

The Qalhât Development Project

First season : January 21st – April 21st 2013

- "Final Report of Excavations at Buildings B19, B20, B21 and B94"

- Vol. 2 -

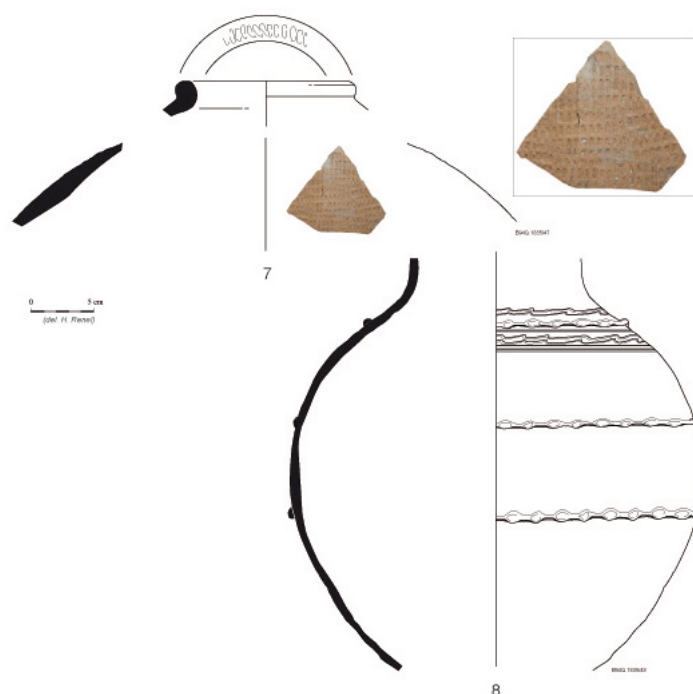

Magalie Dartus (Éveha)

Daniel Étienne (Éveha), Fabien Lesguer (Éveha), Corinne Gosset (Éveha),
Apolline Vernet (Éveha), Hélène Renel (CNRS - Umr 8167),
Dr Gülsü Simsek (Labex MiChem, CNRS – UMR7075),
Dr Hervé Monchot (Labex Resmed, UMR 8167 “Orient & Méditerranée”)

and

Dr Axelle Rougeulle (CNRS - Umr 8167)

Sultanate of Oman
Ministry of Heritage & Culture



سَلْطَنَة عَمَّان
وَلَاة الْبَرَاءة وَالثَّقَاة



The Qalhât Development Project

First season : January 21st – April 21st 2013

" Final Report of Excavations at Buildings B19, B20, B21, B94 "

- Appendix, Vol. 2 -

Magalie Dartus (Éveha)

Daniel Étienne (Éveha), Fabien Lesguer (Éveha), Corinne Gosset (Éveha), Apolline Vernet (Éveha), Hélène Renel (CNRS - UMR 8167), Dr Gülsü Simsek (Labex MiChem, CNRS - UMR7075), Dr Hervé Monchot (Labex Resmed, UMR 8167 "Orient & Méditerranée")

and

Dr Axelle Rougeulle (CNRS - UMR 8167)

Ministry of Heritage & Culture

P. O. Box 668 – P. C. 100

Muscate,

Sultanate of Oman

CNRS- Umr 8167

Orient & Méditerranée

27 rue Paul Bert

94204 Ivry-sur-Seine

France

umr8167@ivry.cnrs.fr

Éveha International

24 avenue des Bénédictins

87000 Limoges

France

contact@eveha-international.com

Édité à Limoges (France), par Éveha international, en septembre 2013 (v2).

B 94, technical drawings

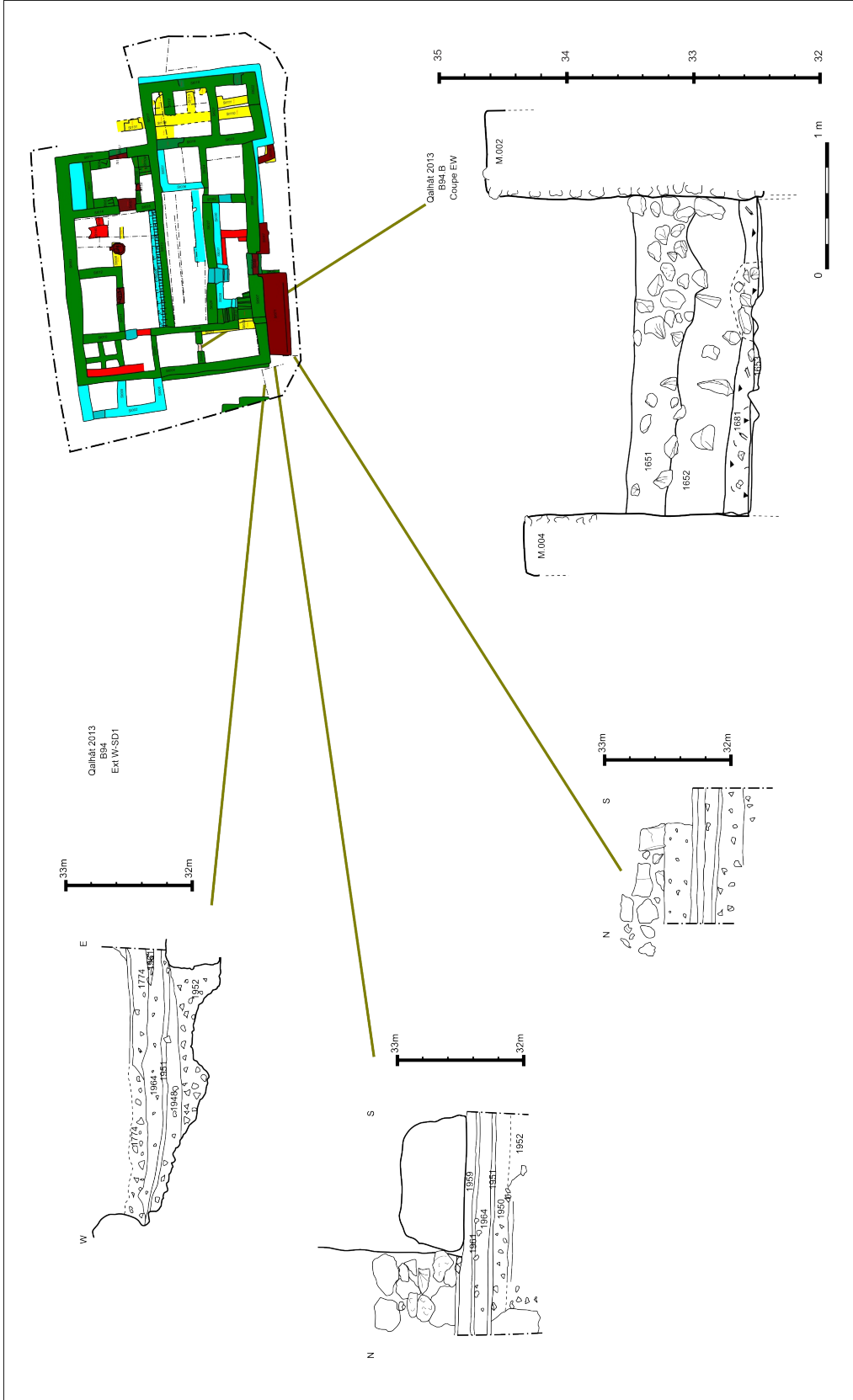

B94 Sections B and Ext W

Qaïbat 2013
B94.F
Cote NS

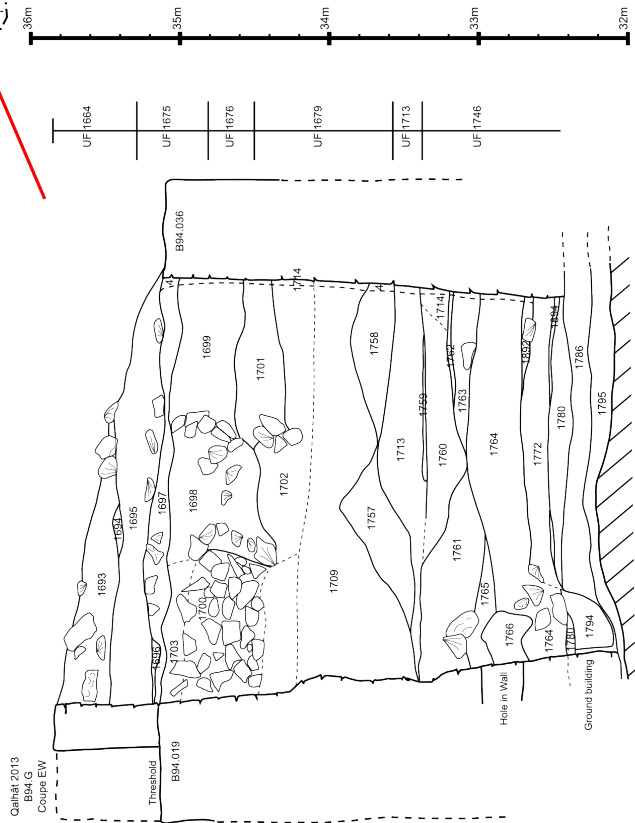
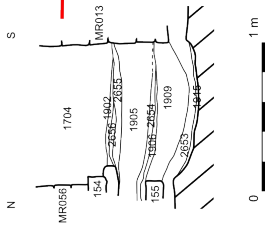

UF 1684
UF 1675
UF 1676
UF 1679
UF 1713
UF 1746

B94 Sections F and G

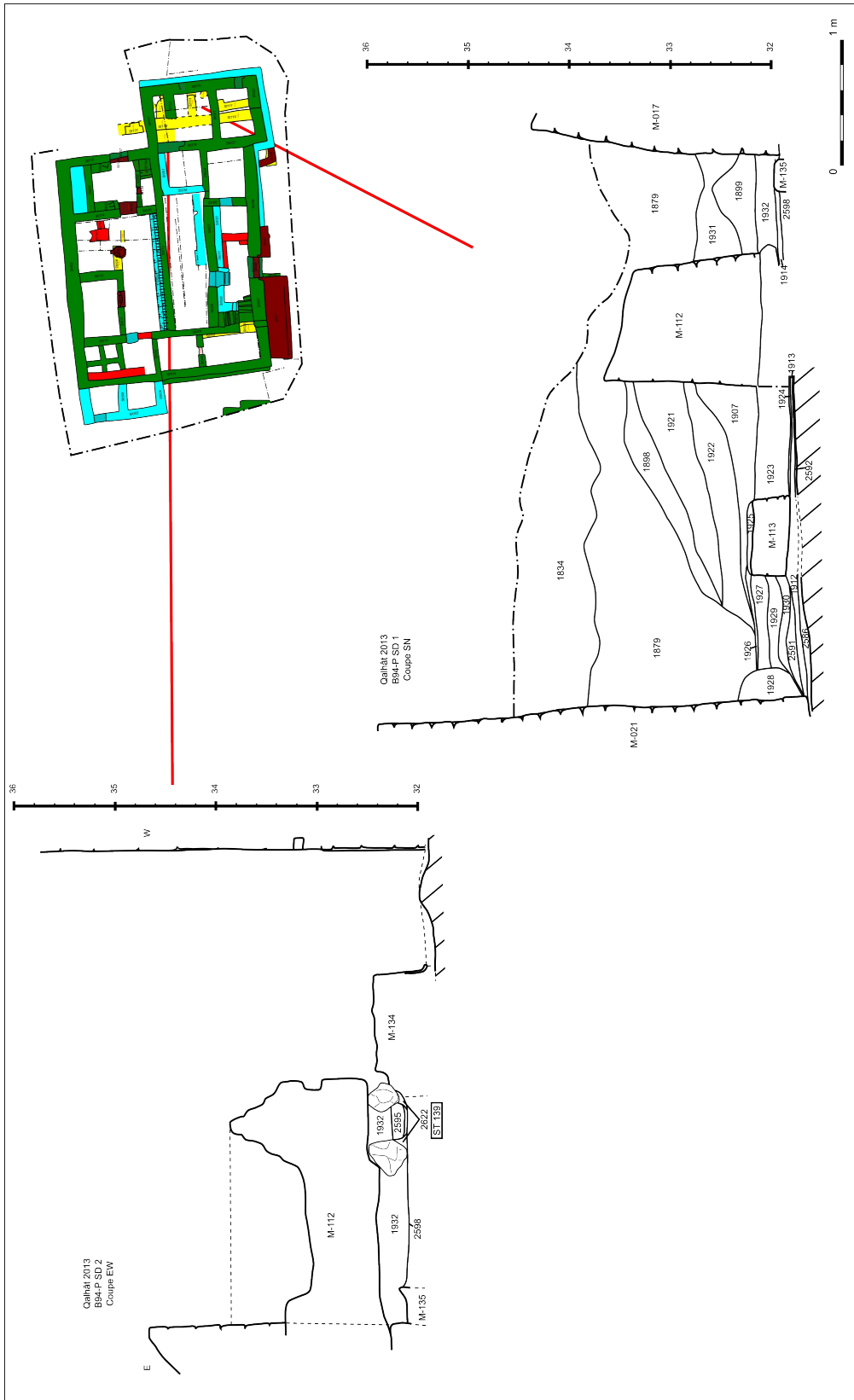

B94 Sections P

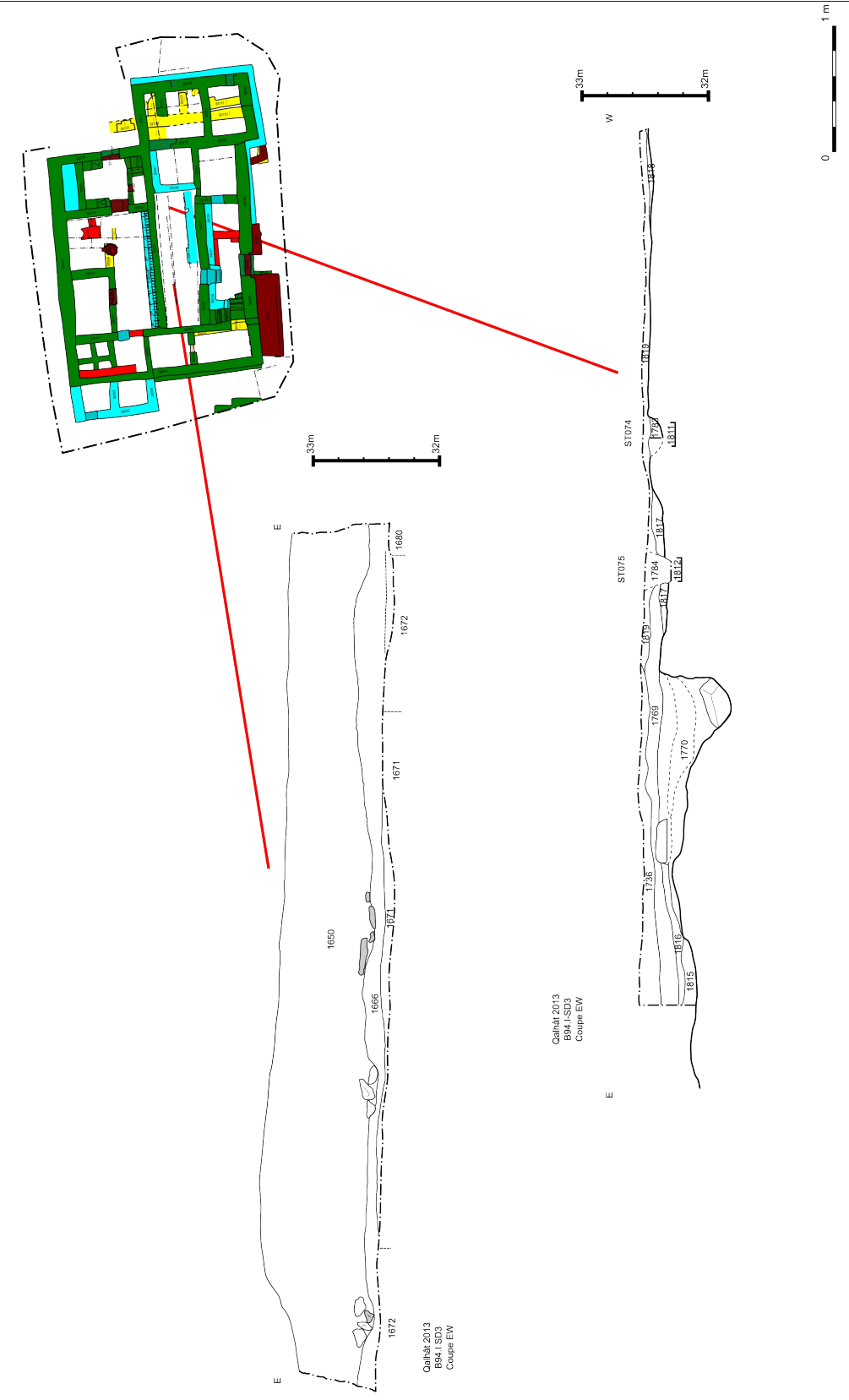

B94 Sections I

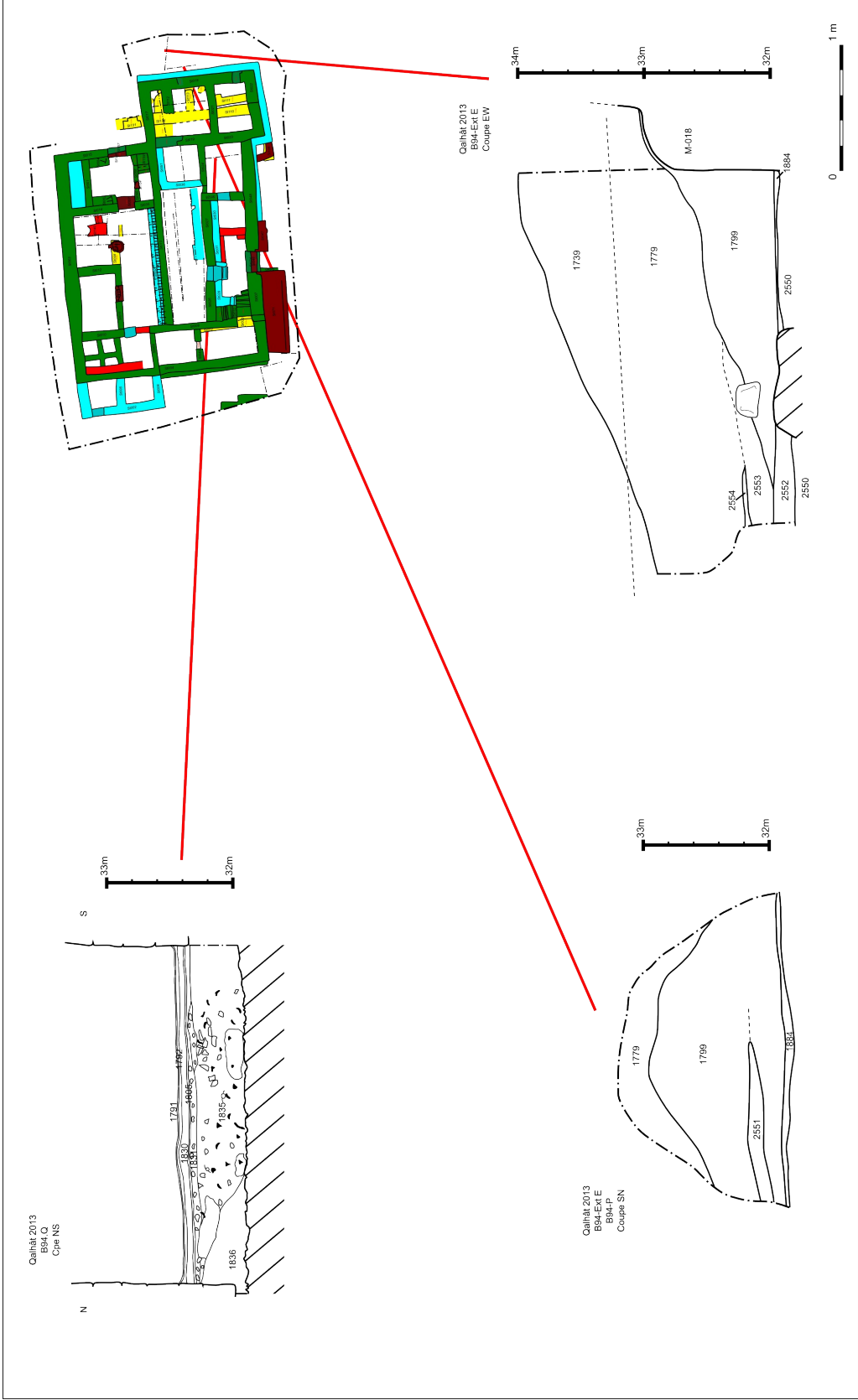

B94 Sections Q and Ext E

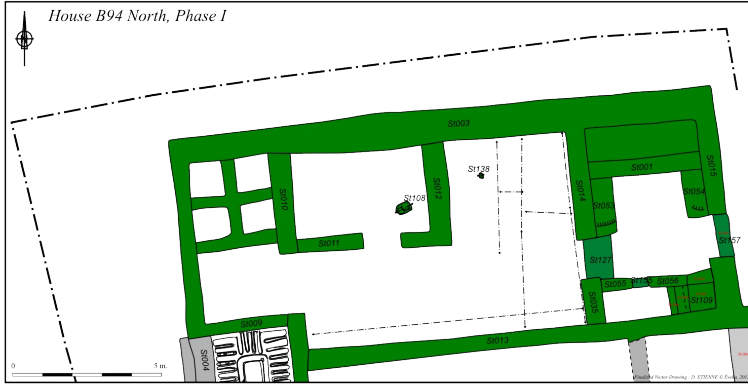

Qalhât 2013
B94.C
ST108

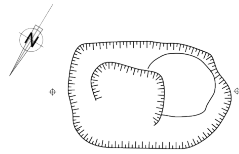

Qalhât 2013
B94.D ST138
Coupe WE
et plan

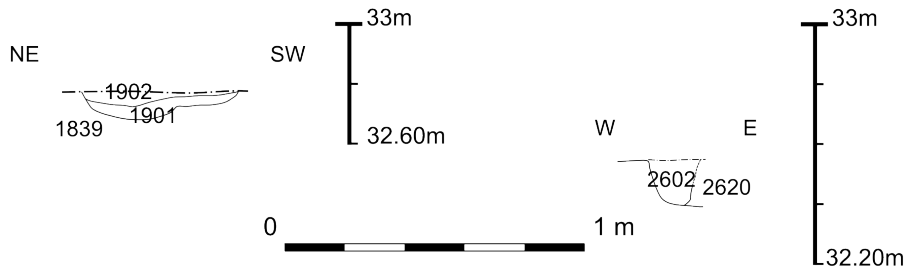
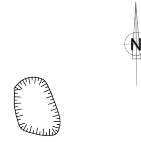

B94 North phase I

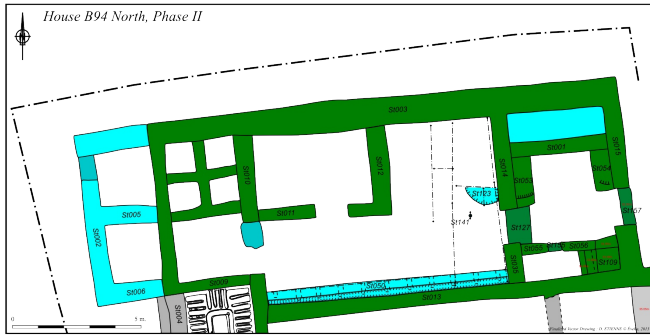

Qalhāt 2013
B94.D
ST123

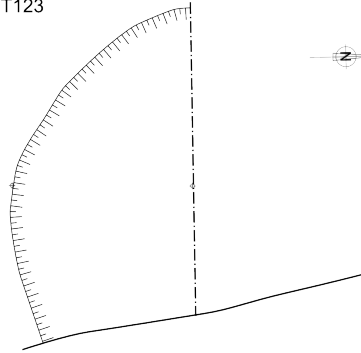

Qalhāt 2013
B94.D
ST141



B94 North phase II



B94 North phase II

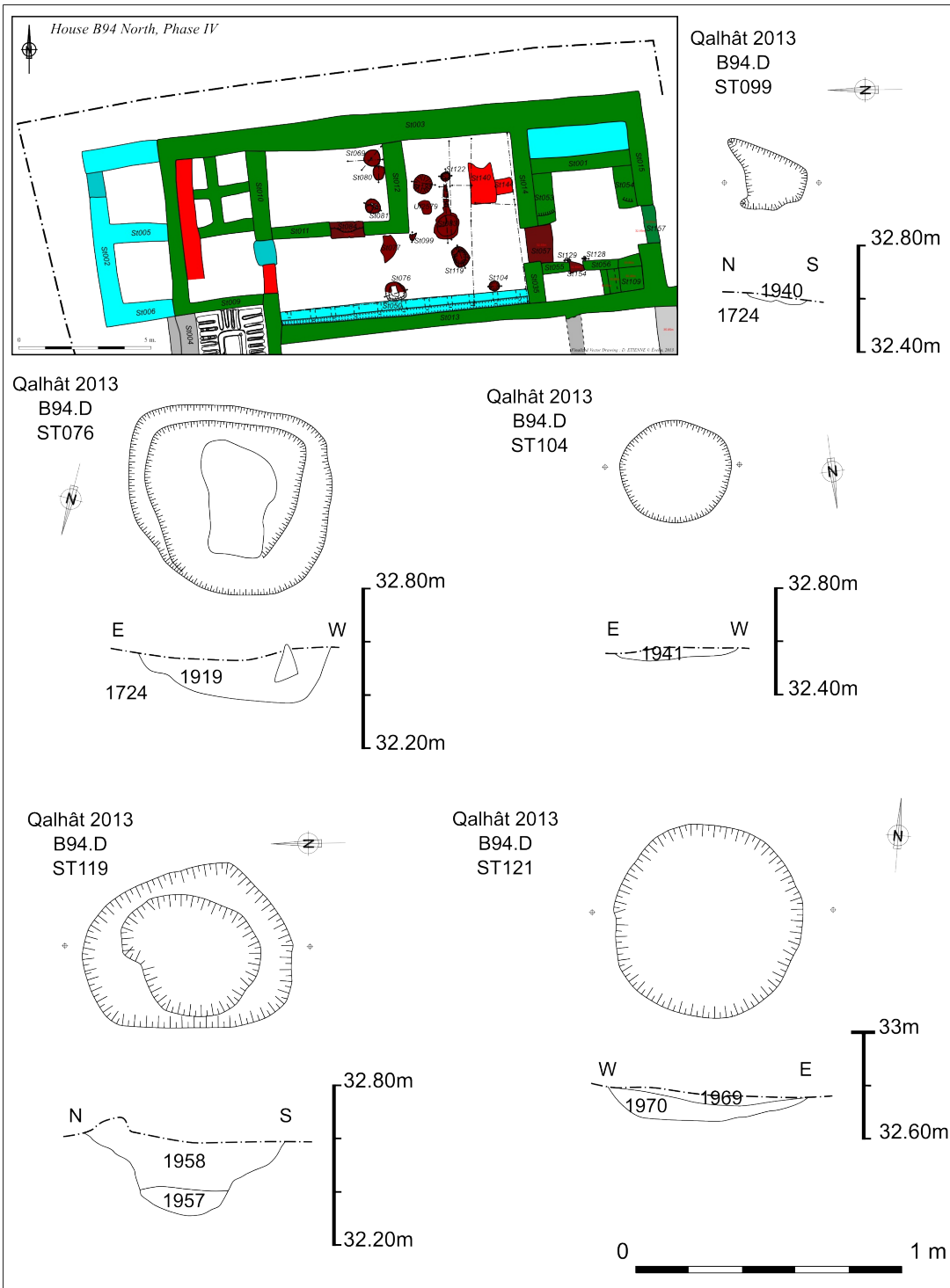

B94 North phase IV

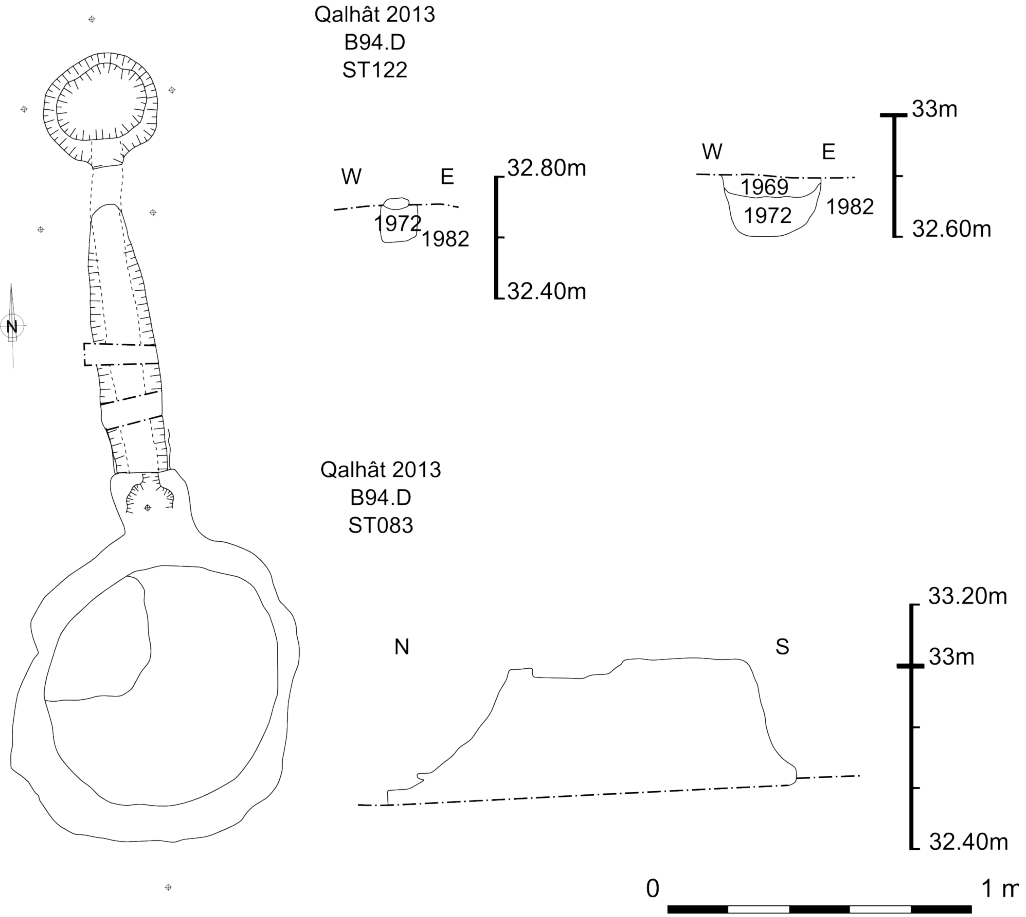
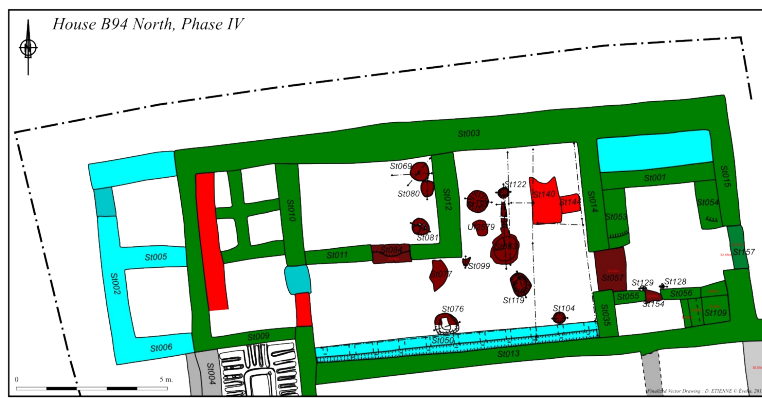

B94 North phase IV

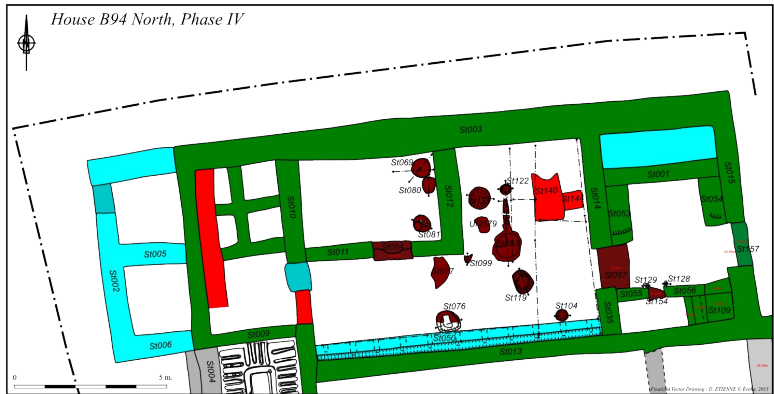

Qalhât 2013
B94.F
ST128

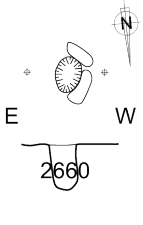

Qalhât 2013
B94.F
ST129

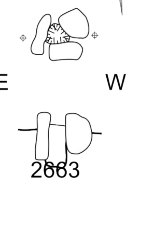

Qalhât 2013
B94.C
ST082

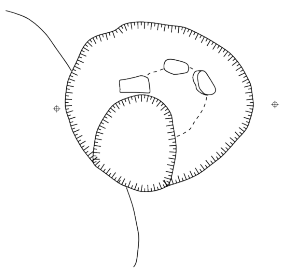

Qalhât 2013
B94.C-ST069
Coupe NE-SW

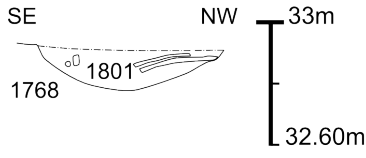
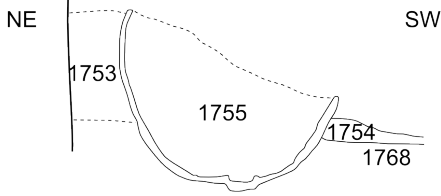

Qalhât 2013
B94.C
ST081

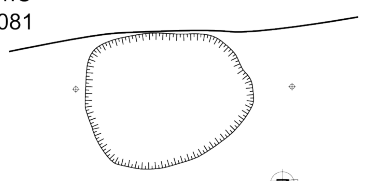

Qalhât 2013
B94.C
ST069

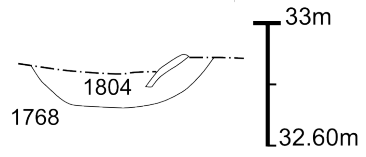
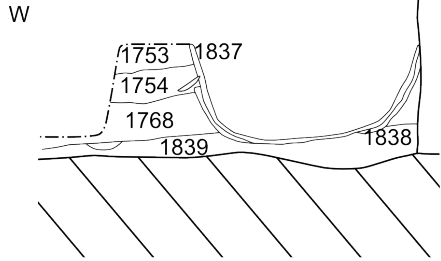

B94 North phase IV

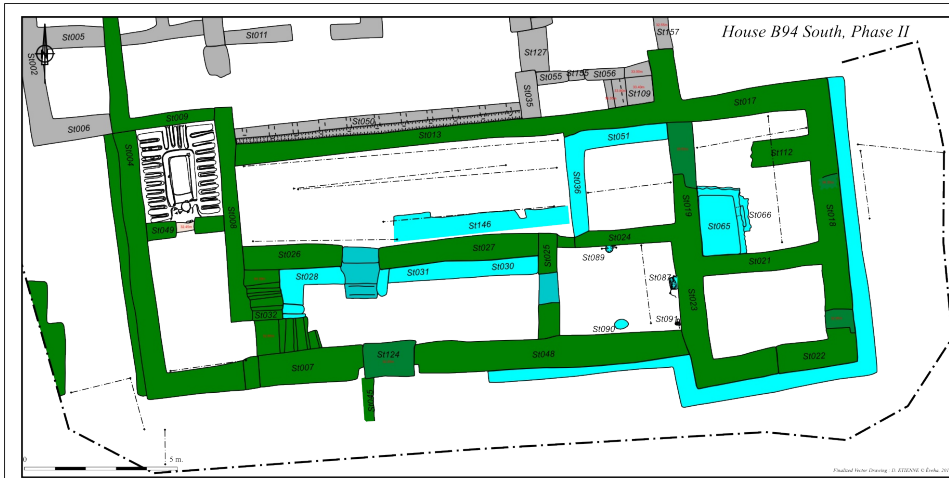

Qalhât 2013
B94.Q
ST087

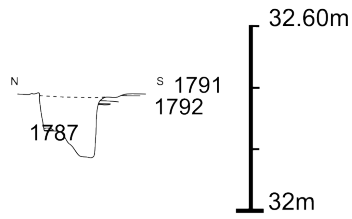
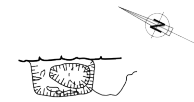

Qalhât 2013
B94.Q
ST089

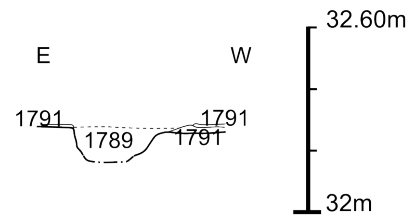
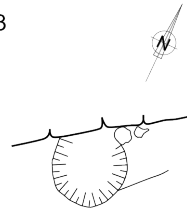

Qalhât 2013
B94.Q
ST090

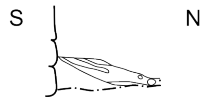
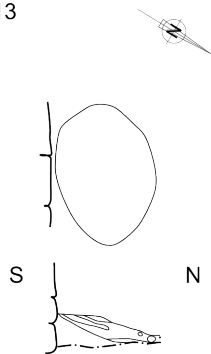

Qalhât 2013
B94.Q
ST091

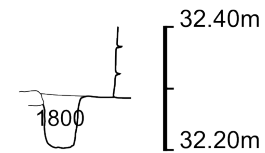

B94 South phase II

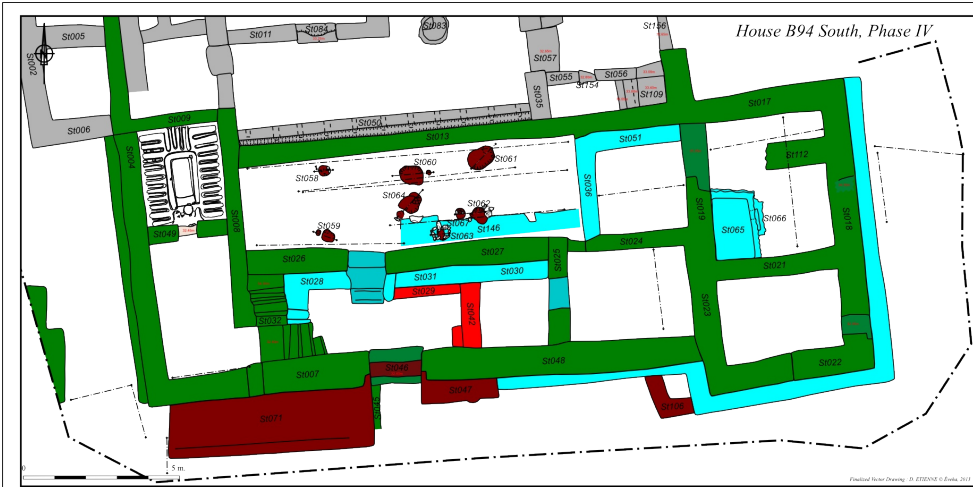

Qalhât 2013
B94.C
ST064

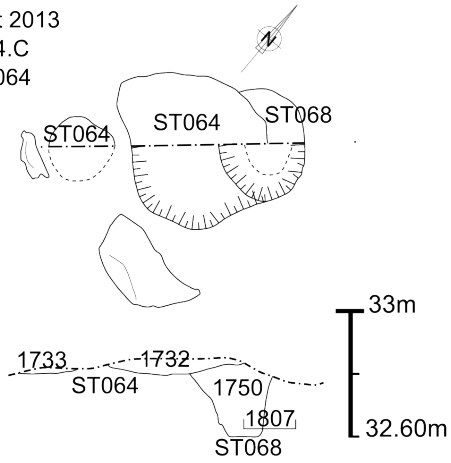

Qalhât 2013
B94.1
ST062-ST067

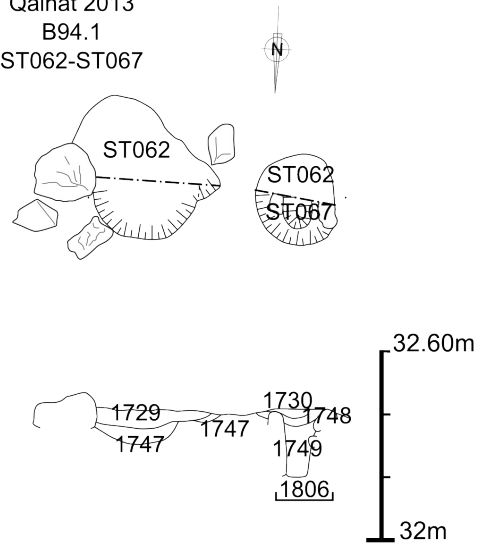

B94 South phase IV

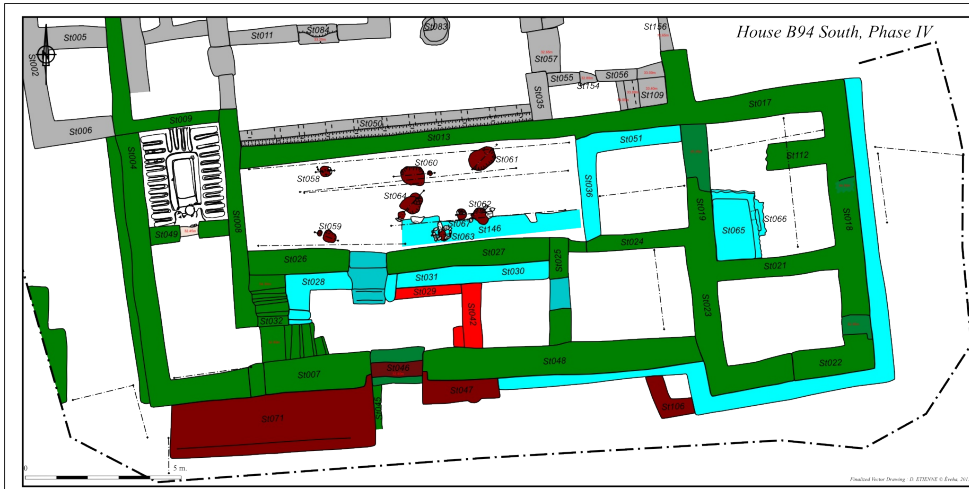

Qalhât 2013
B94.I
ST58

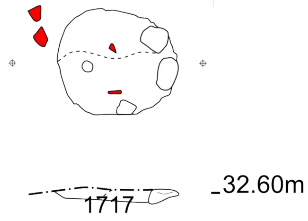

Qalhât 2013
B94.I
ST59

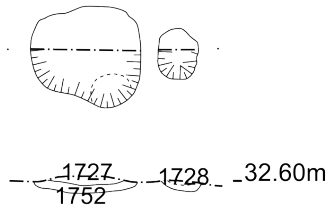

Qalhât 2013
B94.I
ST063

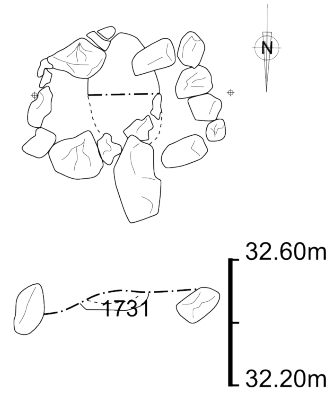

Qalhât 2013
B94.I
ST060

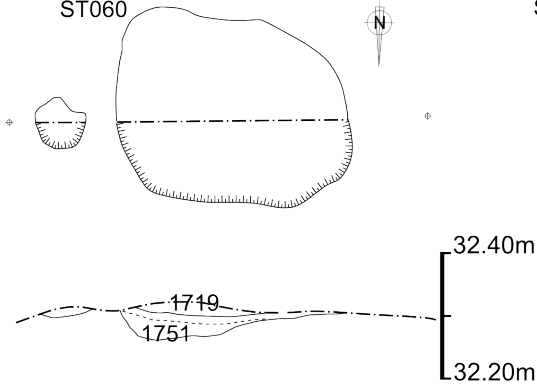

Qalhât 2013
B94.I
ST061

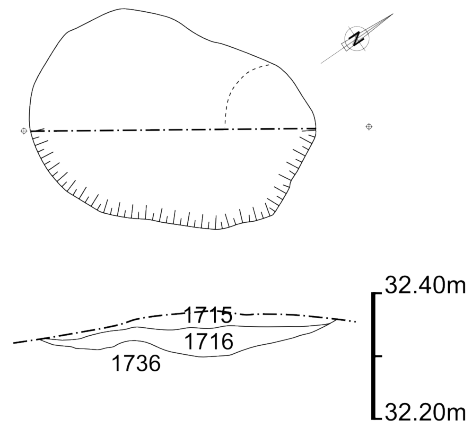

B94 South phase IV

**B 94, ceramics identification and
drawings**



Pl.1. B94 C. Material from the last occupation (16th cent.)

Pl.1. B94 C. Material from the last occupation (16th cent.)

N°1 : Globular Jar with straight and wide Neck. Hard and fine orange brownish fabric. Oman production. Qalhati ware.

N°2 :Support of Jar. Mortar.

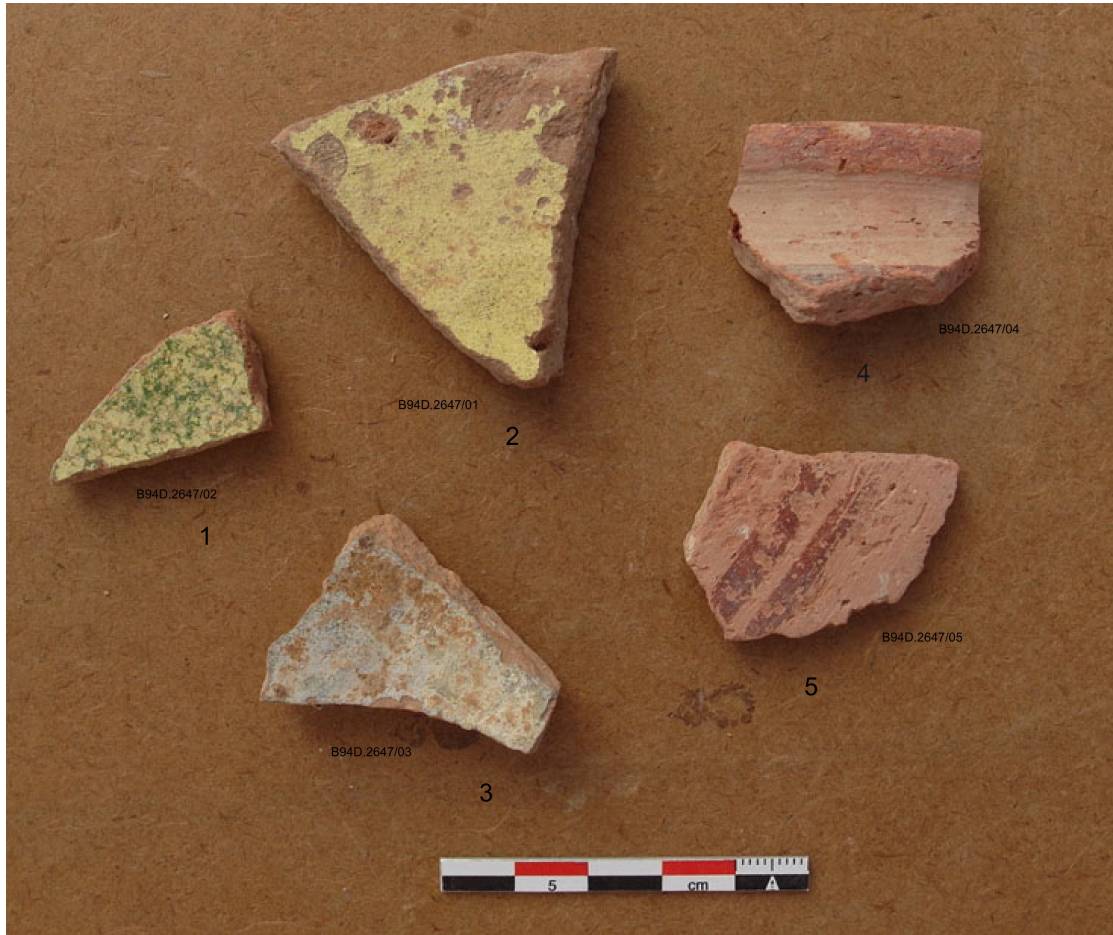

PI.02. B94 D. Material from the construction
(2 half of the 13th cent- 1st half of the14th cent.)

Pl.02. B94 D. Material from the construction (2nd half of the 13th cent- 1st half of the 14th cent.)

N°1: Bowl. Light brown fabric with mica inclusions. Yemen production. "Mustard" ware.

N°2: Bowl. Light brown fabric with mica inclusions. Yellow with green speckled glaze. Yemen production. "Mustard" ware.

N°3: Bowl. Hard and fine light brown fabric. Incised decoration on white slip and under green glaze. Iran production. Sgraffiato ware.

N°4: Jar with slightly everted neck. Pink fabric with vegetable and chamotte inclusions. Light white pinkish slip with dark pink painted decoration. Indian ware.

N°5: Jar with slightly everted neck. Pink fabric with vegetable and chamotte inclusions. Indian ware.

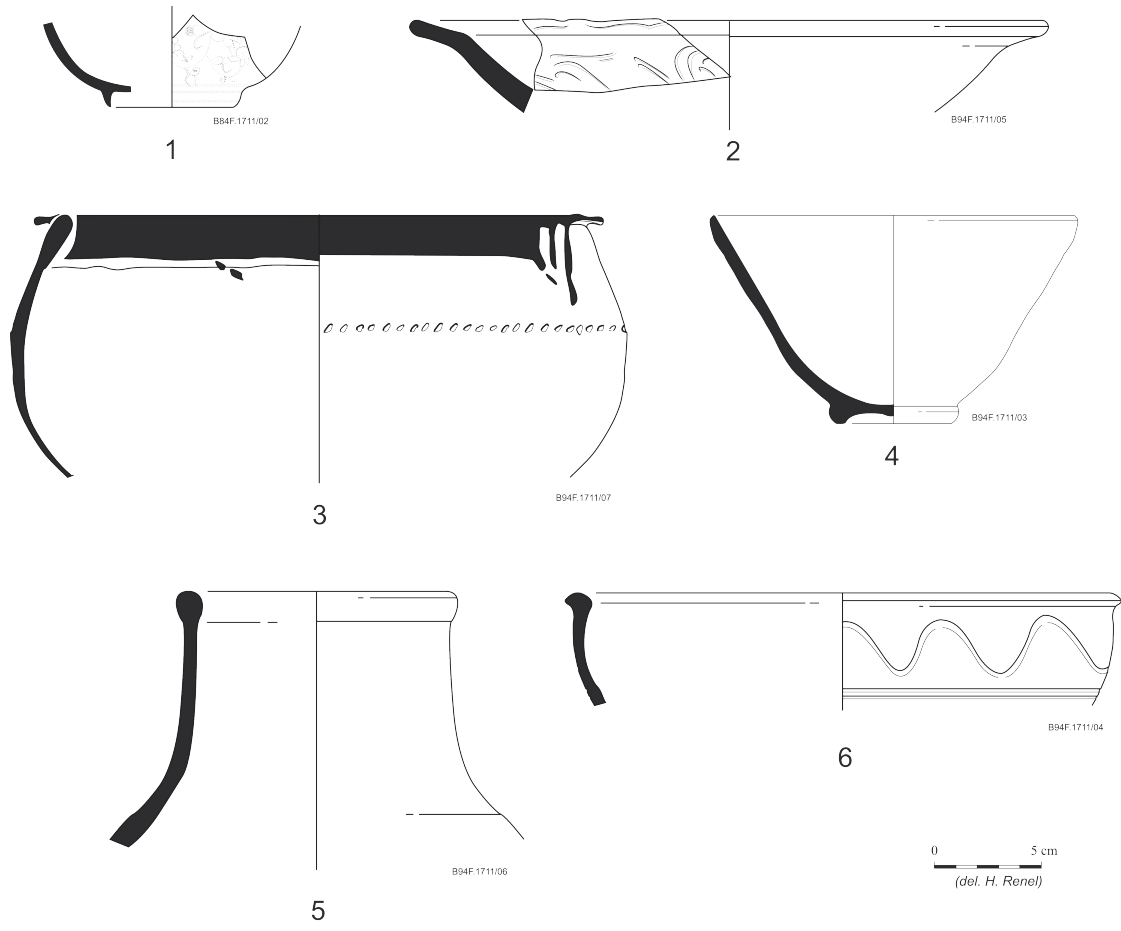

Pl.03. B94 F. Material from the last occupation (16th cent.)

Pl.03. B94 F. Material from the last occupation (16th cent.)

N°1: Hemispherical bowl with ring base. Cobalt painted decoration. Chinese production. Blue and white porcelain.

N°2: Green glazed stoneware. Large hemispherical bowl with ledge rim (inner border). Olive greyish glaze. Thailand production.

N°3: Handmade cooking pot. Coarse red fabric. Red painted decoration on the rim. Wadi Haqil (U.A.E.) production.

N°4: Bowl with out-flaring side and ring base. Light grey fabric. Brown glaze with dark speckles. Oman production. Bahla ware.

N°5: Jar with large and straight neck. Coarse orange brownish fabric with medium grey, white and chamotte inclusions. Oman production. Qalhati ware.

N°6: Large basin. Hemispherical side with thick rounded rim. Coarse orange brownish fabric with medium grey, white and chamotte inclusions. Large and slight incised decoration. Oman production. Qalhati ware.



Pl.04. B94 G. Material from the construction (first half of the 14th cent.)

Pl.04. B94 G. Material from the construction (1st half of the 14th cent.)

N°1: Unglazed moulded jug. Fragment of wall. Fine light grey fabric. Moulded decoration. South Iran production.

N°2: Fragment of bowl. Fine light brown fabric. Degraded color glaze. Iran production. Sgraffiato ware.

N°3: Fragment of jar. Coarse light pink ware with large chamotte inclusions, black on interior. Orange slip. Paddle stamp decoration. Indian ware.

N°4: Fragment of jar. Light orange pinkish fabric with vegetable and chamotte inclusions. Light pink slip. Red and black painted decoration. Indian production.

N°5: Fragment of jar. Light orange pinkish fabric with vegetable and chamotte inclusions. Light pink slip. Orange painted decoration. Indian production.

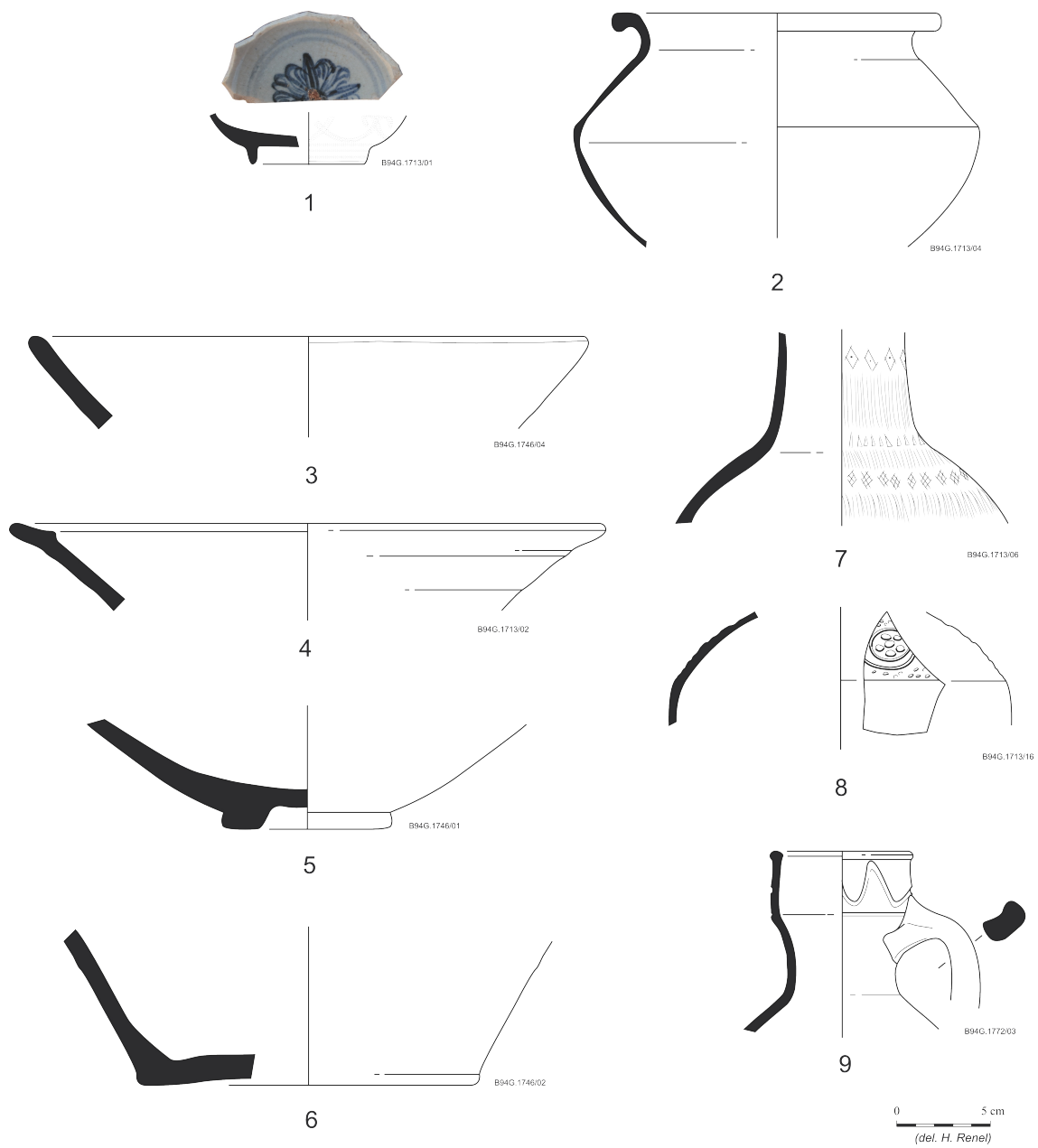

Pl.05. B94 G. Material from the last occupation (16th cent.)

Pl.05. B94 G. Material from the last occupation (16th cent.)

N°1: Hemispherical bowl with ring base. Cobalt painted decoration. Chinese production. Blue and white porcelain.

N°2: Carinated cooking pot, with thick everted rim. Coarse light brown with medium black, white and quartz inclusions. Indian ware.

N°3: Bowl with straight side. Light brown fabric, fine mineral inclusions. Thick blue green with black speckles. Arabian production.

N°4: Straight side with ledge rim. Light brown fabric, fine mineral inclusions. Thick blue green with black speckles. Arabian production.

N°5: Bowl with large ring base. Light brown fabric, fine mineral inclusions. Thick blue green with black speckles. Arabian production.

N°6: Flat base of storage jar. Coarse light yellow ware with large white inclusions. Bahraini production.

N°7: Globular bottle with straight neck. Fine yellow brownish fabric. Stamped, rouletted and incised decoration. South Iran production.

N°8: Moulded jug. Light carinated side. Fine white fabric. Moulded decoration on the shoulder. South Iran production.

N°9: Jug. Globular side, neck with cup rim. Light brown fabric, light yellow on exterior; medium chamotte and grey inclusions. Incised decoration. Oman production. Qalhati ware.

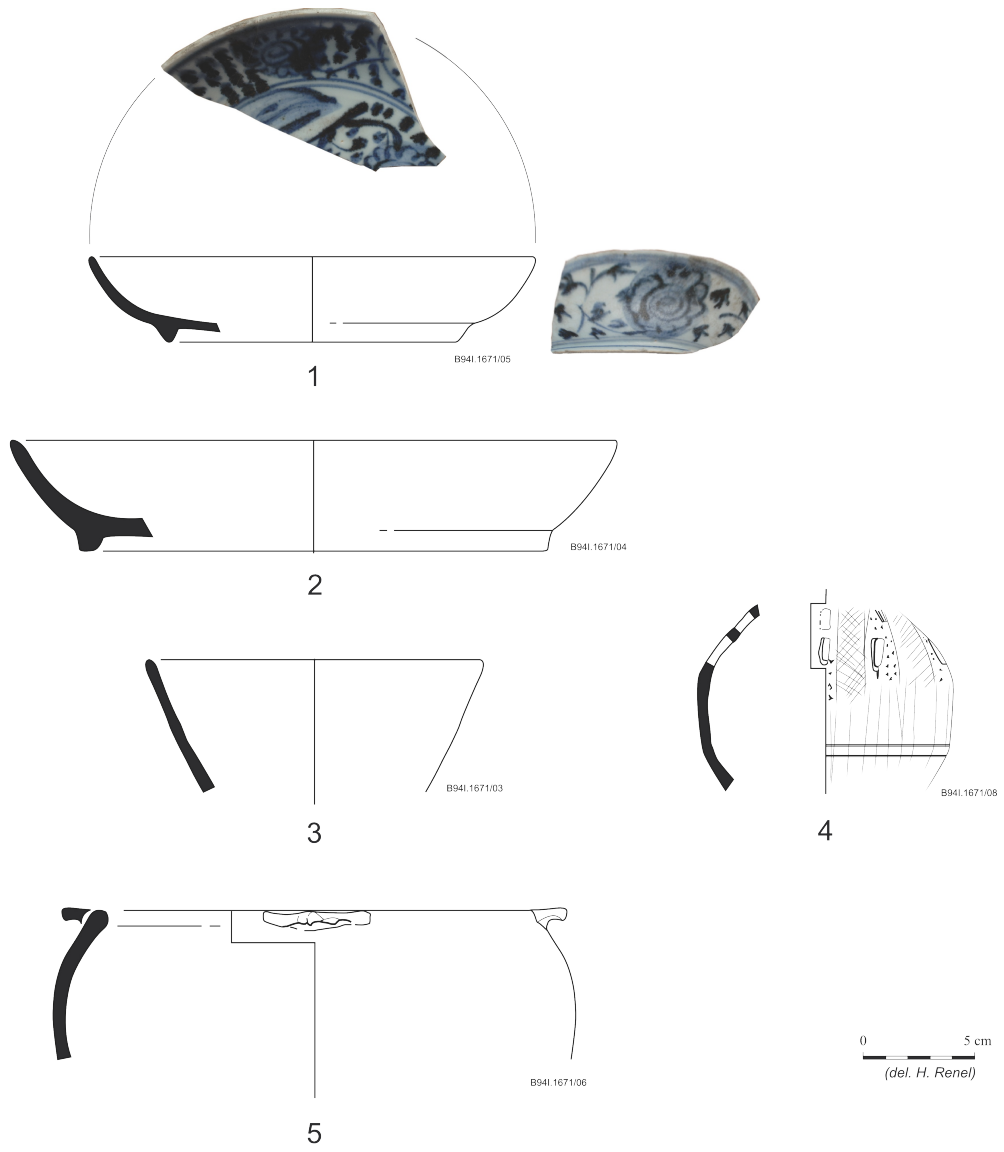

Pl.06. B94 I. Material from the last occupation (16th cent.)

Pl.06. B94 I. Material from the last occupation (16th cent.)

N°1: Large bowl with ring base. Cobalt painted decoration. Chinese production. Blue and White porcelain.

N°2: Large bowl with ring base. Fine red fabric. Thick white glazed on exterior and interior. Burmese production.

N°3: Bowl with out-flaring side. Fine light orange fabric. Brown glaze with dark brown speckles on interior and exterior. Oman production. Bahla ware

N°4: Incense burner. Carinated side with rectangular holes on the shoulder. Fine light orange brownish fabric, white yellowish on exterior. Fine incised and stamped decoration. South Iran production? Oman production?

N°5: Handmade cooking pot. Globular side with thick rounded rim and four handles. Coarse grey brownish fabric with medium vegetable and mineral inclusions. Light grey on exterior. Wadi Haqil (U.A.E.) production.

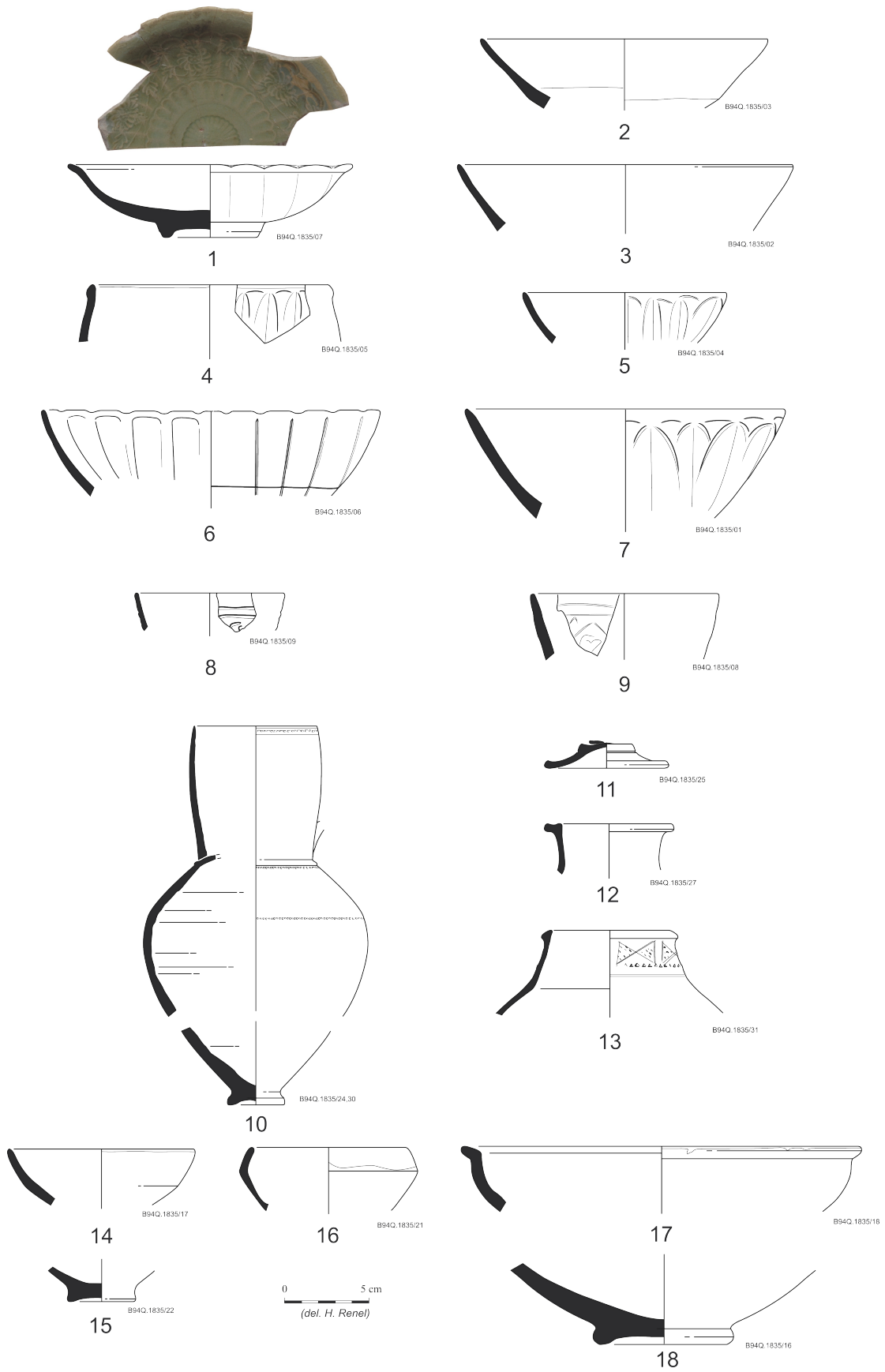

PI.07. B94 Q. Material from the construction (1st half of the 14th cent.).

Pl.07. B94 Q. Material from the construction (1st half of the 14th cent.)

N°1: Bowl with scalloped rim and ring base. Grey stoneware. Slip decoration under olive glaze. Chinese production.

N°2: Bowl with straight side. Light grey stoneware. Light grey glaze on exterior and interior. Bottom inside unglazed. Chinese production.

N°3: Bowl with straight side. Light grey stoneware. Light grey glaze on exterior and interior. Bottom inside unglazed. Chinese production.

N°4: Pot with lotus petals decoration in relief. Light grey stoneware. Blue greenish glaze. Rim unglazed. Chinese production.

N°5: Hemispherical bowl with lotus petals decoration in relief. Grey stoneware. Light blue glaze. Chinese production. Longquan celadon.

N°6: Hemispherical bowl with scalloped rim and ribbed sides. Grey stoneware. Light blue glaze on exterior and blue greenish on interior. Chinese production.

N°7: Hemispherical bowl with lotus petals decoration in relief. Grey stoneware. Olive glaze. Chinese production. Longquan celadon.

N°8: Straight neck of moulded jug. Fine pink brownish fabric, surfaces white. Moulded decoration. South Iran production.

N°9: Straight side bowl. Fine brown fabric. Incised decoration on white slip and under green glaze. Iran production. Sgraffiato ware.

N°10: Jug. Large straight neck, ovoid side, ring base and one handle. Fine orange pinkish fabric. Exterior surface white in color. Fine incised decoration under the rim, on the limits of the neck and of the shoulder. Iranian production.

N°11: Lid. Fine light brown fabric. White surfaces. Iran production?

N°12: Small Jug with straight neck and ledge rim. Fine light brown fabric. White surface. Iran production?

N°13: Small jar with straight neck and triangular rim. Fine orange pinkish fabric. Exterior surface white in color. Fine incised and stamped decoration on the neck. Iran production?

N°14: Hemispherical bowl. White yellowish fabric with fine chamotte and mineral inclusions. Degraded green glazed on interior and top of the outside. Oman production. Qalhati ware.

N°15: Ring base of bowl. White yellowish fabric with fine chamotte and mineral inclusions. Degraded green glazed on interior and top of the outside. Oman production. Qalhati ware.

N°16: Carinated bowl. White yellowish fabric with fine chamotte and mineral inclusions. Degraded green glazed on interior and top of the outside. Oman production. Qalhati ware.

N°17: Hemispherical bowl with everted rim. White yellowish fabric with medium chamotte and mineral inclusions. Degraded green glazed on interior and top of the outside. Oman production. Qalhati ware.

N°18: Ring base of bowl. White yellowish fabric with medium chamotte and mineral inclusions. Degraded green glazed on interior and top of the outside. Oman production. Qalhati ware.

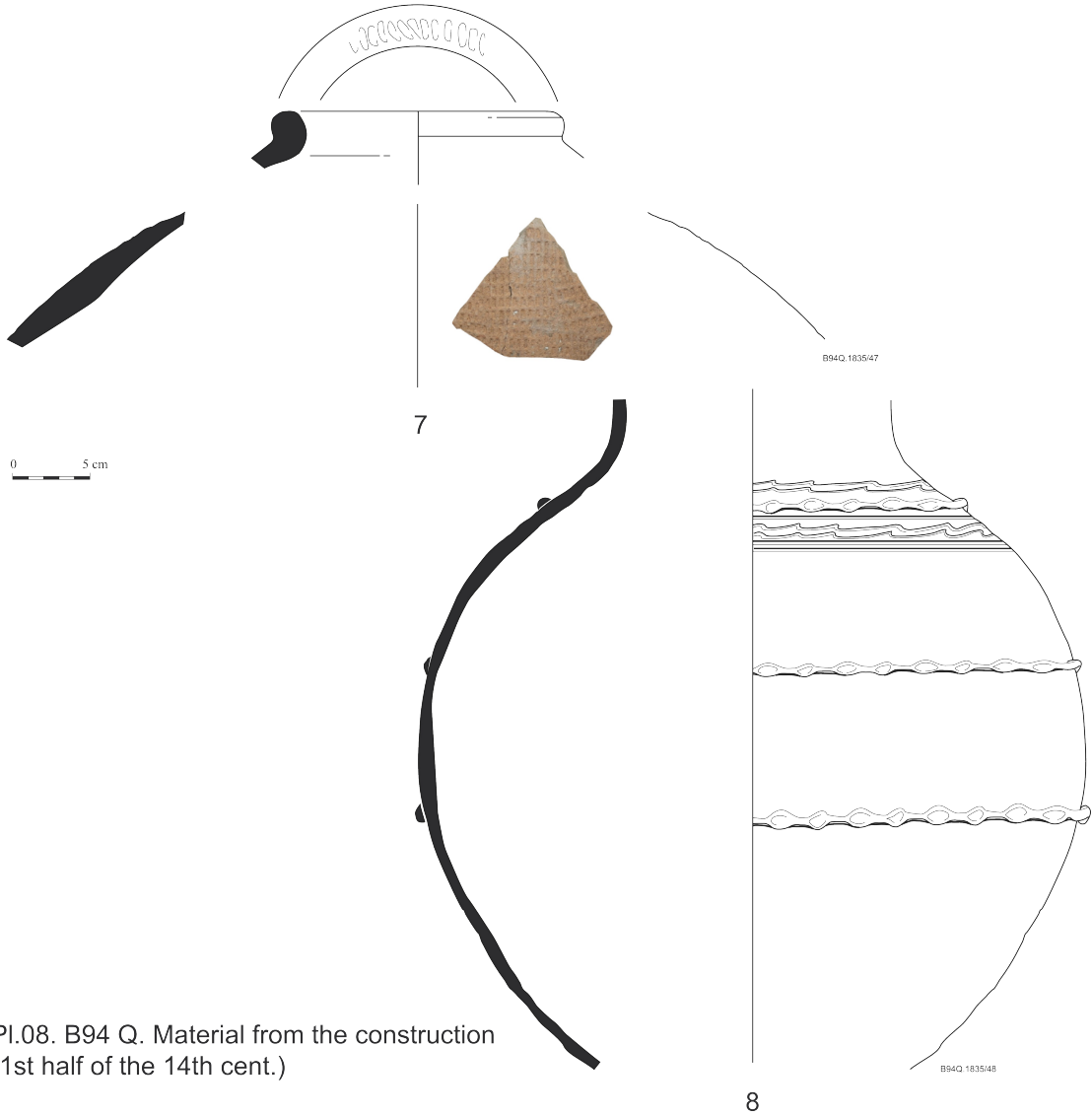
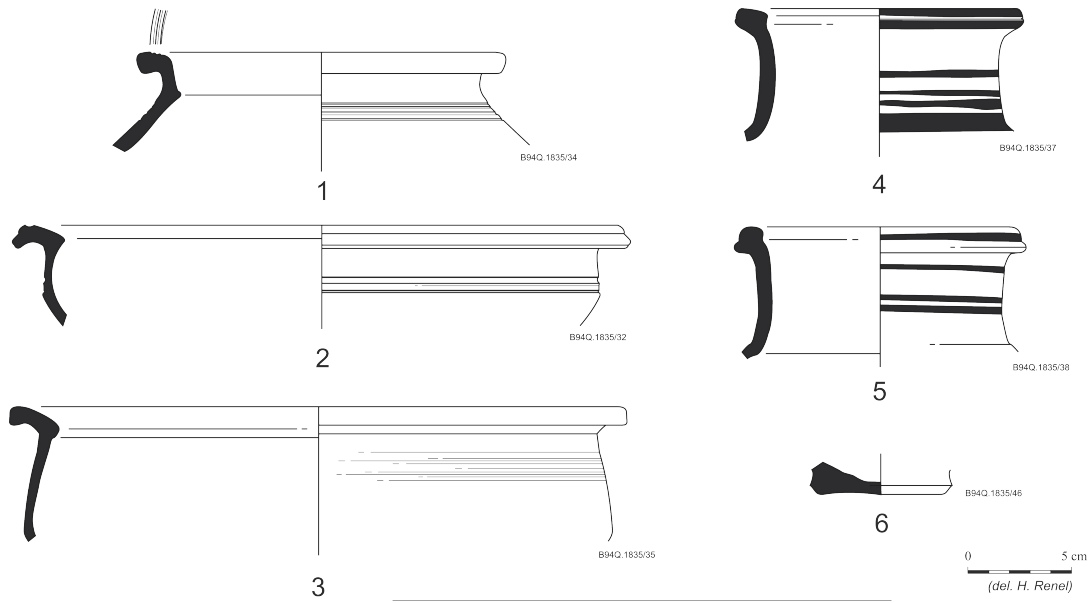

Pl.08. B94 Q. Material from the construction
(1st half of the 14th cent.)

Pl.08. B94 Q. Material from the construction (1st half of the 14th cent.)

N°1: Cooking pot. Short straight neck and thick ledge rim. Coarse brown fabric with medium white, grey and mica inclusions. Light incised decoration on the shoulder. Indian production.

N°2: Carinated cooking pot with thick everted ribbed rim. Coarse brown fabric with fine grey, mica and white inclusions. Red polished surfaces. Incised decoration on the rim and the shoulder. Indian production.

N°3: Carinated cooking pot with thick everted ribbed rim. Coarse brown fabric with grey, white and mica inclusions. Red polished surfaces. Light incised decoration on the shoulder.

N°4: Straight neck of jar with thick square rim and groove on the interior. Coarse pink fabric with vegetable and mineral inclusions. Light pinkish slip on the surfaces. Red painted decoration on the exterior. Indian production.

N°5: Straight neck of jar with thick rounded rim and groove on the interior. Coarse pink fabric with vegetable and mineral inclusions. Light pinkish slip on the surfaces. Red and black painted decoration on the exterior. Indian production.

N°6: Flat base of bowl. Pink fabric with fine vegetable and mineral inclusions. White pinkish slip and green glaze on the interior. Indian production.

N°7: Large storage jar. Globular side and thick rounded rim. Brown fabric grey on core and orange on exterior and interior. Fine white, grey and mica inclusions. Incised decoration on the top of the rim. Paddle stamped decoration. Indian production.

N°8: large globular storage jar. Coarse red brownish fabric with large and medium mineral inclusions. Exterior surface grey greenish in color. Oman production?

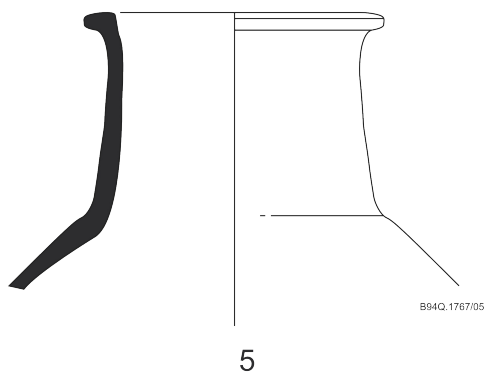
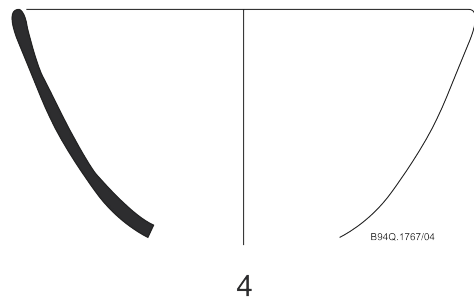
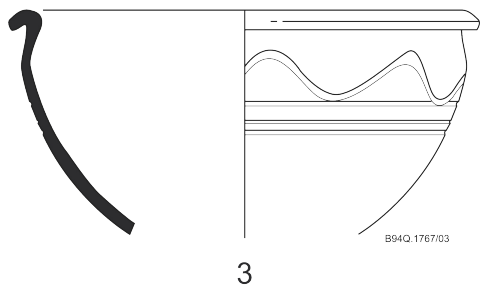
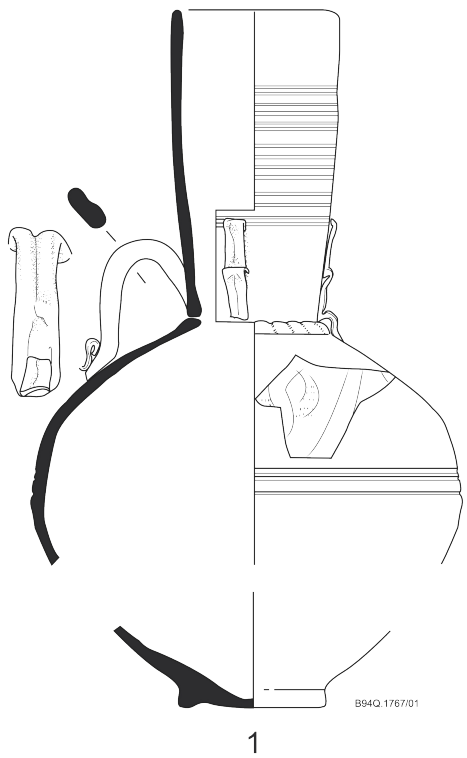

0 5 cm
(del. H. Renel)

PI.09. B94 Q. Material from the last occupation (16th cent.).

Pl.09. B94 Q. Material from the last occupation (16th cent.).

N°1: Jug. Globular side with high straight neck and ring base. Fine light brownish fabric white on the surfaces. Light incised decoration on the shoulder. Barbotine bands on the neck. Iran production.

N°2: Bowl with everted rim and ring base. Cobalt painted decoration. Chinese production. Blue and white porcelain.

N°3: Hemispherical basin. Light brown fabric with medium chamotte inclusions. Surfaces rough and white in color. Incised decoration. Oman production. Qalhati ware.

N°4: Hemispherical bowl. Light brown fabric with fine chamotte and white inclusions. Oman production. Qalhati ware.

N°5: Straight neck of jar with ledge rim. Coarse yellow greenish fabric. Oman production. Qalhati ware.

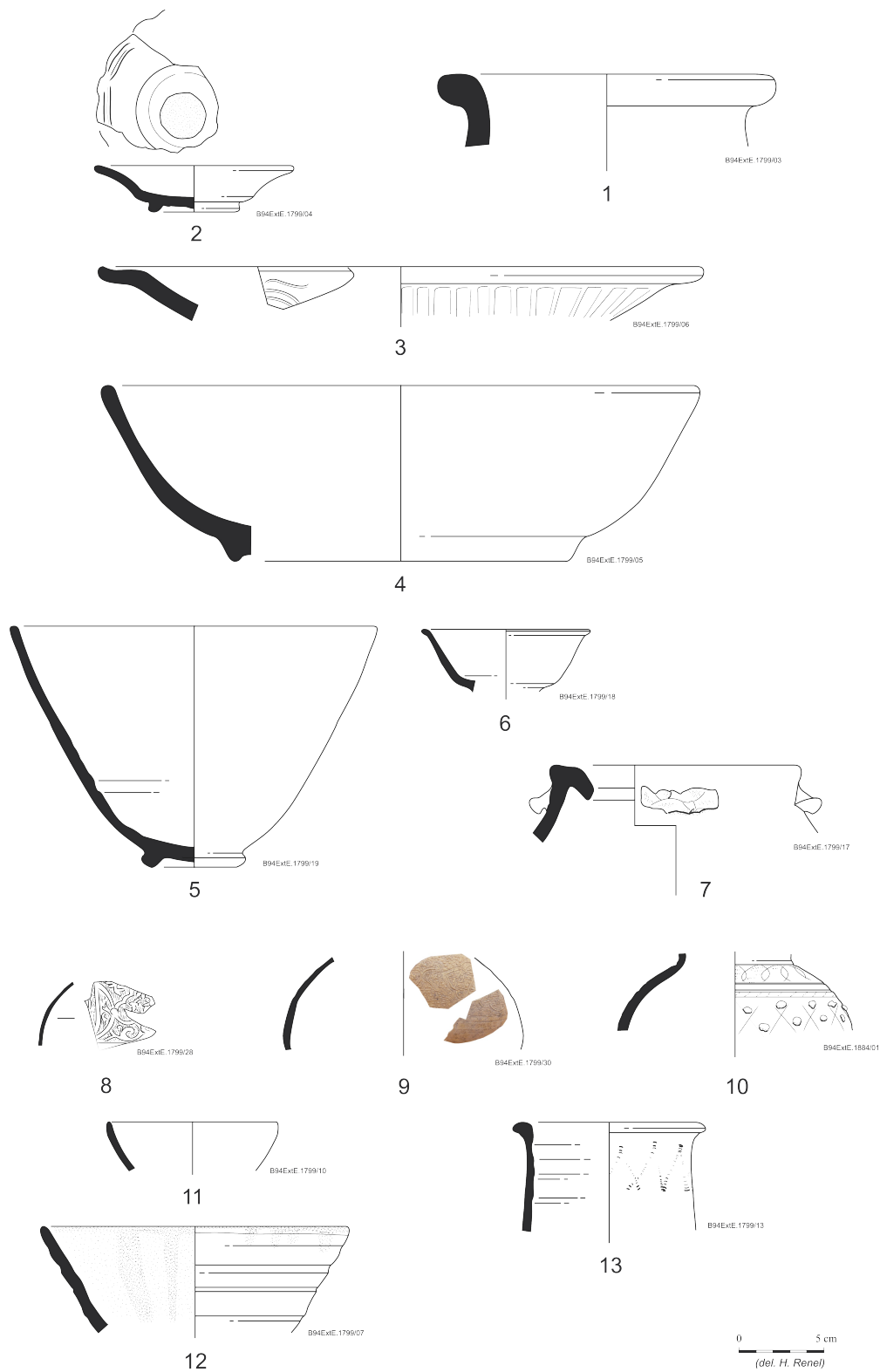

Pl.10. B94 Ext. East. Material from the last occupation (16th cent.).

Pl.10. B94 Ext. East. Material from the last occupation (16th cent.).

N°1: Storage jar with straight neck and thick rounded rim. Fine grey stoneware. Ochre brown glaze. Burmese production. Martaban ware.

N°2: Bowl with out-flaring, scalloped rim and ring base. Coarse grey to orange stoneware. Thick olive grey glaze. Circle unglazed on the bottom of the inside base. Thailand production.

N°3: Large hemispherical bowl with ledge rim. Ribbs on the out side. Coarse grey stoneware, medium mineral inclusions. Incised decoration on the interior. Thick olive grey glaze. Thailand production.

N°4: Large hemispherical bowl with ring base. Light grey to brown stoneware. Thick white grayish glaze on interior and exterior. Thailand production?

N°5: Bowl with out-flaring side and ring base. Fine brown fabric. Ochre brown glaze with dark speckles. Oman production. Bahla ware.

N°6: Small bowl with everted side. Fine grey bluish fabric. Shining brown glaze. Oman production. Bahla ware.

N°7: Large storage jar with in flaring rim and two handles. Coarse yellow fabric with large white inclusions. Bahraini ware.

N°8: Globular jug. Fine dark grey fabric. Fine body. Incised decoration. South Iran production.

N°9: Globular moulded jug. Fine light yellow fabric. Moulded decoration on the shoulder. South Iran decoration.

N°10: Globular jug. Fine light brown fabric. White on exterior surface. Incised, combed and barbotine decoration. South Iran production.

N°11: Hemispherical bowl. Light brown fabric with fine white and chamotte inclusions. Light pink wash on the exterior. Oman production. Qalhati ware.

N°12. Bowl with out-flaring side; ribbed on the exterior. Yellow fabric with medium white and chamotte inclusions. Red painted under green glaze. Oman production. Qalhati ware.

N°13: Straight neck with thick everted rim. Orange brown fabric with white and grey inclusions. Exterior white in color. Stamped decoration. Oman decoration. Qalhati ware.

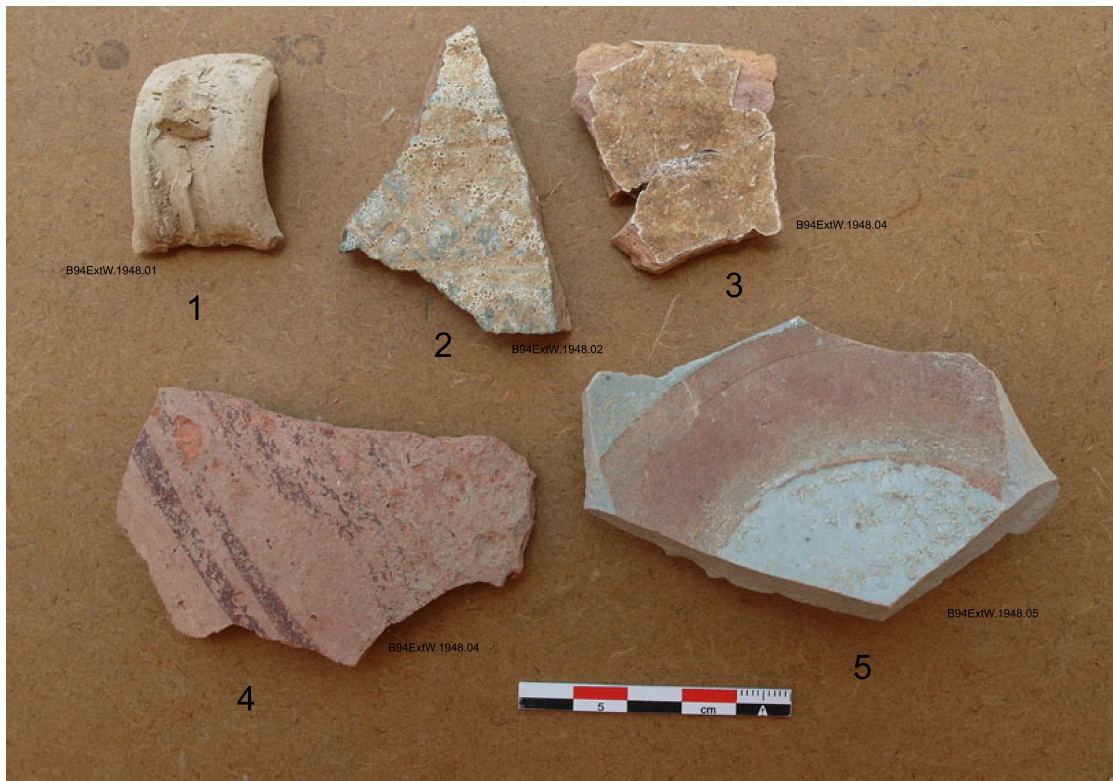

Pl.11. B94 Ext. West. Material from the first occupation (2d half of the 13th cent.-1st half of the 14th cent.).

Pl.11. B94 Ext. West. Material from the first occupation (2nd half of the 13th cent.-1st half of the 14th cent.)

N°1: Handle of a moulded jug. Fine light grey fabric. South Iran production.

N°2: Bowl with out-flaring side. Fine light brown fabric. Incised decoration on white slip and under green glaze. Iran production. Sgraffiato ware.

N°3: Bowl with out-flaring side and everted rim. Fine light brown fabric. Ochre glaze on white slip. Iran production. Sgraffiato ware or monochrome ware?

N°4: Fragment of jar. Pink fabric with vegetable and mineral inclusions. Red painted decoration. Indian production.

N°5: Hemispherical bowl with ring base. Fine grey to brown stoneware. Grey glaze with circle unglazed on the inner base.

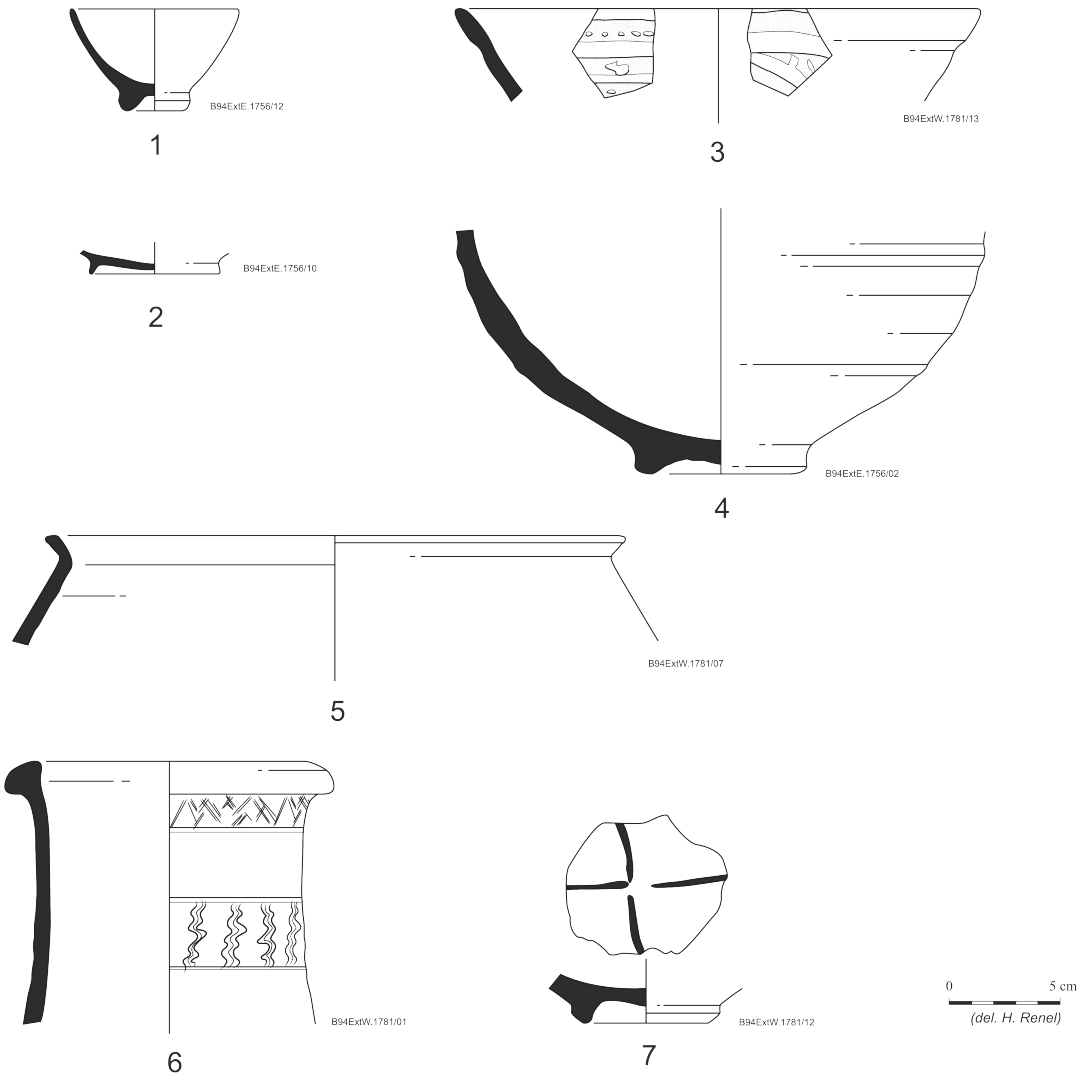

Pl.12. B94 Ext. West. Material from the last occupation (16th cent.).

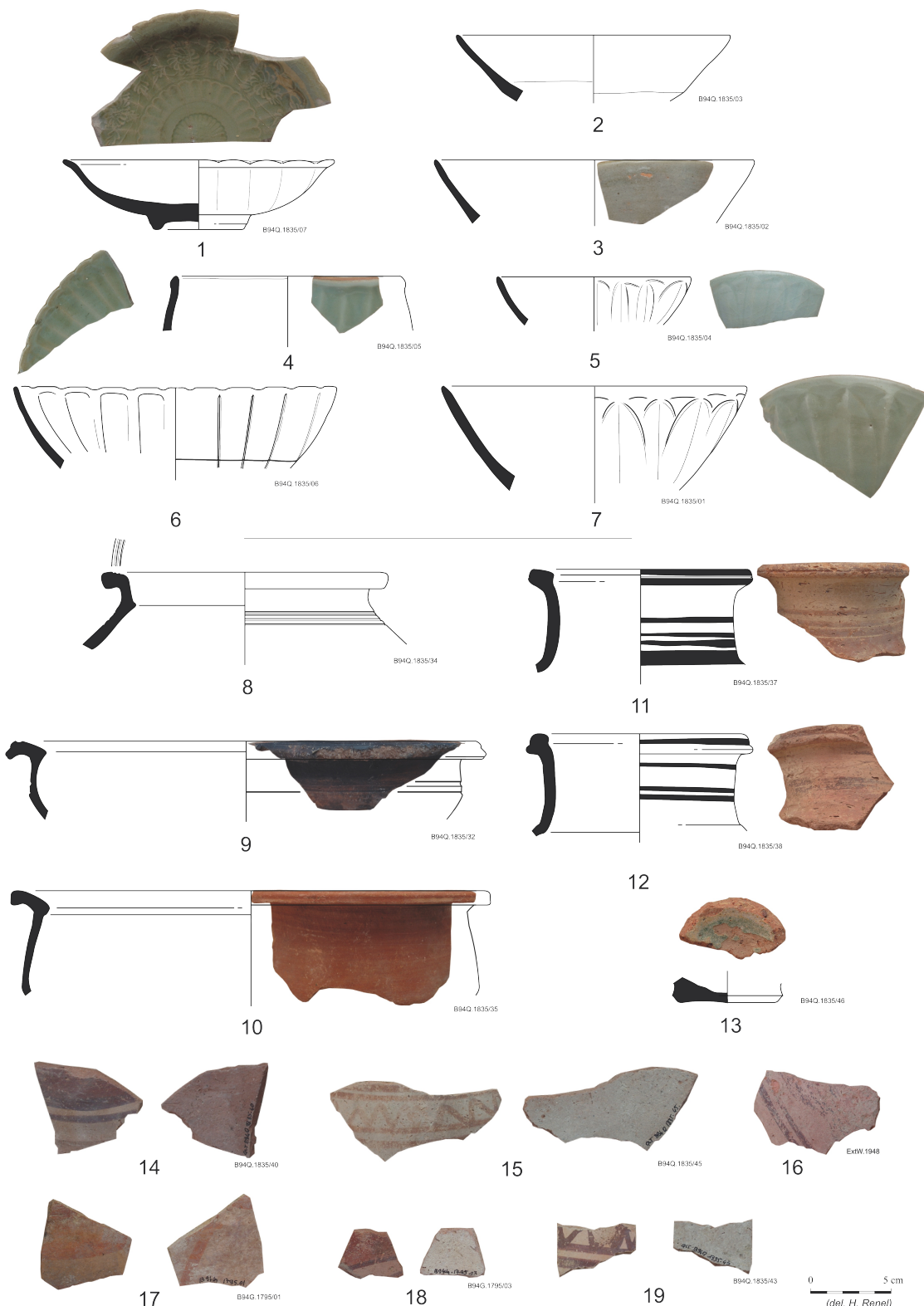

Pl.13. B94 Material of the 2d half of the 13th cent. and 1st half of the 14th cent. from China (1-7) and India (8-19)

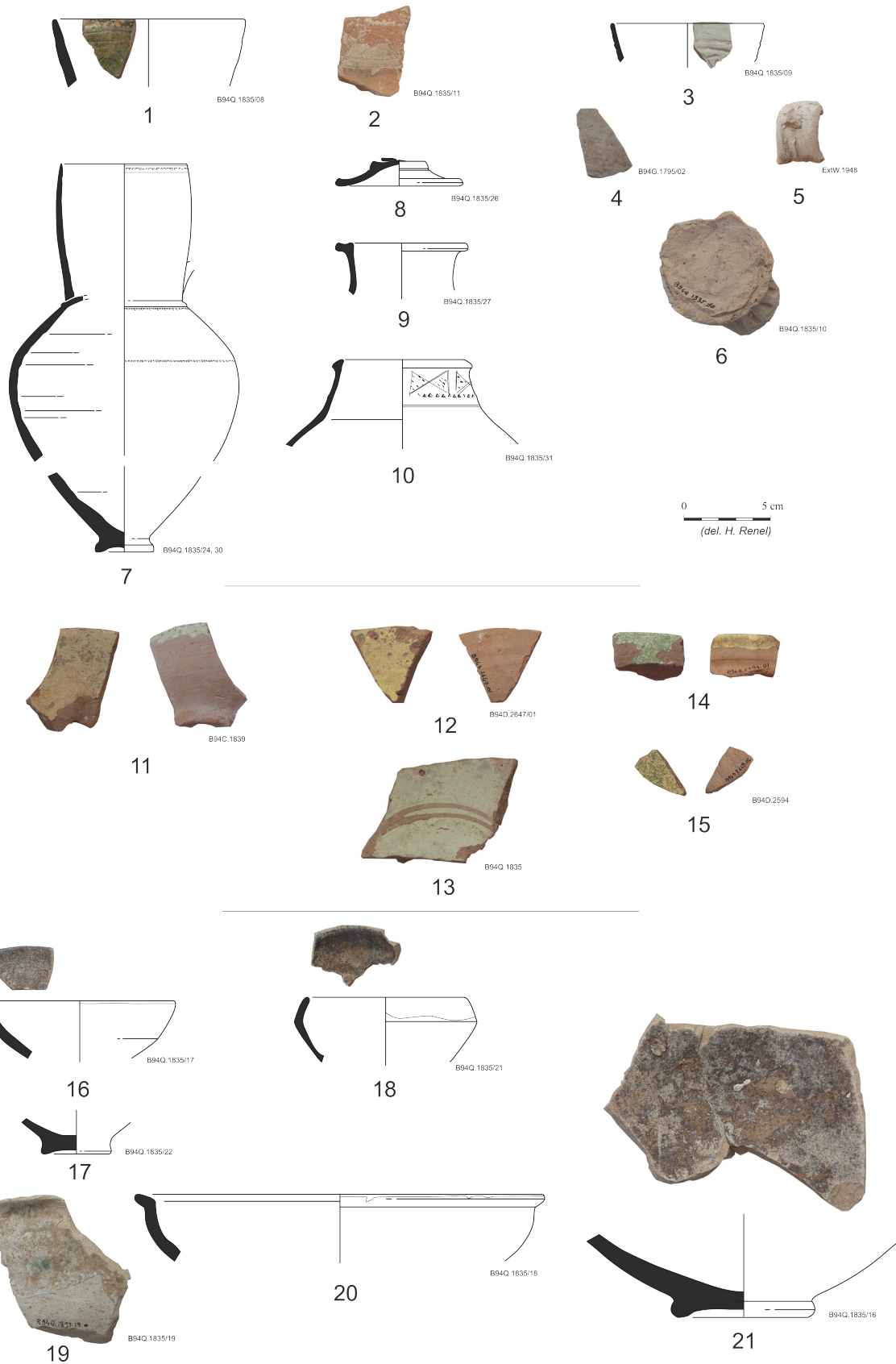

Pl. 14. B94. Material of the 2d half 13th cent. and 1st half of the 4th cent. from Iran (1-10), Yemen (11-15) and Oman, Qalhât (16-21).

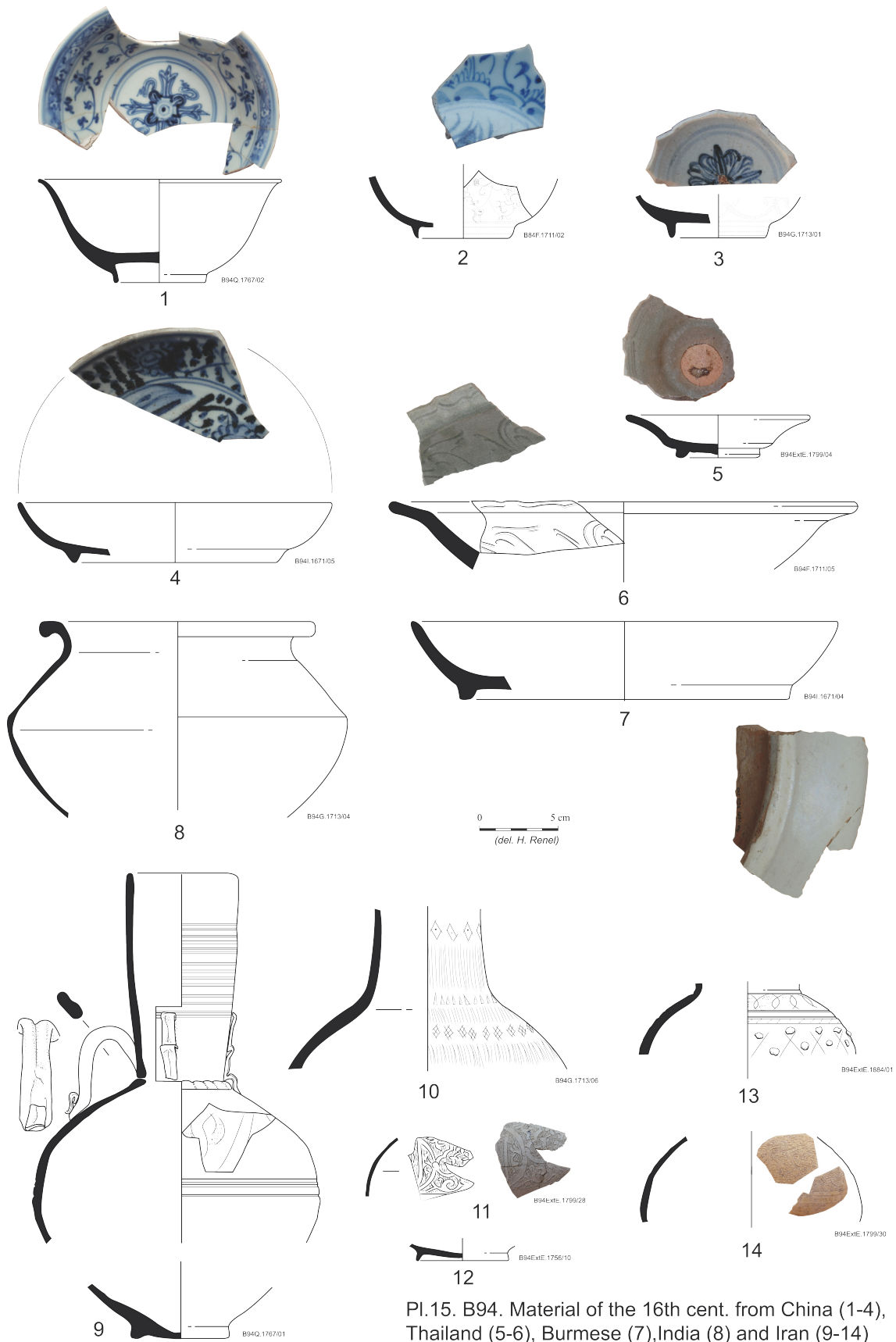

Pl.15. B94. Material of the 16th cent. from China (1-4), Thailand (5-6), Burmese (7), India (8) and Iran (9-14)



Pl.16. B94. Material of the 16th cent from Arabian peninsula : Yemen (1-2), Arabia (3-5), United Arab Emirates (6, 9-10) and Bahrain (7-8).

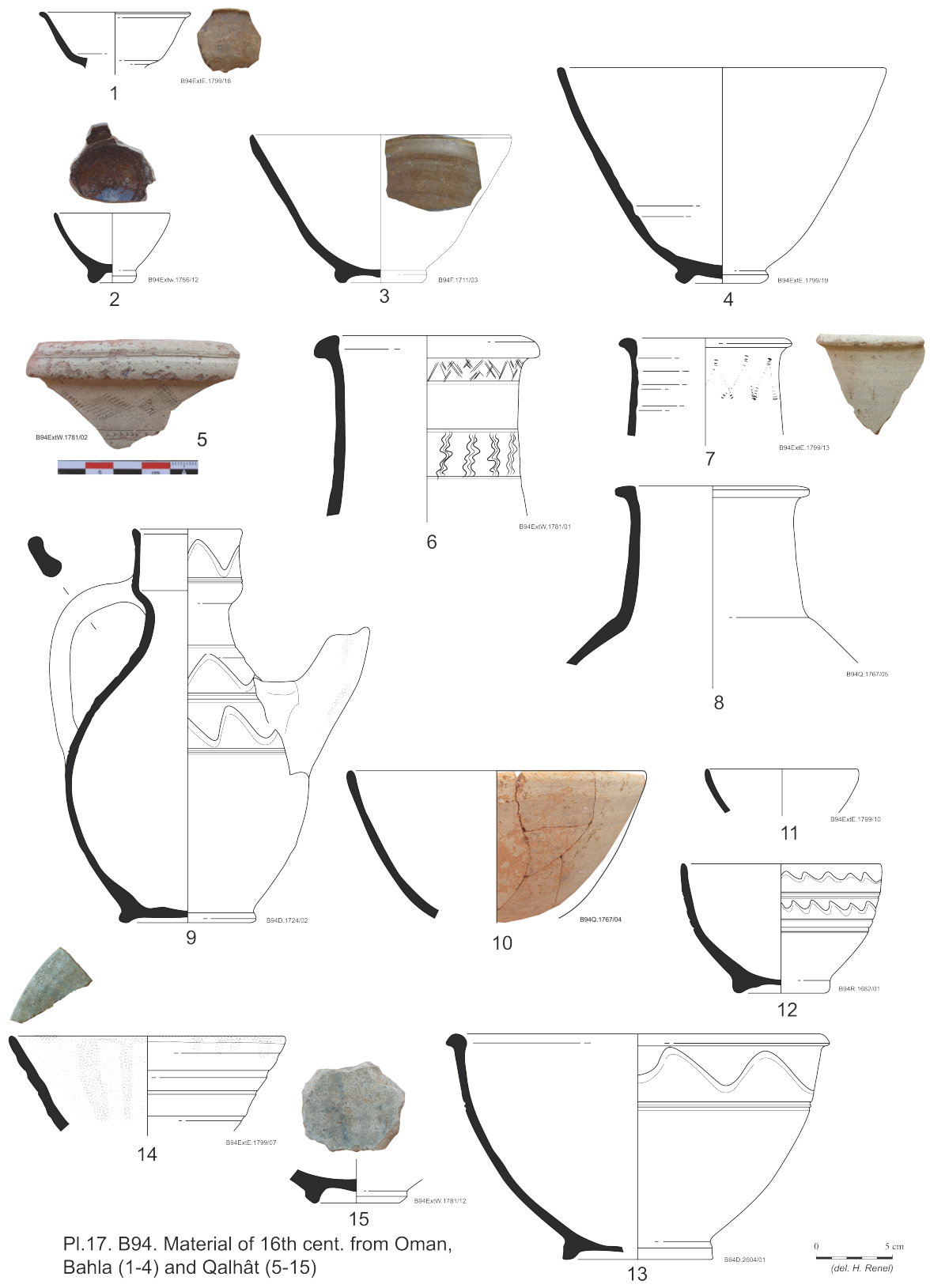

Pl.17. B94. Material of 16th cent. from Oman, Bahla (1-4) and Qalhât (5-15)

B 21, technical drawings

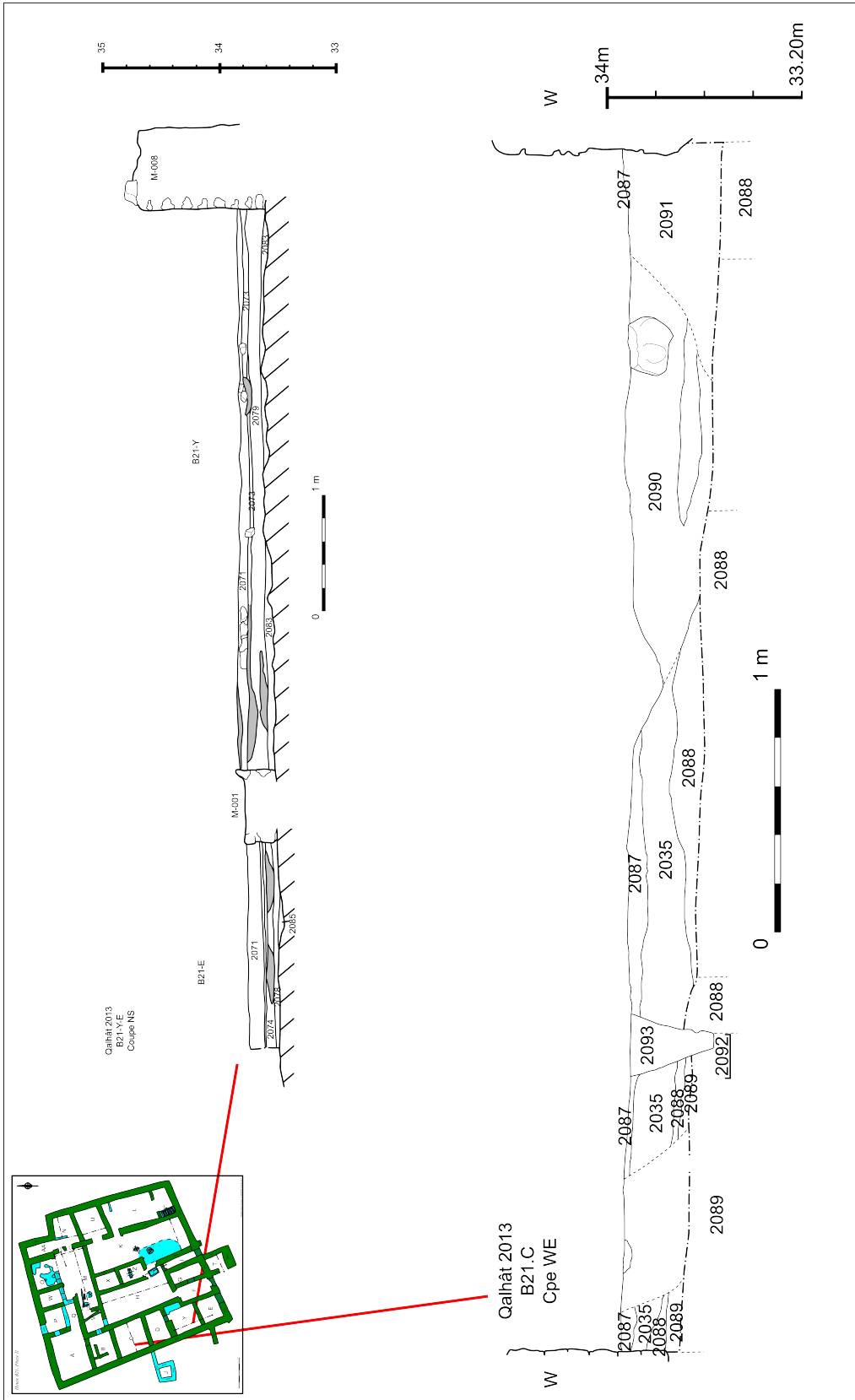

B21 C and E, sections

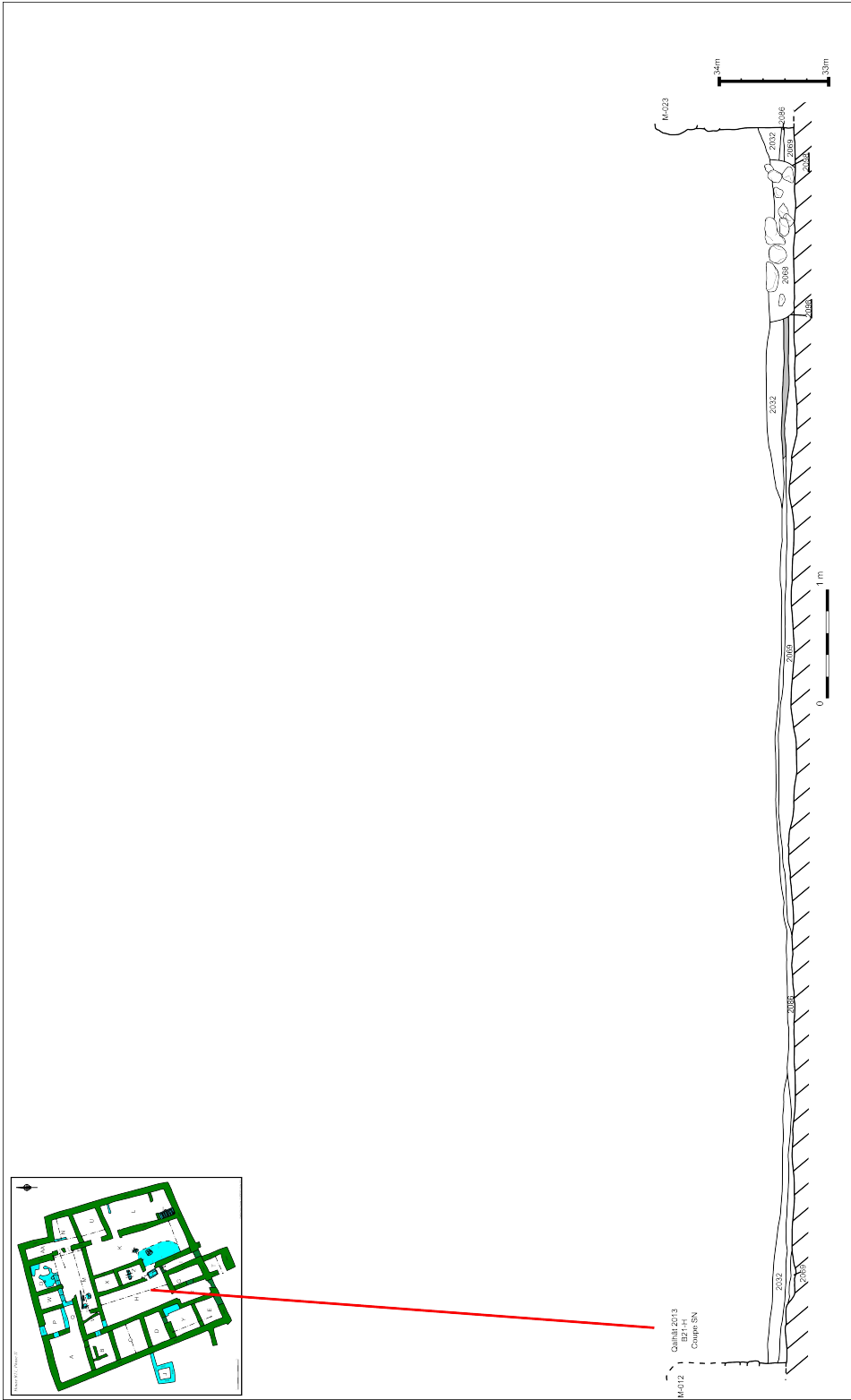

B21 H, sections

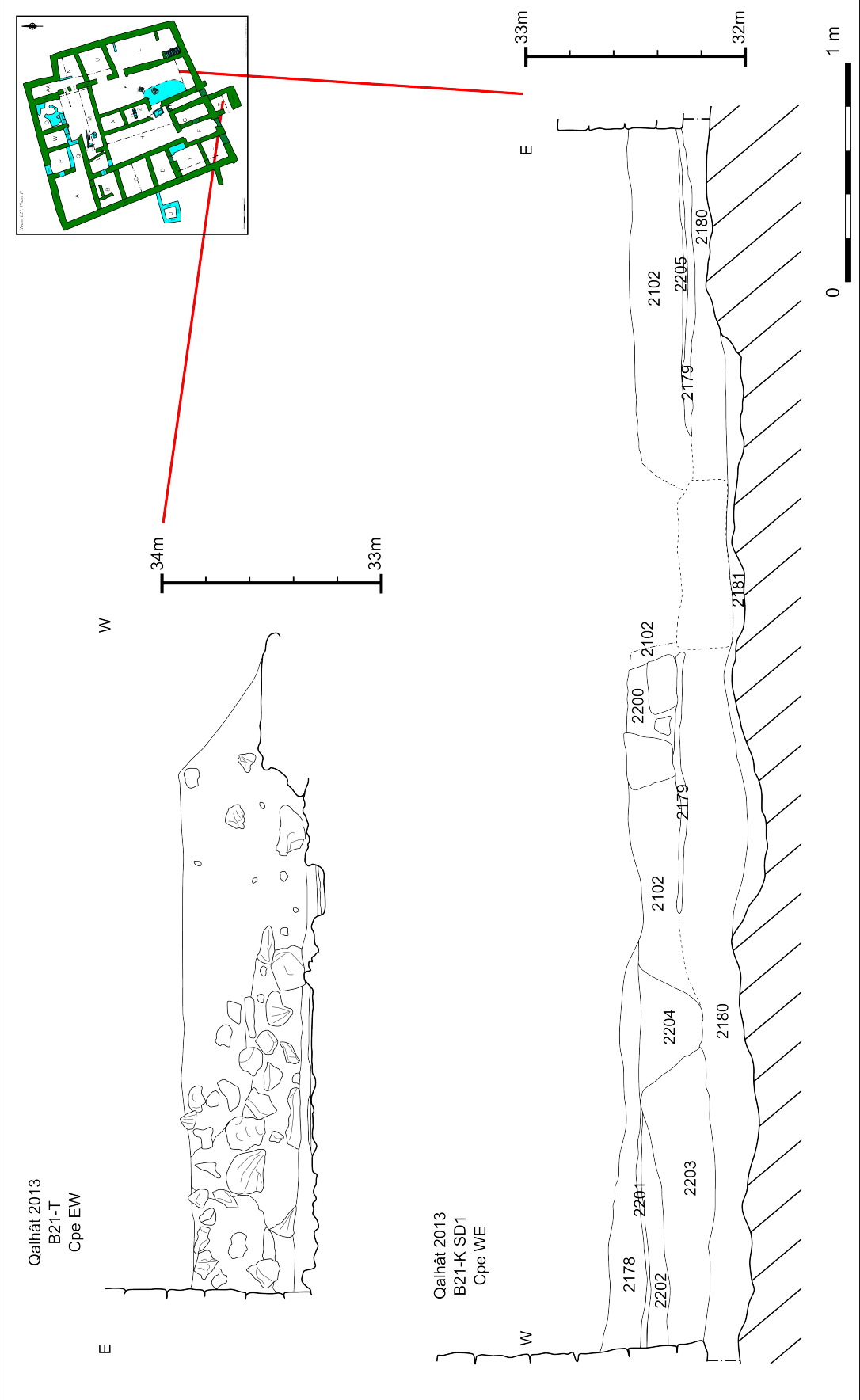

B21 K and T, sections

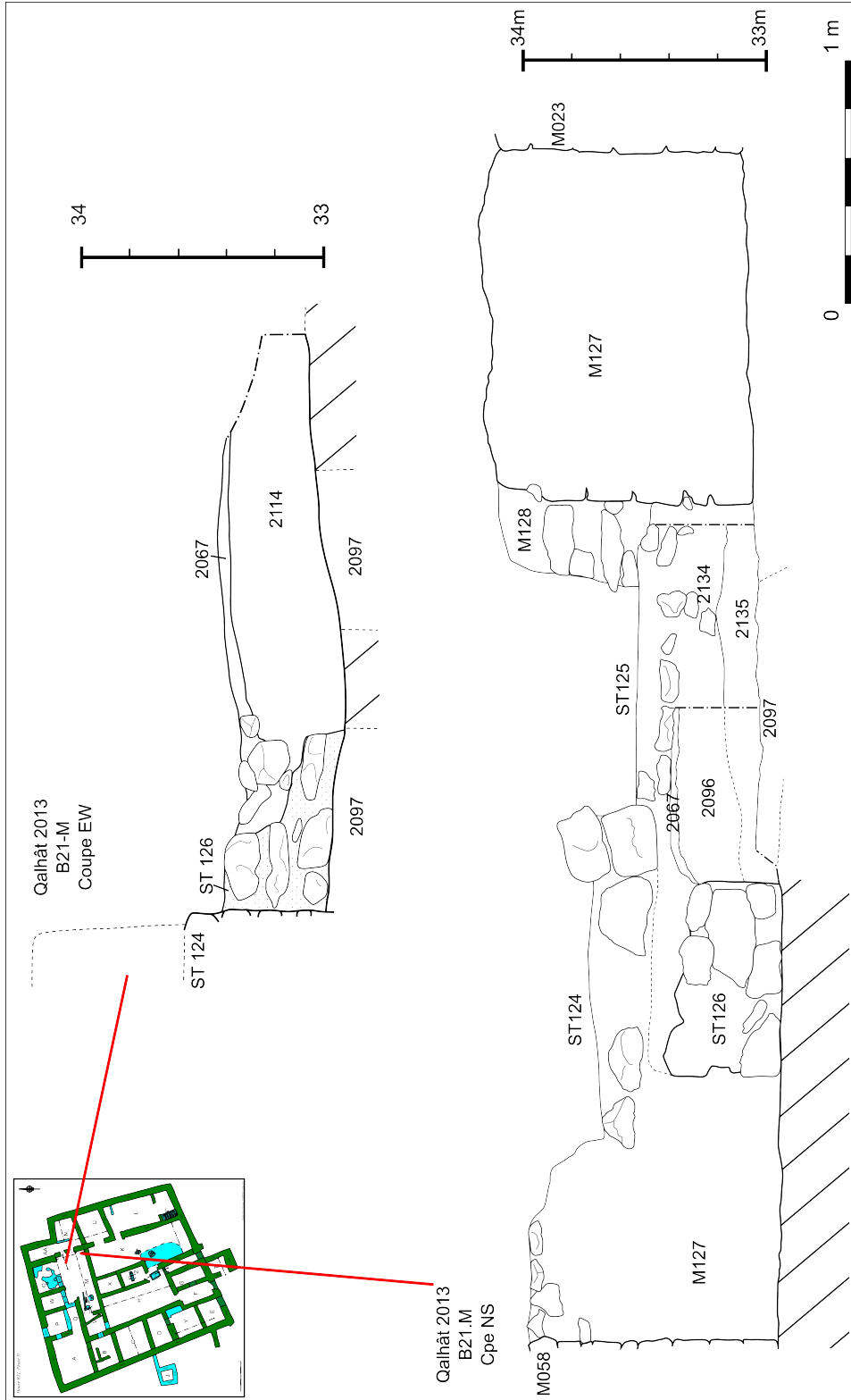

B21 M, sections

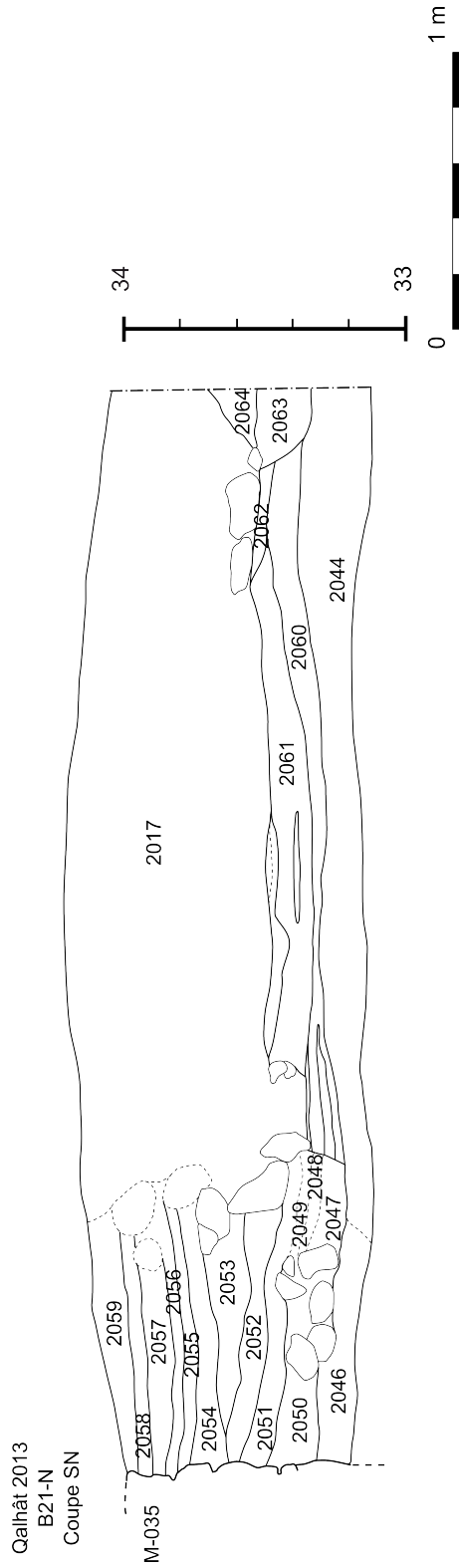
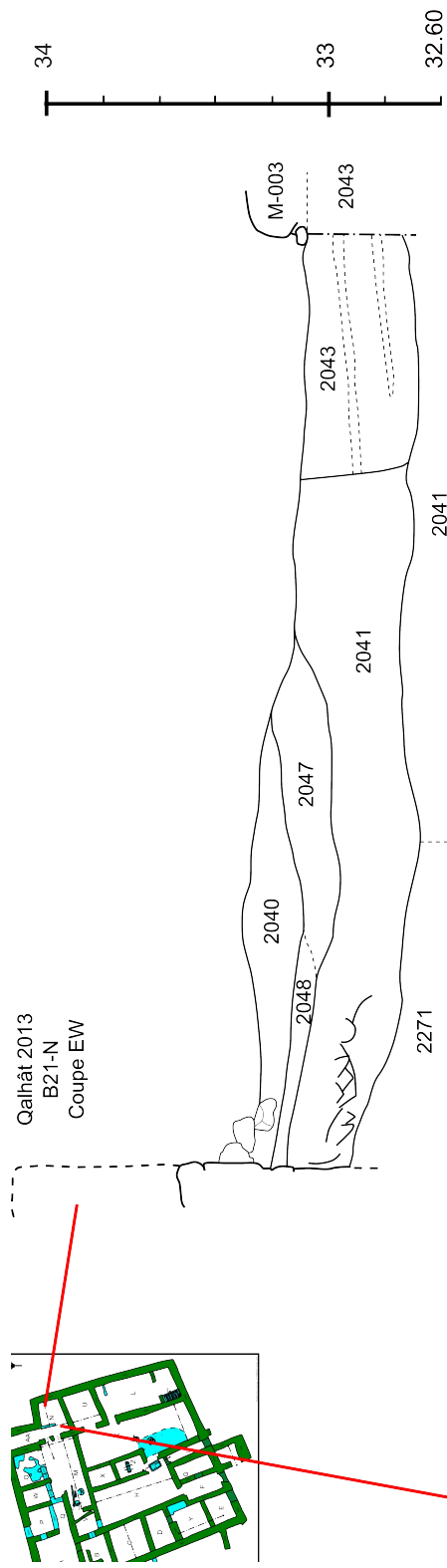

B21 N, sections

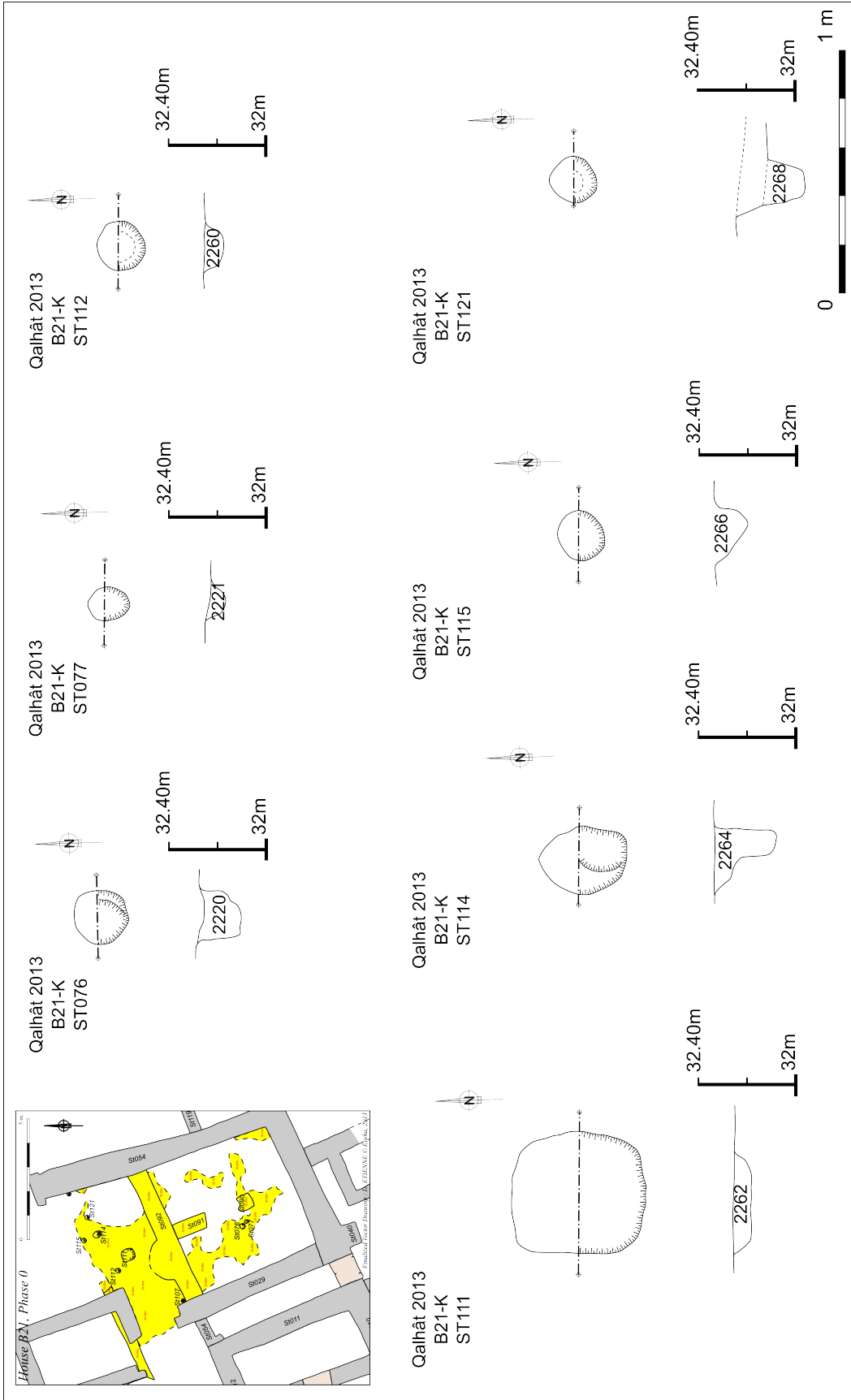

B21 Phase 0, ST in K



Qalhat 2013
B21.T
ST116



32.40m

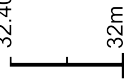

2244
2243

Qalhat 2013
B21.G
ST038

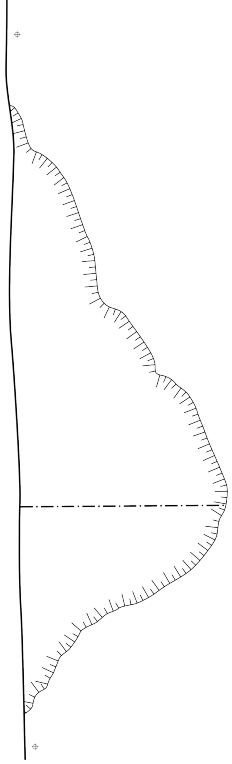

33m

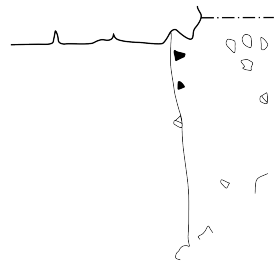
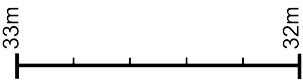

0 1 m



B21 Phase I, ST in T and G

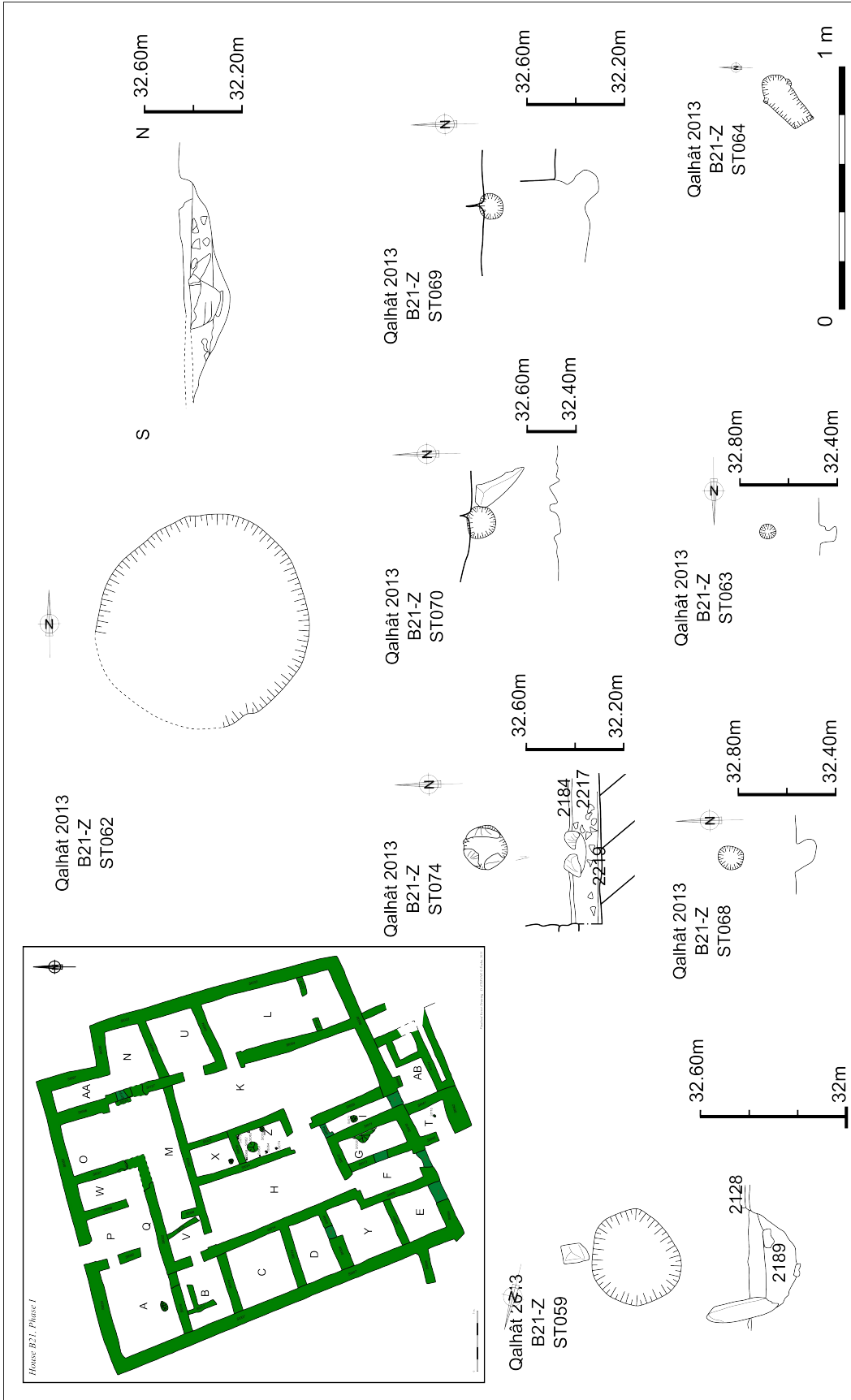

B21 Phase I, ST in Z

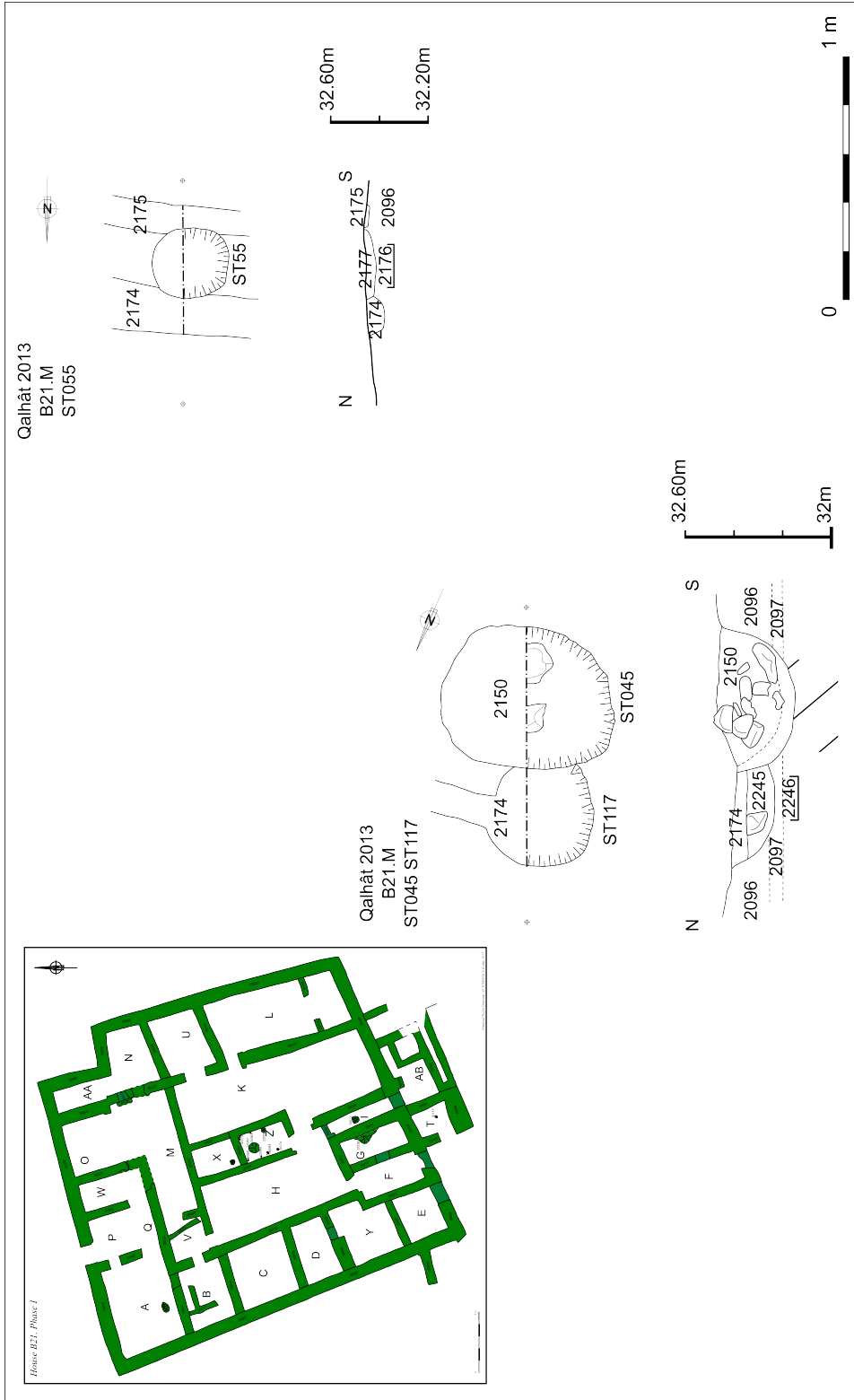

B21 Phase II, ST in M

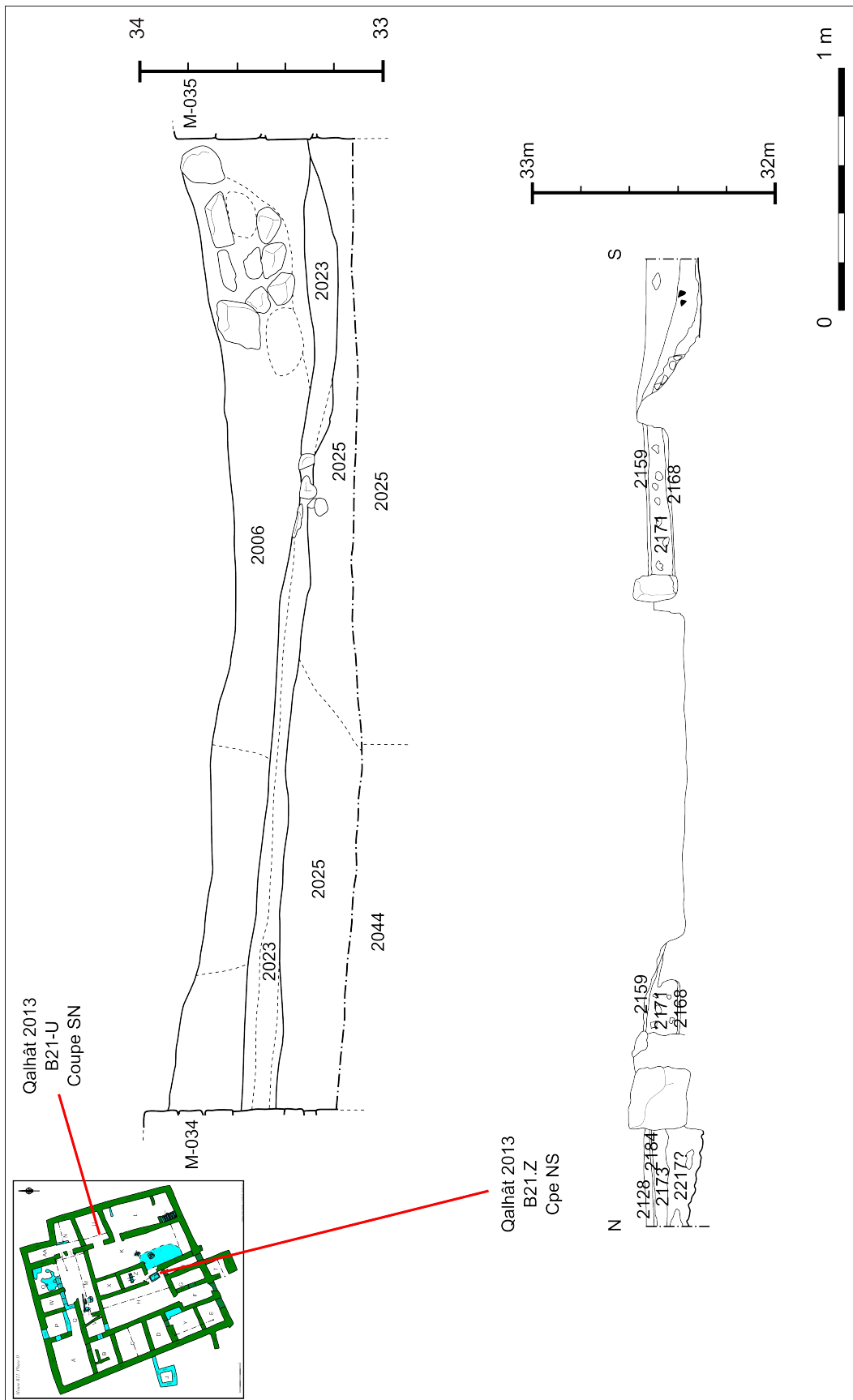

B21 U and Z, sections

B 20, technical drawings

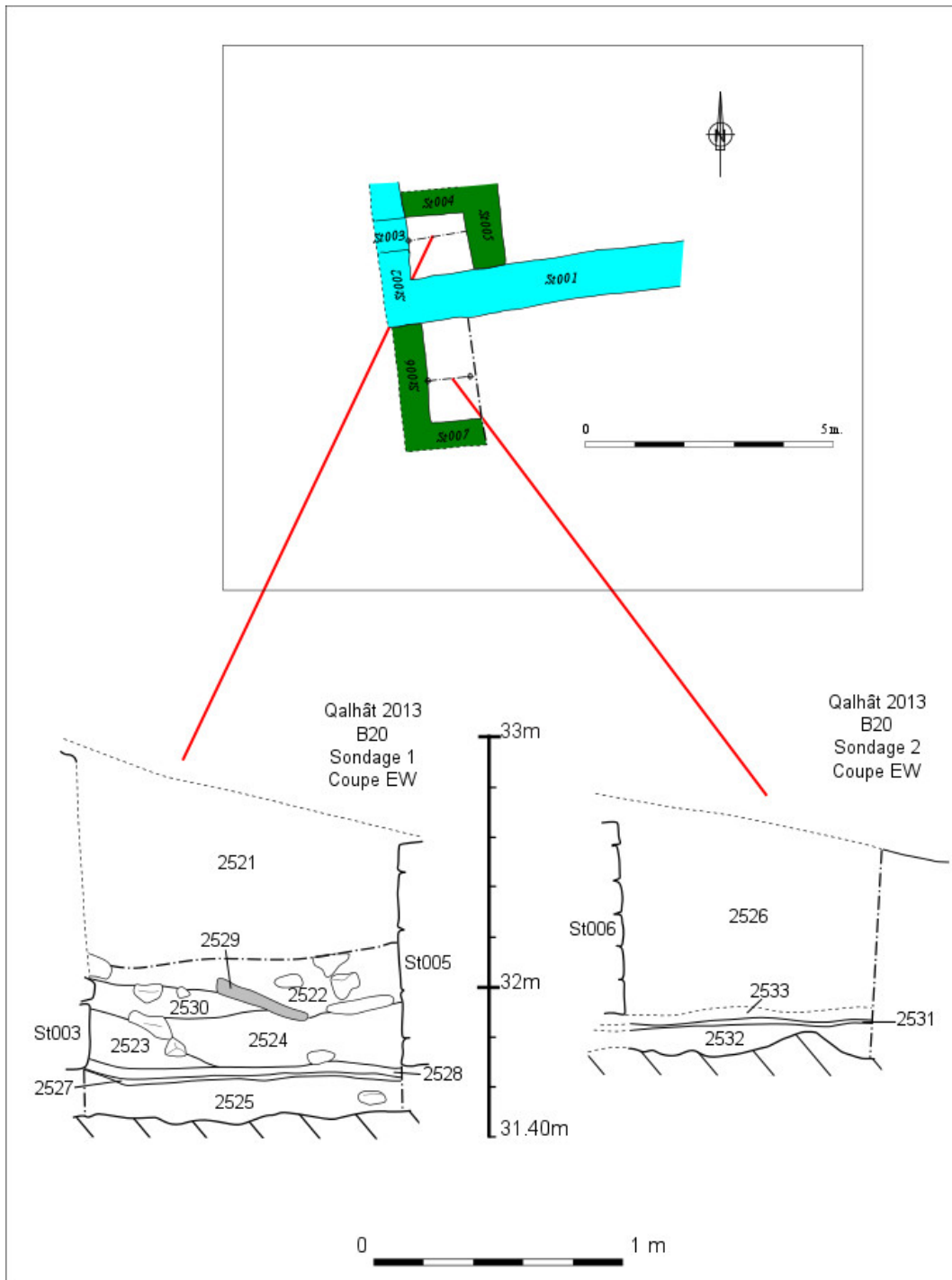

B20, sections

B94, non-ceramic material

Piece B

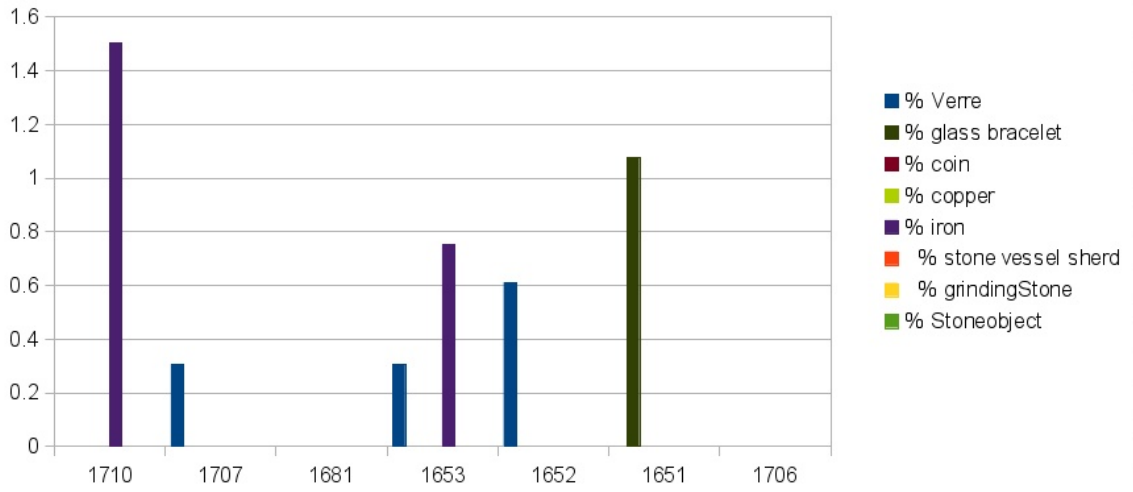

Piece R
sub-title

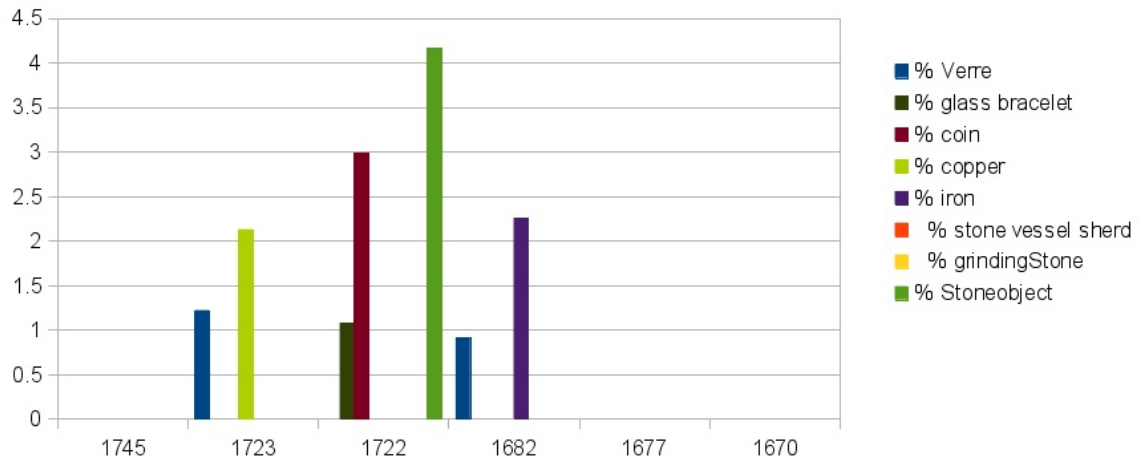

Piece Q
sub-title

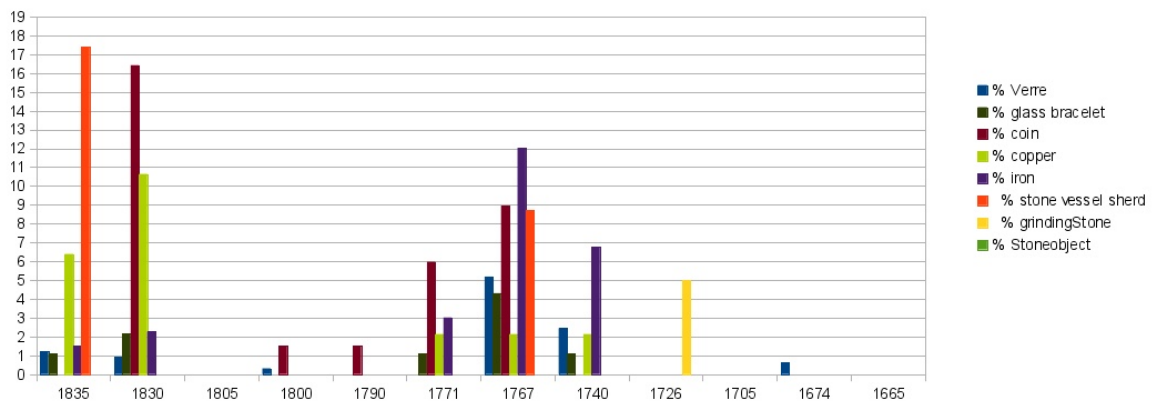

Piece I
sub-title

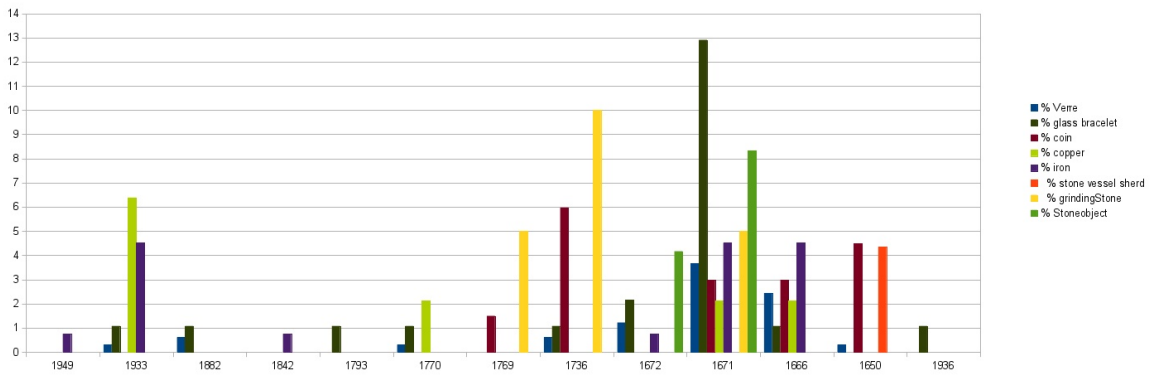

Piece G
sub-title

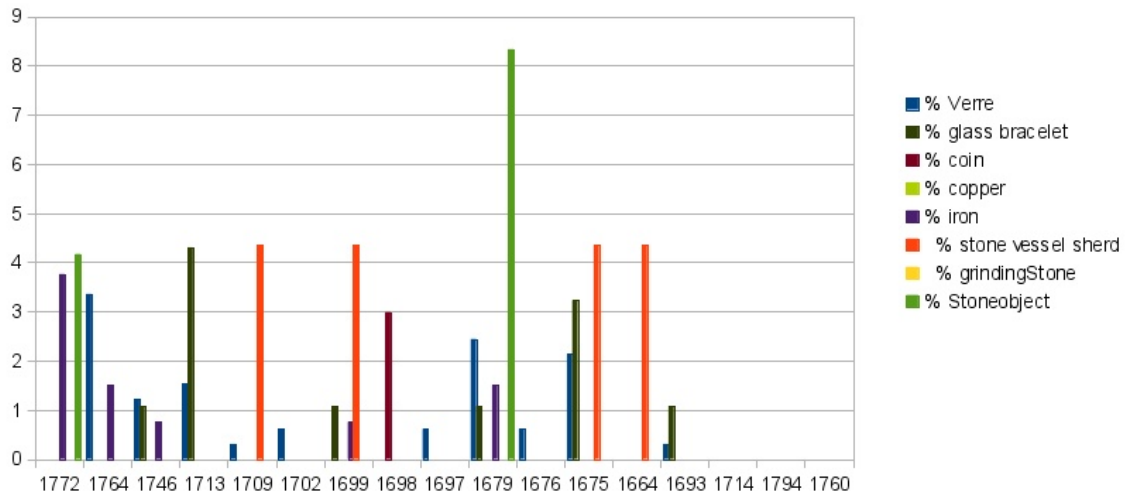

Piece P
sub-title

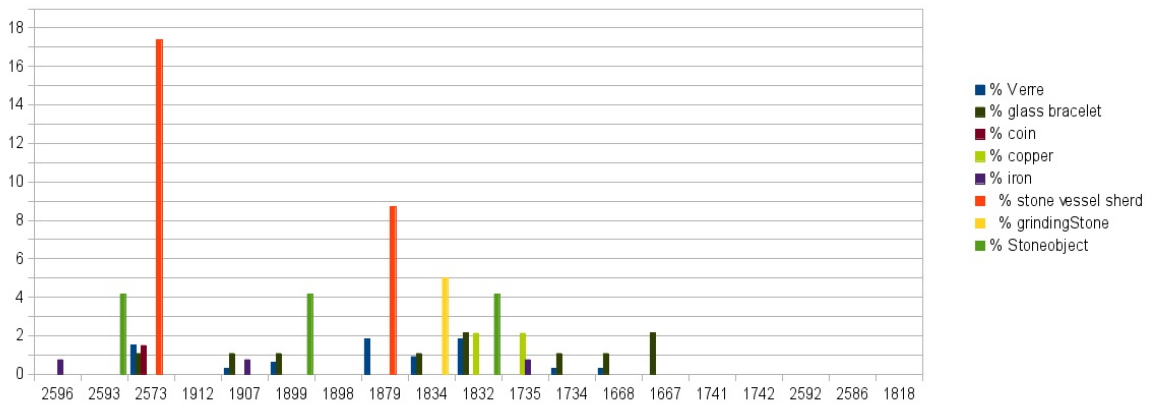

Piece D

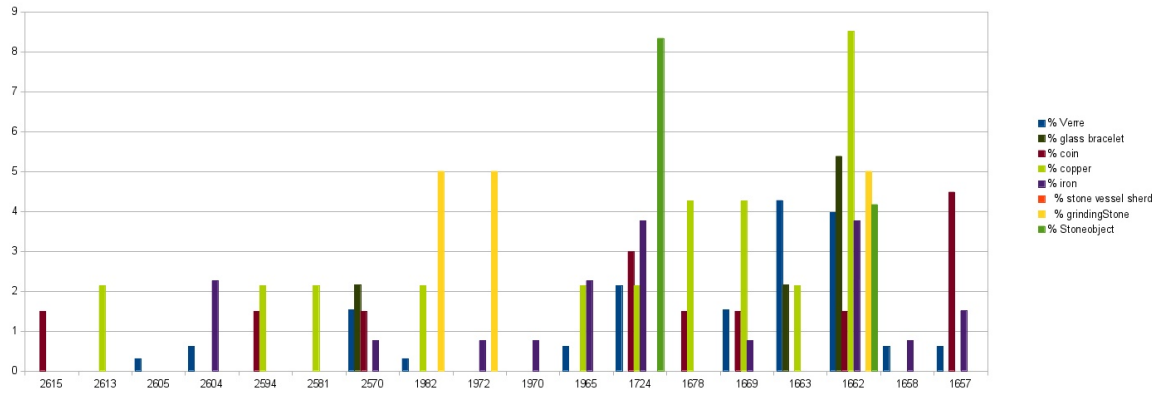

Piece C

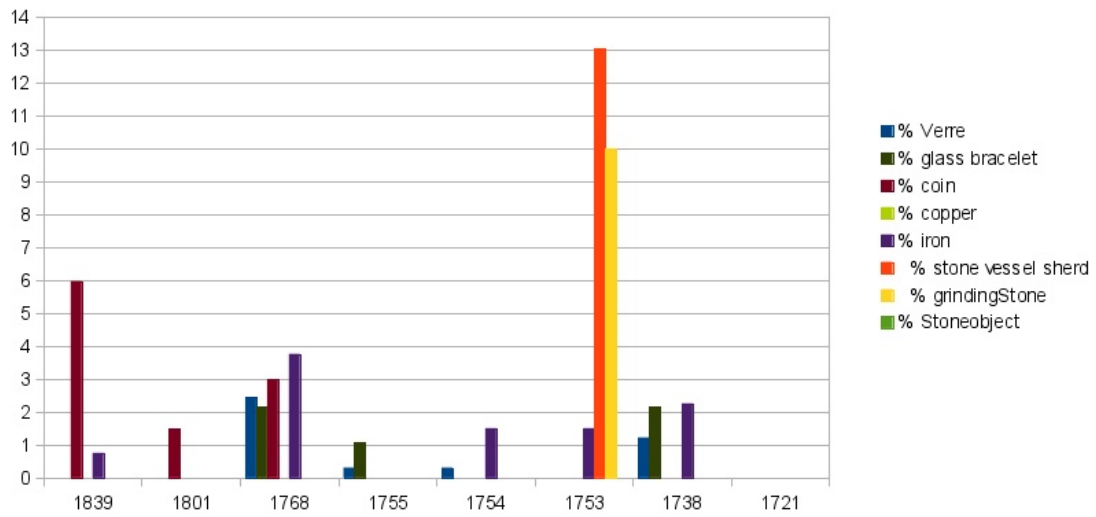

Piece F
sub-title

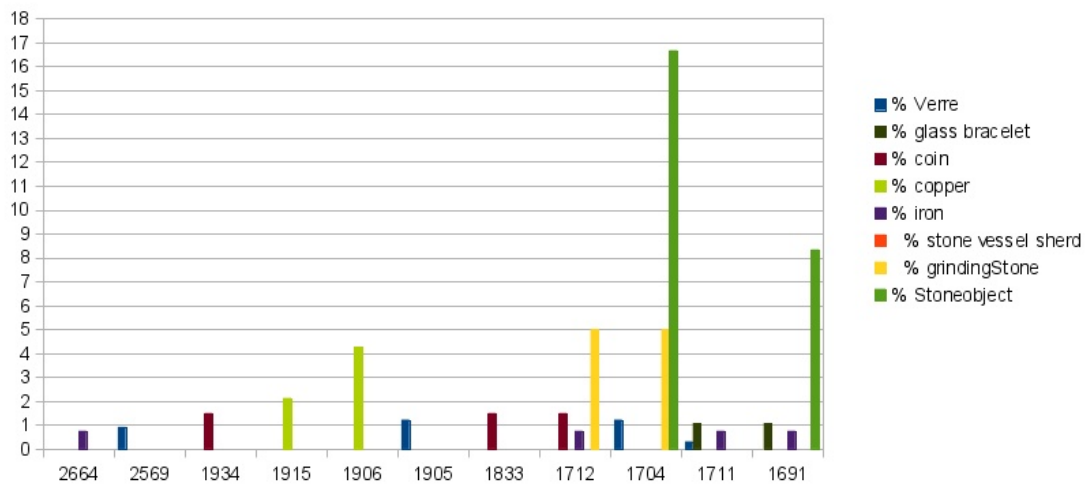

Ext E
sub-title

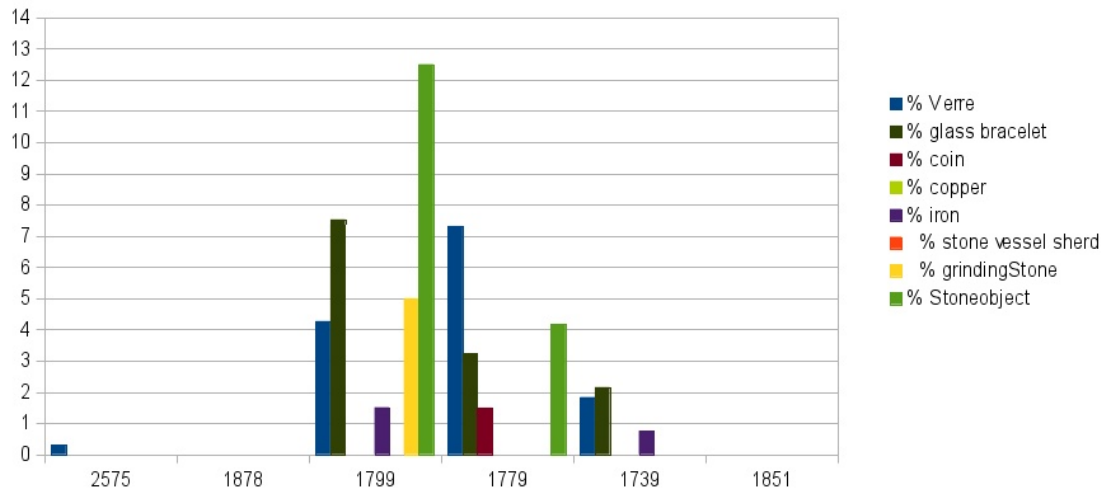

Ext N
sub-title

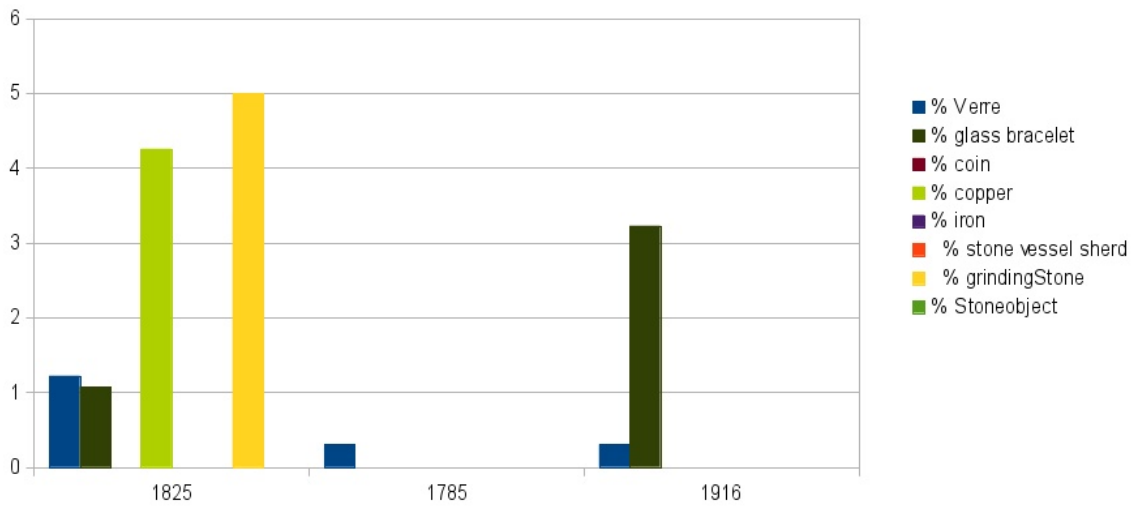

Ext W
sub-title

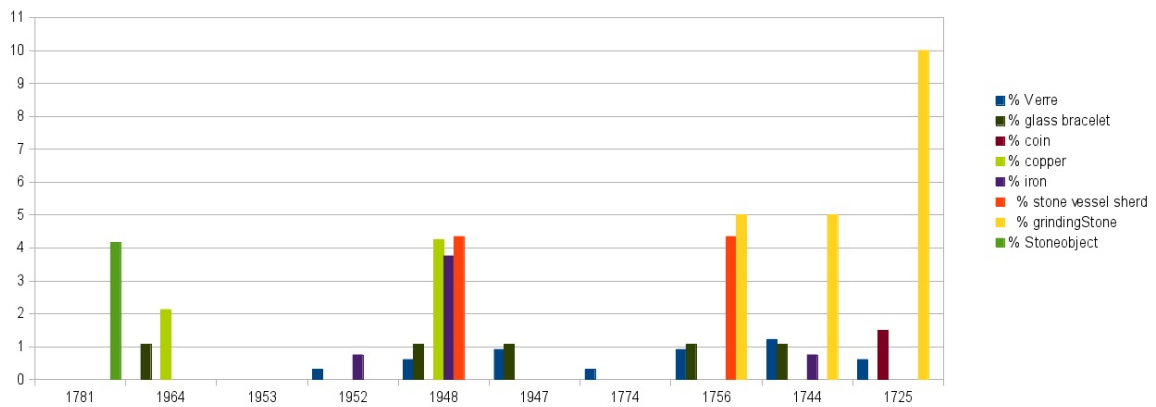

Ext W
sub-tite

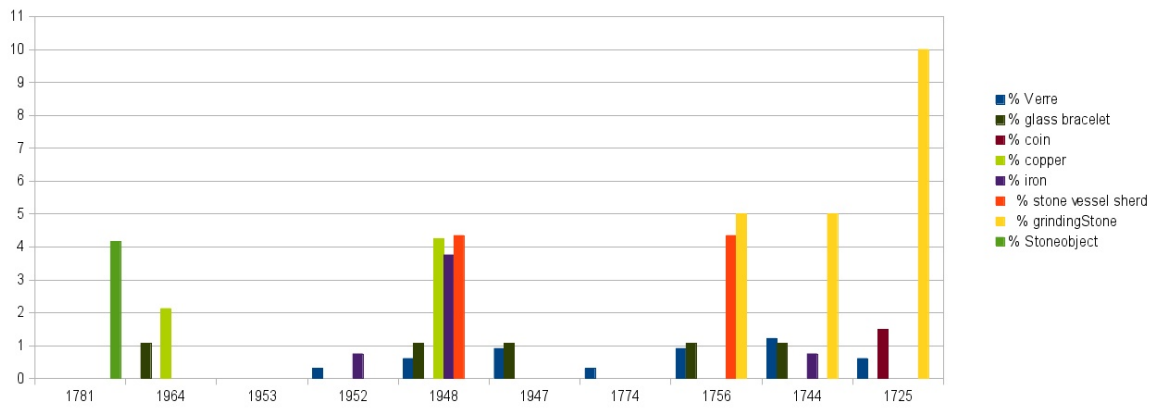

B21, non-ceramic material

A

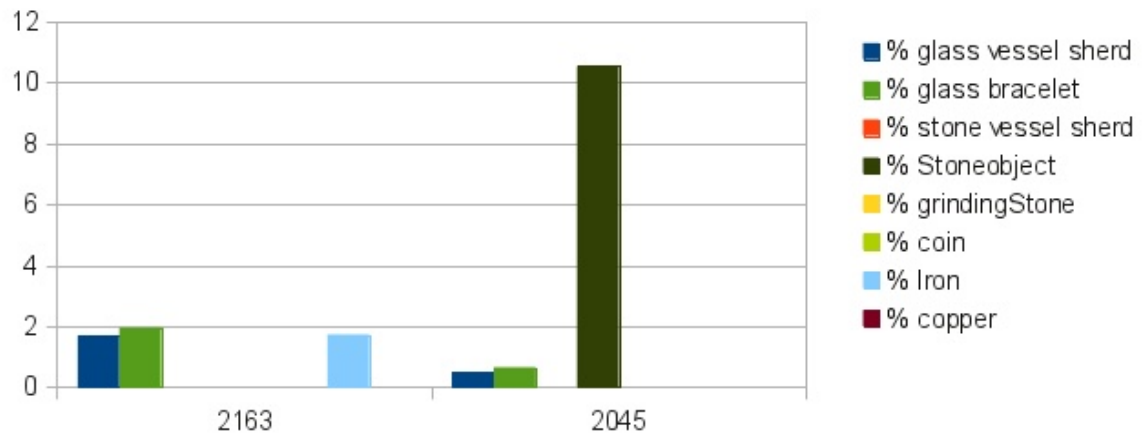

E

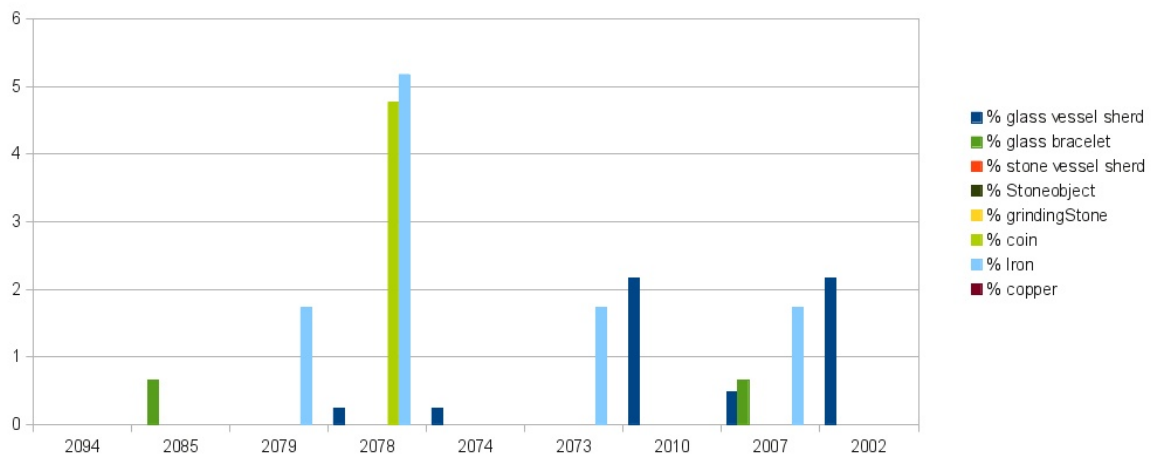

G

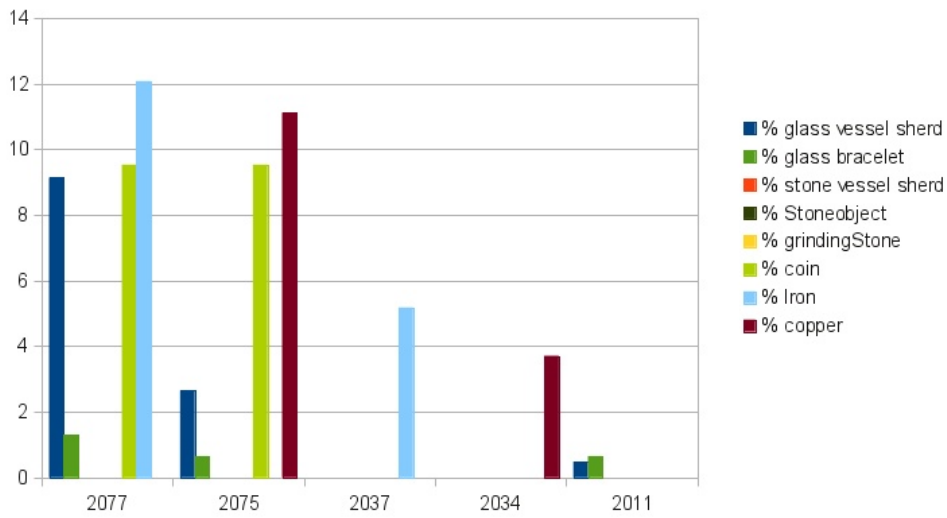

B

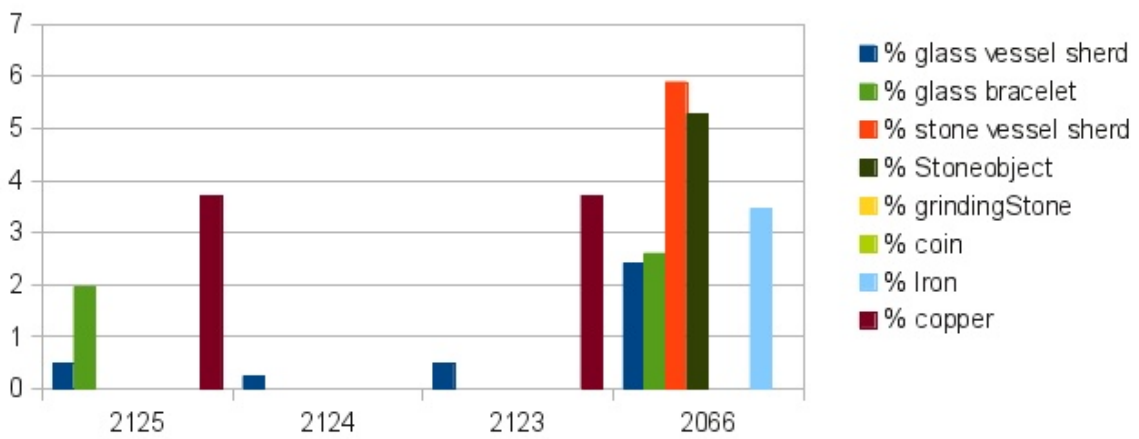

C

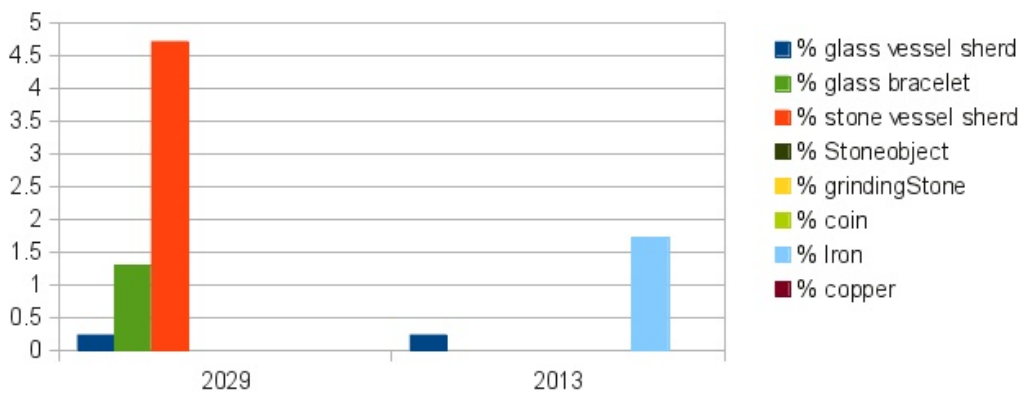

D

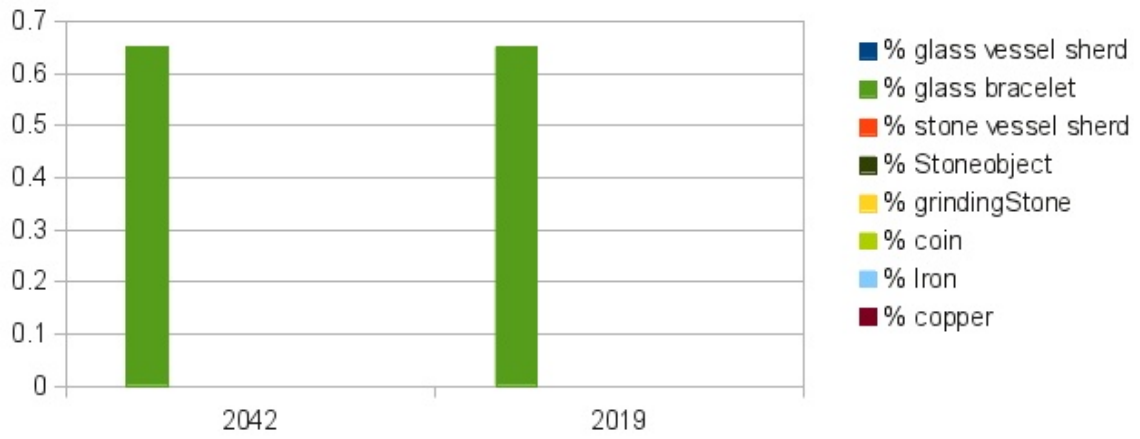

G

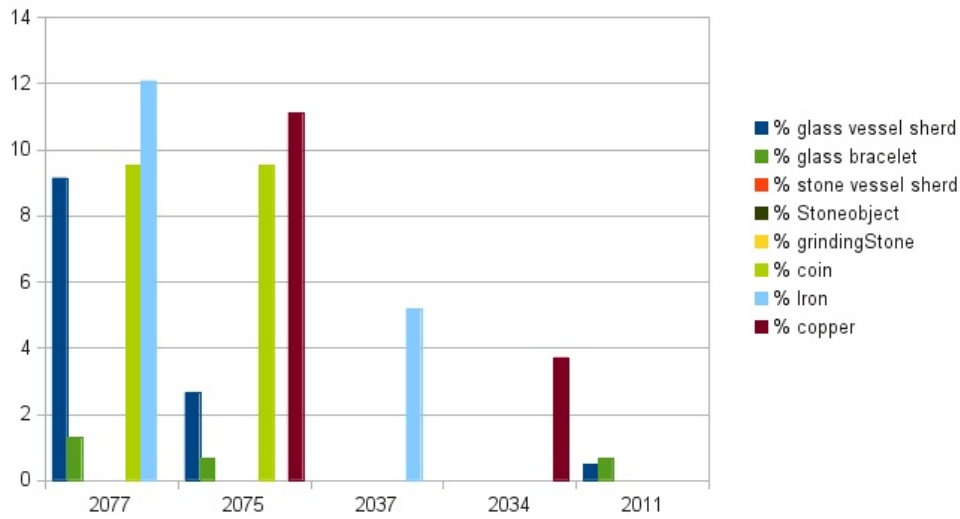

H

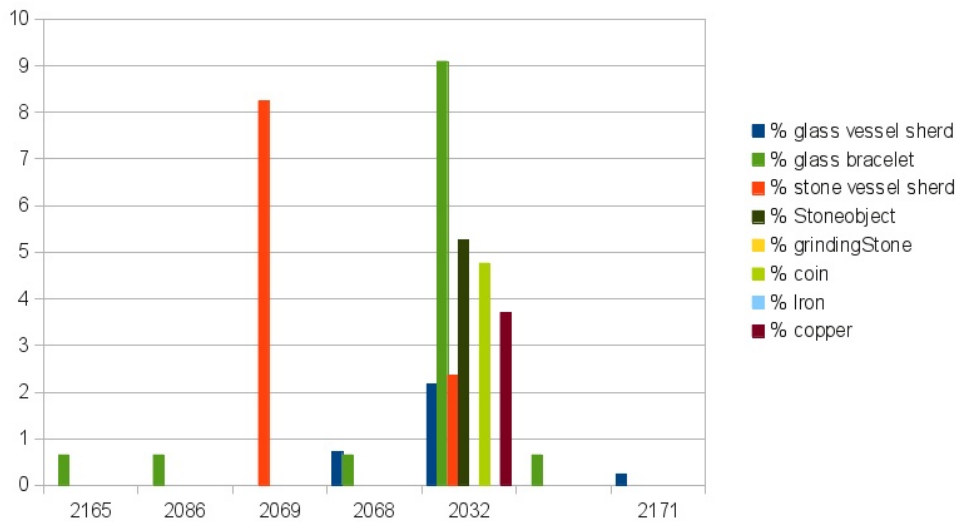

I

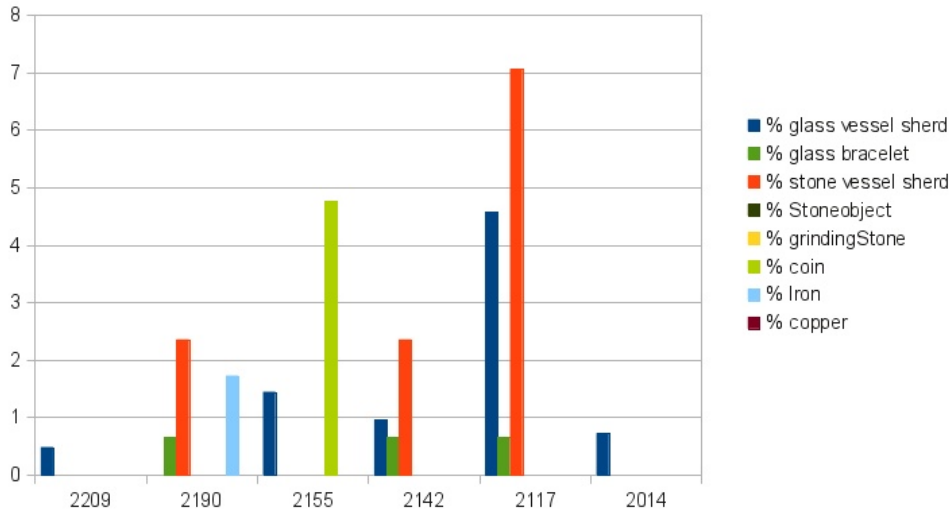

J

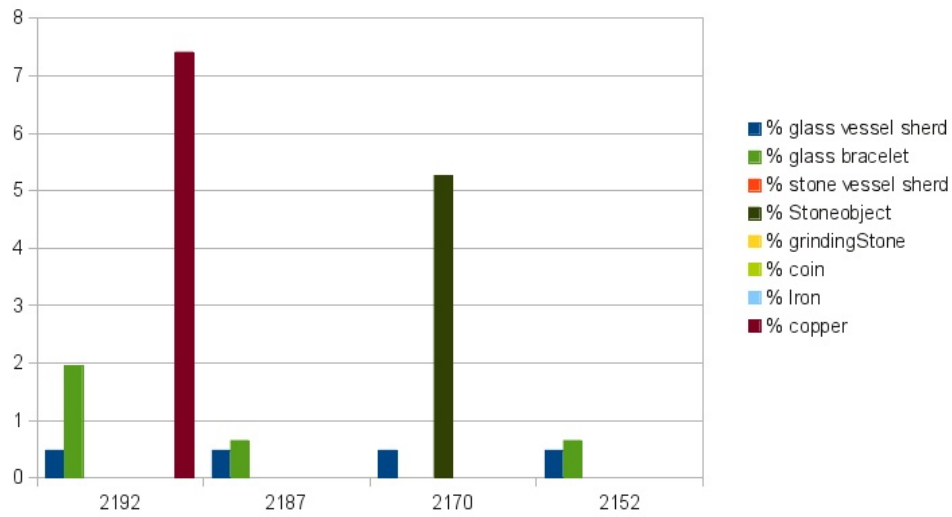

K

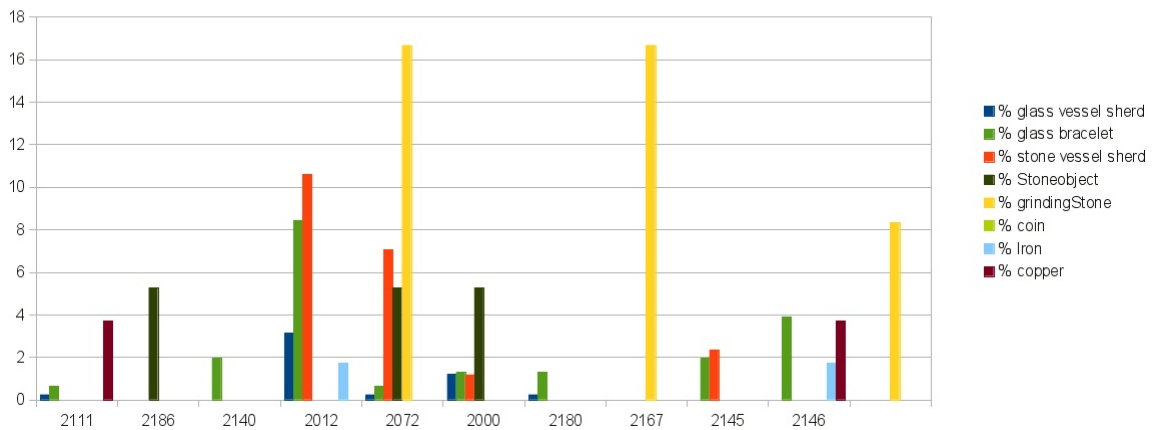

L

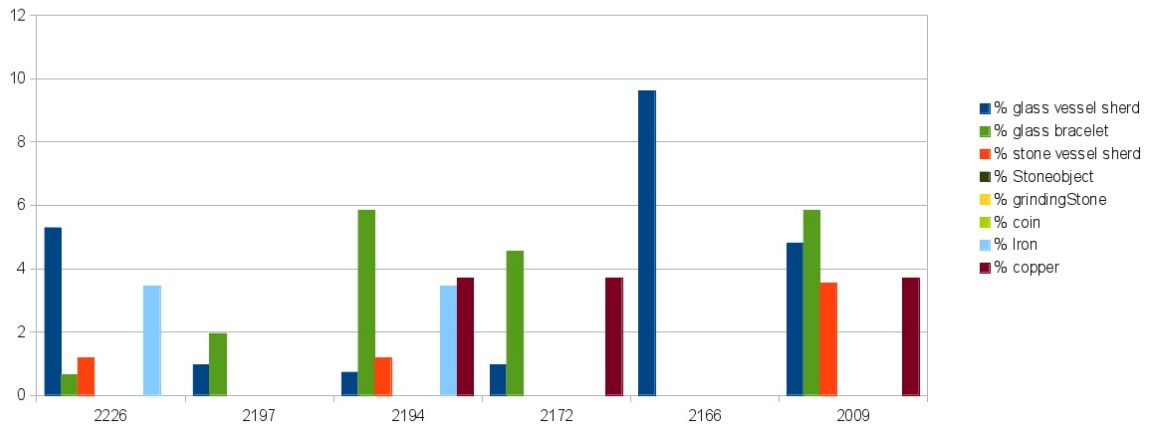

M

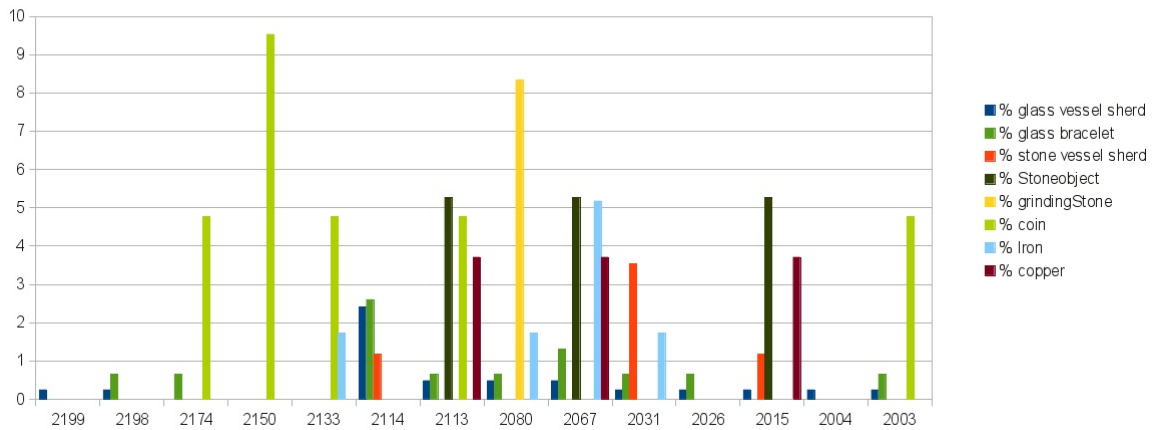

N

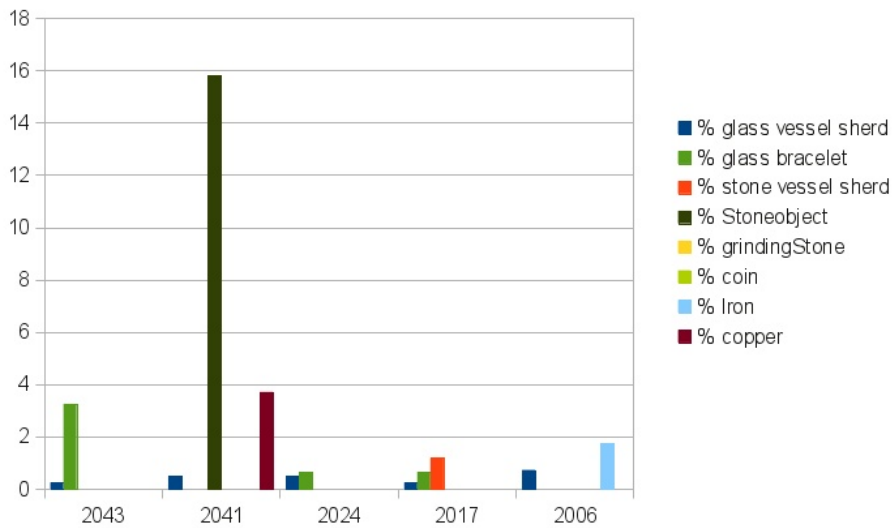

O

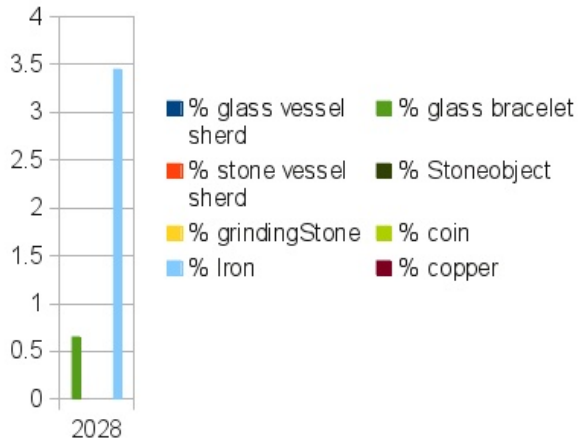

P

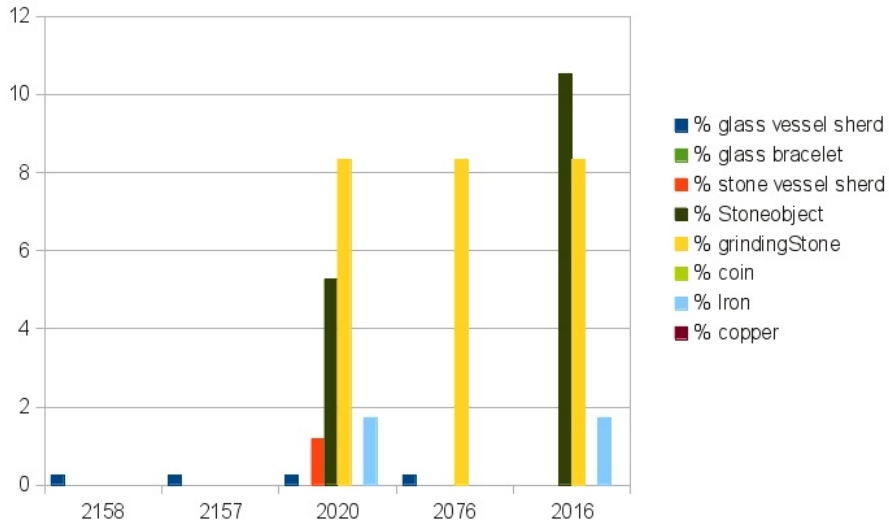

Q

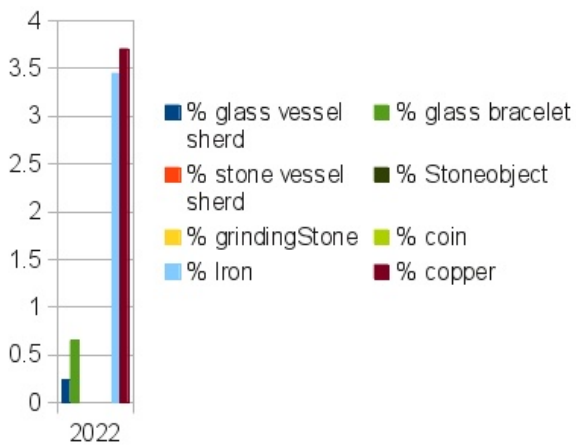

R

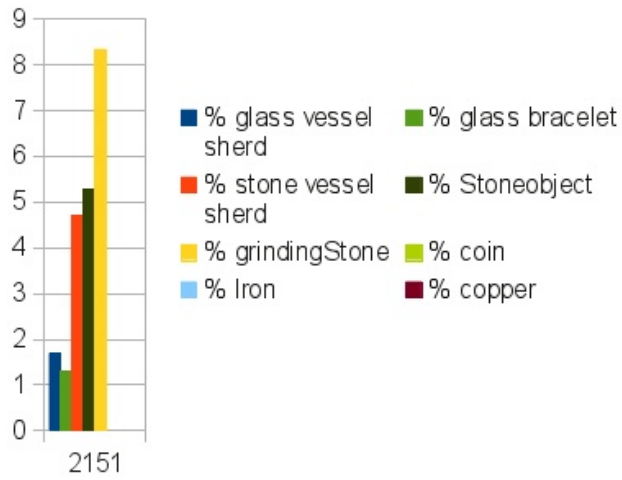

SE

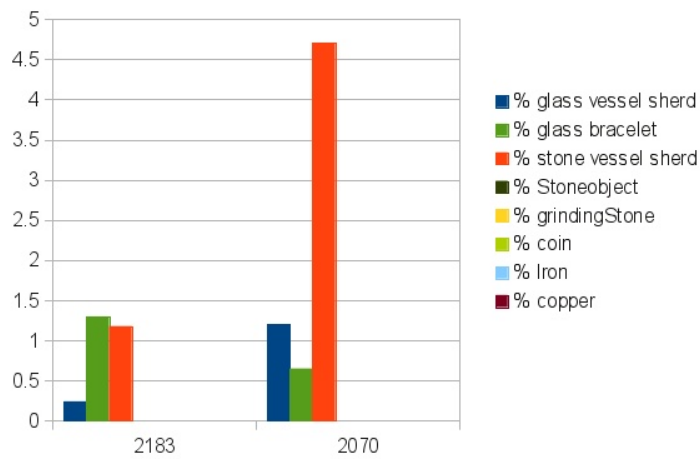

SN

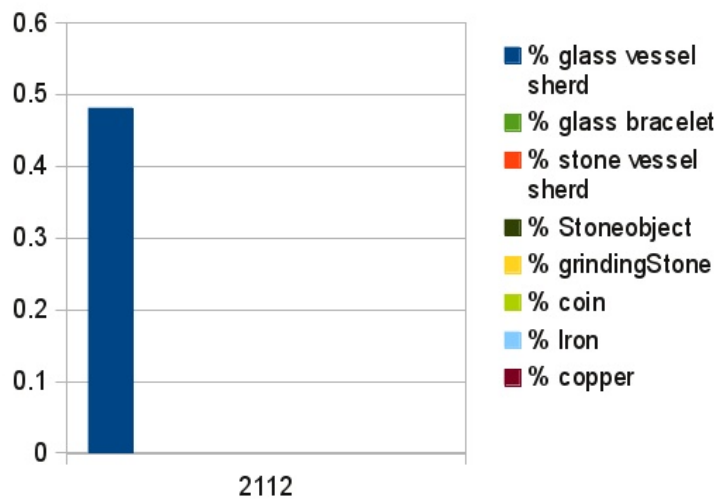

SS

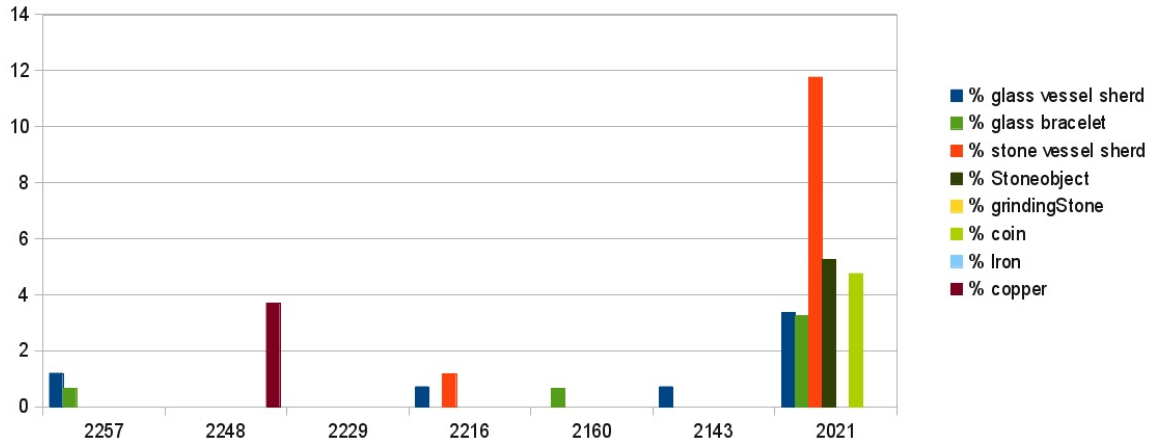

SW

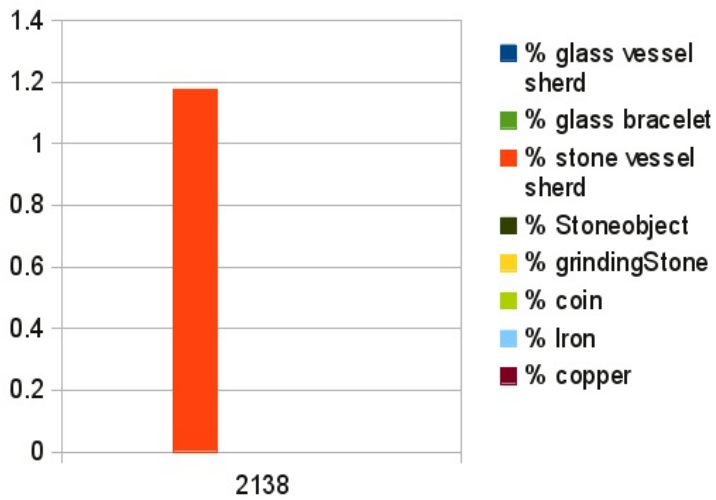

T

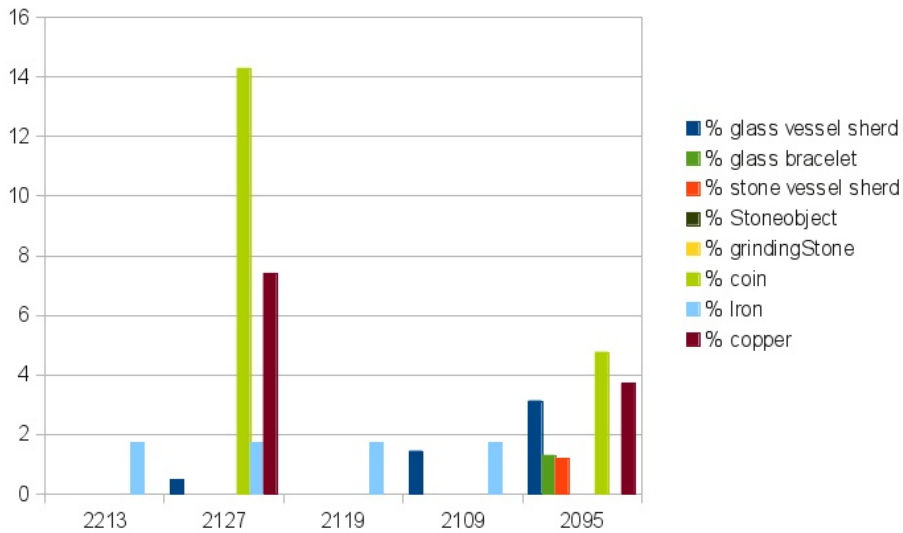

U

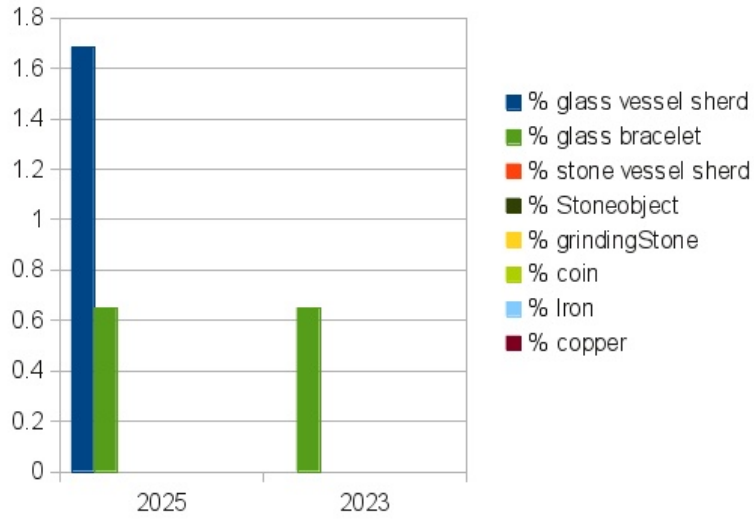

V

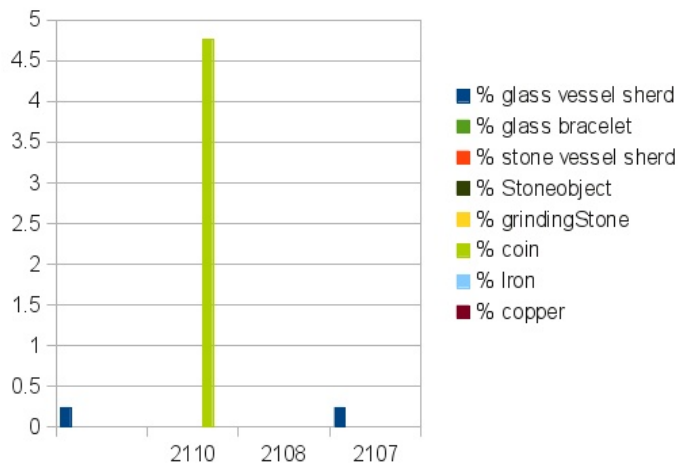

W

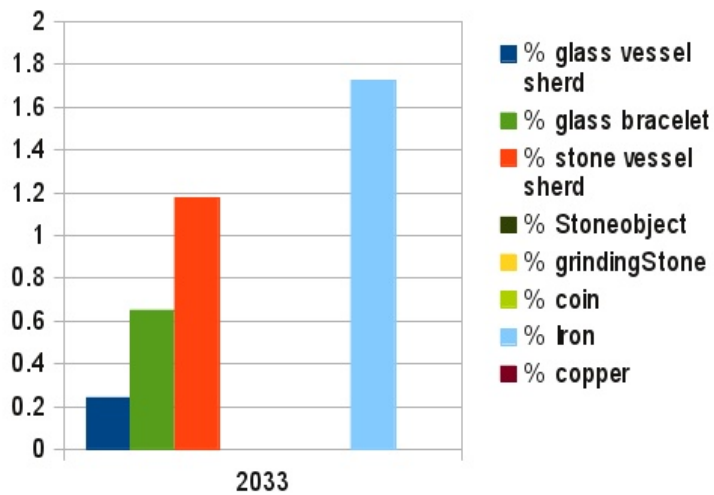

W

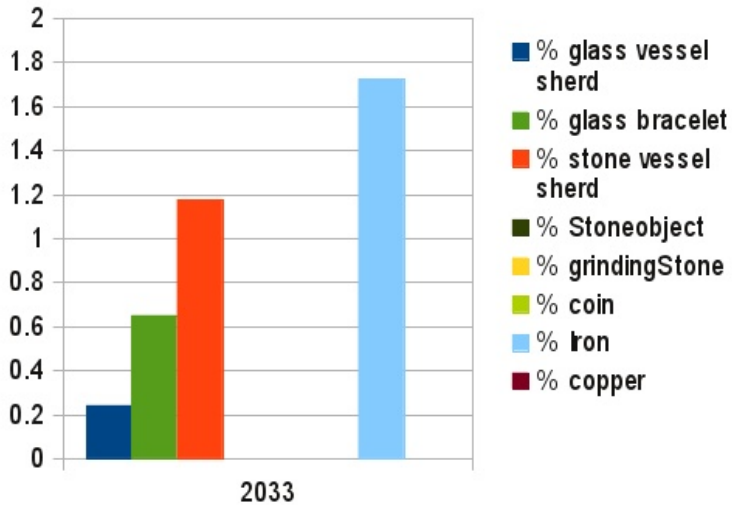

Z

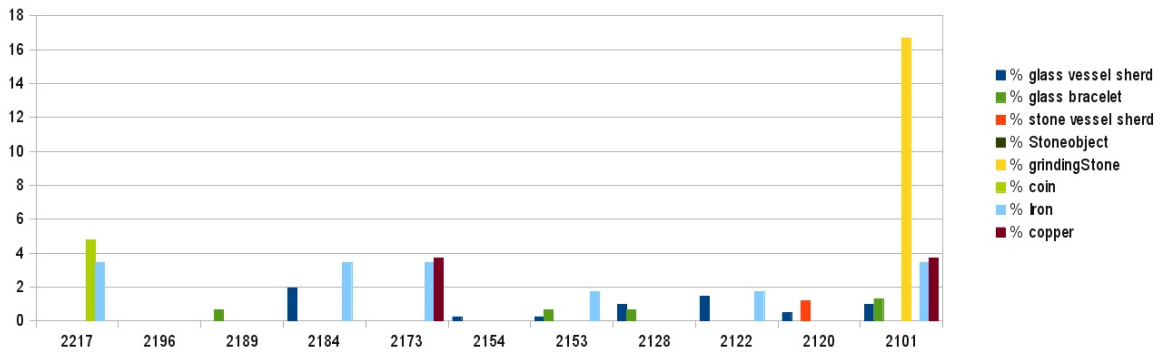

Archeozoology

L	UF	Caprine	Chicken	Cattle	Cat	Pig	Fox	Vulture	Indet.
--	1154	8	1						2
S 14	1178	5	1						
S 14	1194	22	1			1			18
S 14	1306	66		1	1				40
S 14	1309	6					1		3
S 15	1171	26	2		4				
S 21	1186	8	1						
S 21	1193	31	1						11
S 23	1157	4							
S 23	1301	21	1						7
S 24	1162	12							4
S 24	1300	16			15				6
S 24	1304	7			20				
S 25	1182		1						
S 25	1183	5	1		1				
S 25	1189	8							7
S 28	1329	7							3
S 28	1330	5							
S 28	1337	24	1						11
S 28	1338	10							14
S 28	1339	10							
S 29	1323	9	1						
S 29	1343	1							
S 29	1346	8							
S 3	1102	32						1	7
S 6/14	1314	6			1				
	TOT	357	12	1	42	1	1	1	133

Tab. 2. Number of animal remains from the various UF of the building B12, the mosque (in NISP, number of identified specimens)

Room	UF	Caprine	Chicken	Redmeat	Cattle	Horse	Cat	Dog	Rabbit	Gazelle	Bird	Mammal	Insect
--	1400	17	1										8
A	1409	3											16
A	1411	223	11	5			2						49
A	1488	4	1										
A	1493	7		32									5
B	1410	7											7
B	1416	187	4										21
B	1486	57											15
B	1491	26	1										13
B	1499	27	1										14
B	1501	3											2
B	1517	40	1										17
B	1518	7		1									
B	1524	9											4
B	1652	16											3
B	1653	8											
B	1681	17	1										
B	1707	2											
B	1522-1523	68	5										16
C	1407	3											1
C	1415	14	1										18
C	1420	16		1									
C	1423	1											4
C	1425	12							1		1		
C	1426	1											
C	1437	2	2										15
C	1702	27											
C	1738	6											
C	1753	4					1						
C	1754	6	1	5			1						
C	1755	1											
C	1768	14	1	1									2
C	1802	1											
D	1460	5		1									1
D	1462	9		1									
D	1463	4	1										
D	1477	4											2
D	1658	10											10
D	1662	77	5	1									13
D	1663	2	2										2
D	1669	1	1										10
D	1678	3		1									2
D	1724	34	1	1									22
D	1907	9	1										
D	1941	1											
D	1965	16		1									
D	1969	3	1										
D	1970	3	2										3
D	1972	1											
D	1976	4	1										
D	1982	25		1							2		
D	2570	31		1									
D	2573	23	1				1						
Ext. E	1739	35	4		1								11
Ext. E	1779	82	4										55
Ext. E	1799	120	6		1						1		74
Ext. E	1851		1				1						
Ext.	1878	3	2										11

E													
Ext. E	1883	14	5										2
Ext. E	1884	10											5
Ext. E	--	1											
Ext. N	1785	11											8
Ext. N	1825	19	1			1							7
Ext. S	1394	3	1			1							
Ext. S	1507	2											
Ext. S	1692	5											
Ext. S	1797	5											
Ext. S	1828	3											
Ext. S	1852	5	1										2
Ext. S	1967	9											
Ext. S	1968	1											
Ext. S	1974	1											
Ext. S	1978	2											
Ext. S	1980	3											
Ext. W	1725	14	3										2
Ext. W	1744	22			1								2
Ext. W	1756	15						1					1
Ext. W	1774	5			1								5
Ext. W	1781	10											1
Ext. W	1947	5											
Ext. W	1948	1											
Ext. W	1952	6											
Ext. W	1953	1											
Ext. W	1964	9	1										
F	1405	10											12
F	1611	2											3
F	1691	9	1	1							1		1
F	1704	5											8
F	1711	63		1									27
F	1772	12	1					1					
F	1833	2											
F	1905	16	1	1									7
F	1906	2											
F	1909	15											
F	2569	1											
F	US inf	7											5
G	1664	2											1
G	1675	38				1	1						8
G	1676	19					1	1					13

UF, general inventory

UF n°	Building	Room	Related Structure	Under	Over	INTERPRÉTATION
302	B19				303	destruction
303	B19	out qibla wall		302		destruction
307	B19	qibla wall				destruction
310	B19		out qibla wall	307	br	destruction
2502	B19	SD 2			br	collapse
2503	B19	SD 1			br	backfill
2504	B19		M001		M001	collapse
2505	B19		M001			collapse
304	B21	B		surf	306	collapse
305	B21	ext south-west		surf		destruction
306	B21	sound 21B1		304	309	destruction
308	B21	south wall				destruction
309	B21	B C		surf		destruction
312	B21	H				destruction
313	B21	B		309	328	collapse
314	B21	E				collapse
317	▶B21	B		309	313	occupation
318	▶B21	A				collapse
323	B21	C		309		collapse
329	▶B21	D				collapse
328	B21	B		317/309		
336	B21	B		313		occupation
337	B21	B		336		construction
345	B21	E			402	destruction
348	▶B21	B				
400	B21	B		336		occupation
349	B21	B		348-336		floor
401	B21	B		348	337	construction
403	B21	B		336/348/349	337	construction
404	B21	sound ext west		surf	405	abandonment
405	B21	sound ext west		404	406	abandonment
406	B21	sound ext west		405	407	abandonment
407	B21	sound ext west		406	408	occupation
408	B21	sound ext west		407	430	occupation
402	B21	E		345	412	collapse
344	B21	D		329	337	collapse
412	B21	E		402	419	collapse
429	B21	ext west				collapse
422	B21	ext north				abandonment
430	B21	exterior west		408		construction
419	B21	E		412	420	collapse
420	B21	E		419	421	floor
421	B21	E		420	435	floor
431	B21	E	fireplace a	420		pit

435	B21	E		421		floor
439	B21	F				
441	B21	E	fireplace b			fire place
442	B21	E	fireplace c			fire place
443	B21	E	fireplace d			fire place
444	B21	E	fireplace e			cooking pit
449	B21	E		421	455	backfill
440	B21	G			456/454	destruction
454	B21	G	fireplace a			fire place
455	B21	E		449	bedrock	backfill
456	B21	G		440		occupation
457	B21	F		457		occupation
458	B21	H				collapse
445	B21	F		439	457	floor
446	B21	J				
462	B21	H				collapse
469	B21		ext west- 21J int			collapse
447	B21	H				collapse
448	B21		ext west			collapse
463	B21	H C D	wall			construction
480	B21	A		318	481	abandonment
481	B21	A		480	bedrock	construction
495	B21	H				abandonment
496	B21	H		701		occupation
497	B21	H		702	bedrock	floor
498	B21	H				construction
499	B21	H				occupation
500	B21	H		705	bedrock	floor
503	B21	H	bassin a	499	504	construction
504	B21	H	bassin a	503	505	occupation
505	B21	H	bassin a	504	506	occupation
506	B21	H	bassin a	503-5	bedrock 337	construction
507	B21	A	seuil	336		construction
2071	B21	E Y		2010	2073 / 2074	floor
2073	B21	Y		2071	2079	floor
2074	B21	E		2071	2078	floor
2078	B21	E		2074	2082	floor
2079	B21	Y		2078	2083	floor
2083	B21	Y		2079	Bedrock	construction
2094	B21	E		2085	bedrock	floor
2116	B21	E		2085	bedrock	construction
2082	B21	E		2078	2085	construction
2017	B21	N			2061/2064	collapse
2046	B21	N		2050	2041 ?	?
2024	B21	N		2060	2041	backfill ?

2017	B21	N			2061/2064	collapse
2046	B21	N		2050	2041 ?	?
2024	B21	N		2060	2041	▶backfill ?
2047	B21	N		2048	2046	▶?
2048	B21	N		2049	2047	?
2049	B21	N		2051	2048	?
2050	B21	N		2051	2046	backfill
2051	B21	N		2052	2050	▶?
2052	B21	N		2053	2051	collapse
2053	B21	N		2054	2052	?
2054	B21	N		2055	2053	?
2055	B21	N		2056	2054	?
2056	B21	N		2057	2055	?
2057	B21	N		2058	2056	?
2058	B21	N		2059	2057	?
2059	B21	N			2058	?
2060	B21	N		2061	2024	?
2061	B21	N		2017	2060	destruction ?
2062	B21	N		2017	2060	?
2063	B21	N		2064	2024	?
2064	B21	N		2017	2063	?
2012	B21	H			2081	collapse
2081	B21	H		2012	2032	destruction ?
2032	B21	H		2081	2086	backfill
2086	B21	H		2032	2069	floor
2069	B21	H		▶2086	BR	backfill
2098	B21	H		2068	br	construction
2068	B21	H		2012 ?	2098	occupation ?
2040	B21	N			2048	▶collapse
2147	B21	N		2040	2041	backfill
2148	B21	N		2040	2041	collapse
2041	B21	N		2047	▶sol	backfill
2043	B21	N		2024	br ?	backfill
2013	B21	C			2029	collapse
2029	B21	C		2013	2087	destruction
2087	B21	C		2029	2035	floor
2035	B21	C		2087	2088	backfill
2088	B21	C		2035	2089	floor
2089	B21	C		2088	br	backfill
2090	B21	C			br	backfill
2091	B21	C		2087	2088	backfill
2092	B21	C		2093	br	construction
2031	B21	M		2026	2113	▶collapse
2113	B21	M		2031	2067	occupation
2067	B21	M		2113	▶2096	▶floor

2096	B21	M		2067	2097	backfill
2130	B21	M	47	2131	2097	construction
2131	B21	M	47	2067	2130	occupation ?
2132	B21	M	48	2133	2097	construction
2133	B21	M	48	2097	2132	occupation
2080	B21	M		2067	br	backfill
2136	B21	M		2031	br	backfill ?
2135	B21	M		2031	2097	backfill
2134	B21	M		2031	2097	construction
2104	B21	M		2031		destruction ?
2103	B21	M	44	2096	2096	backfill
2115	B21	M		2031	2067	destruction
2114	B21	M		2067	2097	backfill
2097	B21	M		2096	br	floor
2139	B21	M		2134 ?	2097	occupation
2023	B21	U		2006	2023	floor ?
2025	B21	U		2023	2044	backfill
2044	B21	U		2025	br	floor
2159	B21	Seuil p�diluve		2164	2165	floor
2164	B21	Seuil p�diluve			2159	floor
2165	B21	Seuil p�diluve		2159	2168	construction
2168	B21	Seuil p�diluve		2171	bedrock	floor
2171	B21	Seuil p�diluve		2159	2168	construction
2173	B21	Z		2128	2184	occupation
2105	B21	V		2100	2106	floor
2106	B21	V		2105	2107	construction
2107	B21	V		2106	2108	floor
2108	B21	V		2110		construction
2110	B21	V		2107	2108	floor
2120	B21	Z		2101	2122	floor
2121	B21	Z		2101	2122	occupation
2122	B21	Z		2120	2128	floor
2128	B21	Z		2122		floor
2217	B21	Z		2184	2219	construction
2219	B21	Z		2217	Bedrock	floor
2233	B21	Z		2128	2184	construction
2196	B21	Z		2128	2233	occupation
2188	B21	Z		2128	2184	construction
2189	B21	Z		2128	2188	occupation
2000	B21	K			2065	collapse
2001	B21	F			2137	collapse
2002	B21	E			2007	collapse
2003	B21	M			2016	collapse
2004	B21	M			2015	collapse
2005	B21	Q				collapse

2006	B21	N			2017 2023	collapse
2007	B21	E		2002	2010	collapse
2008	B21	O				collapse
2009	B21	L			2172	collapse
2010	B21	E		2007	2038	collapse
2014	B21	I			2117	collapse
2016	B21	P		2003	2020	collapse
2018	B21	Q		2003		collapse
2019	B21	D			2042	collapse
2020	B21	P		2016	2076	
2021	B21	SS			2229	collapse
2022	B21	P		2157	bedrock	
2027	B21	A			2163	
2034	B21	G		2011	2037	collapse
2030	B21	V		2015	2100	collapse
2033	B21	W		2028		collapse
2036	B21	X		2000	2099	collapse
2037	B21	G		2034	2075	collapse
2045	B21	A			2163	collapse
2065	B21	K		2000	2072	collapse
2066	B21	B			2123	collapse
2070	B21	SE			2183	collapse
2075	B21	G		2037	BR	
2084	B21	P		2076	2157	
2250	B21	Z		2122	2128	construction
2153	B21	Z		2128	2154	occupation
2154	B21	Z		2153	2217	floor
2095	B21	T			2109	collapse
2101	B21	Z			2120	collapse
2111	B21	K		2065	2172	collapse
2112	B21	SN				
2117	B21	I		2014	2142	collapse
2118	B21	T		2109	2119	collapse
2119	B21	T		2118	2126	occupation
2123	B21	B		2066	BR	occupation
2124	B21	B		2066	BR	occupation
2125	B21	B		2066	BR	backfill
2137	B21	F		2001	2141	collapse
2138	B21	SW				
2141	B21	F		2137	2214	occupation
2142	B21	I		2117	2155	occupation
2143	B21	SS			2156	collapse
2151	B21	R				collapse
2152	B21	J			2170	collapse
2155	B21	I		2142	2190	occupation

2156	B21	I		2143		occupation
2163	B21	A		2045	BR	occupation
2166	B21	L		2009	2172	
2169	B21	I		2142	2155	occupation
2170	B21	J		2152	2187	collapse
2183	B21	SE		2070		collapse
2187	B21	J		2152		collapse
2192	B21	J		2170		collapse
2038	B21	Y		2010	2071	abandonment
2039	B21	Y		2010	2071	abandonment
2129	B21	Y		2083	Bedrock	construction
2270	B21	K				
2102	B21	K		2178	2180 2179 2205	backfill
2140	B21	K		2000 2065 20	2102	
2145	B21	K				destruction
2146	B21	K			2185	backfill
2161	B21	K				backfill
2162	B21	K			2179	backfill
2167	B21	K			2179	backfill
2178	B21	K		2072	2201 2204 2102	floor
2179	B21	K		2102 2205	2180	floor
2180	B21	K		2203 2204 2	BR 2181	backfill
2181	B21	K		2180	BR	backfill
2185	B21	K		2146 2231	2180 2253	floor
2186	B21	K				backfill
2200	B21	K				
2201	B21	K		2178	2202	occupation
2202	B21	K		2201	2203	backfill
2203	B21	K		2202 2204	2180	backfill
2204	B21	K		2178	2102 2203 2180	backfill
2205	B21	K		2102	2179	occupation
2206	B21	K		2178	2180	occupation
2221	B21	K			2180	abandonment
2220	B21	K				abandonment
2222	B21	K				
2230	B21	K		2232	2146?	floor
2231	B21	K			2254	backfill
2232	B21	K			2254	backfill
2235	B21	K				occupation
2236	B21	K				occupation
2237	B21	K				occupation
2238	B21	K				occupation
2239	B21	K				occupation
2240	B21	K				occupation
2241	B21	K				occupation

2242	B21	K				occupation
2253	B21	K		2185	2258	backfill
2254	B21	K				
2258	B21	K		2253		
2259	B21	K				
2260	B21	K				abandonment
2261	B21	K				
2263	B21	K				
2265	B21	K				
2267	B21	K				
2269	B21	K				
2262	B21	K				abandonment
2264	B21	K				abandonment
2266	B21	K				abandonment
2268	B21	K				abandonment
2271	B21	K				abandonment
2149	B21	M	45	2150	br	construction
2150	B21	M	45	2104	2149	
2246	B21	M	117	2245	2097	construction
2245	B21	M	117	2174	2246	backfill
2085	B21	E		2082	2094	floor
2093	B21	C		2013	2092	backfill
2184	B21	Z		2173		occupation
1998	B9	I		1999	1997	backfill
1409	B94	A		1400	1411	destruction
1411	B94	A		1409	1414	destruction
1414	B94	A		1411	1419	abandonment
1419	B94	A		1414	1428	abandonment
1428	B94	A		1419		construction
1427	B94	A	B94-029	1414		construction
1429	B94	A	B94-029	1414		
1448	B94	Ext W Piece J		1400	Bedrock	abandonment
1430	B94	J		1448	1447	abandonment
1447	B94	J		1448	-	construction
1449	B94	K		1450 1442	Bedrock	abandonment
1450	B94	K		1442	1449	construction
1486	B94	B		1498	1490	occupation
1407	B94	C			1413	collapse
1413	B94	C		1407	1415	collapse
1415	B94	C		1413	1420	collapse
1420	B94	C		1415	1424	collapse
1423	B94	C				
1424	B94	C		1420	1425	abandonment
1425	B94	C		1424	1426	abandonment
1426	B94	C		1425	1437	floor

1437	B94	C		1426	1444	backfill
1439	B94	D		1400	1461	collapse
1444	B94	C		1437		backfill
1461	B94	D		1439	1468	collapse
1467	B94	D		1461		abandonment
1468	B94	D		1467	1469	abandonment
1487	B94	H		1400	1502	abandonment
1490	B94	B		1486	1491 Bedrock	abandonment
1491	B94	B		1486 1490	bedrock	construction
1494	B94	H L		1502	bedrock ?	construction
1495	B94					
1498	B94	B		1499	1490	occupation
1499	B94	B		1400	1498	collapse
1500	B94	H extension				construction
1501	B94	B	044	1416	ST B94-044	abandonment
1502	B94	H		1487	1494	abandonment
1440	B94	J		1400	1430	collapse
1469	B94	D		1485;1461		occupation
1474	B94	D		1461	1477	occupation
1477	B94	D		1474, B94-044	1479	floor
1479	B94	D		1477	1481 ; bedrock	construction
1481	B94	D		1479	1484	occupation
1483	B94	D		1479	BEDROCK	occupation
1484	B94	D		1481	BEDROCK	backfill
1485	B94	D		1468	1474	construction
1493	B94	A		1419	B94-034	backfill
1496	B94	A		1419	B12-034	backfill
1497	B94	A		1414?	1419?	construction
1503	B94	I		1516	1504	occupation
1504	B94	I		1503		occupation
1505	B94	I		1503		
1509	B94	I		1503	BEDROCK	backfill
1510	B94	I		1503	BEDROCK	backfill
1515	B94	EXT		1400		abandonment
1516	B94	I		1408	1503	occupation
1517	B94	B		1499	1518	occupation
1522	B94	B		1518/1525	1523	occupation
1523	B94	B		1522/1525	1524	occupation
1524	B94	B		1523/1525	BEDROCK ?	construction
1525	B94	B			1518	backfill
1518	B94	B		1517	1522	floor
1453	B94	D		1400 (surface	1457	collapse
1457	B94	D		1453	1460	
1460	B94	D		1457	1462	collapse
1462	B94	D		1460	1463	floor

1463	B94	D		1462	1470 ; bedrock	construction
1470	B94	D		1463	Bedrock	construction
1476	B94	D		1463	1478	construction
1478	B94	D		1476	Bedrock	construction
1480	B94	D		1463	st 043	construction
1506	B94	H		1400 (surface)	1513	collapse
1507	B94	extérieur sud		1400	1520	collapse
1508	B94	H		1513	1432	construction
1511	B94	H				
1513	B94	H		1506	1508	floor
1519	B94	H		1473	B94-046 (seuil)	
1520	B94	extérieur sud		1507	1521	floor
1521	B94	extérieur sud		1520	1526	
1401	B94	I		1400	1402	collapse
1402	B94	I		1401		occupation
1403	B94	F		1400	1404	destruction
1404	B94	F		1403	1405	floor
1405	B94	F		1404	b94-001	
1406	B94	I		1402		occupation
1408	B94	I		1400	1456	destruction
1410	B94	B		1400	1416	collapse
1412	B94	P				
1416	B94	B		1410		occupation
1417	B94	H		1400	1418	collapse
1418	B94	H		1417		
1421	B94	SE		1436		construction
1422	B94	P		1412		destruction
1431	B94	K		1400	1441	collapse
1432	B94	H		1418;1508		floor
1434	B94	M		1400		destruction
1435	b94	SE		1400	1436	floor
1436	B94	SE		1435		occupation
1438	B94	L		1400	1475	
1441	B94	K		1431	1442	destruction
1442	B94	K		1441;1446	1450;1449	abandonment
1443	B94			1434	1451	destruction
1445	B94	I		1406	Bedrock	
1446	B94	K		1441	1442	backfill
1451	B94	M		1443	1455	occupation
1452	B94	G		1400	1459	
1454	B94	L		1400	1475	destruction
1455	B94	M		1451	1492	floor
1456	B94	I		1408		occupation
1458	B94	I				
1459	B94	P		1452	1464	destruction

1464	B94	P		1459		
1465	B94	G		1400	1466	
1466	B94	G		1465		
1471	B94	M				
1473	B94	L H		1400		destruction
1475	B94	L		1454		
1512	B94	B		1490		construction
1400	B94					
1472	B94	Ext N/E				
1482	B94	P		1400		
1488	B94	A		1411	1414	
1489	B94	M		1443		
1492	B94	M				
1514	B94					
1526	B94	EXT SUD		1521		
1664	B94	G				collapse
1665	B94	Q			024	collapse
1654	B94	D		1655		construction
1655	B94	D		1657		construction
1656	B94	D	123	1965	1657; st 40	occupation
1657	B94	D		1965; 1656; 2	1655; 1654; bedro	floor
1658	B94	D	100	1659; 1660; 1	2614; 2619	occupation
1659	B94	D	103	1660; 1661	1658	occupation
1660	B94	D		1662	1661; 1658; 1659	occupation
1661	B94	D	103	1662; 1660	1659	occupation
1662	B94	D		1663	1660	collapse
1663	B94	D			1662; 1669; 1683; 1	collapse
1667	B94	P			1668	collapse
1668	B94	P		1667	1734 1735 ST65	collapse
1669	B94	D	50	1663		abandonment
1678	B94	D				collapse
1675	B94	G		1667	1676	collapse
1676	B94	G		1675	1679 M051	collapse
1679	B94	G		1676		collapse
1683	B94	D		1663		construction
1684	B94	D		1663	1685	destruction
1685	B94	D		1684	1660	destruction
1686	B94	D			1969	destruction
1687	B94	D			1969	destruction
1688	B94	D				
1693	B94	G			1694 1695	collapse
1694	B94	G		1693	1695	collapse
1695	B94	G		1693 1694	1696 1697 M036	collapse
1696	B94	G		1695	1697	occupation
1697	B94	G		1695 1696	1699 1698 1703	occupation

1464	B94	P		1459		
1465	B94	G		1400	1466	
1466	B94	G		1465		
1471	B94	M				
1473	B94	L H		1400		destruction
1475	B94	L		1454		
1512	B94	B		1490		construction
1400	B94					
1472	B94	Ext N/E				
1482	B94	P		1400		
1488	B94	A		1411	1414	
1489	B94	M		1443		
1492	B94	M				
1514	B94					
1526	B94	EXT SUD		1521		
1664	B94	G				collapse
1665	B94	Q			024	collapse
1654	B94	D		1655		construction
1655	B94	D		1657		construction
1656	B94	D	123	1965	1657; st 40	occupation
1657	B94	D		1965; 1656; 2	1655; 1654; bedrock	floor
1658	B94	D	100	1659; 1660; 1	2614; 2619	occupation
1659	B94	D	103	1660; 1661	1658	occupation
1660	B94	D		1662	1661; 1658; 1659	occupation
1661	B94	D	103	1662; 1660	1659	occupation
1662	B94	D		1663	1660	collapse
1663	B94	D			1662; 1669; 1683; 1	collapse
1667	B94	P			1668	collapse
1668	B94	P		1667	1734 1735 ST65	collapse
1669	B94	D	50	1663		abandonment
1678	B94	D				collapse
1675	B94	G		1667	1676	collapse
1676	B94	G		1675	1679 M051	collapse
1679	B94	G		1676		collapse
1683	B94	D		1663		construction
1684	B94	D		1663	1685	destruction
1685	B94	D		1684	1660	destruction
1686	B94	D			1969	destruction
1687	B94	D			1969	destruction
1688	B94	D				
1693	B94	G			1694 1695	collapse
1694	B94	G		1693	1695	collapse
1695	B94	G		1693 1694	1696 1697 M036	collapse
1696	B94	G		1695	1697	occupation
1697	B94	G		1695 1696	1699 1698 1703	occupation

1698	B94	G		1697	1699 1701 1702 1703	collapse
1699	B94	G		1697 1968?	1701	collapse
1700	B94	G		1703 1698?		collapse
1701	B94	G		1699	1702	collapse
1702	B94	G		1698 1701		collapse
1703	B94	G		1697	1700	
1651	B94	B			1652	collapse
1652	B94	B		1651	1653	destruction
1653	B94	B		1681	ST 044	abandonment
1681	B94	B		1652	1653	abandonment
1706	B94	B		1653		abandonment
1707	B94	B		1653	Bedrock	construction
1710	B94	B		1681	Bedrock	construction
1670	B94	R			1673	collapse
1673	B94	R		1670	1677	collapse
1677	B94	R		1673	1682	destruction
1682	B94	R		1677	1690	abandonment
1690	B94	R		1682	1722	abandonment
1692	B94	Ext_Sud			1718	collapse
1718	B94	Ext_Sud		1692		collapse
1674	B94	Q		1665	1705	collapse
1705	B94	Q		1674		destruction
1725	B94	Ext_W			1744	collapse
1726	B94	Q		1705	1740	collapse
1739	B94	Ext_E				collapse
1740	B94	Q		1726	1767	abandonment
1743	B94	Ext_S		1718	ST ?	
1744	B94	Ext_W		1725		occupation
1767	B94	Q		1740	1771	abandonment
1720	B94	R		1722	1723	construction
1722	B94	R		1690	1720	occupation
1723	B94	R		1720	bedrock	construction
1745	B94	R		ST 07	1720	backfill
1771	B94	Q		1767	1791	occupation
1800	B94	Q	91	1771	1791	abandonment
1891	B94	Q	91	1771	1791	construction
1888	B94	Q	88	1771		construction
1788	B94	Q	88	1771		abandonment
1787	B94	Q	87	1771	1791	abandonment
1887	B94	Q	87	1771	1791	construction
1790	B94	Q	90	1767	1830	occupation
1791	B94	Q		1771	1792	construction
1792	B94	Q		1791	1830	construction
1805	B94	Q		1830	1831	construction
1824	B94	Q		1740	1891	collapse

1830	B94	Q		1795	1805	occupation
1831	B94	Q		1805	1835	construction
1650	B94	I			1666/1680/1689/	collapse
1666	B94	I		1650	1671	collapse
1680	B94	I		1650/1689	1671	collapse
1689	B94	I		1650/1666	1680/1671	collapse
1671	B94	I		1666	1672	occupation
1672	B94	I		1671	1736	floor
1737	B94	I			1736	?
1736	B94	I		1672		floor
1708	B94	I		1671	1672	occupation
1719	B94	I		1671	1736	occupation
1751	B94	I	60	1719	1736	occupation
1715	B94	I	61	1671	1736	occupation
1716	B94	I	61	1715	1736	occupation
1717	B94	I	58	1671	1736	occupation
1729	B94	I	62	1672	1747	occupation
1747	B94	I	62	1729	1736	occupation
1730	B94	I	62	1672	1748	occupation
1748	B94	I	62	1672	1749	occupation
1733	B94	I	64	1672	1736	occupation
1732	B94	I	64	1672	1736	occupation
1727	B94	I	59	1672	1752	occupation
1709	B94	G		1700 1702	1757 1758	collapse
1713	B94	G		1757 1709 17	1759 1760 1761 17	occupation
1714	B94	G		1713 1760	1762	collapse
1746	B94	G		1713		
1757	B94	G		1709	1713	collapse
1758	B94	G		1709 1714	1713	collapse
1759	B94	G		1713	1760	occupation
1760	B94	G		1759 1713	1714 1762 1761 17	construction
1761	B94	G		1713 1760	1764 1765	occupation
1762	B94	G		1714 1760	1763	occupation
1763	B94	G		1760 1762	1764	occupation
1764	B94	G		1760 1761 17	1892 1772	occupation
1765	B94	G		1761	1764 1766	occupation
1772	B94	G		1764 1892	1892 1893 1780	construction
1780	B94	G		1772 1893 18	1786	floor
1786	B94	G		1780 MR036	1795	construction
1794	B94	G		1764 1780	1786	occupation
1795	B94	G		1786 MR019	BR	
1892	B94	G		1764	1772	occupation
1893	B94	G		1772	1780	occupation
1894	B94	G		1780 MR065	1786	occupation
1895	B94	G		1764	1786 1794	construction

1752	B94	I	59	1727	1736	occupation
1728	B94	I	59	1672	1736	occupation
1731	B94	I	63	1672	1736	occupation
1822	B94	I	63	1672	1736	construction
1821	B94	I	62	1672	1736	construction
1823	B94	I	58	1672	1736	construction
1806	B94	I	67	1749	1736	construction
1749	B94	I	67	1748	1806	abandonment
1807	B94	I	68	1750		construction
1750	B94	I	68		1807	abandonment
1808	B94	I	70	1777		construction
1777	B94	I	70		1808	abandonment
1809	B94	I	72	1778		construction
1778	B94	I	72		1809	abandonment
1810	B94	I	73	1782		construction
1782	B94	I	73		1810	abandonment
1783	B94	I	74		1811	abandonment
1734	B94	P		1668		collapse
1735	B94	P	065	1668	1741	collapse
1741	B94	P	065	1735		abandonment
1742	B94	P	066	1735		occupation
1834	B94	P			1879	
1879	B94	P		1834	1928 1926 1922 19	collapse
1898	B94	P		1879	1921	backfill
1899	B94	P		1931	1932	backfill
1907	B94	P		1922	1923 1925 1926	backfill
1912	B94	P		1930 1928		occupation
1913	B94	P		1924		occupation
1914	B94	P				
1921	B94	P		1898	1922	backfill
1922	B94	P		1921	1907 1926	backfill
1923	B94	P		1907 MR112*	1924	backfill
1924	B94	P		1923	1913	occupation
1925	B94	P		1907 1926	MR113	construction
1926	B94	P		1879 1907 19	1925 1927	occupation
1927	B94	P		1926	1929	occupation
1928	B94	P		1879	1930	
1929	B94	P		1927	1930	backfill
1930	B94	P		1928 1929	1912	backfill
1931	B94	P		1879	1899	collapse
1932	B94	P		1899	1914	backfill
1813	B94	I	86	1814		construction
1814	B94	I	86		1813	abandonment
1812	B94	I	75	1784		construction
1846	B94	I	75	1784	BR	construction

1784	B94	I	75		1812	abandonment
1793	B94	I				abandonment
1840	B94	I	94	1841		construction
1841	B94	I	94	1842	1840	abandonment
1842	B94	I	94			abandonment
1843	B94	I	95	1844		construction
1844	B94	I	95		1843	abandonment
1848	B94	I	96	1849		construction
1769	B94	I		1736	1816/1770	construction
1816	B94	I		1769	1815	backfill
1815	B94	I		1816	BR	backfill
1770	B94	I		1769	BR	backfill
1819	B94	I			1817	floor
1817	B94	I		1819	BR	backfill
1849	B94	I	96		1848	abandonment
1938	B94	Ext W		1774	1961	construction
1947	B94	Ext. W		1960	1774	occupation
1948	B94	Ext. W		1951	1952	construction
1950	B94	Ext. W				occupation
1951	B94	Ext. W		1964	1948	construction
1953	B94	Ext.W		1774		backfill
1952	B94	Ext. W		1948	Bedrock	construction
1964	B94	Ext. W		1961	1951	construction
1961	B94	Ext. W		1938	1964	construction
1774	B94	Ext.W			1938	construction
1960	B94	Ext. W		ST071	MR 07	construction
1959	B94	Ext. S		1960	1947	construction
1967	B94	Ext Sud			1968	floor
1968	B94	Ext.Sud		1967	1971	construction
1971	B94	Ext. Sud		1968	1978	occupation
1978	B94	Ext. Sud		1971	bedrock	construction
1979	B94	Ext. Sud		2574	2582 2583	occupation
1980	B94	Ext Sud		2582 2583	1981	floor
2583	B94	Ext. Sud		1979	1980	occupation
2576	B94	Ext. Sud		2574	1979	construction
2577	B94	Ext. Sud		2574	1979	construction
2584	B94	Ext. Sud		1979	2583	occupation
1861	B94	I	105	1862		construction
1862	B94	I	105	1988	1861	backfill
1863	B94	I	105	1864		construction
1864	B94	I	105	1988	1863	backfill
1865	B94	I	105	1866		construction
1866	B94	I	105		1865	backfill
1867	B94	I	105	1868		construction
1868	B94	I	105		1867	backfill

1869	B94	I		1870		construction
1870	B94	I			1869	abandonment
1875	B94	I		1876	BR	Dépression BR ?
1876	B94	I		1986	1875	backfill
1933	B94	I		1983	BR	backfill
1983	B94	I		1984	1933	?
1984	B94	I		1989	1983	backfill
1985	B94	I		TP SD 1	BR	backfill
1987	B94	I		1988	BR	backfill
1986	B94	I		1988	BR	backfill
1988	B94	I			1986/1987	occupation
1989	B94	I			1984/1988	occupation
1936	B94	I		1990	BR	construction
1990	B94	I		1991	1936	backfill
1991	B94	I		1992	1990	backfill
1992	B94	I		M_013	1991	backfill
1993	B94	I		1770	BR	backfill
1994	B94	I		m_013	1770	occupation
1995	B94	I	93	1996		construction
1996	B94	I	93	M_013	1995	abandonment
1997	B94	I		1998	BR	backfill
1999	B94	I		M_013	1998	backfill
1882	B94	I		seuil	br	backfill
2555	B94	I		seuil	br	?
2556	B94	I		2558	br	occupation ?
2557	B94	I		2558	br	backfill
2558	B94	I		2561	1882/2556/2557	floor ?
2565	B94	I		2559	br	construction
2559	B94	I		1949	BR	backfill
1949	B94	I		2560	2559	backfill
2560	B94	I		2561	1949	backfill
2561	B94	I		2562	2558/2560	backfill ?
2562	B94	I		M_026	2558/2561	floor
1981	B94	Ext. Sud		1980	2572	floor
2572	B94	Ext. Sud		1981		floor
1721	B94	C		1407	1738	collapse
1738	B94	C		1721	1738	collapse
1753	B94	C		1721	1754	collapse
1754	B94	C		1753	1768	abandonment
1755	B94	C	69	1753		abandonment
1837	B94	C	69	1755	1838	occupation
1838	B94	C	69	1837		occupation
2563	B94	C	69			occupation
1768	B94	C		1754	1839	floor
1798	B94	C	82	1754	1768	occupation

1801	B94	C	80	1754		abandonment
1942	B94	C	80			occupation
1802	B94	C	79	1754		occupation
1829	B94	C	79	1802		occupation
1943	B94	C	79			occupation
1803	B94	C	92	1829	1768	abandonment
1944	B94	C	92	1803		occupation
1945	B94	C	92	1829		occupation
1804	B94	C	81	1754		abandonment
1946	B94	C	81			occupation
1839	B94	C		1768		floor
1900	B94	C	108	1768	1901	occupation
1901	B94	C	108	1900		occupation
1966	B94	C	108			occupation
1977	B94	D	123	1656		occupation
2564	B94	D	123			occupation
2566	B94	D	103			occupation
1724	B94	D		1685; 1683	1965	occupation
1919	B94	D	76	1683		abandonment
1920	B94	D	76			occupation
1935	B94	D	77	1685		occupation
1939	B94	D	77	1935		occupation
2567	B94	D	77			occupation
1940	B94	D	99	1685	1724	occupation
1941	B94	D	104	1683		occupation
2568	B94	D	104			occupation
1958	B94	D	119	1685	1957	abandonment
1957	B94	D	119	1958		abandonment
1956	B94	D	119			occupation
1963	B94	D	120	1724		abandonment
1962	B94	D	120			occupation
1970	B94	D	121	1969		abandonment
2677	B94	D	121			occupation
1972	B94	D	122	1969		abandonment
1973	B94	D	122			occupation
1976	B94	D		1724	1965	occupation
2579	B94	D		1969	1982	occupation
2588	B94	D	130	2581		occupation
2581	B94	D	130	1982	2582	occupation
2580	B94	D	130			occupation
2589	B94	D	132			occupation
2590	B94	D	132	1982		abandonment
2602	B94	D	138	2570		abandonment
2601	B94	D	138			occupation
2606	B94	D		1685	1724	occupation

2607	B94	D		ST 50; 1965	1657	occupation
1965	B94	D		1724	2607; 2610	floor
2608	B94	D		1724	1965	occupation
2609	B94	D		1965	2610	occupation
2610	B94	D		1965; 2609	1657; 2619	occupation
2611	B94	D		1724; 1685	1658; 2612	occupation
2612	B94	D		2611; 1724	2613	occupation
2613	B94	D		2612	2619	occupation
2614	B94	D		1658	2615;	occupation
1969	B94	D		1687; 1686	2616; 1982; 1658	occupation
2615	B94	D	140	2616; 2614	2623; 2633; 2619	backfill
2675	B94	D	140	2603		construction
2638	B94	D	140	ST 140	2633	construction
2623	B94	D	140	ST 140; 2615	1654	floor
2624	B94	D	140			occupation
2616	B94	D		1969	1982; 2604; 2615;	floor
1982	B94	D		2616; 1962	2615; 2604; 2570	floor
2617	B94	D		1982	2604	occupation
2618	B94	D		2604	2603	occupation
2570	B94	D		2604; 1982;	2603; 2620; 2619	floor
2619	B94	D		2570; 2610;	2594; 2633; 1657	floor
2620	B94	D		2570	2605	backfill
2605	B94	D		2570; 2620		backfill
2603	B94	D		2570; 2618		backfill
2594	B94	D		2619; 2605		floor
2626	B94	D	143	1965		abandonment
2625	B94	D	143			occupation
2628	B94	D	141	2610		abandonment
2627	B94	D	141			occupation
2630	B94	D	142	1657		abandonment
2629	B94	D	142			occupation
2632	B94	D	145	1657		abandonment
2631	B94	D	145			occupation
2633	B94	D		2619	bedrock	backfill
2634	B94	D	149			occupation
2635	B94	D	149	1657		abandonment
2637	B94	D	148	1657		abandonment
2636	B94	D	148			occupation
2640	B94	D	150	1657		abandonment
2639	B94	D	150			occupation
2642	B94	D	151	2647	2648	abandonment
2641	B94	D	151			occupation
2644	B94	D	152	2647		abandonment
2643	B94	D	152			occupation
2645	B94	D	153			occupation

2646	B94	D	153	2650		abandonment
2647	B94	D		1657	2648	occupation
2648	B94	D		2647	bedrock	backfill
2649	B94	D		2607		occupation
2650	B94	D		2607	2651; 2652	floor
2651	B94	D		2652; 2650	bedrock	occupation
2652	B94	D		2650; St 50	2651	occupation
2674	B94	D	83			construction
2678	B94	D	100			occupation
2679	B94	D		1657	bedrock	occupation
1691	B94	F		1400		collapse
1704	B94	F			1902	destruction
1711	B94	F		1404	1405	backfill
1712	B94	F	57	1404	1405	construction
1833	B94	F	109	1400	1934	collapse
1934	B94	F		1833		construction
2657	B94	F	109			construction
2569	B94	F		1691	2571	occupation
2571	B94	F		2569	2578	floor
2578	B94	F		2571	Bedrock	floor
1915	B94	F		2653	bedrock	floor
2653	B94	F		1909; mur 0	1915	occupation
1909	B94	F		1906	2653	backfill
1906	B94	F		2654	1909; seuil 155	occupation
2654	B94	F		seuil 57; 190	1906	occupation
1905	B94	F		2655	2654	backfill
2655	B94	F		2656	1905	occupation
2656	B94	F		1902	2655	occupation
1902	B94	F		1704	2656	occupation
2660	B94	F	128	2569		abandonment
2659	B94	F	128	2569		construction
2658	B94	F	128			occupation
2663	B94	F	129	2569		abandonment
2662	B94	F	129	2569		construction
2661	B94	F	129			occupation
2664	B94	F	156	2673	2569; ST 157	renovation
2665	B94	F	109			abandonment
2666	B94	F	109			abandonment
2667	B94	F	109			abandonment
2668	B94	F	109			abandonment
2669	B94	F	109			abandonment
2670	B94	F	109			abandonment
2671	B94	F		2673	2672; ST 157	occupation
2672	B94	EXT E		2671	2676	
2673	B94	F			2671; 2664; ST 156	collapse

2676	B94	EXT E		2672		floor
1835	B94	Q		1831	1836 Bedrock	construction
1836	B94	Q		1835	BEDROCK	construction
2574	B94	Ext. Sud			1979	floor
1974	B94	Ext. Sud				
2595	B94	P		1932	2622 2598	occupation
2597	B94	P		1912	2586	occupation
2573	B94	P		1879	2587	backfill
2586	B94	P		1912	BR	backfill
2587	B94	P		2573		collapse
2591	B94	P		1930	1912	backfill
2592	B94	P		1913	BR	backfill
2593	B94	P				
2596	B94	P		1914	MR 135	occupation
2598	B94	P		1932 1914 2598	BR?	construction
2622	B94	P		2595	2598	occupation
1799	B94	Ext E		1779 2553	1883 2552	occupation
1883	B94	Ext E				
1884	B94	Ext E		1883	2550	occupation
2550	B94	Ext E		1884 2552	BR	construction
2551	B94	Ext E				occupation
2552	B94	Ext E		1799 2553	2550	occupation
2553	B94	Ext E		1779 2554	1799 2552	occupation
2554	B94	Ext E				
2600	B94	Ext E		2621	BR?	occupation
2621	B94	Ext E		2550	2600	destruction
2585	B94	Ext E		1878		occupation
2575	B94	Ext E		1878		occupation
1878	B94	Ext E			2575 2585	collapse
1851	B94	Ext E				collapse
1779	B94	Ext E		1739	1799 2553 2554	collapse
2582	B94	Ext. Sud		1979	2583	construction