



HAL
open science

Bare NPs and deficient DPs in Haitian and French: from morphosyntax to reference construal

Anne Zribi-Hertz, Herby Glaude

► **To cite this version:**

Anne Zribi-Hertz, Herby Glaude. Bare NPs and deficient DPs in Haitian and French: from morphosyntax to reference construal. 2006. halshs-00108474

HAL Id: halshs-00108474

<https://shs.hal.science/halshs-00108474>

Preprint submitted on 20 Oct 2006

HAL is a multi-disciplinary open access archive for the deposit and dissemination of scientific research documents, whether they are published or not. The documents may come from teaching and research institutions in France or abroad, or from public or private research centers.

L'archive ouverte pluridisciplinaire **HAL**, est destinée au dépôt et à la diffusion de documents scientifiques de niveau recherche, publiés ou non, émanant des établissements d'enseignement et de recherche français ou étrangers, des laboratoires publics ou privés.

Bare NPs and deficient DPs in Haitian and French: from morphosyntax to referent construal¹

Anne Zribi-Hertz & Herby Glaude
Université Paris-8/UMR 7023, CNRS

(to appear 2006 in M. Baptista & J. Gueron, eds., *Noun phrases in Creole languages*, Amsterdam : J. Benjamins)

Abstract

Based on a comparative description of Haitian and French noun phrases, this study focuses on the notion of *bareness* which characterises so-called *bare NPs*. Lack of determiner is identified as one type of syntactic deficiency, which must be distinguished from Number deficiency. For any functional feature F, phonological deficiency is argued to be ambiguous between feature unmarkedness, feature deficiency, and spell-out deletion. The study of *bare NPs* must therefore crucially separate the phonological and syntactic modules of grammar. Surveying the main determiners of Haitian in simplex (nonrelativised) noun phrases, we show that these morphemes all have a deictic value, either because of their inherent features, or because of their selectional properties, and that ‘bare NPs’ correlatively occur as default options which take up whatever interpretations are not available for overt determiners. We next turn to complex relativised noun phrases. Adapting Kayne’s (1994) theory of relativisation, we argue from Haitian evidence that they include two layers of functional structure which are independently specified for number and/or definiteness, each distribution of features triggering its own set of semantic effects. We suggest that the distribution of number and locative determiners in relativised DPs, and the correlated semantic effects, might be essentially similar in French and Haitian, in spite of the crucially different properties of ‘D’ heads in these two languages.

1. Bare NPs and Number-deficient DPs

Bare NPs are usually understood (cf. Chierchia 1998, Longobardi 1999, 2001) as noun phrases which lack a determiner, their semantics being of special interest in languages which otherwise *have* determiners. For example, English licenses bare NPs where French does not², as exemplified in (1)-(2) :

- (1) a. The whales are cute. [specific reading]
b. Whales are cute. [generic reading]
- (2) a. Les baleines sont mignonnes. [specific or generic]
DF whale-PL are cute-PL
b. *Baleines sont mignonnes.

The lack of determiner, however, is not the only type of functional deficiency within noun phrases which deserves to be studied. Another relevant case is number deficiency, which we illustrate in (3b) and (4b,c) by French examples :

- (3) a. Achetez mes jolies tomates !
buy-2PL my-PL pretty-FPL tomato-PL
‘Buy my pretty tomatoes !’
b. Achetez ma jolie tomate !
buy-2PL my-F pretty-F tomato

lit. 'Buy my pretty tomato !'

- (4) a. J' ai mangé *une* *tomate* au petit déjeuner.
 1SG have eaten a/one-FSG tomato at breakfast
 'I ate {a/one} tomato for breakfast.'
- b. J' ai mangé *de la* *tomate* au petit déjeuner.
 1SG have eaten *de* DF-F tomato at breakfast
 'I ate tomato for breakfast.'
- c. Je me suis cassé la jambe en glissant sur *de la* *tomate*.
 1SG broke my leg as I slid on *de* DF-F tomato
 'I broke my leg as I slid on tomato (pulp).'
- d. J' ai mangé *des* *tomates* au petit déjeuner.
 1SG have eaten *de*+DF-PL tomato-PL at breakfast
 'I ate tomatoes for breakfast.'

The two examples in (3) may be naturally uttered by a Paris vegetable grocer. In sentence (3a), plural marking on the object noun phrase unambiguously triggers a plural interpretation of the referent, i.e. forces us to construe an atomised set of tomatoes minimally including two items. Sentence (3b), where the object is not pluralised, is on the other hand ambiguous between a singular construal (only one tomato-item on sale), and what we shall call a *Sample* reading, pointing to an unspecified quantity of discontinuous items belonging to the TOMATO species.³ This latter interpretation is similar to that of noun phrases which have been or may be characterised as involving number deficiency in various other languages.⁴ In sentences (4a) and (4d), the determiners *une* and *des* in the object noun phrase, which are respectively specified for the singular (*une* = 'one') and for the plural (*des* = *de+les*), trigger a so-called +Count construal of the object referent : *one* tomato-item in (4a), *at least two* tomato-items in (4d). In (4b), on the other hand, the so-called 'partitive' determiner *de+la* triggers, in the same context, trigger a -Count interpretation involving a continuous construal of the referent (*tomato substance or pulp*).⁵ A subtle semantic difference between the Sample reading in (3b) and the Pulp reading in (4b,c) is that the Sample reading does not involve any *grinding* of the referent in the sense of Pelletier (1979), i.e. its being reduced to a pulp/a powder/a stew while the Pulp reading involves Grinding. A crucial observation regarding these examples is that the Sample reading available in (3b), and the Pulp reading available in (4b,c) cease to be available whenever a number specification (-plural, or +plural) is present in the noun phrase: thus, sentence (3a) is unfelicitous if the salesman only has one tomato-item to sell, while (3b), in its Sample reading, is felicitous in this pragmatic context; and the Pulp reading is unavailable in (4a) and (4d), contrasting with (4b,c). To account for these data, we assume that an argument noun phrase may be syntactically unspecified for number, and that number deficiency is the source of Mass readings which include the Sample reading exemplified in (3b) and the Pulp reading exemplified in (4b).⁶ Under our assumption, the Mass/Count contrast is therefore not a lexical distinction, but a semantic effect derived from number specification in syntax.⁷ Any noun, such as *tomato*, may a priori be combined with a number specification, as exemplified above — although some nouns favour one type of syntax on account of the type of referent they serve to denote: thus, since liquid referents are physically perceived as nonatomised substances, they naturally call for a Pulp-type reading, so that the nominals which denote them call for [-number] syntax, unless they are combined with a Count classifier (*one water* = 'one *unit/serving/bottle* of water'); conversely, since human referents are likely to be treated as separate individuals, the nominals which denote them tend to call for [+number] syntax. A correlate of our analysis is that the absence of overt plural marking, in a functional-number

language, is a priori ambiguous between the negative value of number (-plural, i.e. ‘singular’) and number-deficiency (-number). This distinction is formalised in (5):⁸

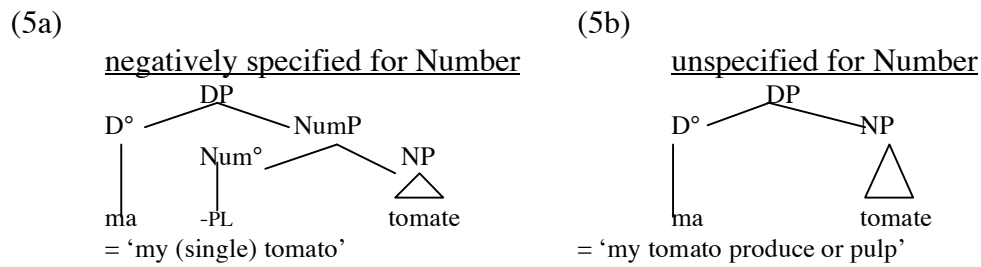

This ambiguity involving number may be regarded as a specific manifestation of the linguistic principle phrased in (6):

- (6) The ambiguity of feature deficiency
 For any *functional* feature F, the lack of phonological spell-out for F may a priori indicate either the *nonspecification* of F, i.e. *syntactic deficiency*, or the *unmarked value* of F, i.e. *phonological deficiency*.⁹

Our analysis of syntactic number leads us to revise the notion of *bareness*, in noun phrases. The English *bare plural* which occurs in (1b) is not functionally *bare* since it is specified for number, whereas the noun phrase *tomato* which occurs in the English translation of (4b) may be assumed to be *bare* if this should mean deficient for both determiner and number. Under our assumptions, English argument noun phrases may also include a determiner but be left unspecified for number, as shown by (7) :

- (7) a. [Mary had a dog and a cat.] *The cat* was disgusting.
 [-plural], Count reading > single cat-creature
 b. [Mary had cat and rice for breakfast.] *The cat* was disgusting.
 [-number], Mass (Pulp) reading > cat meat¹⁰

Our main starting assumption is that the current *bareness* (*bare NP*) concept should be replaced by a more fine-grained approach to feature deficiency. First, the distinction between lack of determiner and lack of number should be crucially taken into account for the analysis of noun phrases. Second, phonological deficiency (lack of phonological spell-out) should be crucially distinguished from syntactic deficiency (lack of feature specification).

2. ‘Definiteness’ and number marking in simplex Haitian noun phrases

2.1. The definite determiner LA

Haitian,¹¹ is a ‘determiner language’, since its lexicon includes a morpheme commonly identified as a *definite determiner* which we shall gloss as *DF* for convention’s sake. This morpheme is basically spelt out as *la* and exhibits a good deal of allomorphy.¹² In what follows the capitalised transcription LA will be meant to refer to the Haitian definite determiner regardless of its context-dependent phonological spell-out. From a historical perspective, Haitian LA is a recycled development of the French locative adverb *là* (‘here/there’) (cf. Hazaël-Massieux 1999). The examples given in (8) and (9) illustrate the allomorphic variation of LA, and show, through their English translations, why this morpheme has been labeled a *definite determiner*.¹³

- (8) a. Pòl ekri lèt la.

- | | | | | | | | |
|----|-----|--------------------------|-----|-------|--|--------|-----|
| | | Paul | | write | | letter | DF |
| | | 'Paul wrote the letter.' | | | | | |
| b. | Pòl | ap | | achte | | vach | la. |
| | | Paul | FUT | buy | | cow | DF |
| | | 'Paul will buy the cow.' | | | | | |
-
- | | | | | | | | |
|--------|-----|---|-----|---------|--|---------|------|
| (9) a. | Pòl | ap | | achte | | chyen | an. |
| | | Paul | FUT | buy | | dog | DF |
| | | 'Paul will buy the dog.' | | | | | |
| b. | Pòl | ap | | achte | | labalèn | nan. |
| | | Paul | FUT | buy | | whale | DF |
| | | 'Paul will buy the whale.' | | | | | |
| c. | Pòl | | | leve | | bebe | a. |
| | | Paul | | wake up | | baby | DF |
| | | 'Paul woke up the (aforementioned) baby.' | | | | | |

Two syntactic representations have been considered in the linguistic literature to account for these data: the one sketched in (10), proposed by Gadelii (1997) and Lefebvre (1998), assumes that DP is head-final in Haitian; the one in (11), proposed by Déprez (2000) and Lyons (2000), assumes that DP is universally head-initial and that D-final noun phrases involve NP-raising to spec,DP:

- (10) Gadelii (1997), Lefebvre (1998)

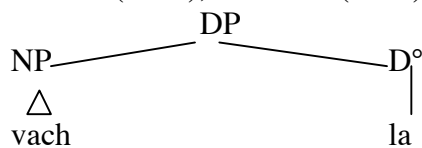

- (11) Déprez (2000), Lyons (2000): NP-raising

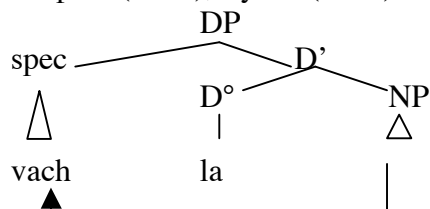

As already mentioned above, Haitian LA was historically recycled from the French locative adverb *là*, which also contributes to noun-phrase functional structure in French as a correlate of demonstrative determiners, cf. *cette vache-là*, lit. 'that cow-there'. To derive such correlative structures within the X-bar framework, it may be argued that the NP (or NumP) is raised to its surface position — the specifier of the phrase headed by *là*. Diagram (11) suggests that this raising rule still applies in the derivation of Haitian *vach la*; but it further states that the head which hosts LA in Haitian has become a 'D' head since the topmost DP layer of French has been discarded. Diagram (10) says like (11) that the head which hosts LA has become a 'D' head in Haitian, but it suggests that the NP-raising rule which applies in French does not apply in Haitian. One argument in favour of (11) is of a purely theory-internal nature — it is compatible with Kayne's (1994) assumption that phrases are universally head-initial. Further empirical evidence in support of (11) is that Haitian is otherwise a head-initial language (V, P and C precede their complement).

2.2. The plural marker *yo* and its relation to LA

Haitian has a plural marker, *yo*, which is linearly ordered to the right of the definite determiner:

- (12) a. Pòl ekri lèt (la) yo. [compare (8a)]
 Paul write letter DF PL
 'Paul wrote the letters.'
- b. Pòl ap achte chyen (an) yo. [compare (9a)]
 Paul FUT buy dog DF PL
 'Paul will buy the dogs.'

When the plural marker *yo* occurs, the definite marker *LA* is deleted in most Haitian dialects, but it remains overtly realised in at least one (Northern) dialectal variety. The most straightforward way to account syntactically for the *LA-yo* linear ordering is the representation given in (13), proposed by Gadelii (1997) and Zribi-Hertz (2002) :

- (13) Gadelii (1997), Zribi-Hertz (2002) : no movement

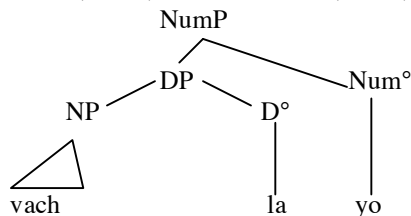

A first problem with this representation is that it is D-final (see above), but it may easily be translated into its D-initial equivalent (13') :

- (13')

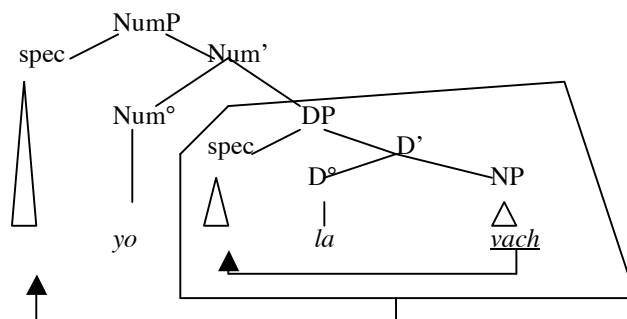

A second and more serious problem with (13)-(13') is that it conflicts with a widespread understanding of the 'DP Hypothesis', according to which D crucially pertains to the left periphery and DP should hence be the topmost projection of the noun phrase.¹⁴ Two proposals have been made to fit such data as (12) into the DP Hypothesis: one is by Lefebvre (1998) and is represented in (14); the other is by Aboh (2002), whose assumption is put forward for Gungbe but is adapted here to Haitian:

(14) Lefebvre (1998): plural adjoins to D

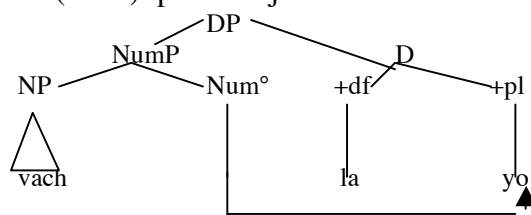

(15) Aboh (2002, for Gungbe): cyclic NP-raising to spec,DP

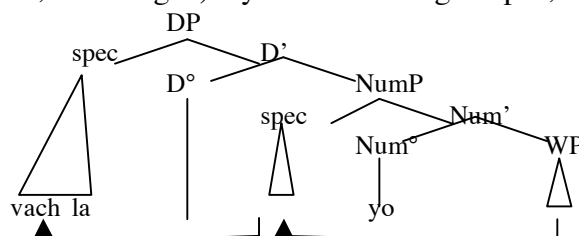

The structures in (14) and (15) rescue the conventionally-understood DP-Hypothesis but face some other problems. Lefebvre's assumption that the plural adjoins to D incorrectly suggests that the Haitian definite marker is inflected for number, while it seems on the contrary quite clear that Haitian has characteristically done away with inflected determiners. Aboh's proposal doesn't run into this serious problem, but includes a D head whose feature content is unclear, since LA is generated here in the WP phrase. In order to straighten up this problem, we might consider generating LA in D in (15), with the NP raising cyclically to spec,DP.

However, a further important property which must be expressed by whatever analysis we should select is that Plural *selects* Definiteness in Haitian. This is exemplified in (16) and (17):¹⁵

- (16) a. Pòl achte de vach.
 Paul buy two cow
 'Paul bought two cows.'
- b. Pòl achte de vach yo.
 Paul buy two cow PL
 'Paul bought *the(se)* two cows.'
 ≠ 'Paul bought two cows.'

- (17) a. Pòl ekri lèt.
 Paul write letter
 'Paul is writing mail.'
- b. Pòl ekri lèt yo.
 Paul write letter PL
 'Paul is writing *the(se)* letters.'
 ≠ 'Paul is writing letters.'

The examples show that the occurrence of the plural marker *yo* automatically calls for the so-called *definite* reading of the referent, glossed in English by means of the definite article *the*. In other words, a pluralised noun phrase such as *vach yo* is semantically equivalent to its dialectal variant *vach la yo*, which overtly contains the definite marker. But conversely, the occurrence of the definite marker LA does not necessarily involve number specification in the noun phrase, as revealed by the ambiguity of (18a,b):

- (18) a. Pòl ap achte ze a.

- Paul FUT buy egg DF
 (i) ‘Paul will buy the (single) egg-item.’
 (ii) ‘Paul will buy the egg-material.’ (i.e. that unspecified quantity of EGG produce which is needed for some purpose or other)
- b. Pòl achte *mori* a.
 Paul buy codfish DF
 (i) ‘Paul bought the (single) codfish animal.’
 (ii) ‘Paul bought the codfish {meat/produce}.’

Under the assumption introduced in section 1, we claim that the interpretations glossed under (18a(ii)) and (18b(ii)) correlate with Number deficiency in syntax. Hence, definite LA does not require number specification, whereas as shown in (16)-(17), overt number specification requires definiteness. This asymmetrical dependency is not captured by the diagram in (14), while it is by the structures proposed in (13)-(13’), as well as by the structure in (15). Since (15), but not (13)-(13’), includes an *ad hoc* D head, the structural representation which appears to us as optimally adequate to account for the described data is (13’), a head-initial structure where Number (*yo*) dominates D (*la*). For purely typographical reasons, however, we shall adopt below head-final representations similar to (13), every one of which may easily be translated into its D-initial counterpart as in (13’).

The diagrams in (19) represent the ambiguity of (18b):

(19) *mori a* ‘the codfish’

a. unspecified for Number: ‘the codfish meat/produce’

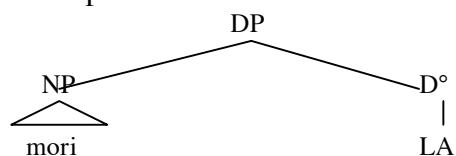

b. negatively specified for Number: ‘the (single) codfish animal’

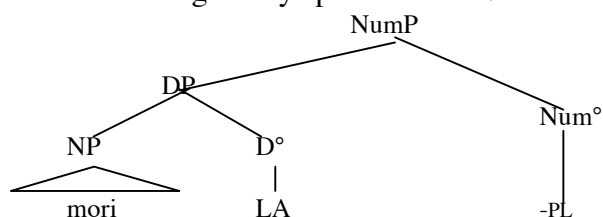

The structure in (19b) leaves us with the DP-Hypothesis twist mentioned above: how can DP – the ‘left periphery’ – be located below NumP – an inflectional projection – in syntax? Our belief is that the Haitian data create neither Twist nor Paradox: the key to our apparent problem is that the so-called definite marker is of an inherently different nature in Haitian and in French.

2.3. How can NumP stand above DP in syntactic structure?

The Haitian *definite determiner* has a strong deictic value, which we may correlate to its locative nature, and which makes it contrast sharply with the French *definite article*.¹⁶ Thus, while French *le* is associated in (20a) with a generic reading, Haitian LA only allows a specific reading in (20b) :

- (20) a. Paul aime *le riz*.
 Paul likes DF rice
 ‘Paul likes rice.’
- b. Pòl renmen *diri a*.
 Paul like rice DF
 ‘Paul likes the rice.’
 ≠ ‘Paul likes rice.’

While French *la* is open to a variable reading in (21a), only the referential reading is allowed in (21b) :

- (21) a. Paul a éteint *la lumière*, et moi aussi.
 Paul turned off DF light and so did I.
- b. Pòl etenn *limyè a*, ak mwenn menm tou.
 Paul turned off light DF and 1SG ITSF too
 ‘Paul turned off that light, and so did I.’
 ≠ ‘Paul turned off the light (wherever he was), and so did I (wherever I was).’

While French *la* is open to the ‘inalienable-possession’ reading in (22a), only the alienable reading is allowed in (22b) :

- (22) a. Paul a levé *la tête*.
 Paul has raised DF head
 lit. ‘Paul raised the head.’
 = ‘Paul raised his head.’
- b. Pòl leve *tèt la*.
 Paul raised head DF
 ‘Paul raised the head.’
 ≠ ‘Paul raised his head.’

While French *le* is open to a variable reading in (23a), only a referential reading is available in (23b) :

- (23) a. Sonnez: *le boucher* va vous servir.
 ring DF butcher will 2PL serve
 ‘Ring the bell : the butcher [whichever one is on duty] will come and serve you.’
- b. Sonnen: *bouche a* ap vin sè vou.
 ring: butcher DF FUT come serve 2PL
 ‘Ring the bell : {this/that} butcher will come and serve you.’
 ≠ ‘Ring the bell : the butcher [whichever one is on duty] will come and serve you.’

The semantic contrasts brought out by (20)-(23) may be subsumed under the descriptive assumption that the French definite article is construed as a bound variable, whereas Haitian LA is not. Following Zribi-Hertz (to appear), we derive the variable semantic behaviour of the French definite article from its pronominal nature, which crucially involves topical binding — a property assumed to be anchored in the left periphery of DP. Haitian LA, on the other hand, is not a pronoun, but a deictic locative morpheme, categorially akin to *sa* - the so-called

demonstrative, a recycled development of French *ça* (the spoken variant of the neuter, demonstrative pronoun *cela*). In Modern Haitian, *sa* is selected by LA, as shown by (24c):

- (24) a. Pòl ekri lèt la.
 Paul write letter DF
 ‘Paul wrote the/this/that [no ostensive signal] letter.’
- b. Pòl ekri lèt sa a.
 Paul write letter DM DF
 ‘Paul wrote this/that [ostensive signal] letter.’
- c. *Pòl ekri lèt sa.

The contrast between (24a) and (24b) is that (24b) involves two layers of deixis marking, while (24a) only involves one. Correlatively, (24b) suggests *strong* deixis (ostension), while (24a) suggests *weak* deixis (presupposed spatialisation). As witnessed by the ungrammaticality of (24c), demonstrative *sa* must be selected by definite LA. The Haitian plural marker *yo*, on the other hand, is a recycled development of *eux*, the French nonclitic 3MPL pronoun. The LA *yo* linear ordering observed in Haitian may be related to the [LA, *eux*] linear sequence observed in French (25), where *là*, as a syntactic correlate of the demonstrative determiner, is positioned inside the DP while *eux*, as a dislocated DP-adjunction, is positioned outside the DP :

- (25) Ces chiens -là, eux, aboient rarement.¹⁷
 DM-PL dog-PL LOC 3PL bark-3PL rarely
 ‘Those dogs rarely bark.’

In short, the syntactic representation proposed in (13)-(13’) does not lead to discard the ‘DP Hypothesis’, provided we realistically accept that the conventional labels *DP* and *NumP* identify positions rather than categories (cf. Milner 1989). NumP dominates DP in Haitian while DP dominates NumP in French because the positions labeled Num and D do not host the same categories in the two languages.

2.4. Doubly-‘definite’ DPs

Gadelii (1997 :142) further notes that a Haitian DP may contain two distinct occurrences of LA, positioned below and above Number, and which he respectively labels DF (*definite*) and DEIX (*deixis*), as in (26) :

- (26) liv mwen sa a yo (a)
 book 1SG DM DF PL DEIX
 lit. ‘those books of mine over there’

However, as shown above, even the morpheme which Gadelii labels *definite* has a deictic force in Haitian. The two instances of LA (> *a*) which occur in (26) are historically derived from the same lexical source (French *là*). From a categorial viewpoint, there is only one LA morpheme in Haitian, but as shown in (26), it can occupy two distinct and combinable functional heads to which Gadelii assigns different labels for convenience’s sake. These facts suggest that what is glossed as DF (*definiteness*) in our examples does not identify a feature, a category, or even a structural position, but only a conventional label inspired by the semantics of French-type *definite articles*. The double occurrence of LA observed in (26) is perfectly consistent with the deictic nature of this morpheme, if we assume that deixis may recursively contribute to referent identification. In this respect, Haitian LA sharply contrasts with the

French definite article, whose number of occurrences is limited to one in a maximal noun phrase.

2.5. 'Bare NPs'

The three functional morphemes LA, *yo* and *sa* of Haitian considered above all trigger a referential, *spatialised* construal of the referent: LA and *sa* because of their deictic character, and *yo* because it always selects deictic LA as its complement. As a result, none of the Haitian determiners considered above allows a nonspatialised reading, i.e. an interpretation which does not link the referent to a specific portion of space. It is thus not very surprising to find that Haitian licenses bare NPs, which take up whatever interpretations do not involve spatialisation:

- (27) a. Pòl renmen vach.
Paul like cow
'Paul likes cows (any member of the COW species).'
- b. Pòl etenn limyè , ak mwen menm tou.
Paul turn off light and 1SG ITSF too
'Paul turned off {the light/lights} and so did I [variable reading only].'
- c. Sonnen : bouche ap vin sè vou.
ring butcher FUT come serve 2PL
'Ring the bell: the butcher(s) (whichever one(s) is/are on duty) will come and serve you.'
- d. Soup bon pou bouche.
soupe good for butcher
'Soup is good for {butchers/the butcher (whoever he is)}.'

'Bare NPs' are unspecified for number not only in morphology, but also in their interpretation, as witnessed by the strongly context-sensitive construal of their referent (cf. (27b,c)). We thus assume that they lack a Number projection in syntax. To capture the fact that their referent is construed as non-spatialised, we assume that they include a D head hosting a [-locative] feature value, contrasting with the [+locative] value spelt out by LA, which, as pointed out above (section 2.2), undergoes phonological deletion in the presence of *yo* in most Haitian varieties:

(28)a. *vach* (= (27a))

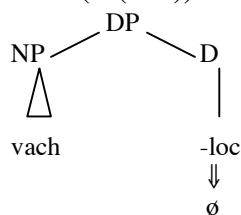

(28)b. *vach (la) yo* (= (13))

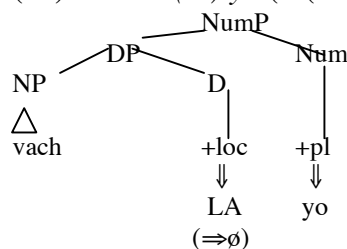

These diagrams instantiate two different cases of phonological deficiency: in (28a), the zero determiner spells out the unmarked value of the [locative] feature; in (28b), D hosts the marked value of the [locative] feature in syntax, prior to phonological deletion.

2.6. Summary

The main descriptive results of this section are listed below:

(i) The so-called *definite determiner* has a different categorial nature in French and in Haitian. Because the French definite article is a topic-bound pronoun, it is located in the left-

periphery of the noun phrase, hence above the Number projection which pertains to the inflectional domain, and its number of occurrences is limited to one. Because the Haitian plural marker *yo* is recycled from a right-adjoined 3PL pronoun, its syntactic projection — labeled *Number Phrase* — stands above LA, itself recycled from a DP-internal locative correlate of the French demonstrative. We have attempted to show why this state of affairs causes no unsolvable paradox as far as the DP-Hypothesis is concerned.

(ii) In Haitian as in French, a nominal argument is not necessarily specified for number. Number deficiency correlates with Mass semantic effects which include those we have labeled above *Pulp* and *Sample*.

(iii) Because all overt determiners (*sa*, *LA*, *yo*) have a deictic effect in Haitian, the occurrence of an overt determiner in this language cannot be associated with a nonspatialised construal of the referent. Hence, ‘bare NPs’ — i.e. noun phrases lacking an overt determiner — freely occur as arguments in this language, and they take up whatever semantic interpretations are not available for overt determiners. In this respect, bare NPs may be described as default nominals in this language. We have proposed to analyse Haitian ‘bare NPs’ as number-deficient DPs whose D head hosts the unmarked feature value [-locative].

3. Definiteness and Number in Haitian relativised noun phrases

3.1. The complex structure of relativised noun phrases

In what follows we shall be calling *relativised DP* a noun phrase which includes a restrictive relative clause.

An aspect of Haitian relativised DPs which seems at first glance remarkable to a French or English speaker is that they may include determiners and plural markers in two distinct and combinable positions. Thus, the English noun phrase *the codfish which Paul buys/bought*¹⁸ may translate as (29a), (29b), (29c) or (29d); and *the(various) codfish (items) which Paul bought*, as (30a), (30b) or (30d) — though (30c) is ungrammatical :

(29) *the codfish which Paul bought*

- | | | | | | |
|----|---------|----------|-------|----------|----------|
| a. | mori | Pòl | achte | | |
| | codfish | Paul | buy | | |
| b. | mori | <i>a</i> | Pòl | achte | |
| | codfish | DF | Paul | buy | |
| c. | mori | Pòl | achte | <i>a</i> | |
| | codfish | Paul | buy | DF | |
| d. | mori | <i>a</i> | Pòl | achte | <i>a</i> |
| | codfish | DF | Paul | buy | DF |

(30) *the codfish (items) which Paul bought*

- | | | | | | |
|----|---------|-----------|------|-------|-----------|
| a. | mori | <i>yo</i> | Pòl | achte | |
| | codfish | PL | Paul | buy | |
| b. | mori | | Pòl | achte | <i>yo</i> |
| | codfish | | Paul | buy | PL |
| c. | *mori | <i>yo</i> | Pòl | achte | <i>yo</i> |
| | codfish | PL | Paul | buy | PL |
| d. | mori | <i>yo</i> | Pòl | achte | <i>a</i> |
| | codfish | PL | Paul | buy | DF |

To account for these facts we shall adopt Kayne's (1994) general approach to restrictively-relativised noun phrases, whose leading idea is that they crucially involve two

layers of noun phrase structure: a larger DP which contains a CP projection, and an argument noun phrase which raises out of the embedded clause to the spec of CP:

(31) Definite relativised noun phrases according to Kayne (1994)

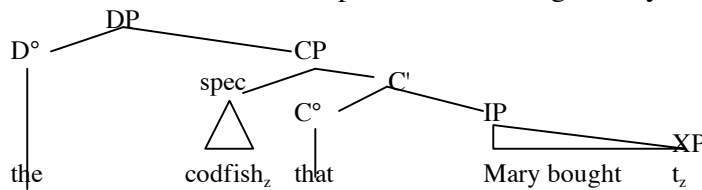

Kayne's leading assumption is that in a complex noun phrase such as (31), the string *the codfish* does not form a syntactic constituent, but results from a nondefinite noun phrase (*codfish*) raising up to spec,CP. The issue of the categorial label of the embedded noun phrase tagged 'XP' in (31) is left unsettled by Kayne, who only suggests that it must not be 'definite' — the definite determiner belonging upstairs.

Kayne's analysis is strongly criticised by Borsley (1997), whose main objection is that the raised expression in structure (31) must be a maximal projection, therefore a 'DP', since it stands as an argument within the embedded clause. It follows that Kayne's grammar generates ungrammatical strings such as **the the codfish that Mary bought*. We do not believe, however, that this overgeneration problem is a necessary consequence of Kayne's general theory. First, empirical evidence suggests that in such languages as English or French, the raised argument in structure (31) is NOT 'definite' (cf. Smith 1964, Vergnaud 1985, Kayne 1994). Second, assuming that XP in (31) must be a maximal projection (whatever its categorial label) is not conceptually problematic if the D-CP relation is seen as adjunction rather than government (cf. Zribi-Hertz to appear).

The analysis of relativised noun phrases sketched in (31) supplies a convenient means of accounting for the double functional specification exhibited in (29) and (30). Assuming that a relativised structure such as (31) actually involves two noun phrase projections, an UPSTAIRS noun phrase, and a DOWNSTAIRS noun phrase, it is not unexpected to find doubly-determined relativised noun phrases in Haitian, as illustrated by (29d), which we may roughly represent as in (32) (leaving out Number, discussed below):

(32) relativised noun phrase with two definite determiners, e.g. :
mori a Pòl achte a (28d):

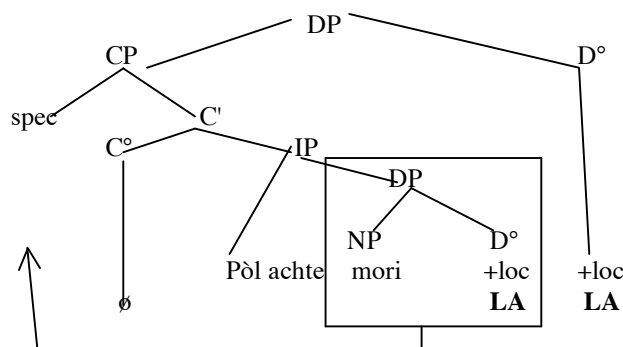

As a result of Relativisation, the downstairs determiner surfaces in an internal position within the larger DP, while the upstairs determiner surfaces in the phrase periphery. The result is a double-D noun phrase, not unsimilar to that in (26).

We shall further continue to assume, as we did above in section 2, that nonpluralised noun phrases, in Haitian, are syntactically ambiguous between a [-plural] reading correlating with the negative value of Number (a ‘singular’ construal of the referent), and a [-number] reading correlating with the absence of the Number projection (‘Pulp’ or ‘Sample’ construal of the referent). This means that each one of the projections labeled DP in diagram (32) could a priori be either specified for the singular, or unspecified for number. To sort out this issue, we shall first look at relativised noun phrases which include an overt number specification, and shall return to nonpluralised noun phrases afterwards.

3.2. The distribution of Number in relativised noun phrases

3.2.1. Plural relativised noun phrases

As witnessed by paradigm (30), repeated below, the [+plural] value of Number may be specified downstairs (30a) or upstairs (30b), but it cannot be specified at both levels (30c):

(30) *the codfish (items) which Paul bought*

- | | | | | |
|----|------------|------|----------|--|
| a. | mori yo | Pòl | achte | |
| | codfish PL | Paul | buy | |
| b. | mori | Pòl | achte yo | |
| | codfish | Paul | buy PL | |
| c. | *mori yo | Pòl | achte yo | |
| | codfish PL | Paul | buy PL | |
| d. | mori yo | Pòl | achte a | |
| | codfish PL | Paul | buy DF | |

The ill-formedness of (30c) could derive from a general restriction to the effect that number specification, unlike deixis, may contribute only once to identify a single referent. We argued in section 2 that Number selects DP in Haitian, and that noun phrases which surface as ‘bare’ are number-deficient, [-locative] DPs. It follows that the noun phrase in (30a) combines a fully saturated NumP downstairs with a number-deficient, [-locative] DP upstairs, while the noun phrase in (30b) combines a fully saturated NumP upstairs with a ‘bare noun phrase’ — i.e. a number-deficient [-locative] DP — downstairs:

(33) a. *mori yo Pòl achte (= (30a))*

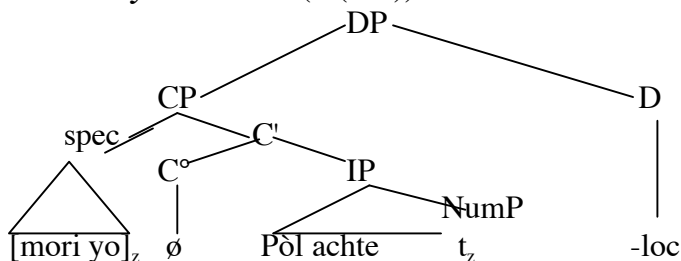

b. *mori Pòl achte yo* (= (29b))

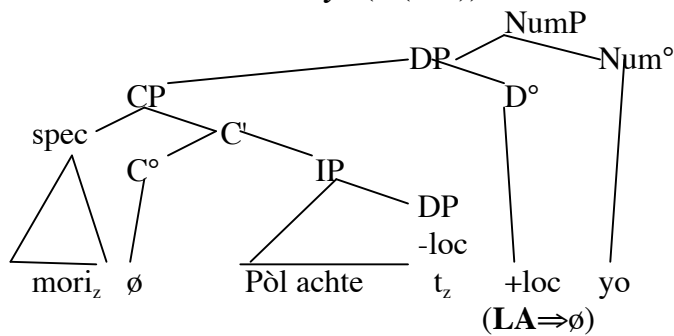

The result of these combinations is a complex noun phrase which is number-deficient (or 'bare') at one level but not at the other. The well-formedness of (30d) further reveals the availability of the combination represented in (34):

(34) *mori yo Pòl achte a* (= (30d))

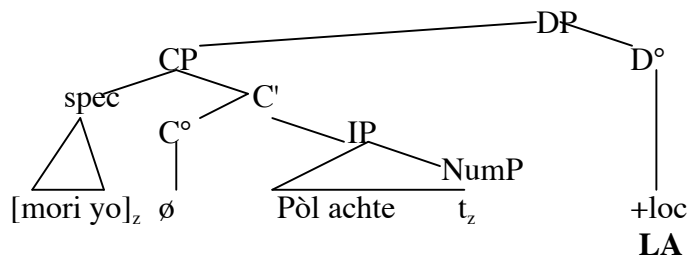

In this case, the upstairs determiner cannot be associated with its own Number projection. That Number cannot be projected both upstairs and downstairs is straightforwardly revealed by the ill-formedness of (30c). As regards (34)/(30d), if Number were projected upstairs, its value would be [-plural], which would conflict with the plural downstairs. We thus assume that (34)/(30d) involves Number (hence Definiteness¹⁹) downstairs, but bare Definiteness (i.e. Definiteness without Number) upstairs.

As naturally expected, the three structures in (33a), (33b) and (34) are not associated with the same semantic interpretations. Upstairs plural marking, as in (33b), triggers a spatialised and plural construal of the referent in which the plural has scope over the entire noun phrase: in other words, an *antipartitive* semantic effect. Downstairs plural marking with a 'bare noun phrase' upstairs, as in (33a), triggers a partitive effect implying that the several items that Paul bought were part of a larger set of available codfish animals. Combining downstairs plural with upstairs definiteness, as in (34), triggers a discourse-linked reading. In (35) below we propose an English translation for each of these three patterns:

- | | | | | | |
|------|----|----------------------------|---|---|------------|
| (35) | a. | <i>mori Pòl achte yo</i> | : | '(all of) the codfish items
which Paul bought' | [= (33b)] |
| | b. | <i>mori yo Pòl achte</i> | : | 'those of the codfish
which Paul bought' | [= (33a)] |
| | c. | <i>mori yo Pòl achte a</i> | : | 'these [aforementioned] codfish
which Paul bought' | [= (34)] |

The three semantic interpretations glossed in (35) are felicitous in different discourse contexts, as shown in (36)-(38):

- (36) Lè Pòl al nan mache,
 when Paul go P_{LOC} market
 'When Paul goes to the market,
- a. mori li achte yo, se pou Elsi.
 codfish 3sg buy PL DM for Elsi
 all the codfish animals he buys are for Elsi.'
- b. %mori yo li achte, se pou Elsi.²⁰
 codfish PL 3sg buy DM for Elsi
 those of the codfish which he buys are for Elsi.'
- (37) Mèkredi, gen anpil bèl mori nan mache.
 Wednesday have a lot nice codfish P_{LOC} market
 'On Wednesday, there {was/were} lots of nice codfish at the market.'
- a. Mori yo Pòl achte te pli gwo pase tut.
 codfish pl Paul buy PST more big than all
 'Those of the codfish which Paul bought were the biggest of all.'
- b. *Mori Pòl achte yo te pli gwo pase tut.
 codfish Paul buy PL PST more big than all
 lit. 'All the codfish items Paul bought were the biggest of all.'
- (38) Mèkredi, Pòl achte de mori nan mache.
 Wednesday Paul buy two codfish P_{LOC} market
 'On Wednesday, Paul bought two codfish (items) at the market.'
- a. %Mori yo li achte, se te pou Elsi.
 codfish PL 3sg buy DM PST for Elsi
 'Those of the codfish which he bought were for Elsi.'
- b. Mori li achte yo, se te pou Elsi.
 codfish 3sg buy PL, DM PST for Elsi.
 The codfish (items) which he bought were for Elsi.'
- c. Mori yo li achte a, se te pou Elsi.
 codfish pl 3sg buy DF DM PST for Elsi
 'Those codfish (items) which he bought, they were for Elsi.'

Summarising, we assume on empirical grounds that a pluralised relativised noun phrase, in Haitian, involves two levels of functional specification, allowing three different feature combinations:

- Number upstairs, 'bare noun phrase' downstairs
- Number downstairs, 'bare noun phrase' upstairs
- Number downstairs, Definiteness upstairs

Each pattern triggers a different construal for the referent:

- Number upstairs has scope over the entire noun phrase
- Number downstairs has scope over the downstairs noun phrase only
- Definiteness upstairs triggers a discourse-linking effect

3.2.2. Nonpluralised relativised noun phrases

For nonpluralised relativised noun phrases, we find the four patterns exemplified in (29), repeated below in (39) with a more accurate English translation:

- (39) a. [Mori Pòl achte], se pou Elsi.
 codfish Paul buy DM for Elsi
 'Whatever codfish Paul buys is/are for Elsi.'
- b. [Mori Pòl achte *a*], se pou Elsi.
 codfish Paul buy DF DM for Elsi
 'This codfish {meat/produce/item} which Paul bought is for Elsi.'²¹
- c. [Mori *a* Pòl achte], se pou Elsi.
 codfish DF Paul buy DM for Elsi
 'The one codfish which Paul bought is for Elsi.'
- d. [Mori *a* Pòl achte *a*], se pou Elsi.
 codfish DF Paul buy DF DM for Elsi
 'This single codfish which Paul bought, it is for Elsi.'

In (39a), the bracketed noun phrase includes no overt occurrence of the definite determiner and is correlatively unspecified for Number. The semantic effect is rendered in the English translation by a universally quantified nonspecific relativised noun phrase whose referent may be construed either as Pulp or as Sample.

In (39b) and (39c), the bracketed noun phrase contains one definite determiner positioned at the right periphery in (39b), and in an internal position in (39c). The right-periphery determiner triggers a discourse-linking effect, glossed here in English by *this*, implying that the buying of one or some codfish by Paul is given information. Interestingly, the phrase *mori* ('codfish') may be construed in (39b) either as Pulp (*codfish meat*) or Sample (*unspecified sample of codfish items*), or as singular (*single codfish creature*): we hence assume that the upstairs DP in this example is ambiguously construed either as [-number] (unspecified for Number) or as [-plural] (singular). Contrasting with the external determiner of (39b), the internal determiner in (39c) only allows for a singular construal of the phrase *mori*, as translated by *one*, which suggests a partitive implication (i.e. the one codfish which Paul bought was a member of a larger set of available codfish items). We hence assume that in a Haitian complex noun phrase containing a restrictive relative clause, downstairs LA, unlike upstairs LA, is always selected by Number. We thus predict that those nouns whose semantic content calls for [-number] syntax (i.e. strictly *Mass* nouns, such as 'mud' (*labou*)) do not combine with the feature patterns exemplified by (39c,d): this prediction is confirmed below by the ungrammaticality of (40c,d):

- (40) a. [labou Pòl ranmase], se pou Elsi.
 mud Paul pick up DM for Elsi
 'Whatever mud Paul picks up is for Elsi.'
- b. [labou Pòl ranmase *a*], se pou Elsi.
 mud Paul pick up DF DM for Elsi
 'This mud which Paul has picked up is for Elsi.'
- c. *[labou *a* Pòl ranmase], se pou Elsi.
 mud DF Paul pick up DM for Elsi
 lit. 'The one mud which Paul has picked up is for Elsi.'
- d. *[labou *a* Pòl ranmase *a*], se pou Elsi.
 mud DF Paul pick up DF DM for Elsi
 lit. 'This single mud which Paul has picked up is for Elsi.'

In Haitian as in the English translations, such examples as (40c,d) would only be acceptable if construed as including an implicit classifier allowing for [-plural] syntax, which is pragmatically out of order with MUD ('one *bottle* of mud?').

As suggested by our English translations, (39b) and (39d) share one interpretation. According to our own intuition, the two examples crucially contrast in that (39b) allows either for a [-number] or for a [-plural] construal of the noun phrase, whereas (39d) only allows for the [-plural] reading: we thus suspect that the syntax exemplified by (39d) should be more frequently chosen over that of (39b) for discourse-linked singular readings, while the syntax of (39b) should be selected for discourse-linked [-number] (e.g. Pulp or Sample) readings.

Pursuing the reasoning introduced in section 2.1, we assume that in their [-plural] readings, the examples in (39) are the singular counterparts of (30), while in their [-number] readings, they involve syntactic number deficiency both upstairs and downstairs:

(41)a. (= (39a)) *mori Pòl achte*
'whatever codfish Paul buys'

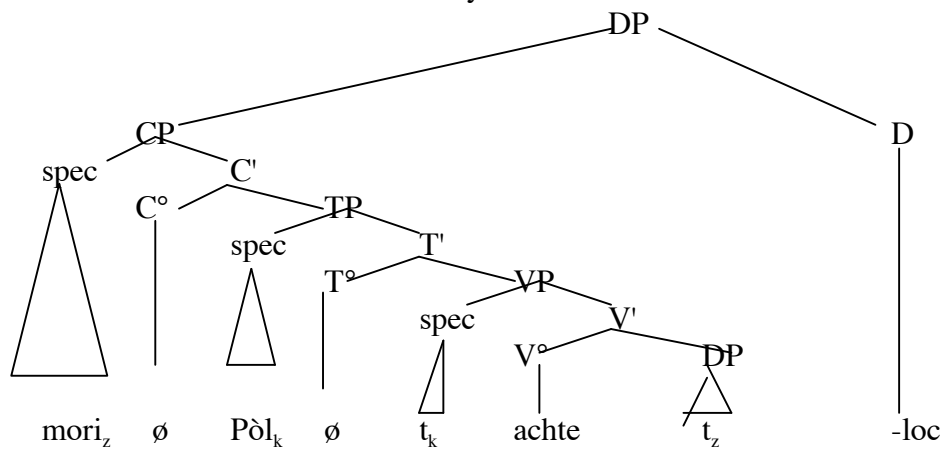

(41)b (= (39b) with Mass or Sample reading) *mori Pòl achte a*
'this codfish meat/produce which Paul bought'

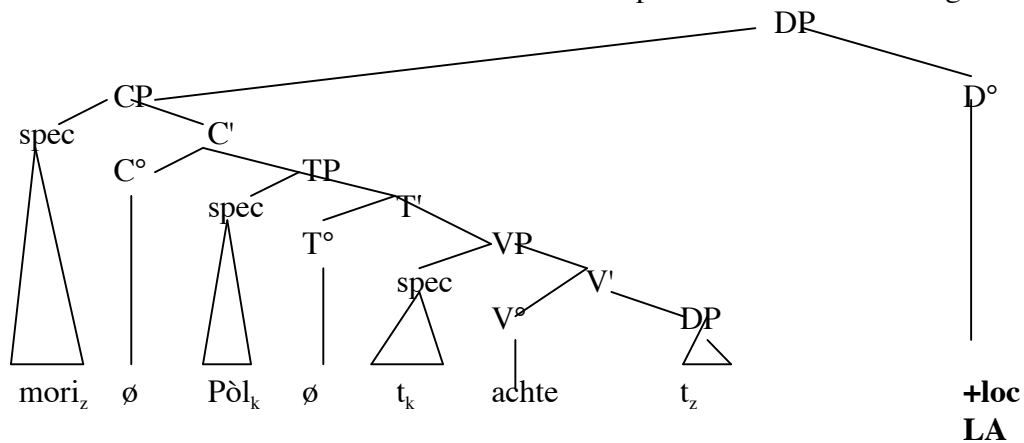

(41)c. (= (39b) with count reading) *mori Pòl achte a*
 'this codfish item which Paul bought'

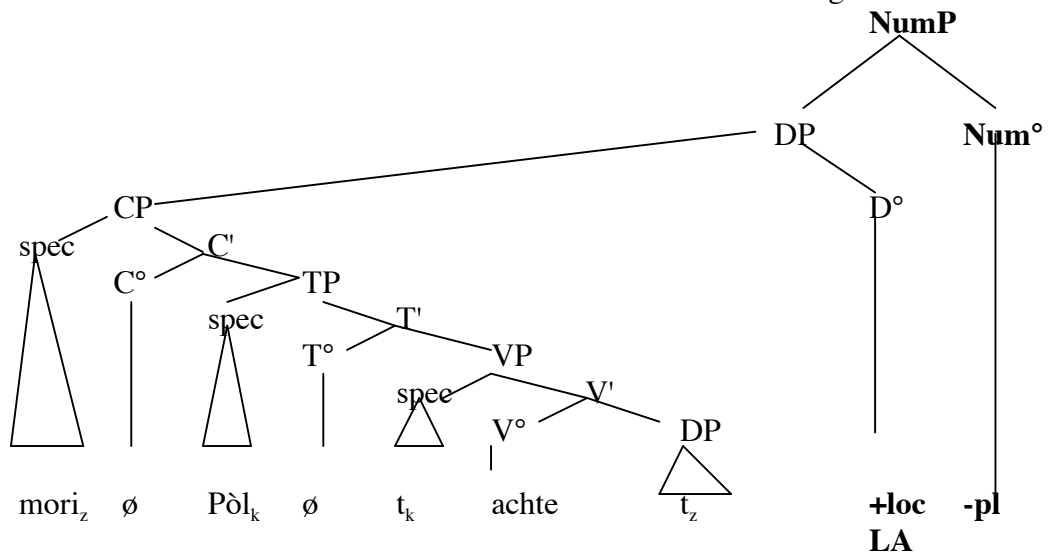

(41)d. (= (39c)) *mor a Pòl achte*
 'the one codfish which Paul bought'

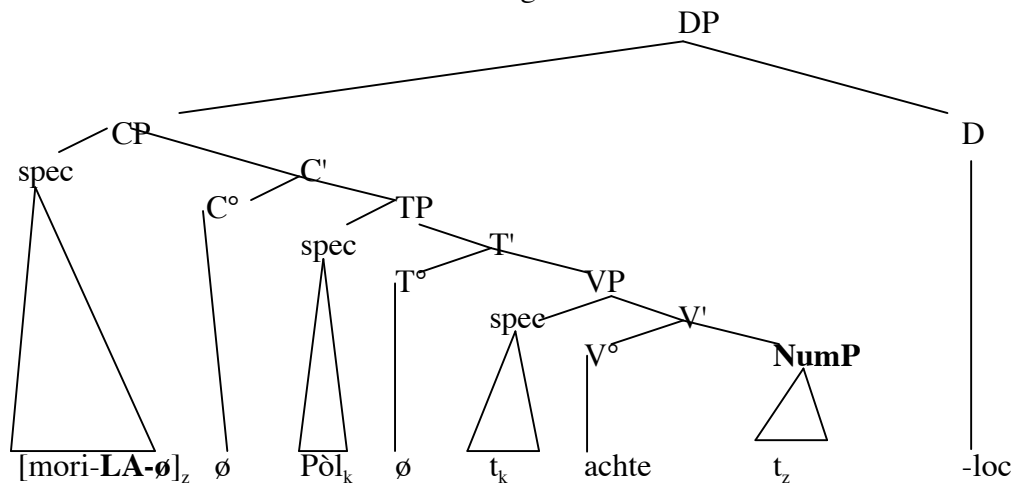

(41)e. (= (39d)) *mori a Pòl achte a*
 ‘this one codfish which Paul bought’

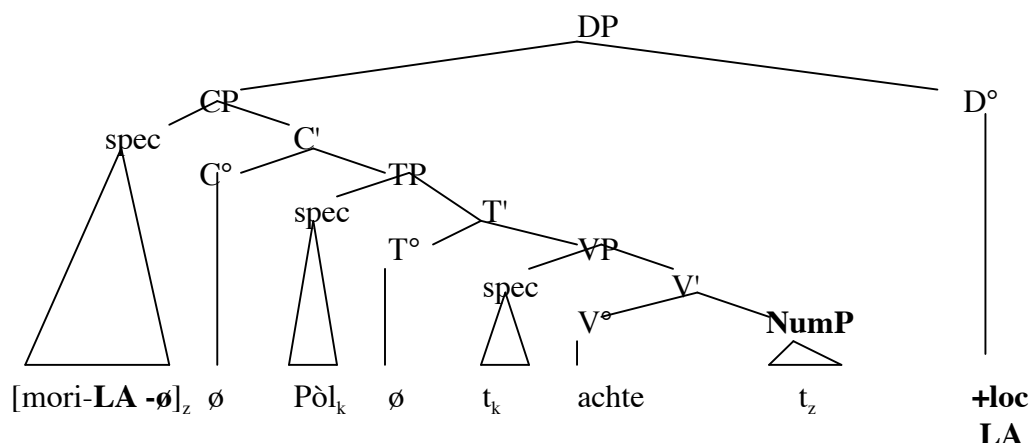

4. French relativised DPs: the teachings of Haitian

The data presented in section 3 have revealed that Haitian relativised noun phrases may include no overt functional specification (surfacing as ‘bare DPs’), an upstairs bare DP with a downstairs NumP or bare DP, an upstairs NumP with a downstairs bare DP, or a downstairs NumP with an upstairs bare DP. We have also assumed on empirical grounds that number cannot be independently specified both upstairs and downstairs within a single complex noun phrase.

As recalled in section 2, the assumed French analogue of Haitian LA is the so-called definite article, spelt out as *le* (nonplural, masculine), *la* (nonplural, feminine), *les* (plural), and which for simplicity’s sake we shall from now on designate as LE. As also recalled in section 2, French LE differs from Haitian LA in both its inherent feature content (LE is an inflected bound pronoun while LA is an uninflected deictic locative) and its structural position (LE dominates NumP while LA may dominate or be dominated by NumP). Nevertheless, both French LE and Haitian LA are commonly given the same categorial label — *definite determiner* — in the linguistic literature. One likely reason is that both seem to occupy similar paradigmatic positions within their respective determiner systems: each of them instantiates a functional item whose feature content contributes to referent-identification but is morphologically distinct from both the ostension marker (*ce+cil/là* in French, *sa* in Haitian) and the plural marker (*-(e)s* in French, *yo* in Haitian). Another interesting similarity between Haitian LA and French LE is that their occurrence is somehow required whenever functional number is specified: in Haitian, this is due to the Plural>Definiteness selectional restriction discussed in section 2; in French, it is due to the fact that gender and (functional²²) number are generally spelt out on D.²³

Let us now consider the functional structure of French relativised noun phrases. An important morphological constraint, pointed out above, is that their phi-features (gender and functional number) must be externalised on the definite article, generated in the D-head. A central assumption of Kayne’s (1994) analysis, which echoes both diachronic facts (cf. Meillet & Vendryès 1979, Muller 1996) and an idea informally expressed by Vendler (1967), and variously formalised by, e.g., Smith (1964), or Vergnaud (1985), is that within a French definite relativised DP, the definite article partakes in a head-head correlation with the complementiser, i.e. it heads a DP-CP shell within which argument raising (Relativisation)

occurs. Thus, the syntactic structure of *les livres que Paul a lus* ('the books which Paul read') may be roughly represented as in (42):

(42) *les livres que Paul a lus*

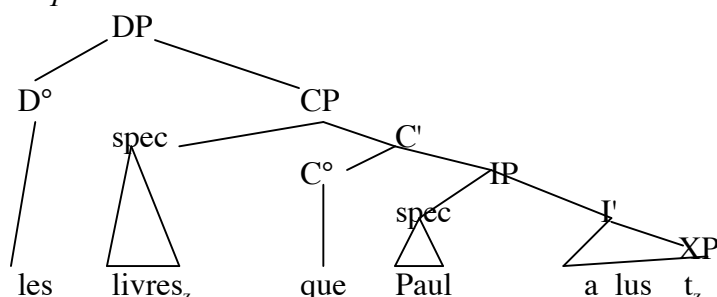

A question immediately raised by this tree diagram is that of the categorial identity of the phrase labeled XP — the argument raised to spec,CP. Kayne (1994) labels it *NP*, but assuming that the plural number must be syntactically represented somewhere in the DP under consideration, XP in (42) could also be NumP. We on the other hand assume, following Kayne, that XP in French must be nondefinite, hence cannot be 'DP'.²⁴ It follows that unlike their Haitian homologues described in section 3, French definite relativised DPs may only include one D-head, upstairs, which both supports the D-C correlation and provides a unique locus for phi-feature externalisation.

We shall now explore the idea that despite the uniqueness restriction on the D-head which prevails in French, the distribution of number and locative markers in relativised DPs and the correlated semantic effects are largely similar in French and in Haitian. Consider the French relativised DPs which are bracketed in (43) and their various possible interpretations:²⁵

- (43) a. [La morue que Paul achète] est pourrie.
 DF codfish that Paul buys/is buying is rotten
 (i) 'Whatever codfish {meat/produce} Paul buys is (always) rotten.'
 (ii) 'The codfish {meat/produce} which Paul is buying is rotten.'
 (iii) 'The one codfish which Paul is buying is rotten.'
- b. [Cette morue que Paul a achetée] est pourrie.
 (i) 'This codfish {meat/produce} which Paul bought is rotten.'
 (ii) 'This single codfish which Paul bought is rotten.'

In French as in Haitian above, a nonpluralised noun phrase headed by the noun *morue* ('codfish') may a priori be read as Pulp or Sample (cf. (43a-i, ii), (43b-i)) or as singular (-plural) (cf. (43a-iii), (43b-ii)), an ambiguity which we propose to derive, under the assumption in (5)-(6), from the intrinsic ambiguity of plural deficiency. Both the [-number] and the [+number] readings are compatible with the definite article, which — due to the restrictive relative clause — triggers a non-discourse-linked reading (cf. (43a)), and with the demonstrative determiner, which triggers a discourse-linked reading (cf. (43b)).²⁶ From a semantic perspective, these French data are essentially parallel to the Haitian data in (29). However, where four different strings are spelt out in Haitian, only two surface in French — (43a) and (43b) — distinguished by the content of the D-head: *la* (the FSG definite article, unspecified for spatialisation and glossed below as [-LOC]) vs. *cette* (the FSG demonstrative determiner, glossed as [+LOC]).

(44)

	Haitian	French	English translation
a.	mori Pòl achte	la morue que Paul achète	{the/whatever} codfish (meat/produce) Paul buys
b.	mori Pòl achte <i>a</i>	cette morue que Paul achète/a achetée'	{this/that} codfish (meat/produce) Paul {is buying/bought}
c.	mori <i>a</i> Pòl achte	la morue que Paul {achète/a achetée}	the one codfish Paul {is buying/bought}
d.	mori <i>a</i> Pòl achte <i>a</i>	cette morue que Paul {achète/ a achetée}	{this/that} single codfish Paul {is buying/bought}

The interpretive options which are provided in Haitian by the syntactic patterns distinguished in (41) are also available in French and English. In all three languages the semantic construal of the relativised noun phrase is sensitive to the aspectual properties of the clause — but we shall leave this issue out of the present study and focus on the semantic effects of DP functional structure.

Let us assume that each construal of the noun phrase is triggered by the same feature combination in both French and Haitian: the Pulp and Sample readings result from syntactic Number deficiency (i.e. the lack of the Number projection), the singular reading is triggered by the negative value of the Number feature, and the discourse-linking effect is triggered by an upstairs locative spelt out as *LA* in Haitian, and by *cette* in French:

(45) a. Number deficiency > Pulp or Sample reading

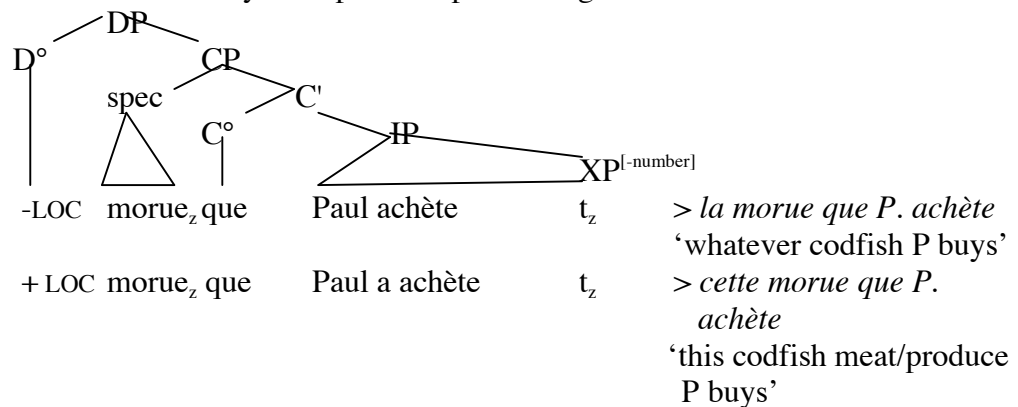

(45) b. Number upstairs > singular with wide scope

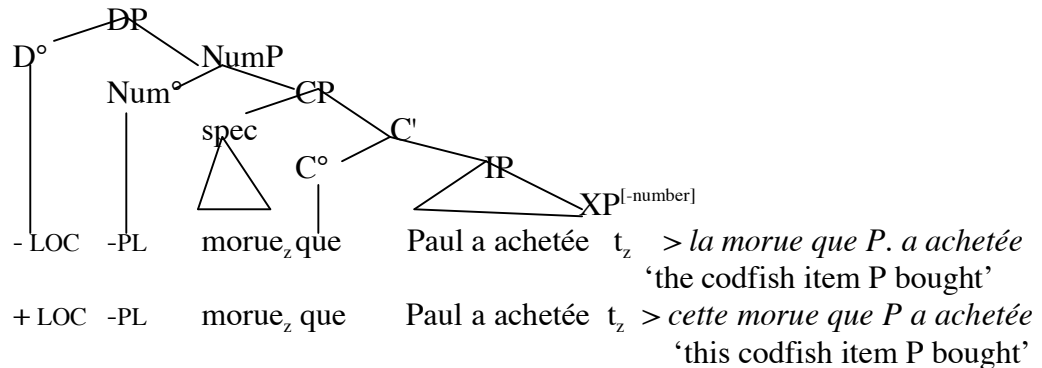

(45) c. Number downstairs > singular with narrow scope

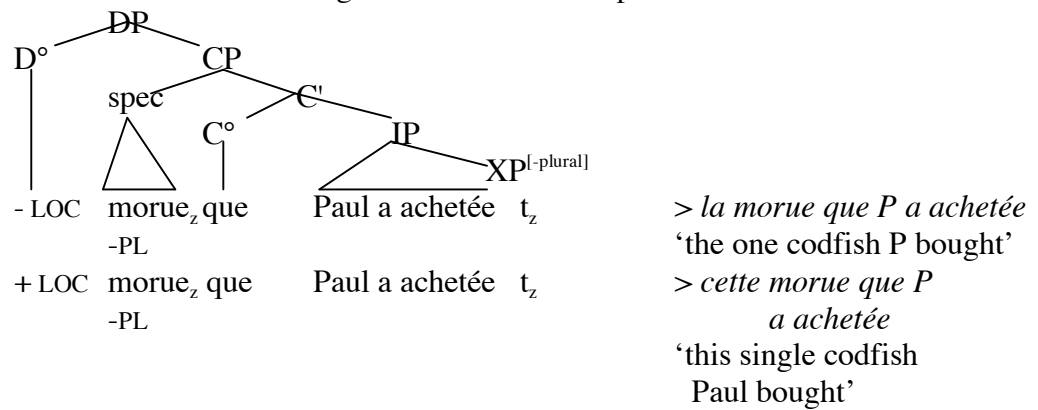

If the relativised phrase is specified for the plural, the resulting noun phrase may, in French as in Haitian, be associated with three different construals of the referent:

- (46) a. French : les morues que Paul a achetées
ANTIPARTITIVE READING: ‘(all of) the codfish items which Paul bought’
 a'. Haitian : mori Pòl achte yo
- b. French : les morues que Paul a achetées
PARTITIVE READING: those of the codfish animals which Paul bought
 b'. Haitian : mori yo Pòl achte
- c. French : ces morues que Paul a achetées
DISCOURSE-LINKED READING: these/those codfish animals which Paul bought
 c'. Haitian : mori yo Pòl achte a

Our assumption is that each of the three readings glossed in (46) is triggered by the same feature pattern in both languages: the upstairs plural has scope over the entire noun phrase and triggers an antipartitive reading; the downstairs plural has scope over the internal noun phrase only and triggers a partitive reading if the upstairs D is [-LOC]; and a [+LOC] feature in the upstairs D triggers a discourse-linking effect:

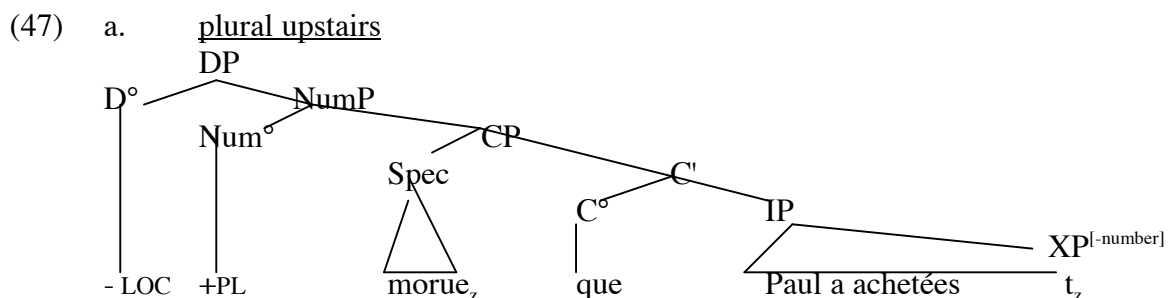

French : *les morues que Paul a achetées* : cf. (46a)
 Haitian : *mori Pòl achte yo* : cf. (29b), (32b)

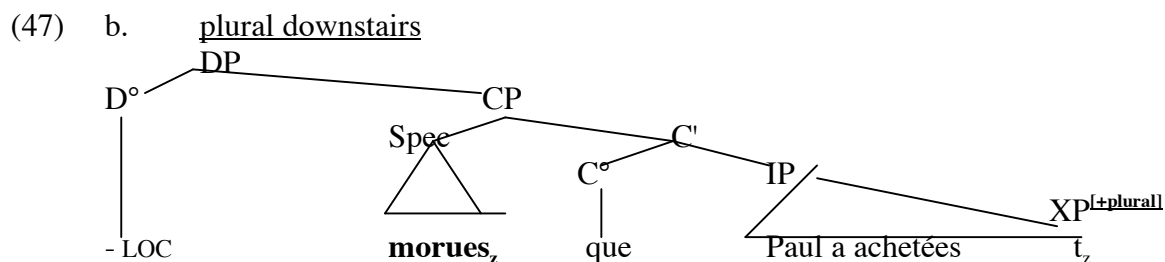

French : *les morues que Paul a achetées* : cf. (46b)

Haitian : *mori yo Pòl achte* : cf.(29a), (32a)

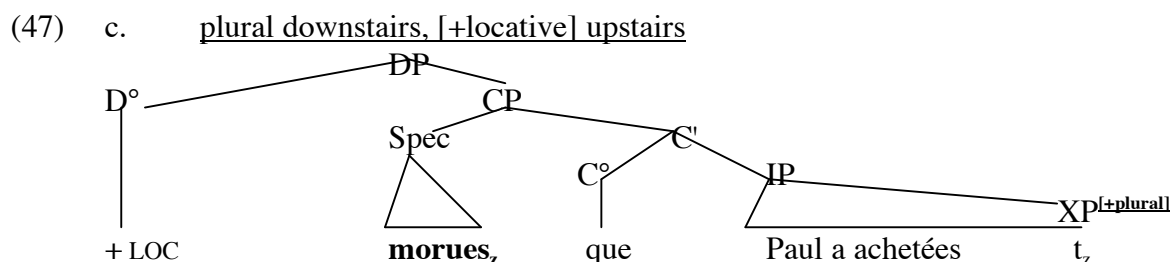

French : *ces morues que Paul a achetées* : cf. (46c)

Haitian : *mori yo Pòl achte a* : cf.(29d), (32d)

Because only one determiner (variable LE or deictic-locative CE) may be spelt out in French within the maximal DP domain, these data contrast with those of Haitian, whose definite determiner LA may overtly occur both upstairs and downstairs. Once passed through the morphological component, Number is externalised upstairs in French whatever its syntactic source (downstairs, or upstairs), hence the homonymous spell-outs of (46a) and (46b), which are morphologically distinguished in Haitian.

5. Conclusions

Our starting point is the assumption that for any functional feature $[\alpha \pm F]$, lack of morphological specification is syntactically ambiguous between feature deficiency $[-F]$ and feature unmarkedness $[-\alpha]$. Moreover, zero morphology may also result from the phonological deletion of a marked feature spell-out. This has crucial bearing on the analysis of 'bare' phrases. We have argued on empirical grounds that in Haitian, a phonologically null D head may instantiate either the zero spell-out of a $[-\text{locative}]$ feature value, or the deleted spell-out of a $[\text{+locative}]$ feature selected by *yo*. It follows that 'bare noun phrases', in Haitian, are all DPs. DP structure however varies as to number specification, since the lack of overt plural marking may instantiate the negative value of functional number — $[-\text{plural}]$, i.e. 'singular' — or number deficiency, which triggers Mass semantic effects. French crucially differs from Haitian in the feature content of its *definite determiner* — a locative item in Haitian, a bound variable in French. As regards number, we have argued that the syntactic ambiguity of the nonplural correlates with the same semantic effects in both languages.

Adapting Kayne's (1994) analysis of restrictively-relativised noun phrases, we have shown that those of Haitian overtly stand as complex structures involving two distinct levels of functional specifications, with each pattern of features triggering its own construal of the referent. Correlatively, a relativised DP may be deficient for some functional feature at one

level, but not at the other. We have argued that a similar analysis may be extended to French, although in this language, contrasting in this respect with Haitian, each maximal DP is limited to one overt D head.

Basing ourselves on the French-Haitian comparative evidence presented above, we feel entitled to conclude that definiteness is neither a feature nor a syntactic category and that the conventional label D identifies neither a syntactic category nor a unique structural position. Furthermore, so-called *bare NPs* do not form a relevant or coherent class from a syntactic perspective, and their description should at least separate determiner deficiency from number deficiency, and syntactic deficiency from phonological deficiency.

¹ We have a huge debt of gratitude towards Marlyse Baptista, Jacqueline Guéron, and Makoto Kaneko, for their helpful comments on earlier drafts of this text. We also thank Karl Gadelii for sharing with us some typological data, and the audience of the Paris ‘DP group’ for their precious stimulus and feedback : N. Boneh, P. Cabredo, A. Daladier, C. Dobrovie, A. Kihm, M.-L. Knittel, S.-N. Kwon, B. Laca, O. Matushansky, J. Roodenburg. The acceptability judgements on Haitian are those of H. Glaude, who was born in 1977 in L’Estère, in the Northern department of Artibonite (where definite LA remains undeleted to the left of plural YO), but lived for ten years in Port-au-Prince (where LA undergoes deletion when followed by YO).

² Determinerless nominal arguments are in fact licensed in French, but only under special conditions, for example under coordination, as shown by Roodenburg (2001, 2003).

³ The *Sample* reading is introduced here in contradistinction with the *Kind* label, which is used in the semantic literature in reference to the interpretations of nominals such as those italicised in (i) :

- (i) a. *Iguanodons* are extinct.
b. *The iguanodon* is extinct.

These noun phrases are however, arguably, syntactically specified for number — [+PL] in (ia), [-PL] in (ib) — and are correlatively construed semantically as plural in (ia) (i.e. as denoting a(n open) set of more than one atomised items) and singular in (ib) (i.e. as denoting a single species-item). What we call the *Sample* reading crucially correlates, like the Pulp reading, with *number deficiency*. Like the Pulp reading, the *Sample* reading ceases to be available if number is syntactically specified in the noun phrase.

⁴ Cf. Zribi-Hertz & Mbolatianavalona (1999) on Malagasy, Schmitt & Munn (2000) and Müller (2001) on Brazilian Portuguese, Song (1975), Jun (1999), Kwon & Zribi-Hertz (2004) on Korean, Chung (2000) on Indonesian.

⁵ The French partitive determiner is also open to what we have called the *Sample* reading, in appropriate contexts, as witnessed by (i) :

- (i) Aujourd’hui je vends de la jolie tomate.
Today 1SG sell *de+DF-F pretty-F* tomato
lit. ‘Today I have pretty tomato to sell.’
= ‘Today I have (some) pretty tomato produce to sell.’

In our view, the Pulp and *Sample* readings ultimately boil down to a single (Mass) semantic construal, characterised by number deficiency.

⁶ These two readings are likely not to exhaust the list of possible semantic effects of number deficiency — an open question. Interestingly, while the Pulp semantic effect associated with French (4b,c) is similarly available in the English translation (*I ate tomato for breakfast – this is why my allergic rash has come out*), the *Sample* semantic effect associated with (3b) in French is not available in *Come and buy my pretty tomato !* — which in the mouth of an English-speaking vegetable grocer seems to require a singular construal of the TOMATO referent.

⁷ Our analysis is but a syntactic phrasing of various ideas put forward in the semantic literature. What Pelletier (1979) calls the *Universal Grinder* boils down — in our terms — to the fact that the Pulp reading is in some languages (e.g. English and French) a productive semantic effect of syntactic Number deficiency. The fact that in such languages, most lexical nouns are a priori open to a Pulp reading (cf. Ware 1979) similarly boils down to the fact that number deficiency is a priori available in syntax, regardless of lexical selection (cf. *I ate little girl for breakfast, I stepped in (mashed up) machine-gun*, etc.). The assumption that the Mass/Count distinction originates in syntax is also explored and formalised by Doetjes (1997) and Borer (2004).

⁸ As pointed out by one referee, the representation given in (5b) runs against two current ideas : (a) the assumption that, for cognitive reasons, number is a necessary ingredient of any denoting nominal argument (cf. Bouchard 2002, 2003); (b) the assumption that so-called mass nouns are pluralised in the lexicon (Chierchia

1998). Under our own analysis, Number deficiency does not stop a noun phrase from denoting; and Mass readings stand as possible semantic effects of syntactic Number deficiency.

⁹ This is a very old and basic linguistic idea, exemplified by a subclass of *neutralisation* situations, in the sense of the Prague School: unvoicedness does not have the same status in a context where the [+voiced] specification is otherwise available, and in one where it is not. The construal of zero morphology as an *unmarked value* — a negatively-specified value — could be the crucial distinction between inflectional features, for which this property obtains, and lexical features, for which it does not.

¹⁰ One might want to object that *the cat* is actually specified as [-plural] in (7b), because it is D-linked to a preidentified CAT referent which is ‘singular’ in the sense that it denotes a single occurrence of cat meat. Note, however, that even in a D-linked context, number specification *blocks* the Pulp reading; thus, in (i) below, the pluralised noun phrase *both cats* forces us to construe in the second sentence at least two (Count) CAT referents from which the (Pulp) cat-meat mentioned in the first sentence was taken:

(i) For breakfast, Mary ate both Siamese cat and Angora cat. *Both cats* were disgusting.

(7b), on the other hand, tells us nothing about the number of cat-creatures which were used to produce the cat-meat. Under our assumption, this contrast directly derives from the fact that *cat* is unspecified for number in (7b) while *both cats* is specified as [+plural] in (i) above. We hence maintain our claim that the Pulp construal of the referent is crucially correlated with number deficiency in syntax. The fact that the CAT referent is construed in (7b) as a ‘single instance’ of cat-meat is due, we believe, to DP-external factors (verbal aspect, in particular).

¹¹ On the syntax of French-lexifier Creoles and of Haitian in particular, see Sylvain 1936, Pompilus (1976), Bernabé (1983, 1987), Bickerton (1981), Chaudenson (1992), Damoiseau (1999), DeGraff (1992, 1999b, 2002), Deprez (2000), Gadelii (1997), Germain 1995, Janson (1984), Joseph (1988), Lefebvre (1998), Valdman (1978), among others.

¹² Depending on phonological context, *la* is spelt out [la], [a], [lā], [nā] or [ã].

¹³ Abbreviations used in our glosses : DF = definite determiner; DM = demonstrative; F = feminine gender; FUT = future tense ; ITSF = intensifier ; LOC = locative ; M = masculine gender; P_{Loc} = locative preposition; PST = past tense; PL = plural; SG = singular; 1, 2, 3 = 1st, 2nd, 3rd person

¹⁴ Cf. for instance Cardinaletti & Starke (1999), Longobardi (1999, 2001).

¹⁵ From now on, we shall systematically delete LA in our Haitian examples whenever it is followed by *yo*.

In this respect, our data instantiate the most ‘advanced’ (also the most widespread) dialectal variety of Haitian.

¹⁶ The semantic contrasts between French and Haitian definite determiners are further developed in Zribi-Hertz (2002) — from a synchronic perspective. For a diachronic approach to Creole determiners, see Hazaël-Massieux (1999). On the bound variable character of the French definite article, see Guéron (1985, 1992, 2003), who focuses on inalienable-possession constructions, and Zribi-Hertz (to appear), who explores the general assumption that French definite articles are topic-bound pronouns.

¹⁷ As pointed out to us by K. Gadelii (p.c.), who draws his data from Goodman (1964), the *LA yo* linear order exhibited by Haitian is not the only attested one in those French-lexifier creoles which recycled a 3PL pronoun as a plural marker; thus, where Louisiana creole has (i-a) (like Haitian), (i-b) is found in Guyanais :

- (i) a. Louisianais
 madam la ye
 woman DF PL
 ‘the women’
 b. Guyanais
 fam ye la
 woman PL DF
 ‘the women’

This dialectal variation may be correlated with the fact that French locative *là* may not only be the DP-internal correlate of the demonstrative determiner, as in (25), but also a DP-external adjunction, as in (ii) below, where we see that it is no longer selected by the demonstrative. In such a case, the two DP-adjunctions, *eux* and *là*, are freely ordered in French :

- (ii) a. {les/ces} chiens, *eux*, *là*, ils aboient trop.
 DF/DM-PL dog-PL 3MPL LOC 3MPL bark too much
 lit. ‘The/those dogs, them, there, they bark too much.’
 b. {les/ces} chiens, *là*, *eux*, ils aboient trop.
 DF/DM-PL dog-PL LOC 3PL 3MPL bark too much
 lit. ‘The/those dogs, there, them, they bark too much.’

¹⁸ In Haitian as in English, the noun *mori* ‘codfish’ easily combines both with [+number] syntax (> ‘one or several codfish (item(s))’, and with [-number] syntax (> ‘codfish meat, pulp or produce’).

¹⁹ We use the term *Definiteness* here as a convenient label referring to whatever functional feature is hosted by the D head. As shown above in section 2, Definiteness has a different feature content in French and in Haitian: in Haitian, *Definiteness* is expressed by a [locative] feature.

²⁰ Examples marked by ‘%’ are syntactically well-formed but unfelicitous in the given discourse context.

²¹ The morphologically unspecified tense in the relative clause may a priori translate into English as a generic present (‘buys’), a present perfect (‘has bought’) or a preterit (‘bought’). We have chosen to associate a generic-present translation with unspatialised relativised noun phrases, and a preterit or present perfect translation with noun phrases including a spatialiser at one level and/or the other. Hence, the translations we propose for the Haitian examples hardly ever exhaust all possible interpretations.

²² Functional number (the \pm plural contrast) must be distinguished from lexical number, as expressed by cardinals. If a cardinal occurs, D ceases to be required, as witnessed by the Haitian examples in (16), which are paralleled in French :

- (i) a. Paul a acheté deux vaches.
‘Paul bought two cows.’
b. Paul a acheté les deux vaches.
‘Paul bought the two cows.’

²³ This is a consequence of the phonological deletion of word-final consonants which started out in Old French and was finalised in the 17th century. Due to this phonological event, the plural ending *-s* fails to be pronounced on most nouns in Modern French, whence plural marking is only audible on determiners — e.g. *les*, pronounced [le] or [lɛ]. This *phi-feature externalisation* requirement contributes to account for the fact that the distribution of determinerless noun phrases is far more restricted in French than in, e.g., English, or other Romance languages. Although some modern authors seem to attribute it to Delfitto & Schroten (1991), this correlation goes back to French traditional grammarians (cf. Wagner & Pinchon 1962).

²⁴ The raised XP may be Number Phrase, as in (i), (ii), or a [-number] phrase construed as a Mass existential indefinite, as in (iii). Whether the necessary adjustments made explicit in (ii-b) and (iii) pertain to syntax or morphology is an open issue:

- (i) a. Marie a acheté *deux chiens*.
‘Marie bought two dogs.’
b. les [*deux chiens*] que Marie a achetés *t*
‘the two dogs that Marie bought’
(ii) a. Marie a acheté *un chien*.
‘Marie bought a dog.’
b. le [*(*un) chien*] que Marie a acheté *t*
the (*a) dog that Marie bought
(iii) a. Marie a eu *du mal* à le trouver.
‘Marie had trouble finding it’
b. le [*(*du) mal*] que Marie a eu *t* (à le trouver)
the DU trouble that M. had finding it

²⁵ The interpretation of the bracketed noun phrase in (43a) is sensitive to the aspectual construal of the present tense, which in French may or may not be anchored to the Utterance Time (cf. English *buys* vs. *is buying*).

²⁶ Following Zribi-Hertz (2002), we assume that the French demonstrative determiner *is*, like the definite article, generated in the D-head, rather than in some specifier position.

References

- Aboh, E.O. 2002. « La morphosyntaxe de la périphérie gauche nominale. » *Recherches Linguistiques de Vincennes* 31 : 9-26.
- Bernabé, J. 1983. *Fondal-Natal : Grammaire Basilectale Approchée des Créoles Guadeloupéen et Martiniquais*. Paris : L'Harmattan.
- Bernabé, J. 1987. *Grammaire Créole – fondas kréyol-la*. Paris: L'Harmattan.
- Bickerton, D., 1981. *Roots of Language*. Ann Arbor : Karoma
- Borer, H., 2004, *Structuring Sense*. Oxford : Oxford University Press.
- Borsley, R. 1997. « Relative clauses and the theory of phrase structure. » *Linguistic Inquiry* 28-4 : 629-647.
- Bouchard, D. 2002. *Adjectives, Number, and Universal Grammar*. Oxford : Elsevier Science.

-
- Bouchard, D. 2003. « Les SN sans déterminant en français et en anglais. » In *Essais sur la Grammaire Comparée du Français et de l'Anglais*, P. Miller & A. Zribi-Hertz (eds.), 55-95. Saint-Denis, France: Presses Universitaires de Vincenne.
- Chaudenson, R. 1992. *Des Iles, des Hommes, des Langues: Essai sur la Créolisation Linguistique et Culturelle*. Paris: L'Harmattan.
- Cardinaletti, A. and Starke, M. 1999. « The typology of structural deficiency : a case study of the three classes of pronouns. » In *Clitics in the Languages of Europe*, H. van Riemsdijk (ed.), 145-233. Berlin: Mouton-De Gruyter.
- Cherchia, G. 1998. « Reference to kinds across languages ». *Natural Language Semantics* 6: 339-405.
- Chung, S. 2000. « On reference to kinds in Indonesian. » *Natural Language Semantics* 8-2:157-171.
- Damoiseau, R. 1999. *Éléments de Grammaire Comparée Français-Créole*. Petit-Bourg, Guadeloupe: Ibis Rouge Editions.
- DeGraff, M. 1992. *Creole Grammars and the Acquisition of Syntax: the Case of Haitian*, unpublished doctoral dissertation, University of Pennsylvania.
- DeGraff, M. 1999a. *Language Creation and Language Change: Creolization, Diachrony and Development*. Cambridge MA: MIT Press.
- DeGraff, M. 1999b. « Creolization, language change, and language acquisition. » In DeGraff (1999a), 1-46.
- DeGraff, M. 2002. « Morphology in creole genesis. » In *Ken Hale: a Life in Language*, M. Kenstowicz (ed.), 53-121. Cambridge MA: MIT Press.
- Delfitto, D. and Schrotten, J. 1991. « Bare plurals and the number affix in DP. » *Probus* 3-2 : 155-185.
- Déprez, V. 2000. « Parallel (a)symmetries and the internal structure of negative expressions. » *Natural Language & Linguistic Theory* 18-2:253-342.
- Doetjes, Jenny. 1997. *Quantifiers and selection*, The Hague: HIL
- Gadelii, K.E. 1997. *Lesser Antillean French Creole and Universal Grammar*. Doctoral dissertation : Göteborg University.
- Germain, R. 1995. *Grammaire Créole*. Paris : L'Harmattan.
- Goodman, M.F. 1964. *A Comparative Study of Creole French Dialects*. The Hague: Mouton.
- Guéron, J. 1985. « Inalienable possession, PRO-inclusion and lexical chains ». In *Grammatical Representation*, J. Guéron, H. Obenauer and J.-Y. Pollock (eds.), 43-86. Dordrecht : Foris.
- Guéron, J. 1992. « La possession inaliénable et l'aspect locatif. » In *De la Musique à la Linguistique. Hommages à Nicolas Ruwet*, L. Tasmowski and A. Zribi-Hertz (eds.), 255-272. Ghent : Communication & Cognition.
- Guéron, J. 2003. « Inalienable Possession and the interpretation of determiners. » In *From NP to DP*, volume 2: *On the Expression of Possession*, M. Coene and Y. D'Hulst (eds), 189-220. Amsterdam-Philadelphia: John Benjamins Publishing Company.
- Hazaël-Massieux, G. 1999, « Marking specificity in Antillean Creole French. » In *St Kitts and the Atlantic Creoles*, P. Baker & A. Bruyn (eds.), 271-288. University of Westminster Press : Westminster Creolistic Series 4.
- Janson, T. 1984. « Articles and plural formation in creoles: change and universals. » *Lingua* 64 : 291-323.
- Joseph, F. 1988. *La Détermination Nominale en Créole Haïtien*. Unpublished dissertation, Université Paris-7.
- Jun, J.-Y. 1999. *Recherches sur le Nombre en Coréen : Syntaxe, Sémantique et Morphologie*. Unpublished dissertation, Université Paris-8.

-
- Kayne, R. 1994. *The Antisymmetry of Syntax*. Cambridge MA: MIT Press.
- Lefebvre, C. 1998. *Creole Genesis and the Acquisition of Grammar: the Case of Haitian Creole*. Cambridge: Cambridge University Press.
- Kwon, S.-N. and Zribi-Hertz, A. 2004. « Number from a syntactic perspective : why does plural marking look ‘truer’ in French than in Korean? » In *Empirical Issues in Formal Syntax and Semantics 5 : Selected Papers from CSSP 2003*, O. Bonami & P. Cabredo Hofherr (eds.), <http://www.cssp.cnrs.fr>.
- Longobardi, G. 1999. « The structure of DPs: some principles, parameters and problems ». In *Handbook of Syntactic Theory*, M. Baltin and C. Collins (eds.). London: Blackwell.
- Longobardi, G. 2001. « Formal syntax, diachronic minimalism, and etymology: the history of French *chez*. » *Linguistic Inquiry* 32-2: 275-302.
- Lyons, C. 2000. *Definiteness*. Cambridge :Cambridge University Press.
- Meillet, A. and Vendryès, J. 1979. *Traité de Grammaire Comparée des Langues Classiques*, 5th printing revised by J. Vendryès. Paris : Champion.
- Milner, J.-C. 1989. *Introduction à une Science du Langage*. Paris : Seuil.
- Muller, C. 1996. *La Subordination en Français: le Schème Corrélatif*. Paris : Armand Colin.
- Müller, A. 2001. « Genericity and the denotation of common nouns in Brazilian Portuguese. » In *The Proceedings of the SULA : the Semantics of Under-Represented Languages in the Americas*, UMOG 25, A. Weerle and J.-Y. Im (eds.), 72-80. Amherst MA : The University of Massachusetts.
- Pelletier, F. 1979. « Non-singular reference : some preliminaries. » In *Mass Terms : Some Philosophical Problems*, F. Pelletier (ed.), 1-14. Dordrecht : Reidel.
- Pompilus, P. 1976. *Contribution à l'Etude Comparée du Créole et du Français – à partir du Créole Haïtien. Morphologie et Syntaxe*. Port-au-Prince: Editions Caraïbes.
- Roodenburg, J. 2001. « Les "noms nus" en français contemporain: quelques problèmes. » In *6^{èmes} Rencontres de l'Atelier des Doctorants de Linguistique*, E. Aïm and al. (eds.), 125-130. Université Paris-7 : Département de Recherches Linguistiques.
- Roodenburg, J. 2003. “The interpretations of coordinated bare nouns in French.” In *Proceedings of ConSole XI*, M. van Koppen, J. Sio and M. de Vos (eds.), 1-15. University of Leiden.
- Smith, C. 1964. “Determiners and relative clauses in a generative grammar of English.” *Language* 40-1: 37-52.
- Schmitt, A and Munn, C. 2000. « Bare nominals, morphosyntax, and the Nominal Mapping Parameter. » Unpublished manuscript. Michigan State University.
- Song, S.-C. 1975 « Rare plural marking and ubiquitous plural marker in Korean. » In *Papers from the Eleventh Regional Meeting of the Chicago Linguistic Society*, R. Grossman, L. J. San & T. Vance (eds.), 536-46. Chicago : Chicago Linguistic Society.
- Sylvain, S. 1936. *Le Créole Haïtien, Morphologie et Syntaxe*. Belgium : Wetteren.
- Valdman, A. 1978. *Le Créole : Structure, Statut et Origine*. Paris: Klincksieck.
- Vendler, Z. 1967. *Linguistic and Philosophy*. Ithaca NY: Cornell University Press.
- Vergnaud, J.-R. 1985. *Dépendances et Niveaux de Représentation en Syntaxe*. Amsterdam/Philadelphia: John Benjamins.
- Wagner, R.-L. and Pinchon, J. 1962. *Grammaire du Français Classique et Moderne*. Paris:Hachette.
- Ware, R. 1979. « Some bits and pieces. » In *Mass Terms : Some Philosophical Problems*, F. Pelletier (ed.), 15-29. Dordrecht : Reidel.

-
- Zribi-Hertz, A. and Mbolatianavalona, L. 1999. « Towards a modular theory of linguistic deficiency: evidence from Malagasy personal pronouns. » *Natural Language & Linguistic Theory* 17-1 : 161-218.
- Zribi-Hertz, A. 2002. « The DP hypothesis and the syntax of identification. » *Recherches Linguistiques de Vincennes* 31 : 127-142.
- Zribi-Hertz, A. to appear. « La syntaxe de l'article défini: de la structure à l'interprétation ». In *Modèles Syntaxiques*, special issue of *Travaux de Linguistique*, D. Van Raemdonck (ed.). Gembloux, Belgium : De Boeck-Duculot.