



**HAL**  
open science

## Innovation in services: theoretical issues.

Faïz Gallouj

► **To cite this version:**

Faïz Gallouj. Innovation in services: theoretical issues.. [Research Report] Université Lille 1, CLERSE. 1998. halshs-01113047

**HAL Id: halshs-01113047**

**<https://shs.hal.science/halshs-01113047>**

Submitted on 4 Feb 2015

**HAL** is a multi-disciplinary open access archive for the deposit and dissemination of scientific research documents, whether they are published or not. The documents may come from teaching and research institutions in France or abroad, or from public or private research centers.

L'archive ouverte pluridisciplinaire **HAL**, est destinée au dépôt et à la diffusion de documents scientifiques de niveau recherche, publiés ou non, émanant des établissements d'enseignement et de recherche français ou étrangers, des laboratoires publics ou privés.

**UNIVERSITY OF SCIENCE AND TECHNOLOGY OF LILLE**  
**Faculty of Economics and Sociology**

**INNOVATION IN SERVICES:**  
**THEORETICAL ISSUES**

**Faïz GALLOUJ**

**CLERSE-IFRESI**

**July 1998**

**REPORT FOR THE EUROPEAN COMMISSION DG XII TSER-  
SI4S PROJECT**

**CONTENTS**

<b>Introduction.....</b>	<b>3</b>
<b>Paper 1: Innovation in services and the attendant myths.....</b>	<b>4</b>
<b>Paper 2: Neo-schumpeterian perspectives for innovation in services: a survey (with Camal Gallouj).....</b>	<b>17</b>
<b>Paper 3: Beyond technological innovation: trajectories and varieties of services innovation.....</b>	<b>38</b>
<b>Paper 4: Innovating in reverse: services and the reverse product cycle.....</b>	<b>58</b>
<b>Paper 5: Innovation as a loosely coupled system in services (with Jon Sundbo).....</b>	<b>81</b>
<b>Paper 6: Innovation in services (with Olivier Weinstein).....</b>	<b>102</b>

## INTRODUCTION

This report consists of six independent papers given over to different theoretical issues regarding innovation in services. All these papers were written as part of the TSER-SI4S project. They are either based upon empirical materials gathered during the project or they feed it with theoretical background and literature survey.

The first paper (« Innovation in services and the attendant myths ») raises the following question: « is service innovation special? ». It looks into the nature and the origin of different old or new myths concerning services and innovation in services (the myth of the residual sector, the myths of low productivity and low capital intensity, the myth of the servant society, the myth of lack of innovation, etc.).

The second paper (« Neo-schumpeterian perspectives for innovation in services: a survey » with Camal Gallouj) and the third one (« Beyond technological innovation : trajectories and varieties of services innovation ») are devoted to a survey of the literature on innovation in services. Paper 2 examines services from the perspectives of neo-Schumpeterian theories of innovation. Its goal is to look to what extent neo-Schumpeterian analyses help take into account innovation in services. Paper 3 aims at displaying the variety of forms and trajectories of innovation in services, beyond technological innovation. It classifies the attendant literature into two categories:

- service-oriented analyses, focusing on service specificities;
- integrated approaches aiming at designing analyses and theories of innovation suitable for both goods and services.

The three other papers are given over to the deepening of certain theoretical issues raised previously.

The fourth paper (« Innovating in reverse: services and the reverse product cycle ») proposes an assessment of Barras' model both at a theoretical level and on the basis of the empirical materials gathered during the SI4S project.

The goal of the fifth paper (« Innovation as a loosely coupled system in services » with Jon Sundbo) is to assess whether innovation in services can be described as a steady and coherent system. It displays and analyses different models of innovation organisation in services.

The last paper (« Innovation in services », with Olivier Weinstein) aims at laying the foundations of a theory of innovation in services on the basis of the definition of the product or service as a system of characteristics.

**PAPER 1:**

**INNOVATION IN SERVICES AND THE  
ATTENDANT MYTHS**

Published in the Journal of Socio-economics. Gallouj F. (2002), Innovation in services and the attendant old and new myths, Journal of socio-economics, Vol. 31, p. 137-154.

## INNOVATION IN SERVICES AND THE ATTENDANT MYTHS<sup>1</sup>

(Published in the Journal of Socio-economics. Gallouj F. (2002), Innovation in services and the attendant old and new myths, Journal of socio-economics, Vol. 31, p. 137-154.)

**Faiz Gallouj**

### **Summary:**

*Although service activities now account for the greater share of wealth and employment in developed economies, they are still perceived negatively. Once described as residual activities characterised by low productivity, low capital intensity and low skill levels, they are now regarded as lacking in innovative capacity. This article examines these myths and their origins. Innovation in services exists, although it has to be accepted that it may possibly take different forms and be organised differently. Nevertheless, against a background of convergence between a manufacturing sector that is becoming increasingly service-oriented and a service sector that is gradually becoming industrialised, it would be wrong to conclude that there is an irreconcilable opposition between goods and services when it comes to innovation; rather, there are opportunities for mutual enrichment.*

### **INTRODUCTION**

In many ways, thinking on services resembles the strivings of the sultan of the fable, who persisted in looking for the keys to his palace under a lantern and not where he had lost them.

It is economic theory that takes the place of the lantern here. This lantern, which for a long time shed light (and a good deal of illumination as well) on our economies, with their roots in agriculture and manufacturing, leaves the service sector in darkness. Thus services constitute the dark side of the economy and of economic theory. Like the medieval forest, it is a dangerous place to venture into. It is the troubling world of myths and legends: a residual world, a “third world”, that of the intangible and inexpressible. Its inhabitants are

---

<sup>1</sup> We take our inspiration here from the title of an article published by Michel Callon (1994), from which we also borrow the following definition: “Myth: simplified, frequently illusory image that groups of human beings develop or accept in respect of an individual or phenomenon and that plays a decisive role in determining their behaviour or judgement”.

unproductive and estranged: it is the world of priests and “servants”, an unchanging universe, resistant to innovation.

Services now account for more than seventy percent of employment and GDP in most developed countries. As a result, the lantern of economic theory now casts its beam on only 30% of economic activity, thereby condemning the essential source of jobs and wealth in all developed countries to languish in darkness. Furthermore, the edge of the forest is no longer clearly defined. The world of manufacturing is increasingly inhabited by creatures of darkness and that of services by tangible entities.

The purpose of this article is to investigate some of the myths about services and innovation in services. The second group are derived to a large extent from the first. What is clear even before we begin is that any researcher as any sultan wishing “to find the key” has no choice but to move his lantern in order to cast his light on the object of his research.

## **1. SERVICES: THE DARK SIDE OF THE ECONOMY?**

According to this first generic myth, which has its roots among the founders of political economy, the service sector is the dark side of the economy, the one that is of little if any interest and that the lantern of economic theory can do little to illuminate. It is said to be a world inhabited by shadows, by incorporeal entities (“intangible products”), by frequently servile individuals who evade the traditional economic tools (productivity) or, more precisely, perform miserably when measured by them or do not even deserve to be taken into consideration by them. It is the world of those who are said to produce nothing (useful): in former times, that of priests and of servants, today that of pizza delivery services and “hot-air salesmen”: consultants ... and professors. This world of night, of darkness and shadows, is said to constitute a permanent danger for the world of day, which it seeks or helps to smother. This danger has a name: deindustrialisation.

### **1.1 The myth of the residual sector**

In this respect, economists have adopted the same attitude as the primitive peoples described by anthropologists. For an economic theory that had its roots in agriculture and manufacturing, services could only be defined as “that which is neither agriculture nor manufacturing”. Thus the world of those who produce (men or free men) was opposed to the “rest”: that of those “who produce nothing” (the non-humans).

Thus everything located beyond the light shed by the lantern was termed residual. Other descriptions were used to supplement this one: services were said to be “peripheral”, while goods were the “driving forces” in the economy. They were described as pathological, as malign cells that tended to proliferate and smother a hypertrophied metabolism (Attali, 1981).

As is so often the case, it then became necessary to construct, a posteriori, an argument to justify this condemnation. As with many of the great conquests in human history, it was necessary to legitimate the bad treatment meted out to the “vanquished” (i.e. services), by using criteria derived from (frequently) provisional findings to erect a theory, which was subsequently elevated to the status of a natural law. These justifications were essentially observations that threw a negative light on services (compared with manufacturing). Thus

services were characterised as the world of “that which is not ...” (productive, capital-intensive, innovative ...). Like all myths, the ones thus forged have proved durable, even if they are refuted by the facts.

## **1.2 The myths of low productivity and low capital intensity**

These two myths are closely linked. Services have long been thought to be characterised by low capital intensity, in that they do not require the construction of factories and large-scale production lines. They are also said to be characterised by low productivity. The (increasing) introduction of technical systems into service activities has done little to change this perception. Indeed, services are allegedly suffering from a new syndrome, namely Solow’s paradox, in which an increase in technical change is said to be accompanied by a simultaneous stagnation of productivity.

Studies by Kutscher and Mark (1983) and then Roach (1988) in the United States helped to refute this myth of the low capital intensity of services. Some of these service activities have for a long time been closely linked to heavy technologies (transport of fluids and commodities: energy provision, air, rail and road transport services), while others are now acknowledged as the main users of information and telecommunications technologies (codified data processing services: banking, insurance, etc.). As far as low productivity and Solow’s paradox are concerned, it may very well be that it is our instruments of measurement that are at fault. Our definitions of productivity were developed in and for the world of manufacturing (Gadrey, 1996a). They are unable to take account of those incorporeal creatures that inhabit the “services forest”, beyond the pale of the light cast by conventional economic theory.

Paradoxically, some studies acknowledge the role of technologies in services only to sound the death knell of the “service society” and replace it with a “self-service” society, in which consumers reject market services in favour of domestic production based on a technological system. For Gershuny (1978) and Gershuny and Miles (1983), technology and material artefacts (cars, washing machines, televisions etc., currently already, but to an even greater extent, in the future, computer-assisted teaching and medical diagnosis) make it possible to rescue some activities (public transport, laundries, cinemas, educational and medical services ...) from obscurity and subject them to scrutiny under the lantern of economic theory. This use of technological systems in the domestic sphere is, paradoxically, christened “social innovation”.

## **1.3 A society of servants or a society of engineers?**

This is the myth that service activities do indeed create jobs but that those jobs are deskilled. At best, workers in such activities are the “servants” of machines (standardised recording tasks), at worst they are the “servants” of other people, as intolerably servile as villeins under the feudal system. Thus from this point of view, the service society is a “society of servants” (Gorz, 1988), in which the new aristocracy armed with service cheques subjugate their fellow creatures by offering them low-grade domestic jobs. Again, this is a myth that has its idyllic counterpart, namely the myth of the “post-industrial society” (Bell, 1973). In accordance with Engel’s law, post-industrial society allegedly constitutes a new stage in human progress, based on the production and consumption of services and the pre-eminence of a higher, white-



collar tertiary sector. In reality, while it is true that the service society creates low-skill jobs, it is equally true that it is now the principal employer of managers, engineers and other professionals (who form the bulk of recruits in “high-level” services).

## **2. THE MYTH OF THE SPECIFICITY OF SERVICES?**

The “general” or “macroeconomic” myths outlined above are nourished by the idea that services are intrinsically “different” (from manufacturing). This is to some extent true. In reality, however, the situation is much less clear-cut. Let us examine briefly what it is that constitutes the (relative) specificity of services.

Once it is manufactured, a good usually acquires an autonomous physical existence. It enjoys a high level of exteriority vis-à-vis the person who made it and the person who is going to consume it.<sup>2</sup> Services are, in general, intangible and do not possess that quality of exteriority. They are consubstantial with those producing them and with those consuming them (they cannot be held in stock). They seldom exist outside of these individuals. They are not a given outcome, but rather an act or a process. By developing the metaphor of the “service triangle”, Gadrey (1996b) has helped to bring into widespread use the definition of a service as a set of processing operations carried out by a provider (B) on behalf of a client (A) in a medium (C) held by A and intended to bring about a change in the medium C.

Most of the difficulties outlined below are linked. Nevertheless, they are presented separately in order to facilitate analysis and to allow slight differences to be taken into account.

### **2.1 The problems of product standardisation**

In service activities, the “product” is not always completely “formatted” or codified, i.e. precisely defined in advance of being delivered. However, this is also true in a way of some custom-made material goods: spectacles, for example, are usually made to a set of highly personal specifications.

Each service transaction is in a way unique since it is produced *interactively* with clients, in response to particular (non-standardisable) problems they have and in an environment that is always different. Of course, this infinite diversity of possible forms taken by the “product” in response to the wide variety of customer needs should not be confused with the particular variation known as innovation. The first is random, ephemeral and unintentional, while the second is generally intentional. It lies above the threshold of visibility and can be isolated. In sum, it adds to system variety.

### **2.2 A product that manifests itself through its effects over time**

The “product” supplied by a service provider may manifest itself through the effects it produces over a longer or shorter period of time (although this is also true, to a certain extent,

---

<sup>2</sup> unless it is a custom-made product that cannot be easily transferred to another user (spectacles, machine tools, customised software etc.).

of spectacles, which help to maintain or even improve visual acuity). In order to take account of this characteristic, Gadrey (1991) proposes that a distinction should be made between:

- the direct or immediate "product" (the actual delivery of the service) : e.g. a consultation with a doctor or lawyer, a visit to a garage, etc.
- and the indirect or mediate "product" (the subsequent results, whether expected or not) : change in the state of health, legal situation, working order of vehicle, etc.

### 2.3 The question of the service relationship

One of the fundamental characteristics of service activities, particularly "knowledge-intensive" ones, is client participation (in various forms) in the production of the service. Various concepts have been developed in order to take account of this client involvement. They are sometimes used synonymously. In reality, they denote different aspects of the same phenomenon, and can be differentiated from each other by their theoretical substance.

Thus the term **interface** denotes the meeting or contact point between customer and service provider. It frequently refers to a physical place: a window in a ticket office, a restaurant or an office. However, the contact can equally well take place on the telephone. In general, the term denotes contact between individuals or groups of individuals. However, it may also denote contact between the customer and the technologies used by the service provider (e.g. a bank cash dispenser or a ticket or stamp machine).

It is at this interface that the **interactions** between customer and service provider take place, i.e. that various elements are exchanged. These exchanges may involve information or knowledge, emotions, verbal or gestural civilities or the performance of repair or rectification tasks. This interaction which relates to various elements may vary in intensity. It also reflects the balance of power between and the influence exerted on each other by client and service provider. The term **co-production** generally denotes situations in which the (essentially operational) interaction is intensive and balanced.

The three other terms ("servuction", socially regulated service relationship and service relationship) have acquired the status of theoretical concepts. In management sciences, the neologism "**servuction**" denotes the process whereby a service is produced (Eiglier, Langeard, 1987). The "servuction" system takes account of the relations between the following elements: the client, the physical medium, the contact personnel, the service, the system of internal organisation and other clients. The notion of **socially regulated service relationship** (Gadrey, 1991) considers services from the point of view of the social rules that control the relations between agents involved in service situations. The term **service relationship** (de Bandt, Gadrey (eds.), 1994) is defined as a "mode of coordinating the actors on the supply and demand sides", whether for services or for goods. This service relationship comprises, on the one hand, operational relations or interactions (co-production) and, on the other, the social relations that control and regulate (by contract or convention) the action in question.

### 2.4 The difficulty of distinguishing between product and process in services

In the case of goods, the distinction between product and process, which is a useful analytical tool, though sometimes difficult to use, is widely accepted. The same is certainly not true of

services. Here, the term “product” frequently denotes a process: a service package, a set of procedures and protocols, an “act”. In reality, this use of the term depends on the concept of product tacitly accepted by the protagonists in question. If they understand the product to be analogous with the immediate act of providing a service, then it is more or less synonymous with it.

## **2.5 The importance of informational asymmetries**

In the case of services, and particularly those in which the intangible and relational aspects are important, the correspondences between the competences brought to bear by the service provider and the "product" are generally much hazier and more difficult to codify: they are to a large extent tacit and subject to problems of informational asymmetry. For these reasons (and others), it is not always possible to restore a service to its proper or former state once it has been provided.

## **3. INNOVATION IN SERVICES: THE MYTHS**

The generic myth here is that of the inability of services to produce innovation. Just as they are considered to be unproductive and of low capital intensity, so services are said to be incapable of innovating or to confine themselves to adopting technological innovations originating in manufacturing industry. Nothing could be further from the truth. A myth of this kind can cause serious difficulties in an economy dominated by services, since it precludes serious thought (particularly on the part of the public authorities) about ways of energising an area of activity of great importance for the future of firms, industries and nations.<sup>3</sup>

### **3.1 Innovation does not exist: the origins of a myth**

In reality, this generic myth can take a number of different forms, according to which:

- innovation in services simply does not exist;
- innovation in services is strictly technological and adopted;
- innovation in services is incremental and insignificant.

The explanations for this refusal to acknowledge the existence of innovation are to be found in the myths outlined above (in which services are perceived to be the “dark side” of the economy). In fact, if it is accepted that innovation has a positive connotation and if, as economists claim, it is the engine of growth, it would be paradoxical for a residual, peripheral sector that was not a driving force in the economy to be capable of it. Furthermore, if what is being sought in the world of intangible products are innovations in the sense of physical goods, then it is highly likely that the quest will be in vain.

In other words, these myths have their origins in the manufacturing and technological bias of our analytical apparatus. In neo-classical economics, the question of innovation is perceived

---

<sup>3</sup> For a more comprehensive analysis of these various myths and of the studies of innovation in services cf. F. Gallouj (1994a) and C. Gallouj and F. Gallouj (1996).

through the concept of the production function and is limited to process innovation (as incorporated into technical equipment). From this perspective, it is but a short step to reduce innovation in services to the mere adoption of technical equipment produced by the only driving force capable of innovation in the economy, i.e. manufacturing industry.

More modern economic analyses (based on evolutionary and neo-Schumpeterian approaches), which are more sensitive to the characteristics of the “black box” of the firm, i.e. to learning phenomena and the mediums through which they are enacted (routines) and to the tacit and idiosyncratic aspects of technologies, and more inclined to accept a broader definition of innovation, have not succeeded in ridding themselves of this technological bias. In such analyses, services are dominated by the suppliers of their technical equipment.

It is of course possible to find circumstances that attenuate the second myth, that “innovation in services is strictly technological and adopted”. In the past few years, services have indeed become the main users of information technologies, which of course modifies the “services landscape” and raises extremely important theoretical and empirical questions (concerning in particular the consequences of the introduction of these technologies for employment, productivity, trade, work organisation, skill requirements, etc.). The fact that this phenomenon is important both in itself and in terms of its consequences should not blind us to other manifestations of innovation in service activities.

There are far too many studies by economists, sociologists and management specialists that claim to tackle the question of innovation in services by reducing it to the impacts of adopted technologies for there to be any possibility of examining them all here. We will confine ourselves to mentioning the most successful of these attempts, namely Barras’ reverse cycle model (Barras, 1986). According to this model, the dynamic of innovation in services follows a life cycle (the reverse of the traditional industrial cycle) in which the introduction of technical systems is followed by sequential phases of incremental process innovations, radial process innovations and “product” innovations.<sup>4</sup> In the case of banking, for example, the life cycle would begin with the computerisation of back-office tasks, continue with the introduction of automatic cash dispensers and lead ultimately to home banking.

This generic myth of the non-existence of innovation has certain corollaries that it is important to emphasise. Services are, allegedly, as unacquainted with R&D as they are with innovation, despite the large number of engineers and managers now employed in service industries. And the proof is that national and international indicators of R&D and innovation (the Frascati and Oslo manuals, for example) almost completely ignore services.<sup>5</sup>

### **3.2 Innovation in services does exist: we’ve all experienced it**

Innovation in services does exist. Each one of us has already experienced it, when travelling by plane, eating in a McDonalds or a restaurant operated by the Sodexo group, spending a night in a Travelodge hotel, ordering a pizza from a home delivery service, taking a Club Med holiday or waiting for the bus under a J.-C. Decaux bus shelter. However, it can take different forms and be organised differently. Moreover, some services (notably the most knowledge-intensive ones), not content with being innovative themselves, have exacted the ultimate

---

<sup>4</sup> For a critical analysis of this model see F. Gallouj (1997).

<sup>5</sup> It is by no means unusual for economic theory to consider that that which it is unable to measure does not exist.

retribution on behalf of the “world of night” by playing an important role in their clients’ innovation processes (particularly those in manufacturing industry).

Thus the trend towards deindustrialisation can be considered in a less negative light. If services are expanding, it is perhaps also because they are (more) innovative and because, in accordance with the Schumpeterian notion of waves of creative destruction, relatively non-innovative structures are giving way to more innovative structures.

### *3.2.1. It can take different forms*

Drawing once again on the wisdom of fables, economic theory might be said to resemble the blind shepherd whose only memory is that of a sheep and who reduces every discussion to the following question: does it look like a sheep?

It is no more possible to reduce the various forms of innovation to technological innovation than it is to apprehend the world in all its diversity using just a sheep as a yardstick. Just like manufacturing industry, the service sector is a locus for product, process, organisational and market innovations. Even so, it still has to be accepted that the semantic content of each of these types of innovation should not be unduly inflexible (Gallouj, 1994a; C. and F. Gallouj, 1996).

Although it is playing an increasingly important role in services, (material) technology is not an inevitable component of innovation. Innovation can and frequently does take place without the use of technology (a new form of insurance policy, new financial instruments, a new area of legal expertise, a new restaurant format<sup>6</sup>, etc.) This does not mean that these innovations are not or cannot be based on a material technology (computer or telecommunications systems, for example) but that they may in certain cases dispense with them. Not to accept this is seriously to underestimate the innovative capacity of service activities. The silence of national and international indicators of R&D and innovation can be explained by this mistake. It is not that service activities are incapable of R&D and innovation but rather that these highly “technologist” indicators are unable to capture what actually happens in service industries (the inevitable, and by now very familiar lantern...). Under these circumstances, it is hardly surprising if it is really only innovation in IT services that is properly reflected in these indicators.

Like product innovation, process innovation can be intangible. It can consist of methods, that is it can be like the text of a play or the screenplay for a film that defines the words, action and movements of each individual involved (consultants’ procedures, or the methods employed in catering). Some of these methods might be based on technical systems (computerisation of recruitment methods), while others might be embodied in tools (legal expert systems), but this is not a necessary condition for innovation. In other words, it would be wrong to take the view that innovation takes place only when it is embodied in a technical system.

This intangibility (and this non-technological dimension), as well as the importance of the service relation, mean that it can be difficult to appropriate and protect innovation in services. In our view, however, they do offer at least one advantage. Since they are to some extent free of material and technical contingencies, services might be said to constitute the last bastion of innovation produced by “romantic improvisation” (a notion that M. Callon (1994) denounces

---

<sup>6</sup> Michel Callon (1995) supplies a nice example.

as one of the great myths of technological innovation). The simplest ideas can still lead to the creation of economic empires. There are numerous examples, ranging from pizza delivery services via home help services for the elderly to travel arrangements for tourists.

Product and process innovation are much more difficult to separate from each other in services than in manufacturing. As we have already stressed, a service is not an artefact but a protocol, a formula, a process developing over time and leading to the provision of a “product”.

Services have also to be regarded in the wider social context. They are socially embedded. The notion of “diversity of worlds” developed by advocates of the “*convention*” approach (Boltanski and Thévenot, 1991)) can perhaps be applied more usefully to services than to any other economic activity in order to explain the multiple forms that innovation can take (Gallouj, 1997). More than any other sphere of the economy, the service sector is characterised by a multiplicity of competing and frequently ambiguous “levels of justification” (reference worlds). This tension, which is the source of the wide diversity of explicit and implicit products, can be interpreted in various ways. Firstly, the medium through which many services are enacted is highly specific, involving individuals or groups of individuals whose lives, with their domestic, civic and economic dimensions, are multifaceted. Secondly, one of the most important elements of the tertiary sector is the large number of activities in which the civic “level of justification” plays, or is supposed to play, a central role, i.e. public and social services.

Thus service activities are the locus for a considerable amount of ad hoc and customised innovation. These types of innovation derive their justification from the domestic and relational world. The resulting innovations are created out of the interaction between client (user) and provider and do not have the usual relationships to the commercial (or market) world. In particular, they may not be reproducible as such. This characteristic, which is undoubtedly problematic in a strictly market world, creates no problems at all in the domestic world. Thus the introduction of the domestic world allows some of the serious constraints on our theoretical concepts of innovation (the requirement that innovations be reproducible, for example) to be relaxed.

Furthermore, certain innovations, notably but not solely in the public services, have their roots in the social and civic world (e.g. products specific to various physical and social handicaps) and should not be evaluated by reference solely to the market world either. Although such innovations have a cost, they also generate value added which cannot be expressed in terms of volume or value but which might be described as social value added. This type of innovation, like the preceding one, has its roots in a non-market selective environment.

### *3.2.2. It can be organised differently*

Economic theory has long championed a linear concept of innovation, in which the R&D, production and marketing phases succeed each other without interacting. From this point of view, researchers, producers and sales staff are specialists belonging to separate, hermetic universes.

Such a theoretical concept is far removed from the reality of manufacturing companies. It is fundamentally incompatible with the real nature of service activities. Services are, by definition, interactive, and innovation here tends to be organised in a quasi-natural way in

accordance with an interactive model, i.e. a model in which actors from various departments interact. This seems to be the rule even in heavily bureaucratic organisations such as insurance companies. The development of a new, mass-market insurance policy, for example, requires the participation of lawyers, actuaries, IT specialists, loss adjusters, sales staff and customers. And in the case of consultancy services, it is clear that those who produce innovations are the very same people who sell the services (i.e. those in direct contact with clients). It can hardly be any different in activities in which a part of the innovation is produced at the interface between provider and client.

This (quasi-natural) interactivity does not, of course, preclude the existence in certain cases of specialist innovation departments, particularly in very large companies. However, such departments, when they exist, are seldom the only actor in the innovation process. They are almost always complemented by (and in competition with) formalised but non-permanent innovation structures (project groups made up of individuals from various departments) and by a high degree of informal individual activity, particularly in knowledge-intensive activities.

The frequent absence of R&D departments makes it difficult to identify autonomous R&D activity. Nevertheless, it most certainly exists. Obviously it is to be found in R&D departments when they exist. However, it can also be found in the activities of less permanent structures (e.g. project groups). It is usually one of the facets of innovation projects that may comprise analytical and conceptual activity, sometimes accompanied by tests. It can also take forms that are not captured in national and international R&D indicators, namely those of the human and social sciences. The following can be cited by way of examples: psychology put to use in recruitment consultancy, human resource management; and in the field of insurance: anthropology, sociology, economics and management, law and political science, danger science, etc.

### *3.2.3 The revenge of the “world of night”: services in support of innovation in manufacturing*

Many service activities have now reversed their subordinate relationship with manufacturing industry in matters of technological innovation. In other words, they produce their own technical systems, either by themselves or within a power relationship favourable to them. This is the case, for example, with automatic cash dispensers, cleaning robots and cooking and refrigeration equipment for fast-food restaurants. It also applies to certain large distribution chains that exert pressure on their suppliers and impose specifications so precise that it indeed becomes possible to speak of suppliers of technology dominated by service users.

However, another phenomenon is even more clearly indicative of the revenge of the “sector of darkness”. This is the active role played by the so-called “knowledge-intensive services” in their clients’ innovation processes (particularly those in manufacturing industry). Whether the innovations relate to organisation, strategy, products etc., these service providers assist their clients in a variety of ways, to differing degrees and at different stages in the innovation process. It is no exaggeration, therefore, to speak of “consultant-assisted” model of innovation (Gallouj, 1994b).

## **Conclusion: convergence between goods and services in respect of innovation**

Like many great peoples who have been defeated on the field of battle but who succeed ultimately in imposing their culture on their conquerors, services can be said to have taken their revenge on manufacturing industry. Indeed manufacturing industry is also increasingly inhabited by incorporeal entities and is gradually coming to resemble the tertiary sector. There are numerous indications of this convergence between manufacturing and services. The institutional boundaries between some service companies and certain manufacturing firms are no longer very clearly defined. Various forms of service now constitute the main component of many industrial goods. And as we have seen, some services are called on to tend ailing manufacturing industries.

At the same time, however, there are some indications of a reverse trend towards the industrialisation of certain services. There is, therefore, some degree of convergence between goods and services. The most important theoretical instrument in this convergence is undoubtedly the notion of service relationship, understood as a mode of coordination between economic agents in both services and manufacturing (de Bandt et Gadrey, 1994). This convergence means that, beyond the myths we have examined, there are opportunities in the economics of innovation for mutual enrichment between goods and services. This means, for example, that manufacturing activities can draw inspiration from service firms in the development of interactive models of innovation and that the different forms of innovation outlined above can be applied equally to manufacturing activities. In other words, if we underestimate innovation in services, we are also underestimating innovation in manufacturing industry.

### References

- ATTALI J., 1981, *Les Trois Mondes*, Fayard, Paris.
- BARRAS R., 1986, Towards a Theory of Innovation in Services, *Research Policy*, 15., p. 161-173.
- BELL D., 1973, *The Coming of Post-Industrial Society, a Venture in Social Forecasting*, Basic Books, New York ; traduction française, 1976, *Vers la société post-industrielle*, Laffont.
- BOLTANSKI L., THEVENOT L., 1991, *De la justification. Les économies de la grandeur*, Gallimard, Paris.
- CALLON M., 1994, L'innovation technologique et ses mythes, *Gérer et Comprendre*, mars, p.5-17.
- CALLON M., 1995, *Pratiques et enjeux de la démarche qualité dans deux filiales de la Sodexo (Bâteaux parisiens, chèques restaurants)*, CSI, décembre.
- DE BANDT J., GADREY J. (Eds), 1994, *Relations de service, marchés des services*, CNRS Editions.
- EIGLIER P., LANGEARD E., 1987, *Servuction : le marketing des services*, Mc Graw-Hill.
- GADREY J., 1991, Le service n'est pas un produit: quelques implications pour l'analyse économique et pour la gestion, *Politiques et Management Public*, vol. 9, n°1, mars, p. 1-24.
- GADREY J., 1996a, *Services : la productivité en question*, Desclée de Brouwer.
- GADREY J., 1996b, *L'économie des services*, La Découverte (2ème édition).
- GALLOUJ C., GALLOUJ F., 1996, *L'innovation dans les services*, Economica Paris.
- GALLOUJ F., 1997, Towards a neo-Schumpeterian theory of innovation in services?, *Science and Public Policy*, Vol. 24, n°6, December, p. 405-420.
- GALLOUJ F., 1994, *Economie de l'innovation dans les services*, Editions L'Harmattan, Logiques économiques, Paris.



- GALLOUJ F., 1994, Cycles économiques et innovations de service : quelques interrogations à la lumière de la pensée schumpeterienne, *Revue française d'économie*, volume IX, 4, automne, p. 169-213.
- GALLOUJ F. (avec la collaboration de F. DJELLAL et C. GALLOUJ), 1997, *Vers une théorie de l'innovation dans les services*, Rapport pour le Commissariat Général du Plan, juillet.
- GERSHUNY J. (1978), *After Industrial Society? The Emerging Self-Service Economy*, Mac Millan, Londres.
- GERSHUNY J., MILES I. (1983), *The new service economy*, Frances Pinter.
- GORZ, 1988, *Métamorphoses du travail et quête de sens*, Galilée.
- KUTSCHER R., MARK J., 1983, The Service-Producing Sector: Some Common Perceptions Reviewed, *Monthly Labor Review*, Avril, p. 21-24.
- ROACH S., 1989, *Pitfalls on the "New" Assembly Line: Can Services Learn from Manufacturing ?*, Séminaire international la science, la technologie et la croissance économique, OCDE, Paris, juin.

**PAPER 2:**

**NEO-SCHUMPETERIAN PERSPECTIVES FOR  
INNOVATION IN SERVICES: A SURVEY**

**(Forthcoming as Chapter 2 in Boden and Miles (eds), Innovation in the  
Knowledge Based Economy, Cassell Academics, 1998)**

## NEO-SCHUMPETERIAN PERSPECTIVES FOR INNOVATION IN SERVICES (A SURVEY)

Faiz Gallouj and Camal Gallouj<sup>7</sup>

(Forthcoming as Chapter 2 in Boden and Miles (eds), *Innovation in the Knowledge Based Economy*, Cassell Academics, 1998)

### Introduction

The economics of services is seeking a theory of innovation appropriate to its specific features<sup>8</sup>. The bulk of the literature on "innovation in services" utilizes "technologicistic" and "industrialistic" concepts and has in practice examined *technological innovations applied to services*.

The most obvious explanation of this bias is the sheer scope of the processes of technology adoption and their impacts on economic variables as significant as productivity, employment, skills, trade, etc. Indeed which the tertiary was long considered a sector of low capital intensity, services are now the principal *buyers* and *users* of information technologies across all the developed economies (Kutscher and Mark, 1983; Guile and Quinn, 1988).

Because it contributes to creating a "mechanistic" analysis of production and a restrictive and "technologicistic" vision of innovation that are particularly inappropriate to the fundamental characteristics of the service economy, the implicit or explicit utilization of standard neoclassical theory also plays a role in this "technologicistic" bias. This theory is based upon hypotheses<sup>9</sup> that are incompatible with the characteristics of the service economy. It leads to a focus on process innovations that are incorporated into producer goods, and fails to take into account the tacit and idiosyncratic dimensions of techniques that are particularly significant to service activities.

A number of *ad hoc* empirical analyses have been undertaken in recent years with a view to moving beyond this "technologicistic" approach and take into account the specificities of services innovation. Though by no means an exhaustive list, we can cite examples of integrationist and functional approaches (Belleflamme et al., 1986; Barcet et al. 1987), managerial approaches (Norman, 1984; Eiglier and Langedard, 1987; Lovelock, 1992) and service-based or service trajectory approaches (Gallouj, 1991; Gadrey et al., 1993, 1995; Sundbo, 1993, 1994).

This chapter does not review these analyses some of which will be considered in

---

<sup>7</sup> We gratefully acknowledge comments and suggestions of Jon Sundbo. This chapter is partly based upon a previous paper published in *Science and Public Policy* (F. Gallouj, 1997).

<sup>8</sup> Which does not imply that this theory has to be limited to it.

<sup>9</sup> Very broadly, these are hypotheses of nomenclature, non-interaction and product anonymity. These hypotheses contradict the characteristics generally attributed to services, of immateriality, interaction, and 'non-stockability'.

chapter 7<sup>10</sup> but examines services from the perspective of neo-Schumpeterian theories of innovation. The goal is to reflect upon the following question. To what extent do neo-Schumpeterian analyses of innovation help take into account services innovation? Faithful to the Schumpeterian tradition, these theories in practice adopt a broad definition of innovation as a non-maximizing, interactive, cumulative, specific and institutionalized process. In contrast to the hypotheses of standard neoclassical theory, their hypotheses do not, *a priori*, seem incompatible with the principal traits of the service economy. This chapter examines the transposition, into the services sphere of the concepts of the technological paradigm (Part 1), and the technological trajectory and attempts to construct sector-based taxonomies of the forms of technological change (Part 2). The "*reverse cycle*" model of Barras goes beyond these conceptual transpositions since it proposes a theory of services innovation along Schumpeterian lines; a detailed critical analysis is presented (Part 3).

## 1. Services and technological paradigms

In this first part of the chapter the modalities (and difficulties) of transposing the concepts of the technological and techno-economic paradigms to service activities are examined. The link between services and the technological (or techno-economic) paradigm can be conceptualized on two levels: that of the impact of the new paradigm (based on information and telecommunications technologies) on services and that of the role of services in this new paradigm. In practice this notion of a reciprocal effect is much more complex. For example, problems specific to services (at the micro-economic level) have impacts on the form of technological change.

### 1.1 *The impact of the new (information) paradigm on services*

The main body of the literature implicitly or explicitly related to services innovation focuses on this generic theme. It is not necessary to present an exhaustive analysis of this theme, since the aim is to identify a number of questions the significance of which helps explain why there is less interest in services innovation in its own right.

Very schematically, it is possible to identify two models of successive technological innovations - the first corresponding to the introduction of heavy computerization, the second to the introduction of decentralized computerization and networks - and to examine the impact of each on employment, skills, the organization of tasks, productivity, trade, and the "service-product" (quality). The matrix representing the two models on one axis and these principal analytical concerns on the other axis encapsulates a large part of the economic debate related to "innovation in services". An approach such as this is certainly reductionist: other factors (eg competition) affect the various elements which are not analyzed here ; one model follows the other yet they are not necessarily substitutes. However, the procedures adopted in many studies are wholly or partially contained within this "matrix". A review of the significant body of literature that corresponds to this matrix would not be particularly useful here. Instead, the following "stylized facts" can be outlined.

As far as the first model is concerned (introduction of heavy computerization), it is generally accepted that the impacts theoretically expected include: increased

---

<sup>10</sup> For a survey of these analyses, see F. Gallouj (1994), Miles et al. (1995), C. Gallouj and F. Gallouj (1996).

productivity, reduced employment and deskilling of the workforce. This first model corresponds to the computerization of *back-office* tasks. It is based upon the standardization and Taylorization of tasks (data retrieval) and the exploitation of economies of scale.

In the second model (the introduction of decentralized computerization and networks), by contrast, the principal hypotheses theoretically tested can be summarized in the following question: does the introduction of decentralized computerization not entail higher employment, a reskilling of the workforce and increased productivity? In practice, decentralized computerization is related to diverse tasks and not solely the back office. Moreover, it tends to bring about economies of variety and to reduce routine tasks in favour of more reputation-enhancing tasks such as consulting and commercial activities.

In both cases, a significant portion of the literature consists of presenting these theoretical hypotheses and their mechanisms, confronting them with reality and attempting to interpret the discrepancies. A question of major theoretical importance which runs across both models and several studies is what is known as the "Solow paradox". This is the observation of a simultaneous decline in productivity and acceleration of technical change in most of the developed economies since the early 1970s.

The analysis of the impact of technology investments on the nature of the "service-product" should bring us nearer to the problem of service innovation itself. Yet this issue most often remains secondary in relation to other analytical priorities. It is true that in the first model, the technological innovation adopted generally entails little change in the "service-product". But while in the second model there are possible impacts in terms of "product" and "service" innovations, they are rarely examined in any depth.

The main lesson to be drawn from the preceding remarks is the following: the adoption of technical innovations in services has significant economic and theoretical consequences, the analysis of which has mobilised a large number of researchers. This justifiable focus of economic research has contributed to a neutralization of attention paid to innovation "internal" to services.

### ***1.2 The place of services in the new paradigm***

The second aspect of the question is rarely considered. It consists of viewing services (or some of them) as constitutive elements of the new techno-economic paradigm in the sense that they create the material or non-material technologies that are part of the basis of this paradigm. The question then becomes whether they participate actively and significantly in this paradigm or whether they are merely a secondary and subordinate part of it.

To the extent that the technological trajectory represents the gradual exploitation of a "technological potential" under the various forms that neo-Schumpeterian economics gives it (paradigm, "guide post", new technological system, etc.) service innovation in the strict sense can be considered to be the ultimate (optimal) exploitation of a given potential. It is in this sense that one must interpret the following declaration by C. Freeman (1982, p.5):

This is not to underestimate the importance of dissemination of knowledge through the education system, industrial training, the mass media, information services and other means. (. . .). It is only to assert the fundamental point that for any given technique of production, transport or distribution, there are long-run limitations on the growth of productivity, which are technologically determined. (. . .). Education and training of the labour force, efficient communications, additional capital investment, economies of scale, structural changes, plant reorganization, and the application of management skills may all be regarded as the systematic exploitation and "follow-through" of scientific discovery and technological innovation.

It appears that, in practice, the introduction of the service dimension into industrial activities — as, for instance, in its day, the establishment by companies of "after sales service" or "consumer services" — can be interpreted as a service innovation that originates in the optimization of an industrial innovation to which it is subordinate. From this perspective, service innovation does not have its own purpose; it only exists to confer the status of innovation on a given good.

The idea of a reduced role for service innovation strictly defined, in which it is placed in a subordinate position with respect to a paradigm (here the new technological system) in which the "object" dimension predominates is nevertheless interesting in the sense that it goes much further in its thinking than the theoretical project that is limited to analysing the impact of the new technological system (the new paradigm) on services.

In a more recent article, C. Freeman (1991) is more explicit in his discussion of service innovations. It is true that he only considers them in terms of a purely organisational dimension; his real interest lies in organisational innovations, which he illustrates with examples drawn from service activities. However he breaks with the strictly *subordinate* perspective when he admits that these innovations *may* have few direct links to technical innovations. His examples include supermarkets in the distribution sector, containerization in the transport sector and package holidays in the tourism sector. The roles played by changes in physical equipment (technical innovations in refrigeration, vehicles and communications) in these service innovations is far from negligible, yet these links are not the main determinants and the service innovations have their own autonomous trajectories.

While these organisational and service innovations are not directly linked to any particular technical innovation they are nevertheless intimately linked to the techno-economic paradigm of which they form a part. The emergence of the service innovations cited above was linked to

" social and technological trends of mass production, standardization of consumer products, mass markets, car ownership and cheap energy. Thus they were far more influenced by the dominant contextual web of technical and economic development and the dominant style of management (the "techno-economic paradigm") than by specific technical innovations in each particular sector" (Freeman, 1991, p.221).

According to C. Freeman (1991) these innovations have to be treated in a way already recommended by Schumpeter, in other words in the same way as all technical innovations that are "part of the general profit-driven dynamic of capitalism".

The existence of service innovations or innovations which affect service functions (organisational innovations) that are directly induced by technical innovations does not escape C. Freeman's notice (p.221): "almost any major process or product innovation will lead to some corresponding organisational change in the company, for example changes in training systems, in maintenance procedures, in technical services and so forth". They may also lead to organisational changes (service innovations) beyond the innovating companies and thus cause the emergence of new service activities, such as the opening of garages to maintain and repair vehicles, or information consultancy.

Moulaert et al. (1991) move even further away from the subordinate interpretation of the role of services in the technological paradigm. Their interest lies in high technology services and they defend the thesis that "the recent revolution is as much a revolution in professional services and more precisely in high technology consultancy as a hardware revolution." Their principal reasons are as follows: the central role played by high technology consultancy in the development of the new technological paradigm; the strong growth in this kind of activity over a number of years; and the tendency towards a certain autonomy in the location strategies of high technology consultancy activities with respect to the locations of equipment producers.

In a recent study, F. Djellal (1995) develops this idea at length. She proposes substituting the concepts of the paradigm and the technological or techno-economic trajectory (still dominated by a technologicistic and economic logic) with a socio-technical paradigm and trajectory. Backed up by concepts of regulation theory and institutional theories she takes into account organisational, institutional and social dimensions of innovation. As with the "science based companies" in Pavitt's taxonomy (see below) information technology consultancy firms, which articulate knowledge of hardware, software and orgware, are active agents in a socio-technical paradigm. If we accept the definition of innovation as *problem solving activity* (Dosi, 1982) it would appear to be possible to extend this thesis to all consulting activities. Given that in practice these activities are generally themselves defined as legal, economic, technological and social *problem solving activities*, it can be said that they actively participate in the new socio-techno-economic paradigm.

### ***1.3. More complex reciprocal relations***

The links between technology and services are not limited to the issue of the impact of technology adoption by service industries. Several other relations, which are neither exhaustive or exclusive, can be identified (cf. Table 1).

Substitution relationship	Total or partial replacement of a service with a technology
Identity relationship	The service constitutes the usage value of the technology
Determination relationship	Technological innovation "determines" the appearance of new services
Diffusion relationship	Services participate in the diffusion of technological innovations
Production relationship	Services produce technological innovations

Table 1: Main links between technological innovations and service innovations (Galloway, 1994)

1) *Substitution relation*. In this case the linkage is one of substituting technical capital for human capital. This total or partial substitution may take place in the back office (and not concern the client directly) or at the interface. Examples include automatic teller machines, "information and advice displays" in some banks, "advice and promotion displays" in some shopping centres, transport timetable services and reservation systems. It is here that we come across the theory of self-service (Gershuny, 1978 ; Gershuny and Miles, 1983).

2) *Identity relation*. The nature of the service provided determines the use value of the technology. There is a *relationship of identity, of consubstantiality*, between the tool and the service. There is a long list of such innovations in telecommunication services (improved telephone systems, electronic mailing, high definition video, fax...). This relationship of consubstantiality between the technology and the service is not very different from the situation in which material goods are defined in terms of the *service they provide*. Saviotti and Metcalfe (1984) base their attempt to measure technological change on this interpretation and on certain hypotheses drawn from the new consumer theory (cf. chapter 7).

3) *Determination relation*. The technological innovation determines the emergence of new service functions. This was the way the emergence of information technologies brought about the emergence of new professions and services, not the least of which are the various types of information technology consultancy. Similarly, numerous other producer goods have brought about the emergence of new financial, insurance, consultancy, cleaning, maintenance and location services.

4) *Diffusion relation*. Certain service activities help to diffuse technological and organisational innovation. This is particularly the case with high technology consultancy activities (Moulaert, Martinelli, and Djellal, 1990, Bessant and Rush, 1995).

5) *Production relation*. Service firms are themselves producers of technological innovation. They can also subcontract this production, but in a favourable balance of power. For some time now, service providers have exerted strong pressure on material producers to persuade them to produce certain types of equipment or software. This "determination" is exerted not only towards suppliers of high technology, but also includes other clients and suppliers. The major retailing firms, for instance, exert strong pressures on the food industry and other production sectors to improve the quality and condition of products, as well as more recently their ecological characteristics (Miles and Wyatt, 1991). This relation recognises that services have a role that is not merely passive and related to adoption but on the contrary is very active, similar to that in manufacturing industries.

## 2. Services, sectoral taxonomies and technological trajectories

In an evolutionary and neo-Schumpeterian perspective Pavitt (1984) was able to disaggregate the whole British economy into three categories: supplier dominated,



production intensive and science-based. Each of these represents a sectoral model of technical change.

According to Pavitt, most professional, financial and commercial services belong to the supplier-dominated category in this now well-known taxonomy. While in a more recent study Pavitt, Robson and Townsend (1989) separate out an "information-intensive" trajectory within this category, services remain "dominated by suppliers" of technology (of information technology in this case). Recall the principal traits of supplier-dominated firms. They are generally small. Most of their technology is process technology that comes from equipment and material suppliers external to the particular sector. Generally speaking users are price-sensitive, and the technological trajectory is therefore one of "cost-cutting". The principal modes of appropriating technology are non-technical and include registered trade-marks, marketing and advertising strategies and aesthetic design.

In order to usefully analyze technological trajectories in services, it is necessary to disaggregate this heterogeneous group; that is, to develop a classification pertinent to the behaviour of its constituent parts with regard to technological change. This is precisely the project undertaken by T. Lakshmanan (1987) and Soete and Miozzo (1990).

### ***2.1 Technological and institutional trajectories according to Lakshmanan***

Lakshmanan adapted a typology developed by Peter Mills (1986) and identified the following three principal types of services: "service dispensing activities", "task-interactive services" and "personal interactive services", the principal characteristics of which are reproduced in Table 2.

Hence, according to Lakshmanan, the "service dispensing activities" appear to follow what R. Nelson and S. Winter (1977) call a "natural, technological trajectory", in other words a process of mechanisation and exploitation of economies of scale. Dominated by a logic of standardisation, this type of service adopts technologies that are similar in certain respects to the technologies used to produce goods. These are machines capable of treating large volumes of information or material. Good examples include check-out tills at supermarkets (which in some ways resemble industrial assembly lines), technologies to handle letters in postal sorting centres, and various aspects of the mechanisation of fast-food (heating and cooling technologies).

The technological trajectory being followed in some services belonging to the "task-interactive" and "personal-interactive" categories is different. The goal here is to reduce communication costs. A significant aspect to this problem is therefore the acquisition and processing of information. Not surprisingly it is information and telecommunication technologies that are preferred here.

A further interesting aspect of the work of T. Lakshmanan is to draw attention to what he calls institutional innovations and their articulation with technological innovations. Institutional innovations are defined as changes to the rules that govern modes of interaction between individuals in a firm or organisation. Self-service, co-production, "monitoring" (service provider controlling) and bonding (provider's possession of bonds assuring the quality of its services) are examples of this type of innovation.

While Lakshmanan's work suggests the usefulness of introducing the concept of institutional innovation, he does not pursue it further. The idea of institutional innovation in the sense accepted by Lakshmanan is but one component of the social innovation defined by Normann (1984, p.84) as "innovation that creates new types of social behaviour that use social or human energy more efficiently, that link social contexts to each other in new ways".

Defined thus, social innovation is not limited to the mode of participation or mediation with the client, but also includes social trajectories (institutional or organisational) as follows :

- the utilisation of human or technical production capacities which are un-used and only require to be used. Some computer services firms are said to have originated in a desire to utilise the overcapacity of the computer departments of large companies.
- the introduction into an organisation of new functions leading to new roles or sets of roles. The best known example of this type of social innovation is that of the "*gentils organisateurs*" (GO) at Club Méditerranée.
- making contacts between contexts and actors with potentially complementary needs. In France, J.C. Decaux is an example of this type of social innovation<sup>11</sup>.

Type of service	Key characteristics	Technical innovations	Institutional innovations	Synergistic developments
"Service dispensers" (e.g. retail wholesale, telecommunications, fast food, banks, etc.)	Stable, low uncertainty environments, consumer contact minimal, production technologies known, customer's needs known, amenable to scale economies, service provider more involved with dispensing services than producing them .	Automation of many processes, ATM, etc. high volume machine technologies	Self-service, standardized service packages.	E.g. Federal express
"Task-interactive services" (e.g. accounting, legal, financial)	Complex environment, moderate to high customer contact, unique customer needs, high information needs, information subject to different interpretations, clients goals known but outcome of solutions uncertain.	Telecommunication for efficiency, quality of service, on-lin information systems	Use of consumers for specification of output, forms of coproduction	Information network services, new service products
Personal-interactive services (e.g. health care, welfare agencies)	Dynamic uncertain environments ; client goals imprecise ; cause-effect relationships between solutions and outcome uncertain. Adverse selection, moral hazard	- Machine technology growth rapid (e.g. health) - On-line information systems	- Coproduction - Bonding - Monitoring	Distributed coproduction ; innovation in service output

Table 2: Evolving technologies in the service sector  
*After Lakshmanan, 1987.*

<sup>11</sup> The service provided by this firm is based on making contact between four groups of actors: local governments which are provided with free bus shelters and are responsible for maintaining them; advertising agencies which rent out high quality and perfectly maintained sign boards (the bus shelters); bus passengers, and the public in general which benefits from this so-called urban furniture.

## 2.2 Soete and Miozzo : a taxonomy inspired from Pavitt's one

L. Soete and M. Miozzo (1990), by contrast, utilise Pavitt's criteria to propose a taxonomy that is specific to services. They identify three types of firms or sectors: a "supplier-dominated" type (dominated by suppliers of equipment and technical systems); a type that they call "scale intensive physical and information networks" which corresponds to most services dominated by the processing of codified information (banking, insurance) or activity related to goods (trade, transport); and a type that they call "specialised suppliers and science-based firms".

Category of firm	Supplier dominated		Scale intensive physical networks	Information networks	Specialized suppliers/science based	
<b>Typical core sectors</b>	Personal services (repair, cleaning, barber and beauty services, hotels, bars, restaurants, retail trade, etc.)	Public and social services (health, education)	Transport, wholesale	Finance, insurance, communications	Software	Specialized business services
<b>Sources of technology :</b> • manufacturing • services	Manuf.	Manuf. and services	Manuf.	Manuf. and services	Services	
<b>Type of user</b>	Performance sensitive	Quality sensitive	Price sensitive	Price sensitive	Performance sensitive	
<b>Means of appropriation</b>	Non technical	Not allowed, public	Standards, norms	Standards, norms	R-D know-how, copyright, product differentiation	
<b>Technological trajectory</b>	Product design	Improving performance	Cost-cutting and networking	Cost-cutting and networking	system design	
<b>Source of technology</b>	Suppliers	Suppliers	In-house ; suppliers	In-house ; suppliers	In-house ; customers ; suppliers	
<b>Relative size of innovating firms</b>	Small	Large	Large	Large	Small	

Table 3 : A sectoral technological taxonomy of services : determinants, directions and measured characteristics.

*Soete et Miozzo, 1990*

The category of "services dominated by equipment and technical suppliers" corresponds to the most traditional vision of services. Firms in this category do not participate significantly in the production of the process technologies they utilise. L. Soete and M. Miozzo classify them under two sub-categories: personal services (repair services, cleaning, bars and restaurants, hotels, retailing, laundry, beauty services, etc.) and public and social services (education, health care, public administration).

The two sub-categories are associated with different sizes of firm (generally small in the first case, large in the second), different sensitivities on the part of users (performance in the first case, quality in a wider sense in the second) and different modes of appropriating the innovation (in the first case non-technical means such as professional know-how, aesthetic design, brand name, advertising; in the second case appropriation is not permitted or is public).

The two other types of service firm, "physical and information networks" and "specialised supplier and science based firms", participate to a greater extent in the production of technological innovations.

The technological trajectory of network firms is based on cost reduction and a networking strategy. These types of firm are large and their principal modes of appropriating technology are standards and norms. Users are price sensitive. Soete and Miozzo further divide them into two sub-categories: firms associated with physical networks (transport, wholesale distribution) and firms associated with information networks (finance, insurance, communication). They note that just as in industry there emerged departments of engineering and production techniques responsible for the proper functioning and the improvement of production techniques, so the services are seeing the emergence of departments of network engineering, particularly in firms associated with information networks. While manufacturing industry reappears here as a supplier of equipment and technical systems, it is important to recognise a certain reversal of power relationships, as revealed by the frequent intervention of client service firms in the specification of the technical tools. Here it is incorrect to speak of service firms as dominated by technology suppliers; it is more appropriate to talk of "services dependant suppliers", as Soete and Miozzo call them.

The category of specialised suppliers and science based firms is characterised by a significant output of technological innovations mediated by research, development and software activities undertaken by the service firms themselves. This is the case of business services that maintain close relationships with R&D, information technologies and telecommunications. This type of firm is relatively small and the users are more sensitive to the performance of the technologies than to their price. Their characteristic technological trajectory is based on the system design. The principal means of appropriating technology are R&D know-how, copyright and product differentiation.

Three comments can be made about this taxonomy, none of which reduce its interest:

- 1) It appears to be largely conceptual and deserves wider empirical testing.
- 2) The "targeted" analysis undertaken by the two authors permits us to progress beyond the idea of services as simple adopters of technologies. Indeed some services are themselves producers or co-producers of these technologies. However, only material technologies (incorporated into equipment) are really considered. Nothing is said about non-technological innovations, unlike in Lakshmanan's classification in which institutional innovations are at least suggested. The taxonomy developed by Soete and Miozzo ought perhaps to be broadened in the direction of taking into

account aspects and forms of innovation and services that are not strictly technological.

3) The network idea (and the corresponding technological trajectory) should constitute not so much one of the types within the taxonomy and rather a characteristic that is transversal, a trait of several, if not all types. Hence, for example, in the category that Soete and Miozzo call "supplier-dominated" significant networks have developed. Examples include certain hotel and restaurant chains and certain chains of "temp" agencies. Similarly, the category of specialised suppliers and science based firms is characterised by the development of networks. Indeed it is in this category that the major international accounting and consultancy firms (the Big Six) and the largest international computer services and engineering firms are to be found. The recognition of this problem then leads to a reconsideration of the issue of the relative size of firms. In practice, there are also many large firms in the categories of "supplier-dominated services" and "specialised and science based services".

One way to resolve this problem may be through functional decomposition. J. Gadrey's (1992) attempt is of interest here. Gadrey identifies three types of operation in the service process:

- those that consist of processing tangible objects, in others words transforming, moving or maintaining them (material logistics and transformation operations);
- those that consist of "processing" codified information, ie producing, retrieving and circulating it (information logistics operations);
- those that principally involve the client itself and which are made up of a direct service (with contact).

Each tertiary activity combines these three functions in different proportions, and as well as overall or transversal innovations it is possible to envisage innovations within each of the three dimensions. For instance, the following hypotheses might be proposed:

- the part of the service related to information logistics follows a technological trajectory of reducing communication and networking costs;
- the part of the service related to material logistics and transformation follows a natural trajectory that is more traditional, based on mechanisation and the exploitation of economies of scale;
- it is doubtless in the contact-type service provision that the institutional trajectory in the sense of T. Lakshmanan can be observed.

The tourist business, for instance, links together these various aspects: information logistics (reservation systems), material logistics (transport and accommodation) and contact-type provision. Accordingly, it is likely that different socio-technical trajectories are at work. In insurance companies where the information trajectory dominates, there are other trajectories related to direct service in areas such as "assistance" services, prevention, improvement of interfaces (reimbursement

deadlines, etc.). That's what J. Sundbo (1993, 1994) calls service professional trajectories. These trajectories can be found alongside another trajectory that is linked to material logistics (the organisation of transport systems in cases of assistance ; or, in the case of an accident involving damage insurance, a choice given to the client between monetary compensation and recourse to an agreed provider to repair the damage).

### **3. A neo-Schumpeterian theory of service innovation : Barras' reverse cycle model reconsidered**

Barras' model (1986, 1990) is without a doubt the first explicit attempt to create a theory of innovation in services following the Schumpeterian line. Barras views the debate on service innovations from a dynamic perspective. Contrary to the approaches reviewed above which focus on typologies, he does not limit firms to a given technological trajectory. Instead, the nature of the trajectory varies from one phase of his cycle to another. However, his model remains sectorally limited and fundamentally technologicistic.

#### ***3.1 The model described***

In certain services (banking, insurance, accounting, administration), Barras observed a product life cycle that was the reverse of the traditional industrial cycle formalised by Abernathy and Utterback (1978). The basic act in this theory is the adoption of a producer good in the form of an information and computing system by a service activity. The three phases of the reverse cycle are as follows.

##### *Phase I: incremental process innovation and improvement of service efficiency*

The first stage of the reverse cycle is initiated by the adoption, in a service activity, of a new producer good derived from the industrial sector. This is usually an information or telecommunication technology, and in particular a central computer system. The various forms of learning by doing, using, (and, let us add, consulting) lead to a number of incremental innovations which contribute to increasing the efficiency of the service provided, that is, reducing its costs. The automation of back-offices in banks, insurance, administration and accounting companies is based on this logic. More precise examples are given by the computerization of insurance policy records, local government personnel records and pay-roll, audit techniques and internal time recording in accountancy firms.

The generally "non-programmed" character of this type of innovation is consistent with the observation that at this stage service firms do not actively engage in research and development. In other words this is a situation in which firms are "technologically dominated by supply".

##### *Phase II: Radical process innovation and improvement of service quality*

After a certain threshold has been crossed, the knowledge and experience base that has accumulated and the introduction of mini and micro-computers which are used in the front office lead to radical process innovations that contribute more to

effectiveness than to efficiency. The goal is now to improve the quality of existing services. Examples include the computerised management of housing waiting lists in local public administration, on-line insurance policy quotations, and computerized book keeping services in accountancy firms. The installation of automated teller machines by banks also fits into this category since they not only reduce costs but also increase service quality by facilitating the withdrawal of money, waiting time, and hours of availability.

*Phase III: "Product" innovation*

The third phase of the cycle involves the production of new services rather than simply improvements to the efficiency and quality of existing services. It should be noted, however, that the new services are still generated by machines and technical systems, including network technologies.

This third phase has barely started, and if it is to take off it will require the creation of an information infrastructure. Network technologies, for instance, lead to experiments with interactive and fully automated auditing and accounting processes in accountancy firms, complete on-line services in insurance firms, home banking, etc. The services, created by the integration of banking, transport and insurance services, derive from the same logic.

The production of technology is no longer dominated by suppliers. The interactive innovation process is accentuated, resulting in a situation that may be labelled "user dominated", to parody Pavitt's taxonomy. This new status is of course accompanied by the establishment of an active research and development function, which may take place within specialised departments or through specialist small companies or consultants (Gallouj, 1994 ; Djellal, 1995 ; Bessant and Rush, 1995).

**3.2 A "sectorally limited" model**

Barras' thesis is predicated on the existence of "vanguard sectors" (financial and business services) and "enabling technologies" (information and telecommunications technologies). Further examination of these two notions leads to the conclusion that the field in which the model is valid may be both narrower and wider than Barras imagines.

*a) A narrower field of validity?*

In practice, despite his broad hypothesis about "vanguard sectors", Barras draws most of his empirical material from sectors he himself classifies as "pre-industrial": banking, insurance, accounting and municipal services. The question is, to what extent can this model be transposed to other "vanguard" service sectors? Perhaps Barras' model is basically applicable to the "vanguard" services that are most sensitive to technological development, and is of limited applicability to most other cases.

Two examples drawn from the consultancy sector are illustrative. Legal consultancy in France (see Gallouj, 1992) would seem to meet the Barras criteria for broadly defined "vanguard" sectors. However, thus far this sector has barely opened up to

enabling technologies (computer and telecommunications). Yet this has not prevented it from developing other forms of innovation: ad hoc innovations through original solutions (some components of which can nevertheless be reproduced) to a client's problem; opening up of new fields of law through an accumulation of knowledge and expertise; innovation by formalization through the introduction of new methods and bundling-unbundling procedures (in the sense of Bressand and Nicolaïdis, 1988; see also Foray, 1993; Henderson and Clark, 1990). Conversely, another legal profession, the notary profession, has been relatively quick (compared to other forms of consultancy) to computerize its offices. Yet this does not seem to have led to major innovations along the lines of the Barras cycle. Doubtless in these two cases account has to be taken of institutional rigidities and the degree of complexity and instability in the environment and in the problems to be resolved.

In an article on the "Solow paradox", P. Petit (1990) argues that Barras' analysis applies best to the development of all the self-service activities, and thus mostly to consumer services. Self-service is actually a way to use the consumer's own labour as an input, as a means to reduce the labour costs of the service. In some cases it includes the intensive use of "enabling technologies" such as those associated with the development of automatic teller machines at banks.

E. Langeard and P. Eiglier (1990) distinguish between two categories of equipment: "downstream equipment that participates directly in the realization of the service, and upstream equipment that is disconnected from it". They argue that the Barras model only applies to upstream equipment brought in from outside and is not valid for downstream equipment. In other words, the Barras model applies best in the case of activities where there is a significant back office (banks, insurance). It applies less well to consultancy activities, for instance, where the back office is much less significant than the front office (or place of *servuction*).

Hence Langeard and Eiglier on the one hand, and Petit on the other hand, appear to arrive at different and contradictory results as far as the field of validity of the Barras model is concerned.

These divergent interpretations may in part be due to two significant ambiguities that characterize this model. The first is the problematic transposition of the concept of "product" to services. The second is a possible confusion between two different levels of technology (incorporated into equipment): "enabling" technologies on the one hand<sup>12</sup>, and innovations permitted by these enabling technologies on the other hand, which may themselves be incorporated into technical equipment and systems. Hence, for instance, in the spirit of Barras, automatic teller machines are not enabling technologies but radical process innovations, the enabling technologies of which are networks with "dumb" terminals.

#### *b) A broader field of validity?*

The Barras model is exclusively based on the adoption of information and telecommunications technologies by firms in the service sector. It does not take

---

<sup>12</sup> As in the case, for instance of the insurance, accounting and municipal services sectors: mainframe computers during the first phase of the reverse cycle, mini and micro-computers during the second phase, and networks during the third.



account of technologies adopted by services that are not related to the storage, processing and circulation of information but to material logistics (storage, processing and circulation of material), such as technologies for transport, refrigeration, cooking, cleaning, etc. It also fails to take account of new technologies like medical instruments<sup>13</sup>, genetics and biotechnologies, etc. Accordingly, the question to which it is necessary to reply is the following: to what extent does the adoption of these technologies by services entail first process innovations and then "quasi-product" innovations ?

There appear to be good examples of new "service-products", new "formulas" or "concepts" in activities that utilize material transformation and logistics technologies, in distribution, for instance, or in restaurant chains. The automation of petrol pumps in service stations, for instance, may be considered a radical process innovation similar to automatic teller machines. Moreover, the opening of sales points in these service stations, using all the techniques of the supermarket and open permanently, is related to "product" innovation in the sense used by Barras.

Moreover, situations can be envisaged in which the Barras cycle is based on a combinatorial adoption of information technologies and material transformation and logistics technologies. This is the case with firms like Federal Express, Chronopost and mail order companies. An example is containerized transport. While this technology is relatively old (Ernst, 1985), it has been a source of process innovations in Barras' sense; in the first place it improved the efficiency of transport without changing the nature of the service itself. The later standardization of container sizes and development of technologies involving the unloading cranes and their standardization have been factors in improving service quality in terms of a greater availability and so on (radical process innovation). With the introduction in recent years of information and telecommunications technologies into maritime container transport, the quality of the service has been improved so much that it is possible to speak of a "new service" in Barras's sense<sup>14</sup>. Another example is fast food in the United States. In certain fast food restaurants, cooking and refrigeration technologies are permitting incremental process innovations (affecting the "back-office": the central kitchen). On the other hand, computerized menu ordering systems can be seen as radical process innovations (by analogy with the automatic teller machines of banks, which are considered so by R. Barras).

### *c) A technologically determined model*

In Barras' model service innovation is necessarily based on technological systems. Even the "product" innovations that appear in the third phase of the reverse cycle are necessarily supported by technical equipment.

In the Barras approach, economic and institutional determinants are only evoked as factors that facilitate or block innovation, that is the implementation of technological possibilities, and never as active determinants of innovation. And yet technology

---

<sup>13</sup> Although, in this case, there is a significant information component.

<sup>14</sup> It is now possible to know at every moment to whom each container belongs, what it contains, where it is located, where it comes from and where it is going, where it should (optimally) go once empty, what kind of container it is, if it needs to be repaired and at what price, etc. (Ernst, 1985).

(incorporated into equipment) is neither necessary nor sufficient for the process of service innovation. Other factors may in fact play a role, such as deregulation, evolving client and market behaviours, and the characteristics of human resources.

D. Tremblay (1989) confirms one aspect of the Barras thesis, that in the banks innovation has shifted from process to product. However, she differs on two other points. First, product innovation is already the dominant form, as shown by the observable tendency for banks to be organized on product lines. Second, technology is only one factor in a multidimensional causal model which includes the various other factors mentioned above.

Studies in the consultancy and insurance sectors (Gallouj, 1994, 1995; Gadrey et al., 1993, 1995) confirm that the Barras approach is fundamentally technologicistic, and that a far broader "causal" model is required. From this perspective, the Barras model is flawed on a number of grounds, which can best be explained by reviewing the cycle phase by phase.

The first phase of the cycle is not in fact specific to services. The learning process, notably "learning by doing", is involved in all equipment acquisition in any manufacturing or service sector. The reverse cycle is about the adoption by services of technologies created in other sectors (manufacturing sectors) in rather neoclassical terms during the first phase of the cycle (process innovation and cost reduction) and in neo-Schumpeterian terms during the second phase of the cycle (the idea of a technological trajectory initiated by the first phase).

The concept of service quality, which is the focus of the second phase of the reverse cycle, is used in a restricted sense, that of "access time". This is the purpose of the automatic teller machines. If, however, one accepts that the role of technology is to create closer links between the bank and the client, and that perceived quality is a function of the "distance" between the service provider and the client, it can be concluded (as Barras does) that during the second phase of the cycle technology ought to improve quality. Yet the technologies used by the banks during the second phase may also have the effect of distancing the provider from the client and therefore lowering a certain type of quality.

When we finally reach the phase that is really specific to services, the phase in which service activities ought to create their own innovations ("new services"), Barras is careful to state that the phase has only just started. Yet if we adopt a non-technologicistic definition of "product" innovation, in the sense commonly used for banking "products" ("formulas" for managing operations, accounts and payments, which can be created without any technological innovation), we arrive at the opposite conclusion, that in banking at least, product innovation is already dominant.

In the adjacent field of insurance, recent studies (Gadrey et al., 1993, 1995) reveal the importance of this type of "service-product" innovation which is ignored by the reverse cycle model<sup>15</sup>. It appears that even while in certain situations the introduction

---

<sup>15</sup> In particular, a distinction is made between: a 'service-product' innovation in the sense of the creation of a new service, formula, concept or contract; a 'tailored service-product' innovation, which is an important form in collective life assurance, the insurance of major industrial risks and travel assistance; architectural innovations in the sense of the association-

of computerization leads to process innovations (in conformity with the Barras model), the design of new "service-products" in life insurance, damage insurance, or travel assistance often also leads to innovative changes in information systems, a process that is not captured by the Barras model.

## Conclusion

Services and the service relationship appear to have a number of points of convergence with the evolutionary and neo-Schumpeterian framework for analysing economic and technical change.

The concepts of technological paradigm and techno-economic paradigm seem sufficiently broad to leave room for services. As already pointed out, if innovation is defined (following G. Dosi, 1982) as a problem-solving activity, it is possible to go so far as to consider nearly all business consultancy activities as innovative and therefore as constituents of the new socio-technical paradigm (Djellal, 1995). It ought to be noted, however, that the intermediate concepts of "guidepost", technological regime, and "basic design" need to be used with care in the services because of their significant material connotation. On the other hand, the intermediate concepts of "technological system" and "bandwagon" are applicable to services. Examples are the system that is being constituted around the supermarket, insurance, banking and consultancy, and the system that is emerging around various forms of transport, restaurants, hotels, tourism and leisure services. As well as a bandwagon in computers and telecommunications, we can now talk of a bandwagon in goods logistics (wholesaling) or a bandwagon (not principally related to technology) in business consultancy services.

The evolutionary intellectual process, which favours movement and trajectory, does not, *a priori*, seem incompatible with a procedure of defining a service as itself an act, a movement. As the analysis of T. Lakshmanan suggests, it is possible to envisage an "institutional" trajectory for services, that is, a trajectory not in terms of technological innovations but in terms of institutional (or social) innovations.

The behaviour of certain services firms seems to correspond well to the evolutionary hypotheses. In numerous cases, for instance, the development of the service relation itself seems to be more a heuristical type of relationship than an algorithmic relationship of optimization.

Hence the Barras model constitutes a neo-Schumpeterian theoretical synthesis of several studies of "the impacts of information and telecommunications technology on services". It recomposes the various empirical and theoretical ideas and results into a synthetic and dynamic model with an internal coherence. Barras has therefore succeeded in developing what he calls a "theory of innovation". But it is less a theory of innovation in services than a theory of the diffusion to services of technological innovations originating in industry. In other words, the reverse product cycle model

---

dissociation of existing 'service-products'; and finally, innovations which involve the modification of a service-product, that is modification of specifications or options (new guarantees) where the basic formula is unchanged.

remains fundamentally technologicistic: the only innovations in fact envisaged are technological. The emergence of new functions independent of technologies is not recognized.

And so, despite the apparent convergence between evolutionary and neo-Schumpeterian concepts and the service sector, the two fields remain separate from one another in economic theory. As J. de Bandt (1994) has argued with respect to the theory of production as a whole, the two fields will remain separate as long as the analytical objective remains that of using the services to test concepts and methodologies developed in, and for, an industrial context.

## Bibliography

- Abernathy W. Utterback J. (1978), Patterns of Industrial Innovation, *Technology Review*, 80, Juin-Juillet.
- Barcet A., Bonamy J., Mayère A., (1987), *Modernisation et innovation dans les services aux entreprises (Modernisation and innovation in business services)*, Report for Commissariat Général du Plan.
- Barras R.(1986), Towards a Theory of Innovation in Services, *Research Policy*, 15.
- Barras R. (1990)), Interactive Innovation in Financial and Business Services : The Vanguard of the Service Revolution, *Research Policy*, 19.
- Belleflamme C., Houard J., Michaux B., Ruysen O., (1986), *Innovation and Research and Development Process Analysis in Service Activities*, FAST-CEE Report.
- Bessant J, Rush H. (1995), Building bridges for innovation : the role of consultants in technology transfer, *Research Policy*, 24.
- Bressand A., Nicolaïdis K. (1988), Les services au coeur de l'économie relationnelle (Services in the heart of the relational economy), *Revue d'Economie Industrielle*, 43.
- De Bandt J. (1994), *De l'économie des biens à l'économie des services : la production de richesses dans et par les services (From goods economics to service economics : wealth production in and through services)*, in De Bandt J. Gadrey J. (eds), (1994), *Relations de service, marchés des services (Service relations, service markets)*, CNRS Editions.
- Djellal F., (1995), *Changement technique et conseil en technologie de l'information, (Technical change and information technology consultancy)* Editions L'harmattan.
- Dosi G. (1982), Technological Paradigms and Technological Trajectories : A Suggested Interpretation of the Determinants and Directions of Technical Change, *Research Policy*, 11.
- Eiglier P. Langeard E. (1987), *Servuction : le marketing des services (Servuction : the services marketing)*, Mc Graw-Hill.
- Foray D., (1993), *Modernisation des entreprises, coopération industrielle inter et intra-firmes et ressources humaines (Firms modernisation, inter and intra-firms industrial cooperation and human resources)*, report for the Ministry of Research and Technology, June.
- Freeman (1982), *The economics of industrial innovation*, Frances Pinter.
- Freeman C. (1991), Innovation, Change of Techno-Economic Paradigm and Biological Analogies in Economics, *Revue Economique*, n°2, march.
- Gadrey J. (1992), L'économie des services (The services economy), La Découverte.

- Gadrey J., Gallouj F. (1998), The Provider-Customer Interface in Business and Professional Services, *The Service Industries Journal*, Vol. 18, n°2, April, pp. 1-15.
- Gadrey J., Gallouj F., Lhuillery S., Ribault T., Weinstein O., (1993), *La recherche-développement et l'innovation dans les activités de service : le cas du conseil, de l'assurance et des services d'information électronique (R-D and innovation in service activities : the case of consultancy, insurance and data bases services)*, Report for the French Ministry of research, december.
- Gadrey J., Gallouj F., Weinstein O., (1995), New modes of innovation : how services benefit industry, *International Journal of Service Industry Management*, Vol. 6, n°3, pp. 4-16.
- Gallouj C., Gallouj F. (1996), *L'innovation dans les services (Innovation in services)*, Editions Economica, Paris.
- Gallouj F. (1991), Les formes de l'innovation dans les services de conseil (The forms of innovation in consultancy services), *Revue d'Economie Industrielle*, n°57, 3rd quarter.
- Gallouj F. (1994), Cycles économiques et innovations de service : quelques interrogations à la lumière de la pensée schumpeterienne (Economic cycles and innovation in services : some questions in the light of schumpeterian thought), *Revue française d'économie*, Vol. IX, 4, autumn.
- Gallouj F. (1994), *Economie de l'innovation dans les services (Economics of innovation in services)*, Editions L'Harmattan, Paris.
- Gallouj F. (1997), Towards a neo-schumpeterian theory of innovation in services? , *Science and Public Policy*, Vol. 24, n°5, december, pp.405-420.
- Gallouj F. (1992), *Le conseil juridique français : d'une logique professionnelle à une logique d'entreprise (The french legal consultancy : from a professional logic to a business logic)*, in Gadrey J. et al.
- Gershuny J. (1978), *After Industrial Society ? The Emerging Self-Service Economy*, Londres, Mac Millan.
- Gershuny J., Miles I. (1983), *The New Service Economy : the Transformation of Employment in Industrial Societies*, London : Frances Pinter.
- Guile B. Quinn J. (1988), *Managing Innovation : Cases from the Services Industries*, National Academy Press, Washington.
- Henderson R. M., Clark K. B., (1990), Architectural Innovation : The Reconfiguration of Existing Product Technologies and the Failure of Established Firms, *Administrative Science Quarterly*, Vol. 35, n°1, March.
- Kutscher R., Mark J. (1983), The Service-Producing Sector : Some Common Perceptions Reviewed, *Monthly Labor Review*, April.
- Lakshmanan T. (1987), *Technological and Institutional Innovation in the Service Sector*, Colloque "recherche et développement, changement industriel et politique économique", University of Karlstad, Sweden, June.
- Langeard E. Eiglier P. (1990), *L'innovation de service (Service innovation)*, Working paper for the "researchers-professionals meeting on service activities", 6 march, Paris.
- Lovelock C. (1992), *A Basic Toolkit for Service Managers*, in C. Lovelock (ed), *Managing Services : Marketing, Operations, and Human resources*, Prentice-Hall International Editions.
- Miles I., Kastrinos N., Flanagan K., Bilderbeek R., Den Hertog P., Huntik W., Bouman M. (1995), *Knowledge-Intensive Business Services : Users, Carriers and Sources of Innovation*, Rapport pour DG13 SPRINT-EIMS, March.

- Miles I. Wyatt S. (1991), *L'évolution technique des services et leur compétitivité dans le commerce international (The technical evolution of services and their competitiveness in international trade)*, UNCTAD.
- Moulaert F., Chikhaoui Y., Djellal F. (1991), Locational behavior of french high-tech consultancy firms, *International Journal of Regional Research*, vol. 15, n°1.
- Moulaert F., Martinelli F., Djellal F. (1990), *The Role of Information technology Consultancy in the Transfer of Information Technology to Production and Service Organizations*, Nederlandse Organisatie voor Technologisch Aspectenonderzoek.
- Nelson R. Winter S., (1977), In Search of Useful Theory of Innovation, *Research Policy*, vol. 6.
- Normann R. (1984), *Service Management : Strategy and leadership in Service Business*, John Wiley and Sons
- Pavitt K. (1984), Sectoral Patterns of Technical Change : Towards a Taxonomy and a Theory, *Research Policy*, 13.
- Pavitt K., Robson M., Townsend J. (1989) *Accumulation, diversification and organisation of technology activities in UK companies, 1945-83* in Dodgson M. (ed), *Technology Strategy and the Firm : Management and Public Policy*, Longman Harlow.
- Petit P. (1990), *Emploi, Productivité et technologies de l'information : le cas des services (Employment, productivity and information technologies : the services case)*, IRIS Seminar, University of Paris XI Dauphine on "Competences et competitiveness", 5 april.
- Rosenberg N. (1982), *Inside the Black Box : Technology and Economics*, Cambridge University Press.
- Saviotti P., Metcalfe J. (1984), A Theoretical Approach to the Construction of Technological Output Indicators, *Research Policy*, vol. 13, n°3, june.
- Soete L., Miozzo M. (1990), *Trade and Development in Services : a Technological Perspective*, MERIT, The Netherlands.
- Sundbo (1993), *Innovative Networks, Technological and Public Knowledge Support Systems in Services*, Roskilde University, mimeo.
- Sundbo (1994), Management of innovation in services, *The Service Industries Journal* (Forthcoming).
- Tremblay D. (1989), *La dynamique économique du processus d'innovation : une analyse de l'innovation et du mode de gestion des ressources humaines dans le secteur bancaire canadien (The economic dynamic of innovation process : an analysis of innovation and human resource management in the canadian bank sector)*, PhD Thesis, University of Paris I.

**PAPER 3:**

**BEYOND TECHNOLOGICAL INNOVATION:  
TRAJECTORIES AND VARIETIES OF SERVICES  
INNOVATION**

**(Forthcoming as Chapter 7 in Boden and Miles (eds), *Innovation in the Knowledge Based Economy*, Cassell Academics, 1998)**

## BEYOND TECHNOLOGICAL INNOVATION: TRAJECTORIES AND VARIETIES OF SERVICES INNOVATION

**Faïz Gallouj**  
**IFRESI-CNRS**

**(Forthcoming as chapter 7 in Boden and Miles (eds), *Innovation in the Knowledge Based Economy*, Cassell Academics, 1998)**

Technology is undoubtedly, as we noticed it in chapter 2, a core element of innovation in services. However in services more than anywhere else technology is not sufficient to take into account the whole innovation phenomena in services.

The aim of this chapter is to present a set of works that share the goal of going beyond technological innovation without neglecting it. Their general purpose is to display the varieties of forms and trajectories of innovation in services. According to the analytical priority they focus on these works can be divided into two different categories<sup>16</sup> :

- Service based or service oriented approaches, focusing on service specificities in the field of innovation;
- Integrated approaches aiming at adopting a similar approach to the economic analysis of both goods and services. This notion is based on the observation that the boundary between goods and services is becoming increasingly less clear. Certain services are being "industrialised" and, conversely, the production of certain goods is being "tertiarised". These converging tendencies are often described in terms of the *goods-services continuum and functions*. We especially intend to try and enrich and operationalise these approaches by using a characteristics representation of the product drawn upon the work of Lancaster (1966) and Saviotti and Metcalfe (1984).

### **1. Service oriented approaches**

The starting point for the less familiar approaches that we describe as "service-oriented" is the notion that innovation can exist where the "technologist" gaze perceives nothing. Without ignoring the technological dimension, these approaches focus on non-technological forms of innovation ; in this respect, they are following the precedent set by Schumpeter, whose definition of innovation was particularly broad and open.

#### **1.1 Core and peripheral services approach**

---

<sup>16</sup> For a more comprehensive survey cf. F. Gallouj (1994), C. Gallouj and F. Gallouj (1996).



In this approach proposed by management science and especially marketing students (Flipo, 1984 ; Shostack, 1984 ; Norman, 1984 ; Eiglier and Langeard, 1987 ; Jallat, 1992) services are defined as the bundling of two sets of activities : core services and peripheral ones. For a given core service, peripheral services make "product" differentiation possible, and are often at the basis of competitive edge.

Eiglier and Langeard (1987) for example make the following distinction between a new service and the extension of an existing service : a new service requires the design of a new core service whereas the extension of an existing service is mainly made possible by the addition of a new peripheral service.

Although it is interesting this approach applies more to consumer services than to business services especially the more knowledge intensive among them.

## 1.2 Financial services innovation theory

Analyses of financial innovation based on the demand for certain characteristics (Hardouin, 1973; Desai and Low, 1987) have developed independently with a view to providing a theory that applies solely to financial services. In that sense they can also be considered as service-oriented approaches. However in the approach we have adopted below (§3), these analyses constitute only one particular illustration of a general model that can be applied to all goods and services.

Hardouin (1973) formalises this analysis as follows. A monetary and financial instrument  $T_i$  can be defined a priori or a posteriori by a finite set of "n" characteristics and can therefore be written in the form of a vector with n dimensions in which the  $t_{ij}$  indicate the extent to which property j is incorporated in instrument i.  $T_i = (t_{i1} \dots t_{ij} \dots t_{in})$ . Thus if the instrument  $T_i$  does not have property j,  $t_{ij} = 0$ . Innovation appears in the following two cases: a variation in  $t_{ij}$ , i.e. a variation in the extent to which the existing property j is incorporated in the instrument (e.g. the instrument is more liquid), and the activation of a property that did not previously exist (transition from  $t_{ij} = 0$  to  $t_{ij} \neq 0$ ).

A first example is provided by Desai and Low (1987), who are concerned with financial assets and define them in terms of two characteristics, namely access (liquidity) (A) and return (yield)(R). The diagram thus constituted (Figure 1) makes it possible to locate and describe existing assets:

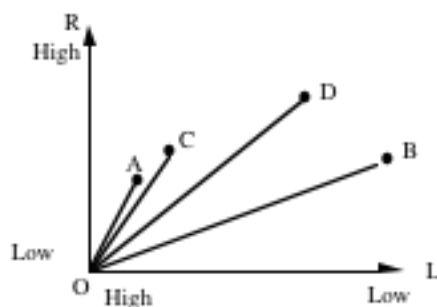

**Figure 1 : Representation of financial products in a diagram of characteristics** Source: After Desai and Low (1987)

Since reference assets A and B are characterised by a low return and high liquidity and a higher return and low liquidity respectively, Desai and Low consider the development of asset C as a "*trivial innovation*", since the distance between A and C in terms of characteristics, as measured by the angle (OA, OC), is small. On the other hand, asset D is an "*important innovation*", since it fills an "empty space" between the two reference assets.

Another example is provided by Niehans' analysis (1983). Assuming that any financial service, from the simplest to the most complex, can be represented by a given combination of the following three functions or characteristics: the exchange of current money against future money, the linking of borrowers and lenders, the making of payments in the name of a client, this author defines innovation as any new way of combining these three aspects.

Niehans also introduces an interesting distinction between irreversible combinations (innovations), which he describes as "*technological*" but which are not limited to material technologies since they include double-entry book-keeping, which was invented at the end of the Middle Ages, and those that are more reversible and cyclical, which he terms "*adaptive innovations*". Innovations in this latter category disappear as soon as the conditions that encouraged their development have themselves disappeared.

### 1.3 The commercial innovation school

Like specialists in the financial services industry, students of retailing have sought to develop "local" theories of innovation adapted to their particular field. In consequence, this section given over to "services oriented" approaches seeks to give an account of these various theories.

The most important of them relate to the dynamic of shop formats, which are conceived of in terms of life cycle. Thus the "wheel of retailing" model (McNair, 1958) can be summarised as follows :

- 1) All new forms of retailing appear first in a "discount" version, i.e. outlets offer a limited range of goods and services and the main objective is to maximise sales volumes.
- 2) Their success causes the "wheel" to revolve as retailers gradually "trade up" by adding new products and services to the original ranges ; this leads in turn to increased operating costs and higher prices.
- 3) This "bourgeoisification" of the retail form opens up the market for new, more "Spartan" entrants (to borrow the terms used by Tarondeau and Xardel, 1992).

Other analyses couched in terms of cycles, which cannot be outlined in any detail here (cf. C. Gallouj, 1997), have extended the "wheel of retailing" model":

- Goldman's analyses (Goldman, 1975) distinguish between various possible forms of "trading up" or ways of causing the wheel to revolve by the degree of innovation in goods or service they introduce into the range ;
- in the "accordion theory" (Hollander, 1966) the retailing dynamic is characterised by alternation between outlets offering a wide, non-specialist range of products and those with a narrow, specialised product range.

However, the cycle model in its various forms, as well as Barras' reversed cycle model (cf. chapter x), cannot account adequately for the wide diversity of forms of innovation in the retail sector. These retail cycle models are concerned only with innovation in shop format (i.e. organisational innovation). However, even in this particular case, they are trapped within a binary logic (low/high prices; wide/restricted product range) and fail to take full account of the diversity of new shop formats and of new forms and new channels of distribution.

Nor do these models take account of the following forms or areas of innovation, most of which require detailed investigation if they are to yield up their secrets:

- new methods of selling (mail order, door-to-door selling ...);
- new products and services retailed in stores;
- new products and services designed by the retailer or on his initiative;
- new processes (or new forms of organisation and operation) within the same format, whether based on the introduction of new technologies or not (within the same form of retail outlet or within the environment - customers, suppliers, other stores - of the form under consideration).

#### **1.4 Ad hoc innovation, formalization trajectories, service trajectories**

Studies based on this service oriented approach often take the "purer" services as their field of investigation, i.e. those in which the criteria of intangibility and the coproduction of output are assumed to be most evident. Consultancy services, for example, are an interesting area for empirical analysis of service-oriented innovation.

*Deep investigations of consultancy firms (F. Galloway, 1991, 1994, 1995)* make it possible to highlight in particular the existence of ad hoc forms of innovation that are not immediately reproducible and of institutional "formalization" trajectories (i.e. the search for a certain degree of formalization, though not necessarily, or even predominantly, in tangible form). More precisely these investigations highlight the three following forms of innovation.

##### **1.4.1 Ad hoc innovation**

This type of innovation consists of creating and utilizing synergies out of available knowledge and experience accumulated in the course of past practice, in order to create original solutions (for organizational, strategic, fiscal... problems), new knowledge, and higher-value knowledge in cooperation with clients. Examples that can be cited include the numerous unprecedented ad hoc legal solutions sweeping into the cracks in the system, or the specification by different types of consultants of particularly novel strategies that confer a certain competitive advantage on the client.

As far as it is often produced in cooperation with the client and it is generally "non-programmed" (Zaltman et al., 1973), *Ad hoc* innovation raises appropriation and reproducibility issues. If the client participates in the production of innovation, to whom does it ultimately belong? How is this appropriation to be formally implemented? In the case of *ad hoc* innovation, these two levels of appropriation are both difficult to determine. As regards reproducibility, however, even if the service cannot be reproduced totally,

knowledge, experience (whether codifiable or not), tacit and idiosyncratic techniques resulting from practice, methods utilized for their production and transfer, can, for their part, be reused.

*Ad hoc* innovation is a frequent form of innovation within consultancy (especially legal and strategic consultancy) although it is not taken into account by economic analysis. Generally speaking it is hardly spectacular, and in this regard a number of professional assert : "our innovations are invisible".

#### **1.4.2 Expertise-field innovation**

Based upon surveying and listening to the environment and the client's problems, this form of innovation consists of detecting new needs and responding to them through a procedure of accumulating knowledge and expertise. In the case of legal consultancy, examples include investments by innovators in new potential fields of law (upper space, information technologies, consumerism, environmental protection...). However, innovation remains only potential, and will only be materialized in an interaction with the client. As a consequence, it requires a certain amount of marketing work which, in the field of consultancy, most often comes in the form of participation in conferences, publication of studies or books, etc.

Expertise-field innovation determines the long-term growth of activity. The essential results of this form of innovation are the opening of new markets, diversification (internal or external) or renewal of product ranges, and creation of a competitive advantage or monopoly in terms of knowledge and expertise.

#### **1.4.3 Formalization innovation**

This is a more heterogeneous type of innovation which through different means, aims to lend a "material" form to services. Among these means can be counted :

- the "script" design i.e. the formal specification of the stages of the process and their content (up to a certain point). The methods, and innovation in the methods, play a fundamental role here since they make up the skeleton of this invisible or mysterious animal that is consultancy ;
- the incorporation, at certain points in the process, of technical tools adapted to the demands of consultancy ;
- the contents and organization of packages, whether it be by unbundling a general service or by bundling up the basic units of service (Bressand and Nicolaïdis, 1988, Henderson and Clark, 1990) ;
- organizational innovations. A new service provided to the client can be materialized in a new organization ;
- tool kits (in a restricted sense, in which the marketing dimension predominates).

To conclude this point we could add that the three previous forms of innovation may either have an autonomous existence or be combined or interact (figure 2). Expertise-field innovation seems to be a core component in this interacting system in the sense that it may be followed by *ad hoc* and/or formalization innovation. However expertise-field innovation may occur simultaneously with formalization innovation. This is what happens when a new field of expertise is detected and exploited and when methods and tools are built without delay and independant services defined among the new expertise field. Furthermore figure 1

(dotted line) shows that *ad hoc* innovation is a source of ideas both for methods improvements (formalization innovation) and for new expertise field detection.

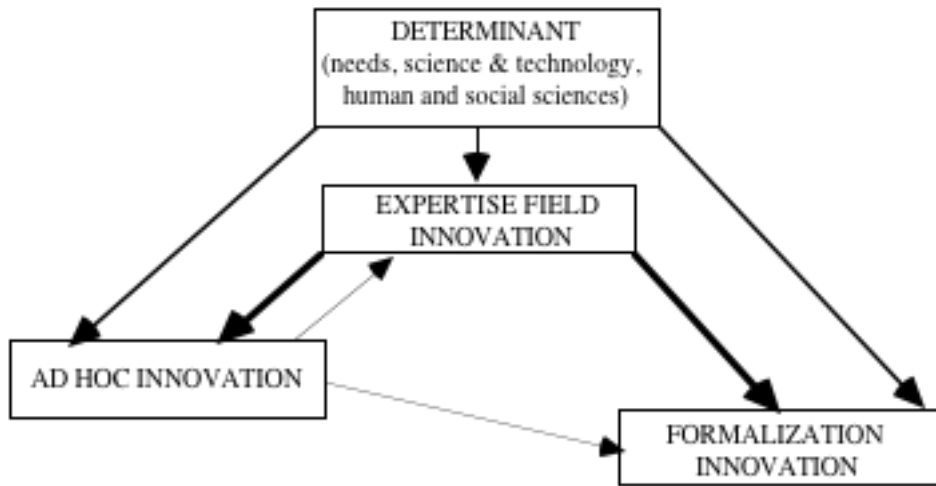

**Figure 2: The main links between the different forms of innovation in consultancy services**

The studies by Van der Aa and Elfring (1993), Gadrey et al. (1993, 1994) and Sundbo (1993, 1994, 1996) also take a broad, Schumpeterian view of innovation. According to Sundbo (1993, 1994, 1996) innovations in services do not follow a technological trajectory (in Dosi's sense) but rather "service-professional trajectories" (e.g. a certain number of ideas on management, banking, etc.) in which technologies are only one vector among several others. Van der Aa and Elfring's study (1993) displays two main general categories of innovation in services: technological innovations which need to be splitted into "information technologies" and "other forms of technologies" ; and (pure) organizational innovation which comprises : new combinations of services and new services ; the different ways of making customers co-producers ; multi-unit organisation and chain-formation (cf. Figure 3).

Innovations in services				
Technological innovations		(Pure) organisational innovation		
Information technologies	Other technologies	New services and new bundles of services	New ways of working with customers as co-producers	New multi-unit organisations and chains

**Figure 3 : Different types of innovation in services (Van der Aa and Elfring, 1993)**

## 2. Functional approaches

In order notably to avoid the difficulties of the distinction between product innovation and process innovation some works favour a functional approach rejecting the opposition between goods and services. The hypothesis underlying these works is that clients are less interested in a good or in a service than in meeting a need (a function). Two attempts deserve attention.

### 2.1 From "Vector" concept to forms of innovation

Belleflamme, Houard and Michaux (1986) base their analysis of innovation upon the heuristic notion of "Vector" which they define as "the set of means and conditions necessary and sufficient for the preparation and existence of a product". They formalize the Vector as follows :

$$V = I + bP + cS$$

where P is the production process ("set of material means for the preparation of the product") ; S is the servuction process ("set of means and conditions for the "consumerization" of the product" i.e. "for the differentiation and adaptation of the product to the user's specifications") ; I, the set of elements of the general organization of the firm. The coefficients b and c represent the relative importance of production and servuction processes i.e. if  $b > c$  the goods dimension is most important while if  $b < c$  the service dimension is most important.

The authors distinguish several forms of innovation according to the component of the Vector which the innovation acts on :

- the introduction of a *new service* ;
- the introduction of a *new production process* or the improvement of the previous one ;
- the introduction of a *new servuction process* or the improvement of the previous one (certain technological systems such as computers belong to the "production process" when located in back-office and to the "servuction process" when used in front-office)
- any combination of the three previous forms.

However this classification doesn't take into account the variable I of the "Vector" although it may be an important locus of innovation. Furthermore neither the problem linked to the high subjectivity of the notion of novelty in the field of services nor the distinction between product and process are puzzled out. And finally servuction, production and service innovation oftent overlap.

## 2.2 Functional, specification and production innovation

The study by Barcet, Bonamy and Mayère (1987) adopts a functional approach and results in a classification of the forms of innovation that applies to both goods and services. These authors categorise innovations according to whether they relate to function, specification or the production process.

— The first category (*functional innovation*) encompasses the emergence of new, undifferentiated, abstract functions, such as the storage of picture and sound in the case of video recorders, or the identification of a new risk to be covered in the insurance industry. Its appropriability regime is relatively low.

— The second (*specification innovation*) involves the concrete realisation and differentiation of the functional innovation. The aim is to design products and services different from those of competitors, adapted to different types of clients and of easier appropriability regime. Among innovation by specification are fast food catering, ATM money distribution, home booking, in the case of services and the evolution of cars in the case of goods.

— The third category (*production innovation*) corresponds to a cost-cutting trajectory (as a result of standardisation, the use of new technical instruments especially in the back-office, etc.). Production innovation mainly corresponds to "mass services" such as banks, insurance

companies, social services... However it can be developed in consultancy services as well (expert systems...).

As far as it is synonymous respectively of new functions, new services and new processes this typology is still reflecting the traditional ambiguities between product and process. Furthermore the distinction between functional and specification innovation even though analytically useful seems to be difficult to put into practical use. "Specificity" is a subjective notion and the frontiers of a "function" are difficult to grasp.

### 3. A unified model of characteristics and competences in product/services

The characteristics approach derived from Lancaster, which it is our intention to develop here, is also integrative. Firstly, it encompasses both goods and services. Secondly, it applies both to technological innovation itself and to the non-technological forms of innovation. Such an approach is sufficiently flexible to make it possible to grasp in the same analysis both goods and services without neglecting service specificities in terms of innovation<sup>17</sup>. It can be seen as a way of clarifying and making more operational the earlier functional approach, which proved to be too general. This is what we propose to demonstrate now.

According to Saviotti and Metcalfe (1984) inspired by Lancaster, *the provision of any type of "product" can be described in terms of a set of characteristics* that reflect, on the one hand, the internal structure of the product in question and, on the other, its external properties, i.e. the type of service being offered to users. Saviotti and Metcalfe divide these characteristics into three main types :

— *The final or service characteristics*. These are the characteristics of the product seen from the point of view of the end user, e.g., in the case of a car, its size, performance, comfort, safety features, etc.

— *The "internal", technical characteristics* comprise the characteristics of the various technical mechanisms used to obtain the final characteristics. In the case of a motor car, for example, they would include the type of engine, transmission, suspension and so on.

— *The process characteristics*, finally, relate to the methods by which the product in question is produced, and the technologies and modes of organisation involved (the materials used, the ways in which they are processed, the forms of energy, the organisation of the process, etc.). Thus they include all the technologies used in the design, production and marketing of products. In the case of the motor car, for example, the assembly line is a process characteristic.

Despite some difficulties (see Gallouj and Weinstein, 1995, 1998 and Gallouj, 1997) these three types of characteristics can be transposed to the representation of a service as following examples show it :

— The characteristics of an automated telling machine service in a bank will reflect in particular the various uses to which it can be put (deposits, withdrawals, balance enquiries, ordering cheque books, etc.) and the ease with which it can be used ("user-friendliness"). In

---

<sup>17</sup>The analysis developed in this section is based upon a research work carried out together with O. Weinstein (Gallouj, Weinstein, 1995 and 1997).

the case of monetary and financial instruments, Tobin, for example, suggests that the main characteristics of a service constitute a finite set in which liquidity, divisibility, reversibility/substitutability, yield, income, predictable final value, ease of exchange, risk, etc. feature prominently.

— In the case of services, technical characteristics of a product may be material technologies in the usual sense of the term, particularly information technologies. However, the service characteristics of a product are also produced through the implementation of specific *intangible "technologies"*, such as legal or financial expertise, or mathematical instruments (economic and financial modelling, operational research methods), for example. One of the major features of service activities is undoubtedly the fact that these "technologies" usually take the form of knowledge and competences embodied in individuals (or teams) and implemented directly when each transaction occurs, rather than in physical equipment.

— *In services process characteristics are difficult to separate from technical characteristics.* To try and draw a kind of boundary between them we could consider that *technical characteristics concern mainly front-office "techniques" whereas process characteristics concern back-office ones.* For example, insurance products require suitably adapted back-office management systems which may count as process characteristics.

We shall add to Saviotti and Metcalfe's formalisation *the range of competences mobilised* by the various technological elements that constitute a product. In the case of services, as we stressed earlier, these competences (and especially the more formalized among them) are often contained within the technical characteristics. We shall consider them separately here, in order to take account of situations in which service providers make direct use of such competences in order to provide the service characteristics ("pure service").

In order to take into account one of the fundamental characteristics of service activities, particularly "knowledge-intensive" ones, namely client participation in the production of the service characteristics  $[Y_i]$  (coproduction) *we propose to introduce into our diagrammatic representation a distinction between two types of competence : those of the service provider (column vector  $[C_k]$ ) and those of the client (linear vector  $[C'_k]$ ).* The coproduction relationship, therefore, is represented by the combination of the terms of the two vectors. There are several reasons for taking account of this client/provider interface. Firstly, it may itself be the subject of innovations (organisational changes, interface management methods, etc.) ; secondly, it is the "laboratory" where a form of innovation often neglected in economic analysis, ad hoc innovation (cf. § 4.4), is initiated ; finally, the quality of the client firm's competences ( $C'_1 C'_2 \dots C'_k$ ) is one criterion for the success of innovations and technology transfer (in the broadest sense). In this respect, it may be useful to make a distinction within the vector  $[C'_k]$  between the technological competences of the client firm (i.e. the areas of knowledge in which it has expertise) and its capacity to absorb and assimilate new competences. The management of this interface, i.e. of the combination or conjunction of  $[C'_k]$  and  $[C_k]$ , may offer a solution to the awkward question of protecting innovation in services. A service provider may in fact be able to develop highly complementary combinations of  $[C'_k]$  and  $[C_k]$  that encourage a form of dependency known as "customer lock-in", which is relatively common in the computer services field.



The most general and most significant representation is the one shown in Figure 4. The relation  $[X_j] \leftrightarrow [Y_i]$  displaying how services characteristics are obtained by the combination of technical characteristics is the one proposed by Saviotto and Metcalfe (1984).

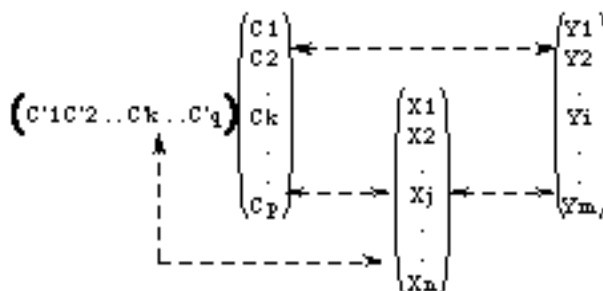

**Figure 4 : The representation of a product (good or service) as a system of characteristics and skill**

In the general formalization, provision of service characteristics  $[Y_i]$  (i.e. the product or service) requires both a) the direct implementation of knowledge and competences (embodied in individual members not only of the provider firm  $[C_k]$  but also of the client company  $[C'k]$ ) and b) the mobilisation of "technical" factors (the  $X_j$ ). These factors consist of knowledge that is codified and formalised in such a way that they can be used repeatedly for the provision of similar services or of services of different kinds (depending on whether they are more or less generic or specific). They may be tangible (computer or telecommunications systems) or intangible (modelling methods, legal expertise, etc. Thus they are codified and formalized  $[C_k]$ ).

In most cases these two patterns a) and b) are combined but we can consider that the ideal-type relation  $[C'k][C_k] \leftrightarrow [Y_i]$  represents the "pure service" pattern in which competences are directly implemented to provide service characteristics without using any technical characteristic either material or immaterial (methods).

Finally, it should be noted that the system  $\{[C'k], [X_j], [Y_i]\}$  through which the consumer makes direct use of his knowledge and competences represents in particular the various ways in which the client himself is "put to work" within the service firm: self-service situations (super/hypermarkets, fast-food restaurants, self-service banking, etc.), hiring of various equipment (such as vehicles, for example).

#### **4. Trajectories and modes of innovation revisited**

On the basis of the previous representation six modes of innovation can be envisioned.

##### **4.1 Radical innovation**

It is the creation of a totally new product, i.e. one defined in terms of a system of characteristics and competences  $\{[C^*], [X^*], [Y^*]\}$  unconnected with those of an old product. The design and marketing by insurance companies of care and assistance products may, for example, be seen as a radical innovation that has changed the entire system.

Companies offering these products are no longer selling life insurance, savings or damage insurance products but are actually providing services. The technologies used are different (alarm, monitoring, communications and transport systems, social networks, specific commercial networks), and the service characteristics are different: it is no longer a case of making a money payment when a specified event has taken place, but rather of providing a more or less complex service (housing, health care, transport, etc.). The vector of competences is also modified as a result of course.

#### ***4.2 "Improvement innovation"***

According to the strictest definition, this type of innovation consists simply of improving certain characteristics, without any change to the structure of the system. The value of certain  $Y_i$  is increased either directly, by improving certain  $C_p$ , or by improving certain  $X_j$ . This is due more to the learning effects that normally accompany any activity than to innovation in the strict sense of the term. Nevertheless, this type of innovation cannot be ignored: the extent and cumulative nature of its effect on overall productivity are widely recognised.

These two first modes of innovation are nodal traditional forms. However, it is possible to envisage three other major modes of innovation.

#### ***4.3 Incremental innovation (innovation by substitution or addition of characteristics)***

The general structure of the system  $\{[C], [X], [Y]\}$  remains the same, but the system is changed marginally through the addition of new elements to  $[X]$  and/or  $[Y]$  or through the substitution of elements (Figure 5). This may involve, for example, the addition of one or two new characteristics to a certain type of product, either by directly mobilising certain competences or by adding new technical characteristics. It is certainly difficult clearly to define the boundary between this mode of innovation and the previous one, i.e. to distinguish the moment at which a new characteristic is added (e.g. the addition of a guarantee to meet deadlines) from the one at which a simple improvement is made (reduction in deadlines or delivery times). It is often the desire to formalise the improvement as a new *specification* that makes the difference: the transition from a mode to another can therefore be interpreted as a social construction.

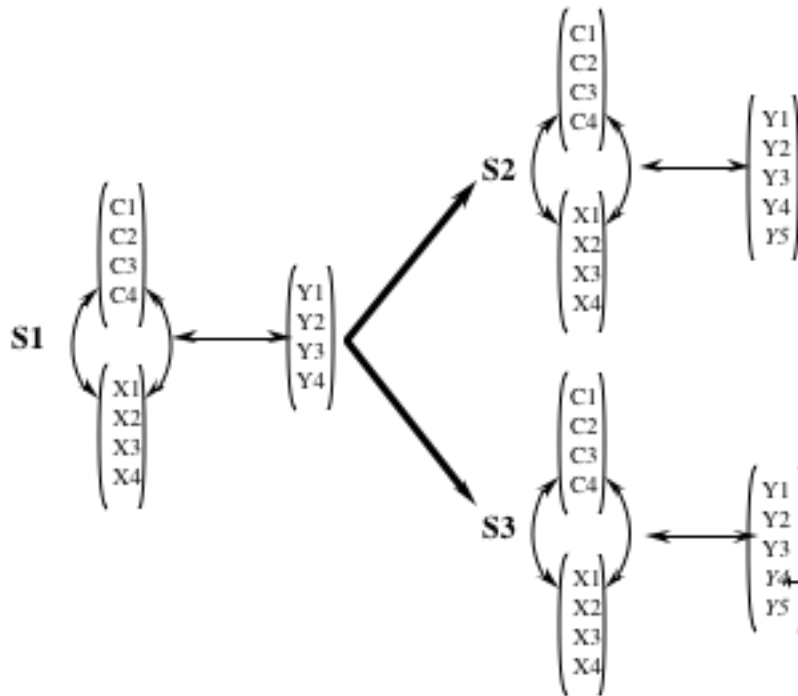

**Figure 5: S2 : incremental innovation through the addition of characteristics (Y5) ; S3 : incremental innovation through substitution of characteristics (substitution of Y5 for Y4)**

Staying with improvement and incremental innovation categories, the argument can be advanced even further, firstly by introducing the distinction already noted above between improvements to or the addition of main or complementary characteristics. Secondly, the distinction made by Baily and Gordon (1988) between a "proportional" innovation, which increases the quantity and/or quality of the service characteristics (i.e. the performance of the product, for example, the power, processing speed or memory of a computer) to the same extent as the cost of the resources use, and a "non-proportional" innovation, which increases performance by a greater extent than the cost of the resources, may also prove useful from this point of view.

It should be noted that non-proportional innovations seems to be particularly common in service activities. Easingwood (1986), for example, makes a distinction between change and innovation in "software" (what we call service characteristics) and in "hardware" (what we call here technical characteristics in the strict sense [X<sub>j</sub>] and process characteristics). The "newness" of new services lies in the intangible software dimension, while the hardware dimension remains unchanged. For example, an airline might introduce a ticket with new conditions attached to it (software change). However, this new product will be provided by means of the same aeroplanes, crews, reservation systems, etc. In other words, "software" innovations will tend to proliferate in service activities.

#### **4.4 Ad hoc innovation**

Ad hoc innovation can be defined in general terms as the interactive (social) construction of a solution to a particular problem posed by a given client. It is a very important form of innovation in consultancy services as we already mentioned it and also in "informational services", as defined by De Bandt (1995), and more generally in other services involving a

high-level degree of interaction between provider and client. In ad hoc innovation the available knowledge and experience accumulated over time are harnessed and put to work synergistically in order to create fresh solutions and new knowledge that changes the client's situation in a positive and original way.

The service characteristics  $[Y_i]$  (output) of an ad hoc innovation can be seen as an original solution, or a set of original solutions, of an organisational, strategic, legal, fiscal, social or human nature that emerges in response to a (partially new) problem. From the point of view of the service provider, an ad hoc innovation helps to produce new knowledge and competences that have to be codified and formalised in order that they might be re-used in different circumstances. There is thus a significant change in the vector of competences  $[C_k]$ , and particularly in the intangible elements of the technical characteristics  $[X_j]$ . This a posteriori codification and formalisation of certain elements of a given solution in order that it may be partially and indirectly reproduced is what distinguishes ad hoc innovation from the ad hoc nature of many service transactions.

As a product of the client/provider interface, ad hoc innovation, particularly in consultancy activities, depends on the nature of that interface and the various elements of which it is made up.

Thus interfaces of the "sparring" type (coproduction) are more conducive than those of the "jobbing" type (subcontracting) (Gadrey et al. 1992) to the creation and success of this form of innovation, since they enable the innovation to be better understood and accepted (legitimated). Moreover, problems of a strategic nature, which are potential sources of innovation, are usually tackled in interfaces of the "sparring" type: they are seldom subcontracted.

In particular, the existence of this interface helps to limit the reproducibility of an ad hoc innovation in its original form. However, the knowledge, the experience (whether codifiable or not) and the unformulated, idiosyncratic techniques that emerge from practical experience and the methods used to produce and transfer them can be reproduced. Ad hoc innovations are profitable, even if they are not reproducible, since they are based on an informational and cognitive input that can be transferred in part to other ad hoc situations.

What is generally known as **customised innovation** can be included in both incremental and ad hoc modes of innovation. In the case of the insurance industry, for example, (Gadrey and Gallouj, 1994) "*adapted customised*" innovations, in which a standard contract is tailored to suit a particular client (or often a whole market segment) by changing the rates or introducing certain additional clauses, could be included in incremental innovation category. On the other hand, "*fully customised*" innovations, in which a genuinely new contract is drawn up for a specific client (often a large company), and "*cover for special risks*", in which insurance is provided against a risk that might affect very small populations (for which no statistics are available) would be included in ad hoc innovation category, since the ad hoc element is much more significant.

#### ***4.5 Recombination innovation***

A final and major mode of innovation frequent in services but also in microelectronics and biotechnologies industries is what might be called recombinative innovation (cf. Foray 1993) or architectural innovation (Henderson and Clark 1990). Innovation of this kind

exploits the possibilities opened up by new combinations of various final and technical characteristics, derived from an established stock of knowledge and a given technological base or existing within a defined technological trajectory. Taking as its starting point the final and technical characteristics of an existing family of products and technologies, it forms the basis for a relatively routine method of producing innovation through the systematic re-utilisation of certain "elements" or "components". This does not mean that the creation of a new product through a new combination of characteristics does not require specific competences, considerable development work and a not insignificant amount of creativity.

Innovation based on the addition of characteristics can be considered as a form of recombinative innovation, particularly when the characteristics added have their origins in pre-existing products. There are two other possible forms<sup>18</sup> which, in the field of services, have been particularly highlighted by Bressand and Nicolaidis (1988). The first involves the creation of a new product by combining the characteristics of two or more existing products (Figure 6), while the second involves the creation of new products by splitting up an existing product, separating out various characteristics and turning certain elements into autonomous products (Figure 7). This second case can be illustrated by the example of recruitment consultants. Broadly speaking, a recruitment service provides the service characteristics inherent in four types of sequential activities: the analysis of the client organisation's needs, the choice of a method of approach (direct, through advertisements, etc.), the selection of candidates, their monitoring and the assistance in integrating them into the firm. In accordance with the principle of architectural innovation, consultancy companies have split up this generic service in such a way as to provide perhaps only that set of service characteristics specific to one or more phases of the combination outlined above.

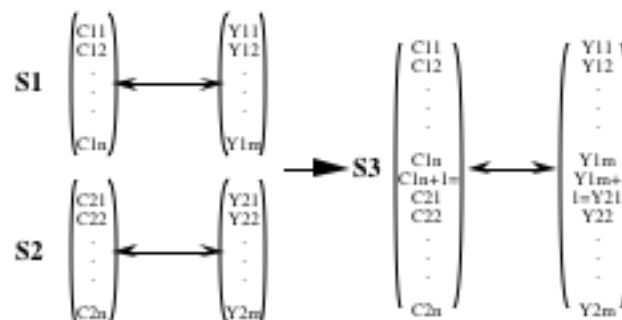

**Figure 6: A new service (S3) produced by recombining the characteristics of two existing services (S1 and S2)<sup>19</sup>**

<sup>18</sup> However, a distinction should be made between combinations of characteristics and combinations of modules (which is one of the technical forms in which architectural innovation commonly manifests itself).

<sup>19</sup> In order to simplify the analysis we consider in figure 6 and 7 the case of "pure service".

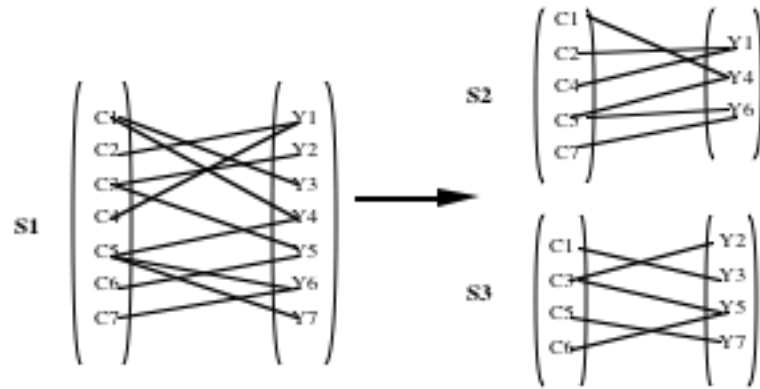

**Figure 7: Two autonomous new services (S2 and S3) produced by splitting up the characteristics of an existing service (S1)<sup>20</sup>**

#### **4.6 Formalisation innovation**

The various models of innovation outlined above are based on qualitative or quantitative variation in technical or service characteristics or competences (addition, elimination, improvement, bundling, unbundling). There is a final model in which it is not quantity or quality that varies, but rather the “visibility” and the degree of standardisation of the various characteristics.

This model, which we shall call the formalisation model, consists of putting the service characteristics “into order”, specifying them, making them less hazy, making them concrete, giving them a shape.

This objective is often achieved by putting in place technical characteristics, whether tangible (equipment, software, etc.) or intangible (e.g. methods, organisation, toolboxes).

This formalisation model also constitutes an attempt to clarify the correspondences between these technical characteristics and the service characteristics.

Putting the service characteristics “into order” frequently involves the transformation of a general function into sub-functions or service characteristics. This general process makes it possible to understand why this formalisation model often precedes the recombination model.

In many services, including knowledge-intensive ones, this formalisation model constitutes a genuine “natural trajectory”, in the sense of the term adopted by Nelson and Winter.

There are plenty of examples of this model. They are found in the cleaning industry, where Sundbo (1996) highlights the growing importance of what he calls modularisation. They are also found in the fast-food industry (cf. the organisation of work at McDonald’s, analysed by Levitt, 1972). Legal consultancy also provides examples. The service known as “legal

<sup>20</sup> In reality, the “autonomous” existence of S2 and S3 (and, in Figure 6, the existence of S3 as a combination of S1 and S2) constitutes an additional service characteristics that has to be incorporated into the vectors.

audit”, for example, has always been provided by consultants more or less automatically and always informally. The formalisation process consisted of finding a name for the service and establishing (following the model of financial auditing) reference points or methodological markers by which it could be defined. In this case, as in the other, the various elements can be said to have “existed” implicitly beforehand: they are rendered explicit through a process of social construction. It should be noted that this process of formalisation innovation was followed by implementation of the recombination model, in which the general legal audit is broken down into a number of specific audits: contract audits, patent audits, etc., all of them “products” that can be given an independent existence and be sold as such.

The ultimate configuration of this formalisation model is the one that leads to the production of a real object that can be reduced to Saviotti and Metcalffe’s original representation. This is the case, for example, with the development of expert systems. The substitution of ATMs for transactions over the counter falls within the scope of this model.

## **Conclusion**

In this chapter we have addressed the question of the variety of innovation forms and trajectories in services by focussing on service oriented approaches and integrative approaches. Drawing upon the works of Lancaster and Saviotti and Metcalfe we have sought to enlarge and operationalize integrative approaches.

As we have just shown, an approach to products in terms of final, technical and process characteristics offers a stimulating starting point for the study of innovation in services. Such an approach is sufficiently flexible to include both goods and services without sacrificing any of the specific aspects of innovation in services. Various modes of innovation are highlighted (radical innovation, innovation based on improvement, innovation involving the addition of new characteristics, ad hoc innovation, recombinative innovation) and interpreted in terms of a characteristics dynamic.

This approach has implications for traditional theories of innovation, some aspects of which have already been mentioned and to which we now return by way of conclusion.

Description of a product in terms of characteristics clearly reconciles the "science-push" and "demand-pull" approaches to innovation: science, denoted by the vectors [C] and/or [X], and the demand for service characteristics, denoted by the vector [Y], constitute the two facets of the product (good or service). An innovation may use one of these two points of entry, or both at the same time. The "science-push" determinant, it should be noted, cannot be limited solely to the physical sciences, however: it also takes account of progress in the social sciences. [X] and [C] respectively encompass not only technologies in the narrow sense of the term and the competences relating to those technologies, but also the "technologies" specific to services (legal, financial, commercial, etc.) and the competences corresponding to them.

This has consequences for the definition and content of technological trajectories in services. In Saviotti and Metcalfe's approach, the "technological regime" (in Nelson and Winter's sense) or the "dominant design" (in Abernathy and Utterback's sense) correspond to a given list of technical characteristics  $X_j$ . A "technological trajectory" is a path of gradual improvement in the  $X_j$ . In the case of services, the term takes on a particular

meaning, since it can refer as well (or indeed exclusively) to service "technologies" (financial, actuarial, human resource management etc.). These technologies are also characterised by "lock-in" phenomena: it is difficult to envisage a return to Taylorism in areas where other techniques of work organisation have been tested. It is also possible in the "purest" services to introduce cognitive trajectories: the accumulation of expertise, individual and collective learning processes, gradual improvement of the Ck. In this case, the technological regime can be renamed the cognitive regime, thus constituting a general frame of competence formalised by a list of cognitive characteristics (Ck).

Even though certain modes of innovation (such as recombinative innovation) are particularly important today, it does not seem possible to articulate the various modes of innovation over the course of a product's life cycle. Barras' attempt to do so (cf. chapter x) is interesting but reductionist in terms of modes of innovations.

### **Bibliography:**

- Baily M., Gordon R. J., *The Productivity Slowdown, Measurement Issues and the Explosion of Computer Power*, Brookings Papers on Economic Activity, n°2, 1988, pp. 347-431.
- Barcet A., Bonamy J., Mayère A., *Modernisation et innovation dans les services aux entreprises* (Modernisation and innovation in business services), Report for Commissariat Général du Plan, 1987.
- Belleflamme C., Houard J., Michaux B., Ruysen O., *Innovation and Research and Development Process Analysis in Service Activities*, IRES, FAST report, 1986.
- Bessant J., Rush H., "Building bridges for innovation : the role of consultants in technology transfer", *Research Policy*, 24, 1995.
- Bressand A. Nicolaïdis K., "Les services au cœur de l'économie relationnelle" (Services in the heart of the relational economy), *Revue d'Economie Industrielle*, 43, 1988.
- Desai M., Low W., *Measuring the Opportunity for Product Innovation*, in De Cecco M. (Ed), *Changing Money : Financial Innovation in Developed Countries*, Basil Blackwell, 1987.
- Djellal F., *Changement technique et conseil en technologie de l'information (Technical change and information technology consultancy)*, Editions L'Harmattan, 1995.
- Easingwood C. J., New Product Development for Services Companies, *Journal of Product Innovation Management*, Vol. 3, December, (1986) pp. 264-275.
- Eiglier P. Langeard E., *Servuction : le marketing des services (Servuction : the services marketing)*, Mc Graw-Hill, 1987.
- Flipo J.-P., *Le management des entreprises de service (Service firms management)*, Les éditions d'organisation, Paris.
- Foray D., *Modernisation des entreprises, coopération industrielle inter et intra-firmes et ressources humaines, (Firms modernisation, inter and intra-firms industrial cooperation and human resources)*, report for the Ministry of Research and Technology, 1993.
- Gadrey J., Gallouj F. (1998), The Provider-Customer Interface in Business and Professional Services, *The Service Industries Journal*, Vol. 18, n°2, April, pp. 1-15.
- Gadrey J., Gallouj F., Weinstein O., "New modes of innovation : how services benefit industry", *International Journal of Service Industries Management*, volume 6, n° 3, 1995.
- Gadrey J., Gallouj F., *L'innovation dans l'assurance : le cas de l'UAP, (Innovation in insurance : the case of UAP)* Report for Union des Assurances de Paris, IFRESI, University of Lille I, September, 1994.



- Gadrey J., Gallouj F., Lhuillery S., Ribault T., Weinstein O., *La recherche-développement et l'innovation dans les activités de service : le cas du conseil, de l'assurance et des services d'information électronique, (R-D and innovation in service activities : the case of consultancy, insurance and data bases services)*, Report for the French Ministry of research, December 1993.
- Gallouj C., Gallouj F., *L'innovation dans les services (Innovation in services)*, Editions Economica, 1996.
- Gallouj C., *Innovation in french retailing*, preliminary report for DG XII, TSER program, march, 1997.
- Gallouj F. "Cycles économiques et innovations de service : quelques interrogations à la lumière de la pensée schumpeterienne", (Economic cycles and innovation in services : some questions in the light of schumpeterian thought), *Revue française d'économie*, Vol. IX, 4, autumn 1994.
- Gallouj F., *Economie de l'innovation dans les services (Economics of innovation in services)*, Editions L'Harmattan, Logiques économiques, Paris, 1994.
- Gallouj F., La production de l'innovation dans les services de conseil (The production process of innovation in consultancy services), *Revue Française de Gestion*, march-april-may, 1995.
- Gallouj F., Les déterminants de l'innovation dans les activités de conseil (The determinants of innovation in consultancy services), *Revue Française du Marketing*, n° 149, 1994.
- Gallouj F., "Les formes de l'innovation dans les services de conseil" (The forms of innovation in consultancy services), *Revue d'économie industrielle*, n°57, 1991.
- Gallouj F., Weinstein O., *L'innovation dans les services : une approche en termes de caractéristiques*, (Innovation in services : a characteristics approach), CEDES Seminar, Lyon, april, 1995.
- Gallouj F., *Vers une théorie de l'innovation dans les services (Towards a theory of innovation in services)*, Report for Commissariat Général du Plan, July, 1997.
- Gallouj F. Weinstein O., Innovation in services, *Research Policy*, Vol. 26, pp. 537-556., 1997.
- Goldman, A., The role of Trading up in the development of retail system, *Journal of Marketing* 39 (1), p. 54-62, 1975.
- Hardouin J.C., *L'apparition de l'innovation financière. Contribution à l'étude de ses éléments explicatifs*, (The appearance of financial innovation), Complementary Thesis University of Rennes, 1973.
- Henderson R. M., Clark K. B., "Architectural Innovation : The Reconfiguration of Existing Product Technologies and the Failure of Established Firms", *Administrative Science Quarterly*, Vol. 35, n°1, march, 1990.
- Hollander, S.C., Notes on the Retail Acordion, *Journal of Retailing*, Vol 42, n° 2, p. 24, 1966.
- Jallat F., *Le management de l'innovation dans les entreprises de services au particulier : concepts, processus et performances*, (Management of innovation in personnel services : concepts, process and performances), PhD thesis, University of Aix-Marseille III, 1992.
- Lancaster K. , A New Approach to Consumer Theory, *Journal of Political Economy*, 14, 1966.
- Levitt T., Production line approach to service, *Harvard Business Review*, september-october, 1972.
- Mc Nair M.P., 1958, *Significant trends and developments in the post war period*, in A.B. Smith (ed.) *Competitive Distribution in a Free High Level Economy and its implication for the University*, University of Pittsburgh Press, Pittsburg, p. 1-25.

- Miles I., Kastrinos N., Flanagan K., Bilderbeek R., Den Hertog P., Huntik W., Bouman M., *Knowledge-Intensive Business Services : Users, Carriers and Sources of Innovation*, Rapport pour DG13 SPRINT-EIMS, March (1995).
- Niehans J., "Financial Innovation, Multinational Banking, and Monetary Policy", *Journal of Banking and Finance*, 7, 1983.
- Normann R., *Service Management : Strategy and leadership in Service Business*, John Wiley and Sons, New York, 1984.
- Saviotti P., Metcalfe J., "A Theoretical Approach to the Construction of Technological Output Indicators", *Research Policy*, vol. 13, n°3, june, 1984.
- Shostack G.L., *Service Design in the Operating Environment*, in George W., Marshall C. (Eds), 1984
- Sundbo J., *Innovative Networks, Technological and Public Knowledge Support Systems in Services*, Roskilde University, mimeo, 1993.
- Sundbo J., Management of innovation in services, *The Service Industries Journal*. (forthcoming), 1996.
- Sundbo J., Development of the service system in a manual service firm : a case study of the Danish ISS, *Advances in Services Marketing and Management*, Vol. 5, 1996.
- Sundbo J., Modulization of service production and a thesis of convergence between service and manufacturing organizations, *Scandinavian Journal of Management*, Vol. 10, N°3, pp. 245-266, 1994.
- Tarondeau J.C., Xardel D., *La distribution*, (Retailing) Paris, PUF, Que sais-je, 1992.
- Van Der Aa W., Elfring T., *A typology of Innovations in Service Firms*, Conférence on "Managing Innovations in Services", Cardiff Business School, 5-7 april, 1993.

**PAPER 4:**

**INNOVATING IN REVERSE: SERVICES AND  
THE REVERSE PRODUCT CYCLE**

**(Forthcoming in the European Journal of Innovation Management, Vol. 1,  
Number 3, 1998)**

## INNOVATING IN REVERSE: SERVICES AND THE REVERSE PRODUCT CYCLE

Faïz GALLOUJ

(Forthcoming in the *European Journal of Innovation Management*, Vol. 1,  
Number 3, 1998)

### *Summary:*

*As they account for the largest share of employment and value added, services do not (or cannot) lie outside a Schumpeterian view of innovation phenomena. Of the various attempts at shedding more light on the mechanisms of innovation in service industries and firms, we consider the “reverse product cycle” to warrant special attention because of its highly thought-provoking nature and its theoretical ambition. This article has two objectives: firstly, to present this interesting and still neglected theoretical study, and secondly, to evaluate on a theoretical and empirical level the extent to which Barras’ model meets the objective of a “theory of innovation in services”.*

### I. INTRODUCTION

Since they account for the largest share of employment and value added, service industries are at the heart of contemporary economies. From a Schumpeterian perspective, innovation phenomena must be at work in service firms. In an economic sector which is, admittedly, highly heterogeneous, but whose output remains largely “imperceptible”, the question, therefore, is what are the *specificities* of innovation in services?

The different answers given to this question by economic and management literature can be schematically classed into three categories (F. Gallouj, 1994 and C. Gallouj and F. Gallouj, 1996):

- “service-oriented” approaches (Gallouj, 1991 ; Van der Aa and Elfring, 1993; Gadrey et al., 1995; Sundbo, 1993) which emphasise the specificities of innovation in services and show particular innovation modalities in these activities (particularly high frequency of ad hoc innovation, “intangible” service trajectories as opposed to technological trajectories, etc.). In management science, and particularly, service industries marketing, these service-oriented approaches towards innovation are defined particularly by the distinction between *basic services* and *peripheral services*. Viewed from this angle, a *new service* corresponds to setting up a new basic service, and the *extension of an existing service* occurs through the addition of a new peripheral service (Flipo, 1984; Eiglier and Langeard, 1987; Jallat, 1992; Lovelock, 1992). The course taken by financial innovation (e.g. Hardouin, 1973; Desai and Low,

1987) represents, at a more subtle level (that of demand for service characteristics), this view of “product/service”;

- integrative approaches (Belleflamme, Houard, Michaux, 1986; Barcet, Bonamy, Mayère, 1987; Gallouj and Weinstein, 1997) whose aim is to reconcile goods and services in a single innovation theory. These approaches are based on a functional conception (or one in terms of characteristics) of the product, and they propose typologies of forms of innovation valid for both goods and services;

- technologist approaches, by far the most numerous, which can be summarised as being concerned with the introduction of equipment and technical systems into service firms and industries.

We consider Barras’ reverse product cycle model, on which this study is centred, to belong to the last category. We do not intend to examine the first two approaches<sup>21</sup>; it is, however, necessary to justify our particular interest in Barras’ model.

Even though it is, as we shall see, fundamentally technologist, this model nevertheless exceeds a simple analysis of the assessment and consequences of adopting technological innovation in services, unlike the majority of the economic and management literature on this theme. Its consideration of innovation processes in services is not, as is often the case in other works, the “by-product” of other analytical priorities. Indeed, this model aims to draw up a study on the production of innovations by services *themselves*. Consequently, it is an interesting theoretical advance and one which we still feel to be somewhat neglected.

Richard Barras’ theoretical objective is clearly set out in the title of one of his reference articles published in the journal *Research Policy* in 1986: “*Towards a Theory of Innovation in Services*”. The objective of our article is twofold: firstly, to present Barras’ theory as it appears not only in Barras’ own article, but also in other earlier and later works; secondly, to evaluate the extent to which the model meets the objective of a “theory of innovation in services”, and what needs to be retained from it for our own perception of innovation in services. It can already be said that, in services more than elsewhere, innovation cannot be reduced, as is the case in Barras’ theory, to its technological manifestations. The definition of innovation put forward by Schumpeter at the beginning of the century, therefore, through its broadness, remains the best reference<sup>22</sup>.

## II. - PRESENTATION OF THE MODEL

In a series of empirical studies covering the fields of banking, insurance, accounting and local public administration, Barras (1986, 1990), highlights a product life cycle which he describes as the reverse of the cycle at work in manufacturing, where the initial phase, predominantly product innovation, is followed by a second phase, dominated by process innovation (Abernathy and Utterback, 1978).

<sup>21</sup> For a survey of the literature on innovation in services, cf. particularly Gallouj (1994), Miles et al (1995), C. Gallouj and F. Gallouj (1996), F. Gallouj (1997).

<sup>22</sup> Indeed, Schumpeter’s definition contains five categories: new goods, new production methods, new markets, new sources of raw materials, new organisation of production.

Following this model, the evolution in services will be the reverse, because the incremental phase of process innovation will be followed by radical phases of process innovation, then of product innovation, the respective purposes of which are improving the efficiency of the service, improving its quality, and conceiving a new service.

The empirical assessment of this reversal of the life cycle is the core of Barras' theory of innovation in services. Each stage of the reverse cycle is initiated by the introduction of a particular technological system: respectively, mainframe computers, minicomputers and microcomputers and networks (cf. table 1).

Unlike some typological approaches (Pavitt, 1984; Lakshmanan, 1987; Soete and Miozzo, 1990), Barras' model does not restrict firms to a given technological trajectory, but considers the nature of the trajectory to vary from one phase of the cycle to another. He thus places the debate on service innovations in a dynamic perspective. This model, the usefulness and limitations of which we are examining here, is without doubt the first economic study which explicitly aims to devise a theory of innovation in services in the Schumpeterian tradition.

### **2.1. Incremental process innovation and improvement of service efficiency.**

The first stage of the reverse cycle (cf. table 1) is initiated by service-providing firms adopting back-office mainframe computers. The setting up of these mainframe computers is the opportunity for many forms of learning, resulting in incremental improvements in the service provided. These incremental innovations concern the process: they reduce the cost of the service provided without affecting its quality. Examples of these incremental process innovations are the computerisation of insurance policy records, local government personnel records and payroll, audit techniques and internal time recording in accountancy firms.

According to Pavitt's taxonomy (1984), at this stage of the cycle, firms are "technologically dominated by suppliers". This does not, however, mean that no interaction takes place; quite the opposite. Indeed, Barras stresses the idea of an interactive innovation process, which introduces a feedback loop between the incremental process innovation produced by the service provider, and the producer of new technologies. Indeed, incremental process innovations affect not only the technological trajectories in the field of equipment sectors (leading to other innovations in this field: e.g. superior software applications), but also the institutional structure of the service activity and the nature and volume of demand for the service (which costs less).

In terms of impact on production factors, the first stage of the reverse cycle is characterised by technical progress which saves labour and increases the amount of capital used.

### **2.2. Radical process innovation and improvement of service quality**

The following phase coincides with the introduction of a new generation of computer systems: mini and microcomputers. These new systems benefit from the knowledge and experience base accumulated during the previous phase, and, in turn, initiate new learning and innovation opportunities which are more centred on the front office and client satisfaction. These innovations, however, are of a more radical nature. Their purpose is no longer to lower costs, but to enhance the quality of the service provided. The best known examples of this type of innovation are automatic teller machines, other examples being the computerised management of housing waiting lists in local public administration, on-line insurance policy quotations, and computerised book keeping services in accountancy firms.

With the acceleration of the speed at which technical change in equipment spreads, its impact on production factors changes. Indeed, technical advances have progressively less effect on the labour factor, and, instead, promote the improvement of quantity and, above all, the quality and variety of capital.

### 2.3. “Product” innovation

The purpose of the third phase of the cycle, the product innovation phase, is to open up new markets. It is accompanied by a radical change in the service firm’s structure and strategies. The firm becomes freed from subordination to technological suppliers, and can produce its own innovations autonomously, within specialised departments, or by calling upon external service providers, particularly those belonging to knowledge-intensive business services, but where the balance of power is in the service firm’s favour.

On the face of it, this phase seems to be the most interesting, as it corresponds to producing new services, rather than simply improving the efficiency or quality of existing services.

However, two limitations of the model are already evident, to which we will return in more detail:

- as it is a technologist vision, it is a restrictive view of “product” innovation, as is borne out by the examples given, such as interactive and fully-automated auditing and accounting processes in accountancy firms, complete on-line services in insurance firms, home banking, and all “home” services made possible by new information and telecommunication technologies.
- moreover, the third phase would barely get under way, and in all cases, its progress would require an informational infrastructure to be set up.

This “product” innovation phase has a positive effect both on output and employment. It is associated to technical advances which save capital whilst improving its quality.

Phase of the cycle	Main forms of innovation	Competitive effort	Enabling technologies	Examples	Impact of technical advances on production factors
Phase I	Incremental process	Improvement of service efficiency	Mainframe	The computerisation	Labour-saving technical

	innovation	(cost decrease)		of insurance policy records, personnel records and payrolls	advances which increase the amount of capital used
Phase II	Radical process innovation	Improvement of service quality	Mini and micro computers	The computerised management of housing waiting lists in local public administration, on-line insurance policy quotations, ATMs	Technical advances which are neutral in terms of labour, and which encourage an increase in the quantity and particularly the quality and variety of capital
Phase III	Product innovation	New services	Networks	Home banking	Technical advances which save capital whilst improving its quality

**Table 1:** The main characteristics of the reverse cycle

Barras' model, the main points of which we have just presented, suffers from using concepts from the field of manufacturing (product, life cycle). Indeed, it could be said, paradoxically, that "in services, the product is a process". It is therefore difficult to make the distinction between product innovation and process innovation. By the same token, it becomes difficult to follow the "product" life cycle. But other problems, which to our mind are more important, must be resolved if Barras' model is truly to constitute a theory of innovation in services. Indeed, in this model, innovation is not envisaged independently of technological possibilities. It is also a model whose field of application (in terms of fields of activity) merits discussion.

### III. - A MODEL WHICH IS LIMITED IN TERMS OF TYPE OF ACTIVITY

Two factors at the centre of Barras' model lead to its domain of validity being questioned:

- The enabling technologies which we have seen to be at the root of the different stages of the reverse cycle. In the main, these enabling technologies are information and telecommunications technologies. It is worth mentioning the confusion which arises (frequently in studies) between enabling technologies (mainframe computers, mini and microcomputers, networks) and the innovations made possible by these enabling technologies (which can themselves be incorporated into equipment and technical systems (e.g. automatic teller machines (ATMs) and cashpoints)). Indeed, automatic teller machines and cashpoints are not enabling technologies, but radical process innovations whose enabling technologies are particularly networks of dumb terminals.



- The vanguard sectors which, in terms of their contribution to economic growth, are particularly dynamic. Barras would class these as financial and business and professional services, and these served as the empirical field of investigation for his model.

We would like to raise the following two questions:

- Are there not other enabling technologies, other than information and telecommunications technologies; can the validity of the model therefore not be extended to other technological systems?

- Is the analysis valid for all vanguard services, and can its field of application be extended further than vanguard services?

### **3.1. Is Barras' model valid for all vanguard services and beyond?**

Firstly, this question can be considered on the basis of concrete examples.

Legal consultancy to firms has seen a relatively high growth rate in France, which has been encouraged by a number of recent institutional changes. According to Barras' definition, as a "knowledge intensive business service", it belongs to the vanguard services. Does it, however, display a reverse product life cycle? The answer is negative for different reasons: firstly, in France, this activity is currently not particularly open to information technology; the second reason (closely linked to the first) is that it is an activity which does not deal with codified information, but with expertise. This does not, however, prevent it from innovating, although its innovations do not slot neatly into the product innovation/process innovation typology. Indeed, what we see here (and we will come back to this point in section 5.1) are different forms of innovation lying outside Barras' model: ad hoc innovations arising from the need to come up with a new solution to a client's problem; the opening up of new legal fields through accumulation of knowledge and expertise; formalisation innovations through the introduction of methods, and through procedures of combining/dissociating existing services (architectural or recombination innovations).

Another legal profession, that of notary, very rapidly embarked on the road to office computerisation. Microcomputers and fax machines were introduced under the impetus given by professional institutions. Indeed, the information processed by notaries is often more standardised. This innovation does not, however, seem to have followed Barras' reverse cycle. Admittedly, incremental process innovations occurred, but no radical process innovations or, indeed, product innovations. Obviously, in both cases, the strength of institutional rigidities must be pointed out, as must the degree of complexity and instability of the environment and of the problems to be solved.

Our conclusion, therefore, is that Barras' model applies mainly to those vanguard services and other services which are most affected by technological evolution, and that it cannot be applied to most other cases. It does cover some (but, as we shall see,

not all) innovation modalities in “pre-industrial” services, i.e. essentially mass informational services (banks, insurance, public administration, large audit firms).

Other assessments of Barras’ model’s field of validity draw similar conclusions. Some service marketing specialists (E. Langeard and P. Eiglier, 1990) consider Barras’ model to be valid only for services with a substantial back office (insurance, banking), as it is dominated by back-office technologies. It is not valid for services where the service relationship («servuction») occupies a central position, as is the case in consultancy and most knowledge intensive business services. Economists interested in Solow’s paradox (Petit, 1990), consider the model’s main field of validity to be household services, since they have a strong element of self-service.

An additional question, which we will only touch upon here, is whether, from the perspective of a functional approach, Barras’ thesis could be extended to service functions internal to firms, particularly when the latter adopt, as is often the case, informational technologies.

### **3.2. Can Barras’ model be applied further than informational technologies?**

The informational paradigm on which Barras’ model is based is certainly dominant in our economies, but other technological systems also occupy an important place in them, sometimes by merging with the previous paradigm. This is the case with technologies involved not only in storing, processing and circulating information, but also in material logistics, i.e. storing, handling and circulating materials (transport, refrigeration, cooking and cleaning technologies etc.). It is also the case with new technologies such as medical instrumentation, genetics and biotechnology, etc.

Before Barras’ model could be applied to technologies other than informational technologies, it would have to be verified that the adoption of these technologies initiates a reverse cycle whose initial phases are dominated by process innovation, before the following phases of “quasi-product” innovation occur. There are indicators that such an evolution occurs.

1) There appear to be good examples of new "service-products", new "formulas" or "concepts" in activities that utilize material transformation and logistics technologies, in distribution, for instance, or in restaurant chains (Pizza Hut, the french "Courte-Paille" or Spizza 30'...). The automation of petrol pumps in service stations, for instance, may be considered a radical process innovation similar to automatic teller machines. Moreover, the opening of sales points in these service stations, using all the techniques of the supermarket and open permanently, is related to 'product' innovation in the sense used by Barras.

2) Moreover, situations can be envisaged in which the Barras cycle is based on a combinatorial adoption of information technologies and material transformation and logistics technologies. This is the case with firms like Federal Express, Chronopost and mail order companies.

An example is containerized transport. While this technology is relatively old (Ernst, 1985), it has been a source of process innovations in Barras' sense; in the first place it

improved the efficiency of transport without changing the nature of the service itself. The later standardization of container sizes and development of technologies involving the unloading cranes and their standardization have been factors in improving service quality in terms of a greater availability and so on (radical process innovation). With the introduction in recent years of information and telecommunications technologies into maritime container transport, the quality of the service has been improved so much that it is possible to speak of a "new service" in Barras' sense<sup>23</sup>.

Another example is fast food in the United States. In certain fast food restaurants, cooking and refrigeration technologies are permitting incremental process innovations (affecting the "back-office": the central kitchen). On the other hand, computerized menu ordering systems can be seen as radical process innovations (by analogy with the automatic teller machines of banks, which are considered so by R. Barras).

But even then, supposing that Barras' model could have a wider field of application than the informational technologies, the fact remains that it would not necessarily accommodate all the diverse forms of innovation in service firms and industries.

#### **IV. - A MODEL DETERMINED BY TECHNOLOGY**

Barras' model's main limitation is that it reduces the degree of variety of innovation in services, which is paradoxical on two counts:

- firstly, Barras claims to follow Schumpeter, but Schumpeter's definition of innovation is, in fact, broad and open, and can accommodate intangible "products" and "processes".
- secondly, the technological bias of the analysis means that recent important advances made in theories of financial and commercial innovation are not taken into account. We will indicate several important points of these advances here.

Analyses of financial innovation based on the demand for certain characteristics have developed independently with a view to providing a theory that applies solely to financial services. They take account of facets of innovation which are not accommodated by Barras' model. The basic hypothesis is that any financial product can be broken down into a certain number of service characteristics by which it is defined. From this point of view, any change in the topography of these characteristics, whether this involves the emergence of new characteristics or of new combinations of existing characteristics, constitutes an innovation.

Hardouin (1973) formalises this analysis as follows. A monetary and financial instrument  $T_i$  can be defined a priori or a posteriori by a finite set of "n" characteristics and can therefore be written in the form of a vector with n dimensions in which the  $t_{ij}$  indicate the extent to which property j is incorporated in instrument i.

---

<sup>23</sup> It is now possible to know at every moment to whom each container belongs, what it contains, where it is located, where it comes from and where it is going, where it should (optimally) go once empty, what kind of container it is, if it needs to be repaired and at what price, etc. (Ernst, 1985).

$T_i = (t_{i1} \dots t_{ij} \dots t_{in})$ . Thus if the instrument  $T_i$  does not have property  $j$ ,  $t_{ij} = 0$ . Innovation appears in the following two cases: a variation in  $t_{ij}$ , i.e. a variation in the extent to which the existing property  $j$  is incorporated in the instrument (e.g. the instrument is more liquid), and the activation of a property that did not previously exist (transition from  $t_{ij} = 0$  to  $t_{ij} \neq 0$ ).

For example assuming that any financial service, from the simplest to the most complex, can be represented by a given combination of the following three functions or characteristics (Niehans, 1983) : the exchange of current money against future money, the linking of borrowers and lenders, the making of payments in the name of a client, this author defines innovation as any new way of combining these three aspects.

Niehans also introduces an interesting distinction between irreversible combinations (innovations), which he describes as "*technological*" but which are not limited to material technologies since they include double-entry book-keeping, which was invented at the end of the Middle Ages, and those that are more reversible and cyclical, which he terms "*adaptive innovations*". Innovations in this latter category disappear as soon as the conditions that encouraged their development have themselves disappeared.

Like specialists in the financial services industry, students of retailing have sought to develop theories of innovation adapted to their particular field.

The most important of them relate to the dynamic of shop formats, which are conceived of in terms of life cycle. Thus the "wheel of retailing" model (McNair, 1958) can be summarised as follows:

- 1) All new forms of retailing appear first in a "discount" version, i.e. outlets offer a limited range of goods and services and the main objective is to maximise sales volumes.
- 2) Their success causes the "wheel" to revolve as retailers gradually "trade up" by adding new products and services to the original ranges; this leads in turn to increased operating costs and higher prices.
- 3) This "bourgeoisification" of the retail form opens up the market for new, more "Spartan" entrants (to borrow the terms used by Tarondeau and Xardel, 1992).

Other analyses couched in terms of cycles, which cannot be outlined in any detail here (cf. C. Gallouj, 1997), have extended the "wheel of retailing" model:

- Goldman's analyses (Goldman, 1975) distinguish between various possible forms of "trading up" or ways of causing the wheel to revolve by the degree of innovation in goods or service they introduce into the range;
- in the "accordion theory" (Hollander, 1966) the retailing dynamic is characterised by alternation between outlets offering a wide, non-specialist range of products and those with a narrow, specialised product range.

However, the cycle model in its various forms, as well as Barras' reversed cycle model, cannot account adequately for the wide diversity of forms of innovation in the retail sector. These retail cycle models are concerned only with innovation in shop format (i.e. organisational innovation). However, even in this particular case, they are trapped within a binary logic (low/high prices; wide/restricted product range) and fail to take full account of the diversity of new shop formats and of new forms and new channels of distribution.

Nor do these models take account of the following forms or areas of innovation, most of which require detailed investigation if they are to yield up their secrets:

- new methods of selling (mail order, door-to-door selling ...);
- new products and services retailed in stores;
- new processes (or new forms of organisation and operation) within the same format, whether based on the introduction of new technologies or not (within the same form of retail outlet or within the environment - customers, suppliers, other stores - of the form under consideration).

Contrary to financial innovation theories and commercial innovation theories, in Barras' model, **innovation does not exist outside of technological possibilities**. This is true not only of process innovations, but also of so-called "product" innovations, occurring in the third phase of the cycle. In the following section, we will attempt to illustrate, through concrete examples, the diverse forms which innovation in services can take.

## **V. - BARRAS' MODEL PUT TO THE TEST: CONSULTANCY, TRANSPORT AND INSURANCE**

Despite his affiliation to Schumpeter, we have seen that Barras adopts a reductionist view of "new services" (new "products"). The object of this section is to illustrate the multiplicity of innovation forms and trajectories in the three service industries, which display differing relationships with materiality and technology:

- consultancy (the very epitome of a "pure" service)
- road haulage (the tangible dimensions of which are obvious),
- but, above all, insurance and financial services (which are situated somewhere between the other two service industries in terms of their relationship with materiality and technical systems, and which are one of Barras' main fields of investigation).

### **5.1. Consultancy**

Consultancy activities have much in common with research activities: their high content of "grey matter", a similar purpose, namely "solving problems", etc. However, paradoxically, it is difficult to study and evaluate innovation activities in this field using traditional analytical tools. Some researchers are quick to conclude that little or no innovation takes place in this type of activity, apart from, at the very most, the technical systems adopted. Consultants themselves are often split into two camps: those who underestimate their capacity for innovation and those who consider every service transaction to be an innovation, as each transaction is new and original.

For our part, we do not share either of these conclusions, which prove how unfit our analytical tools are for understanding the nature of innovation in service firms. The difficulty stems in particular from the intangible and interactive nature of this type of activity. These characteristics also call into question the traditional distinction between product innovation and process innovation (C. and F. Gallouj, 1996; Gallouj and Weinstein, 1997). Innovation does exist in this type of activity, but it can take different forms. Our empirical investigations allow three different types of innovation to be envisaged, which we will designate by the following terms: ad hoc innovation, anticipatory innovation (or new expertise field innovation) and formalisation innovation.

#### *Ad hoc innovation*

Ad hoc innovation is the conception of a new solution to a client's problem (which is, itself, often completely novel), with the client's participation. It can be a solution to an organisational, strategic, legal, fiscal, social, or human problem, etc. To ensure that the ad hoc innovation can, to a certain extent, be reproduced, and to establish a boundary between ad hoc innovation and the ad hoc nature of all consultancy service transactions, it is necessary for the service provider, at the outset of the service and innovation, to embark upon a process of formalisation, i.e. codification of certain elements of the service, which can then be reused elsewhere, and which will help enrich the organisational memory of the firm.

This is the interface which constitutes the "laboratory" where this "non-programmed" (Zaltman et al., 1973) and somewhat emergent form of innovation is conceived.

Consequently, the probability of an ad hoc innovation occurring, and the quality and nature of the innovation, depend heavily on the nature and quality of the interface.

Apart from the service provider's own intrinsic elements, the "quality" of the interface depends on:

- the quality of the experts from the client organisation who are involved in the interface. Indeed, these professionals partly determine how well the request is formulated and the "true need" (which often differs from the request) is (re)built (Gallouj, 1994). Furthermore, the success of the innovative solution and its assimilation by the firm depends on their ability to absorb the new ideas.
- the quality of the problem raised. Original and unprecedented problems are potential sources of ad hoc innovation. That said, the innovation potential arising from curative and preventative problems (according to Kubr's terminology, 1988) must not be underestimated. Moreover, strategic problems are often more fruitful sources of innovation than more operational or routine problems. These strategic problems are most often the subject of sparring-type interfaces (cf. Gadrey and Gallouj, 1998). They are rarely contracted out. The terms of the analysis can thus be reversed, concluding that sparring type interfaces are more frequent sources of innovation than jobbing- type interfaces.

On a qualitative level, it can be said that opportunities for ad hoc innovation seem to increase with the size of the service provider and their client. Indeed, the

multiplication of “contact” zones, (i.e. interfaces) provides multiple opportunities for reciprocal learning and possibly ad hoc innovation.

The existence of this interface raises two important problems:

- In particular, it is partly responsible for limiting the extent to which the ad hoc innovation can be reproduced in its current form. In our opinion, this is what leads a number of researchers to refuse to class this particular form of mobilising expertise as an innovation. However, knowledge, experience (codifiable or not), tacit and idiosyncratic techniques stemming from practical experience, and methods used for their production and transfer can, for their part, be reproduced.
- It poses serious problems of protection and appropriation. Indeed, as the ad hoc innovation stems from the interface, during a process of reciprocal learning, and as it has a strong tacit and contextual dimension, it is difficult to designate its inventor or owner. It is impossible, if the need arises, to ensure protection.

*Anticipatory innovation (or new expertise field innovation)*

This particular form of innovation could also be called a “new field of knowledge and/or expertise”. It can be considered as a particular manifestation (i.e. adapted to knowledge-intensive business services), of what Barcet, Monamy and Mayère (1987) call functional innovation (the appearance of a new function). The ideas at the root of such an innovation can stem from the interface (i.e. direct exchanges with the client, the expression of the client’s needs), but they more generally stem from what we call the “abstract need”, (i.e. the “diffuse” background noise emitted by the environment), which is complex and unclear, and not linked to any particular client (Gallouj, 1994). As the environment and the client’s needs are monitored and listened to, new needs emerge, which must be satisfied. Anticipatory innovation consists of collecting and accumulating new knowledge and expertise relevant to the “problem” or anticipated need, stemming from technological, economic, social or institutional change. Faced with particularly novel problems, i.e. problems for which there is little available expertise, the consultant will have to turn to outside experience, to similar situations. He may, in some cases, carry out research which creates genuinely new expertise. In this way, I.T. has given rise to experts in I.T. consultancy and I.T. law, etc., and ecological and environmental concerns, European construction and the opening up of Eastern countries have given rise to many “new fields of expertise”, shared by different types of service providers according to their main field of activity (technical, commercial, legal, political, etc.). These new fields of expertise, which have constituted innovations for those who anticipated these changes, are the equivalent of “product” innovations in the field of knowledge-intensive services. However, until an interface has been established with the client, anticipatory innovation will remain potential. Consequently, this presupposes some marketing and communication efforts which, in the field of consultancy, usually take the form of publications, participation in conferences, etc.

As a “new field of expertise”, this form of innovation is particularly difficult to protect. Its appropriation can sometimes be facilitated by the realisation of another form of innovation: formalisation innovation.

### *Formalisation innovation*

Formalisation innovation consists of “putting order” into service functions, which are often vague and unformatted. They must be given form, specified and made concrete. This does not, however, mean that the desired “materiality” necessarily has to be tangible.

These objectives can be met by introducing “boundaries”, reference points into the “vague” service. The components of this genuine service framework can be tangible (back-office or interface technical systems, software, etc.) or intangible: methods that constitute the scripts for the “live performance” that services are, organisations embodying service innovations, toolboxes, etc.

In service activities, this “ordering” of service characteristics and functions is very often the preliminary to implementing mechanisms for architectural- or combinatory-type innovations, which consist of producing new services by combining existing services or, conversely, by dissociating an existing service.

In many services, formalisation innovation constitutes a truly “natural trajectory” in the sense of the evolutionary theory of innovation. That said, we cannot, in the case of professional services, talk of industrialisation.

These three forms of innovation can appear autonomously, or they can be combined and interact. Anticipatory innovation is the central element of this system of interaction, in that it is very often followed by ad hoc and/or formalisation innovations. It must not, however, be reduced to a single particular strategy, a stage in a process whose purpose is one of the other two forms of innovation. Indeed, in consultancy activities, it is just as often an autonomous and viable form of innovation. It is a particular form (one adapted to knowledge-intensive business services) of functional innovation, in the sense of Barcet, Bonamy and Mayère (1987). Anticipatory innovation and formalisation innovation can overlap, as is the case when a new field of expertise is detected and exploited at the same time as methods and tools are developed and autonomous services within the new field of expertise are differentiated. Moreover, ad hoc innovations can be a source of ideas both for improving methods (formalisation innovation) and for new fields of expertise to be detected (anticipatory innovation).

## **5.2. Transport.**

It is unlikely that Barras’ reverse cycle model can explain the dynamic of innovation in road haulage. Indeed, as we have already stressed, the model applies, above all, to activities whose most important element is the informational element.

Transport can be broken down into three types of operation (Gadrey, 1991; Djellal, 1998):

- those which consist of “handling” tangible objects, i.e. changing, moving or maintaining them (**material** logistics and transformation operations);
- those which consist of “processing” codified information, i.e. producing, capturing, circulating it, etc. (**informational** logistics operations);



- those whose main medium is the client and which consists of a direct (contact) service. This third type of operation can apply to transport firms which provide “tour operator” services i.e. whose main operations are **immaterial** logistics operations, such as organising the flow of information between firms, monitoring and commitment to the client (quality, trust, guarantee) and, more generally, social innovations.

In transport, initially, the material logistic element was dominant (Djellal, 1998), so the activity naturally evolved according to the trajectory of logistical technologies (transport equipment and the handling of materials). These technologies do not seem to have behaved in exactly the same way as mainframe-based computer systems, which are described by Barras in the first stages of development of the (reverse) life cycle of financial, and, more generally, informational services.

However, if back-office mainframe systems have played no role whatsoever in the development of the transport activity, the same cannot be said of decentralised computer systems. It would seem that transport can be considered as an activity involved not only in handling materials, but also in processing information, and even in processing knowledge and the service relationship.

Transport is therefore an activity where several technological and innovation trajectories connect:

- A material logistics technological trajectory (improvement of vehicles and material-handling systems).
- An informational and communicational technological trajectory (computer systems, telecommunications).
- An immaterial logistical trajectory (organisational knowledge and expertise, service relation, etc.).

To these three trajectories must be added an organisational or “infrastructural” trajectory (the setting up of computerised roadside information points), which depends mainly on the public authorities.

The first three trajectories can occur independently, when they characterise firms evolving according to only one of the trajectories (specialised trajectory). But most of the time, they connect and merge, becoming inseparable. This is particularly the case with material logistics technological trajectories and informational technological trajectories.

Moreover, as we saw above, the evolution of the transport activity is characterised by two movements:

- enrichment of each of the trajectories, i.e. innovation within each of the functional components of the activity.
- movement from one trajectory to the other.

Whether they are of a logistical or informational nature, technologies are not the only dimensions of innovation in transport. There is also room for truly intangible services (“tour operator”-type services, set-ups of transport and logistical consultancy firms).

### 5.3. Insurance

In this domain, our field studies<sup>24</sup> highlight the importance of “product/service” forms of innovation, which are absent from the reverse cycle model. It even seems that in some situations, if computerisation brings about process innovations (in accordance with Barras’ model), the conception of new “product/services” such as life insurance, damage/injury insurance or assistance policies quite often entails innovative changes in computer systems. A point which Barras’ model, however, does not cover.

Innovation in insurance companies and banks may take four generic forms (Gadrey, Gallouj, 1994), which are summarised in the following table.

TYPES OF INNOVATION	SUB-CATEGORIES	DEFINITION	
A: PRODUCT/SERVICE INNOVATIONS	A1: “Absolute” product/service innovations	New service, concept or policy for the whole market	
	A2: “Relative” product/service innovations	New service, concept or policy for the company concerned	
	A3: Tailor-made products/services innovations	1) Adaptive tailor-made innovations	Adaptation of a standard policy for a particular client through changes in pricing or the addition of certain supplementary clauses
		2) Fully tailor-made innovations	Design of a genuinely specific policy for a given client
3) Cover for special risks		Cover for a new risk affecting only small populations.	
B: ARCHITECTURAL INNOVATIONS	B1: Product/service bundling innovations	Recombination of existing products/services	
	B2: Product/service unbundling innovations	Isolation of one element in a product/service for sale as a separate item.	
C: INNOVATIONS BASED ON MODIFICATIONS TO A PRODUCT OR SERVICE		Certain specifications and options are modified, leaving the basic formula unchanged	
D: PROCESS AND ORGANISATIONAL INNOVATIONS, INNOVATIONS IN METHODS AND MANAGEMENT	D1: Innovations introduced in support of product/service innovations	Process and organisational innovation following a product/service of type A, B or C and indissociable from it	
	D2: innovations associated with a product/service that remains unchanged in terms of both formal specifications and mode of delivery	Significant change in process (technology, work organisation), leaving the final service unchanged	
	D3: innovations associated with a product/service whose formal specifications remain unchanged but whose mode of delivery, perceived quality and marketing are to be improved	Significant change in process (technology, work organisation) leaving the product “formally” identical but improved in quality	
	D4: Formal management innovations	Innovations relating to financial, actuarial, legal, HR management.	
	D5: Informal management innovations (ad hoc or makeshift innovation)	Differentiated from the forms outlined above by their informal nature.	

**Table 2:** The main forms of innovation in insurance services

In order to facilitate analysis, these various forms of innovation are presented here separately. In reality, of course, they are frequently indissociable from each other, both in the way they are produced and in the effects they have. Thus many process and product innovations are simply two facets of the same phenomenon, and process and organisational innovations are often indissociable from each other. Furthermore, as Y. Lasfargue (1995) rightly points out, the effects of different innovations on the firm, its specialities, skills and jobs, etc., cannot be isolated, but must be systematically comprehended.

<sup>24</sup> They were carried out together with Jean Gadrey. This section is indebted to him.

### 5.3.1. *Product/service innovations (type A)*

It is a new service, a new “formula”, a new concept, a new policy which we ambiguously tend to call a new “product”. This is a service (a formula) of contractually making available methods and competencies for managing clients’ insurance problems under conditions which are novel.

The characteristic of *newness* must be assessed from the point of view of the user, i.e. the client. Thus, if the clients obtain the same results or guarantees, the same benefits, but the processes differ, then it is the same “product/service” (and therefore a D-type innovation). Furthermore, if “product/service” innovations can fit the existing management system, the latter often needs to be modified, sometimes innovatively. The “product/service” innovation is then accompanied by a D1-type innovation and Barras’ reverse cycle is reversed, as the product innovation (which, admittedly, is not used here in Barras’ sense) precedes the process innovation.

This category partly covers what Y. Lasfargue (1995) calls “product, service and mission innovation”. Unlike that innovation, however, it excludes innovations such as new distribution channels, which belong to category D3 (front-office innovations).

Product/service innovations may be “absolute” (A1) or “relative” (A2), depending on whether the products or services involved are new to the market as a whole or just to the insurance company concerned. This latter case (imitation) is obviously more frequent than the former, particularly since product/service innovations in the insurance industry are not patentable. Nevertheless, it should be noted that the particular structural characteristics of a company (in terms of technologies, distribution channels, etc.) will very often endow the imitation with a certain degree of originality.

Product/service innovations can be tailor-made (A3) to suit a particular kind of risk or client. This is especially the case in group life insurance, the covering of major industrial risks and certain aspects of assistance or support services (e.g. Europ Assistance). However, a distinction must be made between three different kinds of tailor-made innovations. *Adaptive tailor-made innovations* adjust an existing policy to a given clientele by modifying the premiums or introducing additional clauses. This form of innovation is relatively common, particularly in the SME market. *Fully tailor-made innovations* are common in the insuring of risks faced by large firms, and involve the drafting of a genuinely specific policy for each client. Finally, *special risk policies* provide cover for risks for which there are no actuarial statistics available since they affect only very small populations.

To conclude this section on product/service innovations (type A), several subtle differences can be brought into the description. The distinction between radical product/service innovations, relative product/service innovations and tailor-made product innovations may be difficult. A new product does not *intrinsically* belong to one particular category, but can belong to one or another according to circumstances.

- Thus, an A3-type innovation (tailor-made) can become an A2-type innovation because of changes in regulations. Today, for example, insurance against computer fraud is a tailor-made product usually offered to large firms. If, tomorrow, a change in regulations made it compulsory, it could become a genuine mass product.

- Similarly, tailor-made products developed in the context of brokerage relationships can be distributed by general agents, and reciprocally, products designed for the latter (by technical departments, etc.) can be offered to brokers, in return for, if need be, a “tailor-made” adaptation process.
- A1 (absolute innovation) and A3 (tailor-made innovation) are not necessarily in opposition. For example, the specific contract drawn up for Harley Davidson could be said to be an *absolute product/service innovation* (A1) since the competitors do not have such a contract; a *relative product/service innovation* since Harley Davidsons are motorcycles, and there are long-standing motorcycle contracts; a *tailor-made innovation* (A3) in the sense that it addresses a particular target, for which it adapts a specific product. Similarly, certain innovations, which can be classed as tailor-made (A3) in the sense that they address a large firm which has a monopoly over a given activity, can also, given their originality, be radical innovations. The absolute/relative innovation distinction, however, will be reserved only for “general public” “product/service” innovations.

### **5.3.2. Architectural innovations (type B)**

This is a frequent form of innovation in services, and has been highlighted by Albert Bressand and Kalypso Nicolaïdis (1988). It must also be noted that this form of innovation is becoming more and more important in manufacturing (particularly in electronic and biotechnology industries). It is thus at the centre of an innovation model entitled “recombination model” (Foray, 1993), or architectural innovation model (Henderson and Clark, 1990). This model contrasts with the radical innovation model (which is governed by the principle of “absolute originality”) and with the incremental innovation model (governed by the principle of “first improvement”, which preserves the main characteristics of the product, but replaces some secondary characteristics with new characteristics). The recombination model can be defined in the following terms (Foray, 1993): 1) it maintains all the known characteristics of a product; 2) it recombines these different characteristics; 3) it encourages systematically reusing “components”; 4) it may add a slight difference.

Architectural innovation can be divided into two different types according to the following processes:

- the bundling or integration of services, consisting of offering formulas or contracts in which the service provider commits itself to treat a bundle of problems or operations on behalf of the client which were previously dealt with by separate formulas or contracts (type B1);
- inversely, the separation of services by isolating a type of service or a sub-set of operations which previously formed part of an integrated service, offering it as a new service sold separately or as an option (type B2).

Individual elements such as guarantees, options and premiums may be recombined or detached from existing products. Such innovations may also involve changes in the mix of services offered (this is the case in assistance/support policies).

### **5.3.3 Innovations based on modifications to the product/service (type C)**

In this case the core of the service, as seen from the client's perspective, is unchanged, which is most often revealed in the fact that its "denomination" remains the same. At the same time, modifications are explicitly introduced into the formulas and the contracts.

The main difference between this type of innovation and the tailor-made innovations referred to above is that innovations based on modifications are supply-driven, whereas tailor-made solutions are demand-driven.

In conclusion, it must be remembered that, in the case of the insurance industry, the traditional notion of product innovation covers a wider reality than is usually imagined. Not only does it correspond to categories A, B and C, but, moreover, some of these can be split into subcategories which themselves are pertinent.

#### ***5.3.4. Process and organisational innovations, innovations in methods and management (type D)***

This generic category can be divided into four subcategories:

- *(Process and organisational) innovations associated with product/service innovations (type D1)*

In the insurance industry, product/service innovations, whether architectural in nature or based on modifications of existing products/services, almost always require changes in processes and organisation, some of which may be innovative.

It is partly for this reason that it is generally considered difficult, in services, to distinguish between "product innovation" and "process innovation". Barras' theory is obviously reversed here, as it is the conception of a new "product" which leads to computer systems being modified.

This innovation is sometimes entrusted to external service providers, such as IT service companies or manufacturers of transmission and monitoring equipment in the case of assistance/support services.

- *(Process and organisational) innovations associated with a product/service that remains unchanged in terms of both formal specifications and mode of delivery (unchanged quality criteria) (type D2)*

This is what Barras calls an "incremental innovation process". In his view, it equates to the first phase of the "reverse product cycle" that illustrates the dynamic of innovation in services. It improves the efficiency of an existing service (i.e. reduces the cost of providing it) without affecting its quality. There is a significant (non-incremental) change in the process (new technologies, new work organisation) while the final service remains unchanged. This category is a back-office innovation.

- *(Process and organisational) innovations associated with a product/service whose formal specifications remain unchanged but whose mode of delivery, perceived quality and marketing are to be improved (type D3).*

Innovations of this kind involve a significant change in the process (technology, work organisation) while leaving the final product unchanged in formal terms but improved in quality. They affect the front office, i.e. they improve the quality of relationships with customers. Examples: improvements in advice and information; reduction in payment or response times; reduction in waiting times at counters.

- *Innovations in management (type D4)*

This category includes innovations relating to financial, actuarial, legal and HR management and, in particular, certain innovations in financial management. For example, assets-liabilities model, innovations in risk analysis methods, particularly relating to technical risks in the industrial sphere; legal innovations as applied to insurance, such as the setting up of bancassurance policies; innovations in HRM. We will also include in this category another form of innovation that might be described as *informal management* or *makeshift innovation*, in which solutions are found for certain local problems, sometimes in a secretive (even, paradoxically, disreputable) way, particularly when the innovation involves bypassing central computer systems.

To conclude this point, we can say that:

- 1) Most of the process innovations taken into account by Barras' model belong to categories D2 and D3;
- 2) "Product" innovations in the sense of new contracts and new services (categories A, B, C) which are the core of insurance activity are mostly not accommodated by Barras' model, which contains a very restrictive definition of "new products";
- 3) "Product" innovations (in the sense of new contracts, new services) can give rise to process innovations. In this case, Barras' cycle is reversed in that product innovation precedes process innovation (a return to the traditional cycle).

## VI. CONCLUSION

Barras' model constitutes, in our opinion, a neo-Schumpeterian theoretical synthesis of many studies in terms of "the impact of information technology and telecommunications technology on services". Scattered materials, empirical and theoretical results have been drawn together into a synthetic and dynamic model, with its own internal coherence. Consequently, R. Barras has effectively succeeded in what he set out to do, i.e. devise a "theory of innovation". But it is less a theory of innovation in services than a theory of the spread of technological innovation from manufacturing to services. In other words, the reverse product cycle model remains fundamentally technologist: innovation is not really considered to occur outside of "technological possibilities". It does not take into account, for example, the appearance of new functions which are independent of technology.

Part of the problem stems from the fact that R. Barras does not alter the conceptual frame of reference. The model is, indeed, concerned primarily with material technologies, and no other form of technology is taken into consideration. This bias is

doubtlessly due to the choice of technology-intensive service industries as a field of investigation. Product and process innovations are then considered, but the question of the validity of transposing these concepts onto services is not addressed. Finally, the notion of life cycle, reversed or not, also merits the same investigation as regards its true scope in services.

Once again, this does not mean that Barras' model should be rejected. Indeed, his model studies, in a highly thought-provoking and unprecedented fashion, *a certain (important) aspect of innovation in services*. Rather than rejecting the model, we must seek to *complement* the model through studies which place emphasis on the least technologist aspects of this type of innovation.

## BIBLIOGRAPHY

- Abernathy, W. Utterback, J. (1978), Patterns of Industrial Innovation, *Technology Review*, 80, June-July, pp. 41-47.
- Barcet, A., Bonamy, J. and Mayère A. (1987), *Modernisation et innovation dans les services aux entreprises (Modernisation and innovation in business services)*, Report for Commissariat Général du Plan.
- Barras, R. (1986), Towards a Theory of Innovation in Services, *Research Policy*, 15, pp. 161-173.
- Barras, R. (1990), Interactive Innovation in Financial and Business Services : The Vanguard of the Service Revolution, *Research Policy*, 19, pp. 215-237.
- Belleflamme, C., Houard, J., Michaux, B. and Ruysen, O. (1986), *Innovation and Research and Development Process Analysis in Service Activities*, IRES, Report for EC, FAST programme.
- Bressand, A. and Nicolaïdis, K. (1988), Les services au coeur de l'économie relationnelle, *Revue d'Economie Industrielle (Services in the heart of the relational economy)*, 43, pp. 141-163.
- Desai, M. and Low, W. (1987), *Measuring the Opportunity for Product Innovation*, in M. De Cecco (Ed), *Changing Money : Financial Innovation in Developed Countries*, Basil Blackwell.
- Djellal, F. (1998), *Innovation in French road haulage*, preliminary report for EC, DG XII, TSER programme.
- Eiglier, P. and Langeard, E. (1987), *Servuction : le marketing des services (Servuction : services marketing)*, Mc Graw-Hill.
- Ernst, M.L. (1985), *Electronics in Commerce*, in T. Forester (Ed.), *The Information Technology Revolution*, MIT Press.
- Flipo, J.-P. (1984), *Le management des entreprises de service (Service firms management)*, Les Editions d'organisation.
- Foray, D. (1993), *Modernisation des entreprises, coopération industrielle inter et intra-firmes et ressources humaines (Firms modernisation, inter and intra-firm cooperation and human resources)*, report for the french Ministry of research and technology, june.
- Gadrey, J. (1991), Le service n'est pas un produit : quelques implications pour l'analyse économique et pour la gestion (The service is not a product : some consequences for economic analysis and management), *Politiques et Management Public*, volume 9, n°1, march.

- Gadrey, J. and Gallouj, F. (1994), *L'innovation dans l'assurance : le cas de l'UAP (Innovation in insurance : the case of UAP)*, report for UAP and the french Ministry of research, University of Lille I, september.
- Gadrey, J. and Gallouj, F. (1998), The provider-customer interface in business and professional services, *The service industries Journal*, Vol. 18, n°2, April, pp.1-15.
- Gadrey, J., Gallouj, F. and Weinstein, O. (1995), New modes of innovation : how services benefit industry, *International Journal of Service Industry Management*, volume 6, n° 3, pp. 4-16.
- Gallouj, C. (1997) *Innovation in french retailing*, preliminary report for EC, DG XII, TSER program, march.
- Gallouj, C. and Gallouj, F. (1996), *L'innovation dans les services (Innovation in services)*, Editions Economica, Paris.
- Gallouj, F. (1991), Les formes de l'innovation dans les services de conseil (The forms of innovation in consultancy services), *Revue d'économie industrielle*, n°57, pp. 25-45.
- Gallouj, F. (1994), *Economie de l'innovation dans les services (Economics of innovation in services)*, Editions L'Harmattan, Logique économique, Paris.
- Gallouj, F. (1997), Towards a Neoschumpeterian Theory of innovation in Services, *Science and Public Policy*, Vol. 24, n°6, december, pp. 405-420.
- Gallouj, F. and Weinstein, O. (1997), Innovation in services, *Research Policy*, 26, p. 537-566.
- Goldman, A. (1975), The role of Trading up in the development of retail system, *Journal of Marketing*, Volume 39, n°1, pp. 54-62.
- Hardouin, J.C. (1973), *L'apparition de l'innovation financière. Contribution à l'étude de ses éléments explicatifs (The appearance of financial innovation : a contribution to the analysis of its determinants)*, Complementary Thesis, University of Rennes.
- Henderson, R.M. and Clark, K.B. (1990), Architectural Innovation : The Reconfiguration of Existing Product Technologies and the Failure of Established Firms, *Administrative Science Quarterly*, Vol. 35, n°1, march, pp. 9-30.
- Hollander, S.C. (1966), Notes on the Retail Acordion, *Journal of Retailing*, Vol. 42, n° 2, pp. 24-33.
- Jallat, F. (1992), *Le management de l'innovation dans les entreprises de services au particulier : concepts, processus et performances (Innovation management in household services : concepts, processes and efficiency)*, PhD Thesis, University of Aix-Marseille III.
- Kubr, M. (1988), *Management Consulting : a Guide to the Profession*, ILO, Geneva.
- Lakshmanan T. (1987), *Technological and Institutional Innovation in the Service Sector*, Conference "R-D, industrial change and economic policy", University of Karlstad, Sweden, June.
- Langeard, E. and Eiglier, P. (1990), *L'innovation de service (Service innovation)*, Working paper, University of Aix-Marseille III, march.
- Lasfargue, Y. (1995), *Quelques réflexions sur les innovations et l'évolution des métiers (Some thoughts about innovations and jobs evolution)*, INTEPF seminar "Compétitivité des services : quel avenir pour le travail et l'emploi ? (Services competitiveness : what kind of future for work and employment ?)", Marcy l'Etoile, November 16.



- Lovelock, C. (1992), *A Basic Toolkit for Service Managers*, in C. Lovelock (ed), *Managing Services : Marketing, Operations, and Human resources*, Prentice-Hall International Editions.
- Mc Nair, M.P. (1958), *Significant trends and developments in the post war period*, in A.B. Smith (ed.) *Competitive Distribution in a Free High Level Economy and its implication for the University*, University of Pittsburgh Press, Pittsburg, pp. 1-25.
- Miles, I., Kastrinos, N., Flanagan, K., Bilderbeek, R., Den Hertog, P., Huntik, W. and Bouman M. (1995), *Knowledge-Intensive Business Services : Users, Carriers and Sources of Innovation*, Report for DG13 SPRINT-EIMS, march.
- Niehans, J. (1983) "Financial Innovation, Multinational Banking, and Monetary Policy", *Journal of Banking and Finance*, 7, pp. 537-551.
- Pavitt, K. (1984), Sectoral Patterns of Technical Change : Towards a Taxonomy and a Theory, *Research Policy*, 13, pp. 343-373.
- Petit, P. (1990), *Emploi, Productivité et technologies de l'information : le cas des services (Employment, productivity and information technologies : the case of service industries)*, IRIS Conference, University of Paris XI Dauphine "Competence and competitiveness", april, 5.
- Soete, L. and Miozzo, M. (1990), *Trade and Development in Services : a Technological Perspective*, MERIT, The Netherlands.
- Sundbo, J. (1993), *Innovative Networks, Technological and Public Knowledge Support Systems in Services*, Roskilde University, mimeo.
- Tarondeau, J.C. and Xardel D. (1992), *La distribution, (Retailing)*, Paris, PUF, Que sais-je.
- Van Der Aa, W. and Elfring, T. (1993), *A typology of Innovations in Service Firms*, Conference on "Managing Innovations in Services", Cardiff Business School, April 5-7.
- Zaltman G., Duncan, R., Holbek, J. (1973), *Innovation and organization*, John Willey and Sons, New York.

**PAPER 5 :**

**INNOVATION AS A LOOSELY COUPLED  
SYSTEM IN SERVICES**

**(Paper presented at the CRIC workshop on Innovation and Services 17-18 March  
1998, Manchester)**

## INNOVATION AS A LOOSELY COUPLED SYSTEM IN SERVICES

**Jon Sundbo (Roskilde University, Denmark) and Faïz Gallouj (Lille University, France)**

**Paper presented at the CRIC workshop on Innovation and Services 17-18 March 1998, Manchester**

### *Summary:*

*The goal of this paper is to assess whether innovation in services can be described as a coherent and steady system. Our results are based on the survey of a great deal of theoretical but mostly empirical literature including an ongoing European project called SI4S (Innovation in services and services in innovation). We first present some general characteristics of services and of service innovations. Then, we analyse some typical innovation patterns in services. These patterns are different versions or configurations of a model of actors and trajectories. The discussion of these different patterns lead us to the conclusion that innovation in services is not an institutionalised system but rather a loosely coupled system.*

### **Introduction**

In this article we will put forward a model of the innovation system in services. The model is theoretical, but based on a review of a large amount of existing empirical research on innovation in services, including a recent E.U. financed project, called the SI4S (Services in Innovation and Innovation in Services) project which we have participated in, and which has been the occasion for us to develop these thoughts<sup>i</sup> (Sundbo and Gallouj, 1998),

We find that the empirical results give us a basis for establishing a general model and that it is a fair generalisation of these results. Even if the service industries are different from one another, the empirical research indicates that there are some common characteristics of the innovation processes due to the specific nature of service production that is common to all service industries.

The main focus of the model is the innovation processes from the perspective of the service sector: How do service industries view their innovation activity? What are the driving forces behind the single service enterprise? More generally, how do these driving forces combine to constitute a system? And how should we characterise this possible system?

This article is divided in four sections. The first section is devoted to an attempt to present some general characteristics of services and of service innovations. On the basis of empirical work, sections 2 and 3 present some typical innovation patterns in services. This presentation leads us to what we mean by innovation system and whether an innovation system may exist in services is discussed in section 4. In the conclusion we discuss how the analysis might contribute to developing evolutionary theory of innovation.

## 1. Service firms do innovate

Services have been considered in most of the literature as an appendix to manufacturing (e.g. Cohen and Zysman, 1987 ; Miles et al., 1994), a residual or peripheral sector, or at least as a sector lagging behind the manufacturing sector in form of low productivity, low capital intensity, weak qualification levels and low innovation activity. This is not true. Service firms do innovate, but their innovations may take other forms than in manufacturing and they may be organised differently.

The different forms of service innovations are to some degree related to the specific form of service production, and we will therefore start by briefly stating these characteristics.

By looking at the special forms that service innovations take, we may learn more about innovation processes, which might even be valid for manufacturing innovations as well.

### 1.1 General service characteristics

The particular innovation pattern in services, for example compared to manufacturing, must be explained by the specific characteristics of service production. We will not detail these here as they have been treated intensively elsewhere (e.g. Gadrey, 1992; Illeris, 1996; Normann, 1991) but only briefly repeat the facts that are most relevant to innovation.

In service industries product is not always perfectly "formatted" and codified, ie precisely determined a priori. Each service transaction may be considered as unique as far as it is produced on demand (tailor-made) in interaction with the client or as a response to a specific, not standardisable problem, and in different environments.

Client participation (in various forms) in the production of the service may be the most basic characteristic of service activities, particularly knowledge-intensive ones. Various concepts have been developed in order to account for this client involvement (co-production, servuction, service relationship, the moment of truth, presumption). At the interface between the service provider and its client different types of interaction are occurring. Different types of elements are being exchanged: information and knowledge, emotions, verbal and gesture signals of civility. This interaction also expresses power struggle, domination and reciprocal influence relationships.

The service industries are also under pressure to reduce the costs and that lead to a standardisation tendency. This standardisation means that service production is not unique in the single delivery situation. The service firms attempt to combine this with the individual customer care in a modulisation system (Sundbo, 1994).

The analytically useful in using (though difficult) a distinction between product and process, is widely accepted in the case of manufacturing goods. The same is not true of services where the product mostly can not be separated from the process. Here, the term "product" frequently includes a process: a service package, a set of procedures and protocols, an "act".

In the case of services, and particularly those in which the intangible and relational aspects are important, the correspondences between the competencies and other means brought to bear by the service provider and the "product" are generally much hazier and much more difficult to codify : they are to a large extent tacit and subject to the difficulties caused by informational asymmetry. The emphasis on quality and trust is therefore an important dimension of service activities.

## **1.2 Service innovation as an interaction process**

The innovation process in services is to a large degree an interaction process, both externally and internally.

It is an interaction with external actors, particularly with customers. The customer's satisfaction with the total encounter (not only the core service delivered, but also the circumstances of the delivery) has been crucial in service production. Customer satisfaction has been more important than the issue of a new core service. Customer satisfaction, in terms of service quality, has thus been more important to service firms than innovation. There have been innovations, but mainly as delivery or process innovations. However, the standardisation or modularisation tendency has made it more relevant to emphasise product innovations and innovation generally.

Nevertheless the tradition has led service firm to still be extremely fixed on the customer encounter, also in terms of their innovation activities. These emphasise the client interaction (sociologically: primary interaction) as an important parameter in the innovation process (Edvardsson et al., 1995). It is a crucial factor in the process of getting the innovation accepted on the market. The primary interaction is often forgotten in the theories on manufacturing innovations that more or less implicitly presupposes that the marketing of a new product is a mass process (sociologically: secondary interaction), and it is so for mass goods.

The innovation process is also an interaction process at the internal level. Innovation is generally an unsystematic, collective process in which employees and managers participate in different interaction patterns at the formal and informal level. The organisation of innovation is differentiated and various patterns can be observed in different types of firm as we will see in section 2. The service firms have not been good at organising the innovation process in a formalised and systematic way and learning from the process. This is even valid for the external interaction with customers (Edvardsson et al., 1995).

The contemporary tendencies in the service sector, however, are towards a more systematic innovation process, often based on certain trajectories. They are often service professional trajectories (ideas and logics within a service professional such as law, accountancy, etc.), but may also be technological trajectories. The service firms still maintain a great deal of flexibility in the innovation activities, which involve several actors and trajectories.

## **1.3 Innovation and non-reproduced small changes**

Innovations in services are a mix of reproducible (although incremental) innovations and "small", non-reproducible or not directly reproducible changes to solve single customers' problems (what we also will call ad hoc innovation). The latter is particularly a result of the customer interaction process.

This means that we must understand the development of service business by combining innovation theory (which concerns reproducible renewals - that a new product is produced in more than one copy, a new process element is used generally in the organisation, etc.) and a theory of continuous change as accumulated, not (necessarily or only partially) reproducible ad hoc innovations. We cannot catch all these individual changes in one theory, but we can understand the firms' attempt to guide this process through a combination of two theoretical elements: 1. On organisational creativity, 2. On organisational learning.

## **1.4 Three types of approaches to understand innovation in services**

A useful distinction can be made between approaches that might be described as "technologist", which focus on analysis of the introduction of equipment and technical systems, service-oriented approaches that emphasise divergence by highlighting the specific characteristics of service activities and integrative approaches that emphasise convergence by advancing analyses that can be applied to both goods and services. All these works are more deeply analysed in F. Gallouj (1994) and C. and F. Gallouj (1996).

*1) Innovation in services and technology: one referent, a multiplicity of relationships*

Many studies in this first category (technologist approaches) concentrate exclusively on innovations that are both technological and adopted, usually at the expense of ignoring non-technological innovation and technological innovation produced by service firms themselves.

This technologist approach can be interpreted in various ways, empirical and theoretical. The first consists of recording the extent to which technologies have been diffused within services, as shown by statistical studies. Service industries are now the main users of information technology in all the developed economies (Miles et al., 1994). The second, linked to the first, is based on investigation of the nature of the effects produced by the adoption of these technologies on economic variables such as productivity, employment, skills, trade, etc. The use, implicit or explicit, of standard neo-classical economic theory (through the production function concept) constitutes a second line of interpretation. This theory has in fact contributed to the development of a "mechanistic" approach to production and to a somewhat reductionistic, "technologist" view of innovation that focuses on process innovations embodied in capital goods. Although they adopt a much wider definition of innovation, the new neo-Schumpeterian and evolutionary approaches to technical change are not immune to this technologist bias, and have even contributed to it to a certain extent (Gallouj, 1997). Their primary objective is usually to analyse the ways in which service firms and industries adopt or, in a few cases, produce technologies. For the moment, their theoretical horizons are limited to the application to the service sector of concepts and methodologies developed with reference to manufacturing industry, such as the natural technological trajectory, the technological paradigm, sectoral taxonomies of forms of technological change, etc. (cf. in particular Soete and Miozzo, 1990). But it is possible as we will see here (cf. also, Gallouj and Weinstein, 1997) to use these evolutionary theories in a less technologist perspective.

Barras' work (1986, 1990) is particularly interesting because of its theoretical ambition. In certain services (banking, insurance, accounting, administration), Barras has observed a product life cycle that is the converse of the traditional industrial cycle. The basic element of this so-called "reverse product cycle" theory is the adoption of an item of computer equipment by a service activity that triggers what might be called a "natural technological trajectory". This leads, in the first instance, to the emergence of incremental process innovations, the purpose of which is to improve the efficiency of the service being provided, secondly to an improvement in service quality through more radical process innovations and finally, in the last phase of cycle, to the emergence of product innovations. Thus innovation is not viewed in isolation from the technological potentialities, and Barras' model is less a theory of innovation in services than a theory of the diffusion within the service sector of technological innovations derived from manufacturing industry.

*2) The specificities of innovation in the service sector as a priority for analysis*

Without ignoring the technological dimension, the "service-oriented" approaches focus on non-technological forms of innovation; in this respect, they follow Schumpeter's well-known broad and open definition of innovation.

Studies based on this approach often take the "purer" services as their field of investigation, i.e. those in which the criteria of intangibility and the co-production of output are assumed to be most evident. Consultancy services, for example, are an interesting area for empirical analysis of service-oriented innovation. In his study of consultancy firms, Gallouj (1994) highlights the existence of ad hoc forms of innovation that are not immediately reproducible and of institutional "formalisation" trajectories (i.e. the search for a certain degree of formalisation, though not necessarily, or even predominantly, in tangible form).

The studies by Van der Aa and Elfring (1993) Gadrey et al. (1995) and Sundbo [33] also take a broad, Schumpeterian view of innovation. According to Sundbo (1997) innovations in services do not follow a technological trajectory (in Dosi's sense (1982) but rather service-professional trajectories (e.g. a certain number of ideas on management, banking, etc.) in which technologies are only one vector among several others.

### *3) The search for convergence and the desire for analytical integration*

The notion of adopting a similar approach to the economic analysis of both goods and services is based on the observation that the boundary between goods and services is becoming increasingly less clear. Certain services are being "industrialised" and, conversely, the production of certain goods is being "tertiarised". These converging tendencies are often described in terms of the goods-services continuum and functions.

The study by Barcet, Bonamy and Mayère (1987) adopts this approach and results in a classification of the forms of innovation that applies to both goods and services. These authors categorise innovations according to whether they relate to function, specification or the production process. The first category encompasses the emergence of new, undifferentiated, abstract functions, such as the storage of picture and sound in the case of video recorders, or the identification of a new risk to be covered in the insurance industry; the second involves the concrete realisation and differentiation of the functional innovation, while the third corresponds to a cost-cutting activity (as a result of standardisation, the use of new technical instruments, etc.).

The characteristics approach developed by Gallouj and Weinstein (1997) is also integrative. Following and extending Saviotti and Metcalfe's (1984) representation of the product it shows that an approach to products in terms of competencies, service, technical and process characteristics offers a stimulating starting point for the study of innovation in both goods and services without sacrificing any of the specific aspects of innovation in services. Various modes of innovation are highlighted (radical innovation, innovation based on improvement, innovation involving the addition of new characteristics, ad hoc innovation, re-combinative innovation, innovation through formalisation) and interpreted in terms of a characteristics dynamic. This may take different forms : addition, elimination, improvement, bundling, unbundling, shaping of characteristics.

## **2. Internal and external driving forces: The components of innovation patterns**

As a basis for presenting the innovation patterns, we will start by setting up the driving forces of innovation in services in a scheme. These are the determining elements in the innovation process and a possible system is composed by a combination of the driving forces.

The formulation of these driving forces are the result of an investigation of most of the existing research on innovation in service which has been part of the SI4S project<sup>ii</sup>. It is also based upon the survey of other existing empirical literature.

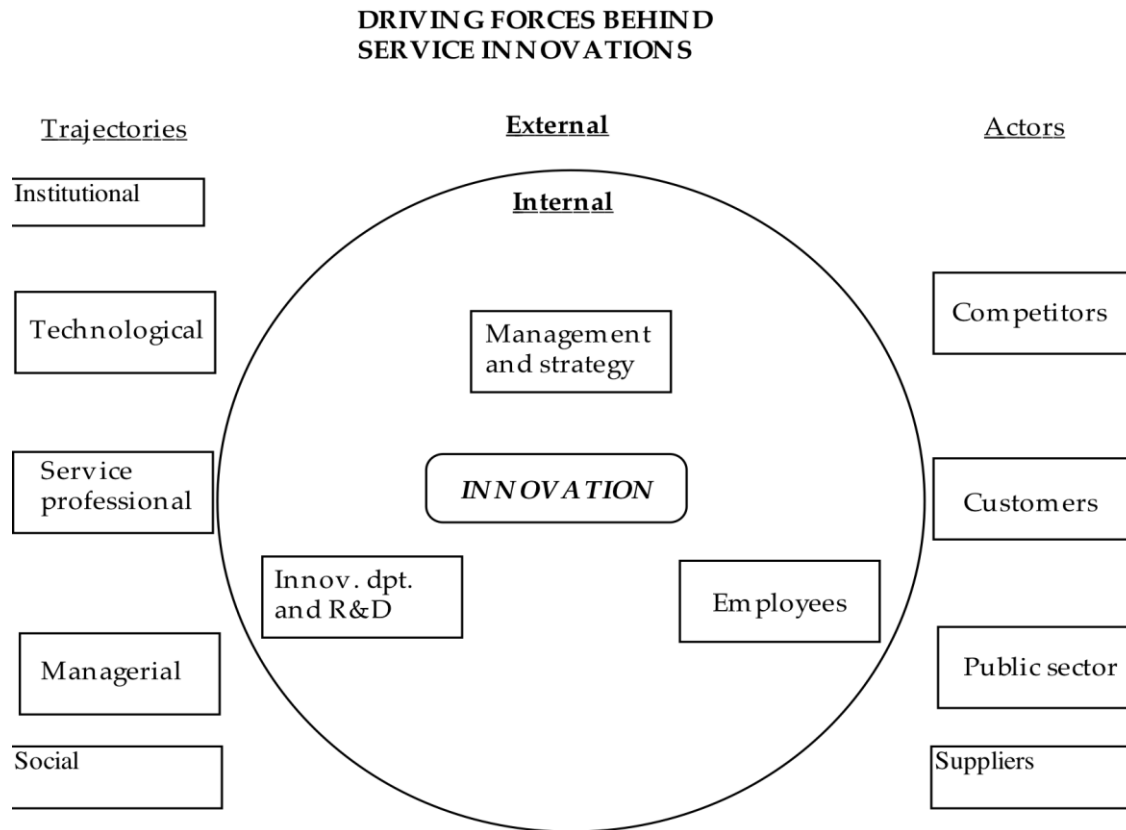

**Figure 1 :** Driving forces behind service innovation  
From: Sundbo and Gallouj (1998)

Taking the firm as a landmark, there are external and internal driving forces.

### 2.1 Internal driving forces

The innovation process in service firms is mainly driven by internal forces (however, this may be said about manufacturing firms as well).

There are three internal forces.

The first is the management and the strategy of the firm. Management could be the top manager, but it is often the management of the marketing department since service innovations very often are market driven and the marketing department, which has the direct customer contact and market knowledge, is the leading actor in innovation activities.

The innovation process in services is mostly a loosely coupled process in which the employees (including managers at all levels) are involved, or they just function as corporate entrepreneurs and start the process. The employees are, therefore, an important driving force. They are the second internal driving force.

A third driving force is formalised R&D departments or other type of formalised department which has the responsibility for ensuring that innovations will appear. The latter



is a kind of communication department, that exist in some service firms and which has the task to induce innovation ideas among the employees and managers and to collect these ideas; the innovation department do sometimes innovate itself, but this is not always the case. Since service innovations rarely are science based, it is very rare to find R&D departments in service firms.

## 2.2 External driving forces

The external forces can be divided into trajectories and actors. Trajectories are considered to be external driving forces even though the innovation activities of the single firm can contribute to the reinforcement of a given trajectory.

*Trajectories* are ideas and logics that are diffused through time and through the social system (being a nation, an international network, professional networks etc.) (cf. Dosi, 1982). They are often diffused through many and difficult identifiable actors. The important factor is, however, not the actors, but the ideas and the logic behind the ideas. There may be identified five types of trajectories.

The most important factor is service professional trajectories by which we mean methods, general knowledge and behavioural rules (e.g. ethics) that exist within the different service professions (e.g. lawyers, nurses, catering (how to cook)).

Another type of trajectory is general management ideas or ideas for new organisational forms such as motivational systems, BPR, service management etc. These two first types of trajectories may highly overlap as far as knowledge intensive business services (KIBS) are concerned.

The third type of trajectory is technology trajectories in the traditional economic sense. New logics for producing and using technology that generally influence service products and production processes. Examples are the ICT wave and more specific the Internet, and the freezer and microwave oven which together has created a new distribution system within catering. Some service fields (such as software, financial services, technical services etc.) have contributed more to the ICT development than manufacturing (Miles et al., 1994).

The institutional trajectory describes the general trend of the evolution of regulations and political institutions (for example : the European construction, the European research programs, regulation changes).

The social trajectory displays the evolutions of general social rules and conventions (for example: ecological and environmental consciousness).

These different trajectories are not independent of each other, they may in many situations be intertwined in the same firm.

*Actors* are persons, firms or organisations who's behaviour has importance for the service firms' possibilities for selling services and therefore for their innovation activities. The actors define the market possibilities and they are sometime involved in the development of the innovations.

Customers are of course actors of major importance. They may be sources of information but they also can contribute more actively to the innovation process. In certain situations, the interface between the service provider and its client can be considered as a genuine laboratory where certain types of innovation are co-produced.

Competitors are also important for the innovation activities. Service firms may imitate competitors' innovations, and since service industries generally not have been characterised by offensive innovation strategies, a condition for starting an innovation activity has often been that the competitors should be moving first.

Suppliers and especially knowledge business service suppliers are important sources of innovation as well. To complement the two well-known Schumpeterian models of

innovation (Schumpeter Mark I and Schumpeter Mark II), it is possible to define what could be called “a consultant-aided model of innovation” (cf. Gallouj, 1994). Therefore, knowledge business service suppliers or some of them may be considered as a new locus of the “Schumpeterian enterprise spirit”. Technology suppliers (including software suppliers) are also sometimes important partners in the innovation process, much knowledge business service suppliers and software has been developed in cooperation between service firms that needed a new technology, and technology suppliers.

The public sector is the least important actor, but nevertheless an actor of some importance. The public sector demands services, and it delivers research and education necessary to innovation activities, but the public sector is rarely an direct actor in service innovation processes, neither as change agent nor as deliverer of knowledge (since service innovations rarely are science based). Further, the public sector has regulated the service sector, a function that in fact has led to many innovations, but also has impeded innovation. Many financial innovations are due to changes of tax laws. The contemporary tendency to deregulation makes this function of the public sector less important.

### 3. Typical innovation patterns

One can theoretically state many patterns by combining these driving forces. Seven patterns of innovation have been found in empirical research until now. We will call them :

- 1) the classic pattern (traditional or fordistic variant)
- 2) the classic pattern (neo-industrial variant)
- 3) the service-professional pattern
- 4) the organised strategic pattern
- 5) the entrepreneurial pattern
- 6) the artisanal pattern
- 7) the network pattern

#### 3.1 The classic R&D pattern (the industrial pattern of innovation) and its evolution

This pattern is the less frequent in service industries (cf. Barcet et al., 1987). Nevertheless it can be found in large size firms specialised in the production of standardised operational services dealing with material or information. For example: large firms specialising in information mass processing, building maintenance or tele-guarding. This is a copy of the traditional manufacturing R-D pattern which makes a clear dissociation between R-D and production. Compared, for example, to knowledge business service firms one can say that in this types of firms there is generally a dissociation between the service production and its delivery. It is therefore possible to create an R-D department devoted to the improvements of the “ products ” that are to be delivered or to the design of new “ products ”.

This industrial pattern of innovation, as it is defined (notably by Barcet, Bonamy, Mayere, 1987) seems to us ambiguous. It refers to the old industrial pattern, which has changed a lot itself. The new industrial model, which has substituted a flexibility logic for the old standardisation logic, is far closer to the functioning of service activities (which are often interactive by definition).

One may distinguish between two variants of the classic R&D pattern: a traditional or fordistic variant, and a neo-industrial one.

##### *A traditional or fordistic variant*

This pattern (Figure 2) is defined as above. It is rare in services and it tends to be rarer in manufacturing as well. The main lever of innovation is the pursuit of the technological trajectory (technological and process innovations). One or several departments specialised

in innovation do exist. They develop linear relationships (without any real feed-back) with the other departments (traditional linear model of innovation). These innovation departments are generally production technical departments or information technology departments. The client is present in this pattern but only as a passive source of information.

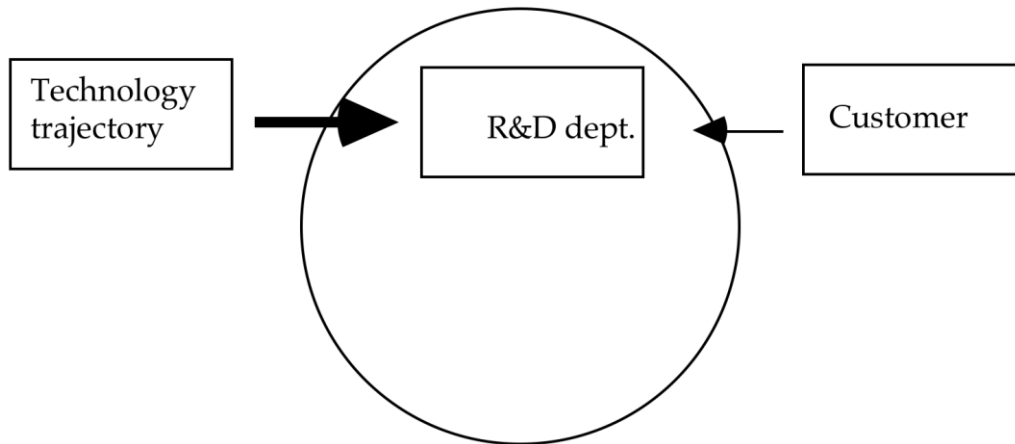
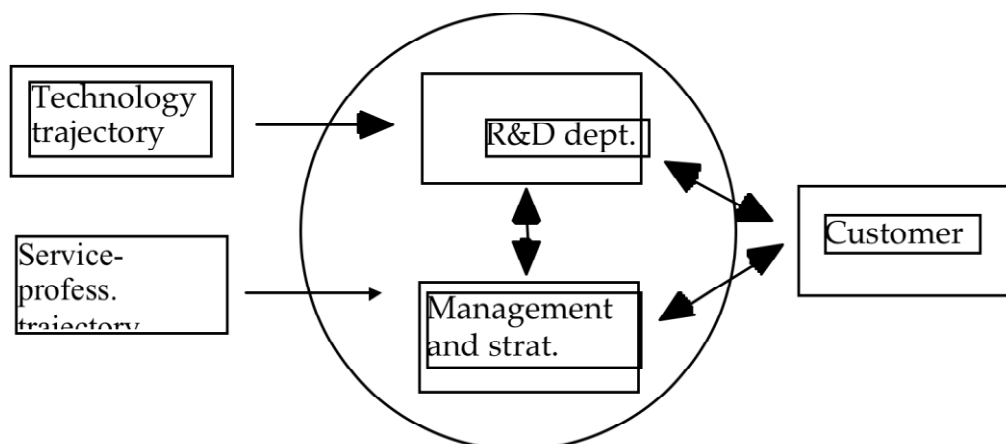

**Figure 2** : The industrial pattern : traditional or fordistic variant

*A neo-industrial variant*

Firms run according to the traditional industrial pattern tend to move towards this new one. The neo-industrial pattern refers to certain evolutions that are occurring in mass informational services that traditionally were following a fordistic pattern and that now are facing important competition pressures (banks, insurance companies, postal services). In these firms innovation is produced by interacting sources or actors. The innovation process does rarely follow the linear model, but often a more complex pattern (cf. Kline and Rosenberg, 1986). These interactions are “ technical ” unavoidable relations, no matter their quality and efficiency. In insurance companies the actors are for example, information technology departments, the various actuarial departments, the marketing department, possibly a genuine research laboratory (cf. Gallouj and Gallouj, 1996). Transversal project groups are favoured and multiplied with more or less success. In this pattern, the levers of innovation are both the technological trajectory and the service-professional trajectory. The main actors participating in each trajectory and its corresponding forms of innovation interact. Management and strategy play an important role as well.

This model is more customer oriented. More innovations come from a pull effect, namely the expected future needs of the customers.



**Figure 3 : The neo-industrial pattern**

One can distinguish between two sub-variants of this neo-industrial variant (Gallouj et al, 1997) :

- 1) The variant in which the technological trajectory and the service trajectory are in an imbalanced interaction ;
- 2) The variant in which they are in a balanced interaction.

In the first case, if we define a product as a set of service, technical and process characteristics in correspondence (Saviotti and Metcalfe, 1984), one can say that the service characteristics change much more rapidly than the technical and process characteristics. There is, to a certain extent, proliferation of new services characteristics (or functions) while the technical and process characteristics remain unchanged. The incremental model of innovation (innovation by adding characteristics) play a very important role here.

In the second case (when the technological trajectory and the service trajectory are in a balanced interaction), certain members of the organisation have in charge to produce technical and process characteristics and others service characteristics. There is a share of tasks and a certain balance of power, which doesn't mean a lack of conflicts.

### 3.2 The service professional pattern

This model which has also been described by Barcet, Bonamy and Mayère (1987) characterises the professional knowledge service firms. They are generally medium size firms devoted to knowledge intensive business services. These firms don't really sell product-services, but competencies, abilities to solve problems in different expertise areas (consultancy and engineering).

In this pattern formalised structures dedicated to innovation do not exist. The innovation trajectory is of the service-professional type.

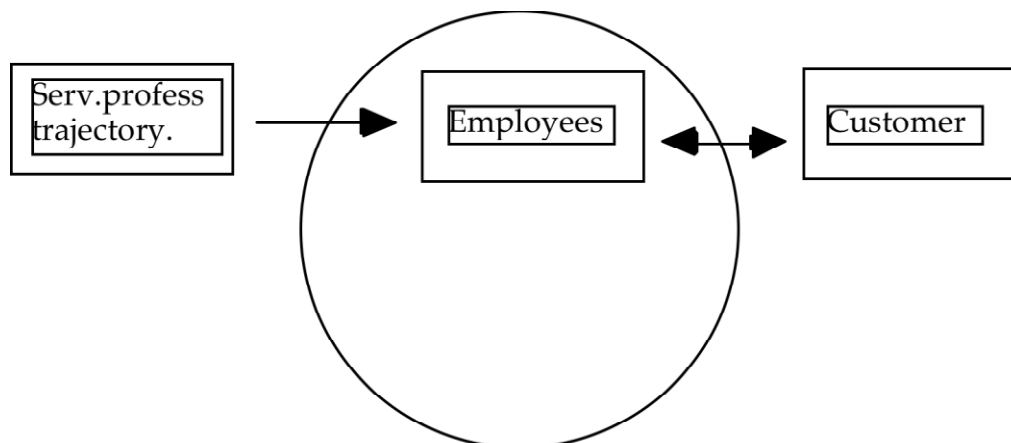

**Figure 4 : The service professional pattern**

The innovation process is a collective process in which all the professionals are supposed to participate. It will often be a more disciplined, and less "wild" and radical, process than in the entrepreneur model (see below). The professional often follows certain professional norms and methods in their innovation.

Extrapolating Martin and Horne's analysis (1995) one can describe this pattern as bottom-bottom or top-top. Because of this the service professional pattern has a certain number of advantages : it is flexible, able to answer quickly to market signals, able to cross

synergically the individual ideas and experiences of its members. Conversely, as far as it heavily depends upon its individual components it also has a number of disadvantages among which are the risk that the innovation process is not completed, and the absence of enterprise projects.

In the service professional pattern, the main driving force or lever of innovation is individual expertise and competencies which correspond to the service-professional trajectory. An important locus of innovation is the interface with the customer. Thus the client who is present here plays a much more active role than in the previous pattern. The ad hoc type of innovation (cf. section 1.3), without being exclusive, plays an important role here.

The analysis of the different steps of such an ad hoc type of innovation shows that the steps of production, selling and innovation take place simultaneously or are merged. The client's problem (in its concrete sense) is the starting point of the innovation process. An important point here is that this service production process, which a posteriori becomes an innovation process ends with a formalisation step. This formalisation step is achieved without the client's participation. It aims at going through the problem and the innovating final solution again and at formalising and modifying them in order to re-appropriate some of their components and to capitalise them in the organisational memory of the firm (for example paper, software, IT-files audio-visual, routines, etc.).

As a product of the customer interface, ad hoc innovations, particularly in consultancy firms, depend upon the nature and components of this. Thus sparring type interfaces conversely to jobbing type (Gadrey and Gallouj, 1998) are most propitious for the creation and success of this form of innovation, because they help to assure a better understanding and acceptance (legitimacy) of the innovation. Moreover, problems of a strategic nature, themselves potential sources of innovation, are most often the object of a sparring type interface. However, one must not conclude from this that only creative problems (as Kubr, 1988 calls them) - those where one seeks to develop a completely new situation - are carriers of *ad hoc* innovation. Corrective problems, in which the consultant plays the role of therapist, and progressive problems, in which the consultant are expected to improve a given situation that is feared to be deteriorating, are also ad hoc innovation carriers. Furthermore, the opportunities for ad hoc innovation appear to increase with the size of the service provider and that of the client. The effective implementation of ad hoc innovations also depends upon the quality of the professionals in the client organisation participating in the interface.

Some of the professional knowledge service firms have currently a tendency to move towards the third pattern, the organised strategic innovation pattern. The innovation process becomes guided by the top management and the firm's strategy and less anarchic and free for the professionals.

### **3.3 The organised strategic innovation pattern**

The organised strategic innovation pattern (or the managerial model of organising the innovation) is the most typical within the service sector. It is definitively so for large service firms, but even small service firms are moving towards this model.

This pattern corresponds to the real existence of a policy, a strategy or a function of innovation in the firm, but to the absence of a permanent R-D-innovation department. Research and more precisely new ideas research is every one's task, but design and development, which require much time, are done by ad hoc project teams. The logic which is favoured is that of designing products which are as reproducible as possible. Whether we can conclude that a trend of industrialisation does exist in service, is difficult to say. Empirical research suggests different conclusions. In some research an industrialisation

tendency has been found (Sundbo, 1994, 1997), in other it was found that a professional rationalisation logic (combining technology, service-professional, managerial strategies or trajectories) prevails rather than an industrial rationalisation logic (Gadrey, 1994).

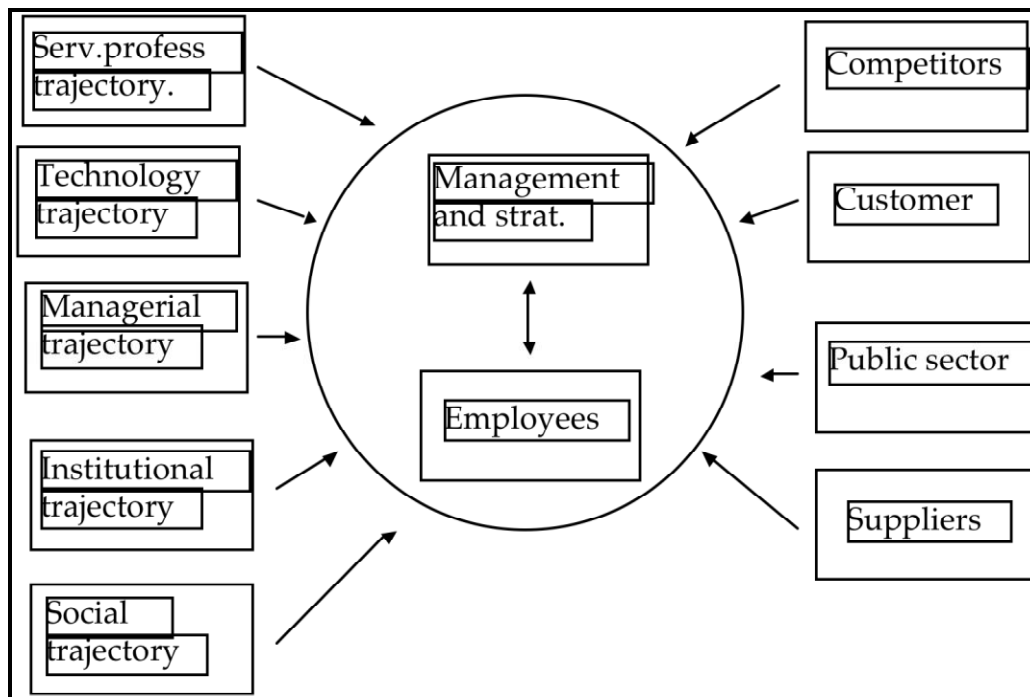

**Figure 5 :** The organised strategic innovation pattern

In this model the innovation policy is supplemented with two important actions: 1) knowledge accumulation in order to facilitate its reproducibility and the share of individual knowledge among the firm ; 2) quality control as a mean of checking the respect of service standards, but also as an indicator of the evolution of the nature of clients' demand. The innovation process becomes a process of balanced entrepreneurship (Sundbo, 1992, 1996) : The employees act as corporate entrepreneurs, but the management attempts to regulate and control the corporate entrepreneurial process. The framework for the management's regulation is most often the strategy, which contains the policy for innovation (which types, for which market segment etc.). The strategy can also function as an inspiration for innovative ideas.

The innovation process is often organised in different steps, starting with a free corporate entrepreneurial idea phase, which turns into a more guided development phase, often organised as team work, and finally ending as a test and marketing activity in which the marketing and a production department have the main role. The marketing department when it exists is often the strongest department in the innovation processes.

The innovation policy in this pattern is very broad, which means that the firm is looking for many fields in which it could make innovations, e.g. in marketing, production organisation etc., and since the innovation policy is determined by the strategy, the management focuses much on what is going on in society. This will namely determine the future customer needs. Thus, all the trajectories are relevant here as are all the actors.

In previous works devoted to consultancy sector, Gallouj (1995) shows that this pattern (for example the design of a formatted method or product-service) may follow the standard scheme of industrial R-D (be more or less formalised) : as in the R-D pattern, innovation, production and selling may be at least in theory be separated. A certain formalisation of the

ideas' genesis is possible through internal gathering procedures of ideas; gathering procedures of customer ideas and dissatisfactions (user groups for example).

### **3.4 The entrepreneurial pattern**

This pattern corresponds to the creation of service firms on the basis of a radical innovation. These firms are small and do not have any R-D department. Their main activity is to sell the initial radical innovation. The innovation processes that might follow later are generally focused on the improvement of the latter. The appearance of IT services, of repairing services, etc. may be interpreted in these terms.

Numerous firms set up by university researchers often corresponds to this entrepreneurial pattern as well, but the pattern can be found in all service industries. Some of the service industries, and in particular retail, are characterised by many new firms. However, they don't belong to the entrepreneurial model because most of the corresponding new firms are not based on any innovative idea.

Because of the radical character of the basic innovation that lays at the foundation of this pattern, one can say that none of the different innovation trajectories can be excluded from the entrepreneurial pattern.

**Figure 6 : The entrepreneurial pattern****3.5 The artisanal pattern**

This pattern describes small firms involved in operational services (cleaning, guard services, hotels, restaurants etc.). These firms do not have any innovation strategy. They do not have any R-D department nor information technology department.

Generally, these firms are not innovative, and if they are, the renewals are normally small, non-reproduced changes. The firms are generally conservative, not-change and trajectory oriented and therefore not oriented towards external trajectories. The external innovation drivers are the actors. If innovation is present, it is through improvement models and learning processes.

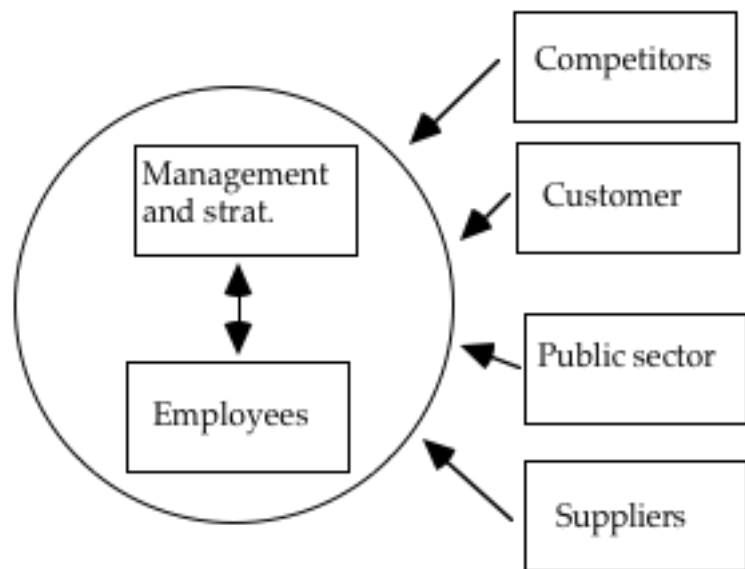
**Figure 7 : the artisanal pattern****3.6 The network pattern**

One pattern is a situation where a number of service firms have created a common network firm that has the purpose to innovate on behalf of the member firms or induce innovations in these. This pattern is found in tourism (Sundbo, 1997) and in certain financial groups (Gallouj et al., 1997). This is a situation where the service firms lay the innovation activity and the relation to actors and trajectories in the hands of a professional organisation for innovation outside the firms.

The network firm could in principle have an R&D department, but this is not reported in any empirical research. The whole set of innovation trajectories are involved in this pattern.

The network firm may be supposed not to be very customer or supplier oriented because it does not have the contact with these actors, who interact directly with the member firms. The clients are the member firms.



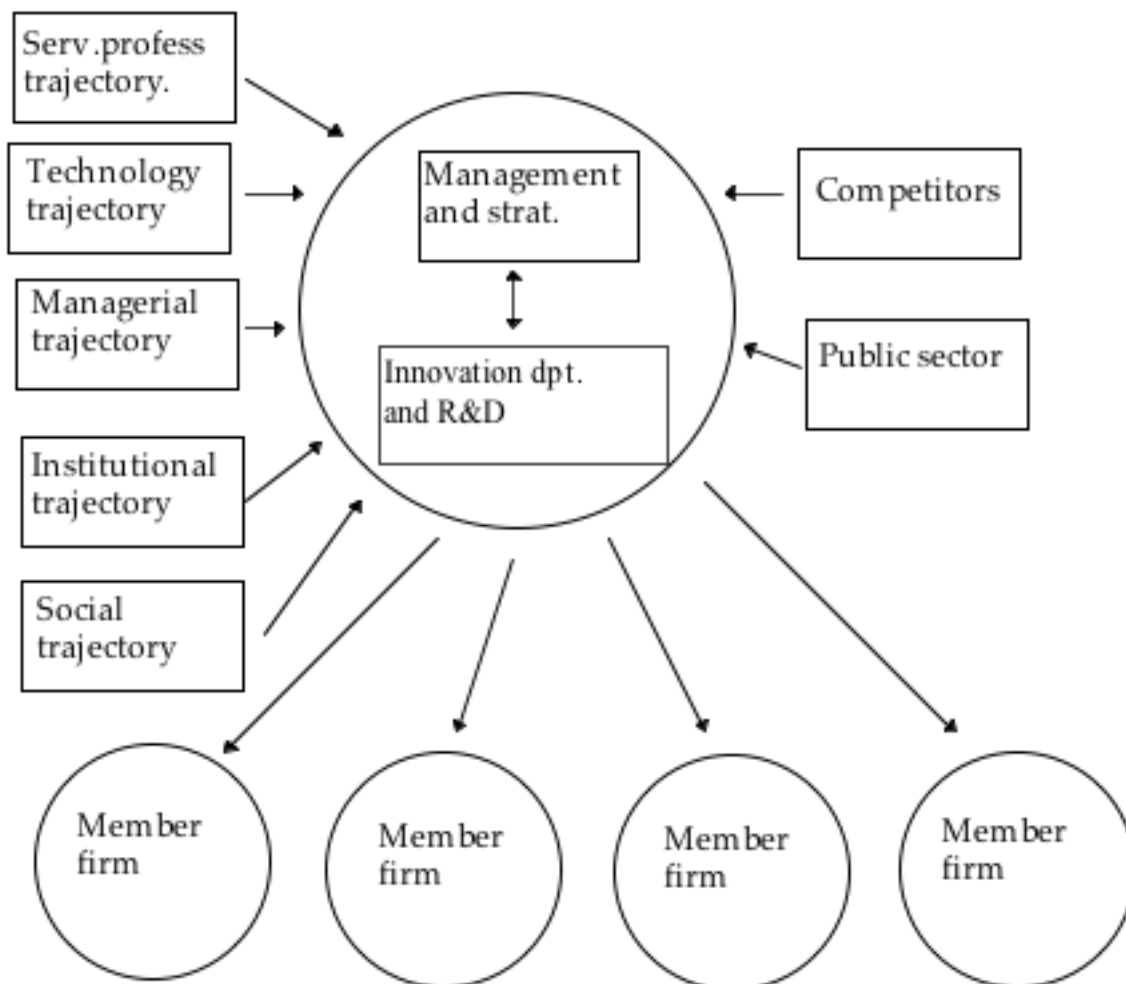

**Figure 8 :** the network pattern

#### 4. Innovation system and services

The existence of an innovation system requires, as we will see, the fulfilment of two conditions: one of coherence, the other of repetition. Before we can discuss whether an innovation system does exist in services, we have to define more precisely that concept.

##### 4.1 The notion of innovation systems

By innovation system we mean a general pattern that can describe the innovation activities in a sector, in this case the service sector. That a pattern exists means that certain elements are determining the innovations and the development of new ideas and innovations and their diffusion follows certain ways. If there is some repeated common characteristics of the pattern, we may call it a system.

An innovation system can be either institutional or loosely coupled.

An *institutional innovation system* is a coherent system with a series of relationships between different actors through which knowledge and ideas for innovations are diffused. The actors interact and through this system of interaction innovations are developed. It may also include a “snow ball” effect (one new idea leads to the generation of another in the system). One can follow the diffusion process because it follows certain patterns. The

system can be said to be institutionalised because the interrelationship between the actors often follows a certain pattern with long lasting relations and co-operations and often the relationship is formalised through contracts or well-known norms for co-operation. There are often fixed positions in the system and generally accepted norms for the relationships and interactions.

A *loosely coupled innovation system* is composed of certain actors, certain trajectories of development within important fields like technology, management etc. and some forms of behaviour that are common to the sector in case. The constellation between the actors, the trajectories and the behavioural forms is not very fixed, it may take various forms. It is not an institutionalised system in the way that there is no fixed norms for behaviour and relations that everybody in the sector know and follow. The firms co-operate less with external actors than supposed in the institutional innovation system, but they relate to the external actors, i.e. these actors are important providers of input or purchasers of the output from the innovation process or are competitors. The interaction may be as large, or even larger, than in the institutional system, it is just more competition oriented and not institutionalised. Further, the output purchasers mean more than the input providers in this system compared to the institutional system. The diffusion process does not follow a straight line, but is complex with many informal and often in-observable elements like intuitive idea generating of one person who's identity has been forgotten by everybody if you ask the actors some time later. The loosely coupled innovation system can not be theoretically understood from a coherent, explanatory model as the institutionalised system because of the loose coupling of all elements and non-fixed behavioural patterns and traditions. The actors, trajectories and major behavioural and interactional elements can nevertheless be described and some scientific rules or laws of the average behaviour and relationships formulated. Strategy is a social behaviour and the actors are social beings thus the innovation process and the interaction system follow sociological laws as do all other human groups.

The loosely coupled innovation system may be supposed to characterise a situation with hard market competition and weak common push elements such as a common scientific or technological basis of the production (a trajectory). This calls for more strategic game approach towards the market of the single firm and little co-operation with other actors outside the firm.

The institutionalised innovation system may be supposed to characterise a situation in which a sector has gone through a long history where the independently determined behavioural patterns of the single actors have been common and fixed, general norms have been established with a sanction system to ensure that all actors follow the institutionalised norms and rules. Although this may look like a description of an inefficient conservation system, that does not need to be the case. One can argue that an institution could be oriented towards change and creativity. However, there could be a tendency to a routinisation of the creativity thus changes follow certain paths or trajectories that can not be broken. Radical innovations might not appear in an institutionalised system.

#### **4.2 Are there evidence of the existence of an innovation system in services?**

Do the different patterns that we have described in section 3 constitute a system? To describe them as a system demands that two conditions could be fulfilled: 1. There is at least some coherence in these patterns. 2. There is some repetition in the patterns thus one or a few patterns are general.

The possible system could be institutionalised if the coherency is strong and there is only one pattern that is repeated very much. If there are several patterns and it cannot be

predicted which pattern will appear in which situations and if the coherence in the patterns is weak, it is a loosely coupled system.

Thus, we have three possibilities concerning the innovation system in service: A. There is an institutionalised system, B. There is a loosely coupled system, C. There is no system at all.

### **Lack of coherence**

The innovation activities are only coherent to a small degree in services and we would state as a hypothesis that it would be difficult to find a route of imitation where different actors have a mutual relation and the diffusion of new ideas and concrete innovations could be followed through several links. Even the trajectories are often not coherent systems, service firms are still not very scientific-professional based, so the service professional trajectory is often weak; innovations are still often quick, practical ideas.

The technology trajectory is also often weak if we discuss it as a coherent system that leads to a wave of innovations that generates each other. The innovation process and the introduction of new technology are still often unsystematic and are a result of firm internal trial-and-error decisions and not a consequence of any external system.

However, this is a matter of degree, the service professional and, to a less degree, the technology trajectories have been found to be the strongest patterns in services and those that has been most institutionalised. Further, these are general statements about the total service sector, there are differences between different service industries. Thus, a generalisation to all service industries might be doubtful, but the service industries have some common characteristics (that we have briefly emphasised in this article) thus it can be allowed to propose over-all models at the general level of this theoretical discussion. In empirical studies one must investigate the possible innovation systems that each industry or maybe firm is involved in.

The lack of coherence means to that we can find only a loosely coupled system of service innovation and even that may in some service fields be weak. The service innovation process as a societal activity could be characterised as an anarchic market based process. However, this is an exaggeration because more systematic relations already exist and there are developments towards formation of innovation systems that can already be observed as we shall demonstrate below.

### **Some repetition of a few patterns**

As argued above, there are several patterns of innovation in the service sector, and not only one. They are not always repeated in the same firm or industry, a new pattern may be selected for a new innovation. Service firms are only moderately aware of innovation as a means for developing the firm (to get a better competition position on the market, and to grow in turnover and profit). This means that they are not very clear about how they want to organise and manage their innovation activities. The form of organisation, which actors and/or trajectories they choose and how the relationship with actors should be, becomes often a coincidental decision, determined by the actual situation.

Nevertheless some patterns are more common than others. There is also a tendency for one pattern to become dominant in most types of services and firms. That is the case to the organised strategic innovation pattern and, within specific service areas, to the service professional and artisanal patterns, although the domination of these patterns is less clear. This means that there is at least some repetition of one, or maybe two or three, innovation patterns.

Our conclusion (i.e. our answer to the question does an innovation system exist in services) is that since there is some coherence and some repetitions in the innovations patterns and since a limited number of patterns are repeated and seem to characterise the main part of the innovation situations, we can say that there is a system.

Since there is only some coherence, some repetitions and there are several patterns, it is only a loosely coupled system.

The system is not much of a national system, which has been observed in manufacturing (Nelson, 1993; Porter, 1990). If it might be defined geographically - which is not sure, it is international and internationalisation forwards innovation.

## **Conclusion and perspectives**

We can conclude that there is a system of innovation in service, but it is a loosely coupled system and there is a variation of patterns within the system. The system is not a national system, and the varied and loosely coupled character of the system makes it difficult to use it as a basis for political regulation and stimulation.

Whether the service innovation system in the future will be more institutionalised, is difficult to say, but since it still will be much characterised by a large variety of relations between trajectories and actors and by many widespread interaction situations between actors, it is mostly likely that it will remain at least less institutionalised than we know from the manufacturing system. This may, however, not be a disadvantage to the service sector, on the contrary it may create a more dynamic innovation system that even manufacturing could learn from (and which it, according to our hypothesis stated below, will).

The service innovation system is different from the manufacturing innovation system as this has been discussed in literature, but one can assume that the service and manufacturing systems are converging and will converge more in the future. There is some empirical evidence for stating such a hypothesis.

In the current post-fordistic period manufacturing innovations get traits from the service innovation system: A heavy customer and market orientation, less standardised and more flexible products and production organisation and mainly dominated by incremental innovations. The employees may be supposed to get a more central role as corporate entrepreneurs even in manufacturing.

Service innovations is moving into the directions of the manufacturing system in some ways; it seems to become more systematic, more technology is involved, and the service innovations may be supposed to be more push determined through R&D, although the sciences on which the service innovations will be based, are more human and social social sciences than natural and technical sciences.

However, the service innovation system keeps some of its own elements: The customer encounter and (non-technologic) person-to-person contact as core driver; many small, non-reproduced changes; a relatively more loosely-coupled organisation system, characterised by less R&D, more corporate entrepreneurship, strategic guidance, and service professional trajectories.

Evolutionary economics which is particularly interested by interaction-intensive economic phenomenon is obviously at the heart of our analysis. It offers promising ideas to cope with innovation in services. Indeed there is for example a kind of proximity or similarity between the nature of the service and the way one could say that evolutionary economics defines innovation, or should define it. Both are a process, an act and not merely a result. Both are interactive and both have some difficulties to follow optimising principles. We will now

briefly discuss how the attempt to define and find an innovation system in services could contribute to develop evolutionary economic theory

The patterns described above (section 3) are a proposal for a model of the organised and complex innovation systems that follows after the breakdown of the entrepreneur model (a “Schumpeter I” model), but another proposal than the R&D system (the “Shumpeter II” model). The most dominant pattern in the service innovation system is the organised strategic pattern. It emphasises the dualism of the corporate entrepreneurship of the employees and the management who induces and controls the innovation process within the framework of the strategy. This model is within the theoretical framework of the strategic innovation theory (Sundbo, 1998), which points to this dual innovation organisation as the important and the firms strategy as the framework for the management’s decision and inducement.

This model might be more dynamic and more valid than the technological R&D model that has been discussed as the proposal for a Schumpeter II model. Further research will be necessary to show that.

The above structuring of a service innovation system can thus contribute to develop evolutionary theory in the way that it offers a version of the determining and structuring mechanisms in the innovation process and thus in the evolution of the production system and the economy. This version may include elements, and constellation of these, that have not until now been stressed in evolutionary theory. Compared to Pavitt’s general sectoral taxonomy (1984) or to Soete and Miozzo’s service innovation taxonomy (1990) our model does not focus on technological trajectories alone, but it also takes into account several other trajectories: service-professional, managerial, social, and institutional which may be deeply intertwined.

### References

- Barcet, A., Bonamy, J., and Mayère, A., (1987) *Modernisation et innovation dans les services aux entreprises (modernisation and innovation in business services)*, Report for Commissariat Général du Plan.
- Barras, R. (1990) Interactive Innovation in Financial and Business Services: The Vanguard of the Service Revolution, *Research Policy*, 19, 3:215-37.
- Barras, R. (1986) Towards a Theory of Innovation in Services, *Research Policy*, 15:161-173.
- Cohen, S. and Zysman, J. (1987) *Manufacturing Matters*, Basic Books, New York (1987).
- Dosi, G. (1982) Technological Paradigms and Technological Trajectories : A Suggested Interpretation of the Determinants and Directions of Technical Change, *Research Policy*, 11:147-162.
- Edvardsson, B., Haglund, L. and Mattsson, J. (1995) Analysis, planning, improvisation and control in the development of new services, *International Journal of Service Industry Management*, 6(2): 24-35.
- Edvardsson, B., Thomasson, B. and Ovretveit, J. (1994) *Quality of Service*, London.
- Gadrey, J. (1992) *L'économie des services (The service economy)*, La Découverte.
- Gadrey, J. (1994) La modernisation des services professionnels : rationalisation industrielle ou rationalisation professionnelle (The modernisation of professional services : industrial rationalisation or professional rationalisation), *Revue française de sociologie*, XXXV:163-195.
- Gadrey, J. and Gallouj, F. (1998) The provider-customer interface in business and professional services, *The Service Industries Journal*, Vol. 18, april:1-15.
- Gadrey J., Gallouj F. and Weinstein O. (1995) New modes of innovation : how services benefit industry, *International Journal of Service Industry Management*, volume 6(3): 4-

- 1.
- Gallouj, F. (1994) *Economie de l'innovation dans les services (Economics of innovation in services)*, Editions L'Harmattan, Logiques économiques, Paris.
- Gallouj, F. (1995) Le processus de production de l'innovation dans les services de conseil (the process of innovation in consultancy services), *Revue Française de Gestion* March, April, May.
- Gallouj, C. and Gallouj, F. (1996) *L'innovation dans les services (Innovation in services)*, Editions Economica, Paris.
- Gallouj, F. (1997) Towards a Neoschumpeterian Theory of innovation in Services, *Science and Public Policy*, 24(6):405-420, december.
- Gallouj, F. and Weinstein, O. (1997) Innovation in services, *Research Policy* 26:537-556.
- Gallouj, F., Djellal F., Gallouj C. (1997) *Vers une théorie de l'innovation dans les services, (Towards a theory of innovation in services)*, Report for Commissariat General du Plan, july.
- Illeris, S. (1996) *The service economy. A geographical approach*, Chichester.
- Kline, S. and Rosenberg, N. (1986) "An Overview of Innovation", In Landau, R. and Rosenberg, N. (eds), *The Positive Sum Strategy: Harnessing Technology for Economic Growth*, National Academic Press, Washington DC.
- Kubr, M. (1988) *Management Consulting : a Guide to the Profession*, ILO, Geneva.
- Martin, C.R. and Horne, D.A. (1995) Service innovation: successful versus unsuccessful firms, *International Journal of Service Industry Management*, 4(1):49-65.
- Miles, I. (1993) Services in the New Industrial Ecocony, *Futures* , 25: 653-72, July/August.
- Miles, I., Kastrinos, N., Flanagan, K., Bilderbek, R., den Hertog, P., Huntink, W. and Bouman, M. (1994) *Knowledge-Intensive Business Services: Their Role as Users, Carriers and Sources of Innovation*, PREST, University of Manchester.
- Nelson, R. (ed.) (1993) *National Innovation Systems*, Oxford.
- Normann, R. (1991) *Service Management*, London.
- Pavitt, K. (1984) Sectoral Patterns of Technical Change : Towards a Taxonomy and a Theory, *Research Policy*, 13..
- Porter, M. (1990) *The Competitive Advantage of Nations*, New York.
- Saviotti, P.P., and Metcalfe, J.S., (1984) A theoretical approach to the construction of technological output indicators, *Research Policy*, 13:141-151.
- Soete, L., and Miozzo, M. (1990) *Trade and Development in Services: a Technological Perspective*, MERIT, The Netherlands.
- Sundbo, J. (1992) The Tied Entrepreneur, *Creativity and Innovation Management*, 1(3):109-20.
- Sundbo, J. (1994) Modulization of service production and a thesis of convergence between service and manufacturing organizations, *Scandinavian Journal of Management*, 10, (3): 245-266.
- Sundbo, J. (1996) Balancing Empowerment, *Technovation*, 16 (8):397-409.
- Sundbo J. (1997) Management of Innovation in Services, *The Service Industries Journal*, 17(3): 432-55.
- Sundbo, J. (1998) *Innovation Theory: Three Paradigms*, Cheltenham Glous.
- Sundbo, J. and Gallouj, F. (1998) *Innovation in services*, The results of Work Package 3-4 of the SI4S project, july.
- Van Der Aa, W. and Elfring, T., (1993) *A typology of Innovations in Service Firms*, Conference on "Managing Innovations in Services", Cardiff Business School, 5-7 April.

**PAPER 6 :**

**INNOVATION IN SERVICES**

**(Paper published in Research Policy, Vol. 26, 1997, p. 82-97)**

**INNOVATION IN SERVICES**

**Faïz Gallouj**

**(Last-Clersé, University of Lille I and IFRESI-CNRS)**

**Olivier Weinstein**

**(Crei, University of Paris-Nord)**

**(Paper published in Research Policy, Vol. 26, 1997, p. 82-97)**

*Abstract:*

*The purpose of this article is to lay the foundations of a theory that can be used to interpret innovation processes in the service sector. The hypothesis underpinning this article is based on Lancaster's definition of the product (in both manufacturing and services) as a set of service characteristics. The article follows the example of those who have sought to apply Lancaster's work to technological phenomena. Various modes of innovation in the service sectors are highlighted and illustrated.*



## INNOVATION IN SERVICES

### 1. Introduction

The importance of innovation processes, widely recognised on both the empirical and theoretical levels, and the increasingly prominent role being played by service activities in productive systems have combined to make innovation in the service sector an issue of great importance. However, analysis of innovation in service industries is difficult from two standpoints. On the one hand, innovation theory has been developed essentially on the basis of analysis of *technological* innovation in *manufacturing* activities (which, incidentally, represents a diminution of the scope of Schumpeter's pioneering analyses). On the other hand, the specific properties of service activities, and particularly the analytically "fuzzy" nature of their output, make it particularly difficult to measure them by the traditional economic methods (productivity) and to detect improvement or change (on the qualitative level).

These two difficulties constitute the starting point for two complementary groups of studies on innovation in services (which can be only briefly outlined here)<sup>25</sup> :

— The first group focuses on analysis of the introduction of technical equipment and systems in service firms and industries. It includes a very large number of studies of the impact of technologies (particularly information technologies) on services, as well as attempts to construct taxonomies of technological trajectories specific to services [38]. Barras' work ([3], [4]) merits particular attention by virtue of its theoretical ambition. In certain services (banking, insurance, accounting, administration), Barras has observed a product life cycle that is the converse of the traditional industrial cycle. The basic element of this so-called "reverse product cycle" theory is the adoption of an item of computer equipment by a service activity that triggers what might be called a "natural technological trajectory". This leads, in the first instance, to the emergence of incremental process innovations, the purpose of which is to improve the efficiency of the service being provided, secondly to an improvement in service quality through more radical process innovations and finally, in the last phase of cycle, to the emergence of product innovations. Thus innovation is not viewed in isolation from the technological potentialities, and Barras' model is less a theory of innovation in services than a theory of the diffusion within the service sector of technological

---

<sup>25</sup> For a more detailed survey cf. F. Gallouj [25] and C. Gallouj and F. Gallouj [22].

innovations derived from manufacturing industry.

— The starting point for the second set of studies is the notion that innovation can exist where the "technologist" gaze perceives nothing. Without ignoring the technological dimension, these "service-oriented" approaches focus on non-technological forms of innovation ; in this respect, they are following the precedent set by Schumpeter, whose definition of innovation was particularly broad and open<sup>26</sup>. Consultancy services, for example, are an interesting area for empirical analysis of service-oriented innovation. In his study of consultancy firms, Gallouj [23] highlights in particular the existence of ad hoc forms of innovation that are not immediately reproducible and of institutional "formalisation" trajectories (i.e. the search for a certain degree of formalisation, though not necessarily, or even predominantly, in tangible form). The latter trajectory was also recently highlighted in the field of catering and related services by Callon [7] and Dubuisson [13]. The studies by Van der Aa and Elfring [43], Gadrey et al. [21] and Sundbo [39], [40] also take a broad, Schumpeterian view of innovation. According to Sundbo [39], [40] innovations in services do not follow a technological trajectory (in Dosi's sense [12]) but rather "service-professional trajectories" (e.g. a certain number of ideas on management, banking, etc.) in which technologies are only one vector among several others.

The purpose of this article is to lay the foundations of a theory that can be used to interpret innovation processes in the service sector. In order to achieve this objective, it did not seem to us appropriate to make an a priori distinction between innovation in service activities and innovation in manufacturing and to attempt to construct a specific "theory of innovation in services". Rather, it is our intention to investigate how taking the specificities of service activities as a starting point might lead to a reformulation of the analysis of innovation and a clear definition of the possible forms it might take. Such an approach, which seems to us both more realistic and more productive, is in line with the hypothesis of a convergence between manufacturing and services.

The construction of a general description of innovation is essential for an understanding of what the notion of innovation might encompass, in both services and manufacturing industry, and the basic forms it might take. The standard analysis of technological innovation tends to focus on the effects of innovation rather than on its actual content and characteristics. As a result, study of the various forms of innovation has centred on two lines of inquiry, with the first distinguishing product innovation from process innovation (to which might be added other forms, such as organisational

---

<sup>26</sup> Schumpeter identified several different forms of innovation: the introduction of a new good, the introduction of a new means of production, the discovery of a new source of raw material or semi-finished product, the conquest of a new market and the establishment of a new organisation.

innovation and the various types considered by Schumpeter) and the second contrasting major (or radical) innovations with secondary (or incremental) innovations. However important these aspects may be, it is essential to delve deeper into the "black box" of innovative processes in order to understand both their content and the forces that drive them. This can be achieved through a formalisation derived from Lancaster's work [32], in which a product is defined as a set of characteristics. The approach adopted in this article follows the example of those who have sought to apply Lancaster's approach to technological phenomena (Saviotti and Metcalfe [36], cf. also Saviotti [37]). It seems to us possible, with a certain number of changes, to extend the application of this formalisation to the analysis of innovation in the service sector, by taking due account of the intangible nature of the "product" and the interaction between agents that often characterise this type of activity.

The characteristics approach, which it is our intention to develop here, is integrative. Firstly, it encompasses both goods and services. Secondly, it applies both to technological innovation itself and to the non-technological forms of innovation. It can be seen as a way of clarifying and making more operational functional approaches<sup>27</sup> which have proved to be too general.

This article is divided into three sections. The first section is given over to an attempt to extend the Lancasterian representation of products and processes suggested by Saviotti and Metcalfe to services (§2). The various modes and models of innovation derived from this approach are then outlined and illustrated<sup>28</sup> as they apply to services (§3). The conclusion is given over to an examination of some of the theoretical implications of an approach to products and innovation based on charts of characteristics.

---

<sup>27</sup> Barcet, Bonamy and Mayère [2] adopt such an approach and categorise innovations according to whether they relate to function, specification or the production process. The first category encompasses the emergence of new, undifferentiated, abstract functions ; the second involves the concrete realisation and differentiation of the functional innovation, while the third corresponds to a cost-cutting trajectory (as a result of standardisation, the use of new technical instruments, etc.).

<sup>28</sup> The illustrations in this paper are drawn from two main sources: on the one hand, the economic and management literature and, on the other, an empirical study carried out by the authors in collaboration with Jean Gadrey, Thierry Ribault and Stéphane Lhuillery for the French Ministry of Higher Education and Research on the subject of R&D and innovation in services. In the course of the project, studies were conducted in the insurance and banking, consultancy and electronic information services industries. The article has also benefited from empirical and theoretical material derived from two other research projects carried out in collaboration with Faridah Djellal and Camal Gallouj, one for the Commissariat Général du Plan, the other for the European Commission.. In the course of these projects, investigations were carried out in other areas of the service sector, namely retailing, hotels and catering, transport and cleaning.

## 2. The search for a general formalisation of the product (good or service)

We shall begin here by outlining the way in which Saviotti and Metcalfe [36] and Saviotti [37], taking Lancaster's work as a starting point but, paradoxically, adopting an evolutionary perspective, advance the notion of modelling a product (i.e., from Saviotti and Metcalfe's point of view, a "material" artefact) as a means of measuring technical change. This notion is examined in the light of the principal defining characteristics of services and proposals drawn up for adapting it to service activities.

Nevertheless, an approach such as the one favoured here, which takes products as its starting point, does not mean that process innovations or technologies are ignored. As far as services are concerned, distinguishing between these two categories is more problematic than in the case of goods. The approach outlined here will have to take this into account.

### 2.1. *The product as a set of technical and service characteristics*

According to Saviotti and Metcalfe [36] the provision of any type of "product" can be described in terms of a set of characteristics that reflect, on the one hand, the internal structure of the product in question and, on the other, its external properties, i.e. the type of service being offered to users. Saviotti and Metcalfe divide these characteristics into three main types:

**(a)** *The final (or use) characteristics of the good or service (Y)* - Saviotti and Metcalfe speak of "*service characteristics*". These are the characteristics of the product seen from the point of view of the end user, e.g., in the case of a car, its size, performance, comfort, safety features, etc. (cf. Saviotti and Metcalfe [36]). In general terms, they constitute a definition of the services, of the utility being performed by a given good.

A hierarchy of service characteristics can be introduced by making a distinction between *main* characteristics, *complementary* characteristics and *externalities* (i.e. the undesired characteristics associated with the product - in the case of the motor car these would include pollution, noise, danger, etc.).

**(b)** *The "internal", technical characteristics of the good or service (X)* describe the internal characteristics of the technology i.e. the characteristics of the various technical mechanisms used to obtain the final characteristics. In the case of a manufacturing product, these characteristics are clearly defined. In a motor car, for

example, they would include the type of engine (internal combustion, petrol or diesel, electric engine...), transmission, suspension and so on.

(c) *Process characteristics (Z)*, finally, relate to the methods by which the good or service in question is produced, and the technologies and modes of organisation involved (the materials used, the ways in which they are processed, the forms of energy, the organisation of the process, etc.). Thus they include all the technologies (in the usual sense of the term) used in the design, production and marketing of products. In the case of the motor car, for example, the assembly line is a process characteristic. Although they are mentioned and defined by Saviotti and Metcalfe, these process characteristics are rapidly abandoned in their analysis<sup>29</sup>. Indeed, as far as goods are concerned, Saviotti et Metcalfe [36] take the view that "the separability of product and process technology is not complete but is a reasonable approximation in many situations". In fact, the notion of the product they adopt incorporates only technical and service characteristics.

## ***2.2 The specificities of services***

Some experts on services have made considerable efforts in recent years to stress that goods are also defined by the "services they provide" (Zarifian [45] ; Bressand and Nicolaïdis [6], etc.). However, while goods do indeed provide services, it should not be forgotten that services also provide services. Our hypothesis is that the absence of technical specifications (in the traditional sense) certainly makes the task more difficult, but does not make it impossible to extend and adapt Saviotti and Metcalfe's approach to services. Before embarking upon this task, let us remind ourselves briefly what the (relative) specificity of services consists of.

Once produced, a good usually acquires an autonomous physical existence. It has a high degree of exteriority relative to the individual who produced it and the person who is going to consume it<sup>30</sup> (the anonymity principle, as neo-classical theory has it). Generally speaking, a service is intangible and does not have the same exteriority. It is identical in substance with those who produce it and with those who consume it (it cannot, therefore, be held in stock). It seldom exists outside of them. It is not a given result, but an act or process. By developing the metaphor of the "service triangle", Gadrey [18], following on from Hill [30], has helped to bring into general use the definition of a service as a set of processing operations (...) carried out by a service

<sup>29</sup> They are completely absent from Saviotti's latest work on this subject [37].

<sup>30</sup> unless it is a good custom-made for someone and not readily transferable to anyone else (e.g. spectacles, machine tools, customised software etc.).

provider (B) on behalf of a client (A), in a medium (C) held by A, and intended to bring about a change of state in the medium C.

This definition conceals a certain number of analytical difficulties that will have to be taken into consideration in attempting to adapt Lancaster's approach to goods in order to use it for the analysis of services. Most of the difficulties outlined below are linked. Nevertheless, they are presented separately in order to facilitate the analysis and to allow certain slight differences to be pointed up.

### *2.2.1 The problems of product standardisation*

Since a product is not always perfectly "formatted" and codified, and in some cases the final characteristics are to a certain extent socially constructed during the actual process of providing the product, the vector of characteristics  $[Y_i]$  may not be precisely determined a priori. However, this also applies to certain custom-made tangible goods: spectacles, for example, are usually made to a set of highly personal specifications.

Each service transaction may give rise to a particular set of characteristics  $[Y_i]$  in situations where there is production on demand or a response to a specific, not standardisable problem (which may apply equally well to some manufacturing production). In these cases, it may seem difficult to say for certain whether or not innovation has taken place. If a simple definition of product innovation is retained (with innovation being said to occur as soon as there is a new product), it would be necessary to consider innovation to have taken place in all these cases, which seems to defy common sense; this would suggest that a "custom-made product" frequently requires little imagination or creativity. In order to resolve this dilemma, the focus of attention needs to shift upstream, towards the conditions under which the product is designed.

### *2.2.2 A product that manifests itself through its effects over time*

The "product" supplied by a service provider may manifest itself through the effects it produces over a longer or shorter period of time (although this is also true, to a certain extent of spectacles). In order to take account of this characteristic, Gadrey [18] proposes that a distinction should be made between :

- the direct or immediate "product" (the actual delivery of the service) : e.g. a consultation with a doctor or lawyer, a visit to a garage, etc.

- and the indirect "product" (the subsequent results, whether expected or not) : change in the state of health, legal position, working order of vehicle, etc.

### *2.2.3 The question of the service relationship*

One of the fundamental characteristics of service activities, particularly "knowledge-intensive" ones, is client participation (in various forms) in the production of the service. Various concepts have been developed in order to account for this client involvement. These concepts, which are sometimes used as synonyms, are summarised in Figure 1. In reality, they denote different aspects of the same phenomenon, and can be differentiated from each other by their theoretical substance.

Whatever term is used, (interface, interaction, co-production, "servuction", socially regulated service relationship, service relationship), this link between service provider and client is the most important element missing from the notion of the product put forward by Saviotti and Metcalfe, if it is to embrace services and, more generally, the rise in the real power (or at least awareness) of the service relationship in the economic system as a whole (including the manufacture of industrial goods).

### **Figure 1 : Various ways of expressing customer involvement in the provision of services**

### *2.2.4 The difficulty of distinguishing between product and process in services*

In the case of goods, the distinction between product and process, which is a useful analytical tool, though sometimes difficult to use, is widely accepted. The same is certainly not true of services. Here, the term "product" frequently denotes a process: a service package, a set of procedures and protocols, an "act". In reality, this use of the term depends on the concept of product tacitly accepted by the protagonists in question. If they understand the product to be analogous with the immediate act of providing a service, then it is more or less synonymous with it.

### *2.2.5 The correspondences between vectors of characteristics*

Even though they may be very complex, the correspondences between the technical characteristics [X] and service characteristics [Y] of goods are well known. They figure in the handbooks or user manuals that accompany manufactured products. They may be the subject of laboratory experiments. Even though they may not be evident to

the user, they are well known to experts. They constitute the very foundation of any attempt to repair a good, the aim being to detect failings in the service characteristics of the good and to trace right back along the correspondence between technical and service characteristics until the faulty technical system is identified.

In the case of services, and particularly those in which the intangible and relational aspects are important, the correspondences between the competences brought to bear by the service provider and the "product" certainly exist (one simply has to compare the effect on [X] of a competent service provider with that of an incompetent provider), but they are generally much hazier and much more difficult to codify : they are to a large extent tacit and subject to the difficulties caused by informational asymmetry. For these reasons (and others), it is not always possible to restore a service that has been provided to its proper or former state. In some cases, however, it is possible. Indeed, if the service provided can be regarded as a maintenance or repair service (in Goffman's sense), then it may be that an inadequate service can be "repaired" by a second intervention (e.g. by the mechanic to whom one entrusts one's car).

### ***2.3 Services as a set of characteristics: an extended notion***

In order to take account of the specific characteristics of services, we intend to adopt two different approaches. One involves an attempt to transpose to services the concepts developed solely for analysis of goods, while the other seeks to add new elements to the theoretical framework.

#### *2.3.1 Extending the notion of service characteristics to services*

As we have already noted, extending the notion of service characteristics to services does not pose any conceptual problems. Just like goods, services provide services (or service characteristics). The difficulty lies in the designation and evaluation of these characteristics. While we undoubtedly have to accept that the extended notion should be implemented more flexibly (by distinguishing between various scenarios, or by dealing individually with particular categories of services), it nevertheless remains a very productive heuristic tool, as we shall see.

This can be readily applied to services as well, whether it be an insurance product, a consultancy service, a database or information services in general. The characteristics of a database service, for example, will include features relating to the quantitative



and qualitative content of the supply of information, the mode of access to the information and the conditions and quality of that access. The characteristics of an automated telling machine service in a bank will reflect in particular the various uses to which it can be put (deposits, withdrawals, balance enquiries, ordering cheque books, etc.) and the ease with which it can be used ("user-friendliness"). In the case of monetary and financial instruments, Tobin<sup>31</sup>, for example, suggests that the main characteristics of a service constitute a finite set in which liquidity, divisibility, reversibility/substitutability, yield, income, predictable final value, ease of exchange, risk, etc. feature prominently. In more general terms, it can be said that a significant proportion of financial services innovation theory has been based on the final characteristics of the product or service (cf. Greenbaum and Haywood [26], Hardouin [27], Desai and Low [10]). The service characteristics of consultancy activities are more difficult to define. While they might appear at first sight to be consistent with the principal objectives contained in the schedule of conditions, in reality there is often a discrepancy between these characteristics and those finally obtained, which has to be considered a major feature of certain types of services and one inherent in the nature of the "products" on offer.

### 2.3.2 *Technical characteristics, process characteristics*

The technical characteristics of goods are those *internal* characteristics of tangible systems that *directly* provide a service. In the case of services, they are both 1) the *tangible* technical characteristics (particularly of information technologies, but also of logistical technologies, chemical products, e.g. in cleaning services, etc.) used to produce the service characteristics, and 2) what we shall call the *intangible* technical characteristics : legal or financial expertise, mathematical instruments (economic and financial modelling, operational research methods), consultants' methods or the (adaptable) standard contracts used by legal advisers, for example.

The technical characteristics of services (with the exception, to some extent, of transactions that make use of self-service equipment, such as ATMs in banks) cannot claim the *interiority* that is a feature of those of tangible systems. One of the major features of service activities is undoubtedly the fact that the "technologies" involved usually take the form of knowledge and skills embodied in individuals (or teams) and implemented directly when each transaction occurs, rather than in physical plant or equipment. Section 2.3.3 below is given over to the question of the distinction

---

<sup>31</sup> Unpublished manuscript on monetary theory, Chapter II, "Properties of Assets", cited in Greenbaum and Haywood [26].

between competences and intangible technical characteristics. Similarly, it is difficult to separate technical characteristics from process characteristics. Nevertheless, there is no question of excluding them from the conceptual framework, as Saviotti [37] decided to do. It is possible to envisage two different ways of getting round the problem of distinguishing between technical and process characteristics :

1) the view can be taken that, in services, they are one and the same thing, in other words that the processes in all their tangible and intangible forms are, as it were, (partial) replacements for internal technical specifications. This amounts to an assumption that, while the distinction between product and process can be considered a reasonable approximation in the case of goods, as Saviotti and Metcalfe suggest, this is not true of services.

2) the reference to the interface can be used as an instrument of discrimination. Thus the technical characteristics will be those of the (tangible and intangible) front-office technologies (i.e. that part of the organisation in direct contact with customers) and the (tangible and intangible) back-office technologies will be described as process characteristics. This solution seems to us more satisfactory than the first one, for several reasons. Firstly, of course, it goes beyond a mere acknowledgement of impotence. Secondly, and more importantly, its discriminatory power is based on the notion of service relationship which, as we have already stated, is of fundamental importance to our approach. It is the proximity of the technology in question to the customer that is the basis for the distinction between technical characteristic and process characteristic. These interface or front-office technologies, mobilised by the service provider, by the client or, more generally, by both at the same time, supply certain service characteristics directly to the customer, and in that respect have something in common with the internal technical specifications of goods. Home banking is undoubtedly the archetypal example of this scenario, in which all the customer has to do is “press a few buttons” in order to obtain the service he or she requires. ATMs, an insurance salesman’s computerised simulator, self-service franking machines and the various methods used by consultants are other examples. On the other hand, the mainframe servicing an insurance company or bank or postal sorting systems fall more within the sphere of process characteristics. Despite its pertinence, this solution does not resolve all the difficulties in practice, and particularly not those located on the boundary between front and back office, especially in the current situation in which some service firms are trying to eliminate that boundary altogether.

For the sake of convenience, however, we shall adopt the first solution in the rest of this paper. Whatever approach is adopted, processes lie at the heart of product analysis. As we shall see, this finding is of the utmost importance for the study of innovation (in services).

To summarise, what is termed here a technical characteristic (denoted as [X] or [X-Z]) differs in content from the term used by Saviotti and Metcalfe. It embraces tangible front-office technical characteristics (which are fairly close to technical characteristics in Saviotti and Metcalfe's sense), tangible back-office technical characteristics (which are fairly close to Saviotti and Metcalfe's process characteristics), intangible back-office or front-office technical characteristics (which do not exist in Saviotti and Metcalfe's framework) and possibly, organisational and spatial characteristics.

### 2.3.3 Adding in the competences mobilised (by the service provider)

For goods as for services, technical characteristics are knowledge, *competences* embodied in tangible (or intangible) systems. However, the provision of a service (i.e. of service characteristics) is generally the result of a combination of the following two mechanisms: the utilisation of (tangible or intangible) technical characteristics that are themselves based on competences, and the *direct* mobilisation of competences (i.e. without any technological mediation). We propose adding to Saviotti and Metcalfe's framework all the competences [C] mobilised by the service provider (cf. Figure 2).

A product (good or service) is therefore represented by a set of final (or service) characteristics ( $Y_i$ ). Each  $Y_i$  indicates the "level" of a characteristic  $i$ . These final characteristics are obtained by a certain combination of technical characteristics ( $X_j$ ), with each  $Y_i$  being obtained by a certain subset of the  $X_j$ . Similarly, each technical characteristic mobilises the competences  $C_k$  (certain competences may involve the ability to combine different technologies); in certain situations, those same competences may be mobilised directly.

**Figure 2: a representation of a product or service as a system of characteristics and competences** Source: based on Saviotti and Metcalfe [36]

The specific characteristic of service activities (or of some of them at least) is that the provision of the service may take place without a good or set of goods (material artefact) being supplied, or at least it cannot be reduced solely to the provision of a good or goods. Knowledge and competences may be mobilised in order to obtain a

certain set of final characteristics, which leads to the model in Figure 2 being replaced by that in Figure 3. Figure 3 constitutes a particular case of Figure 2, and depicts the ideal-type configuration of a “pure”, “intangible” service (whether it be an intellectual service, such as consultancy, or a manual one, such as some aspects of cleaning that merely involve emptying waste-paper baskets or even remedial massage, when the masseur uses only his hands). In this type of configuration, the ability to provide a service  $[Y_i]$ , and the quality of that service, depend crucially on the ability to implement and organise the various competences required, which is why, in certain services<sup>32</sup>, the design of organisational systems, and innovation in that area, is extremely important. The strategic importance of the vector  $[C_k]$  in the case of “knowledge-based” services is obvious, since it is the greater ability to mobilise competences that is the main argument in favour of using the external service provider.

### Figure 3 : The case of a "pure", "intangible" service

The "vector"  $[C]$  of competences mobilised in the provision of a service relates only to *individual* competences or to a clearly delimited group, i.e. the team involved in providing the service in question. It does not include *organisational* competences, which fall within the scope of intangible technical characteristics  $[X]$ .

These competences  $[C]$  are derived from various sources: initial education, continuing training, experience and, more generally, interaction. They can be codified, that is they can be reduced to messages that can be diffused at zero cost (Foray [17]), but in many cases, and particularly in services they are also tacit, i.e. not easily transferable and indissociable from the individual. Whether codified or tacit, these competences can be roughly classified into several types : scientific and technical competences (cognitive competences); internal and external relational competences (depending on whether the relations in question are those within the team or those with the customer or other players in the provision of the service), combinatory<sup>33</sup> or creative competences (i.e. those that combine technical characteristics into coherent sets and subsets) and operational (or manual) competences.

As we have already stressed, it is important to distinguish the vector of competences from that of intangible technical characteristics. Intangible technical characteristics  $[X]$  are (systems of) codified and formalised competences. They are used by the

<sup>32</sup> Those described in a recent book by Jacques de Bandt [8] as "informational services".

<sup>33</sup> What Henderson and Clark [28] call architectural competences.

individual (or group), and thus require the mobilisation of individual competences [C], but are independent of them. They exist independently of individuals and constitute the various elements that make up organisational memory.

In the terminology adopted by Nelson and Winter [35], and in evolutionary theory, competences [C] are the equivalent of "skills" and intangible technical characteristics [X] equate to a certain extent to "routines", or at least to the more codified of these routines.

In the case of recruitment consultancy, for example, knowledge of psychology, knowledge of the firm, know-who, etc. are all components of the vector of competences [C], whereas job analysis methods, selection tests, candidates' or clients' files etc. are intangible technical characteristics, the organisational routines that ensure the survival of the consultancy company independently of the individual consultants (who may leave at some time in the future).

In a static model, competences and intangible technical characteristics are linked by a relationship already alluded to above, namely the mobilisation of competences in order to bring technical characteristics into play.

In a dynamic model (and we shall return to this point when discussing models of innovation), another relationship emerges, one that equates to the change of state in certain C or combinations of C. These competences undergo a socialised process of codification, through which they come to form the organisation's "cognitive maps" (Argyris and Schön [1]); this formalisation shifts them away from the level of individual competence towards that of organisational competence. In this way, they become intangible techniques of which all members of the organisation can avail themselves.

#### *2.3.4 Adding customer competences in order to take account of the service relationship*

The customer is absent from both Figure 2 and Figure 3. However, as has already been noted, the customer's participation, in one way or another, in the production of a service (co-production, service relationship) is one of the major characteristics of service provision (and is increasingly shared with the production of certain goods).

Thus we propose to introduce into our diagrammatic representation a distinction

between two types of competence: those of the service provider (column vector  $[C_k]$ ) and those of the client (linear vector  $[C'_k]$ ). The co-production relationship, therefore, is represented by the combination of the terms of the two vectors (figure 4). Thus demand theory is present not only on the side of the service characteristics (in accordance with Lancaster's analysis) but also on the side of the customer competences mobilised through the service relationship.

There are several reasons for taking account of this client/provider interface. Firstly, it may itself be the subject of innovations (organisational changes, interface management methods, etc.); secondly, it is the "laboratory" where a form of innovation often neglected in economic analysis, ad hoc innovation (cf. § 3.4), is initiated; finally, the quality of the client firm's competences ( $C'_1 C'_2 \dots C'_k$ ) is one criterion for the success of innovations and technology transfer (in the broadest sense). In this respect, it may be useful to make a distinction within the vector  $[C'_k]$  between the technological competences of the client firm (i.e. the areas of knowledge in which it has expertise) and its capacity to absorb and assimilate new competences. This also applies to certain services to households (health, training). The management of this interface, i.e. of the combination or conjunction of  $[C'_k]$  and  $[C_k]$ , may offer a solution to the awkward question of protecting innovation in services. A service provider may in fact be able to develop highly complementary combinations of  $[C'_k]$  and  $[C_k]$  that encourage a form of dependency known as "customer lock-in", which is relatively common in the computer services field.

**Figure 4 : The case of a "pure" service (including the co-production relationship)**

*2.3.5 The most general representation*

The most general and most significant representation is the one shown in Figure 5. Provision of a service requires both the direct implementation of knowledge and competences (embodied in individual members not only of the provider firm but also of the client company) and the mobilisation of "technical" factors (the  $X_j$ ). These factors consist of knowledge that is codified and formalised in such a way that they can be used repeatedly for the provision of similar services or of services of different kinds (depending on whether they are more or less generic or specific). They may be tangible (computer or telecommunications systems) or intangible (modelling methods, legal expertise, etc.). They may be already in existence (use of widely diffused techniques) or be designed or adapted for a specific "product". Finally, it should be noted that the system  $\{[C'_k], [X_j], [Y_i]\}$  through which the consumer makes direct use

of his knowledge and competences represents in particular the various ways in which the client himself is "put to work" within the service firm: self-service situations (super/hypermarkets, fast-food restaurants, self-service banking, etc.), hiring of various equipment (such as vehicles, for example).

### **Figure 5 : The general form**

### **3. Modes and models of innovation**

If the representation of the product (good or service) outlined above is accepted, innovation can be defined as any change affecting one or more terms of one or more vectors of characteristics (of whatever kind - technical, service or competence).

These changes are brought about by a range of basic mechanisms: evolution or variation, disappearance, appearance, association, dissociation. They may be "programmed", i.e. intentional, the product of R & D, design and innovation activity, or "emergent", i.e. the fruit of natural learning mechanisms.

The representation of the "product" put forward here has the advantage, as we have already noted, of not excluding processes (and thus analysis of process innovation process). Nevertheless, the models of innovation outlined here are not articulated around the problematic dichotomy of product and process innovation. The representation adopted here has a further advantage: it breaks with the distinction between radical and non-radical innovations by introducing different modes of product improvement (learning, or the addition of characteristics).

#### **3.1 Radical innovation**

The term "radical innovation" denotes the creation of a totally new product, i.e. one defined in terms of characteristics unconnected with those of an old product. The entire system  $\{[C'], [C], [X], [Y]\}$  is transformed or, more precisely, *a new system  $\{[C'^*], [C^*], [X^*], [Y^*]\}$  is created*. The final and technical characteristics of the new product,  $[X^*], [Y^*]$ , have no elements in common with the characteristics  $[X]$  and  $[Y]$  of an old product, while the set of competences  $[C^*]$  contains new elements that did not exist in the sets  $[C]$  associated with any old products. The customer's competences  $[C']$ , it should be noted, are also renewed, since the more radical the innovation is, the more necessary it is to teach the client to adopt and use it. This is a mode of innovation that Tushman and Anderson [42] describe as "competence destroying".

This definition is the narrowest and most exacting. In many cases, the term “radical innovation” is also applied to those innovations that replace all the {C', C, X}, i.e. the "internal structure" or its equivalent, even if it leaves the Y (the service characteristics) unchanged (to a certain extent), at least in absolute terms (it is rare for the "levels" not to change at all). The transition from horse-drawn carriages to motor vehicles was a radical innovation, even though to a certain extent the service characteristics remained the same, i.e. individuals were still transported with certain degrees of comfort, safety and speed...

The design and marketing by insurance companies of care and assistance products (e.g. Europ Assistance) may, for example, be seen as a radical innovation that has changed the entire system. Companies offering these products are no longer selling life insurance, savings or damage insurance products but are actually providing services. The technologies used are different (alarm, monitoring, communications and transport systems, social networks, specific commercial networks), and the service characteristics are different : it is no longer a case of making a money payment when a specified event has taken place, but rather of providing a more or less complex service (housing, health care, transport, etc.). The vector of competences is also, of course, modified as a result.

In insurance itself, radical innovations would be, for example, policies offering cover for totally new risks: the emergence of new vehicles requiring insurance (electric vehicles), the identification or, more precisely, the social construction of new events to be insured against (therapeutic risk).

In the sphere of legal consultancy, a radical innovation would be, for example, the identification of and entry into a new area of expertise (by various means, including the accumulation and exploitation of expertise and the perfection of new methods). Examples might include, in their time, patent law and the law on IT, space, environmental protection etc.

The cleaning industry has also seen a radical innovation, described as “computer cleaning”; the term denotes not the use of IT in the provision of cleaning services, but rather the cleaning of computer systems. This new service, which constitutes an entry into an unusual area of activity for cleaning companies (strategic materials), has required a multiplicity of changes that amount to the development of a new set of characteristics and competences: recruitment and training of technicians (professionals



of a good level, with adequate communication skills), changes in working hours (the service is provided inside of office hours) and the development by the company's technical department not only of a trolley suited to this kind of cleaning service but also of special chemicals, techniques for spraying air and sucking up dust, cleaning methods, etc.

### 3.2 "*Improvement Innovation*"

The exact definition of such innovation is not actually self-evident, since an "improvement" to a product or procedure may take a wide range of different forms that vary greatly in scope. According to the strictest definition, this type of innovation consists simply of improving certain characteristics, without any change to the structure of the system; the value of certain  $Y_i$  is increased either directly, by improving certain  $C_p$ , or by improving certain  $X_j$ . Certain qualities of the product or process are improved, without any change to its characteristics. This is a "competence enhancing" form of innovation, to use Tushman and Henderson's term [42], which is a result more of the learning effects that normally accompany any activity than of innovation in the strict sense of the term ("joint product learning process", in the words of D. Foray [16]). Nevertheless, this type of innovation cannot be ignored : the extent and cumulative nature of its effect on overall productivity are widely recognised.

In our view the studies of Desai and Low [10], which are well known in financial economics, offer an illustration of this model of improvement (although learning phenomena play no role in them). These authors are concerned with financial assets and define them in terms of two characteristics, namely access (liquidity) (A) and return (yield) (R). The diagram thus constituted (Figure 6) makes it possible to locate and describe existing assets:

#### **Figure 6 : Representation of financial products in a diagram of characteristics**

Source: After Desai and Low [10]

Since reference assets A and B are characterised by a low return and high liquidity and a higher return and low liquidity respectively, Desai and Low consider the development of asset C as a "*trivial innovation*", since the distance between A and C in terms of characteristics, as measured by the angle (OA, OC), is small. On the other hand, asset D is an "*important innovation*", since it fills an "empty space" between the two reference assets.

### ***3.3 Incremental innovation (innovation by substitution or addition of characteristics)***

The general structure of the system {[C'], [C], [X], [Y]} remains the same, but the system is changed marginally through the addition of new elements to [X] and/or [Y] or through the substitution of elements (Figure 7). This may involve, for example, the addition of one or two new characteristics to a certain type of product, either by directly mobilising certain competences or by adding new technical characteristics. It may also involve the improvement of certain final characteristics (increasing certain  $Y_j$ ), or a reduction in production costs by adding or changing certain technical characteristics  $X_j$ . Thus it can be seen that innovations based on improvements, whose great importance in practice is widely recognised, can take a variety of forms, and may or *may not* be based on technical advances in the usual sense of the term. It is certainly difficult clearly to define the boundary between incremental innovation and "improvement" innovation, i.e. to distinguish the moment at which a new characteristic is added (e.g. the addition of a guarantee to meet deadlines) from the one at which a simple improvement is made (reduction in deadlines or delivery times). It is often the desire to formalise the improvement as a new *specification* that makes the difference: the transition from improvement mode to incremental mode can therefore be interpreted as a social construction.

In the insurance industry (cf. Gadrey, Gallouj, [20]), incremental innovations are commonplace. The basic form of the contract remains unchanged, but certain specifications or options can be added or taken away. Thus there are always opportunities to introduce new guarantees, to diversify the product by grafting a range of options on to the same stem.

Comparable examples can be found in the cleaning industry, where optional service characteristics can be added on to or taken away from the basic service (frequency of vacuum cleaning, washing office floors or simply dusting) (Sundbo, [41]). As the firm evolves, new service characteristics (or modules) are added to the basic service.

Checkout packing services in supermarkets and the introduction by car-hire companies of computer-aided route selection services can be regarded as incremental innovations. There are plentiful examples of this type in the hotel and air transport industries, among others.

**Figure 7 : S2: incremental innovation through the addition of characteristics (Y5) ; S3: incremental innovation through substitution of characteristics (substitution of Y5 for Y4)**

Staying with improvement and incremental innovation categories, the argument can be advanced even further, firstly by introducing the distinction already noted above between improvements to or the addition of main or complementary characteristics.

### ***3.4 Ad hoc innovation***

Ad hoc innovation can be defined in general terms as the interactive (social) construction of a solution to a particular problem posed by a given client. It is a very important form of innovation in consultancy services<sup>34</sup>, where the available knowledge and experience accumulated over time are harnessed and put to work synergistically in order to create fresh solutions and new knowledge that changes the client's situation in a positive and original way. Mention can be made, by way of example, of the many new legal arrangements that can be accommodated in the gaps in the system, or the development by various categories of consultants of especially novel strategies that give their customers a certain competitive advantage.

It is at the client/provider interface that this form of innovation is mainly produced. In fact, ad hoc innovations are often produced jointly by the service provider and the client. They usually appear during the normal process of delivering the service and are frequently not recognised as innovations until after the service has been provided. Thus they are a form of "non-programmed" innovation (Zaltman et al. [44]) that might be described as "emergent" (in the sense that they arise out of the unpredictable rearrangement of existing knowledge and experience).

The service characteristics  $[Y_i]$  (output) of an ad hoc innovation can be seen as an original solution, or a set of original solutions, of an organisational, strategic, legal, fiscal, social or human nature that emerges in response to a (partially new) problem. From the point of view of the service provider, an ad hoc innovation helps to produce new knowledge and competences that have to be codified and formalised in order that they might be re-used in different circumstances. There is thus a significant change in the vector of competences  $[C_k]$ , and particularly in the intangible elements of the technical characteristics  $[X_j]$ . This a posteriori codification and formalisation of

---

<sup>34</sup> The following observations on ad hoc innovation relate largely to this area of activity. However, the same applies to most "informational services", as defined by De Bandt [8], and to other services involving a high level of interaction between provider and client.

certain elements of a given solution in order that it may be partially and indirectly reproduced is what distinguishes ad hoc innovation from the ad hoc nature of many service transactions. The difference between ad hoc innovation and the kind of change inherent in many service transactions is that the former constitutes a permanent, non-random change of state produced by the codification of accumulated experience and, in many cases, an expansion of the firm's organisational memory. This clearly distinguishes it from random changes in the configuration of the service (caused by changes in the external environment, in customers etc.).

Ad hoc innovation is closely linked to cumulative learning processes. It is the product of a non-optimising procedural rationality (innovation takes place, but is not reproducible in the traditional sense of the term). It triggers a process of knowledge codification, i.e. the production of routines (search routine or dynamic routine).

As a product of the client/provider interface, ad hoc innovation, particularly in consultancy activities, depends on the nature of that interface and the various elements that go to make it up.

Thus interfaces of the "sparring" type (co-production) are more conducive than those of the "jobbing" type (subcontracting) (Gadrey et al. [19]) to the creation and success of this form of innovation, since they enable the innovation to be better understood and accepted (legitimated). Moreover, problems of a strategic nature, which are potential sources of innovation, are usually tackled in interfaces of the "sparring" type: they are seldom subcontracted. It should not be concluded from this, however, that only "creative problems" (to use Kubr's terminology [31]), where the aim is to create a totally new situation, can lead to the emergence of ad hoc innovations. "Corrective problems", in which the consultant's role is more curative, and "progressive problems", in which the consultant is expected to improve a given situation that it is feared might deteriorate, can also do so. And the opportunities for ad hoc innovations seem to increase with the size of the provider organisation and that of their clients, i.e. as the range of possible interfaces increases both qualitatively and quantitatively. Finally, the actual emergence of an ad hoc innovation depends also on the quality of the professionals in the client organisation involved in the interface (vector [C'k]).

In particular, the existence of this interface helps to limit the reproducibility of an ad hoc innovation in its original form. However, the knowledge, the experience (whether codifiable or not) and the unformulated, idiosyncratic techniques that emerge from

practical experience and the methods used to produce and transfer them can be reproduced. Ad hoc innovations are profitable, even if they are not reproducible, since they are based on an informational and cognitive input that can be transferred in part to other ad hoc situations.

What is generally known as **customised innovation** can be included in both incremental and ad hoc modes of innovation. In the case of the insurance industry, for example, (Gadrey and Gallouj [27]) "*adapted customised*" innovations, in which a standard contract is tailored to suit a particular client (or often a whole market segment) by changing the rates or introducing certain additional clauses, could be included in incremental category. On the other hand, "*fully customised*" innovations, in which a genuinely new contract is drawn up for a specific client (often a large company), and "*cover for special risks*", in which insurance is provided against a risk that might affect very small populations (for which no statistics are available) would be included in the ad hoc category, since the ad hoc element is much more significant.

### ***3.5 Recombinative innovation***

Another and major mode of innovation frequent in services but also in microelectronics and biotechnologies is what might be called recombinative (cf. Foray [15]<sup>35</sup>) or architectural innovation (Henderson and Clark [28]), a notion that means much the same. Innovation of this kind exploits the possibilities opened up by new combinations of various final and technical characteristics, derived from an established stock of knowledge and a given technological base or existing within a defined technological trajectory. Taking as its starting point the final and technical characteristics of an existing family of products and technologies, it forms the basis for a relatively routine method of producing innovation through the systematic re-utilisation of certain "elements" or "components". This does not mean that the creation of a new product through a new combination of characteristics does not require specific competences, considerable development work and a not insignificant amount of creativity. Innovation based on the addition of characteristics can be considered as a form of recombinative innovation, particularly when the characteristics added have their origins in pre-existing products.

---

<sup>35</sup> As early as 1912, in fact, Schumpeter defined innovation as a new combination of existing knowledge: "To produce other things or the same things by a different methods means to combine these materials and forces differently ... Development in our sense is then defined by the carrying out of new combinations" (Schumpeter [1934], p. 65-66, *The Theory of Economic Development*, Cambridge MA Harvard University Press (first edition 1912))

There are two other possible forms<sup>36</sup> which, in the field of services, have been particularly highlighted by Bressand and Nicolaïdis [6]. The first involves the creation of a new product by combining the characteristics of two or more existing products (Figure 8), while the second involves the creation of new products by splitting up an existing product, separating out various characteristics and turning certain elements into autonomous products (Figure 9).

This twin notion of bundling and unbundling is deliberately oversimplified: the new system is regarded simply as the sum of the two old ones or as the product of fragmentation. In reality, recombination and fragmentation techniques should also be brought into play (together with the corresponding technical characteristics) (cf. Bressand et Nicolaïdis [6]). According to Henderson et Clark, architectural innovations "destroy the utility of a firm's architectural knowledge, but preserve the utility of its knowledge of the product's individual components". Thus, as Bressand and Nicolaïdis emphasise, the processes of bundling and unbundling should not be reduced to a simple engineering exercise, involving the mere assembly of spare parts.

There are numerous illustrations of this model. Broadly speaking, a recruitment service provides the service characteristics inherent in four types of sequential activities: the analysis of the client organisation's needs, the choice of a method of approach (direct, through advertisements, etc.), the selection of candidates, their monitoring and the assistance in integrating them into the firm. In accordance with the principle of architectural innovation, consultancy companies have split up this generic service in such a way as to provide perhaps only that set of service characteristics specific to one or more phases of the combination outlined above. Recombinative innovation can go further by creating a totally new product through a combination of existing technical characteristics and elements, since the mere fact of combining certain characteristics in different ways or adding certain others might be sufficient to make possible totally new modes of use<sup>37</sup>. It should also be pointed out that recombinative innovation may also manifest itself through the implementation of a new technology, such as the use of a new medium (e.g. CD-ROM) in order to provide an information service.

According to Bressand and Nicolaïdis [6], charter air services emerged from this process of fragmenting or splitting up an air travel service made up of a combination

---

<sup>36</sup> However, a distinction should be made between combinations of characteristics and combinations of modules (which is one of the technical forms in which architectural innovation commonly manifests itself).

<sup>37</sup> This is the basis of "multimedia" systems.

of different elements: the travel itself, baggage handling, catering and reservations. The emergence of fast-food restaurants, brokerage and publishing (proliferation of photocopying companies) can be interpreted in the same way.

Conversely, examples of innovation based on the recombination of existing elements are provided by the recovery services originally conceived by Europe Assistance (thus the recombination model can lead to radical innovations, as defined above). The concept of "club" as devised by Club Med or the "fitness centres" invented by Viatrop are further examples. Moreover, transport services can be combined in the same package with a hotel reservation service, car hire etc., leading ultimately to a comprehensive tourist service. Similarly, "teleshopping" and mail order services combine retailing, transport and informational services. The French firm J.C. Decaux combines various activities that previously existed independently : the manufacture of bus shelters, cleaning and maintenance services for them, advertising services, information services, city maps etc.

**Figure 8 : A new service (S3) produced by recombining the characteristics of two existing services (S1 and S2)**

**Figure 9 : Two autonomous new services (S2 and S3) produced by splitting up the characteristics of an existing service (S1)<sup>38</sup>**

Recombinative innovation has now become *a fundamental mode of creating innovations*. As innovations become increasingly "systemic", some authors have suggested that it constitutes a new model of innovation (Foray [15]) that operates particularly in the informational and biotechnology industries. As we shall see, it also lies at the heart of the innovation and R & D mechanisms in services. It should be added that this form can be considered a normal form of innovation: when a problem arises, the first step, naturally, is to seek to solve it by using knowledge, methods and techniques already available and assimilated or known to be readily obtainable. In other respects, recombinative innovation may pose problems: (i) does the innovating agent himself possess the required competences and elements (the innovation process may remain purely internal) or do they have to be acquired from external sources and assimilated, which may be more or less difficult; (ii) does the process of recombination involve significant changes or adaptations to certain elements? (iii) are

---

<sup>38</sup> In reality, the "autonomous" existence of S2 and S3 (and, in Figure 8, the existence of S3 as a combination of S1 and S2) constitutes an additional service characteristic that has to be incorporated into the vectors.

there certain elements that offer great potential for innovation of this type?

This model has certain fundamental implications, particularly for services:

1) The capacity for innovation depends on the ability to explore and mobilise an extended set of knowledge and techniques. This has major implications for the role of the social forms of the flow and appropriation of information and knowledge (cf. on this point Foray [15])<sup>39</sup> and for the modes of organisation and innovation within firms. Although this point cannot be developed here, the specificity of the position of service firms should be noted.

The organisational innovation dimension (including technical media) is particularly strong in services, whereas there is relatively little research or innovation relating to components or materials<sup>40</sup> that draws upon the natural and life sciences. The main disciplines involved are the social sciences, computer science and sometimes mathematics (in banking and insurance, for example) and new disciplines located on the boundary between the social sciences and the "hard" sciences, such as linguistics, cognitive sciences and operational research methods.

2) The second implication of the recombinative innovation model is the need to design a certain type of modular architecture for both products and production systems in which products and systems are readily divisible. It is not difficult to imagine what this type of architecture might represent in manufacturing industry, where it is not really new. Things are less obvious in the case of services. Recombinative innovation obviously occurs in services, as we shall see in the next section, and in services of very different kinds (banking and insurance, hotels, information services, etc.). However, the implementation of this form of innovation in services is based on some important presuppositions. It is assumed that the "product" can be broken down into clearly identified and defined elements, in other words that the service characteristics and access to them can be rigorously specified. This may lead to a greater formalisation of existing activities, i.e. to the development of "standardised" products and modulization of service production (Sundbo [39]). In terms of the general representation shown in Figure 5, this means defining  $Y_i$  more precisely and, in certain cases, allocating a bigger role to  $X_j$ . In the case of services, in other words, it can be hypothesised that *innovation through formalisation* is an

---

<sup>39</sup> Some service providers, notably consultancy firms, play an essential role as diffusers of "elements" or as the medium through which they are combined (cf. Gallouj [24], Djellal [11], Bessant and Rush [5]).

<sup>40</sup> Except in those services such as transport and telecommunications that are highly capital-intensive.



important aspect of the establishment of "innovation routines". This is connected in part to the impact of computerisation in service industries.

3) The third implication of the recombinative model is located at industry level. Clusters of innovations emerging from different service industries are combined in such a way as to constitute systems. "What we are dealing with is a group of initially independent services that then forge links with each other and thus develop into a system. Examples of this process would include the systems that tend to develop around supermarkets, insurance, banking, consultancy services, etc., or even those that are beginning to emerge around the various forms of transport, catering services, hotels, tourism, leisure services, etc." (Gallouj [24]).

4) More generally, as soon as the question of (re)combination is raised, questions should also be asked about what it is that is being combined: knowledge, characteristics (which ones?), goods and services, human resources or institutions. This amounts to a shift away from analysis of cognitive processes towards notions of networks and local innovation systems. For example, when it comes to the organisation of R&D processes in services, new combinations of competences or characteristics may mean new combinations of individuals (particularly when expertise is highly tacit). This observation helps to explain the trend towards the establishment of flexible project groups to manage innovation in service firms.

The recombination model of innovation can shed new light on certain characteristics generally attributed to innovation and research in the service sector.

1. The unspectacular nature of product innovation. Defined in terms of "the routine use of a technological base", the recombination model does not operate through ruptures, but rather through the continuous and cumulative production of knowledge.

2. The difficulty of evaluating R&D. Traditional measures elaborately developed by national and international institutions are in fact based on criteria of novelty which are not relevant within the framework of the recombination model.

3. The low cost of innovation. If research or innovation rarely requires substantial investment, this is perhaps due to the process of recombination and the "systematic re-utilization" of components to enable major resource savings.

4. The relative lack of research in the classical sense: the production of new knowledge. The recombination model produces and also demands more in terms of "architectural knowledge" (as in engineering) than of knowledge of the components themselves.

5. No prototype perfection. Innovation consists of assembling existing components which have been proven in practice.
6. The difficulty of protecting innovations, which can be imitated relatively easily. If the validity of the recombination model is accepted, the important thing is not so much to protect innovation and impede imitation as to facilitate recombinations.

### **3.6 Formalisation innovation**

The various models of innovation outlined above are based on qualitative or quantitative variation in technical or service characteristics or competences (addition, elimination, improvement, bundling, unbundling). There is a final model in which it is not quantity or quality that varies, but rather the “visibility” and the degree of standardisation of the various characteristics.

This model, which we shall call the formalisation model, consists of putting the service characteristics “into order”, specifying them, making them less hazy, making them concrete, giving them a shape.

This objective is often achieved by putting in place technical characteristics, whether tangible (equipment, software, etc.) or intangible (e.g. methods, organisation, toolboxes).

This formalisation model also constitutes an attempt to clarify the correspondences between these technical characteristics and the service characteristics.

Putting the service characteristics “into order” frequently involves the transformation of a general function into sub-functions or service characteristics. This general process makes it possible to understand why this formalisation model often precedes the recombination model.

In many services, including knowledge-intensive ones, this formalisation model constitutes a genuine “natural trajectory”, in the sense of the term adopted by Nelson and Winter.

There are plenty of examples of this model. They are found in the cleaning industry, where Sundbo [41] highlights the growing importance of what he calls modularisation. They are also found in the fast-food industry (cf. the organisation of work at McDonald’s, analysed by Levitt [33]). Legal consultancy also provides examples. The

service known as “legal audit”, for example, has always been provided by consultants more or less automatically and always informally. The formalisation process consisted of finding a name for the service and establishing (following the model of financial auditing) reference points or methodological markers by which it could be defined. In this case, as in the other, the various elements can be said to have “existed” implicitly beforehand: they are rendered explicit through a process of social construction. It should be noted that this process of formalisation innovation was followed by implementation of the recombination model, in which the general legal audit is broken down into a number of specific audits: contract audits, patent audits, etc., all of them “products” that can be given an independent existence and be sold as such. The same can be said of all the examples cited in the case of recombinative innovation, to the extent that they had to be formalised beforehand (charter flights, recovery services, etc.).

The ultimate configuration of this formalisation model is the one that leads to the production of a real object that can be reduced to Saviotti and Metcalffe’s original representation. This is the case, for example, with the development of expert systems. The substitution of ATMs for transactions over the counter falls within the scope of this model.

#### **4. The theoretical implications of a characteristics approach to innovation**

As we have just shown, an approach to products in terms of final, technical and process characteristics offers a stimulating starting point for the study of innovation in services. Such an approach is sufficiently flexible to include both goods and services without sacrificing any of the specific aspects of innovation in services. Various modes of innovation are highlighted (radical innovation, innovation based on improvement, innovation involving the addition of new characteristics, ad hoc innovation, recombinative innovation, innovation through formalisation) and interpreted in terms of a characteristics dynamic.

This approach has implications for traditional theories of innovation, some aspects of which have already been mentioned and to which we now return by way of conclusion.

Description of a product in terms of characteristics clearly reconciles the "science-push" and "demand-pull" approaches to innovation: science, denoted by the vectors [C] and/or [X], and the demand for service characteristics, denoted by the vector [Y],

constitute the two facets of the product (good or service). An innovation may use one of these two points of entry, or both at the same time. The "science-push" determinant, it should be noted, cannot be limited solely to the physical sciences, however: it also takes account of progress in the social sciences. [X] and [C] respectively encompass not only technologies in the narrow sense of the term and the competences relating to those technologies, but also the "technologies" specific to services (legal, financial, commercial, etc.) and the competences corresponding to them.

This has consequences for the definition and content of technological trajectories in services. In Saviotti and Metcalfe's approach [36], the "technological regime" (in Nelson and Winter's sense) or the "dominant design" (in Abernathy and Utterback's sense) correspond to a given list of technical characteristics  $X_j$ . A "technological trajectory" is a path of gradual improvement in the  $X_j$ . In the case of services, the term takes on a particular meaning, since it can refer as well (or indeed exclusively) to service "technologies" (financial, actuarial, human resource management etc.). These technologies are also characterised by "lock-in" phenomena: it is difficult to envisage a return to Taylorism in areas where other techniques of work organisation have been tested. It is also possible in the "purest" services to introduce cognitive trajectories: the accumulation of expertise, individual and collective learning processes, gradual improvement of the  $C_k$ . In this case, the technological regime can be renamed the cognitive regime, thus constituting a general frame of competence formalised by a list of cognitive characteristics ( $C_k$ ).

Even though certain modes of innovation (such as recombinative innovation) are particularly important today, it does not seem possible to articulate the various modes of innovation over the course of a product's life cycle. Barras' attempt to do so (cf. §1) is interesting but reductionist in terms of modes of innovations. Indeed, from the point of view of a characteristics approach, Barras' model can be said to be technologist, to the extent that it sees innovation as having only one point of entry: either [Z], the vector of process characteristics, or [X], the vector of technical characteristics; as we have already stressed, it is difficult to distinguish between the two. Taking as its starting point a service defined as the set  $\{[Z], [X], [Y]\}$ , the "reverse product cycle" theory envisages the following dynamic, which corresponds to the three phases of the cycle:

1)  $\{[Z], [X], [Y]\}$ : the introduction of new process characteristics (linked to mainframe introduction in banks, for example), which gives rise to new technical

characteristics (computerisation of the back office) but no real change in final characteristics: [Y] is not altered (even if its cost falls).

2) {Z"}, [X"}, [Y"}: the introduction of new process characteristics (mini-computers), which gives rise to new sets of technical characteristics (ATMs in banks) and a certain improvement in the service characteristics (improved quality of service).

3) {[Z"}, [X"}, [Y"}: the introduction of new process characteristics (network technologies), which give rise to new technical characteristics (home banking) and a multiplicity of new service characteristics.

### References

- [1] C. Argyris, D. Schön, *Organizational learning : a theory of action perspective*, (Reading, MA : Addison-Wesley, 1978).
- [2] A. Barcet, J. Bonamy, A. Mayère, *Modernisation et innovation dans les services aux entreprises*, Commissariat Général du Plan, (1987).
- [3] R. Barras, Towards a Theory of Innovation in Services, *Research Policy*, 15., (1986) pp. 161-173.
- [4] R. Barras, Interactive Innovation in Financial and Business Services : The Vanguard of the Service Revolution, *Research Policy*, 19, (1990) pp. 215-237.
- [5] J. Bessant, H. Rush, Building bridges for innovation : the role of consultants in technology transfer, *Research Policy*, 24, (1995) pp. 97-114.
- [6] A. Bressand, K. Nicolaïdis, Les services au coeur de l'économie relationnelle, *Revue d'Economie Industrielle*, 43, (1988), pp. 141-163.
- [7] M. Callon, *Pratiques et enjeux de la démarche qualité dans deux filiales de la Sodexo (Bâteaux parisiens, Chèques restaurants)*, confidential research report, CSI, Ecole Nationale Supérieure des Mines, Paris, December, (1995)
- [8] J. De Bandt, *Services aux entreprises : Informations, Produits, Richesses*, (Economica, Paris, 1995).
- [9] J. De Bandt, J. Gadrey (Eds), *Relations de service, marchés des services*, (CNRS Editions, Paris, 1994)
- [10] M. Desai, W. Low, *Measuring the Opportunity for Product Innovation*, in M. De Cecco (Ed), *Changing Money : Financial Innovation in Developed Countries*,

- (Basil Blackwell, 1987).
- [11] F. Djellal, *Changement technique et conseil en technologie de l'information*, (Editions L'Harmattan, Logique économique, Paris, 1995).
- [12] G. Dosi, Technological Paradigms and Technological Trajectories, *Research Policy*, 11, (1982) pp.147-162.
- [13] S. Dubuisson, *Sodexo : réorganisation d'une offre de service : codification et ajustement de la prestation*, research report for Sodexo, CSI, Ecole Nationale Supérieure des Mines, Paris, October (1995).
- [14] P. Eiglier, E. Langeard, *Servuction : le marketing des services*, (Mc Graw-Hill, 1987).
- [15] D. Foray, *Modernisation des entreprises, coopération industrielle inter et intra-firmes et ressources humaines*, report for the Ministry of Research and Technology, June (1993).
- [16] D. Foray, Les nouveaux paradigmes de l'apprentissage technologique, *Revue d'économie industrielle*, n°69 (1994) pp. 93-104.
- [18] J. Gadrey, *L'économie des services*, (Repères, La Découverte, Paris, 1992).
- [19] J. Gadrey, C. Gallouj, F. Gallouj, F. Martinelli, F. Moulaert, P. Tordoir, *Manager le Conseil*, (Ediscience, Paris, 1992).
- [20] J. Gadrey, F. Gallouj, *L'innovation dans l'assurance : le cas de l'UAP*, research report for UAP, University of Lille I and IFRESI, September (1994).
- [21] J. Gadrey, F. Gallouj, S. Lhuillery, T. Ribault, O. Weinstein, *La recherche-développement et l'innovation dans les activités de service : le cas du conseil, de l'assurance et des services d'information électronique*, report for the Ministry of Higher Education and Research, December (1993).
- [22] C. Gallouj, F. Gallouj, *L'innovation dans les services* (Editions Economica, Paris, 1996).
- [23] F. Gallouj, Les formes de l'innovation dans les services de conseil, *Revue d'économie industrielle*, n°57, (1991) pp. 25-45.
- [24] F. Gallouj, Cycles économiques et innovations de service : quelques interrogations à la lumière de la pensée schumpeterienne, *Revue française d'économie*, volume IX, 4, Autumn, (1994) pp.169-213.
- [25] F. Gallouj, *Economie de l'innovation dans les services*, (Editions L'Harmattan, logique économique, Paris, 1994).
- [26] S. I. Greenbaum, C. F. Haywood, Secular Change in the Financial Services Industry, *Journal of Money, Credit, and Banking*, May, (1971) pp. 571-589
- [27] J. C. Hardouin, *L'apparition de l'innovation financière. Contribution à l'étude de ses éléments explicatifs*, Thèse complémentaire, University of Rennes (1973).
- [28] R. M. Henderson, K. B. Clark, Architectural Innovation : The Reconfiguration of Existing Product Technologies and the Failure of Established Firms, *Administrative*

- Science Quarterly*, Vol. 35, n°1, March, (1990) pp. 9-30.
- [29] A. Hennion et al., *Lyonnaise des Eaux-Dumez : une entreprise face à ses innovations : politique, technologie, environnement*, research report for Lyonnaise des Eaux-Dumez, October (1995).
- [30] P. Hill, On goods and services, *The Review of Income and Wealth*, 4, december, (1977), pp. 315-338.
- [31] M. Kubr, *Management Consulting : a Guide to the Profession*, ILO, Geneva (1988).
- [32] K. J. Lancaster, A New Approach to Consumer Theory, *Journal of Political Economy*, 14, (1966) pp. 133-156.
- [33] T. Levitt, Production line approach to service, *Harvard Business Review*, september-october (1972).
- [34] I. Miles, N. Kastrinos, K. Flanagan, R. Bilderbeek, P. Den Hertog, W. Huntik, M. Bouman, *Knowledge-Intensive Business Services : Users, Carriers and Sources of Innovation*, Rapport pour DG13 SPRINT-EIMS, March (1995).
- [35] R. Nelson, S. Winter, *An Evolutionary Theory of Economic Change*, (Belknap Harvard, 1982).
- [36] P.P. Saviotti, J.S. Metcalfe, A theoretical approach to the construction of technological output indicators, *Research Policy*, 13, (1984) pp. 141-151.
- [37] P.P. Saviotti, *Technological evolution, variety and the economy*, (Edward Elgar Publishing Limited, 1996).
- [38] L. Soete, M. Miozzo, *Trade and Development in Services : a Technological Perspective*, MERIT (1990).
- [39] J. Sundbo, Modulization of service production and a thesis of convergence between service and manufacturing organizations, *Scandinavian Journal of Management*, Vol. 10, n°3, (1994).pp. 245-266.
- [40] J. Sundbo, Management of innovation in services, Forthcoming in *The Service Industries Journal*.
- [41] J. Sundbo, Development of the service system in a manual service firm : a case study of the Danish ISS, *Advances in Services Marketing and Management*, vol. 5, (1996) p. 169-191.
- [42] M.L. Tushman, Anderson P., Technological discontinuities and organizational environments, *Administrative Science Quarterly*, 31, (1986) pp. 439-465.
- [43] W. Van Der Aa, T. Elfring, *A typology of Innovations in Service Firms*, Conférence on "Managing Innovations in Services", Cardiff Business School, 5-7 April (1993).
- [44] G. Zaltman, R. Duncan, J. Holbek, *Innovation and Organization*, (John Wiley and Sons, New York, 1973).

- [45] P. Zarifian, La production industrielle comme production de services, Colloque "Dynamique des services et théories économiques", University of Lille I, January (1987).



CONCEPT	MEANING
Interface	(physical or virtual) point of contact between customer and service provider (or his technical systems)
Interaction	exchanges of information, knowledge and civilities, performance of repair/rectification tasks
Co-production	extensive and balanced interaction (essentially operational)
Servuction [14]	the process of creating a service by linking up various elements: the customer, the physical medium, contact personnel, the service, the system of internal organisation, other customers
Socially regulated service relationship [18]	manifestation of new forms of the social regulation of relationships between producers and consumers
Service relationship [9]	"mode of coordinating the actors on the supply and demand sides" for services or for goods. Operational relationships (co-production) + social relationships for the control and regulation of action programme

**Figure 1 : Various ways of expressing customer involvement in the provision of services**

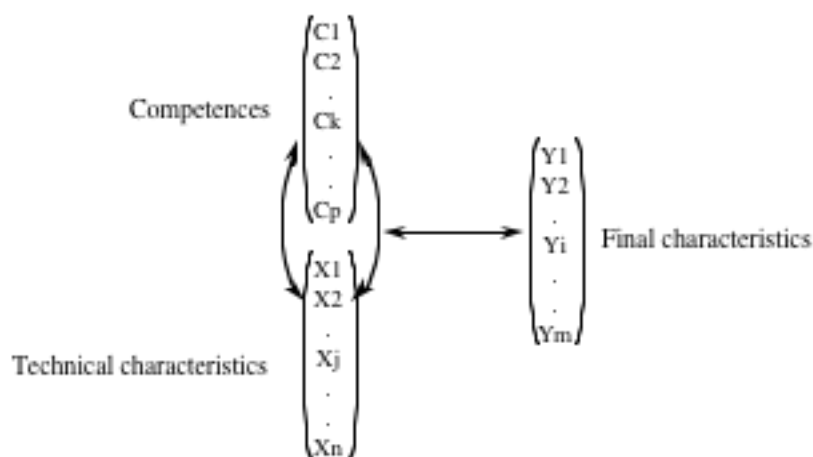

**Figure 2 : a representation of a product or service as a system of characteristics and competences** Source: based on Saviotti and Metcalfe [36]

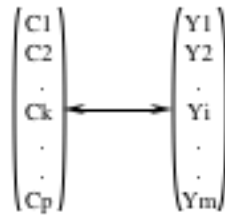

Figure 3 : The case of a "pure", "intangible" service



Figure 4 : The case of a "pure" service (including the coproduction relationship)

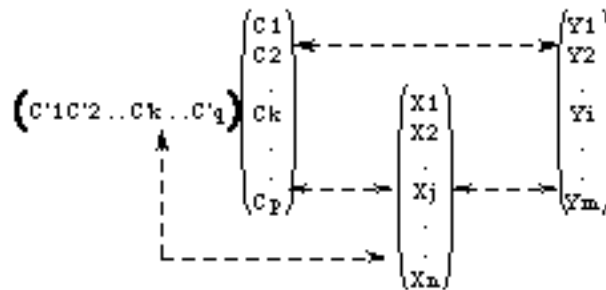

Figure 5 : The general form

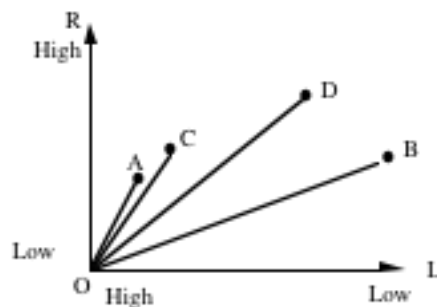
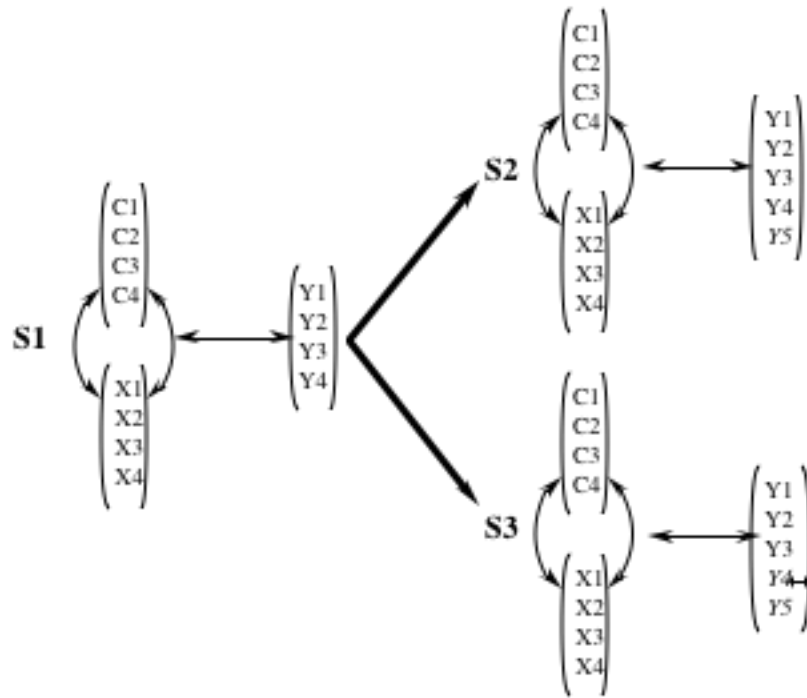
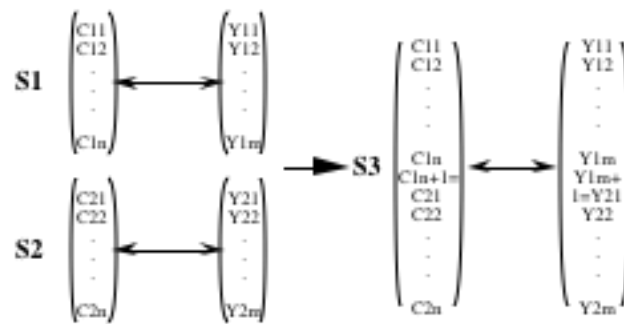

Figure 6: Representation of financial products in a diagram of characteristics Source: After Desai and Low [10]



**Figure 7 : S2: incremental innovation through the addition of characteristics (Y5); S3: incremental innovation through substitution of characteristics (substitution of Y5 for Y4)**



**Figure 8 : A new service (S3) produced by recombining the characteristics of two existing services (S1 and S2)**

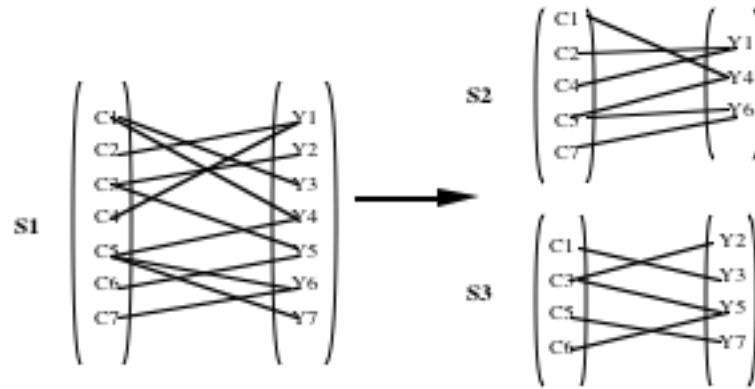

**Figure 9 : Two autonomous new services (S2 and S3) produced by splitting up the characteristics of an existing service (S1)**

---

<sup>i</sup> In the SI4S project national reports on innovation in services have been produced by the following research teams: DIW, Berlin, Germany; TNO, The Netherlands; STEP group, Oslo, Norway, NUTEK, Stockholm, Sweden; PREST, University of Manchester, UK; Roskilde university, Centre of Service Studies, Denmark; and IFRESI, University of Lille 1, France.

<sup>ii</sup> The basis for the driving force scheme has been the reports from the national teams of the SI4S projects on the service innovation situations in different countries. The scheme thus is a result of the SI4S work and we owe thanks to the national teams