



**HAL**  
open science

# Textile Terminologies from the Orient to the Mediterranean and Europe, 1000 BC to 1000 AD

Salvatore Gaspa, Cécile Michel, Marie Louise Bech Nosch

► **To cite this version:**

Salvatore Gaspa, Cécile Michel, Marie Louise Bech Nosch (Dir.). Textile Terminologies from the Orient to the Mediterranean and Europe, 1000 BC to 1000 AD. 2017, 10.13014/K2S46PVB . halshs-01674057

**HAL Id: halshs-01674057**

**<https://shs.hal.science/halshs-01674057v1>**

Submitted on 4 Jan 2018

**HAL** is a multi-disciplinary open access archive for the deposit and dissemination of scientific research documents, whether they are published or not. The documents may come from teaching and research institutions in France or abroad, or from public or private research centers.

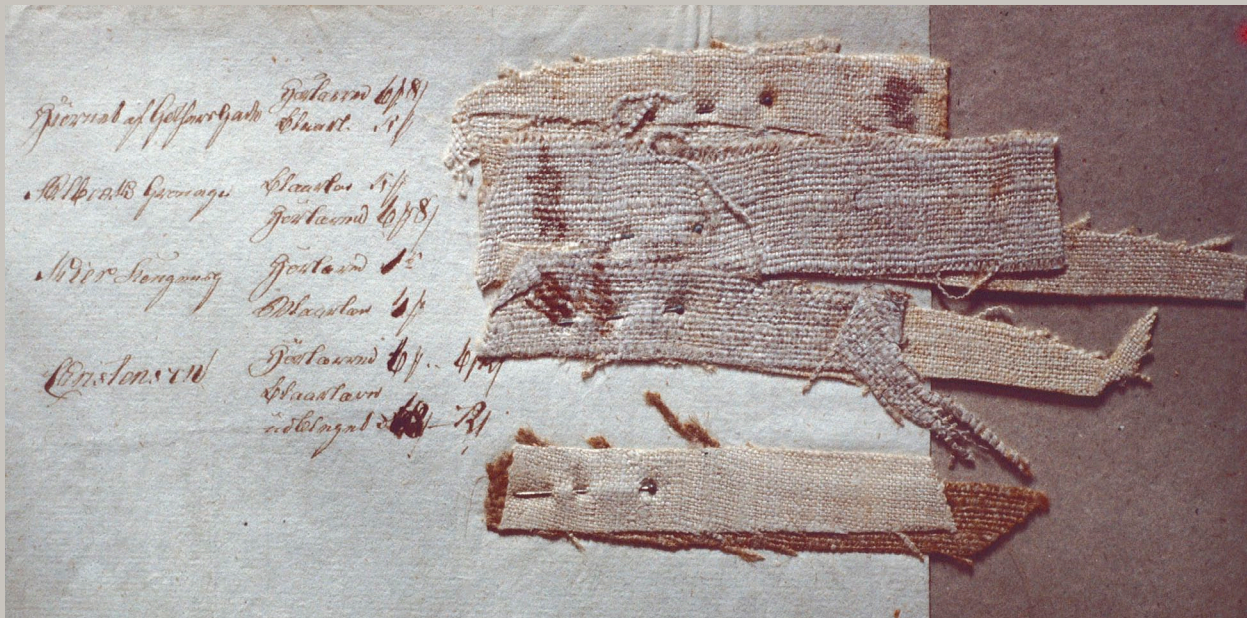
L'archive ouverte pluridisciplinaire **HAL**, est destinée au dépôt et à la diffusion de documents scientifiques de niveau recherche, publiés ou non, émanant des établissements d'enseignement et de recherche français ou étrangers, des laboratoires publics ou privés.



# Textile Terminologies

from the Orient  
to the Mediterranean  
and Europe,  
1000 BC to 1000 AD

**Salvatore Gaspa, Cécile Michel, & Marie-Louise Nosch, editors**



The papers in this volume derive from the conference on textile terminology held in June 2014 at the University of Copenhagen. Around 50 experts from the fields of Ancient History, Indo-European Studies, Semitic Philology, Assyriology, Classical Archaeology, and Terminology from twelve different countries came together at the Centre for Textile Research, to discuss textile terminology, semantic fields of clothing and technology, loan words, and developments of textile terms in Antiquity. They exchanged ideas, research results, and presented various views and methods.

This volume contains 35 chapters, divided into five sections:

- Textile terminologies across the ancient Near East and the Southern Levant
- Textile terminologies in Europe and Egypt
- Textile Terminologies in metaphorical language and poetry
- Textile terminologies: examples from China and Japan
- Technical terms of textiles and textile tools and methodologies of classifications

The 44 contributors include Salvatore Gaspa, Cécile Michel, Marie-Louise Nosch, Elena Soriga, Louise Quillien, Luigi Malatucca, Nahum Ben-Yehuda, Christina Katsikadeli, Orit Shamir, Agnes Korn, Georg Warning, Birgit Anette Olsen, Stella Spantidaki, Peder Flemestad, Birgit Anette Olsen, Peter Herz, Ines Bogensperger, Herbert Graßl, Peder Flemestad, Mary Harlow, Berit Hildebrandt, Magdalena Öhrman, Roland Schuhmann, Kerstin Droß-Krüpe, John Peter Wild, Maria Mossakowska-Gaubert, Julia Galliker, Anne Regourd, Fiona J. L. Handley, Götz König, Miguel Ángel Andrés-Toledo, Stefan Niederreiter, Oswald Panagl, Giovanni Fanfani, Le Wang, Feng Zhao, Mari Omura, Naoko Kizawa, Maciej Szymaszek, Francesco Meo, Felicitas Maeder, Kalliope Sarri, Susanne Lervad, and Tove Engelhardt Mathiassen.

Illustrated with 134 color and black & white illustrations.

ISBN: 978-1-60962-112-4

doi:10.13014/K2S46PVB

Zea Books  
Lincoln, Nebraska

UNIVERSITY OF  
**Nebraska**  
Lincoln

# Textile Terminologies

from the Orient  
to the Mediterranean  
and Europe,  
1000 BC to 1000 AD

Salvatore Gaspa, Cécile Michel, & Marie-Louise Nosch, editors

Zea Books  
Lincoln, Nebraska  
2017



Copyright © 2017 Salvatore Gaspa, Cécile Michel, & Marie-Louise Nosch.

*Photographs copyright as noted.*

ISBN: 978-1-60962-112-4

doi:10.13014/K2S46PVB

Composed in Times New Roman, Maiandra GD, Thorne Shaded, IFAOGrec, PMingLiu, SimSun, Times New Unicode, and Segoe types by Paul Royster.

Zea Books are published by the University of Nebraska–Lincoln Libraries.

Electronic (pdf) edition online at <http://digitalcommons.unl.edu/zeabook/>

Print edition available from <http://www.lulu.com/spotlight/unllib>

UNL does not discriminate based upon any protected status.  
Please go to [unl.edu/nondiscrimination](http://unl.edu/nondiscrimination)

UNIVERSITY OF  
**Nebraska**  
Lincoln

# Preface

This volume is the fruit of a longstanding collaboration in the field of textile terminologies. Since 2005, Cécile Michel and Marie-Louise Nosch have collaborated on numerous academic activities – joint teaching, lectures at conferences, experimental workshops, co-publishing and co-editing. One of the highlights was the first *Textile Terminologies of the 3<sup>rd</sup> and 2<sup>nd</sup> millennia* conference, an exploratory workshop with a diachronic and interdisciplinary scope held in Copenhagen in March 2009 with the generous support of the European Science Foundation.

The French-Danish scholarly cooperation on textile research was further consolidated in the “Programme International de Coopération Scientifique” *TexOrMed* (2012-2014). The European Science Foundation Exploratory *Workshop on Wool economy in the Near East and the Aegean* organized in Nanterre in November 2012 was one of the flagship projects of this collaboration.

In 2013 Salvatore Gaspa joined the team with a prestigious Marie Curie Grant from the Seventh Framework Programme of the European Union (FP7). Together they fostered the idea of continuing the textile terminological research but widening the scope to Central and North European and Asian languages and focusing on the 1<sup>st</sup> millennium BC and 1<sup>st</sup> millennium CE, thus providing a platform for the textile terminological exchange of the classical languages of Greek and Latin, but also including Germanic languages, Armenian, Italic, Semitic, Chinese and Japanese.

The second conference on textile terminology was held in June 2014 at the University of Copenhagen. Around 50 experts from the fields of Ancient History, Indo-European Studies, Semitic Philology, Assyriology, Classical Archaeology, and Terminology from twelve different countries came together at the Centre for Textile Research, to discuss textile terminology, semantic fields of clothing and technology, loan

words, and developments of textile terms in Antiquity. They exchanged ideas, research results, and presented various views and methods.

It was a specific aim to cross disciplinary boundaries, both between language families and chronological phases, but also to keep the focus on textiles and garments as visual, tactile and material items, and not simply words. This multi-faceted view is also apparent in the present volume. We have, as far as possible, included illustrations where it was possible, in order to marry images, objects and words.

The present volume has been prepared within the frame of an international cooperation, the *Groupe de Recherche International ATOM = Ancient Textiles from the Orient to the Mediterranean* (2015-2018) which involves several research institutions and universities in France, Denmark and the United Kingdom. *ATOM* aims to define both the impact of textile production on agriculture, husbandry and the environment, its role in handicrafts, in trade, and, more generally, in the ancient economy, but also the uses of clothing in the construction of gender and individual and collective identities.

We are delighted that Zea Books of the University of Nebraska–Lincoln Libraries’ Office of Scholarly Communications accepted this volume for publication. The open and free access will make our joint efforts available worldwide, and this is particularly important for a topic such as textile terminologies, which represents a truly global phenomenon. The electronic interface makes the papers searchable for those colleagues wishing to follow the paths of a textile or garment term, or for those who will search for textile techniques, tools or professions across languages and culture. We hope that the specialized papers will reach experts around the world, and enjoy a large and interested global readership who finds that the terminology of textiles is an intriguing endeavour.

# Acknowledgements

We warmly thank all participants for their insightful and stimulating papers, lively discussions, inspiring exchange of ideas, both during the conference and in continued exchanges after the conference.

We would like to express our sincere gratitude to those individuals and institutions who have contributed to the success of the conference and to the editorial work for the publication. First and foremost, for the generous financial support from our sponsors and hosts providing the institutional and financial framework for this conference and its publication: The Danish National Research Foundation's Centre for Textile

Research (CTR), the Alexander von Humboldt Stiftung, the PICS *TexOrMed*, the GDRI *Ancient Textiles from the Orient to the Mediterranean* (ATOM), and the Centre National de la Recherche Scientifique (CNRS). Financial support has also been provided by the Marie Curie Intra-European Fellowship within the Seventh Framework Programme of the European Commission for research activities at the University of Copenhagen (ASTEX Project no. 36539).

This publication benefitted from the assistance and advice of our colleagues Peder Flemestad, Cherine Munkholt, Cailin Kwoh and Sidsel Frisch.

Salvatore Gaspa  
Cécile Michel  
Marie-Louise Nosch  
December 2016

# Contents

Preface . . . . .	3
Acknowledgements . . . . .	4
List of Contributors . . . . .	9
1 Textile Terminologies, State of the Art and New Directions . . . . .	19
<b>Salvatore Gaspa, Cécile Michel, &amp; Marie-Louise Nosch</b>	

## **Textile terminologies across the ancient Near East and the Southern Levant**

2 A Diachronic View on Fulling Technology in the Mediterranean and the Ancient Near East: Tools, Raw Materials and Natural Resources for the Finishing of Textiles . . . . .	24
<b>Elena Soriga</b>	
3 Garments, Parts of Garments, and Textile Techniques in the Assyrian Terminology: . . . . .	47
The Neo-Assyrian Textile Lexicon in the 1st-Millennium BC Linguistic Context	
<b>Salvatore Gaspa</b>	
4 Tools and Crafts, the Terminology of Textile Manufacturing in 1st-Millennium BC Babylonia . . . . .	91
<b>Louise Quillien</b>	
5 Ordinary People’s Garments in Neo- and Late-Babylonian Sources . . . . .	107
<b>Luigi Malatacca</b>	
6 Flax and Linen Terminology in Talmudic Literature . . . . .	122
<b>Nahum Ben-Yehuda</b>	
7 Jewish Terminologies for Fabrics and Garments in Late Antiquity: A Linguistic Survey Based on the Mishnah and the Talmuds . . . . .	153
<b>Christina Katsikadeli</b>	
8 <i>Sha’atnez</i> – The Biblical Prohibition Against Wearing Mixed Wool and Linen Together and the Observance and Enforcement of the Command in the Orthodox Jewish Communities Today . . . . .	164
<b>Orit Shamir</b>	



- 9 Armenian *karmir*, Sogdian *karmīr* ‘red’, Hebrew *karmīl* and the Armenian Scale  
Insect Dye in Antiquity . . . . . 173  
**Agnes Korn & Georg Warning**
- 10 Armenian Textile Terminology . . . . . 188  
**Birgit Anette Olsen**

### **Textile terminologies in Europe and Egypt**

- 11 Remarks on the Interpretation of Some Ambiguous Greek Textile Terms . . . . . 202  
**Stella Spantidaki**
- 12 Sabellic Textile Terminology . . . . . 210  
**Peder Flemestad & Birgit Anette Olsen**
- 13 Beschaffung und Handel mit Farbstoffen . . . . . 228  
**Peter Herz**
- 14 Purple and its Various Kinds in Documentary Papyri. . . . . 235  
**Ines Bogensperger**
- 15 Zur Textilterminologie auf römischen Bleitäfelchen: Probleme der Lesung und  
Interpretation . . . . . 250  
**Herbert Graßl**
- 16 Observations on the Terminology of Textile Tools in the *Edictum Diocletiani* on  
Maximum Prices . . . . . 256  
**Peder Flemestad, Mary Harlow, Berit Hildebrandt, & Marie-Louise Nosch**
- 17 Listening for *licia*: A Reconsideration of Latin *licia* as Heddle-Leashes. . . . . 278  
**Magdalena Öhrman**
- 18 Textile Terminology in Old High German between Inherited and Loan Words. . . . . 288  
**Roland Schuhmann**
- 19 Χιτών – δαλματική – μαφόρτης – σύνθεσις: Common and Uncommon Garment  
Terms in Dowry Arrangements from Roman Egypt . . . . . 295  
**Kerstin Droß-Krüpe**
- 20 *Ars polymita, ars plumaria*: The Weaving Terminology of *taqueté* and Tapestry . . . . . 301  
**John Peter Wild & Kerstin Droß-Krüpe**

- 21 Tunics Worn in Egypt in Roman and Byzantine times: The Greek Vocabulary. . . . . 321  
**Maria Mossakowska-Gaubert**
- 22 Terminology Associated with Silk in the Middle Byzantine Period (AD 843-1204) . . . 346  
**Julia Galliker**
- 23 A Name of a Private Factory (or Workshop) on a Piece of Textile: The Case of  
the Document A.L.18 (Vienna) . . . . . 374  
**Anne Regourd & Fiona J. L. Handley**

### **Textile Terminologies in metaphorical language and poetry**

- 24 Zur Bekleidung der Krieger im Avesta: Rüstung und magischer Schmuck . . . . . 383  
**Götz König**
- 25 Sasanian Exegesis of Avestan Textile Terms . . . . . 397  
**Miguel Ángel Andrés-Toledo**
- 26 “*Der Faden soll nicht reißen, während ich meine Dichtung webe...* ”:  
Zum metaphorischen Gebrauch von Textilterminologie im Rigveda . . . . . 404  
**Stefan Niederreiter**
- 27 Der Text als Gewebe: Lexikalische Studien im Sinnbezirk von Webstuhl und Kleid . . . 413  
**Oswald Panagl**
- 28 Weaving a Song. Convergences in Greek Poetic Imagery between Textile and  
Musical Terminology. An Overview on Archaic and Classical Literature . . . . . 421  
**Giovanni Fanfani**

### **Textile terminologies: examples from China and Japan**

- 29 *Xie*, a Technical Term for Resist Dye in China: Analysis Based on the Burial  
Inventory from Tomb 26, Bijiashan, Huahai, Gansu . . . . . 437  
**Le Wang & Feng Zhao**
- 30 The Textile Terminology in Ancient Japan . . . . . 451  
**Mari Omura & Naoko Kizawa**

## Technical terms of textiles and textile tools and methodologies of classifications

31	The Textile Term <i>gammadia</i> . . . . .	483
	<b>Maciej Szymaszek</b>	
32	The <i>oscillum</i> Misunderstanding . . . . .	492
	<b>Francesco Meo</b>	
33	Irritating Byssus – Etymological Problems, Material facts, and the Impact of Mass Media . . . . .	500
	<b>Felicitas Maeder</b>	
34	Conceptualizing Greek Textile Terminologies: A Databased System . . . . .	520
	<b>Kalliope Sarri</b>	
35	textilnet.dk – A Toolkit for Terminology Research and Presentation . . . . .	528
	<b>Susanne Lervad &amp; Tove Engelhardt Mathiassen</b>	

# List of contributors

**Miguel Ángel Andrés-Toledo** is at the Department of Classical Philology and Indo-European Linguistics of the University of Salamanca, Spain, where he obtained the degree of Doctor Europaeus with his PhD *Vīdēvdād 10-12: Critical Edition, Translation and Commentary of the Avestan and Pahlavi Texts*. He has also been Post-doctoral Research Assistant at the Institut für Iranistik of the Freie Universität Berlin, Germany (2010-2013); Associate Professor and Marie Skłodowska-Curie Fellow at The Danish National Research Foundation's Centre for Textile Research of the University of Copenhagen, Denmark (2013-2015); and Post-doctoral Research Fellow at the Institute of Asian and African Studies of the Hebrew University of Jerusalem, Israel (2016). His research interests are Old and Middle Iranian languages and literatures, Old Indian languages and literatures, Zoroastrianism, Avestan and Pahlavi manuscripts and textual criticism, Iranian and Indian lexicography, and Indo-Iranian and Indo-European linguistics.

**Nahum Ben-Yehuda** is currently a doctoral candidate at Bar Ilan University, Land of Israel Studies Dept. His previous degrees are from the departments of Talmud and Jewish History, respectively. He is an ordained orthodox rabbi, recognized by the Chief Rabbinate of Israel. He studied Textile Engineering at Shenkar College, and is an associate (CText ATI) of The Textile Institute, Manchester UK. He serves on the Editorial Board of the *Journal of Natural Fibers* and is a member of the European Cooperative Research Network on Flax and other Bast Plants. His background includes product design and engineering in the textile industry, and he is currently a textile craftsman specializing in flax-linen at all stages of the *chaîne opératoire*. These diverse qualifications

enhance his *longue durée* and multidisciplinary approach to historical Biblical and Talmudic textile and garment research.

**Ines Bogensperger** studied Classical Archaeology and is currently a PhD candidate of Ancient History at the University of Vienna, Austria. During the *forMuse*-research project, she studied and catalogued the Late Antique textile collection of the *Papyrussammlung* of the Austrian National Library (2010-2012). Besides her focus on textiles, she was collaborator in the FWF-research project 'Egypt's southern boarder in the 6<sup>th</sup>-11<sup>th</sup> century AD' (2013-2015), where she participated in a summer school on Cultural Heritage. Starting from 2015, she is working in the current FWF-project 'Texts and Textiles in Late Antique Egypt', which aims to combine the papyrological evidence with the contemporaneous preserved textiles from Late Antique Egypt.

**Kerstin Droß-Krüpe** is currently employed as a post-doctoral assistant at Kassel University. She studied Classical Archaeology, Ancient History and Business Administration at Philipps-Universität Marburg and obtained her PhD in 2010 with a thesis concerning textile production during the Roman Empire in the province of Egypt, which was published as *Wolle – Weber – Wirtschaft. Die Textilproduktion der römischen Kaiserzeit im Spiegel der papyrologischen Überlieferung* (Wiesbaden 2011). In 2012 she received a post-doctoral grant at the Danish National Research Foundation's Centre for Textile Research (CTR) in Copenhagen. In 2014 and 2016 she (co-)edited two volumes on ancient textile trade: *Textile Trade and Distribution in Antiquity* (Wiesbaden 2014) and *Textiles, Trade, and Theories* (Münster 2016, with Nosch). In addition to ancient economic history and ancient textile studies

her research focuses on the reception of antiquity. Her current research project deals with the reception of the “Babylonian” queen Semiramis.

**Giovanni Fanfani** is a classical philologist and post-doctoral researcher in the ERC Consolidator Grant Project *PENELOPE: A Study of Weaving as Technical Mode of Existence*, hosted at the Research Institute for the History of Science and Technology, Deutsches Museum, Munich. In his previous project, based at the Danish National Research Foundation’s Centre for Textile Research (University of Copenhagen), for which he was awarded a Mobilex Grant (2014-2016) from the Danish Council for Independent Research, he has investigated the role and function of textile imagery in archaic and classical Greek poetry and poetics. He has co-edited together with Harlow and Nosch the book *Spinning Fates and the Song of the Loom*, 2016. His research interests include Euripidean tragedy and its interaction with the melic tradition.

**Peder Flemestad** is a classical philologist. He is currently a doctoral candidate at Lund University, Sweden, and an affiliated researcher at the Centre for Textile Research at the University of Copenhagen, Denmark; his project investigates aspects of dress and identity in the imperial Greek world. He has previously held various teaching and research positions at the University of Copenhagen (2005-16), and has worked for the *Tracking Colour* project at the Ny Carlsberg Glyptotek. His research interests include ancient Greek and Latin language and literature, ancient history and epigraphy, Indo-European studies, and diachronic terminology.

**Julia Galliker** is currently a post-doctoral researcher at the University of Michigan. She is currently involved in the *Spiral Textile* project which seeks to bridge the gap between academic historical textile research and the worldwide community of practitioners by crowd-sourcing experimental archaeology through a web-based platform. She is also

researching Greek and Coptic inscribed textiles at the Kelsey Museum of Archaeology. Julia earned her PhD in Byzantine History at the University of Birmingham UK in 2014. Her dissertation is a parallel investigation of textual and material evidence associated with representational figured silks attributed to Mediterranean workshops between AD 600-1200. She also holds an MBA in corporate finance and MA degrees in history and international relations. Before resuming her studies, Julia was a corporate treasurer for a major automotive supplier.

**Salvatore Gaspa** is a historian specialized in Ancient Near Eastern studies. His main research interests relate to the history, administration, cult, economy and material culture of the Neo-Assyrian Empire. He was awarded a PhD in Semitic Linguistics by the University of Firenze in 2007 and a PhD in Ancient Near Eastern history by the University of Naples “L’Orientale” in 2011. His most recent publications include a book on foods and food practices in Assyria, a monograph on vessels in the Neo-Assyrian sources, and various papers on textiles in 1st-millennium BC Assyria. In 2013-2015 he has been Marie Skłodowska-Curie Fellow and Associate Professor at the Danish National Research Foundation’s Centre for Textile Research of the University of Copenhagen with a research project on textiles in the Neo-Assyrian Empire. In 2015 he was awarded a grant from the Carlsberg Foundation for a project on textiles in ritual and cultic practices in the Ancient Near East.

**Herbert GraBl** is emeritus professor of ancient history at the university of Salzburg, Austria. He received his Dr. phil from the University of Graz, taught ancient history in the universities of Klagenfurt and Salzburg. Recent publications include articles on literary and epigraphic texts on ancient textiles and textile economy, erotic graffiti, ancient geography and local history of the Alpine region.

**Fiona J. L. Handley** is a Senior Lecturer in Learning and Teaching at the University of Brighton, UK. She has a wide variety of research interests, including ancient textiles from Egypt, especially the Roman and Islamic periods. She was the textile, basketry, matting and cordage specialist on two University of Southampton archaeological expeditions to Egypt (Mons Porphyrites and Quseir al-Qadim), and held an AHRC Research Fellowship at the Textile Conservation Centre, University of Southampton to study these groups of textiles further.

**Mary Harlow** is Associate Professor in Ancient History at the University of Leicester, UK. Her research interests are in dress, the life course (age and ageing), gender and social history more widely. Her most recent publications include the edited volumes: *A Cultural History of Fashion and Dress* (2016); *Spinning the Fates* (with Fanfani and Nosch, 2016); and *Greek and Roman Textiles and Dress, An Interdisciplinary Anthology* (with Nosch, 2014).

**Peter Herz** studied history, Latin, and archaeology at Mainz and Oxford (1968-1975). PhD in Ancient History Mainz 1975. Practical time as a teacher 1977-78. Traveling scholarship of the Deutsches Archäologisches Institute 1978-79. University assistant Mainz 1980. Habilitation for Ancient History Mainz 1985. Professor Mainz 1986. Replacement in Darmstadt, Basel and Heidelberg. Institute for Advanced Study 1990. Chair for Ancient History University of Regensburg (1994-2014). Main fields of research: Social and economic history, history of religions (ruler cult in antiquity), Latin epigraphy, history of the Roman Empire.

**Berit Hildebrandt** is a researcher and project manager at the Nordic Centre of Heritage Learning and Creativity in Östersund, Sweden. She is educated as a Classical Archaeologist (M.A.) and Ancient Historian (PhD) and has worked at the German universities of Greifswald (as a lecturer), München (as a PostDoc with a fellowship from the German Research Foundation, DFG) at the

Graduate School “Forms of Prestige in Cultures of the Ancient World”) and Hannover (as assistant professor). In 2011-12 she held a Volkswagen Foundation postdoctoral fellowship at the Mahindra Humanities Center at Harvard University where she organized a workshop on “Silk. Trade and Exchange along the Silk Roads” (the contributions of which are published with Oxbow in CTR’s Ancient Textiles Series). From 2013-2015 she was a Marie Skłodowska-Curie Fellow at the Danish National Research Foundation’s Centre for Textile Research (CTR) at Copenhagen University, Denmark, with a project exploring the costumes of the Roman Emperors. Another textile-related area of her research concerns the study of silk and the silk trade in Antiquity. Currently she is involved in the international European project *Reinventing Europeans through History, Art and Culture Learning* that is aimed at enhancing the skills of refugees as well as teachers and supporters of refugees through the learning opportunities provided by culture, the arts and history.

**Christina Katsikadeli** is Postdoctoral Researcher and Lecturer in general and historical-comparative linguistics at the Department of Linguistics and at the Center for the Research of Eastern Christianity (ZECO), University of Salzburg, Austria. Her research and teaching subjects are general and historical linguistics (Indo-European Studies, esp. Vedic Sanskrit and Greek), historical syntax, morphology and semantics, bi-/multilingualism, language change and contact, especially between Indo-European and Afro-Asiatic languages (Hebrew, Aramaic, Coptic), terminology and onomastics, historical lexicography, second language acquisition, and the history of linguistics. She has been co-worker (2000-2007) and project leader (2008-2009) at the *Rig Veda Dictionary* (RIVELEX, Vols. I-III) funded by the Austrian Research Fund (FWF). For the period 2014-2017, she is the principal investigator (“Elise-Richter-Fellow”) of the project *Hellemistic Koine in Egypt and the Near East*, also funded by the FWF.

**Naoko Kizawa** is interested in the historical use of organic materials such as wood, fibers and related technologies. Kizawa especially concentrates on that of wood. The study of wooden artifacts provides us with a lot of information about the tools used to make them as well as the development of manufacturing techniques. In Japan, a country rich in natural vegetation, many kinds of wood species have been used since the Jōmon (Neolithic) period to enrich human lives. It is significant to understand people's ideas concerning the use of wood and the surrounding environment throughout these remains. Naoko Kizawa and Mari Omura have been studying excavated combs from ancient East Asia, and comparing instances of combs excavated from Japan with those found in other countries, in the Korean Peninsula and in China. Moreover, combs were so popular to everyone that they could easily be carried by people from region to region. So it is possible to know about relationships between Ancient Japan and the surrounding areas by studying them.

**Götz König** is currently research associate at Ruhr Universität Bochum/Germany. He has studied Iranian Studies, philosophy, German literature. His work is mainly based in the field of Zoroastrian Studies and comprehends philological studies as well as research in the field of religion, literature and intellectual and cultural history. His current work is focused on the Xorde Avesta (its texts, translation, genesis and history), a history of rationality in Old Iran and a description of the Pahlavi literature as a reformulation of the Zoroastrian tradition under the influence of Greek philosophy.

**Agnes Korn** studied Indo-European linguistics in Hamburg and Vienna (MA thesis on the metrics of the Rigveda). After a year in Banská Bystrica (Slovakia) teaching German as a Foreign language and a position in Graz (Austria) on a lexicographical project in Persian, she moved to Frankfurt (Germany) to do a PhD in Comparative linguistics (thesis on the historical grammar of Balochi) followed by a "habilitation" on

Iranian linguistics. In 2015, she joined the CNRS in Paris as a researcher in linguistics; she is member of the research group *Mondes iranien et indien*. Current projects include the description of Iranian minority languages and their dialects (particularly Bashkardi and Balochi) as well as historical linguistics (grammaticalisation and modeling relations among the Iranian languages).

**Susanne Lervad**, PhD is visiting scholar and terminologist at the Centre for Textile Research at the SAXO institute at Copenhagen University. She is trained at the University of Southern Denmark and Université Lyon 2 (Centre de Recherche en Terminologie et Traduction) in specialized communication within the textile field, — especially weaving and the configurations of verbal and nonverbal representation of concepts in terminology. She has a series of publications in diachronic as well as synchronic aspects of textile terminology (see Dury, Lervad [2010], "Synonymic variation in the field of textile terminology", and Dury, Lervad & Nosch [2011], "Verbal and nonverbal configurations of textiles, a diachronic study"), and is co-editor of *Verbal and nonverbal representation in terminology, proceedings of the TOTH workshop 2013 at the DNRF's Centre for Textile Research in 2013* and author of the book's epilogue "Professional Nonverbal Communication in the field of textiles". Since 2007 project member of the textile terminological project [www.textilnet.dk](http://www.textilnet.dk), member of CIETA and the Danish and international networks of terminology: DANTERM, NORDTERM and the European Association of Terminology (EAFT). Owner of and terminology coach of the consultancy firm Termplus aps 2003.

**Felicitas Maeder** born in St. Gallen, Switzerland, in a family of former textile entrepreneurs – a fact that might have had some genetic implications. As an autodidact, she initiated in 1998 at the Natural History Museum Basel, Switzerland, the *Sea-silk Project* – with three goals: compiling an inventory of all objects in sea-silk still existing; tracing the history of this forgotten textile material, its production and processing; and the

documentation of the knowledge and the remains of this cultural heritage of the Mediterranean. Today the inventory includes more than 60 objects. They are presented online together with the biology of the fan shell and its fibre beard called byssus, the history and the production process of sea-silk in English, Italian and German ([www.muschelseide.ch](http://www.muschelseide.ch)). It includes also an extensive bibliography. In 2004 she curated the world's first thematic exhibition at the Natural History Museum Basel: *Muschelseide – Goldene Fäden vom Meeresgrund / Bisso marino - Fili d'oro dal fondo del mare*. The exhibition catalogue is the first illustrated monograph and completely bilingual, in German and Italian. In 2012, Felicitas Maeder received for her research an honorary doctorate of the Faculty of Humanities of the University of Basel, Switzerland. The main research topic lays now on terminological studies: What is the difference between the antique textile term byssus and sea-silk – often called byssus silk? And what were the terms given to sea-silk from Antiquity till late Middle Ages in different languages and cultures, at different times? Also the search for other sea-silk objects continues.

**Luigi Malatucca** is an Assyriologist. His focus is on the Neo- and Late Babylonian period and, in June 2016, he completed his PhD at the University of Naples “L’Orientale”. His work is entitled *Cultura materiale nella Babilonia del I millennio a.C.: L’industria tessile (Material Culture in First Millennium BC Babylonia: The Textile Industry)* and it is about Neo-Babylonian textiles in the textual evidence.

**Tove Engelhardt Mathiassen** is a curator at *Den Gamle By*, National Open Air Museum of Urban History and Culture, in Aarhus, Denmark. She is an expert on historical dress and textiles and has published extensively on these subjects. Engelhardt Mathiassen has organised a series of exhibitions on the cultural history of costume and dress: *Bride and Bridegroom, Wedding Garments for 250 years* (2004), *Maternity Clothing for 150 years* (2005), *Christening Clothes* (2006), *Festive*

*Dress 1909-2009* (2009), *18<sup>th</sup>-century shoes and accessories* (2012) and *Political knitwear and hot pants, dress and lifestyle in the 1970s* (2014). She is the co-author of ‘Costume in a Museological Context: Dealing with Costume and Dress from Modern Danish History’ (with Helle Leilund) in *Dressing the Past* (ed. M. Gleba, C. Munkholt and M-L.Nosch), Ancient Textiles Series 3, 2008. Co-editor of *Fashionable Encounters. Perspectives and Trends in Textile and Dress in the Early Modern Nordic World* (eds. with Nosch, M. Ringgaard, K. Toftegaard and M. Venborg Pedersen) and author of ‘Luxurious Textiles in Danish Christening Garments: Fashionable Encounters across social and geographical borders’, in *Fashionable Encounters. Ancient Textiles Series 14*. 2014. Since 2004 she has been the project leader of the textile terminological project [www.textilnet.dk](http://www.textilnet.dk) and co-author of ‘A New Danish Project in Textile Terminology: [textilnet.dk](http://textilnet.dk).’ (with Birka Ringbøl Bitsch), in *Verbal and Non-verbal Representations in Terminology. Proceedings of the TOTh Workshop 2013* (Eds. Lervad, S. et al.), 2016. Engelhardt Mathiassen is member of CIETA and ICOM Costume Committee.

**Francesco Meo** is an archaeologist, Adjunct Professor in the Department of Cultural Heritage at the University of Salento (Lecce, Italy). In 2011, during his PhD in Ancient History, he has been visiting scholar at the CTR in Copenhagen. He is the co-organiser of the International Workshop “Treasures from the Sea. Sea Silk and Shellfish Purple Dye in Antiquity” (Lecce, Italy - 26-28 May 2013) and of the VI Purpureae Vestes International Symposium “Textiles and Dyes in the Mediterranean Economy and Society” (Padua, Italy - 17-20 October 2016). In 2014 he was awarded the Italian National Prize on Archaeology of Production “FecitTe”. Since 2015 he is Professor of Archaeology of Great Greece at the University of Salento, Italy. Since 2016 he is the Scientific Director of the Muro Leccese Archaeological Project, a Messapian indigenous settlement in Southern Puglia Region — Italy, and member of the International Archaeological Mission



in Hierapolis of Frigia-Pammukale, Turkey. Last main publications: a monograph entitled *L'attività tessile a Herakleia di Lucania tra III e I secolo a.C.* (Rome 2015); co-editor of the book entitled *Muro Leccese. The Secrets of a Messapian Settlement* (Lecce 2016). His research aims at the study of textile production in Southern Italy between the Iron Age and the Roman Empire and of the changes of the Messapian society between the Iron Age and the arrival of the Romans in the mid-3<sup>rd</sup> century BC.

**Cécile Michel** is a historian and Assyriologist, Director of Research at the National Centre of Scientific Research (CNRS) in the *Histoire et Archéologie de l'Orient Cunéiforme* (Archéologies et Sciences de l'Antiquité) at Nanterre, and Professor at Hamburg University. She is a collaborator of the Centre for Textile Research (CTR) since 2005. Working on the decipherment and study of cuneiform texts from the first half of the 2nd millennium BC (private archives of merchants, state administrative archives), her main research interests are Mesopotamian trade, Upper Mesopotamian and Anatolian societies, gender studies, daily life and material culture (fauna, food, metals, textiles), calendars and chronology, history of sciences, education, writing and computing. Coordinator of the International Research Network (GDRI) *Ancient Textiles from the Orient to the Mediterranean* (ATOM, FR – DK – UK), she organized and published international conferences on textile terminologies (with Nosch, *Ancient Textile Series 8*, Oxford 2010) and wool economy (with C. Breniquet, *Ancient Textile Series 17*, Oxford 2014).

**Maria Mossakowska-Gaubert** graduated from the University of Warsaw. She is an archaeologist and a historian, graduated in Greek papyrology. Former assistant-curator at the National Museum of Warsaw, Department of Oriental Christian Art (1993-1999), she was an externally supported scientific fellow at the French Institut of Oriental Archaeology in Cairo – IFAO (1999-2003),

then associate researcher in the IFAO. Since January 2017, she is a Marie Skłodowska-Curie Fellow at the University of Copenhagen's Centre for Textile Research – CTR. Her current research focuses on the material culture of Egypt in Byzantine, and early Arab periods, combining the archaeological and iconographic data together with information derived from texts. She has a special interest in Egyptian monks everyday life: its economic, social, and religious aspects. She also continues as an active archaeologist and collaborates with many missions in Egypt as a specialist in glass objects. Maria Mossakowska-Gaubert has participated in many international and interdisciplinary projects, co-managing some of them and supervising the publication of their results (e.g. *La vie quotidienne des moines en Orient et en Occident (IV<sup>e</sup>-X<sup>e</sup> siècle)*; *Les moines autour de la Méditerranée : contacts, échanges, influences entre Orient et Occident de l'Antiquité tardive au Moyen Âge (IV<sup>e</sup>-XV<sup>e</sup> siècle)*; *Contextes et mobiliers. De l'époque hellénistique à la période mamelouke. Approches archéologiques, historiques et anthropologiques*).

**Stefan Niederreiter** has studied Historical Linguistics and German language and philology at the University of Salzburg where he worked as a teacher (2000-2015), project contributor (2000-2007) and project leader (2007-2010). He is currently working as a teacher for German Language and Literature at a commercial academy. His main research interests are Vedic lexicography and lexicology, etymology and syntax. Besides his contributions to the Rigvedic dictionary (RIVELEX, 2006, 2012), he focused on semantic fields in Indo-European and Vedic (cf. e.g. *Verba dicendi im Rigveda. Eine Wortfelduntersuchung im Altindischen*. Graz 2014; 'Vedisch *hári*- und Komposita'. In: *Akten der 40. Österreichischen Linguistiktagung*. Ed. by Thomas Krisch und Stefan Niederreiter. Innsbruck 2015 (IBS 150); 'Verba dicendi in den „magischen“ Hymnen des Rigveda'. In: *Akten des 1. Grazer Kolloquiums zur indogermanischen Altertumskunde*. Ed. by Michaela Zinko. Graz 2015).

**Marie-Louise Nosch** is a historian and the director of the Danish National Research Foundation's Centre for Textile Research (CTR) at the University of Copenhagen and the National Museum of Denmark from 2005 to 2016. She is a Professor in Ancient History in the University of Copenhagen. She was awarded her PhD by the University of Salzburg in 2000 with a thesis on Mycenaean textile administration in Linear B and has subsequently merged Linear B studies with experimental archaeology and textile tool studies; as director of the CTR, she has launched research programmes combining archaeology and natural sciences. She is author, co-author and editor of many works on Aegean Late Bronze Age textile production in the Mycenaean palace economies.

**Magdalena Öhrman**, University of Wales Trinity Saint David, is a senior lecturer in Classics. In 2016-2018, she is a Marie Skłodowska-Curie Fellow at the Centre for Textile Research in Copenhagen, where her project *Textile Reflections* examines multi-sensory representation of textile crafts in Roman literary sources, especially poetry. She is the author of *Varying Virtue. Mythological Paragons of Wifely Virtues in Roman Elegy* (Lund 2008) and has published on various aspects of Latin poetry, including its depiction of Roman textiles. Recent publications include 'From Calathos to Carmen: Metapoetics in the Story of the Daughters of Minyas (Ovid *Metamorphoses* 4)' in *Spinning Fates and the Song of the Loom. The Use of Textiles, Clothing and Cloth Production as Metaphor, Symbol, and Narrative Device in Greek and Latin Literature*, eds. G. Fanfani, M. Harlow, and M.-L. Nosch, Ancient Textile Series 24. Oxford, 285-295; 'Fake Farewells: The Elegiac Cast of Ov. *Trist.* 1.3', in *Latinet i tiden. En festskrift till Hans Aili* (Stockholm University), eds. E. Andersson, E. Kihlman, and M. Plaza. Stockholm, 427-438.

**Birgit Anette Rasmussen (Olsen)** is professor of Indo-European Studies at the University of Copenhagen. She completed her MA in Indo-European in 1978 and achieved the degree as dr.phil.

in 1999 for the thesis *The Noun in Biblical Armenian, Origin and Word Formation – with special emphasis on the Indo-European heritage* (Mouton de Gruyter: Berlin – New York, 1999). Her interests include all areas of Indo-European language and culture with particular focus on phonology and morphophonology, morphology, especially nominal word formation, etymology, the interface between language and culture and the linguistic basis for the reconstruction of Indo-European society. Her principal objects of research are Indo-Iranian, Greek, Latin and especially Armenian, most often with relevance for the Indo-European protolanguage as such. She has been centre leader of the interdisciplinary project *Roots of Europe – language, culture and migrations* (2008-13) and is currently heading the project *Individual, kin and family in pre-historic Europe – what words can tell*. Olsen is the author of three monographs and about 80 articles and book chapters, co-editor of 6 collected volumes and executive editor of the journal *Tocharian and Indo-European Studies*.

**Mari Omura** is interested in the historical use of organic materials. She has been focusing on fibers and textile technologies including archaic braiding techniques. Through previous research projects concerning the braids and threads taken from both plants and animals (such as cocoons, lotus, and sheep) the intercultural relationships between these materials and textile technologies from early stages began to be considered. To construct this paper, she was aided by the linguistic awareness gained through her upbringing in the countryside that some dialects contain old terms. An example of this is the term *gurumegi* which seems to have been derived from *kurumeku* or *kurubeku* was still used there as a term for 'ankle' in her childhood. The sound of this word seemed strange or odd to her although it is important in the wider context of textile terminologies.

**Louise Quillien** is *agrégée d'histoire* and has a PhD in Assyriology from the University of Paris 1 Panthéon-Sorbonne (France) on the topic *Textiles*

*in Mesopotamia, 750-500 BC, manufacturing techniques, trade and social meanings.* She is member of the Histoire et Archéologie de l'Orient Cunéiforme (Archéologie et Sciences de l'Antiquité) at Nanterre. She works on economic and social history of Babylonia during the 1st millennium BC, as well as on history of technics and material culture. She has a formation in history and epigraphy and is specialised in the reading of Akkadian language of the Neo-Babylonian period. Her research focuses on the history of textiles, mainly through the cuneiform texts, and also from the iconography, archaeological remains and textile imprints. In her PhD she studied the economic and non-economic circulations of textiles, the organisation of their production and their various uses in Babylonian society. The clarification of textile terminology is an important aspect of her research, because it is crucial for the understanding of the different aspects of textiles, the technics of manufacturing and the functions of textiles in the Babylonian society.

**Oswald Panagl** was trained as a linguist and in classical philology in the University of Vienna, Austria. His Habilitation was in 1976. He has taught linguistics in the University of Munich and University of Salzburg. His research areas include Mycenaean studies and historical linguistics, in particular etymology, semantic changes, syntax, historical grammar of the Indo-European languages (especially Greek, Latin, Germanic languages, Sanskrit, and Baltic languages). He is the editor of the conference proceedings *Die neuen Linear B-Texte aus Theben. Ihr Aufschlusswert für die mykenische Sprache und Kultur*, Wien 2006 (with S. Deger-Jalkotzy) as well as *Die frühgriechischen Texte aus mykenischer Zeit. Zur Erforschung der Linear B-Tafeln* (with S. Hiller), Darmstadt 1976.

**Anne Regourd** is Senior Researcher at the Department of Cross-Cultural Studies, University of Copenhagen, Denmark, and she is an Associate at the CNRS, France. She taught Arabic Epigraphy and Papyrology at the University of Vienna,

Institut für Orientalistik. She has publications in the fields of history and philology dealing with codicology, catalography, paper studies, papyrology, and epigraphy. She has worked extensively on Yemeni, and now Ethiopian, manuscripts.

**Kalliope Sarri** is a Marie Skłodowska-Curie Fellow 2015-2017 at the Centre for Textile Research, University of Copenhagen. She has studied history and archaeology at the University of Athens and obtained her PhD at the Institute for Prehistory and Proto-history of the University of Heidelberg. She is specialized in the Aegean prehistory, being particularly interested in settlement patterns, burial customs and pottery production. She has written a book (*Orchomenos in the Middle Bronze Age*, Munich 2010) and a series of articles on the Middle Bronze Age and on prehistoric pottery assemblages in the Aegean. Her second scholarly interest concerns textile archaeology and terminology and she currently investigates textile technologies during the Aegean Neolithic. Her on-going research project NETIA (Neolithic Textiles and Clothing Industries in the Aegean) is supported by the EU.

**Roland Schuhmann** studied Classics in Leiden, Indo-European and Classics in Gießen and Indo-European, Latin and Medieval Latin in Jena. Since 2000 he works as research fellow on the *Etymologisches Wörterbuch des Althochdeutschen*. Between 2005 and 2012 he was research fellow at the Lehrstuhl für Indogermanistik at the Friedrich-Schiller-Universität Jena and between 2013 and 2014 he worked as research fellow on the project *Reading and interpreting runic inscriptions: the theory and method of runology* at the Centre for Advanced Study in Oslo. Between 2015 and 2016 he is research fellow at the Department of German Studies and Linguistics at the Humboldt-University at Berlin. He has published articles on Germanic and Latin linguistics.

**Orit Shamir** is an archaeologist who wrote her PhD about *Textiles in the Land of Israel from the Roman Period till the Early Islamic Period in the*

*Light of the Archaeological Finds* and her MBA about *Textile Production in Eretz-Israel at the Iron Age in the Light of the Archaeological Finds*. Her area of specialization are textiles and related artifacts, basketry and cordage from Neolithic to the Medieval period in Israel. She is Curator of Organic Materials and head department of museums and exhibits, Israel Antiquities Authority. She supervised MBA thesis by Goldman Y., 2013, *Micro-RTI as a Means for the Documentation and Investigation of Textiles: An assemblage from Yoram cave, Judean Desert, as a case study*. M.A thesis. Haifa University. With Ravit Linn and Workman V., 2016, *Textile Finds from Timna and their Social, Historical, and Technological Implications for the Ancient Mining Community*. M.A thesis. Tel Aviv University with Erez Ben-Yosef. She published widely and participated at many conferences. The publications and conferences are listed at: [antiquities.academia.edu/OritShamir](http://antiquities.academia.edu/OritShamir).

**Elena Soriga** is an archaeologist and a historian of the Ancient Near East specialised in cultural ecology and economic anthropology. She was awarded her PhD in Ancient Near Eastern history by the University of Naples “L’Orientale” in 2016, with a multidisciplinary thesis entitled *Natural Resources of the Bronze Age Textile Technology. Economic, ecologic and symbolic role of the raw materials involved*. Her work focuses on the study of cuneiform texts dealing with natural resources and on the Sumerian and Akkadian terminology of raw materials in order to understand the actual practical use and ideological meaning of animal, plants and minerals in ancient economies and societies of the Eastern Mediterranean and Mesopotamia. Besides textiles and dye technology, her research interests include trade and maritime exchanges in Bronze Age Eastern Mediterranean, daily life and material culture like fauna and flora, foods and food practices, tools, medicine, cosmetics, and ornamentation as well as identity and gender studies. Her methodological approach combines philology, archaeology, iconography, linguistics, literary and religious studies

to bioarchaeology, natural sciences, experimental archaeology and ethnoarchaeology.

**Stella Spantidaki** is a Greek archaeologist specialising in Greek archaeological textiles. Her PhD, *Textile Production in Classical Athens*, published in 2016 by Oxbow Books, focused in textile production in Classical Athens. She is interested in interdisciplinary research combining fields such as ancient philology, ancient history, archaeology, art history, chemistry, biology and experimental archaeology. Since 2015 she is the Director of ARTEX, the Hellenic Centre for Research and Conservation of Archaeological Textiles in Athens.

**Maciej Szymaszek** is a postdoctoral fellow and project manager at the Department of Historical Studies, University of Gothenburg. He is principal investigator in the Swedish Research Council project *Tracing the provenance of ancient Egyptian textiles: Tove Alm’s collection* (2015-2019). He is currently editing a volume on the origins and histories of ‘Coptic’ textile collections and has forthcoming articles on the Nubian fabrics kept at the Oriental Institute Museum in Chicago and the Museum Gustavianum in Uppsala. His doctoral research has been focused on the so-called *gam-madia* signs found on Roman and Late Antique textiles. His monograph on this topic included an extensive catalogue of over 500 archaeological textiles and representations. He has published papers about the region of Tur ‘Abdin, pioneers of art historical research in Syria and Mesopotamia, visualizations of historical buildings, and textile terminology in the 1st millennium AD.

**Le Wang** is an Associate Professor at the College of Fashion and Design, Donghua University, Shanghai. She was awarded her PhD by Donghua University in 2009 with a dissertation on the silks discovered in Dunhuang. Her research focuses on history of textiles and costume. She is currently working on the topic *The Design and Cultural Exchanges Reflected by the Silks along the Silk Road from the 2<sup>nd</sup> Century BC to 10<sup>th</sup> Century AD*.

**Georg Warning** is an independent researcher based in Konstanz / Germany. His interests include languages and history, particularly of the area Anatolia – Iran – Caucasus. With a professional training in chemistry, he is likewise interested in botany and zoology, again with a focus on the historical perspective.

**John Peter Wild** studied Classics and provincial-Roman Archaeology at the Universities of Cambridge and Bonn, obtaining a doctorate for a dissertation on provincial-Roman clothing and textiles. Thereafter he was appointed to a post at Manchester University to teach Greek and Latin language, later archaeology, and remained in that university until retirement. His principal archaeological fieldwork has been in the Nene Valley (Peterborough, Eastern England) where he has directed excavations on a series of Roman pottery-production sites. His personal bibliography, however, reflects for the most part his research on aspects of archaeological textiles and textile manufacture across the Roman Empire.

**Feng Zhao** is the Director of China National Silk Museum, Hangzhou. He is also a Professor for history of textiles and costume in Donghua University, Shanghai. He received his PhD from China Textile University (present day Donghua University) in 1997. His main research is on the textiles along the Silk Road, especially based on the excavations. He focuses on the interdisciplinary research on science and technology history, art history and archaeology. As a director of China National Silk Museum, he also pay attention to the conservation of ancient textiles and the inheritance and innovation of traditional crafts. His publication *The General History of Chinese Silk* (editor in chief) was awarded the First National Publication Award for 2007 and *Chinese Silks* (editor in chief for the Chinese version) was awarded the R. L. Shep Ethnic Textiles Book Award for 2012.

# 1

## Textile Terminologies, State of the Art and New Directions

Salvatore Gaspa, Cécile Michel, Marie-Louise Nosch

The first published volume dedicated to the diachronic study of ancient textile terminologies gathered contributions on Semitic and Indo-European studies based on texts dated mainly to the 3<sup>rd</sup> and 2<sup>nd</sup> millennium BCE.<sup>1</sup> It provided a rich body of data and the first steps in elaborating a methodology of how to analyse textile terminologies and technologies according to various categories. Yet, it also highlighted the problems that were encountered in such studies. For example, some areas such as Greece, Italy, Anatolia and Italy are rich in texts providing numerous textile terms but do not yield many ancient textiles, which can be compared to the textile terminology. Likewise, other areas, such as Northern Europe and the Alpine region yield archaeological textiles but very few texts to document how the textiles were called.

Several technical words refer to ancient technologies, which are lost today, and thus difficult to understand for the modern scholar. The ancient vocabulary of colours and dye products is also often unclear to the modern reader. Moreover, translations of ancient texts do not always convey correctly the techniques and tools described in the texts, but rather reflect the philologist's poor understanding of textile techniques. Likewise, ancient (male) authors of high social and economic status did probably enjoy textile qualities but did not necessarily know the technicalities of manufacture, or chose deliberately to be vague about them for poetic purposes. It is therefore highly necessary to embark on more precise studies of textile terminologies, in order to be able to embed this body of knowledge into the understanding of the past.

This new volume includes 35 contributions by 41 experts, exploring a wide range of Indo-European languages, as well as Semitic, Sino-Tibetan, and Japonic languages, spoken and written down between the 1<sup>st</sup> millennium BC and the 1<sup>st</sup> millennium. They represent a unique and impressive amount of data; in addition, they offer many new approaches to textile terminologies and help to answer crucial questions concerning, among others, the nature of textile terminologies and their position and inclusion into languages, the characterisation of textile terminologies as specialised, technical language or fully integrated in the generalised language; the relationships between textile terms and technologies, geographical provenance, fashion, or social strata; the distribution and mobility of loanwords; the use of textile and garment terms in figurative language and metaphors.

The fields of textile terminology include terms for garments, fabric types, weaves, textile tools, textile craft professions, dyes and dye plants. Several authors draw inspiration and comparative data from iconography, chemical analyses of dyes, and modern ethnographic surveys.

The evidence presented in this volume forms a distinct geographical pattern. In the case of the textile terminological survey of the 3<sup>rd</sup> and 2<sup>nd</sup> millennia, most data stemmed from the Levant, Anatolia (Hittite, Kanesh), Egypt, Greece, and the Near East (Mari, Ebla, Mesopotamia), reaching back into India. In the present survey, the focus is re-positioned to the next two millennia, but in the 1<sup>st</sup> millennium BCE, the surveyed regions remain largely the same as in the 3<sup>rd</sup>

1. Michel & Nosch 2010.

and 2<sup>nd</sup> millennia BCE: the Near East covers most of our knowledge of textile terminology of the 1<sup>st</sup> millennium BCE (Neo-Assyrian and Neo-Babylonian palatial and private archives). Investigating this area is important in order to understand how Mesopotamian textile terms found their way in the ‘Age of the Empires’ and how this tradition developed during the 1<sup>st</sup> millennium BC thanks to the enlargement of commercial networks of Assyria and Babylonia and the cultural encounter that took place in these regions between the old Akkadian-speaking urban elites with groups originating from other regions of the Near East. The Hebrew sources represent another treasure trove over the millennia, and Greece makes a noticeable exception with its rich and diverse textual sources of the second part of the 2<sup>nd</sup> millennium BC, continuing into Archaic, Classical and Hellenistic cultures, and richly preserved, not in Greece, but in the Greek-speaking settlements of Egypt. Most of our knowledge of textile terminologies in the early 1<sup>st</sup> millennium AD also stems from Greek, as well as from Latin, but the provenance of these sources is to a very large part Egypt, and continues to be so for the late antique periods as well as the early Arabic inscriptions. Thus we encounter with textile terminology the same peculiar situation of selective conservation of texts as the selective conservation of textiles from the dry conditions of Egypt, and these sources frame and precondition our knowledge of antique and late antique texts — and textiles.

### **Textile terminologies as a segregated, specialized, technical language, or as part of the general language foundations**

The lexical field of textiles may sometimes follow its own rules, which interact with the development of languages. It is often very difficult to provide definitions of words related to textiles or even to classify them. In some ancient languages, generic terms are used for both textiles and garments, and it is not obvious to make a clear distinction of their functions. Modern textile terms do not necessarily match ancient terminologies, and thus it is necessary to retool classifications. Philologists today have the complex task of trying to understand and translate what is hidden behind words supposed to refer to specific materials, shapes, colours, uses, techniques, *etc.*

In a few cases, archaeology and the materiality of textiles can actually assist us in matching terms and textiles. In ideal cases, like the inscribed fabric sample from Fatimid Egypt studied by Anne Regourd and Fiona Handley, the textile itself states what it is and where it comes from. In other exceptional instances, textiles were buried together with inventory lists giving precise descriptions of the clothing items in the burial, and the burial was so well preserved that the garments themselves also came to light. Thus, Le Wang and Feng Zhao could compare a range of clothing terms with the archaeological clothing items, and identify, *e.g.*, the name of a purple jacket thanks to the textual records buried together with it and giving the inventory of the tomb excavated in the Ganzu province.

Several studies carried out on single textile and garment words show that they may convey many different meanings. Stella Spantidaki notes the ambiguity of several ancient Greek terms for textiles tools and fabrics, because of the polysemy of the language. In particular, the word *mitos*, which may have been the generic term for thread or yarn, or the specialised and technical term for linen thread used for heddle leaches. A similar observation is made by Peder Flemestad, Mary Harlow, Berit Hildebrandt, and Marie-Louise Nosch: in the *Edictum Diocletiani* of the years 301 AD some words refer to very specific tools, while others, like *acus*, carry multiple meanings, perhaps linked to its shape and multi-functionality.

When lacking specific terms to refer to some textile materials, qualities or characteristics, like colours, these can be expressed by paraphrases. Thus, according to Ines Bogensperger, the great varieties of purple dye qualities attested in the Greek papyri are rendered with the help of descriptive adjectives or additional nouns. Composite terms are also widely used to describe garments. Moreover, abbreviations of textiles appear in some ancient texts, and even if their meanings were obvious to the ancient authors, they are difficult to understand today, as noticed by Herbert Graßl.

### **Traditions and technological innovations through textile terminologies**

Languages reflect traditional practices and preference for certain materials, colours, shapes, *etc.* According to

Nahum Ben-Yehuda, Hebrew and Aramaic texts contain an extensive Semitic vocabulary referring to flax and linen suggesting that the production of linen textiles is indigenous and age-old in the region. Likewise, Omura and Kizawa explain that the ancient Japanese records focus entirely on bast fibres, pointing to a local vegetal textile product with a long history. Silk comes subsequently, introduced from China and accompanied by a new vocabulary to denote this novel animal fibre.

The identification of specific techniques behind textile terms may be challenging, as noticed by John Peter Wild and Kerstin Droß-Krüpe, when identifying the words for *taqueté* (*vestis polymita*) and tapestry (*vestis plumaria*) in Roman Egypt. In some cases, we can follow the transmission of a technique or its evolution. Indeed, the continuity of a technique is visible through the terminology of the professional craftspeople and their tools. Elena Soriga suggests that similar types of tools were used in the process of fulling, from the Near Eastern Bronze Age to the Classical Greek and Roman times. The only perceptible difference is linked to the raw materials involved in this technique, which are determined by the local ecosystems.

A radical change of vocabulary can be the result of a change of technology. Up to the middle of the 2<sup>nd</sup> millennium BCE, in Mesopotamia, sheep would shed their wool naturally, and the wool was plucked off the animals (*baqāmum*, *qaṭāpum*). Then, following the mutation of the animal, they had to be shorn (*gazāzum*), and Louise Quillien notices accordingly the appearance of iron shears in the texts; thus an indication of a double technological innovation, of new sheep breeds and iron tools. Progress in dyeing techniques is also observable with a growing variety of words to denote colours, as in the classical Armenian language studied by Birgit Olsen.

A section of this volume is dedicated to the textile terminology used by scholars in textile research, and the contributors conclude how important it is to be concise in the technical terms. The words we apply to archaeological artefacts, often borrowed from ancient languages, have an impact on their interpretation. According to Francesco Meo, circular loom weights from the northern shore of the Taranto Gulf dated to the 3<sup>rd</sup> and 2<sup>nd</sup> centuries BCE, which allowed the weaving of dense fabrics, were traditionally referred to by the word *oscillum*; but this term does not

convey the functionality of weaving and thus conveys a wrong meaning. Along the same lines, Felicitas Maeder follows the path and interpretations of *byssus*, from its Semitic origins, entry into Greek and Latin and its afterlife in varied and erroneous Biblical translations. Other words, depicting very specific types of decoration, can be transmitted in the long term with the same meaning, as noticed Maciej Szymaszek with the word *gammadia*, a right-angled motif, used since the end of the 1st millennium AD.

### **The terminology of fashion and decorations**

Toponymic designations of clothes are very frequent and yet often ambiguous since they can refer to many aspects linked to textiles' origin, techniques, decoration or fashion. The geographical origin of words may reflect the introduction of a foreign decoration technique, including new colours. Agnes Korn and Georg Warning notice the replacement in the book on the same line of the word corresponding to *kermes* (insect dye) used in the other books of the Old Testament by a term referring to an Armenian dye and the colour obtained by using it.

Words are transmitted or borrowed and can convey different meanings. When excavating textile terms in dictionaries and encyclopaedia, we perceive the geographic and diachronic deformation of their meaning; in some instances, a new meaning is applied to the word. Felicitas Maeder explains how the ancient Semitic word *byssus*, which denominated fine linen textile in antiquity, was used to designate sea-silk textiles in the 16<sup>th</sup> century, presumably because of their resemblance. Textile words thus change their meaning over time and also with the introduction of new fashions. Maria Mossakowska-Gaubert studies the Greek vocabulary for tunics in Egypt during the Roman and Byzantine periods: the construction of a new vocabulary accompanied the introduction of tunics with long sleeves and a diversity of the way to wear them.

### **Textile terminologies as an indicator of social status and origin**

The types of textiles documented by texts and images usually reflect high quality and luxury items, those worn by the court and elite members, or exchanged



as diplomatic gifts. They are made of expensive materials, like silk, which was always a luxurious fibre. However, during the Middle Byzantine period, according to Julia Galliker, the great variety of textile terms used in association with silk of a wide range of qualities suggest that silk had become widely available in Constantinople. A social distinction through the use of silk-based material was then made via the development of complex decorative weaving techniques.

Outside the realm of elite textiles, some texts, like the Roman marriage contract papyri from Imperial Egypt listing dowries, including women's wardrobes, give an idea of the garments worn by more common people; these are described by Kerstin Droß-Krüpe who notices a high proportion of red and yellow clothes. Another example is provided by Luigi Malatucca who explores the Neo and Late-Babylonian sources for evidence of ordinary people's clothing, and notes that this terminology is limited and often generic, referring to 'dress' and 'garment'.

### **Loanwords in the lexical field of textiles**

Textile terminologies are informative concerning contacts and influences between peoples, languages and areas through the use of loanwords. A variety of factors can determine the relation between a textile term and the referred item and, consequently, its meaning and later semantic developments, such as the socio-economic context where the item was fabricated, used or purchased, as well as the written practice and the prestige of schools and writers. Some text corpora are especially rich for such an investigation of cultural influences, like for example the rabbinic texts, which reflect traditions from the Late Antiquity Eastern Mediterranean. Nevertheless, as Christina Katsikadeli explains, the identification and interpretation of loanwords in these sources may be affected by the texts' transmission and their various manuscript editions.

The donor languages change according to the considered domain, and loanwords may be more present in specific lexical fields, as for example the one of textiles. In 1<sup>st</sup> millennium BCE Assyrian texts, according to Salvatore Gaspa, Aramaic textile loanwords attest to the presence of skilled Aramaic craftspeople in Assyria. Many of these terms were still in use in

the Late Babylonian dialect and this demonstrates the deep impact of Aramaic in the textile lexical field of the whole East Semitic area. Thus, the chronology of the transfers and borrowings is an important aspect to take into consideration as well as that of the cultural-historical contexts that determined them.

In many cases, it seems that loanwords come with the 'loan thing'. This could be the case for the borrowings observed by Peder Flemestad and Birgit Annette Olsen between Greek and various Italic languages, among which are Sabellic and Latin. The meaning of foreign words was not always obvious, even for those using them, as Miguel Ángel Andrés-Toledo explains concerning the name of a silk textile translated from Avestan to Pahlavi, which needed to be explained by the translator.

Roland Schuhmann demonstrates that the many textile loanwords in Old High German were borrowed primarily from Latin and Old French, and these textile loanwords arrive from the south and from the west into the Old High German area. It is worth noticing that the number of Latin and Old French loanwords increases gradually from the 8<sup>th</sup> and 12<sup>th</sup> century. Moreover, the borrowings belong to three specific semantic fields: new and previously unknown materials and their products, garments for clerics and cushions.

### **The symbolism of textiles and garments and the metaphors they generate**

Essential parts of human life are expressed in textile and garment expressions. A recent dimension of textile research is to explore the role of textile technology in the mental universes of the past, in cult, rituals, mythology, metaphors, political rhetoric, poetry and the language of the sciences. Expressions, such as urban *tissue*, the *fabric* of the universe, the *outskirts* of the city, the common *thread*, the time *warp*, the world wide *web*, all belong to the figurative and metaphorical language, which persists today. Also in the past, languages contained such references and they can be identified in a long literary tradition, from Sanscrit, to Greek archaic poetry and Ovid. Stefan Niederreiter has systematically outlined the metaphoric use of textile terminology in the Rigveda, a collection of sacred hymns from

ancient India composed in Vedic Sanskrit. Giovanni Fanfani demonstrates how the textile vocabulary and the vocabulary of music, performance and composition are interwoven, and Oswald Panagl surveys the symbolism in the semantic field of weaving, which by no means has become a dead metaphor but has remained productive from antiquity to the present day. Terms related to textiles constitute a powerful means of conveying religious ideas through sacred texts. Götz König's investigation focuses on those parts of the Avesta, the holy scriptures of Zoroastrianism, that describe items worn by priests and warriors along with other objects, showing how the components of the warriors' clothing were conceptualized as an armour and as offensive/defensive tools in the framework of the Avestan religious symbolism.

We can conclude that these metaphorical and figurative textile expressions are not merely stylistic tools but rooted in cognitive, terminological and experiential realities of the past. They inform us of technical terms, of textile practices in daily life in antiquity, and thus have a strong didactic and rhetorical value in ancient literature. Magdalena Öhrman highlights exactly this practical and tactile aspect of textile manufacture in her demonstration of how Latin poets use sound-play and the rhythm of weaving in their texts, integrated in the stylistic expression of poetic descriptions of textile work.

Another kind of textile terminology is related to the religious, social and legal regulations of clothing. Here Orit Shamir examines the concept of *sha'atnez* which regulates the forbidden blend of animal and plant based product in ancient Israel, including the forbidden blend of wool and linen. Her study also gives interesting insights into how these ancient religious regulations are followed in modern-day Jewish communities in a world dominated by synthetic fibres and characterized by a globalized economy.

Studying textile terms also leads us to the problem of classifying terms and *realia*. Since textiles circulating in antiquity and the techniques used to produce them have disappeared, it is necessary to continue the fruitful dialogue between all scholars with expertise in history, linguistics and material culture studies in

order to achieve a better understanding of the ancient textiles and their characteristics. This dialogue must also include textile craftspeople.

Classifications of textiles, textile-related materials and relevant terms are another important field highlighted in this volume. Starting with an investigation into the use of saffron as dyestuff in antiquity in the light of a recently discovered Lycian inscription, Peter Herz presents a classification of dyestuffs according to how these substances were produced, thus offering an interesting analysis of a relevant aspect of the history of ancient techniques and economic history.

The problems and the opportunities of a classification of textile terms are also highly relevant as regards the preservation of the textile lore of modern and contemporary societies, since traditional textile production and the relevant technical lore accompanying it are dying out not only in Western societies. Through the description of an important digital term bank and the discussion about how to classify textile-related terms and concepts, Susanne Lervad and Tove Engelhardt Mathiassen demonstrate how the combination of terminological studies and information technology can help scholars preserve and communicate the cultural heritage of words and expressions for clothing and textiles. Along similar methodological lines is Kalliope Sarri's paper, which presents a costume term database of 3000 years of the Greek language. The aim of this ongoing multi-thematic project is to collect Greek costume and other textile-related terms from all periods and regions of Greece. Such a multidisciplinary approach will be crucial in illuminating social aspects of clothing production and dress codes in former periods of Greece and the Eastern Mediterranean area.

With the exploration of textile terms we have highlighted an important aspect in textile terminological investigation: that of transmitting the cultural heritage of past civilizations' textiles to academic and non-academic audiences, an objective that can be achieved only through interdisciplinary approaches, the involvement of specialists from different fields, and new contexts of scholarly interaction and discussion.



# A Diachronic View on Fulling Technology in the Mediterranean and the Ancient Near East: Tools, Raw Materials and Natural Resources for the Finishing of Textiles

Elena Soriga

**A**mong the operations required in the overall cycle of the ancient production of textiles, Greek and Roman sources refer to the fulling of woollen fabrics as the most complex and expensive technical process performed both in the 1st millennium BC and the 1st millennium AD. Indeed, the finishing of woollen clothes needed a large amount of time, energy and labour, as well as involving the use of specialized skills and costly raw materials. Fulling fulfilled two functions that were necessary for the proper finishing of cloth, namely the scouring and consolidation of the fibres in the fabric. Woven cloth straight from the loom has a rather open, loose texture and the woven threads needed closing or tightening. The fulling process was intended to consolidate and thicken the structure of the fabric by matting the fibres together more thoroughly and by shrinking them. Thus the process transformed the cloth from a loose 'net' of threads into a compact, tight, textural whole. This is why in ancient economies, fullled textiles, proof against water and the wear inflicted by weather and time, were considered among the most luxurious and prestigious of fabrics.

Textual, iconographical and archaeological evidence from the Greek and, especially, Roman civilizations provide together quite a complete picture of the procedures, the tools and the raw materials involved, with special emphasis on their natural and geographical origins.<sup>1</sup> In contrast, for pre-Classical fulling, archaeological and epigraphical evidence on the technical phases in the finishing of textiles are unfortunately very scanty, deficient and often of doubtful interpretation. This situation applies to Mesopotamia too. Here the earliest cuneiform texts related to the finishing of woollen textiles date back to the end of the 3rd millennium BC, while seals and sealings representing scenes of fullers at work attest the presence of this technology even around the middle of the 4th millennium BC according to some historians.<sup>2</sup> In fact the terminology of the cuneiform texts limits itself to the name of the textile workers involved, the woollen fabrics undergoing the different operations, and a few raw materials, but they do not describe how technical operations were carried out and the sources of the materials the fullers utilized. Therefore, the study of natural resources mentioned

1. Zawadzki 2013. See in general Flohr 2013; Forbes 1956, 80-89; Singer *et al.* 1962, 216-221.

2. Algaze 2008, 81, 85, 86 and figs. 14, g-h provides as evidence of that seals and sealings of the Uruk periods (ca. 3500-3200 BC). Nonetheless, these iconographical data constitute only a circumstantial evidence because the representations of the men at work are ambiguous: they are interpretable as tanners or other artisans not engaged in textile manufacturing. The first evidence in support of the hypothesis of activities for finishing wool fabrics in Bronze Age Mesopotamia is some Early Dynastic Period texts dated to the middle of the 3rd millennium BC. See also Peyronel 2004, 72.

in 1st millennium Classical texts is extremely useful: it helps first to close the loopholes in both earlier and contemporary cuneiform documentation, and then to better understand the economic and cultural role played by specific plants, animals and minerals belonging to the Near Eastern ecosystems before the advent of mechanized fulling. Several scholars have stressed the substantial uniformity of the technology of fulling, whose procedures and raw materials remained unchanged from Classical antiquity until the end of the Early Middle Ages, when the fulling of cloth was carried out in a textile water mill.<sup>3</sup> It is hence believable that even before the 1st millennium BC Near Eastern fullers were exploiting the same or analogous natural resources for cloth-making, using them in the finishing of woollen fabrics in the same technical operations.

Therefore, this present research employs 1st millennium BC and AD sources to draw an ethnographic parallel with the fulling operations, tools and raw materials recorded in Near Eastern textual documentation during the two previous millennia. Sumerian and Akkadian terminology linked to technical procedures, but also to the names of plants, animals and minerals occurring in the cuneiform texts concerning the finishing of woollen textiles, will be analysed in the light of the historical and anthropological comparisons with the Greco-Roman world. This should reveal new or overlooked aspects of the Mesopotamian and Near Eastern fulling as performed in the Bronze and Iron Ages.

### **Terminology and technology. Names of procedures, tools and textiles**

Archaeological, iconographical and textual sources of the Classical times prove that the fulling of woollen

fabrics had its own *chaîne opératoire*, entailing the performance of consecutive and different steps of finishing: washing, felting, rinsing and drying and often, but not always, raising, shearing of the nap and cropping of the resulting hair.<sup>4</sup>

Some of these technical operations are recorded by various cuneiform texts of the early 2nd millennium BC: a few tablets from the Old Assyrian city of Kanesh (modern Kültepe), in Cappadocia, and an Old Babylonian text, whose provenance remains unknown, provide very accurate instructions on how to full textiles.<sup>5</sup> These cuneiform texts demonstrate that many of the technical processes, as well as the greater part of tools and raw materials, required in Middle Bronze Age finishing of textiles were essentially comparable to those employed in the fulling of woollen cloth during the Iron Age and further described by Greek and Roman sources.

Nonetheless, the textual evidence of some techniques is sometimes ambiguous because several verbs exist to describe common processes occurring in diverse finishing treatments. For instance, the *washing* of fabrics was conducted by fullers in many different tasks: in the scouring and the rinsing of the woollen textiles intended to be fulled, in the ordinary cleaning of soiled garments, in the bleaching of linen items and finally in the partial or comprehensive restoration of damaged fabrics.<sup>6</sup>

This indistinctness in terminology applies too to the very occupational name of the fullers themselves and thus on the how the technical processes they performed was known. Indeed, the elusive nature of the ancient fuller's work has already been often stressed by eminent scholars who intermittently have translated this occupational name as 'laundryman', 'bleacher' or more simply as 'finisher' or 'textile worker'.<sup>7</sup>

3. Uscatescu 2010. Around the 10th century AD, Muslim engineers invented water-powered fulling mills and introduced them throughout the Mediterranean area. See also Peyronel 2004, 73.

4. Smith 1875, 551-553; Flohr 2013, 99-180.

5. For the Old Assyrian text TC 3/I 17, see Veenhof 1972, 104 and Michel & Veenhof 2010. For the Old Babylonian tablet AO 7026, see Lackenbacher 1982.

6. See Firth 2013.

7. Starting in the mid-3rd millennium BC, cuneiform texts mention a professional class of artisans engaged in the finishing of textiles. Since the Early Dynastic period, the Lexical lists record the Sumerian ašlāg GIŠ.TÚG.(PI.)KAR.DU and <sup>lú</sup>azlāg/<sup>lú</sup>azlag as professional designations for the finisher of textiles. Cf. Lexical List Diri III (*ašlāku*) in MSL XV; see also discussion in CAD A/II, 447

It is well known that being derived from cellulose, flax lacks scales and thus its fibres are not able to felt. Nonetheless, from the end of the 3rd millennium BC, cuneiform texts list, among the textiles delivered to the fullers, cloths marked with the determinative for linen.<sup>8</sup> Vocabularies and lexical texts equate the term *ašlāku* ‘fuller’ and the writing LÚ.TÚG.UD, used since the 1st millennium BC by Neo-Babylonian texts to denote exclusively the craftsmen entrusted to whiten new and used linen (LÚ *pūšāyu*).<sup>9</sup> The occupational name *pūšāya* (LÚ.TÚG.BABBAR) ‘launderer’, linked with the term *pešû* (BABBAR) ‘white’ but also ‘clear, shining’, actually occurs only in the Neo-Assyrian and Neo-Babylonian texts concerning the working and finishing of linen and not before.<sup>10</sup> It seems thus reasonable that among his many offices the *ašlāku* was originally in charge of the bleaching of linen and the ecru wool either through the use of fuller’s earth or glassworts dissolved in lye or by treating them with sulphur vapours. Moreover, mineral and vegetal alkalis can be useful also to brighten and to freshen the dyed textiles that have faded due to sulphur or

to the caustic action of the lye.<sup>11</sup> During the 1st millennium BC, as the availability of flax in Mesopotamia increased, this specialization became more significant until it was separated and identified as a profession apart, namely the *pūšāya*. The issue remains still controversial but there is no doubt that the equivocation of the occupational terminology is due both to the wide range of activities performed by the fullers and to the lack of information about the raw materials and tools used in their activities.<sup>12</sup>

Moreover, there is evidence of a metonymic use of some verbs, where a single operation within the overall finishing process is used to indicate the complete process of the fulling of woollen textiles. This latter suggestion is confirmed by the original meaning of the two verbs used in the ancient Greek terminology to indicate the work of the fullers: *πλύνω*, reserved for linen, means ‘to wash, to clean, to scour’, whilst *κναφεύω*, used with reference to the woollen cloths, means ‘to tease, to raise, to card’. Yet, both verbs mean *lato sensu* ‘to full, to launder’. Similarly the Latin *carmino* ‘to card the wool’, and related to *carmēn*, ‘carding, wool comb’, means also ‘to soak

---

sub *ašlāku*. Both terms are equated with the Akkadian *ašlāku* ‘fuller’, a calque of the latter Sumerian word. Cf. LEX/ED IIIa/Fara azlāg SF 070 o iii 7; LEX/ED IIIb/unknown azlāg; Early Dynastic Lú E, 33. See also Lackenbacher 1982, 137: “On traduit parfois LÚ.ASLAG = *ašlākum* par «blanchisseur» ou «fouleur», mais certains auteurs ont déjà souligné qu’une traduction plus vague comme «travailleur du textile» serait bien préférable, car les tâches de cet ouvrier sont plus étendues que celles que désignent ces deux termes”. With regard to the fulling terminology in the Middle Assyrian texts, Postgate (2014, 408) states: “I know of no Middle Assyrian terminology which would refer to the fulling (fouler, walken) of cloth. The one reference to ‘fuller’ (written lú-túg) is in the law code (fragment M), and he here appears more to be concerned with cleaning of an already manufactured garment, than with an interim stage in the production of cloth”.

8. Waetzoldt 1972, 155.

9. CAD A/II, 447 sub *ašlāku*.

10. CAD P, 538 sub *pūšāya* ‘launderer’. The *πλυνῆς* ‘washers’, recorded in a stele of the 4th century BC found in a stadium of Athens, were entrusted with tasks analogous to those of the Mesopotamian *pūšāya*. In the Roman world, the corresponding term for the *pūšāya*-profession was the *nacca*. These occupational names designate fullers skilled in scouring and whitening linen, whereas the Akk. *ašlāku*, Gr. *κναφεύς* and Lat. *fullō* indicate fullers engaged chiefly in wool-cloth treatments.

11. CAD P, 538 records few passages in the text where the activity of the *pūšāya* concerns some wool items. GCCI 1 145:4 records the delivery of wool to a ‘launderer’ for a handiwork (*ana dullu*); in UCP 9 103 No. 41:6 the *pūšāya* receives instead one mina of green-yellowish wool (SÍG *ḥašašti*), besides two minas and 15 shekels of a sail.

12. With regard to this, the greatest part of terminological information is supplied by some cuneiform texts of the early 2nd millennium BC. The recensions B and D of the Old Babylonian series Lú known as <sup>lú</sup>a zlāg = *ašlāku*, lists a huge number of occupations, whose greatest part is otherwise unknown in contemporary texts; therefore these names have been interpreted as a roll of the numerous activities of the fuller’s craft (Sum. *na m - azlāg*; Akk. *ašlākūtu*) rather than different professional designations. See MSL XII, 158, 177, 204; MSL XII, 151: “The name of professions listed in OB Lu designates usually the performer of specific tasks within a given profession (examples of this are the *azlāg*-group in Rec. B I 1-21...)”; see Lackenbacher 1982, 137. The comparison of <sup>lú</sup>a zlāg = *ašlāku* with tablet XIX of the series HAR-ra = *ḥubullu*, a lexical text concerning the names of textiles, enlightens the different technical operations concerning washing, thickening, teasing, carding and cropping of wool textiles, whose names are recorded in contemporary and earlier cuneiform texts dealing with the production of cloths by fullers.

linen'.<sup>13</sup> Such an overlap between different technical operations belonging to subsequent stages of the same *chaîne opératoire* is attested also in the Bronze Age cuneiform texts where, for instance, Akkadian *mašādu* is alternately translated 'to full a cloth, to finish a wool textile' and 'to comb' because of its relation with *muštu* 'comb'.<sup>14</sup> Thus, in my view, the verb *mašādu* has a metonymic function: it can be used to indicate the operation of the fulling in cases when the woollen item is intended to be "combed" with brushes and teasels in order to raise the nap.<sup>15</sup>

### Terminology of finishing treatments and technical operations

#### *Washing cloths*

Washing was instrumental not only in cleaning the fibres by eliminating oils, dirt and other impurities but also, as has already been said, in consolidating and thickening the structure of the fabric. In ancient Greece and Rome, textiles were immersed and then scoured in a hot solution of water and a lump of some fatty or chemical substance with alkaline, bleaching or absorbent and degreasing properties. This soapy lye, named in Greek *κοψία* 'dust, ashes, chalk, lime white-wash, lye, gypsum' (from *κοψιάω/κοψιάζω* 'to sprinkle with ashes/to plaster with lime') and in Latin *lixa* or *lixivium* 'ashes, lye' (from *ēlixo* 'to boil, to drench

in hot water') was rubbed on the surface of the fabrics in order to felt together the threads of the weave, give thickness and strength to the fabric and thus increase its waterproofing properties.<sup>16</sup> The connotation of the 1st millennium BC terms for 'lye' (Gr. *κοψία*; Lat. *lixa/lixivium*) as dust, ashes or lime suggests that these detergents were obtained in the form of powder from sources of alkali (sodium- or potassium-carbonates) belonging to the mineral or vegetal kingdom.<sup>17</sup>

Bronze and Iron Age cuneiform texts attest the occurrence of mineral powder and vegetal ashes among the raw materials used by Near Eastern fullers to wash the woollens intended to be fulled, the linens to be bleached and the soiled garments that needed to be simply cleaned.<sup>18</sup>

The alkaline ash, earth or ground preparation was put in a vat with boiled (still hot but not boiling) water together with the fabrics and vegetal oil or animal grease or, more likely, was mixed with these fatty substances until it reached the form of a homogeneous paste and then rubbed on the textiles soaked in hot water.<sup>19</sup> This last suggestion is supported by a lexical text dating back the mid-2nd millennium BC where the Akkadian verb *sēru* (Sum. ŠÚ, šu-ùr) 'to rub down, to plaster, to cover with a clay slip' is listed in a group with other two verbs describing two major tasks mastered by the fuller: *mēsu* (Sum. LUḪ) 'to wash, to clean' and *kabāsu* (Sum. GIRI US) 'to step upon, to full cloth'.<sup>20</sup> Thus, as well as the Greek

13. Smith 1875, 553; Rocci 1516, *πλύνω*: 'lavo, risciacquo; netto lavando'; Rocci 1058, *κναφεύω*: 'scardasso, cardo, lavo i panni, fo il lavandaio' most likely derived from *κνάω* 'to scrape, to scratch, to tear'. IL, 151, *carmino* 'cardare la lana' e 'macerare il lino', see Pliny, NH 9, 134 and 19, 18.

14. For *mašādu*, see the above-mentioned Old Assyrian text TC 3/I 17, 12-14 and 19-22 in Veenhof 1972, 104 and in Michel & Veenhof 2010, 249-252. In his first edition of the text, Veenhof (1972, 106) prefers to translate *mašādu* 'to comb, to tease', linking it with the substantive *muštu* (Sum. <sup>g</sup>ga-ríg) 'comb', but AHw 687a he rejected this etymology. Waetzoldt 1972, 116 mentions also the <sup>g</sup>ga-ríg-ak with the meaning 'carding comb'. Michel & Veenhof (2010, 249) translate the verb with the original meaning 'striking/biting' and reject the translation 'to comb' since *mašādum* "is applied to wool and hair, not to a fabric".

15. A metonymic use of *mašādum* was proposed first by B. Landsberger (1965, *OLZ* 60, col. 158, on no. 299) in Michel & Veenhof 2010, 252. Regarding this, Veenhof (1972, 106) states: "K. Balkan presents Landsberger's ideas on this terminology. He warns one to distinguish between similar treatments applied to the wool, the threads and the woven tissue. In the latter case the subject of the present letter - he distinguishes three treatments: a) *mašādum*; b) *mašārum*; c) *qatāpum*" and n. 179.

16. Fosbroke & Lardner 1833, 342-345; Aristophanes, *Batrakhoi*, 712.

17. Levey 1959, 125-129; Forbes 1965, 140-141; Waetzoldt 1972, 159.

18. Waetzoldt 1972, 172; Zawadzki 2006, 61-65; Firth 2013.

19. Waetzoldt 1972, 159; Waetzoldt 1985, 83-86; Rougemont 2011, 374-375; Firth 2013; Quillien 2014, 285-286.

20. Erimḫuš = *anantu* II, 42-44 in MSL XVII, 28; MSL XVII, 1: "This series seems, like the similarly structured series Antagal, to aim less at analysing the various meanings of a Sumerian word (whether by contrasting it with other Sumerian words or by enumerating different Akkadian equivalents) than at collecting a set of words from one semantic field: synonyms, homonyms, complementary concepts (black/white), etc."

κονιάω/κονιάζω, the verbs *sêru* and *šu-ùr* describe the felting of the threads of the textiles with the aid of a cleaning powder or lump rubbed on their surface.<sup>21</sup>

### *Walking cloths*

In the fulling of woollen fabrics and cloth-making process, the next step is widely attested by textual and iconographical sources produced by the Classical civilizations. The soaked and soaped textiles were beaten, wiped off and wrung out by hand, pounded by cudgels or trodden by feet.<sup>22</sup> The detergents were pushed through the cloth and penetrated deep into the threads by the trampling of the fabrics and by their scrubbing. The microscopic barbs on the surface of the wool fibres hook together, making the textile softer, thicker and more resistant.<sup>23</sup>

A passage from the *Corpus Hippocraticum* describes the fulling of cloth as an alternation of trampling (λακτίζουσι), striking (κόπτουσι) and pulling (ἔλκουσι).<sup>24</sup> In the first half of the 3rd century BC, the Roman poet Titinius describes in his comedy *Fullones* the work of the textile craftsmen as *argutarier pedibus* ‘nattering, making a noise with the feet’.<sup>25</sup> Around the middle of the 2nd century BC, Cato the Elder described the Roman *fullones* engaged in all these operations.<sup>26</sup> Seneca described the movements of the fullers at work: with a certain amount of irony he likened them to dance steps (Lat. *saltus fullonicus*).<sup>27</sup> Contemporary archaeological and iconographical sources confirm the textual references. A fresco from

the fullery of Veranius Hypsaeus in Pompeii shows one fuller trampling clothes in a tub placed on the floor and three other workers scrubbing and wringing them to facilitate their felting (Fig. 1).

It is very probable that the actual fulling process was performed by trampling the soaped cloths throughout the Mediterranean and Near East long before the Roman period, though the little direct evidence collected so far does not clarify where and when this technique had its origin.<sup>28</sup> In the 5th century AD Horapollon, in his *Hieroglyphica*, mentions that the Egyptian symbol to indicate a fuller consisted of two feet in a tub filled with water.<sup>29</sup> At the beginning of the 2nd millennium BC, a Middle Kingdom depiction from Beni Hassan shows three textile workers standing in what seems to be a large vat, but it is unclear whether they were actually walking on the clothes.<sup>30</sup>

The philological study here presented on the Akkadian and Sumerian terminology in cuneiform texts related to the cloth-making process is able to demonstrate that the technique of fulling underfoot was performed by Mesopotamian fullers of the same period as the Egyptian picture of Beni Hassan. Old Assyrian and Old Babylonian texts dealing with the finishing treatments of different kinds of woollen textiles describe the fulling procedure by using the verbs *mašādu* ‘to press, to walk upon, to full cloth’, *maḥašu* ‘to strike, to weave’ and *kamādu* ‘to weave and prepare cloth in a specific way’.<sup>31</sup> The modalities of this ‘specific treatment of the cloths’ are disclosed

21. CAD S 227, sub *sêru*; Rocci 1071.

22. Moeller 1976, 20.

23. Flohr 2013, 101.

24. The use of the present tense emphasizes the continuity and alternation of the treatment, Flohr 2013, 100 and n. 12.

25. Titinius, *Ful.*, fr. X; Flohr 2013, 101; IL 97 sub *argūtor*: “fig. *argutarier pedibus*: saltellare”, ‘to hop’.

26. Cato, *De agri coltura* X, 5; XIV, 2; Hippocrates, *De diaeta*, I, 14.

27. Seneca, *Epistulae*, XV, 4.

28. Flohr 2013, 101 remarks that fulling with the feet was efficient “as the pressure a human can generate below his feet is much higher than that which he can generate with his hands”. Fulling with this technique was still performed until the early modern period and in some Mediterranean regions even over the last century such as in Crete where fulling by foot was done until the 1950-1960s (Doniert Evelyn, personal communication). Indeed mechanized fulling in water mills (Lat. *molendinum ad fullandum*; *molendinum fullonum*) did never fully replace the traditional foot-fulling carried out by physically trampling the cloths in tubs. In Anglo-Saxon countries and particularly in Scotland the cloth-making process was called walking/*waulking* still after it became mechanized. See Uscatescu 2010.

29. Nonetheless M. Flohr (2013, 101) states: “the symbol does not seem to be known from any hieroglyphic text”.

30. Forbes 1955, 84, fig. 3; Flohr 2013, 101.

31. Probably a difference in meaning distinguishes the tree verbs *kabāšu*, *mašādu* and *kamādu* but it is perhaps too subtle to have been



**Fig. 1.** Lower section of the fresco of the so-called *Pilastro dei Fullones* from the *fullonica* of Veranius Hypsaeus in Pompeii (House VI 8, 20-21.2), depicting some fullers busy to scour the cloths rubbing by hands and trampling on them. 1st century AD, Museo Archeologico Nazionale di Napoli (inv.nr. 9774 b). Photograph courtesy of Miko Flohr.

by the contemporary OB series *lú* where the *ka-mi-du* is described as *lú túg-šu-dúb-da* ‘the craftsman who strikes the cloth by hand’ or, more vaguely, as *lú túg-dúb-da* ‘the man who kicks/smites (*dúb* = *napāšu*) the cloths’.<sup>32</sup> Another Akkadian verb *kabāsu* ‘to step upon something on purpose, to trample, to walk upon, to make compact, to full cloth’ is related with the Biblical professional designation for fuller, the Hebrew *kōbēs*. That suggests that the technique of fulling by walking the cloths was common practice through the ancient Near East still during the 1st millennium BC.<sup>33</sup>

### ***Raising, shearing and polishing the nap***

Following the washing treatments, the soaked textiles had to be presumably rinsed, then wrung thoroughly and hung out in the sun or in a place with enough fresh air circulating through the textile.<sup>34</sup> These stages were essential tasks to be carried out before subsequent processes of the raising, shearing and polishing of the nap.

Several Roman frescos testify to the performance of these operation: the paintings from the House of the Vettii at Pompeii represents a cupid brushing a

understood by the ancient scholars, who were unfamiliar with the material world of textile production. It is, however, noteworthy that in TC 3/I 17 and in contemporary lexical texts, *kamādum* is directly followed by *qatāpum* ‘shearing’, thus overlooking the step of the teaselling, whilst, when *kamādu* is preferred to *mašādu* as in the case of text AO 7026, it is immediately followed by *mašārum* ‘teaseling’. Thus, I propose that the verb *mašādu* might denote a kind of synthesis of the two technical operations indicated by the verbs *kamādum* and *mašārum*. For a terminological study of the technical operations described by the verbs *kamādum* ‘fouillage à la main’ and *mašārum* ‘lainage’, see AO 7026 in Lackenbacher 1982. See also Michel & Veenhof 2010, 252; Veenhof 1972, 105-109. CAD K, 108, sub *kamādu* and 121 sub *kamdu* and *kāmidu*; CAD M/I, 71, sub *maḥaṣu*.

32. MSL XII, 177:13; 204:9.

33. CAD K, 5 sub *kabāsu*; see also the substantive *gabaṣu* ‘contraction’ (CAD G, 3) and the verb *kapāṣu* ‘to bend over, to curl’ (CAD K, 181).

34. The rinsing in fresh water was to wash the excess chemicals out and with them the greases and the lye’s stink they had released. Unfortunately, there is no evidence from Classical antiquity for this stage of the fulling process: rinsing is not discussed in literature,





**Fig. 2.** Upper section of the fresco of the *Pilastro dei Fullones* (9774 b) from the *fullonica* of Veranius Hypsaeus in Pompeii depicting textile finishers working in the *fullonica*; on the left a teaseler raises the nap of the cloth with a brush whilst a woman and a little girl inspect the processed textiles; on the right a man carries the *viminea cavea* and a bucket with sulphur or another bleaching substance. 1st century AD, Museo Archeologico Nazionale di Napoli, after De Albentis 2002, 137.

piece of cloth; the fresco from the fullery of Veranius Hypsaeus (VI 8, 20-21.2) depicts a fuller busy performing the same procedure (Fig. 2).<sup>35</sup>

Flohr, one of foremost authorities on Roman fulling, stated that these technical operations “seem to have belonged to the core business of *fullones*”.<sup>36</sup> Perhaps for this very reason, metonymic overlapping between the verbs describing the actual fulling (as performed first during the washing) and those related to the raising, shearing and polishing of the nap is found both in Bronze and Iron-Age texts. Classical texts report that fulled textiles were treated with gentle brushes or special combs named teasels (Gr. κνάφος; Lat. *aena fullonia*) able to raise the nap of the woollen cloth without damaging its weave. From the ancient Greek word κνάφος ‘teasel’ come the terms κνᾶφεῖον ‘fulling workshop; laundry’ and κναφ/γναφεύς ‘fuller’. This latter noun is descended from the occupational name Myc. *ka-na-pe-u* ‘fuller’ found in the Linear B tablets from Pylos and Mycenae in relation with sheep wool and not vegetal fibres.<sup>37</sup> This fact suggests that even before the 1st millennium BC, in the Aegean area, the raising, shearing and polishing of the nap of woollen textiles underwent a fulling process so important as to lend its name to the profession as a whole.<sup>38</sup>

In the ancient Near East, the textile terminology applied to some finished products provides evidence that the fulling of woollens included the performance of these following steps, at least since the end of the 3rd millennium BC. Among the different woollen items delivered to the fullers of the Ur III texts, the

nor is it depicted in paintings or reliefs. Regarding the drying, depictions of the fulling process from Pompeii, Ostia, Roma and Sens show clothes hanging out over beams. Seneca describes a fullo, ‘fuller’, as sprinkling water over a garment stretched out to be brushed in order to moisten it: this suggests that fulled textiles were usually dried before polishing. See Flohr 2013, 104-105 and 108-109. Ethnographical comparison with the fulling of pre-industrial Europe attests the importance of this practice: wet or damp woollens had to be dried in a place with a sufficiency of circulating fresh air, by hanging them over beams or spreading them out over a large wooden frame called a ‘tenter’ to prevent their shrinkage, as well as stopping the development of a rather unpleasant fusty smell. As noted by Quillien (2014, 286), in ancient Near Eastern religions, the (pleasant) smell of something in part denotes the god’s radiance. Thus fullers and bleachers often are recorded as recipients of aromatics and scented resins to perfume the clothes, thereby covering any residual stench of the chemicals used in fulling and dyeing processes.

35. Flohr 2013, 113-115 and Fig. 26 and Fig. 27.

36. Flohr 2013, 113.

37. PY Cn 1287, En 74/Eo 267, Eo 269; My Oe 129, Oi 701. See Del Frio *et al.* 2010.

38. Some tablets from Pylos testify to the importance of this profession in the Mycenaean world. One text records a man named Pekita, a craftsman from Cyprus, as fuller of the king (Myc. *ka-na-pe-u, wa-na-ka-te-ro*). See Palaima 1997. Pekita may be a nickname linked to the task performed by this craftsman: it is related to the Mycenaean *pe-ki-ti-ra*, the occupational name designating ‘female combers, carders’ and to the finished fabric named *te-pa pe-ko-to*, a very heavy wool cloth most likely first undergone to the thickening and fulling processes and then intended to be teased until reaching an hairy appearance resembling the sheep fleece (Myc. *po-ka*). Yet, with regard to the weight of the *te-pa pe-ko-to* textiles, Del Frio *et al.* 2010, 357 state: “How and whether this fact is technically related to combing is still an open issue”. The above-mentioned Mycenaean terms are all connected to the root *\*pkt-en* from which derive Lat. *pecten* and Gr. κρέτις ‘comb’ and πέκω ‘to comb’, whose meaning “in Mycenaean Greek therefore seems to cover both the treatment of wool and also a treatment of textiles” (Del Frio *et al.* 2010, 358).

túg guz-za is described as ‘a special fabric of flocky and shaggy texture’.<sup>39</sup> The tablets of Girsu prove that this fabric underwent the túg sur-ra and túg kin-DI-a treatments performed with oil and alkali and hence it can be considered a kind of fulled textile.<sup>40</sup> Furthermore, in the early 2nd millennium BC, túg guz-za (akk. <sup>tu</sup>gizzu) “*étouffe poilue ou rêche*” is the only type of textile qualified in the texts of Mari as bar-kar-ra or barkarrû, an adjective denoting a coarse waterproof fabric.<sup>41</sup>

Around the same time the Old Babylon tablet AO 7026 and a lexical text demonstrate unequivocally that the shagginess of the túg guz-za resulted from the raising of the nap of the cloth (Akk. *mašāru*) by the fullers with at least two different kind of teasels.<sup>42</sup>

The contemporary Old Assyrian text TC 3/I 17 gives the following instructions: “Let them full/comb/prepare for raising one side of the textile (*ša šubātīm pānam*); they should not shear it (*lā iqattupūšu*); its weave should be close (*šutūšu lu mādat*) ... the other side (*pānam šaniam*) one should full slightly (*i-li-la limšudū*). If it is still hairy (*šumma šārtam itaš ’û*), one should shear it (*liqtupūšu*) like a *kutānum*”.<sup>43</sup> The text records therefore the shearing of a formerly brushed side, perhaps the outer one, in order to clip the hair extracted by the teasels and to get an even and smooth surface. The verb utilized is *qatāpu* ‘to shear,

to crop’ rather than ‘to pluck’, found also in the series Lú as LÚ.TÚG.PA.KU<sub>5</sub>.RU/DU = *qá-ti-pu*.<sup>44</sup> In the Old Babylonian text AO 7026 the same procedure is performed in the finishing of the TÚG BAR.DIB (*nanbû*) and TÚG *šē-e-tim* under the name of *laqātum* ‘to gather, to pick up’, a verb sometimes written with the logogram KU<sub>5</sub>, which occurs in two different operations (*laqātum pānum* and *laqātum lā pānum*) performed on the surface of a fabric.<sup>45</sup>

These cuneiform texts demonstrate that many of the technical processes required in the Middle Bronze Age finishing of textiles were actually comparable to those described by Greek and Roman sources in the 1st millennium BC. Furthermore, túg guz-za, *kutānum* and other woollen fabrics produced by Mesopotamians fullers show several analogies with some thick, water-resistant woollen cloths still manufactured in Europe with traditional techniques as the *loden*, the *panno casentino* and the Sardinian *orbace*: these fabrics, renowned for their sturdiness and endurance, first undergo the shrinking and fulling treatments and subsequently are brushed with a fuller’s teasel; then the nap is cropped.

If the textile terminology of Bronze Age cuneiform texts provides evidence that the technical operations carried out by 1st millennium fullers and described by Classical sources were already performed in the

39. Oppenheim 1948, 32, G1 n.3; Waetzoldt 1972, 291.

40. Firth 2013.

41. Durand 2009, 35 and 99. Two texts from Mari (T.518: 4 and T.519: 4 in Durand 2009, 35) connect the túg guz-za with a cloth named túg *hu-ru-ru*. The name of this textile might be related to a technical procedure listed also in the contemporary AO 7026. In the Old Babylonian text, the finishing operation is closely linked with another (*nešûm u hurrurum*). Lackenbacher (1982, 142) translates the term *nešûm/našûm* “*racler, enlever en grattant et même arracher*” and *hurrurum* “*rayer, mettre (les fibres) parallèlement*”. The French scholar distinguishes the use of the D form *hurrurum*, applied to hair and fibres, from the G one *harārum*, whose primary meaning is ‘to dig’.

42. MSL XII, 177: 5-8; 204: 4-5; 194-195 in MSL X, 133; Lackenbacher 1982.

43. *šumma šārtam itas ’û kīma kutānim liqtupūšu* “if it (*pānam šaniam*) proves still to be hairy let one shear it like a *kutānum*”, in Michel & Veenhof 2010, 250-252. See also TC 3/I 17, 12-14 and 19-22 in Veenhof 1972, 104.

44. MSL XII 177: 14, 204: 10, Veenhof 1972, 106; Michel & Veenhof 2010.

45. Lackenbacher 1982, 144 rejects the translation of *laqātum* as with the meaning ‘to crop, to trim’ and thus as an equivalent of *qatāpu*, because the former verb is also found in a context of linen bleaching; she prefers to translate it as “enlever (les impuretés)”, considering *pānum* “une partie cousue et donc amovible” rather than one of the two sides of the cloth. Therefore, I suggest that *laqātum pānum* and *laqātum lā pānum* are detailed instructions to trim one side of the cloth and to leave the other without shearing, and thus that this is a parallel of TC 3/I, 17. Indeed, these two operations are both performed only on the surface of bar-dib sig MA IM TE NA, the *šubāt šetim* ÚŠ and bar-dib ÚŠ, whilst the different qualities of GUZ.ZA and the wool cloth named TÚG BAR.DIB SIG *lahāritum* had to undergo an alternative kind of teaseling named *šartum leqûm* “tirer pour (obtenir) le poil”. Since *šartum leqûm* is one of the last operations before the seizing (Akk. *puššuru*) of the cloth, in this step the hair has to be further brushed and curled. This finishing treatment of the cloth, is still performed in Italy where is named *rattinatura* and was carried out in Tuscany until recent times to produce the *panno casentino*; the hair of the inner side was merged into flakes, dumplings, knots and waves by rubbing and pressing them with a stone until an appearance similar to the animal fur was attained.

ancient Near East during the previous two millennia, then too the study of the raw materials and the natural resources involved in the cloth-making process can demonstrate how similar were the treatments of fulled textiles across the millennia.

### Terminology of natural resources exploited as raw materials and tools

#### *Minerals as alkali sources and detergents*

Among the mineral sources of alkali, natron (Lat. *nitrum*; Gr. νίτρον, λίτρον) was in ancient times the most coveted. It is a natural mixture of sodium carbonate, sodium bicarbonate and sodium sulfate along with small amounts of other salts (halite, sodium chloride), and was used to perform many different tasks. The use of natron was advantageous because it was found ready for use in nature: no further costs of extraction of the soda carbonates accrued, as was the case for other sources of alkali.

Even so, natron is found only in contexts with specific pedological and ecological conditions. The most famous provenances were localities in Egypt, where the word used was *ntrj*, ‘to be pure, clean’. Here, the flood waters of the Nile permeated the soil and, once evaporated, deposited incrustations of carbonates of soda.<sup>46</sup> Sodium carbonates used by Greek and Roman fullers had to be imported from far away and were thus rather expensive: during the Ptolemaic period, Egyptian natron formed an important state monopoly, proving that it was a very profitable business.<sup>47</sup> Strabo and Pliny report that in the period straddling the 1st century BC to the 1st century AD, natron (Lat. *nitrum*; Gr. νίτρον, λίτρον) was still imported from Egypt.<sup>48</sup>

During the 1st millennium BC the use of natron in

textile manufacturing is attested in Near Eastern textual documentation too: Neo-Babylonian and Neo-Assyrian tablets record the importation of natron (Akk. *nitiru/nitru*) from Egypt in abundance beside alum (Akk. <sup>na4</sup>*gabû*, *aban gabî*), another substance used in the finishing of textiles. In the Bible, natron (Heb. *neter*) is mentioned for its cleansing power alongside the *bōrît*-grass, a kind of soapwort used by fullers of the ancient Israel.<sup>49</sup>

Classical sources quote however fuller’s earth (Lat. *creta fullonia*) as the detergent *par excellence* used by fullers in textile laundering, whitening and presumably in cloth-making. Under this generic label are collected several mineral substances very different from each other in their sedimentological and chemical qualities. These soft clay-like materials, actually often derived from powdered rocks, share alkaline and smectic properties: once rubbed onto the fabric, they absorbed and removed the greases, imparting a lustre and brightness to the cloth.<sup>50</sup>

The variable amount of the component substances (iron, magnesium, alkaline metals, alkaline earths) naturally contained in these washing powders confers on them absorbent, cleaning and, eventually, whitening properties as in the case of the bentonite, montmorillonite, kaolinite and saponite ‘clays’.<sup>51</sup> In his *Naturalis Historia*, Pliny the Elder mentions several qualities of fuller’s earth (Lat. *creta fullonia*) that possess different properties and, consequently, different purposes.<sup>52</sup>

The most appreciated species of fuller’s earth came from the Eastern Mediterranean: straight after the first-rate ‘tobacco-pipe clay’ (Lat. *terra cimolia*; Gr. κίμωνία γῆ) from Kimolos in the Cyclades, Pliny mentioned the ‘clays’ from Thessaly and Epirus and those from the islands of Cyprus, Samos and

46. Brunello 1973, 44-45.

47. Brunello 1973, 44.

48. Brunello 1973, 44.

49. Oppenheim 1967, 243; Jeremiah II, 22; Malachi, II, 2.

50. Cf. Rougemont 2011, 375; Firth 2013, 140: “Although the wool would have been washed before it was spun, there would have been some residual natural oils in the wool. In addition, oil may have been used to lubricate the threads during weaving.”

51. Pliny, NH, 17, 4.

52. For instance, Pliny (NH, 35, 196) refers to the use of fuller’s earth from Sardinia (*creta sarda*) which was used with sulphur (*sulpur*) and employed in the cleaning or bleaching of white fabrics, Moeller 1976, 20; Robertson 1949.

Lemnos.<sup>53</sup> The first reference to the use of the kaolin gypsum from Κίμωλος is found in a comedy of Aristophanes and dated to the year 405 BC.<sup>54</sup> In the 4th century AD, a kind of mineral powder from the Cyclades is also mentioned by the *Papyrus Graecus Holmiensis*. Because of its ‘astringent’ and ‘caustic’ power, this mineral was compared to the alum used both in the tanning of skins and as a mordant in the dyeing of textiles; hence it was called *stupteriōdes gē* — Greek, “earth containing alum” — a denomination used by Aristotle, Strabo and Pliny some centuries earlier.<sup>55</sup>

In Mesopotamia, it seems highly likely that the identification of this mineral detergent should be with the raw material named in cuneiform texts <sup>na4</sup>im-bab-bár (Akk. *gašsu* ‘gypsum, plaster’), literally “white earth”, because since the end of the 3rd millennium BC it was delivered in large quantities to the fullers for the finishing of cloths.<sup>56</sup> At present, the sedimentological composition of this substance has not yet been elucidated, though the most recent studies have shown that this earth is probably not a kind of clay, but an alkaline powder obtained by crushing minerals such as limestone or chalk together with other cleansing substances like sulphur or another kind of mineral powder named <sup>na4</sup>im-sa<sub>5</sub> ‘red earth’.<sup>57</sup>

### *Vegetal detergents and sources of alkali*

The use of alkalis in the bleaching of linen and in glass and soap-making makes these raw materials important and expensive, especially when they were

imported from far away like the above-mentioned natron. There were other and cheaper sources for such. Classical sources refer to the use of stale urine: animal or human excrement undergoing the nitrification process on the way to becoming ammonia.<sup>58</sup> It is not clear where the *fullones* procured this matter for their workshops, whether from nearby stock-farms or even from the urban public toilets.<sup>59</sup> According to R. J. Forbes, “in ancient Mesopotamia, like in modern India, it [potassium nitrate used in glass-making] was obtained as an efflorescence of the soil in certain places where organic matter decayed (cattle yards and stables)” but no cuneiform text suggests a use of urine (Akk. *šīnātu*; Sum. *kàš*) in the washing or finishing of textiles.<sup>60</sup>

Therefore it is probable that alkalis were obtained from other sources in Mesopotamia before the introduction of Egyptian natron, and later again as its low-priced surrogate. Neo-Sumerian texts show the delivery of a great quantity of vegetable ashes, besides animal and vegetal oils, to the fullers of the city of Girsu for the túg šà-ha, túg kin-DI-a and túg sur-ra treatments of cloths.<sup>61</sup> Actually, the greatest part of the modern and ancient terms denoting soda or, more extensively, lye-wash, are in some ways linked with the incineration of vegetal matters and the resulting cinders. For instance, the English *alkali*, a modern synonymous for *potash* ‘vegetal lye made by burning wood to ashes in a pot’, derives from the Ar. *al-qalīy* ‘calcined ashes’, in its time related both to the Akkadian verb *qalū* ‘to burn, to roast’ and with the term *qīltu* used in Neo-Assyrian tablets to indicate both the

53. Rocci 1718 sub στυπτηριώδης; Pliny, NH 35, 195-201.

54. Arist. *Batrakhoi*, 713. See Robertson 1949.

55. Healy 1999, 286; the adjective *stupteriōdes* used to denote this kind of earth indicates it was ‘alum containing’ or ‘astringent’.

56. Firth (2011) carried out an accurate analysis on the sedimentological and chemical properties of the different candidates proposed for the identification of ancient fuller’s earth, determining the use of the <sup>na4</sup>im-babbar<sub>2</sub> and its usage by the fullers in the Mesopotamian textile industry; Firth 2013, 146.

57. See Firth 2011. CAD G, 54 sub *gašsu*. Note that Pliny (NH, 35, 195) with reference to the *creta cimolia*, in Roman times the most generally used type of fuller’s earth, distinguished too between a white (*candidum*) and a reddish (*ad purpurissum inclinans*) variety.

58. Pliny, NH 38, 66, 91 and 174; Moeller 1976, 13, 20 and 96; Flohr 2013, 103-104.

59. Martial, VI, 93; Moeller 1976, 20; *contra* Flohr 2013, 171: “Thus, on closer inspection, there is no literary evidence for public urine collection by fullers”.

60. Forbes 1965, 181. Once dissolved in boiled water and washed and refined for days this mixture of salt and saltpetre gave some crystals of an alkaline mineral (Akk. *mil’u* and *anzahhu*) used in the glass-making.

61. Waetzoldt 1972, 172; Firth 2013.

lye and the plant from which alkaline ashes were obtained during the 1st millennium BC.<sup>62</sup>

It seems likely too that the Biblical *bōrīt*, the ‘vegetal ashes’ obtained by burning a grass or bush named *gasūl*, and used by fullers of ancient Palestine to prepare the lye and to clean clothes, has to be related to the Heb. *bārar* ‘to purify, to cleanse’ and to the Spanish word *barrilla* and its anglicization *barilla*, a term used since the Middle Ages to denote soda ash and saltworts, glassworts and seaweed, plants that contain widely varying amounts of sodium carbonate and some additional potassium carbonate.<sup>63</sup> In fact, only a few centuries ago, the chief source of alkali consisted of some prickly plants growing by the sea or in saline localities such as salt marshes and commonly named glassworts or saltworts (*Salicornia* spp., *Arthrocnemum* spp., *Halocnemum* spp. *Salsola* spp. and *Kali* spp.). When dried and burnt, these succulent and halophyte plants, mostly belonging to the *Amaranthaceae* family (Fig. 3), produce the best alkaline cinders used in soap- and glassmaking and in bleaching linen.<sup>64</sup>

In the Eastern Mediterranean and Mesopotamia *Salicornia europaea*, *Salsola soda*, *Salsola kali*, *Kali tragus* and *Halocnemum strobilaceum* grow along the brackish swamps, in the saline semi-deserts and obviously nearby the seashores.<sup>65</sup> A philological analysis of the terminology actually highlights the link between the term for alkali (Sum. <sup>na</sup>4naĝa; Akk. *uḫultu/uḫūlu*; Hitt. *ḫas(s)*) to some plant species grouped under the hypernym Ú.NAGA/ <sup>u</sup>teme ‘saltwort, alkaline plant’.<sup>66</sup>

Lexical lists of the 2nd millennium BC record among these the *šāmiṭu*, *mangu* and *qaqqullu* plants,



**Fig. 3.** On the top: *Salsola kali* and *Salsola herbacea*. *Salicornia rudicans* in En. Bot. 1180, 1183, 1868. On the bottom: Uruk sealing with a possible representation of a prickly saltwort, likely belonging to *Salsola* sp. After Liverani 1988, 137, fig. 25-3.

though the plant mostly quoted in glass-making is the *uḫūlu* -plant (Sum. <sup>u</sup>naĝa).<sup>67</sup> The ashes from the *uḫūlu* can be found mixed with oil, fuller’s earth or alum according to the use.<sup>68</sup> Sometimes the texts qualify *uḫūlu* with the epithet *qarnānū* (SI) ‘sprouted’; the relation of the term with the Akk. *qarnu* ‘horn’ could support the identification of *uḫūlu qarnānū* (Sum. Ú.NAGA SI/ <sup>u</sup>naĝa-si-e<sub>3</sub>) as a species belonging to the *Salicornia* or *Salsola* genera, characterized by plants with succulent branches similar to horns (Fig. 3).<sup>69</sup> Another species of saltwort could be denoted by the phytonym *qīltu* that in 1st millennium BC denoted a soda plant and its derived lye. Indeed,

62. CAD Q, 252 sub *qīltu*. In the Mari texts the term *ammidakku* perhaps refer to a kind of lye used in the early 2nd millennium BC for the purification of metals, CAD A/II, 75 sub *ammidakku*. Differently from *qīltu* it is not sure whether *ammidakku* is made from vegetable ashes, CAD A/II, 75 sub *ammidakku*.

63. Malachi III, 2; Jeremiah II, 22. See Forbes 1955, 179-180; Forbes 1965, 140-141; *contra* Brunello 1973, 54 who, though, refers to the use of *Salsola kali* among the fullers of ancient Palestine, and interpreted *bōrīt* as a botanical term and not as vegetable product. Moreover, he identified it with the common soapwort (*Saponaria officinalis*).

64. Levey 1959, 128; Brunello 1973, 54; Moorey 1999, 212.

65. Levey 1959, 122 uses the old nomenclature *Salsola kali* “the soda plant, grows near the Dead Sea today and is common in Syria, Egypt and Arabic”; see CAD Q, 69 sub *qalū*.

66. Forbes 1965, 141.

67. See CAD S/1, 313 sub *šāmiṭu*; CAD M/1, 211 sub *mangu*; CAD Q, 124 sub *qaqqullu*.

68. CAD U-W, 48-50 sub *uḫūlu*.

69. CDA, 419 sub *uhulu(m)*: NB also *uḫūlu*, Ug. *uhunu* m. & f. (an alkali-rich plant) ‘potash’, Bab. [(Ú.)NAGA]; as mineral; for soap; in glass recipe; esp. *u. qarnāti/qarnānu* [(U.)NAGA.SI] ‘*Salicornia*’ and similar plants for glass, drug. See CAD U-W, 49 sub *uḫūlu* d; CAD Q, 134 sub *qarnu* and 133 sub *qarnānū*.



**Fig. 4.** Plant belonging to the wild thistle's group (*Carduus* sp.), photo by Elena Soriga. Its possible representation appears in a scene of sheep shearing from a Middle Assyrian seal, 13th century BC, after Liverani 1988, 595, fig. 110-4.

the term could be linked both to the verbal adjective *baqlu/baqiltu* 'sprouted, horned', and to its staple product, the burnt material (Akk. *qilûtu*; Sum. *gibîl KI.NE*) used as alkali.<sup>70</sup>

On the other hand, the soda plant named *uḫultu* (Ú AN.NU.ḪA.RA) is never qualified as sprouted; it produces a salt quoted in the texts as *aḫussu* or *alluḫaru/annuḫaru* used also in tanning of skins and as a mineral dye or mordant to produce a white colour.<sup>71</sup> In Mari texts, dating back the beginning of 2<sup>nd</sup> millennium BC, the *annuḫarum* used in the finishing of textiles has been interpreted as 'white alum' in opposition to another substance named *qitmu* 'black alum'.<sup>72</sup> In the 1st millennium BC *aḫussu*, interpreted as by-form of both *uḫulu* and *uḫultu*, is found in Neo-Babylonian texts from Ebabbara relating to the bleaching of the linens.<sup>73</sup>

The tablets of the same archive record another phytonym, denoting a plant used by fullers as a bleaching agent, whose name is composed by the sign NAGA: the GIŠ.NAGA plant.<sup>74</sup> According to Zawadzki this sign has to be read *gad-šu-naga* (Akk. *bīnu*) 'tamarisk' and "not alkali".<sup>75</sup> The tamarisk (*Tamarix aphylla*) is an evergreen tree growing on beaches by the sea and along watercourses in arid areas throughout the Near East. Its occurrence in the above-mentioned texts can be explained by the fact that it is *per se* a source of alkali: its leaves are able to accumulate and exudate sodium carbonate, thereby allowing plant to tolerate saline soils and alkaline conditions; hence its name 'salt cedar' in the vernacular. In addition to producing the soda ash, the burning of the plant could itself be used to bring to the boil the water for the lye; and to assist in the long, drawn-out incineration of the

70. CAD Q, 252 sub *qiltu* "a plant from which lye is extracted: Ú NAGA (ŠE+SUM+IR): ú *qi* (var. *qī*)-il-tu[m], Ú NAGA.SI, Ú SA.AD. GAL : Ú MIN *qar-ni*, Uruanna II 271-273"; CAD B, 100 sub *baqlu*: n a g a (ŠE.SUM+IR).ḫu-tul, MIN-gu-li = *ba-q[i]-il-tum* in Hh. XXIV 288f.; CAD Q, 252 sub *qilûtu* 'firewood, burnt material'.

71. CAD U-W, 48 sub *uḫultu*; CAD A/I, 216 sub *aḫussu*; CAD A/I, 359-360 sub *alluḫaru*.

72. Joannés 1984, 142.

73. Zawadzki 2006, 63 and n. 129.

74. BM 84054 and BM 83647 in Zawadzki 2013, 65 and n. 39; Zawadzki 2006, 61, n. 128 reports the case of a bleacher named Bal-assu and a fuller named Šamaš-šu-iddin who receive tamarisk for producing alkali. This indicates that the *ašlāku* can occasionally act as *pūšāya*. See also Quillien 2014, 285 and n. 102.

75. Zawadzki 2006, 63 and n. 129.

saltworts for producing alkali, mentioned in Neo-Babylonian texts beside tamarisk and sesame oil.<sup>76</sup>

Because of its high alkali content, the tamarisk was considered in Mesopotamia and the Levant as a holy (Akk. *quddušu*) tree: in the *The Date Palm and Tamarisk* disputation poem, the tamarisk claims itself to be the chief exorcist for purifying the temple.<sup>77</sup> Indeed in Mesopotamia as well as in the rest of the ancient Near East, cleaning, personal hygiene and ritual cleansing are closely linked aspects. Cuneiform texts quote other plants used in cleansing rituals, in medicine and in magic whose name suggests their exploitation in soap-making as a source of alkali.

The Syrian or wild rue (*Peganum harmala*) is for instance a succulent aromatic plant, rich in alkaloids, and known in Mesopotamia (Akk. *šibburrātu*) mainly as a drug.<sup>78</sup> Its Sumerian phytonym Ú.LUĤ.MAR.TU(.KUR.RA), literally meaning ‘cleaning/cleansing plant of the highland Amorites’, however suggests that wild rue was known for its detergent properties too.<sup>79</sup>

### *Vegetal oils and animal fats for detergents*

Homer’s epic poems describe not only wool but also fabrics and garments with different adjectives and

expressions related to the idea of a treatment with oil or fat.<sup>80</sup> In the Bronze Age texts dealing with the finishing of woollen textiles, alkalis are mentioned alongside vegetal oils or animal greases.<sup>81</sup> These fatty substances could be made up into a soapy lump which was rubbed on the surface of woollen fabrics. when they were scoured in the washing.<sup>82</sup>

The most ancient evidence for the exploitation of animal fats and vegetal oils in the production of soapy detergents to be used for the finishing of textiles comes from Southern Mesopotamia and dates to the end of the 3rd millennium BC.<sup>83</sup> Indeed cuneiform texts from the Sumerian cities ruled by the 3rd Dynasty of Ur record different kinds of fatty stuffs (Sum. Ī; Akk. *šamnu*) related to different treatments of cloths performed by fullers.<sup>84</sup> The tablets from Girsu, modern Tello in Iraq, listed sesame oil (Sum. ŠE.GIŠ.Ì) and swine fat (Sum. Ì.ŠAĤ) for textiles intended to undergo the túg šà-ha, túg sa-gi<sub>4</sub>-a and túg-ge ak(-dè) finishing treatments.<sup>85</sup>

Vegetal oil (Ì.GIŠ literally ‘oil of three’) was the chief fatty stuff used by fullers.<sup>86</sup> *Šamaššammū* (Sum. ŠE.GIŠ.Ì/ŠE.Ì.GIŠ literally ‘seeds of the plant of oil’) was the main source of vegetable oil in Mesopotamia.<sup>87</sup> This oleiferous plant is traditionally identified

76. Zawadzki 2006, 63-65.

77. Umbarger 2012. Tamarisk is also known with the phytonym <sup>u</sup>*tállal*, related to the verb *ullulu* ‘to purify, to cleanse’.

78. CAD Š/II, 376-377 sub *šibburrātu*: ‘For a possible cognate, Syr. *šabbāra* ‘rue’ (*Peganum harmala*)’.

79. In Hittite cuneiform texts this plant, named *ḫasuwāi*<sup>AR</sup>, occurs indeed among the species of soda plants (ŠE+NÁG) used in soap-making. Forbes (1955, 180) refers to a Mesopotamian lye obtained by burning rue (*Ruta graveolens*) but no alkaline property is known for this plant. A species of rue is mentioned for soap-making by Pliny (NH 28, 191) too: ‘*prodest et sapo; Gallorum hoc inventum rutilandis capillis*’.

80. Shelmerdine 1995, 101-102.

81. Mycenaean texts report the use of *e-ra-wo* (Gr. *elaion*) in the manufacturing and finishing of some pieces of cloth, see Shelmerdine 1995, 103-104. More often olive oil is indicated on the Mycenaean tablet by the ideogram OLE. During the Minoan period, the Linear A sign L49 indicated most likely olive oil, see Melena 1983. The fragmentary tablet Xe 7711 from Knossos might record the treatment of woollen cloths with perfumed or unscented oil, given to a fuller by a perfumer. Tablet Fr 1225 from Pylos records the offering of an ointment for smearing the garments - thus woven fabrics - of the *u-po-jo* Potnia, maybe the ‘Goddess of the Weaving’, see Rougemont 2011, 338-381 and Del Frio *et al.* 2010, 360-361.

82. Levey 1959, 125-129; Waetzoldt 1972, 159.

83. Waetzoldt 1972, 159.

84. Waetzoldt 1972, 153-174; Waetzoldt 1985, 83-86; Firth 2013. The Akkadian word *šamnu* denotes generically both animal and vegetable oil meaning ‘oil, fat or cream’, see CAD Š/I, 321 sub *šamnu*.

85. Waetzoldt 1972, 158-159. The túg šà-ha, túg sa-gi<sub>4</sub>-a and túg ge ak(-dè) treatments will be analyzed in the next paragraph that concerns the terminology of the verbs denoting technical operations.

86. The above-mentioned tablets from Girsu report that 56% of the total of fat substances used by fullers in the manufacturing of cloths undergoing the túg šà-ha, túg sa-gi<sub>4</sub>-a and túg-ge ak(-dè) processes was sesame oil; sesame oil even accounted for 98% of the total of fat substances suitable for royalty, see Firth 2013, 140.

87. CAD Š/I, 301 sub *šamaššamū*. In the early 2nd millennium BC two varieties of the ideogram for *šamaššammū* have been noticed:

as sesame (*Sesamum indicum* or *S. orientale*) because of the similarity of the Akkadian term with the Semitic *smsm*, Greek σήσαμον and Latin *sēsāma*. The term (Myc. *se-sa-ma*) appears furthermore already in the Linear B documentation from the Late Bronze Age Aegean, but sesame seeds recorded on tablets of the Ge series (602, 605, 607) from Mycenae seem to have been used as spices and not as an oil source.<sup>88</sup>

Nevertheless, the botanical identification of *šamaššammū* is still a controversial issue, since the etymology of the most ancient Semitic terms (Akk. *šamaššammū*; Ug. *šmn*; Heb. *šemen*), as well as the Sumerian *še-ġiš-ì*, simply point to the main product derived from this vegetable resource: the *šaman šammi* ‘oil of plant’. Thus, it can refer to several other plants with oleaginous seeds.<sup>89</sup>

In the Mediterranean area, where the main oil-producing plant is the olive tree (*Olea europaea*), olive oil was used also for industrial purposes. The olive tree was cultivated in the Near East too, in Syro-Palestine, from at least the Chalcolithic Age. Palaeoecological investigations have proved the presence of its cultivation in Syria in the Early Bronze Age. Its first textual attestation (Sum. GIŠ.Ì.GIŠ) comes from the archives of Ebla and dates back to the second half of the 3rd millennium BC. The Neo-Sumerian texts

from Girsu, at the end of the 3rd millennium BC, provide the first evidence of the importing of olive oil in Mesopotamia.<sup>90</sup> Cuneiform tablets from Mari inform us that the imported olive oil (Akk. *šaman sirdi*; Sum. Ì.GIŠ ZI.IR.DUM/ Ì.GIŠ ZI.IR.DU(UM)) was produced in the Amuq valley and the most valued comes from the coastal city of Alalakh, whence a text records the delivery of 2000 litres of oil.<sup>91</sup> The coeval and neighbouring site of Pyrgos-Mavroraki on the southern coast of Cyprus preserved vestiges of a Middle Bronze Age industrial and commercial complex, where both olive oil and textiles were produced.<sup>92</sup> During the Late Bronze Age, the textual sources show that the amount of olive oil (Ug. *šmn*) produced at Ugarit per year was so much (5,500 tonnes) that the surplus from this Canaanite city was exported to Egypt and Cyprus.<sup>93</sup>

In cuneiform texts, olive oil appears listed among other precious foodstuffs, or was used as an ingredient in precious perfumes, ointments for the body or medicine.<sup>94</sup> Therefore, it seems to be a luxury good and an industrial purpose is perhaps therefore to be ruled out. Only in a single text is olive oil associated with a textile context: a text from Mari records the delivery of olive oil to women weavers (Akk. *ana pašāš išparātim*) as an ‘ointment’.<sup>95</sup> It seems more

---

in the kingdoms in which the scribal traditions of the Upper Mesopotamia prevailed (Mari, Tell Rimah, Nuzi and Assur) the writing *še.ì.giš* is preferred to that of *še.giš.ì* used in Babylonia, see Reculeau 2009.

88. Rougemont 2011, 355.

89. CAD Š/I, 301 and 306 proposes to identify *šamaššamū* with *Linum* sp. “since no sesame seeds have so far been found in Mesopotamia in archaeological contexts earlier than the Sassanid period, whereas there is an abundance of linseed remains... the name [for *Linum* sp. = *šamaššamū*] was later transferred to the newly introduced oleiferous plant, sesame”. Oppenheim (1967) is of the same opinion; *contra* Bedigian & Harlan 1986. Nevertheless, linseeds are recorded in cuneiform documentation by the Sumerian noun *numun-gu* and the Akkadian term *zēr kitī*. For a more recent and comprehensive reassessment of the longstanding debate over the identification of *šamaššamū*, see Reculeau 2009.

90. Waetzoldt 1985, 77; Potts 1997, 66-68.

91. ARM IX, 9: Michel 1996; Reculeau 2009. The territory of Alalakh (=Alalakh) was purchased by the king Zimri-Lim at the end of his reign in order to satisfy internal needs without being dependent on commercial exchanges. Other texts record imports of olive oil from Aleppo: ARM IX 6, ARM VII 238 and ARMT XXVI/1, 22.

92. A large olive press for oil production was found during the excavations. The function of the Cypriote press is confirmed by the discoveries of a great number of jars containing residues of olive oil and of some olive-stones. The so-called Olive Press Room is next to the metallurgical area of the complex and contiguous to the room of perfumes and textiles, suggesting that this precious stuff could be used in the finishing of textiles, perhaps the sizing of the cloths with scented oils. The only parallel known for this period is found in Tell Hazor whilst others, a little later, come from Larnaca and Ugarit. See Heltzer 1987; Callot 1993; Belgiorno 2004; Karageorghis & Belgiorno 2005; Belgiorno 2009, 49-54.

93. The discovery of oil presses in the archaeological levels of Ugarit and Tell Hazor confirmed the production of olive oil in the Canaanite area, Heltzer 1987; Callot 1993.

94. CAD S, 312 sub *serdu* e.; see Stol 1985; Postgate 1985; Waetzoldt 1985.

95. Oil allotments granted as rations are called *piššatu* (Ì.BA/ Ì.GIŠ.BA/Ì.ŠEŠ<sub>4</sub>), CAD P, 431 sub *piššatu*. The verb *pašāšu* could be



reasonable, however, that Ì.GIŠ ZI.IR.DU was given to the women as rations or remuneration for their work: its function as ointment has therefore to be interpreted as a body-lotion for the weavers and not as a product destined to be smeared on textiles.<sup>96</sup>

Furthermore, Akkadian and Sumerian terminologies supply evidence for the use of fatty substances of animal origin too. The above-mentioned texts from Girsu list swine fat (Sum. ì-šaḥ) beside alkali for the finishing of several textiles. According Waetzoldt, the use of swine fat was reserved for textiles of inferior quality.<sup>97</sup> In a recent paper, however, Firth proves that the swine fat used for finishing of textiles intended for the túg-ge ak(-dè) process may sometimes be classified as of royal quality (lugal). Since these texts are always gauged ì-šaḥ in sila, it is likely that swine fat was used not in its solid physical shape, but in the form of a lard.<sup>98</sup>

In the second half of the 2nd millennium BC, a cuneiform text from the private archive of the prince Šilwa-Teššup of Nuzi testifies instead to the use of sheep fat (Akk. *lipû*; Sum. ì-udu) in close connection with the finishing of textiles.<sup>99</sup> In modern Mesopotamia and the Levant, this fat is extensively used in cooking. It is obtained in large part from the caudal appendage peculiar in the Awassi and the other fat-tailed sheep breeds. Iconographical and epigraphical sources demonstrate the preference for these breeds (Sum. udu-gukkal, literally ‘sheep with the big tail’; Akk. *gukkallu*) since the 3rd millennium BC; the texts moreover record their presence at Nuzi in the period when *lipû* was used by fullers.<sup>100</sup>

### *Vegetal and animal teasels*

Greek and Latin authors report that brushes to raise the nap of fulled textiles had spikes made of the prickles of a kind of thorn-bush (Lat. *spina fullonia*; Gr. γναφική ἀκάνθη) or the spines of hedgehog skins (Lat. *erina-ceus*; Gr. ἐχινῆ).<sup>101</sup> Actually the natural origin of the raw materials used to make teasels is suggested by the ancient terminology too: etymological studies related κνάφος and the verbs κναφ/γναφ-εύω ‘to card, to wash, to full the wool’, κνάπτω ‘to comb, to card’ and κνάω ‘to scratch, scrape’ to a common root linked with the spinose structures of bristly plants (Gr. ἀκαν ‘thistle’/ἀκανθα ‘thorn, prickle, spine’) and the stings of spiky animals (Gr. ἐχῖνος; ἀκανθίων ‘hedgehog, porcupine’).

The use of vegetable teasels is well-documented in the Middle Ages and later (Fig. 4).<sup>102</sup> Nowadays, this practice (It. *guernissaggio*) is still carried out in the teaseling of special woollen cloths like those made in cashmere, camel, alpaca, vicuna and guanaco. Unlike wire brushes, the thorns of prickly plants, mostly belonging to the genus of the thistle known as *Dipsacus fullonum*, raise the nap in a gentle way, breaking up the yarns rather than tearing the weave of the textile. Botanical terms (En. *thistle/teasel* and *cardoon*; Fr. *chardon à foulon*; German *Kardendistel*; It. *cardo dei lanaioli/scardaccione*) used to name this plant in modern European languages confirm this ancient custom of employing its spiny heads in the carding and teaseling of the wool.

The terminology of the Middle Bronze Age cuneiform texts demonstrate that Mesopotamian fullers too

used however also with the meaning of the sizing of textiles, CAD P, 245 sub *pašāšu*: [túg].i.udu.ak.a = *pa-ša-šu šá TÚG* ‘to treat a cloth with tallow’, Nabnitu XXIII 330.

96. We find analogous ambiguities in the Aegean documentation: in the tablet MY Fo 101, OLE+WE ‘oil for anointing’ is allocated to various recipients, including *a-ke-ti-ri-ja-i* women (specialists in finishing or decorating textiles), but it is not clear whether the oil delivered was used by these workers in their labours. A similar situation arises from the tablet KN Fh 1056 where a tailor *ra-pte-re* receives 4.8 litres of oil. With regard to the text F. Rougemont (2011, 380) suggests that workers given this professional designation could be performing more operations than sewing alone.

97. Waetzoldt 1985, 83.

98. Firth 2013, 159.

99. Rougemont 2011, 374-375.

100. Breniquet 2010; Waetzoldt 1972, 5, 47-48. Fat-tailed sheep are still well-attested in the Middle Assyrian texts but later “became extinct in the first millennium” (CAD G, 126 sub *gukkallu*), since the *gukkallu*-breed occurs solely in Standard Babylonian and Neo-Babylonian literary texts. Local fat-tailed sheep breeds are still found in most of the Near East countries today as well as they are common in northern parts of Africa, Pakistan, Afghanistan, Iran, North India, Western China, Somalia and Central Asia.

101. Dioscorides, *De Mat. Med.* IV, 160; Pliny NH, 24, 111, 26, 244 and 17, 92. See Flohr 2013, 114.

102. Ryder 1994.

used two different types of teasels to raise the nap of the woollen cloths and that at least one was made of a thorny plant.

The lexical lists Lú B and Lú D, dating back to the early of 2nd millennium BC, provide information about at least two different modalities, or more properly tools, used by the fuller ‘to teasel cloths’ (Akk. *mašārum*), a finishing treatment recorded for the túg guz-za and túg bar-dib cloths immediately after the walking of the textiles (Akk. *kamādum*) in the contemporary tablet AO 7026.<sup>103</sup> In Lú B the fuller in charge of raising the nap is designated both as lú (túg)-giš-kiši<sub>16</sub>-ùr-ra, thus the textile worker *ša i-na a-ša-gi-im i-ma-aš-ša-ru* ‘who raises the nap with the *ašāgu*’ and lú (túg)-bar-sig<sub>6</sub>-ùr-ra, the artisan *ša i-na ku-un-ši-li-im i-ma-[aš]-ša-ru* ‘who teasels with the *kunšillu*’.

The vocabularies used consider the *ašāgu* (GIŠ.Ú.GÍR/ ki-ši GIŠ.Ú.GÍR) as ‘a common spiny plant’ and identify it with a kind of acacia – like the *Prosopis farcta*, or a camel thorn – like the *Alhagi maurorum*.<sup>104</sup> Even so, in the lexical list ḪAR-ra = *hubullu* XIX, cloths are teaseled (Akk. *mašru*) with a plant named Ú.GÍR, an alternative writing of giš-kiši<sub>16</sub> but also a kind of hypernym for thorny plants in general.<sup>105</sup> In lexical texts, spiny shrubs

or weeds with an evil smell or a bitter taste as the *apû*, *dadâ*, *dadānu* and *kurbasi* are glossed as Ú.GÍR and equated with the *ašāgu* plant.<sup>106</sup> The *kurbasi* is sometimes recognized with a kind of thistle, suggesting that the *Dipsacus* sp. could have been involved in finishing also in Mesopotamia.<sup>107</sup> Furthermore, the above-mentioned text TC 3/I, 17, 20 that gives instructions to comb ‘slightly’ (*i-li-la li-im-šu-du*) one side of a woollen textile may suggest the carrying out of a ‘gentle’ brushing of cloth through the hispid trichome of vegetal teasels.<sup>108</sup> The verb *mašādu* has already been analysed above in connection with *muštu* ‘comb’ but in this case the use of the adverb *illillā* ‘slightly’ proposed by Veenhof could suggest a link with the *maša tu*, a thorny plant identified by Uruanna with the *amumeštu* or *baltu* thornbushes.<sup>109</sup>

On the other hand, the identification of the *kunšillu* with a natural resource exploited in brush-making is a rather more problematic issue.<sup>110</sup> Other than <sup>giš</sup>kiši<sub>16</sub>/Ú.GÍR, no determinative sign marks the term bar-sig<sub>6</sub>/BAR-sig and thus it is not possible to understand whether it is a vegetal rather than an animal or mineral substance. Vocabularies provide three meanings for *kunšillu* (ba-ar BAR/ bar): 1) thorn used as teasel, carding-comb or teasel for fabrics; 2)

103. Lú D, 3-4 in MSL XII, 204 and Lú B, 5-6 and 7-8 in MSL XII, 177. See CAD M/I, 359 sub *mašāru* and CAD K, sub *kamādu* “to weave and prepare cloth in a specific way”.

104. Halloran 2006, 34: <sup>(giš)</sup>kiši<sub>16</sub>(Ú.GÍR<sub>2</sub>-*gunû*), <sup>(giš)</sup>kiši<sub>16</sub> “a kind of acacia, *ašāgu*...*shok* (Arabic *shauk*), a thorny bush, *prosopis farcta*”; CAD A/II, 410-411 sub *ašāgu*: “The *ašāgu* can be identified with the modern Arabic *šok* (*Prosopis farcta* or *stephani-ana*) a kind of acacia, one of the most widespread thorny shrubs of southern Iraq”; CDA 27: “camel thorn”. To my knowledge, the only camel thorn that could be interpreted as *ašāgu* is *Alhagi maurorum*, a species of legume that grows in the saline, sandy, rocky, and dry soils across the Near East (Cyprus, Syria, Jordan, Lebanon, Israel, Iraq, Turkey and Iran). An Akkadian passage seems, however, to identify this thorn bush with another plant since it reads: “the plant whose appearance is like the sap of the *ašāgu* thornbush and whose seed is like the seed of lettuce is called ‘sweet plant’ ” (CAD U-W 179, sub *upātu* c). Indeed, *Alhagi maurorum* is mentioned in the Qur’an as a source of sweet manna and its healing and sweetening properties are still well-known in local folk medicine and in cookery.

105. Hh. XIX, 194-195 in MSL X, 133.

106. Uruanna I, 79.

107. CAD (D, 17, sub *dadâ* and *dadānu*) identifies *dadâ* and *dadānu* as “stinking” subspecies of the *ašāgu*, in its turn interpreted a kind of false carob. Apart from the *ašāgu*-group is found another evil-smelling thorny plant, the *daddaru* “thistle-bush”. This phytonym could be related to Heb. *dardar* “thistle” and according to my studies to the Sum. dar-dar = Akk. *tukkupu* “to puncture, to stitch”. Another name for this plant is *kurdinnu*.

108. Veenhof 1972, 104.

109. Veenhof (1972, 106) admits, however, that the translation of the adverb *illillā* ‘slightly’ and its connection with *lillum* ‘weak’ is doubtful. CAD M/I, 360, sub *maša tu*; CDA 201 “a plant with thorns”; Uruanna I, 192; CAD B, 65-66, sub *baltu*: “perhaps a camel thorn”.

110. The Akkadian tool *kunšillu* and the noun *kunšu* (sig-peš-gilim-ak-a, sig-bar-tab) ‘flock, wad of wool’ are related in the same ways as the Greek terms κνάφαλλον ‘teasel, carding-comb’ and κνάφος ‘hank of wool’.

textile worker using the teasel, carder, also abbreviated *kun*<sub>8</sub>; 3) a part of the body, a piece of meat.<sup>111</sup>

With this last connotation, Akkadian *kunšillu* and Sumerian *bar* could therefore indicate the part of an animal, likely the back, used by the fullers as a teasel in the raising of the nap of the woollen cloths. In fact the logogram BAR means ‘outside, exterior; outer appearance; body; back, edge; fleece’ and moreover, the lexical text Hh. XV lists the *kunšillu* (<sup>uz</sup>bar-sig) among different kinds of leather: it is recorded after the *pāru* (<sup>uz</sup>bar) ‘skin, hide’ and *qinburu* (<sup>uz</sup>bar-kun), an animal skin used as well as for its bristles as tools.<sup>112</sup> The identification of the *kunšillu* with a spiny animal skin would explain why this teasel or ‘thorn’ is neither preceded by the determinative for plants Ú or semantic class marker for the wooden instruments GIŠ.

Furthermore, according to some scholars, the sign BAR should have a taxonomical function and be interpreted as a faunal term designating several *genera* of hedgehog endemic to the Near East (*Erinaceus concolor*, *Hemiechinus auritus*, *Paraechinus*

*aethiopicus*).<sup>113</sup> It could be used as an abbreviation for some Sumerian faunal epithets, such as *šaḥ-bar-gùn-gùn-nu* and *šaḥ-zé-da-bar-šur-ra*, whose Akkadian equivalent is *burmāmu* ‘hedgehog’.<sup>114</sup> Literally the Sumerian *šaḥ-bar-gùn-gùn-nu* could be translated as ‘pig whose back is spotted/stitched’, whilst *šaḥ-zé-da-bar-šur-ra* gives ‘piglet whose back bristles/teasels’.<sup>115</sup> The sign *šur-ra* is a compound of the sign *šu* ‘by hand’ and *ur-ra* (Akk. *mašāru*) ‘to brush, to raise the nap with a teasel’, namely the verb which in Hh. XIX, 194-195 designates the function of the *ašaqū* and the *kunšillu* (túg Ú.GÍR.úr-ra and túg bar-sig-úr-ra = *mašru*).<sup>116</sup> This reading seems to be confirmed by the equivalence *lú túg-šu-ur-ur* = *ma-a-še-e-rum* denoting the fuller busy in teaseling by hand.<sup>117</sup>

The identification of the *kunšillu* with an animal teasel obtained from the skin of a Near Eastern species of hedgehog can be confirmed by Classical sources referring to the same involvement of hedgehog skins in 1st century AD Rome.<sup>118</sup> Pliny the Elder refers that the importance of the hedgehog skins

111. CAD K, 542 sub *kunšillu*; CDA 167 sub *kunšillu*.

112. Hh. XV, 288-289 in MSL IX, 14; CAD Q, 254 sub *qinburu*: “probably a bristle, used also as a tool”.

113. Nevertheless, the identification of the plants and animals designated by Akkadian and Sumerian terms with the phytonyms and zoonyms of the modern taxonomy is very torturous and not certain. Even the name of the hedgehog cannot escape this kind of methodological problems. On the one hand, the cuneiform documentation classified the *burmāmu* among rodents and among swine. On the other, further Akkadian animal names, such as those of some piglets or rodents or even reptiles, have a corresponding Sumerian faunal epithet that make them good candidates for the hedgehog: the *arrabu* (*šaḥ-giš-ur-ra/peš-giš-ur-ra*) perhaps ‘dormouse otherwise ‘jerboa’, the *ḥurbabillu* (*bar-gùn-gùn-nu*) maybe ‘chameleon’ and the *apparrū* (*šaḥ-bar-guz*) meaning literally ‘pig having wiry hair’. See Bodenheimer 1960, 108; Hh. XIV, 205-206 in MSL VIII/2, 24; CAD identifies the *bar-gùn-gùn-nu* and the *bar-gùn-gùn-nu-kur-ra* with species of chameleon, CAD H, 248 sub *ḥurbabillu*; Qumsiyeh 1996, 59-69.

114. Hh. XIV 162-164 in MSL VIII/2, 19-20. In Hh. XIV 190a (MSL VIII/2, 22) *burmāmu* is instead classified among rodents (*péš-giš-gi-a*). See CAD B, 330, sub *burmāmu*.

115. In Hh. XIV 48, MSL VIII/2, 74 is found the equivalence *burmāmu* = *šaḥḥu* “pig, hog”. Note that modern languages too bring out the resemblance between these two animals: En. *hedgehog*; Ar. *šayham*; It. *porcospino* and the related En. *porcupine*, Fr. *porcupine*, *porc-épic* designating *Hystrix* sp. The reduplicated sign *gùn* probably refers to the most characteristic feature of this animal namely its speckled (Akk. *burrumu*) back, to which is also related the etymology of the Akkadian zoonym *burmāmu*.

116. CAD K, 298, sub *katāmu*; Hh XIX 178 and 194-195 in MSL X, 133.

117. Lú B 12, in MSL XII, 177. This meaning seems to be further supported by the reading of *šu-ur* as *se-ru* ‘rubbed’ and *šu-ur-ra* as *pašātu* ‘to erase, to scratch out’. See CAD P, 249 sub *pašātu*. Hh XIX, 178 in MSL X, 133 records the equivalence *túg-šu-ur-ra* = MIN (= *tak-ti-mu*), where *katāmu* (Sum. *šu*; *du*1) means ‘to cover with garments, to provide with garments, to cover’, perhaps suggesting that this kind of finishing was intended for the fabrication of fulled textiles for overcoats, blankets, curtains or tents.

118. The third of the so-called Kedor-laomer texts provides further indications referring to the nature of the *kunšillu*: here it appears as a living being with links to the *āribu* bird - the former seemingly the ‘prey’ of the latter. The translation of this passage considered the *āribu* as a ‘rook’ with the *kunšillu* as a thistle, since it is qualified as *kīnu* ‘firm in place’ and the scholars knew its involvement in the raising nap of the fulled textiles. Indeed thistles are very hard to eradicate. Nevertheless, in my opinion the term *kunšillu* could indicate a small animal that does not draw back in front of the threat of predators and raptors, rather than a motionless plant. Actually the bird most famed as the sworn ‘enemy’ of the thistle-bushes is not the crow but the goldfinch (*Carduelis carduelis*) or thistle finch (Gr. *ἀκανθολλίς/ἀκανθίς*; Lat. *carduelis*; It. *cardellino*, Fr. *chardonneret*), a bird greedy for the seeds of these plants, and probably identifiable with the Akkadian *iššūr ašāgi* ‘bird of the *ašāgu*-bush’.



**Fig. 5.** Teasels of hedgehog skin worn by the man named S’Erittaju, Orotelli, Sardinia. Photo courtesy of Luisa Zoroddu.

in the finishing treatments of woollen fabrics led the Roman Senate to impose a monopoly on the hedgehog trade and the skin of the animal became one of the most sought-after commodities in ancient times.<sup>119</sup> Nevertheless a mandible of *Erinaceus europaeus* was found in the Augustan deposit of the *forum* of Pompeii during the excavations: it might be linked with this economical exploitation of the animal described by Pliny.<sup>120</sup> Unfortunately the only archaeological evidence of the tool used as teasel in the Roman age - a couple of brushes found at *fullonica* I 6, 7 at Pompeii - has not been published and does not seem to have been preserved, so it is not clear what they exactly looked like.<sup>121</sup> Indeed there is no evidence for the use of hedgehog skins in textile finishing after the 1st century AD, other than Pliny’s statements. Yet, an indication of how the hedgehog teasels used by Roman fullers were made is provided by the ethnography: these tools made in leather, cork and hedgehog skin (Fig. 5) are still attested today in Sardinia, albeit in a symbolic and ritualized sphere no longer directly related to fulling and cloth-making processes. In fact, a Sardinian Carnival character called s’Erittaju ‘the Hedgehog-bearer’ - a grotesque personification of a fuller - carries hedgehog-skin brushes, attesting to their use until recent times.<sup>122</sup> The clear parallels between the apotropaic rituals performed in the Mediterranean island during the Carnival and those practiced by Romans on

119. Pliny NH, 8, 135: “*hac cute expoliuntur vestes. magnum fraus et ibi lucrum monopolio invenit, de nulla re crebrioribus senatus consultis nulloque non principe adito querimoniis provincialibus*”.

120. King 2002, 426: “but it is more likely that the bones derive from a natural death”.

121. See Flohr 2013, 115. Unlike the vegetal thistles well attested until recent times, the exploitation of hedgehog skins in raising the nap and polishing of woollen cloths seems to have been lost or at least forgotten. Nowadays, tenuous reminiscences of the ancient use of hedgehogs in cloth finishing can be traced in the attempt to imitate its speckled back in the manufacture of clothes-brushes. This of the little mammal was common until the last century in Denmark (M.-L. Nosch, personal communication). Ulla Mannerling has carried out experimental research on the rubbing of hedgehog skins on fulled textiles for The Danish National Research Foundation’s Centre for Textile Research.

122. S’Erittaju ‘the Hedgehog-bearer’ is one of the main characters of the traditional ‘*Thurpos*’ Carnival of Orotelli, a little village of the Barbagia, a very conservative area of the inner Sardinia and romanized only from 1st century AD. During the Carnival processions at Orotelli, the *thurpos* characters wear a traditional *orbace* cowl and as a caricature represent the ancient professions of the rural world with disturbing personifications of the peasants, the plough oxen and craftsmen. The *orbace* (Sar. *orbaci*, *furesu*, *fresi*) is a well-known woollen cloth subjected to fulling and polishing processes; its production is one of the most important economic activities in the Barbagia region. S’Erittaju wears a white *orbace* cloak and some brushes made from hedgehog skins on the chest and abdomen; he has to be considered the grotesque personification of a fuller. The masquerade costume of S’Erittaju had sunk into oblivion; only thanks to the careful and scrupulous research of writer and historian Lorenzo Pusceddu is it now exhibited in the Ethnographical Museum of Nuoro as part of the Sardinian cultural heritage. From a linguistic point of view the term *erittaju* is related to the Proto-Indo-European root \*ǵʰér ‘to bristle, to raise the nap’ to from which derive the Gr. χήρ ‘hedgehog’ and the Lat. *ēr* and *ērīcius* ‘hedgehog’ as well as to Lat. *cārere* ‘to card’ and Gr. κείρω ‘to shear, to smooth’, the two technical operations performed by the fuller right after the fulling of the wool fabrics. See IL 392-293; Rocci 2023.

the occasion of Lupercalia festival, at the same time of the year, suggest that tools and techniques used by Roman fullers might have reached the Sardinian inland over the course of the 1st century AD, when the reason was colonised.<sup>123</sup>

In the documentation of the ancient Near East, besides the afore-mentioned lexical texts, no direct evidence of the exploitation of hedgehogs and hedgehog skins in fulling and finishing processes of woollen textiles is found. The only archaeological sources documenting a certain importance of the animal in Bronze Age Mesopotamian and Eastern Mediterranean cultures, where wool is the chief fibre and the textile industry is the driving element behind the economy, are iconographic: representations of hedgehogs in the shape of offering vessels, figurines (Tell Mozan), amulets (Tell Brak) and on seals and seal impressions (Isin-Larsa) are indeed pretty numerous.<sup>124</sup> Amongst these, the Early Cycladic III (2300-2100 BC) offering vessel found at Chalandriani on Syros,

in the north-west area of the Cycladic islands, could have some connection to the fuller's craft. This little island is not far from Kimolos, the place from where the most renowned quality of fuller's earth in antiquity was quarried. The ancient place name of Kimolos was Echinousa, namely the island of the ἐχῖνος 'hedgehog', or the island of the ἐχῖνῆ 'hedgehog's skin'. The terracotta vessel has the hedgehog sitting and holding a bowl: it is considered a kind of 'prototype' of the Aegean hedgehog *rhyton* found in the Eastern Mediterranean at the end of the 2nd millennium BC.<sup>125</sup> It is perhaps possible to correlate the diffusion of the Mycenaean type of hedgehog *rhyton* and the introduction of new techniques of finishing of cloths from the Near East, but more detailed studies are needed.<sup>126</sup>

It is quite probable that the carding ability offered by the bracts of the teasels was originally observed in the fields when the sheep were shedding. Before the anthropogenic selection of sheep against natural

123. During the Carnival processions *s'Erittaju* chases and hugs the fertile women of the community, pricking their breasts with the brushes. It is believed that the 'teaseling' of these girls with the itchy pricks of the Fuller/Hedgehog-bearer would stimulate the flow of the milk in the women's breasts, increasing the fecundity of the earth, animals and human beings, and so secure the affluence of the community. This ceremony can be interpreted as a rite of passage for the girls who have reached the adult age: the 'fertilization' should transform the virgins into goodwives and wise mistresses of the household, whose economic contribution in a large part was based on the domestic weaving and working of wool. Such an apotropaic ritual recalls the description of the Roman *lupercalia*-festival. The *lupercalia*-festival took place in the culmination of the winter, around the middle of February, when the hungry wolves approached sheepfolds and threatened flocks. The festival was celebrated by the *luperci*, young priests with half-naked limbs smeared with grease and a mud-mask on the face; they wore only a goatskin around the hips, obtained from animals sacrificed during the rites. From these skins they cut some strips of leather named *februa* or *amiculum lunonis* and used them as whips. After a hearty meal, all the *luperci* had to run around the hill. During the race, they jumped about and struck out at both the ground and the women with their whips. Originally the women offered voluntarily their bellies to the *februa* of the priests in order to increase their fertility.

124. The earliest hedgehog representations in the Near East may date as far back as the 7th millennium BC, with examples from Bouqras in Syria (dated 6400-5900 BC). The first known 'hedgehog *rhyton*' - a specific type of vessel with two openings used for libations (Gr. ῥυτόν from the verb ῥεῖν, 'to flow') - is probably the vessel from Arpachiyah from the Halaf period (6100-5100 BC). A hedgehog *rhyton* dated 3500-3300 BC was found in Jebel Aruda. In the 2nd millennium, hedgehog *rhyta* were used Chagar Bazar and Tell Chuera. In the Late Bronze Age (LH III A2-LH IIIB) hedgehog *rhyta* became a Mycenaean production: a small group was found on Mainland Greece (Prosymna, Tanagra and Vari), other examples in Cyprus (Myrtou-Pigades and Maroni) and in the Levant (Tell Abu Hawam, Kamid el-Loz, Tell Sera' and Ugarit). A Philistine hedgehog vessel was found at Ekron and it is the only known LH IIIC example. See Ben-Shlomo 2010, 143-144; Recht 2014; Collon 1986, 159, n. 388.

125. See Recht 2014; Von Bothmer *et al.* 1979, 61:18 and 26.

126. In the 1st millennium AD, the Romans believed that fulling was a finishing process originating in the Eastern Mediterranean. Pliny the Elder (NH 7, 196) attributed the invention of the techniques of *ars fullonia* to the Greek Nicia of Megara, see Flohr 2013, 101. For the links between the hedgehog and the symbolism of death and rebirth, see Ben Shlomo 2010, 144 and n. 48. Moreover the matter is further complicated by the fact that at the end of the 2nd millennium BC, Mycenaean iconographic sources from Eastern Mediterranean show another use of the hedgehog skins: lots of Late Helladic Period III C (1200-1100 BC) pottery fragments portray warriors and mariners wearing a distinctive spiky headdress, the so called "hedgehog" helmet. This cap has been interpreted as being made of leather or raw-hide or some other perishable material reinforced with bronze bosses and a central short crest to resemble the body of a hedgehog, but some scholars have also suggested that similar helmets could have been actually made of hedgehog skins, see Yasur-Landau 2014, 184-186; D'Amato & Salimbeti 2016, 32.

fleece loss, the specimens of *Ovis orientalis* moulted at the first signs of the height of summer.<sup>127</sup> The wool would stay entangled in the thorns of thistle-bushes, the commonest plant of the grazing lands. Shepherds sought out the tufts of wool, plucking and gathering them one by one. Collecting the wool in this way had the advantage of obtaining it with relatively minimal expenditure of time and energy and, not less important, of it having undergone a first cleaning and sorting of the fibres. In the first half of the 2nd millennium BC in Mesopotamia the gathering was performed without any cutting involved: it was sufficient to pluck the flocks by hand or to use the teeth of a comb (Akk. *muštu šipāti*) to obtain the wool.<sup>128</sup> The pulling out of the hair of the fleece with combs or any prickly tool can explain the use of the shearing terminology in the context of the finishing of fabrics and also the ambiguity of many verbs that could be used to mean ‘to shear, to comb, to card, to teasel, to crop, to full’. The above-mentioned Gr. κναφεύω and Akk. *mašādu* have already been analysed, but the Latin terminology also records this same linguistic phenomenon: the tool *carmēn* ‘teasel, carding-comb’ and the natural resource exploited to construct it (Lat. *carduus* ‘thistle, teasel’) are both related to the Lat. *cārere* ‘to card’, in turn linked with Gr. κείρω ‘to shear, to smooth’.<sup>129</sup>

In Akkadian the verb *qatāpu* (Sum. kud) has the chief meaning ‘to pluck’ and is used not only to indicate the harvesting of the wool by plucking, but to designate also the cropping of a hairy fabric. The synonymous *qarādu* (*zē*) ‘to pluck wool’ and its related verbal adjective *qerdu* ‘plucked wool’, often written GÍR-*du*, could therefore be linked with Lat. *cārere* and Gr. κείρω by a common root. As seen above, Sumerian GÍR (Akk. *sehlu, šillu*) means ‘thorn, sting, needle’, suggesting that all these operations may be associated with the use of a sharp, natural tool. The sign GÍR has been connected with the Proto-Indo-European root \**ǵhēr* ‘to bristle’ linked both with

thistles and thorny plants and with prickly animals like hedgehogs (Gr. χήρ; Lat. *ēr, ērerīcius; ērināceus*) or pigs (Gr. χοῖρος).<sup>130</sup>

## Conclusions

In ancient times, fulled textiles were precious and expensive goods. Already in the Bronze Age many Mesopotamian textiles in their finishing processes were designated as ‘royal’, as were certain oils and fats used for scouring; some texts from Pylos, in Messenia, refer instead to a fuller in the sovereign’s service. The fulled textiles’ value has to be understood according to the number of treatments that they needed and the time and raw materials required in each technical operation. I have focused in this analysis on the natural resources involved in the ancient fulling technology, as raw materials or tools. The study of the archaeological and textual sources of the 1st millennium BC gave me the opportunity to investigate too the technology used during the Bronze Age in the finishing of woollen textiles and to compare it with the fulling craft performed in Roman and Greek times, better-known thanks to a richer evidence. Even allowing for differences due to the diverse availability of natural resources from such varied ecosystems and times, the terminology of the 3rd and 2nd millennia BC cuneiform texts reveals that the fulling of woollen fabrics was performed by Near Eastern textile workers with the same techniques and similar tools as described by Greco-Roman sources in Classical antiquity.

## Acknowledgements

I would like to thank Marie-Louise Nosch for inviting to submit my contribution and giving me the opportunity to broach the interesting topic of the terminology of the fulling technology through a diachronic and interdisciplinary point of view. I would also like

127. Breniquet 2010.

128. The *magzazu* ‘shearing blade’ is known from the middle of the 2nd millennium BC, but only in lexical texts. Iron shears are documented from the 1st millennium BC, see Lassen 2010. CAD (M/I, 49, sub *magzazu*) translates *magzazu* as ‘shears’, referring to its equivalence with the sign gi-ir GÍR ‘thorn’.

129. Rocci 1027; IL 151.

130. Whittaker 2012, 585, 590-600.

to express my thanks to the reviewers and to Doniert Evely for the thoroughgoing revision and correction of my article. Finally, I am very grateful to the municipal administration of Orotelli, to the major Nannino Marteddu and to the cultural association Thurpos Eritajos Orotelli for their willingness and enthusiasm in assisting in my ethnographic field research.

### Abbreviations

CAD	<i>The Assyrian Dictionary of the Oriental Institute of the University of Chicago</i> . Chicago 1956-2010
CDA	J. Black, A. George & N. Postgate (eds.) <i>A Concise Dictionary of Akkadian, 2nd (corrected) printing</i> . Wiesbaden 2000
Eng. Bot.	J. Sowerby (ed.) <i>English Botany or, Coloured Figures of British Plants, with their Essential Characters, Synonyms and Places of Growth</i> . London 1790-1813
Hh.	B. Landsberger (ed.) <i>The Series HAR-ra=hubullu, Materials for the Sumerian lexicon</i> . V, VI, VII, IX, X and XI. Rome 1957-
IL	L. Castiglioni & S. Mariotti (eds.) <i>Vocabolario della lingua latina</i> . Milano 1996.
JCS	<i>Journal of Cuneiform Studies</i> . New Haven-Boston-Ann Arbor.
LH	Late Helladic
MSL XII	B. Landsberger, E. Reiner & M. Civil, M. (eds.) <i>Materials for the Sumerian lexicon. The series lu = ša and related texts</i> . Roma 1969.
MSL VIII/2	B. Landsberger (ed.) <i>The Fauna of Ancient Mesopotamia. Second part. HAR-ra=hubullu Tablets XIV and XVIII</i> . Roma 1962.
MSL X	B. Landsberger, E. Reiner and M. Civil (eds.) <i>Materials for the Sumerian Lexicon. The series HAR-ra =hubullu. Tablets XVI, XVII, XIX and related texts</i> . Roma 1970.
Rocci	L. Rocci (ed.) <i>Vocabolario Greco-Italiano</i> . Roma 1993 (Thirty-seventh edition).
Uruanna	Pharmaceutical Series uruanna: <i>maštakal</i>

### Bibliography

Algaze, G. (2008) *Ancient Mesopotamia at the Dawn of Civilization: The Evolution of an Urban Landscape*. Chicago.

- Bedigian, D. & Harlan, J. R. (1986) Evidence for cultivation of sesame in the ancient world, *Economic Botany* 40, 137-154.
- Belgiorno, M. R. (2004) Cyprus, Advanced Country since 2000 BC. In M. R. Belgiorno (ed.), *Pyrgos-Mavroraki. Advanced Technology in Bronze Age Cyprus*, 9-37. Nicosia.
- Belgiorno, M. R. (2009) Progetto Pyrame: Pyrgos Ricerche Archeologiche e Archeometallurgiche, lo stato dell'arte a dicembre 2008. In M. R. Belgiorno (a cura di), *Cipro all'inizio dell'Età del Bronzo. Realtà sconosciute della comunità industriale di Pyrgos/Mavroraki*, 14-105. Roma.
- Beneke, K. & Lagaly G. (2002) From Fuller's Earth to Bleaching Earth: A Historical Note, *European Clay Group Association, Newsletter No. 5*, July 2002, 57-78.
- Ben-Shlomo, D. (2010) *Philistine Iconography: A Wealth of Style and Symbolism*. Orbis Biblicus et Orientalis 241. Fribourg.
- Bodenheimer, F. S. (1960) *Animal and Man in Bible Lands*. Collection de travaux de l'Académie internationale d'histoire des sciences 10. Leiden.
- Breniquet, C. (2010) Weaving in Mesopotamia during the Bronze Age; Archaeology, techniques, iconography. In C. Michel & M.-L. Nosch (eds.), *Textile Terminologies in the Ancient Near East and Mediterranean from the third to the first millennia BC*, Ancient Textiles Series 8. 52-68. Oxford.
- Brunello, F. (1973) *The Art of Dyeing in the History of Mankind*. Vicenza.
- Callot, O. (1993) Les huileries et l'huile au Bronze Récent: quelques exemples syriens et chypriotes. In M. C. Amoretti & J. P. Brun (eds.), *La production du vin et de l'huile en Méditerranée*. 55-64. Athens.
- Collon, D. (1986) *Catalogue of the Western Asiatic Seals in the British Museum. Cylinder Seals III. Isin/Larsa and Old Babylonian Periods*, with contributions by C. B. F. Walker & M. Sax. London.
- D'Amato, R., Salimbeti, A. (2016) *Early Iron Age Greek Warrior 1100-700 BC*. Oxford.
- De Albentis, (2002) L'economia e la produzione. In F. Coarelli (a cura di), *Pompei. La vita ritrovata*. pp. 110-193. Udine.
- Del Frio, M., Nosch, M.-L. & Rougemont, F. (2010) The terminology of Textiles in the Linear B Tablets, including Some Considerations on Linear A Logograms and Abbreviations. In C. Michel & M.-L. Nosch (eds.), *Textile Terminologies in the Ancient Near East and Mediterranean from the third to the first millennia BC*. Ancient Textiles Series 8. 338-373. Oxford.
- Durand, J.-M. (2009) *La nomenclature des habits et des textiles dans les textes de Mari*. Matériaux pour le

- Dictionnaire de Babylonien de Paris, Tome I, Archives Royales de Mari XXX. Paris.
- Firth, R. (2011) A Discussion of the Use of im-bab-bar<sub>2</sub> by the Craft Workers of Ancient Mesopotamia, *Cuneiform Digital Library Journal*, 2011:002, [http://www.cdli.ucla.edu/pubs/cdlj/2011/cdlj2011\\_002.html](http://www.cdli.ucla.edu/pubs/cdlj/2011/cdlj2011_002.html) (preprint).
- Firth, R. (2013) Considering the Finishing of Textiles based on Neo-Sumerian Inscriptions from Girsu. In M.-L. Nosch, E. Andersson Strand & H. Koefoed (eds.), *Textile Production and Consumption in the Ancient Near East. Archaeology, Epigraphy, Iconography*. Ancient Textile Series 12, 138-158. Oxford.
- Flohr, M. (2013) *The World of the Fullo. Work, economy and society in Roman Italy*. Oxford Studies on the Roman Economy 4. Oxford.
- Forbes, R. J. (1956) *Studies in Ancient Technology. Washing, Bleaching, Fulling and Felting. Dyes and Dyeing Spinning. Sewing, Basketry and Weaving and Looms. Fabrics and Weaters. The fibres and fabrics of Antiquity*, Volume IV. Leiden.
- Forbes, R. J. (1965) *Studies in Ancient Technology. Cosmetics and Perfumes in Antiquity: Food, Alcoholic Beverages, Vinegar: Fermented Beverages 500 B.C.-500 A.D.* Volume III. Leiden (Second revised edition).
- Fosbroke, T. D. & Lardner, D. (1833) *A Treatise on the Arts, Manufactures, Manners, and Institutions of the Greeks and Romans*. London.
- Halloran, J. A. (2006) *Sumerian Lexicon: A Dictionary Guide to the Ancient Sumerian Language*. Los Angeles.
- Healy, J. F. (1999) *Pliny the Elder on Science and Technology*. Oxford.
- Heltzer, M. (1987) Olive growing and olive oil in Ugarit. In M. Heltzer & D. Eitam (eds.), *Olive oil in Antiquity*. 106-120. Haifa.
- Hiller, S. (1988) Dependent personnel in Miceanean texts. In M. Heltzer & E. Lipinski (eds.), *Society and Economy in the Eastern Mediterranean, C. 1500-1000 B.C.* Orientalia Lovaniensia Analecta 23. Leuven.
- Jasink, A. M. (2006) Profumi e loro ingredienti nelle tavolette micenee. Il ruolo dell'olio d'oliva / Perfumes and their ingredients in the Mycenaean tablets. The role of the olive oil. In M. R. Belgiorno (a cura di), *Aromata Cipria. Olive oil in perfumes and medicaments in Cyprus in 2000 B.C.*, 271-239. Perugia.
- Joannès, F. (1984) Produits pour le travail du bois, du cuir, et du tissu. In Bardet, G. Joannès, F. Lafont, B. Soubeyran, D. et Villard, P. (eds.) *Archives administratives de Mari I. ARM XXIII*, 133-191. Paris.
- Karageorghis, V. & Belgiorno, M. R. (2005) *Primi esempi di tecnologie agricole e industriali nell'Età del Bronzo a Cipro*. Roma-Palermo.
- King, A. (2002) Mammals: Evidence from Wall Paintings, Sculpture, Mosaics, Faunal Remains and Ancient Literary Sources. In W. F. Jashemski & F. G. Meyer (eds.), *The Natural History of Pompeii*, 401-450. Cambridge.
- Lassen, A. W. (2010) Tools, Procedures and Professions: A review of the Akkadian textile terminology. In C. Michel & M.-L. Nosch (eds.), *Textile Terminologies in the Ancient Near East and Mediterranean from the third to the first millennia BC*. 272-282. Ancient Textiles Series 8. Oxford.
- Lackenbacher, S. (1982) Un texte vieux-babylonien sur la finition des textiles, *Syria* 59, 129-149.
- Levey, M. (1959) *Chemistry and chemical technology in ancient Mesopotamia*. Amsterdam-London.
- Liverani, M. (1988) *Antico Oriente, Storia, società, economia*. Roma-Bari.
- Michel, C. (1996) Le commerce dans les textes de Mari. In J.-M. Durand (ed.), *Mari, Ebla et les Hourrites, dix ans de travaux*, 385-426. Amurru 1. Paris.
- Michel, C. & Veenhof, K. R. (2010) The Textiles Traded by the Assyrians in Anatolia (19th-18th centuries BC). In C. Michel & M.-L. Nosch (eds.), *Textile Terminologies in the Ancient Near East and Mediterranean from the third to the first millennia BC*. Ancient Textiles Series 8, 210-272. Oxford.
- Moeller, W. O. (1976) *The Wool Trade of Ancient Pompeii*. Studies of the Dutch Archaeological and Historical Society 5. Leiden.
- Moorey, P. R. S. (1999) *Ancient Mesopotamian Materials and Industries: The Archaeological Evidence*. Oxford.
- Oppenheim, L. A. (1948) *Catalogue of the Cuneiform Tablets of the Wilberforce Eames Babylonian Collection in the New York Public Library: Tablets of the Time of the Third Dynasty of Ur*, American Oriental Series 32. New Haven.
- Oppenheim, L. A. (1967) Essay on Overland Trade in the First Millennium B.C., *JCS* 21, 236-254.
- Palaima, T. G. (1997) Potter and Fuller: The Royal Craftsmen. In R. Laffineur & P. Betancourt (eds.), *TEXNH: Craftsmen, Craftswomen and Craftsmanship in the Aegean Bronze Age. Proceedings of the 6th International Aegean Conference, Philadelphia, Temple University, 18-21 April 1996*, 407-412. *Aegaeum* 16. Liège-Austin.
- Peyronel, L. (2004) *Gli strumenti di tessitura dall'età del Bronzo all'epoca persiana*. Materiali e Studi Archeologici di Ebla IV. Roma.
- Postgate, N. (2014) Wool, Hair and Textiles in Assyria. In C. Michel & C. Breniquet (eds.), *Wool Economy in the Ancient Near East and the Aegean: From the Beginnings of Sheep Husbandry to Institutional Textile Industry*, Ancient Textiles Series 17, 401-427. Oxford-Philadelphia.



- Potts, D. T. (1997) *Mesopotamia Civilization: The Material Foundations*. New York.
- Quillien, L. (2014) Flax and Linen in the First Millennium Babylonia BC: the Origins, Craft Industry and Uses of a Remarkable Textile. In C. Michel and M.-L. Nosch (eds.), *Prehistoric, Ancient Near Eastern and Aegean Textiles and Dress: an Interdisciplinary Anthology*, Ancient Textiles Serie 18, 271-298. Oxford.
- Qumsiyeh, M. B. (1996) *Mammals of the Holy Land*. Lubbock.
- Recht, L. (2014) Transformers Energize! Aegean Bronze Age rhyta in moments of transformation. In A. Bokern & C. Rowan (eds.), *Embodying Value? The Transformation of Objects in and from the Ancient World*, BAR International Series 2592, 35-52. Oxford.
- Reculeau, H. (2009) Le point sur la 'plante à huile': réflexions sur la culture du sésame en Syrie-Mésopotamie à l'âge du Bronze, *Journal des Médecines Cunéiformes* 13, 13-37.
- Robertson, R. H. S. (1949) The Fuller's Earths of the Elder Pliny, *The Classical Review* 63, 51-52.
- Rougemont, F. (2011) Oil at Nuzi and in the Linear B Records, *Ugarit Forschungen* 43, 345-410.
- Ryder, M. L. (1994) Fascinating Fullonum, *Circaea, The Journal of the Association for Environmental Archaeology* 11, 23-31.
- Shelmerdine, C. W. (1995) Shining and Fragrant Cloth in Homeric Epic. In J. B. Carter & S. P. Morris (eds.), *The ages of Homer: a tribute to Emily Townsend Vermeule*. Austin, Texas, 99-107.
- Singer, Ch., Holmyard, E. J., Hall, A. R., & Williams, T. I. (1962) *Storia della tecnologia*. Vol. II. *Le civiltà mediterranee e il Medioevo*. Torino.
- Smith, W. (1875) *A Dictionary of Greek and Roman Antiquities*. London.
- Umbarger, M. (2012) Abraham's Tamarisk, *Journal for the Evangelical Study of the Old Testament* 1/2, pp. 189-200.
- Uscatescu, A. (2010) En torno a la tendicula de Séneca (*Quaest. Nat.* 1, 3, 2). Una aproximación léxica e iconográfica a la *ars fullonia*, *Archivo Español de Arqueología* 83, 203-220.
- Veenhof, K. R. (1972) *Aspects of Old Assyrian Trade and Its Terminology*. Studia et documenta ad iura orientis antique pertinentia 10. Leiden.
- Von Bothmer, D. & Mertens, J. R. (1979) *Greek Art of the Aegean Islands. An Exhibition*. New York.
- Waetzoldt, H. (1972) *Untersuchungen zur neusumerischen Textilindustrie*. Studi Economici e Tecnologici I. Roma.
- Waetzoldt, H. (1985) Ölpflanzen und Pflanzenöle im 3. Jahrtausend, *Bulletin on Sumerian Agriculture* 2, 77-96.
- Whittaker, G. (2012) Euphratic: A phonological sketch. In B. Nielsen Whitehead, T. Olander, & B. A. Olsen (eds.), *The Sound of Indo-European: Phonetics, Phonemics, and Morphophonemics*, 577-606.
- Yasur-Landau, A. (2014) *The Philistines and Aegean Migration at the End of the Late Bronze Age*. Cambridge.
- Zawadzki, S. (2006) *Garments of the Gods. Studies on the Textile Industry and the Pantheon of Sippar according to the Texts from the Ebabbar Archive*. Orbis Biblicus et Orientalis 218. Fribourg/Göttingen.
- Zawadzki, S. (2013) *Garments of the Gods. Studies on the Textile Industry and the Pantheon of Sippar according to the Texts from the Ebabbar Archive. Vol. 2: Texts*, Orbis Biblicus et Orientalis 260. Fribourg/Göttingen.



## Garments, Parts of Garments, and Textile Techniques in the Assyrian Terminology: The Neo-Assyrian Textile Lexicon in the 1st-Millennium BC Linguistic Context\*

Salvatore Gaspa

[išp]arākma qê amahhaš ulabbaš ummānamma

[I a]m a weaver and beat up the threads. I clothe the troops.

*Tamarisk and Date Palm* (BWL 156, IM 53975 r.5)

At its political and territorial apex in the 8th and 7th centuries BC, Assyria developed into an imperial society characterised by the co-existence of languages and cultures of various origins. The policy of deporting and resettling conquered peoples across the Empire's territory caused the spread of the Aramaic language and alphabetic script as well as the use of Aramaic as a co-official language alongside Akkadian. The linguistic change caused by these events in the Empire's core territory emerges from the late stage of the Assyrian dialect, which shows the impact of Aramaic on various grammatical and lexical elements of the language. At the same time, Neo-Assyrian maintained continuous contact with the Neo-Babylonian dialect, the language spoken by numerous individuals employed in the state sector as scribes, scholars, and officials.

The study of the lexicon of material culture may reveal how these social and linguistic changes shaped the everyday language that emerges from Neo-Assyrian letters, administrative records, and legal

documents. For the terminology of textiles, it is interesting to observe the coexistence of terms belonging to the common Akkadian textile terminology with designations that are peculiar to the late dialects of Akkadian (1st millennium BC), namely Neo-Assyrian and Neo-Babylonian. Other terms, which are genuinely Assyrian, show continuity across the Middle Assyrian and Neo-Assyrian periods. A West Semitic component of the Neo-Assyrian textile terminology is also evident, along with terms possibly belonging to the Hurrian substratum, presumably inherited from the Middle Assyrian dialect, and others of unknown origin.

To judge from the statements in the royal annals of Assyrian kings concerning tribute and booty from the West Semitic sector, textile products from the Syrian region were highly esteemed by Assyrians. For instance, Tukultī-Ninurta II (890-884 BC) records the receipt of woven cloths and dark purple wool from Laqē, while linen garments with multi-coloured trim were a common product acquired by Assurnasirpal II (883-859 BC) and other kings from these regions,

\* This study is part of a research project on the terminology of textiles in the Neo-Assyrian Empire carried out by the author at the Danish National Research Foundation's Centre for Textile Research, University of Copenhagen in the period 2013-2015. Financial support for this study has been provided by the Marie Curie Intra-European Fellowship within the Seventh Framework Programme of the European Commission for research activities at the University of Copenhagen (ASTEX Project no. 36539). The *Danmarks Grundforskningsfond* / Danish National Research Foundation (DNRF 64) is also acknowledged for this support.

such as Bēt-Zammāni. Red-dyed wool garments with multi-coloured trim were also a major portion of the Western textile products obtained by the Assyrians, as evidenced by those from Sam'al and Damascus, mentioned in the royal inscriptions of Shalmaneser III (858-824 BC) and Adad-nērārī III (810-783 BC) respectively. All of these references demonstrate the value of Western dyed wool and linen products and the Assyrian interest in controlling the rich local textile production.<sup>1</sup> It is reasonable to surmise that the expertise of deported textile artisans from the West Semitic area was put to use by the Assyrian ruling elite in state-controlled textile workshops, thereby integrating Western traditions of textile manufacture with Assyrian and Mesopotamian traditions.<sup>2</sup> Presumably, these workshops, located in the main royal households of the Assyrian cities, employed artisans of various provenances and cultural backgrounds. In light of the Aramatisation affecting various sectors of Assyrian society and state organisation, which reached its apex in the 7th century BC, it is clear that the languages used in these textile workshops were Assyrian and Aramaic. All of the technical phases of the textile *chaîne opératoire*, from wool sorting to spinning, from weaving to dyeing, were certainly mirrored by a bilingual terminology. Unfortunately, the extant written documents on clay tablets record only a small fraction of the presumably rich bilingual vocabulary used by these artisans. We know that record-keeping in the Empire's *bureaux* during the 8th and 7th centuries makes use not only of Assyrian cuneiform on clay tablets or wooden (or ivory) waxed board-books but also Aramaic script on flexible material, namely scrolls, presumably of leather or papyrus.<sup>3</sup> The textiles produced for internal consumption by the Assyrian ruling elite and state sector as well as those produced for export were regularly recorded in administrative documents by the scribes. However, the parallel administrative records of these textiles on Aramaic scrolls have not survived. Consequently, our

ignorance of the Aramaic component of the aforementioned Assyro-Aramaic textile vocabulary – at least the one that entered the language of the administrators – renders any attempt to reconstruct the textile lexicon of the Neo-Assyrian Empire limited and partial. In addition to the Aramaic component, Assyrian imperial society of the 7th century BC was enriched by other ethnic groups, such as Elamites, Egyptians, Anatolians, Urartians and peoples from the Iranian area, not to mention other Semitic components, such as Levantines and Arabs. We are totally ignorant of the impact that the languages of these groups, which immigrated into the main cities of the Empire, had on the Assyrian terminology of material culture, especially textiles. It is reasonable to assume that special foreign textile products that were peculiar to their regions of origin were named in accordance with their original designations. However, the assimilation of these foreign groups and their backgrounds of technical terms into the Assyro-Aramaic culture of the Empire is another important process that was at work in this period. This process of unification and standardisation is visible in the case of foreign products (acquired by the Assyrians in the form of tribute or booty) that are named using Akkadian terms.

In the present contribution, observations on Neo-Assyrian textile terminology will concern garments and parts of garments.<sup>4</sup> For a limited number of terms, it is possible to identify the textile techniques after which the end products were named, although the available evidence does not enable us to reach definite conclusions regarding this aspect of the textile production.

### Producing and defining garments in Assyria

Garments and other items of clothing were produced in Assyria through the work-assignment system (*iškāru*), namely, through assignment of raw materials from the state to textile artisans, who were obliged

1. Lipiński 2000, 539-540.

2. Among the *sihirti ummānī*, 'all the craftsmen', who were brought out from the enemy's palace and deported to Assyria by the Assyrian kings there were also textile artisans. For references to deported foreign craftsmen in Sennacherib's royal inscriptions see, e.g., RINAP 3/1, 1:33; 17 i 38 and *passim*.

3. The visual evidence of Neo-Assyrian scribes holding scrolls and pens has been recently reviewed in Reade 2012, 702-704, figs. 1, 5-7, 9-11, 15, 16.

4. Terms designating head-gear are not included in this study.

to produce and return a certain quantity of finished products. Other textile end products were imported from abroad through trading by state merchants. Reconstructing the terminology of the weaving process and of tools used in the fabrication of garments is difficult since the majority of textile designations in Neo-Assyrian texts refer to finished products. In terms of weaving tools, the archaeological evidence for spherical clay loom weights and remains of carbonised wood from what had probably been a loom from the Neo-Assyrian site of Khirbet Khatunyeh<sup>5</sup> confirms that warp-weighted vertical looms were in use in Assyria.<sup>6</sup> Among the objects found at this site were also a wooden object, possibly a weaver's 'shuttle'<sup>7</sup> or bobbin and a flat bone spatula, pointed at one end, which has been interpreted as a 'beater-in' by Curtis and Green, although the correct designation would be 'weft-beater'.<sup>8</sup> Other weaving tools comprise clay spindle whorls.<sup>9</sup> Tools related to weaving and dyeing activities, such as loom weights, bone spatulae, and terracotta dyeing vats, were found at Til Barsip (Tell Ahmar).<sup>10</sup> All of these items were common equipment for textile artisans of the Neo-Assyrian period. For a number of these textile tools, it is possible to identify the term used by artisans. The dyeing vat, for instance, was called *našraptu* in Akkadian,<sup>11</sup> but we do

not know what loom weights were called in this language. For other items used by textile artisans, however, some suggestions can be made. Terms for the loom and its parts are not attested in the Neo-Assyrian corpus but only in lexical lists and in other periods of the Akkadian documentation. The translations given in the dictionaries are generic. Terms referring to parts of the loom were also used to designate parts of doors, indirectly confirming the use of vertical looms in Mesopotamia. Identification of different components of the loom is extremely difficult since the occurrences are predominantly attested, if not exclusively limited, to lexical sources (the lexical series HAR-ra = *hubullu*). We may reconsider the Akkadian terminology in light of what is known about the horizontal ground loom and the vertical loom. The *asû*, of which an upper (*elû*) and a lower (*šaplû*) variety are known,<sup>12</sup> probably refers to the heddle-bar and the shed-bar in the vertical loom and to the front and back beams in the horizontal loom.<sup>13</sup> The words *habbiru*, literally 'the noisy one',<sup>14</sup> and *madakku*, literally 'the crushing one',<sup>15</sup> probably refer to the weft beater. The item called *nîru*, literally 'the yoke, crossbeam',<sup>16</sup> could be identified with the shed-bar,<sup>17</sup> while the *nanšû*, could be the heddle-bar.<sup>18</sup> Giving the meaning of *akaiû* as a stick for driving donkeys,<sup>19</sup> it is possible that it refers to the sharp pointed

5. Curtis & Green 1997, 18-19 and fig. 22. The best preserved of these loom weights show considerable variation in diameter (from c. 6.0 to 7.2 cm), height (from c. 4.0 to 6.3 cm), and weight (from c. 126 to 218 g). See also *ibidem* 21 and fig. 25 (nos. 93, 96).

6. Pieces of warp-weighted looms are generally found in the Aegean area, Anatolia and the Levant. On the warp-weighted loom see Ellis 1976, 76; Barber 1991, 99-113; Völling 2008, 126-131; Andersson Strand 2015, 52-54.

7. Curtis & Green 1997, 20 and fig. 23 (no. 76).

8. Curtis & Green 1997, 20 and fig. 23 (no. 77). But note that the authors define the beater-in as a tool used to press down the weft thread after it has been threaded through the warp threads. This is not correct, since on a warp-weighted loom the wefts are passed upwards, not downwards, and the weft is beaten upwards. On the use of weft-beaters see Andersson Strand 2015, 52.

9. Curtis & Green 1997, 21 and fig. 25 (nos. 90-92). For a copper alloy needle from Level 3 see *ibidem* fig. 25 (no. 87).

10. See Bunnens 1997, 21.

11. CAD N/II, 51b s.v. *našraptu* B.

12. CAD A/II, 347b s.v. *asû* B.

13. These parts probably correspond to the *rās en-nōl* and *qā' en-nōl* of the horizontal loom used by Bedouins today. See Staubli 2012, 91 fig. 85.

14. CAD H, 14b translates the term as 'wool-lever'.

15. CAD M/I, 9a s.v. *madakku* 2.

16. CAD N/II, 263b s.v. *nîru* A 3b.

17. In the horizontal loom, still used by nomads in present-day Middle East, the loom's 'yoke' is called *minjar*. See Staubli 2012, 91 fig. 85.

18. The dictionaries suggest that the *nansû* was the 'lever'. See CAD N/I, 261b. For *maššû*, a variant of *nanšû*, see CAD M/I, 390b s.v. *maššû* A 2.

19. CAD K, 42a s.v. *kajû* 1; CDA, 154b.

stick or spatula used by the weaver as a beater. As for *mukānu* (from the verb *kānu*, ‘to be firm’?),<sup>20</sup> it could be another candidate for the shed-bar. Words for ‘shuttle’ or bobbin are (*w*)*āšītu*, literally ‘that which goes out’,<sup>21</sup> *mušabbītu*,<sup>22</sup> *šīšītu*, of which a large (*rabītu*), a small (*šihirtu*), a *ša paršikti* and a strong (*puggultu*) variety are used,<sup>23</sup> and *ukū*.<sup>24</sup> Alternatively, it is possible that the word *šīšītu* refers to the harness or the heddle of the loom.<sup>25</sup> Unfortunately, we do not know how all of these weaving tools were called in Assyria in the 1st millennium BC since the authors of the written records registering textiles were apparently not interested in the everyday tools used by artisans in the workshops.

Although the terms for textile tools used in Neo-Assyrian workshops remain unknown, we know from the written sources that the Assyrian artisans produced a wide variety of clothing items, such as garments, headdresses, and other textile accessories. Many of these clothes were produced for the palace elite, including royal women. Even if there are few indications of female garments in Neo-Assyrian texts, it is clear that a portion of the palace-controlled textile industry and international trade was determined by the demand for such textiles by women of the royal family. Already in the Middle Assyrian period, we see

that special textiles were produced for palace women, as evidenced by a Tell Ali text mentioning 30 minas of wool for the production of three Cypriot(-like?) *lubēru*-garments for six women.<sup>26</sup> When it comes to designations for garments, we may observe that Neo-Assyrian scribes still use common textile designations such as *labussu* (*lubussu*, *lubultu*, *lubuštu*),<sup>27</sup> *lubāru*,<sup>28</sup> and *šubātu*<sup>29</sup> to refer to garments in general terms. In contrast to CAD,<sup>30</sup> it seems that the last term was also used in Middle Assyrian period as a syllabic writing of the plural logography TÚG.HI.A.<sup>31</sup>

Given that the Ancient Near Eastern costume is, in Durand’s words, an ‘ensemble vestimentaire’,<sup>32</sup> that is, a unity constituted by multiple items of clothing that, presumably, varied across time, region, and social strata, it is possible that the generic term also referred to the main and visually dominant item of clothing worn by a person. In addition to the aforementioned names, terms for specific textile items could also be employed to designate a plurality of garments. Generic terms used to sum up textile products at the end of an enumeration of garments in inventory texts are *mihšu* (logographically written as TÚG.PA), ‘textile, woven fabric’ (from the verb *mahašu*, ‘to beat, weave’),<sup>33</sup> and *kuzippu* or *guzippu* (of unknown origin), probably simply intended as

20. CAD M/II, 183a. The etymology of the word is not indicated in the dictionaries.

21. CAD A/II, 356a s.v. *āšītu* 8. This implement was also called *iš nīri*, see *ibidem* in lexical section.

22. CAD M/II, 240b s.v. *mušabbītu* 1. The terms *āšītu* and *šīšītu* are variants of this word.

23. See CAD Š, 214b in lexical section. For the translation of *šīšītu* as ‘shuttle’ see CDA, 339b.

24. CAD U-W, 58a.

25. CAD Š, 214b.

26. Ismail & Postgate 2008, 172, no. 22:1-2 30 MA.NA SÍG.MEŠ / *a-na* 3 *lu-be-ri a-la-zi-a-e* / *a-na* 6 MÍ.MEŠ *a-na e-pa-še ta-ad-na*. See also *ibidem* 9 for one talent of wool for other female items of clothing.

27. SAA 2, 2 iv 15; 6:374; SAA 3, 34:30; SAA 7, 63 ii 9, 11; SAA 10, 189:9; 287:4, 6; 356:6; SAA 12, 36:17; SAA 13, 176:9, r.4, 11; 186 r.4; SAA 17, 186:9; Menzel 1981, no. 22 ii 9.

28. SAA 12, 83:13’. For Middle Assyrian attestations, see, e.g., KAJ 256:1, 9; *Iraq* 35 T.13, 1:22 (Freydank & Saporetti 1989, 85) and discussion in Postgate 2014, 419.

29. SAA 3, 7:13; 35:20; SAA 4, 23 r.3; SAA 8, 38:5; SAA 10, 238:14; SAA 11, 24 r.7; SAA 12, 35:26; 85 r.33; SAA 17, 11 r.5; 34 r.12; 69 r.14; 122:16; SAA 18, 183 r.5; 187 r.13; StAT 3, 1:1, 16; ND 2312:2 (*Iraq* 23 [1961], 21, pl. X); ND 2687 e.12 (*Iraq* 23 [1961], 43, pl. XXIII) and *passim*. For Middle Assyrian attestations, see, e.g., MARV X, 6:21’; 36:3; 45:8’; 53:3; 64 r.14’; 79:3; 82:1, 2, r.10 (all texts edited in StAT 5) and Postgate 2014, 423 for discussion.

30. CAD L, 228b.

31. Donbaz 1991, A 1722:1-2. See Postgate 2014, 423.

32. Durand 2009, 12.

33. CTN 2, 1:12’ (*dappastu*, SI.LUH, *kišiptu*, *nahlaptu*, *ša hīli*, *hulsu*, *gulēnu*, and *gammīdu*); Billa 71:7 (JCS 7 [1953], 137. The broken part of the line must be completed as TÚG.mi-[ih-šī]; this term is referred to the following textile products: *kusītu*, *ša hīli* and *zārāte*); ND 2672:7 (*Iraq* 23 [1961], 42, pl. XXII = TCAE 387: the term is referred to the textiles called *kitū* and *saddīnu*); SAA 7,

‘garment’ (see below). The beating operation referred to in the root *mḥš* is basically associated with the weaver’s use of weaving tools like the weaving swords and pin-beaters or weft-beaters. These tools, usually made of bone, served to unravel knots or remove impurities, position the weft correctly and tighten some points of the weft.<sup>34</sup> The word *mihšu* is used as a generic term in both Assyrian and Babylonian dialects of the 1st millennium BC.<sup>35</sup> In Assyria, it refers to a wide variety of garments and other finished textile products in texts from Kalhu (Nimrud),<sup>36</sup> Šibaniba (Tell Billa),<sup>37</sup> Nineveh (Kuyunjik),<sup>38</sup> and Tušhan (Ziyaret Tepe).<sup>39</sup> This use is already present in Middle Assyrian times, as shown by a document listing amounts of wool and summarising the textile end products as *mihšu*.<sup>40</sup> Instead, at the end of a list from Assur (Qal‘at Šerqāt), we find the word *kuzippu* having the same meaning as *mihšu*. In this case, the generic term refers to elements of clothing and other textiles coming from abroad, namely from the city or the region of Hamath (in present-day central Syria).<sup>41</sup> The semantic value of the word *kuzippu* as a generic textile term has already been

recognised by Radner<sup>42</sup> and Villard.<sup>43</sup> This use of the word *kuzippu* is confirmed by a letter sent by Urad-Gula to the Assyrian king, where different garments, collectively defined as *kuzippu*, is said to have comprised *gulēnus*, *kitūs*, and *maklulu*-garments.<sup>44</sup> In a fragmentary inventory text from Nineveh we find both *mihšu* and *kuzippu* at the end of a list of clothing items; the former is probably used to sum up all the linen garments, while the latter as a generic term for garments in the grand total section of the document.<sup>45</sup> The use of both terms as collective designations for textiles in the same text probably indicates a certain degree of specialization of the words *mihšu* and *kuzippu*, but conclusive observations about this aspect cannot be made in light of the extant Neo-Assyrian sources. In any case, these two terms were the common designations for textiles transported for trade. Usually, textiles were transported as wrapped in rolls with attached clay sealings or labels describing the contents of the shipment.<sup>46</sup> The practice of gathering garments into rolls, called with the Aramaic loanword *kirku*, is documented in dowry lists both in Assyria<sup>47</sup> and in Babylonia.<sup>48</sup>

---

108 r. ii' 1', 2' (various textiles of which only the designation *urnutu* is preserved); ZTT II, 33:8 (*elītu*, *maklulu*, *šupālītu halluptu*, *ša IŠ*, *iahilu*, and *datāiu*). But note that Postgate does not consider *mihšu* to be the Akkadian reading of the logogram PA. See Postgate 1973, 28. See also Postgate 2014, 407, commenting on the handling of felt in Middle Assyrian period, where he interprets the occurrence of this logographic writing as referring to sticks.

34. Peyronel 2004, 66.

35. For the Neo-Babylonian *mihšu* see Beaulieu 2003, 15.

36. CTN 2, 1:12'; ND 2672:7 (*Iraq* 23 [1961], 42, pl. XXII = TCAE 387).

37. Billa 71:7 (JCS 7 [1953], 137).

38. Ki 1904-10-9,154+ r.50 (*Iraq* 32 [1970], 153, pl. XXVII).

39. ZTT II, 33:8.

40. Postgate 1979, MAH 15854 A 9' a-na TÚG.mi-ih-ši [x] TA.ÀM up-pu-ša. Another occurrence of this word is in MARV VII, 23:5' *i+na mi-ih-š[i']*, the meaning of which is, however, obscure.

41. StAT 3, 1 r.35 PAB 3-me 86 *ku-zip-pe ša KUR.ha-ma-te* (the garments and other textiles in question are *kusītu*, *elītu*, *šupālītu halluptu*, *qarrāru*, *niksu*, *qirmu*, *gammīdu*, *maqāṭtu*, *dappastu*, SILUH, *nēbettu*, *nahlaptu*, *sasuppu*, *pariktu*, *ša muhhi šarri*, and *kitū*).

42. Radner 1999, 117.

43. Villard 2010, 389.

44. SAA 10, 289 r.3'-7' [x TÚG].<sup>c</sup> *gu'-zip-pi pa-ni-i'-ú'-[te]* / [ša UD]-'22'-KÁM ù ša ú-ma-a 'e'-[ru-bu-u-ni] / [TÚG].<sup>c</sup> *gul'*-IGI.2 TÚG'.GADA TÚG.*ma-ak-[li-li]* / 'x' [x]-šú' *am-mar'* *gab-bu-un-ni* / [x x x] *i-na-áš-ši*, “He is taking [for himself] the prime lot of garments [which came in on the 2]2<sup>nd</sup> day and today, (that is to say) [gu]lēnus, tunics, and mak[lulus], every single one of them”.

45. Ki 1904-10-9,154+ r.50-e.51 (*Iraq* 32 [1970], 153, pl. XXVII) [x x x x] TÚG.PA.MEŠ GADA [x x x] / [PAB' x x x x] *ku-zip-pi*, “[...] linen fabric [...] Total: [...] garments”.

46. See SAA 7, 93-106; SAA 11, 67.

47. ND 2307 e.23 (*Iraq* 16 [1954], 37, pl. VI). The word *kirku* also occurs in PVA 269 TÚG *kir-ku* = *ki-ir-ku*, ‘roll of textiles/fabric’.

48. Dar 530:8; Nbk 369:2. See CAD K, 408b s.v. *kirku* B b. On the use of *kirku* in Neo-Babylonian dowry lists, see Roth 1989-90, 30: ‘a roll of cloth’.

## Designations for garments

In the observations that follow, the Neo-Assyrian names of garments are discussed. Terms have been classified into three categories: 1) designations belonging to the common textile Akkadian vocabulary, that is to say, terms that are also attested outside the Neo-Assyrian dialect, namely in other dialects and periods (*e.g.*, in Middle Assyrian, Babylonian, *etc.*); 2) designations that are peculiar to 1st-millennium Akkadian dialects (*i.e.*, Neo-Assyrian and Neo-Babylonian), including terms of (possible) West Semitic origin; and 3) designations the meaning of which is unclear as well as non-Semitic words.

### *Assyrian designations belonging to the common Akkadian textile vocabulary*

*elītu*. The term seems to denote an upper garment or a (fringed) shawl.<sup>49</sup> Of this textile there were both a red (or purple?)<sup>50</sup> and a black variety.<sup>51</sup> Other qualifications, some of which are very common in Neo-Assyrian lists of textiles, are difficult to explain. We know, for example, that the red variety of the *elītu* could be of the country-/mountain-type (KUR = *mātu*, ‘country’, or *šadū*, ‘mountain’),<sup>52</sup> perhaps to be understood as naturally red, in opposition to other red dye varieties, such as the ‘red

of the port’ or ‘commercial red’ (KAR = *kāru*) and the so-called ‘limestone red’ (*pūlu*).<sup>53</sup> This overgarment seems to have had a red-coloured front-part, as witnessed by a list of commodities from Nimrud.<sup>54</sup>

*hullānu*. This name of a cloak or wool or linen wrap<sup>55</sup> is documented from Middle Babylonian times onwards. This textile was probably a cover or a wrap, to be used for garments and beds.<sup>56</sup> From administrative sources we may see that the *hullānus* could be qualified as *šuppu* (decorated?)<sup>57</sup> and that they were employed for beds,<sup>58</sup> perhaps, as bed-covers. Another list of textiles mentions house-wraps for women.<sup>59</sup> In this case, it is possible that the item was a cover. On the use of this textile by ladies we are informed from a letter of the crown prince Assurbanipal to his father, according to which an Aramaean woman put a *hullānu* on her neck.<sup>60</sup> That the *hullānu* was a sort of garment is also clear from a look at Middle Assyrian documents.<sup>61</sup> In the Middle Assyrian period, the luxury variety of *hullānu* could have cedar-tree decorations and sleeves (*ša ahāte*).<sup>62</sup> A variety with (figures) of (heraldically?) crossed *tešēnu*-animals, without sleeves, is also attested.<sup>63</sup> In Neo-Babylonian times, it constituted a component of wardrobes for statues of both gods and goddesses.<sup>64</sup>

49. CTN 2, 153:5; 155 r. v 10'; 224:1; 253; SAA 7, 102:4'; 103:2'; 105:9'; 112:6'; 127:8'; StAT 3, 1:4; ZTT II, 33:1. See AHw, 202a; CAD E, 98b; CDA, 70a. For the meaning ‘shawl’, see Postgate 2001, 380 and AEAD, 24b.

50. SAA 7, 105:9'.

51. SAA 7, 127:8'.

52. SAA 7, 105:9'.

53. See Fales & Postgate 1992, xxviii.

54. CTN 2, 155 r. v 11'. However, the logographic writing ZAG.MEŠ is interpreted by Postgate as referring to the sleeves, see Postgate 1973, 172.

55. AHw, 354a; CAD H, 229a; CDA, 119b; AEAD, 38b. But see Postgate 2014, 418 for the generic translation: ‘a luxury garment’.

56. CTN 2, 152:1; K 6323+ r. i' 10' (Kwasman 2009, 116); ND 2311:1 (*Iraq* 23 [1961], 20, pl. X); PVA 235, 236; SAA 7, 96:6'; 107 r.3'; 109 ii 3', iii 2'; SAA 16, 17 r.7'. See AHw, 354a; CDA, 119b. In addition to this meaning, CAD H, 229a also intends this textile as a blanket, while in AEAD, 38b the entry is translated as ‘cloak, wrap, hood’.

57. SAA 7, 96:6'. Postgate 2014, 425 tentatively suggests the translation of *šuppu* as ‘embroidered?’.

58. SAA 7, 109 iii 3'.

59. SAA 7, 107 r.3' [x x (x x) GÚ?].LÁ bē'-te' ša MÍ.MEŠ.

60. SAA 16, 17 r.6'-8'.

61. AfO 19, T.6:1-2, 3-4 (Freydank & Saporetti 1989, 52); MARV III, 71:1.

62. AfO 19, T.6:1-2 (Freydank & Saporetti 1989, 52). See Postgate 2014, 418 for discussion.

63. AfO 19, T.6:3-4 (Freydank & Saporetti 1989, 52). Cf. CAD T, 373b s.v. *tešēnu*: ‘a wild animal’.

64. See Beaulieu 2003, 15.

*kitû*. The term generally designates a linen textile, a cloth and a garment, probably a tunic.<sup>65</sup> In the Middle Assyrian period linen wraps (*nalbētu*)<sup>66</sup> as well as textiles of thick linen (*kitû kabartu*) were produced.<sup>67</sup> A Neo-Assyrian list of textile products from Assur mentions one white (or bleached?) linen garment (*kitû pašiu*).<sup>68</sup> In Assyria, linen cloth was also used to cover beds and chairs.<sup>69</sup>

*kusītu*. This textile designation has been interpreted as referring to a long garment falling straight to the ground, probably a sort of tunic.<sup>70</sup> The term is also attested in West Semitic, as witnessed by Aramaic *ksūṭā*, ‘garment’,<sup>71</sup> and Mandaic *kissūyā*, ‘veil’<sup>72</sup> (<*ksy*, ‘to cover’). From Middle Assyrian documents we see that this garment was made of wool<sup>73</sup> and that multi-coloured cloth (*birmu*) was used by palace weavers to produce the *kusītu*’s hem.<sup>74</sup> Analogous details we gain from Neo-Assyrian labels and accounts of textiles. The 1st-millennium *kusītu* could be red, of the country-type,<sup>75</sup> or multi-coloured.<sup>76</sup> *Kusītus* of various colours also occur among grave gifts in a royal funerary text.<sup>77</sup> White *kusītus* are documented in the Middle

Assyrian period.<sup>78</sup> In 2nd millennium BC Assyria, *kusītus* were produced for export, as witnessed by Bābu-aha-iddina’s archive.<sup>79</sup> It was also fabricated in the textile workshop in Dūr-Katlimmu (Tall Šēh Ḥamad), from which we learn that a quantity of 8 minas of wool served to produce a pair of these garments<sup>80</sup> and that, consequently, the amount needed for one *kusītu* was 4 minas, around 2 kilograms. As it may be observed from a list of textiles from Assur, *kusītus* could be a palm wide (*ša puškāie*).<sup>81</sup> A letter of Nabû-šarru-ušur informs us that some *kusītus*, which had to be delivered to King Esarhaddon (680-669 BC), were fabricated with red wool by the team of the weavers of (the temple household of) Ištar of Arbela<sup>82</sup>. It was especially used as an honorific form of dress; in fact, a letter reporting on Sennacherib’s death mentions eunuchs standing in the presence of the mayor, dressed in *kusītus* and adorned with rings.<sup>83</sup> Various examples of more or less elaborate and fringed long robes are depicted in palace reliefs as worn by the king, high ranking officials, and soldiers. This item of dress could be worn on its own or in

65. KAR 141:21 (Ebeling 1931, 88); ND 2672:5 (*Iraq* 23 [1961], 42, pl. XXII = TCAE 387); ND 2687:3, 4, r.6 (*Iraq* 23 [1961], 43, pl. XXIII); RINAP 3/2, 154 r.5’; 223:33; SAA 5, 152 r.10; 206 r.7’; SAA 7, 109 r. iv 3’; SAA 10, 289 r.5; SAA 11, 26 r.5; 31 r.7; StAT 3, 1 r.32. See AHw, 495b; CAD K, 473a; CDA, 163a; AEAD, 51a.

66. KAV 99:16-17. The masculine form of *nalbētu* is *nahwū*, attested in Mari. See Durand 2009, 178.

67. KAV 100 r.23.

68. StAT 3, 1 r.32.

69. SAA 7, 115 r. ii 5.

70. Billa 71:2 (JCS 7 [1953], 137); K 6323+ iii 23, 27 (Kwasman 2009, 115); PVA 237, 238; SAA 3, 23:4; SAA 7, 99:1; 105:6’, 7’; 112:6’; SAA 16, 84:8; 95:8; SAA 17, 122:7; StAT 3, 1:2, 3, r.22. For Middle Assyrian occurrences, see AfO 19, T.7, 1:3 (Freydank & Saporetto 1989, 53); KAV 200 r.3; MARV III, 5:8’, r.38’. For the word, see AHw, 514b; CAD K, 585b; CDA, 170a. For the meaning ‘toga’, see AEAD, 52b. A discussion on this item of dress is in Postgate 2001, 378-381. In Postgate 2014, 419 the term is translated as ‘robe’. The etymology of *kusītu* is discussed in Michel & Veenhof 2010, 226.

71. DJPA, 265a; DJBA, 590b; Jastrow 1950, 652b; DNWSI, 522.

72. Drower & Macuch 1963, 220.

73. MARV III, 5:8’. For a blue variety of *kusītu*, see MARV X, 3:14 (StAT 5, 3) 1 TÚG.BAR.DUL ZA.G[IN’], “One blu[e] (wool) *kusītu*-garment”.

74. MARV III, 5 r.38’-39’.

75. SAA 7, 105:7’.

76. SAA 7, 99:1; 105:6’.

77. K 6323+ iii 23 (Kwasman 2009, 115).

78. MARV III, 5:8’.

79. Postgate & Collon 1999-2001, text BM 108965:2. See also Postgate 2014, 419.

80. Rölliig 2002, text 12.7:8 8 MA.NA 2 TÚG.BAR.DUL.

81. StAT 3, 1 r.22. However, Faist considers the qualification *ša puškāie* as referring to a toponym; accordingly, she translates the occurrence 3 TÚG.BAR.DUL *ša pu-uš-ka-a-a* as “3 puškäische *kusītu*-Gewänder”. For the use of the *pušku*-measure in qualifications of textiles in Neo-Babylonian and Neo-Assyrian texts see CAD P, 542b-543a s.v. *pušku* A b.

82. SAA 16, 84:8-r.11.

83. SAA 16, 95:7-9.



association with a fringed shawl or a shirt.<sup>84</sup> The use of the *kusītu* by soldiers is witnessed by a Middle Assyrian document which mentions *kusītus* of the king's troops (*kusītu ša šāb šarri*) among other textiles destined to the army.<sup>85</sup>

*kuzippu*. This name refers to a garment, a cloak or a suit (of clothes).<sup>86</sup> It is possible that the textile designation *kišiptu* is related to *kuzippu* (see below).<sup>87</sup> No etymology is provided by dictionaries. The connection of *kuzippu* to the root \**kzp/kšp* is doubtful in light of its meaning 'to think, estimate'. Instead, the possibility that *k/guzippu* is a compound name related to the word *qušippu* (also *quzippu, qušippatu*),<sup>88</sup> an Akkadian loanword in Sumerian (written as *gu zi.ip.pa.tum/zi.ba.tum/zí.ba.tum*), has never been considered by scholars. The compound word seems to be based on the terms *qu*, 'thread, string', and *šippātu*, a term of unknown meaning probably referring to the material or quality of the thread.<sup>89</sup> If this working hypothesis is valid, the garment designation probably referred to characteristics of the thread used in its manufacture. The *kuzippu*, also attested with voiced plosive [g], *guzippu*,<sup>90</sup> was a wool garment<sup>91</sup> of which both white<sup>92</sup> and red types<sup>93</sup> were

in use in Assyria. A dowry list includes *kuzippus* of commercial red wool ('red wool of the port')<sup>94</sup> as well as white *kuzippus*.<sup>95</sup> Palace weavers in charge of the production of such a garment were able to create very elaborate types of *kuzippus*. A Ninevite textile label mentions a *kuzippu* studded with stones,<sup>96</sup> clearly a textile befitting a member of the Assyrian royal family; an example of such a decorated garment is probably to be recognised in the mineralised textile remains with cornelian beads discovered in the Nimrud royal burial.<sup>97</sup> It is known that the foreign noblemen and messengers who were received by the Assyrian court with great honours were dressed in precious robes: this is the case of the son of a nobleman from an eastern country in the reign of Sargon II (722-705 BC), who received a *kuzippu* and silver bracelets at his arrival.<sup>98</sup> The palace weavers also produced an ordinary and presumably standard variety of this clothing item for the military personnel. An account concerning the consumption of raw materials for textiles records 2 talents of madder for making the clothes of the chariot-fighters and the archers' *kuzippus*.<sup>99</sup> In this connection, it is interesting to note that *kuzippus* were also used

84. Postgate 2001, 379-380.

85. Postgate 2001, 376, text MAH 16086, A ii 11, 13.

86. CTN 2, 152 e.9; Ki 1904-10-9,154+r.36, 51 (*Iraq* 32 [1970], 152-153, pl. XXVII); ND 2097:6, 7 (*Iraq* 23 [1961], 18-19, pl. IX); ND 2307:14, 17, r.3 (*Iraq* 16 [1954], 37, pl. VI); ND 2312:1 (*Iraq* 23 [1961], 21, pl. X); ND 3413:2 (*Iraq* 15 [1953], 139, pl. XI); SAA 1, 246:8; SAA 2, 5 iv 16; SAA 3, 34:30; 35:60; SAA 7, 97:13'; 112:3'; 115 ii 20; SAA 10, 87 r.2, 5; 189:10; 226 r.3; 234 r.4; 235:6; 246:8, 11, r.7; 258:2; 264 r.1; 270 r.6; 275 r.4; 289 r.3, 10; 293:28; 294 r.28, 35; 338:13; 339:12; 340:11; 387 r.3; SAA 11, 67:1; 176 r.6; SAA 13, 33 r.9; 37:8; SAA 15, 90:25; 91 r.2; 259 r.8; SAA 16, 5:6; 83 r.3; 159:3; SAA 19, 6 r.14', 16'; StAT 2, 244 s.4; 315 e.10; StAT 3, 1 r.35. See AHw, 519b; CAD K, 615b; CDA, 171b; AEAD, 53b.

87. Faist 2007, 13.

88. CAD Q, 332b: 'a type of thread'. Instead, AHw, 515b and CDA, 170b do not offer any translation of this term, although AHw suggests a possible relation between *kušippu* and *kuzippu*.

89. CAD Q, 332b. We wonder whether the word in question is *šippatu*, 'reed' (CAD Š, 203b). Does this word also mean 'fiber'? On the correspondent Aramaic word *šbt* see DJBA, 951b: 'fiber'.

90. The preference for voiced forms seems to be due to the voiced context or voiced root-context, see Hämeen-Anttila 2000, 15-16.

91. See, e.g., ND 2307:14 (*Iraq* 16 [1954], 37, pl. VI); SAA 10, 87 r.2'-3'.

92. ND 2307:17 (*Iraq* 16 [1954], 37, pl. VI); SAA 10, 87 r.5'.

93. ND 2307:14 (*Iraq* 16 [1954], 37, pl. VI).

94. ND 2307:14 (*Iraq* 16 [1954], 37, pl. VI).

95. ND 2307:17 (*Iraq* 16 [1954], 37, pl. VI).

96. SAA 7, 97:13'. Garments studded with stones are documented in the written sources of other periods of the Ancient Near Eastern history. See Durand 2009, 72, concerning the item called *nahZaBu*. See also Beaugéard 2010, 288: 'une chemise ornée de pierres précieuses'.

97. Crowfoot 1995, 113.

98. SAA 15, 91 r.1-2. See also SAA 15, 90:25-26.

99. SAA 7, 115 ii 19-20.

as uniforms for soldiers and for the Itu'a troops.<sup>100</sup> Analogous considerations may be made about the use of *kuzippus* by the king's bodyguards.<sup>101</sup> The fact that *kuzippus* as well as other textiles were commodities frequently transferred within the imperial territory is confirmed by a sealing, *i.e.* a circular-shaped piece of clay bearing impressed a stamp seal; this inscribed object accompanied an unspecified number of *kuzippus* and *šipirtu*-textiles.<sup>102</sup> The large circulation of these two items was probably due to the presence of units of the royal army in different area of the imperial territory and to the constant need of provisioning the troops with uniforms and other textiles of everyday use. The sealing operation concerning textiles which had to be delivered from a place to another within the imperial territory is also attested in a letter of Sargon's royal correspondence concerning tunics (*kitû*) stored in Dūr-Šarrukēn (Khorsabad).<sup>103</sup> In Neo-Assyrian letters the term *kuzippu* is also employed to indicate the king's dress<sup>104</sup> and the garments of the statue of the substitute king.<sup>105</sup> From a Marduk-šākin-šumi's letter we also learn that *kuzippus* were used in rituals to be performed in the sacred *qirsu*-place; the king's scholar specifies that the garments had to be used as clothing of skulls.<sup>106</sup> Another garment whose use is connected with the *qirsu*-place is the *pazibdu* (see below). We may also observe that in mourning periods the king was clothed in white robes.<sup>107</sup> In addition, the royal clothes were used as a substitute for the king when he could not participate in the processions of the gods in person.<sup>108</sup> It is also clear that

the term *kuzippu* was used by Assyrian scribes to indicate garments in general (see above). Perhaps this meaning also fits many of the attestations quoted above. This use of the word may be seen, for example, in the end of a textile list from Assur, where all the items are totalled and qualified as *kuzippus* coming from the land of Hamath, as observed above.<sup>109</sup> From the literary text of the *Marduk Ordeal*, it is also clear that the generic semantic value of the word *kuzippu* is different from that of *lubussu*; in fact, *kuzippu* denotes the individual character of the garments in question, not just their being clothing.<sup>110</sup> An administrative document also informs us that a wooden container, called *bēt kuzippi*, was used to store such textiles. This object must have been a characteristic piece of furniture in the royal palace, given the importance, the richness, and the variety of garments that the king and the royal family's members used during private and public occasions.<sup>111</sup> In a marriage contract, different *kuzippus* are listed, among which one pair of *kuzippus* qualified by the obscure designation *magarrūti* occurs.<sup>112</sup> Summing up, the term *kuzippu* appears as a versatile designation for garments, both of luxury (*i.e.*, those of the elite) and ordinary types (*e.g.*, those worn by members of the Assyrian army).

*lamahuššû*. This is a Sumerian loanword in Akkadian and denotes a wool precious garment used for ceremonial purposes.<sup>113</sup> This expensive garment is already attested in Ur III period as well as in Old Babylonian and Old Assyrian times. This textile

100. SAA 19, 6 r.14'.

101. Ki 1904-10-9,154+ r.36 (*Iraq* 32 [1970], 152, pl. XXVII) [x+]6 T[ÚG.k]u-zip-pi [ša?] LÚ.qur-bu-te.

102. SAA 11, 67:1.

103. SAA 5, 206 r.6'-8'.

104. SAA 10, 234 r.4-6; 235:6-15; 339:12; 340:11-12; SAA 13, 37:8.

105. SAA 10, 189:10-11.

106. SAA 10, 264 6-r.2.

107. SAA 10, 234 r.4-6; 235:6-15.

108. SAA 10, 339:12-13; 340:9-12. See also SAA 10, 338:13. On the king's clothes in the city of Arbela see SAA 10, 287:3-6.

109. StAT 3, 1 r.35.

110. SAA 3, 34:30 *la-bu-su-šu ša a-na* <sup>d</sup>GAŠAN—UNUG.KI *ú-še-bal-u-ni ku-zip-pi-šu šu-nu*, "His clothing which they send to the Lady of Uruk is his robes."

111. SAA 7, 119 i 19', ii 14'.

112. ND 2307 r.3 (*Iraq* 16 [1954], 37, pl. VI).

113. AHw, 532a; CAD L, 58b; CDA, 176b; AEAD, 54a.

name was also known with variants with initial *n*, like, for instance, *namaššuhum* (Old Assyrian) and *namanšu 'um* (Old Babylonian).<sup>114</sup> In Mari it indicated both a luxury garment and a precious fabric for furniture.<sup>115</sup> The *lamahuššû* was an integral part of the wardrobe of the statue of the goddess in Neo-Babylonian times.<sup>116</sup>

*maklulu* or *muklālu* (*muqlālu*). This term, derived from the verb *qalālu*, ‘to be light, weak’, seems to denote a wool shawl or a cape.<sup>117</sup> In a Middle Assyrian text wool garments (*lubēru*) with their *maklalu* are listed.<sup>118</sup> The textiles in question are qualified as garments *ša šēri*, ‘of the steppe/countryside’, perhaps, to be intended as garments with capes which were used for travel or which were characteristic of the nomads’ dress. Postgate suggests the translation ‘hood’.<sup>119</sup> Moreover, it seems that in 2nd-millennium BC Assyria also *maklulus* for work (*ša šipri/KIN*) were in use.<sup>120</sup> The Neo-Assyrian *maklulu* came in two varieties: one with sleeves and one without sleeves.<sup>121</sup> Administrative texts dealing with textiles tell us that the *muklālu* could be made of *biršu*, and that it could have a red coloured front-piece and (precious) stones sewn onto it,<sup>122</sup> perhaps along the border. Another document specifies that the colour used for the front-part of the *muklālu* was the commercial red.<sup>123</sup>

*nahlaptu*. This name of textile, which is already attested at the beginning of the 2nd millennium BC,<sup>124</sup> derives from the verb *halāpu* I, ‘to cover, clothe (with)’, probably refers to a wrap and to a coat or armour<sup>125</sup> used by Assyrian soldiers. This designation was also certainly used to indicate the metal scale armours imitating the homonymous wool coats. In fact, a record of copper items mentions a light bronze *nahlaptu* to be polished,<sup>126</sup> in all likelihood a soldier’s coat of mail. Assyrian troops dressed in such armours are mentioned in the correspondence of Esarhaddon.<sup>127</sup> Moreover, the characteristic scale texture of the Assyrian armours is intended in the curse section of two Neo-Assyrian treaties, where we find a simile equating leprosy with the *nahlaptu*-garment.<sup>128</sup> An alternative logographic form of the word was TÚG.DÙL (= *šulūlu*, literally, ‘shelter, protection’), attested in a document from Tušhan (Ziyaret Tepe) concerning a set of clothing for soldiers.<sup>129</sup> As clearly shown by two Middle Assyrian documents concerning textiles, it seems that the production and the supply of *nahlaptus* as well as other textile products to the army was a concern of the Assyrian central administration. We are informed about the centralised production of this item of dress in Assyria

114. See Michel & Veenhof 2010, 229, 237.

115. See Durand 2009, 57, suggesting that it could “servir de toile à matelas, donc pour installer une couche d’apparat”.

116. See TCL 13, 233:4 (cited in CAD L, 59a).

117. CTN 2, 152:2, 6, r.11; 224:2; ND 2311:2 (*Iraq* 23 [1961], 20, pl. X); PVA 250; SAA 10, 289 r.5; ZTT II, 33:2. See AHw, 590a; CAD M/I, 137b; CDA, 192a. For the meaning ‘cape’, see AEAD, 59a.

118. KAV 99:15-16.

119. Postgate 2014, 420.

120. MARV I, 24:7' 1 TÚG.ma-ak-lu-lu ša KIN šī-pár x[x x x]. The same qualification also applied to *šubātus* in KAV 99:15; MARV I, 24:6; MARV III, 5:28'. One wonders whether the qualification *ša UD.MEŠ* (Postgate 1979, 7; see Postgate 2014, 425: ‘for everyday (use)?’) was an alternative way to indicate clothing for work in Assyria.

121. CTN 2, 224:2-3.

122. SAA 7, 96:7'.

123. SAA 7, 105:8'.

124. See, e.g., the occurrences of the term in Mari and Old Assyrian texts. See, respectively, Durand 2009, 67-72 and Michel & Veenhof 2010, 236-237.

125. AfO 8 (1932-33), 178:17; CTN 2, 1:10'; KAR 141:17 (Ebeling 1931, 88); PVA 221; SAA 3, 17:32; 32 r.10; SAA 7, 89 r.8; SAA 10, 238:15; 345 r.9; SAA 16, 95 r.9'; Sg 8 411; StAT 3, 1 r.26, 33; ZTT I, 8:3. For Middle Assyrian attestations see, e.g., Billa 61 r.19 (JCS 7 [1953], 135); KAJ 231:1, 6; 256:7; 279:6; KAV 200 r.3; MARV III, 5:9', 10', 16', 18', 20', e.26'; 71:2, 3,5; MARV VIII, 73:1; 97:5. See AHw, 715a; CAD N/I, 138a; CDA, 232a; AEAD, 71b; Postgate 2014, 421.

126. SAA 7, 89 r.8-9 GÚ.È URUDU Q[ÁL]-tú / ša ka-pa-a-ri, “a bronze armour, *l[igh]t*, to be polished”.

127. SAA 16, 95 r.8'-9'.

128. SAA 2, 2 r. iv 4-5; 11 r.10'-11'.

129. ZTT I, 8:3. The term is translated by Parpola as ‘coat of mail’. See Parpola 2008, 57 for discussion.

since the 2nd millennium BC. Two Middle Assyrian documents reflecting the management of the palace-oriented textile production are particularly interesting: one of them is a list of finished textiles which had to be supplied by a number of contributors; among the listed textiles there are finely executed and decorated(?) coats for battles (*nahlaptu ša dīkāti ša 'uptu qatattu*).<sup>130</sup> In contrast, no explicit reference to military use is made concerning the wool *nahlaptus* recorded in a Middle Assyrian account of work quotas of palace weavers,<sup>131</sup> although the reference to leggings and chariots in the text supports this hypothesis.<sup>132</sup> That the *nahlaptu* constituted a characteristic element of the military uniforms also in the 1st millennium BC is confirmed by the mention of *nahlaptus* (written as *nahhaptu*<sup>133</sup>) of the military unit of the Qurraeans in two Neo-Assyrian lists from Nineveh.<sup>134</sup> In the Middle Assyrian period varieties of *nahlaptu* of red,<sup>135</sup> red-purple,<sup>136</sup> blue,<sup>137</sup> blue-black (or blue-purple),<sup>138</sup> white,<sup>139</sup> and multi-coloured wool<sup>140</sup> were produced. The

2nd-millennium *nahlaptu* could be provided with sleeves (Ā.MEŠ) and breast-pieces (GAB.MEŠ) of red wool.<sup>141</sup> Furthermore, the fact that a *nahlaptu* occurs in a document listing what seem to be royal gifts for a woman<sup>142</sup> shows that the designation also applied to a wrap or coat used by ladies. In this connection, we may note that ordinary coats occur in a Neo-Assyrian dowry list of a marriage contract from Kalhu.<sup>143</sup> With the same textile designation a wrap for beds was also intended.<sup>144</sup> As far as the Neo-Assyrian period is concerned, we may see that in the 1st millennium BC too the *nahlaptu* comes in several varieties. The *Practical Vocabulary of Assur* lists multi-coloured,<sup>145</sup> red,<sup>146</sup> red-purple,<sup>147</sup> blue-black (or blue-purple),<sup>148</sup> scarlet,<sup>149</sup> and *huhhurāti*-dyed<sup>150</sup> types of *nahlaptu*, as well as a house-quality,<sup>151</sup> a variety used for the breast (or, perhaps, a variety with breast-piece?),<sup>152</sup> and one to be used in association with the obscure *kirnāiu*-garment.<sup>153</sup> The list also includes *nahlaptus* with designs (*ušurtu*)<sup>154</sup> and a linen-variety.<sup>155</sup> Of other

130. Postgate 2001, 376, text MAH 16086; Postgate 2014, 425.

131. MARV III, 5:9', 10', 16', 18', 20', e.26'.

132. Gaspa 2013, 231.

133. For the variant *nahhaptu*, which is already attested in the Middle Assyrian period, see KAJ 77:9 (Postgate 1988, text no. 53) 1 TÚG.na-ha-ap-ta.

134. SAA 7, 112 r.1-2; 115 ii 18.

135. MARV III, 71:2 (StAT 5, 92:2); MARV X, 8:1 (StAT 5, 8); 35:1 (StAT 5, 35).

136. MARV III, 5:10', 16', 18'; MARV X, 40:5-6, e.7-r.9 (StAT 5, 40). Note that in this text the amounts of red purple wool (ZA.GÌN.MI) are summarised in the total as *šerpu*, 'red (wool)'. See *ibidem* r.13.

137. MARV X, 77:1 (StAT 5, 77).

138. MARV III, 71:3 (StAT 5, 92); MARV VIII, 97:4; MARV X, 40:1-3 (StAT 5, 40); 64 r.14 (StAT 5, 64).

139. MARV III, 5:20'; MARV X, 8:2 (StAT 5, 8); 36:1 (StAT 5, 36); 59 r.10 (StAT 5, 59); 77:2 (StAT 5, 77).

140. MARV III, 71:5 (StAT 5, 92); MARV VIII, 97:5.

141. MARV III, 5:17'. *Nahlaptu*-garments with sleeves and breast-pieces are also attested in MARV I, 24:13'.

142. MARV VIII, 73:1.

143. CTN 2, 1:10' 6 TÚG.'GÚ'.È.MEŠ *sad-ra-te*.

144. SAA 7, 109 iii 2'-3' G[Ú].LÁ] / NÁ [0].

145. PVA 222.

146. PVA 229.

147. PVA 227.

148. PVA 228.

149. PVA 230.

150. PVA 226.

151. PVA 223.

152. PVA 224.

153. PVA 233. 154. PVA 225.

155. PVA 234.

156. PVA 232. For the reconstruction of the line, see Postgate 1973, 28 and CAD P, 543a.

two varieties mentioned in this lexical list, one is qualified with the palm-measure (*pušku*),<sup>156</sup> but the use of this unit of measure in connection with textiles escapes us. The same measure also characterises scraps of textiles in a marriage transaction document from Nimrud<sup>157</sup> and *kusītus* in a list of textiles from Assur.<sup>158</sup> In addition to the above-mentioned types, a white variety was also produced in the Neo-Assyrian period.<sup>159</sup> Concerning ritual use, we see that a wool white *nahlaptu* was used in a ritual for the Daughter-of-the-River.<sup>160</sup> Assyrian weavers produced both long and short *nahlaptus*; a short variety is documented in the above-cited list of garments from Assur.<sup>161</sup> Another use of this textile was to cover chariot parts. In fact, in a document from Middle Assyrian Assur a *nahlaptu* is associated with the dust guard of the king's chariot.<sup>162</sup>

*nēbuhu*. This is a designation for a band, belt or sash,<sup>163</sup> derived from the verb *ebēhu*, 'to gird, belt up'.<sup>164</sup> From Middle Assyrian documents we see that *nēbuhus* of both red<sup>165</sup> and white wool<sup>166</sup> were produced. Another text specifies the different purposes for which this item of clothing was fabricated in the state textile workshops:<sup>167</sup> the text only refers to the female weavers of Nineveh, whose

work assignments are constituted by the textiles listed in this document. The mention of the god Bēl-šarru is probably an indication that these textiles were destined for the wardrobe of this deity. We know that Ištar's statue was clothed with this item of dress in 1st-millennium BC Babylonia.<sup>168</sup> *niksu*. The word literally means 'cut, piece' (from *nakāsu*, 'to cut'); it probably designated a standard piece of cloth used as wrap,<sup>169</sup> although Middle Assyrian attestations seem to confirm that it was a specific kind of garment. *Niksus* are listed in a document along with amounts of coloured wool and garments, suggesting that they were specific clothing items.<sup>170</sup> In the Neo-Assyrian period, this garment is attested in a legal document listing materials to be used for the king's *sasuppu*-napkin. The text mentions a depot of four unknown items (textiles?) and four *niksus*, fine work belonging to a god and at disposal of a chief weaver.<sup>171</sup> In a document from Ziyaret Tepe, two *niksus* occur in the context of clothes for soldiers.<sup>172</sup> Details on *niksus* are provided by a list from Assur, from which we learn that this kind of wrap could be white<sup>173</sup> with red sides and front-part (UŠ ZAG SA<sub>5</sub>).<sup>174</sup> The same text also mentions a Babylonian variety,<sup>175</sup> but no indications are given about what

157. CTN 2, 1:5'.

158. StAT 3, 1 r.22.

159. StAT 3, 1 r.26.

160. KAR 141:17 (Ebeling 1931, 88).

161. StAT 3, 1 r.33 68 TÚG.GÚ.È *kūr-ri*.

162. MARV X, 5:1-2 (StAT 5, 5) [x x x x] ME 5 'ŠU'.SI GÚ.È / [x x x x GI]Š.'sa'-har-ge-e GIŠ.GIGIR 'ša' 'GÌR' MA[N].

163. ND 3407:3 (*Iraq* 15 [1953], 138, pl. XI); PVA 243; SAA 7, 115 ii 16. See AHw, 773b; CAD N/II, 143a; CDA, 248b; AEAD, 76a; Postgate 2014, 421.

164. CDA, 64b.

165. MARV X, 3:14 (StAT 5, 3).

166. MARV X, 3:14 (StAT 5, 3).

167. MARV X, 69:4-5 (StAT 5, 69) 6+x' TÚG.ÍB.LÁ 'ša' na[m]-hi-ri / 35' TÚG.ÍB.LÁ.MEŠ / ša lu-uš-me. The meaning of the terms *namhiru* and *lušmu* is unclear.

168. Beaulieu 2003, 15.

169. See AHw, 789b; CAD N/II, 231b; CDA, 253b; AEAD, 77a.

170. MARV I, 24:2, 3, 14. *Niksus* and other textiles are summarised as TÚG.lu-bul-tu SIG<sub>5</sub>-tu, 'good-quality clothing', in *ibidem* 12. See Postgate 2014, 422 for discussion. For other attestations of this textile in Middle Assyrian texts, see Faist 2001, 6 (Two *niksus* [and/for?] one Assyrian *lubēru*); Radner 2004, 82, no. 4:30-31; MARV X, 10:1 (StAT 5, 10).

171. SAA 6, 190:2.

172. ZTT I, 8:3.

173. StAT 3, 1:10.

174. StAT 3, 1:11. Faist tentatively suggests the translation of 'mit roter Borte' for the qualification UŠ ZAG SA<sub>5</sub>.

175. StAT 3, 1:r.31 1 TÚG.nik-su KUR URI.KI'. Literally, '(of) the Land of Akkad'.

176. See AHw, 1003a s.v. *sāgu* I: 'ein Arbeitsschurz?'; CAD S, 27b s.v. *sāgu*: 'a piece of clothing'; CDA, 310b s.v. *sāgu* I: 'a skirt,

differentiates the Babylonian *nixsu* from the Assyrian counterpart.

*sāgu*. This term has been interpreted as a name for ‘sack’ and for a garment.<sup>176</sup> In Neo-Assyrian texts<sup>177</sup> it probably represents the Assyrian counterpart of the Neo-Babylonian *saqqu*,<sup>178</sup> a designation for a sack and a garment, and the Aramaic *saq*, *saqqā*, analogously meaning ‘sack’ and ‘sackcloth’.<sup>179</sup> In light of the meaning of the word, it is clear that this garment was made with the coarse cloth of sacks. In Assyria, the occupation dealing with the production or trade of these garments was called *ša sāgātēšu*.<sup>180</sup> In light of a letter dealing with Aramean troops going on a campaign, it seems that *sāgus* were a component of travel equipment along with leather bags, sandals, food and oil.<sup>181</sup> The word has long been considered a 1st-millennium textile term in the Assyrian dialect. However, the fact that the same word also occurs in Middle Assyrian administrative documents from Assur<sup>182</sup> demonstrates that it was already known in the 2nd millennium BC. On von Soden’s authority, Prechel and Freydanck tentatively translate the Middle Assyrian word as ‘Arbeitsschürze’.<sup>183</sup>

*sunābu* (or *sunāpu*). The term seems to be derived from *sanāpu*, ‘to tie on’, and designates a bandage or loincloth.<sup>184</sup> The translation of the word as ‘sanitary towel’ is suggested in CDA.<sup>185</sup> This textile is only mentioned in PVA. Durand states that this term is *hapax* in Akkadian.<sup>186</sup> However, another attestation may be found in a Middle Assyrian text from Kār-Tukultī-Ninurta (Tulūl al-‘Aqir).<sup>187</sup> According to Durand, the word may be explained as an Akkadianisation of Hurrian \**suni-we*, meaning ‘habit à *sūnu*’ (see below).<sup>188</sup> If this interpretation is valid, the term *sunābu* does not derive from the verb *sanāpu*.<sup>189</sup>

*šaddīnu*. The form *šaddīnu*, with initial <š>, is a peculiarity of the Neo-Assyrian dialect.<sup>190</sup> In the Western Semitic area the same word has initial <s>, as shown by Hebrew *sādīn* and Aramaic *sedīnā*. The 2nd-millennium attestations show that the form was originally *sadinnu*.<sup>191</sup> Its early attestations in texts from Mittanni and the doubled consonant in the ending (-*innu*) point to a non-Semitic word which, according to Kaufman, could be of Anatolian origin.<sup>192</sup> The Aramaic *sdyn*, *sdyn*, ‘sheet’, refers to a textile usually made of

kilt’; AEAD, 96b: ‘sackcloth’. See Fales 1983, 68 for the interpretation of *sāgu* as a name for garment. However, the term is usually translated as ‘sash’ by many scholars, see, e.g., Fales & Postgate 1992, 221b; Fales & Postgate 1995, 167a; Luukko & Van Buylaere 2002, 192a.

177. ABL 75:7 (LAS 37); ND 2311:10 (*Iraq* 23 [1961], 20, pl. X); ND 2424:1, 4, r.11 (*Iraq* 23 [1961], 24, pl. XII); ND 3467 r.5 (*Iraq* 15 [1953], 146, pl. XIII); RINAP 1, 48:5’; SAA 3, 23:4; SAA 7, 125:7; SAA 11, 28:14; 36 ii 14; SAA 16, 20 r.7’; SAA 19, 17 r.1; TH 48:12; TH 52:11.

178. Postgate 2001, 384. See CAD S, 168b.

179. LS, 493b; Sokoloff 2009, 1036b; DJBA, 828b; Jastrow 1950, 1019a; DNWSI, 1186.

180. NATAPA 2, 67:2.

181. SAA 19, 17 e.12-r.4.

182. MARV X, 3 r.36’, 37’ (StAT 5, 3); 15:1, e.4 (StAT 5, 15).

183. See StAT 5, 17, 34, 132b.

184. AHW, 1058b; CAD S, 383b; AEAD, 101a.

185. CDA, 328a.

186. Durand 2009, 95 fn. 133.

187. MARV IV, 89 ii 51’.

188. Durand 2009, 95 fn. 133.

189. The connection of the word *sunābu* with the verb *sanāpu* is given in the dictionaries. See AHW, 1058b; CAD S, 383b; CDA, 328a.

190. Hämeen-Anttila 2000, 9-10; Lipiński 1997, 123 § 14.2.

191. See CAD S, 17a.

192. See Kaufman 1974, 94, fn. 324 and Mankowski 2000, 110 for further literature.

193. DJBA, 788a; Jastrow 1950, 957a.

fine linen.<sup>193</sup> This West Semitic form is probably at the basis of Greek σινδών.<sup>194</sup> According to Herodotus, it was used to wrap mummies and wounds received in battle.<sup>195</sup> The context where this textile appears in the Assyrian texts witnesses to the precious nature of this item of clothing.<sup>196</sup> This garment, interpreted by some scholars as ‘toga’,<sup>197</sup> was made of linen.<sup>198</sup> A letter by Crown Prince Sennacherib to King Sargon lists luxury garments and other commodities coming from Western countries as tribute and audience gifts for the palace personnel. Among the various goods there are also *šaddīnu*, a number of which are said to be made of *būšu*.<sup>199</sup> The correlation of *šaddīnu* and *būšu* is significant, since it reminds us of the analogous correlation between σινδών and byssus in Herodotus’ work. In fact, the Greek historian specifies that the σινδών was made of linen (βυσσίνη).<sup>200</sup> Also from Esarhaddon’s royal inscription at Nahr el-Kelb (in Lebanon) we learn that *šaddīnu*-garments were made of byssus;<sup>201</sup> in this case, the *šaddīnu* is one of the valuable objects taken from the treasury of Taharqa’s palace during the Assyrian looting of Memphis. Although it is clear that this is one of the rare attestations in Akkadian of the word ‘byssus’ (Greek βύσσος), it is not clear, however, what kind of fibre was designated with this word. In the light of the studies of Maeder, who carefully reviewed the incongruences of the modern translations of the ancient

term byssus, it seems reasonable to think that the material called *būšu* had nothing to do with the fibers of *Pinna nobilis*, but indicated, instead, a variety of linen.<sup>202</sup> What is evident from Sennacherib’s letter is that the word refers to a textile material used in the Western Semitic region, presumably in the Phoenician coastal area. This also suggests that this luxury material was imported in the Levant from Egypt. The West Semitic word *bš*, probably referring to fine Egyptian linen, occurs in the Phoenician version of the bilingual inscription of Karatepe, where the king of Zincirli/Sam’al (830-825 BC), Kilamuwa, mentions both linen (*ktn*), presumably of the ordinary type, and byssus (*bš*).<sup>203</sup> The origin of this West Semitic word is still disputed and an Egyptian textile designation has been considered by scholars as a possible candidate.<sup>204</sup> The Egyptian word *bd3*, meaning ‘pleated stuff’, could be at the basis of the West Semitic form; Lipiński observes that clothing of pleated fabric occurs in Pharaonic art as elite dresses.<sup>205</sup> Accordingly, the Semitic term *bš/būšu*, which was borrowed by Greek, was probably used to indicate a valuable textile material. In all probability, the West Semitic term entered the Assyrian language in Shalmaneser III’s reign (858-824 BC), since this king states to have received byssus along with multi-coloured clothing and linen as a tribute from Marduk-apla-ušur, king of Suhi, in the Euphrates region.<sup>206</sup> This textile material was highly

194. Chantraine 1968, 1005b.

195. Herodotus, *Historiae*, II.86; VII.181.

196. CTN 2, 155 r. v 13’; ND 2307 r.2 (*Iraq* 16 [1954], 37, pl. VI); ND 2672:6, 12 (*Iraq* 23 [1961], 42, pl. XXII = TCAE 387); RINAP 4, 103:21; SAA 1, 34:9, 11, 12, 14, 15, 17, 18, 19, 21, 22, 23, r.3, 5, 6, 8, 12, 13, 14, 15, 16, 17, 18, 19, 20, 21; 176:8; SAA 11, 26 r.8.

197. Parpola 1987, 227a; Fales & Postgate 1995, 168a. The dictionaries present very different translations. See AHW, 1001b: ‘ein Hemd?’; CAD S, 17a: ‘a cloth and a garment’; CDA, 310a: ‘a tunic?’; AEAD, 107b: ‘satin, silk, sheet, wrapper’.

198. CTN 2, 155 r. v 13’; ND 2307 r.2 (*Iraq* 16 [1954], 37, pl. VI); SAA 11, 26 r.8.

199. SAA 1, 34:11 4 TÚG.šad-din bu-ši.

200. Herodotus, *Historiae*, II.86.

201. RINAP 4, 103:21.

202. See Maeder in the present volume.

203. Hallo & Younger 2000, 148: “And whoever from his childhood had never seen linen, now in my days wore byssos.”

204. See DNSWI, 185 s.v. *bš*. However, Lipiński observes that ‘fine white Egyptian linen’ was called *šš/šs*. See Lipiński 2000, 542, fn. 178.

205. Lipiński 2000, 542.

206. RIMA 3, 90.

207. SAA 7, 62 r. iii 3’ 1 TÚG.šad-din bu-ši’. Byssus is also attested in line r. ii 5’ [x x x]x bu-šu.

appreciated in imperial Assyria, as confirmed by another attestation of the word *būšu* in an administrative text from Nineveh. In this inventory text, which enumerates precious items probably donated to the gods, *šaddīnu*-garments of byssus occur among other valuable commodities;<sup>207</sup> in all likelihood, they were used to clothe statues of divinities. This is also suggested by the fact that in the same text dark fine garments of linen (*qatattu adirtu kitê*) are mentioned in connection with the gods Marduk and Mullissu.<sup>208</sup> Other occurrences of the word *būšu* may be found in the Neo-Babylonian documentation. A text concerning vestments for the statue of Šamaš includes yarn of byssus.<sup>209</sup> Another Neo-Babylonian text shows that this material was categorised as linen (GADA.*bu-šu*);<sup>210</sup> the use of the semantic classifier GADA for byssus may also be seen in an inventory of linen fabrics for gods' statues from Seleucid Uruk.<sup>211</sup> Consequently, it is tempting to identify this material with a very fine variety of linen. Was the transparency of the fabric the main characteristic of the material called *būšu*? In one of the drawings of palace reliefs from Nimrud published in Layard's work there is a scene with two tributaries from Que, who bring provisions and vessels to the Assyrian king's banquet; interestingly, both individuals wear a fringed outer garment made of a transparent fabric, perhaps a very fine variety of linen.<sup>212</sup>

*šahartu*. The etymology of the word is not given in the dictionaries, but it may be connected to Akkadian *šaharru* (a Sumerian loanword), denoting a net.<sup>213</sup> Accordingly, the Assyrian form would represent a feminine nominal form whose meaning probably refer to the net-like structure of the weave. The word is attested in the plural form *šaharrāti*<sup>214</sup> and refers to leggings or socks,<sup>215</sup> especially used by soldiers and envoys. This item of clothing often comes in pairs. It is interesting to observe that representations of leggings worn by soldiers show a net-like appearance given by the leggings' strings.<sup>216</sup> The 'Middle Assyrian Harem Edicts' mention *šaharrātu* along with boots (*šuhuppāte*).<sup>217</sup> From another text of the same period we learn about leggings or socks destined to the king's feet.<sup>218</sup> Quantitative data about the manufacture of these leggings may only be found in the 2nd millennium. One text from Assur specifies that one mina of wool was needed to produce three pairs of white leggings.<sup>219</sup> A Neo-Assyrian document lists leggings among other items of clothing (*i.e.*, reinforced undergarments, sandals, upper garments, and waist-belts) for Urartian envoys.<sup>220</sup> Reinforced undergarments (*šupālītu hal-luptu*) and waist-belts (*šipirtu*) accompany this item also in another text from the central administration and in an affidavit document from Ziyaret Tepe concerning military garments.<sup>221</sup> Details on these leggings may be found only in two

208. SAA 7, 62 ii 15', iv 8' (of linen).

209. Zawadzki 2013, 162, no. 175:12-16.

210. See Quillien 2014, 289 about the text NCBT 597.

211. See Beaulieu 1989, 69-74 on the text NCBT 1244.

212. Layard 1849-53, I, pl. 62.

213. CAD Š/I, 80b.

214. K 6323+ r. i' 6', 16' (Kwasman 2009, 116); SAA 7, 96:9'; 124:11'; 127:4'; ZTT I, 8:2.

215. CDA, 346b; AEAD, 108a. Instead, the word is generically translated as 'garment' in AHw, 1129a; CAD S/I, 81b. See Postgate 2014, 424 for discussion.

216. See, *e.g.*, Fales & Postgate 1992, 124, fig. 30.

217. Weidner 1954-56, 274:43.

218. Postgate 1979, 6.

219. MARV III, 5:32'.

220. SAA 7, 127:4'.

221. SAA 7, 124:11'; ZTT I, 8:2.

222. K 6323+ r. i' 16' (Kwasman 2009, 116); SAA 7, 96:9'.



texts, which mention red-coloured *šaharrāti*.<sup>222</sup> Instead, a white variety is attested in a Middle Assyrian text from Assur.<sup>223</sup>

*šiknu*. This name of textile occurs among various articles of clothing (*i.e.*, mitres, leggings, and sleeves) in a Neo-Assyrian text concerning a royal funeral,<sup>224</sup> but the nature of the textile in question is not clear (a specific item of clothing or a different textile product?). The *šiknu* is attested in connection with garments (*kusītum*) in an Old Assyrian text,<sup>225</sup> while its association with bedclothes is documented in Mari.<sup>226</sup>

*šuhattu*. Apparently, a nominal form from *šahātu*, ‘to wash, rinse, wipe down’, although the etymology is not expressed in the dictionaries. CAD distinguishes two *šuhattu*-textiles: a textile used to wipe clean objects, and a luxury piece of apparel when referred to royal dressing.<sup>227</sup> In Middle Assyrian perfume-making, *šuhattu*-textiles were used to clean cooking pots.<sup>228</sup> The Akkadian reading of the logographic writing TÚG.KUR.RA as *šuhattu* is uncertain.<sup>229</sup> The KUR.RA-textile occurs in a Neo-Babylonian letter of the Assyrian royal correspondence, where it refers to a cloak.<sup>230</sup> From another Middle Assyrian text from Assur it seems that *šuhattu*-textiles were connected to the activity of felt-makers,<sup>231</sup> but conclusive observations on this regard cannot be made in light of the limited evidence.

### *Names of garments in 1st-millennium BC Akkadian dialects (Neo-Assyrian and Neo-Babylonian)*

The textile vocabulary of the Neo-Assyrian period comprises names of garments that are peculiar to the Akkadian dialects of the 1st millennium BC. Some of these designations are common to both Assyrian and Babylonian, others are exclusively attested in only one of these dialects. Some of these 1st-millennium terms may be understood as the development of previous designations based on the same lexical root. In other cases, instead, there are textile designations that are new entries in the late dialects of Akkadian.

*harīru*. The term is a designation for a type of garment or cloth.<sup>232</sup> Only CDA proposes the translation ‘bedspread’.<sup>233</sup> In texts from Mari a textile called *harrurum/hurrurum* is attested. According to Durand, it is possible that this word is related to the Neo-Assyrian form *harīru*.<sup>234</sup> It is not clear whether the Neo-Assyrian term has also some connection with the Old Assyrian *hirurum*.<sup>235</sup> Durand also suggests that the Mari term could have designated a garment with a surface very razed like velvet. The few data about the Assyrian *harīru* does not enable us to confirm this interpretation. The *harīru* occurs in administrative lists from Nineveh<sup>236</sup> among various *maqāṭtu*- and *urnutu*-garments as well as after reinforced undergarments. From another list we learn that *harīrus* could be made of multi-coloured cloth (*birmu*).<sup>237</sup>

223. MARV III, 5 r.32’.

224. K 6323+ r. i’ 5’, 18’ (Kwasman 2009, 116).

225. StOr 46, 198:63 (Hecker *et al.* 1998, no. 429). See CAD Š/II, 439a and Michel & Veenhof 2010, 242.

226. RA 64, 33, no. 25:1. See CAD Š/II, 439a. See also Durand 2009, 39-40.

227. CAD Š/III, 205b.

228. Ebeling 1952, 18, i 18, 19, ii 16, 20-21, ii 3, 20.

229. Reynolds 2003, 197b. The possible readings of the word TÚG.KUR.RA have been discussed by Malatucca in this volume.

230. SAA 18, 100:11 ṛi-na TÚG.KUR.RA-šú pa-ni-šú ṛi’-[ter-mu], ‘Th[ey covered] his face with his cloak.’

231. MARV X, 81:1-4 (StAT 5, 81).

232. AHw, 326a; CAD H, 102b; AEAD, 35b.

233. CDA, 108b.

234. Durand 2009, 41. See also CAD H, 102b, 121a.

235. Michel & Veenhof 2010, 233.

236. SAA 7, 97 r.4; 108 r. ii’ 5’; 109 r. iv 6’.

237. SAA 7, 109 r. iv 6’.

238. AHw, 679a; CAD M/II, 242a; CDA, 220a; AEAD, 68a.

*mušiptu*. The word, a nominal formation possibly based on the verb *šuppu* II, ‘to decorate, overlay, rub down’, occurs in Neo-Babylonian, where it indicates a (standard) piece of clothing;<sup>238</sup> it was used as a generic term for clothing.<sup>239</sup> In a Neo-Babylonian letter of the Assyrian royal correspondence, the term is employed to designate garments from Tukriš.<sup>240</sup> These garments are qualified as *karkēti*. This term may be interpreted as the adjective *karku*, ‘amassed, gathered, twined’<sup>241</sup> or as the substantive *karkītu*, ‘threaded work’, which is not included in dictionaries.<sup>242</sup> Both these nominal forms derive from the verb *karāku*, ‘to gather, wrap, twine’. From the same root also derives the word *karikku*, attested in Mari and translated by Durand as ‘chaussette, bas’.<sup>243</sup> Concerning the place name Tukriš,<sup>244</sup> it is worth noting that wool and textiles from this place are mentioned in Middle Babylonian texts,<sup>245</sup> confirming the importance of the local textile manufacture already in the 2nd millennium BC.

*našbutu*. This item was probably a coat or a sash holder.<sup>246</sup> To judge from the administrative sources, this item of apparel was made of *biršu-*

fabric<sup>247</sup> and it had an edging that could be commercial red-coloured.<sup>248</sup> Of the same colour was also the front-piece of this textile.<sup>249</sup> As to function, we may observe that this textile appear in dowry lists; probably, it was an ordinary piece of clothing to wear at home. In a marriage contract from Assur it occurs after the *urnutu-* and the *maqatūtu*-garments.<sup>250</sup> In the Neo-Babylonian period it is attested in Amat-Nanā’s dowry list among other items of apparel.<sup>251</sup> On the contrary, nothing can be said about the *našbutu* mentioned in a Babylonian letter among amounts of wool, a hat, and other commodities.<sup>252</sup> In Neo-Babylonian times, *našbatu*-garments were used to cover the statues of the gods Nanāya, Ušur-amāssu and Nabû.<sup>253</sup>

*nēbetu*. This word designates a girdle or sash.<sup>254</sup> The nominal form derives from the verb *ebētu*, ‘to bind?’.<sup>255</sup> The dictionaries only list Neo-Babylonian attestations. Texts from Nimrud<sup>256</sup> and Assur<sup>257</sup> record a multi-coloured variety of this item of clothing, while another document from Nimrud mentions a red type.<sup>258</sup>

239. Roth 1989-90, 29; Joannès 2010, 406.

240. SAA 17, 122:8 TÚG.mu-ši-pe-ti / kar-ke-e-ti šá Tuk-riš.

241. CAD K, 217b.

242. Dietrich 2003, 180a.

243. Durand 2009, 50.

244. Groneberg 1980, 239. According to Groneberg, this place is to be identified with the region of Luristan.

245. See references quoted in CAD T, 460a s.v. *tukrišū* b.

246. K 6323+ iii 26 (Kwasman 2009, 115); ND 3407:2 (*Iraq* 15 [1953], 138, pl. XI); SAA 7, 96:11', r.1; 97:6', 11'; 102:1'; 119 r. ii' 2'; SAA 18, 19:4', 9'; StAT 2, 164:13. See AHW, 756b: ‘ein Mantel’; CDA, 244b: ‘a coat’. For the translation ‘sash holder’, see AEAD, 75a and Kwasman 2009, 115. Instead, a generic meaning is given in CAD N/II, 47b.

247. SAA 7, 96:11', r.1; 97:6', 11'; 119 r. ii' 2'.

248. SAA 7, 96:11', r.1; 97:11'. See also SAA 7, 102:1'.

249. SAA 7, 96 r.1.

250. StAT 2, 164:13.

251. Roth 1989-90, 31, text CT 49, 165:11.

252. SAA 18, 19:4', 9'.

253. Beaulieu 2003, 15.

254. AHW, 774a; CAD N/II, 201b; CDA, 248b, AEAD, 76a.

255. CDA, 65a s.v. *ebētu* II.

256. CTN 2, 153:4.

257. StAT 3, 1 r.25.

258. CTN 2, 153:6.

259. AHW, 908a; CAD Q, 173b; CDA, 286b; AEAD, 87b.

*qatattu*. The name of this fine garment is the feminine adjectival form from *qatnu*, ‘thin’.<sup>259</sup> This adjective qualifies TÚG.HI.A<sup>260</sup> and *nahlaptu*-textiles<sup>261</sup> in Middle Assyrian texts. In the 1st millennium it is used to indicate a specific item of clothing. Dark (*adirtu*) *qatattu*-garments of linen are listed in a Neo-Assyrian inventory text from Nineveh.<sup>262</sup>

*qirmu* (or *qermu*, *qeremu*). The term, derived from the verb *qarāmu*, ‘to cover’, seems to designate an overcoat or mantle, if we follow AEAD’s interpretation.<sup>263</sup> Aramaic *qrām*, *qrāmā* means ‘covering’.<sup>264</sup> *Qirmu*-garments could have a red-coloured front-part;<sup>265</sup> the red dye could be of the commercial type (‘red of the port’)<sup>266</sup> or of the country-type.<sup>267</sup> Other attestations show that both red and black wool were used to fabricate *qirmus*.<sup>268</sup> This is confirmed by a document from Assur, where one clean (or bright?) black *qirmu* is recorded.<sup>269</sup> In the same text also the multi-coloured variety is

listed.<sup>270</sup> In Neo-Babylonian documents it occurs as one component of female wardrobes.<sup>271</sup>

*ša hīli*. This term, which is not listed in the dictionaries,<sup>272</sup> is based on the word *hīlu/hillu*,<sup>273</sup> ‘covering, wrapping’.<sup>274</sup> In Assyria the *hillu* was used as wrapping or cover for *nēbuhu*-sashes<sup>275</sup> and constituted an accessory element of *ša Iš* garments.<sup>276</sup> The *ša hīli* is attested both in Neo-Assyrian and Neo-Babylonian.<sup>277</sup> It was made of red wool<sup>278</sup> and accompanied *kusītu*-garments, as may be observed in the description of the clothes of Abu-erība, a relative of the Assyrian king,<sup>279</sup> as well as in a list of garments from Tell Billa.<sup>280</sup>

*ša hurdati*. The translation of the word as ‘petticoat, sanitary napkin’ is suggested by AEAD on the basis of the term *hurdatu*, ‘female genitals’.<sup>281</sup> The term only occurs in the lexical list PVA.<sup>282</sup>

*ša Iš*. Fales and Postgate tentatively suggest the translation ‘dust garment’ on the basis of the word

260. AfO 19, T.6:7-9 (Freydank & Saporetti 1989, 52).

261. Postgate 1979, 6.

262. SAA 7, 62 iv 8’ 1’ TÚG’*qat’-a’-tú a’-dir-tú* GADA. See also *ibidem* ii 15’.

263. AEAD, 88b. Note that the other dictionaries simply give generic translations, see AHw, 918a; CAD Q, 268b; CDA, 288b.

264. LS, 696b; Sokoloff 2009, 1412a; DJBA, 1043b; Jastrow 1950, 1421b.

265. SAA 7, 97:7’; 98:9’, 10’.

266. SAA 7, 98:9’.

267. SAA 7, 98:10’.

268. SAA 7, 110:7-9 2 ½ MA.NA SÍG.HÉ.MED’ [0] / 2 ½ MA.NA SÍG.GI<sub>6</sub> [0] / *a-na TÚG.qir-mu* [0].

269. StAT 3, 1:12.

270. StAT 3, 1 r.23. For other attestations of the term, see CTN 2, 152:7, 8, 10; ND 2307 e.24 (*Iraq* 16 [1954], 37, pl. VI); ND 3407:4 (*Iraq* 15 [1953], 138, pl. IX); PVA 270; SAA 7, 94:3; 104:7; 117 r.3; 122 i 4’. Another occurrence is in SAA 7, 122 i 4’ TÚG.*qi-ir-mu* (Reconstruction of the occurrence by the author).

271. Roth 1989-90, 31, texts Nbn 258:10; BM 76968/72:13.

272. CDA, 347a and AEAD, 108b list the word in the form *šahīlu*.

273. According to AHw, 345b s.v. *hillu* and CAD Š/I, 97a s.v. *šāhīlu*.

274. For the word *hillu* see SAA 7, 115 ii 16; SAA 18, 129:5.

275. SAA 7, 115 ii 16.

276. ZTT II, 33:4.

277. Billa 71:2, 3 (JCS 7 [1953], 137); CTN 2, 1:6’, 10’; ND 267 (*Iraq* 12 [1950], 195, tablet not copied); PVA 240; SAA 17, 122:8 (written as TÚG.*šá—hī-il*).

278. CTN 2, 1:6’.

279. SAA 17, 122:7-8.

280. Billa 71:2 (JCS 7 [1953], 137).

281. AEAD, 106a.

282. PVA 283.

283. Fales & Postgate 1992, xxix.

*eperu* (IŠ/SAHAR).<sup>283</sup> This garment<sup>284</sup> could also be accompanied by one *sūnu*-piece (see below).<sup>285</sup> Another variant of this item is provided by a document from Ziyaret Tepe, which mentions one *ša* IŠ with wrappings(?) (*ša hillānu*).<sup>286</sup> Seven large multi-coloured *ša* IŠ garments are listed in an administrative document along with *kusītu*-garments.<sup>287</sup> The same text tells us that this textile could also be red-coloured.<sup>288</sup> Its front-part could be commercial red<sup>289</sup> or black.<sup>290</sup>

*ša* KÁR. The word is attested in the logographic writing TÚG.KÁR in a fragmentary document from Assur listing iron objects and textiles.<sup>291</sup> This is one of the compound names of the type *ša* X which are very common in the Neo-Assyrian dialect (see also below). These compounds are formed by the determinative pronoun *ša* and a noun in the genitive.<sup>292</sup> In the case of the logographic writing TÚG.KÁR, the sign TÚG is probably used for the determinative pronoun *ša*. The syllabic reading of the logogram KÁR is unknown.

*ša muhhi*. This textile designation, which is not attested in the dictionaries, occurs among other textile designations in a text from Assur. This text mentions an old white *ša muhhi* of the king.<sup>293</sup> It was an integral part of the royal attire, perhaps

corresponding to an overgarment. It is also possible that the item in question corresponds to the Middle Assyrian felt TÚG.UGU, possibly designating a garment or a headdress.<sup>294</sup>

*ša qabli*. This compound name has been interpreted as a designation for loincloth on the basis of the word *qablu*, ‘middle, middle parts, loins’.<sup>295</sup> The term only occurs in PVA and in an inventory list of various objects.<sup>296</sup> Perhaps a similar item of clothing was the one worn by King Assurnasirpal II in various palace reliefs in Kalhu: the item represented in these scenes is constituted by a short cloth girded around the loins and decorated by tassels.<sup>297</sup>

*ša taluk širri*. This unusual textile designation is only attested in PVA<sup>298</sup> and in a fragmentary list of textiles from Nineveh, where only the last part of the compound name can be read.<sup>299</sup> The latter attestation has never been recognised and mentioned by scholars. Its meaning, ‘moving like a snake’, seems to refer to a peculiarity of long and large undulating garments’ border. This compound is listed in CAD, but no translation is given there.<sup>300</sup>

*šer ’ītu*. The word designates a garment for the gods’ statues in Neo-Assyrian<sup>301</sup> and Neo-Babylonian texts.<sup>302</sup> Neo-Assyrian theological commentaries specify that the *šer ’ītu*-garment was worn by

284. CTN 2, 153, 2, 3; SAA 7, 105:6’, 7’; 119 r. i’ 10’, 11’; 127:9’; ZTT II, 33:4.

285. CTN 2, 153:2. But see in the same text also a variety of *ša* IŠ without the *sūnu*-element. See *ibidem* 3.

286. ZTT II, 33:4 1 TÚG.ša<sup>1</sup>—IŠ *ša hi-l[a]’-nu*.

287. SAA 7, 105:6’.

288. SAA 7, 105:7’.

289. SAA 7, 119 r. i’ 10’.

290. SAA 7, 119 r. i’ 11’.

291. StAT 2, 128:7’ [x x x x] TÚG.KÁR.MEŠ.

292. Hämeen-Anttila 2000, 80.

293. StAT 3, 1 r.30 1 TÚG.ša—UGU LUGAL BABBAR SUMUN.

294. Jakob 2003, 435. One *lubulta ša muhhi šarri* is mentioned in KAV 99 r.37.

295. AEAD, 106b.

296. PVA 277; SAA 7, 85 r. ii 6’.

297. Layard 1849-53, I, pls. 12, 17, 20, 23, 31.

298. PVA 284.

299. SAA 7, 120 i’ 2 [x TÚG.ša—*ta-lu*]-*uk*—MUŠ, “[...] ‘mov]ing-like-a-snake’-garment(s)” (Reconstruction of the line by the author).

300. CAD T, 107a s.v. *tāluku*.

301. SAA 3, 34:32, 53; 35:21, 44.

302. BBSt 36 v 44, 52, 54, vi 3. See CAD Š/II, 316a.

303. SAA 3, 34:32, 53; 35:21.

Bēl,<sup>303</sup> while Neo-Babylonian texts associate this article of clothing to the gods Šamaš, Aya, and Bunene.<sup>304</sup> The *Marduk Ordeal* shows that this vestment was stored in the temple's storeroom (*kadammu*).<sup>305</sup> In the same text, Bēl's outfit is compared to the primeval water "which was over (the god) Aššur".<sup>306</sup> I wonder whether the textile term has something to do with the word *šur ʾtu*, attested in PVA and denoting a kind of wool.<sup>307</sup> This is the feminine form of the adjective *šūru*, used to qualify textile products in Old Assyrian, Nuzi and Standard Babylonian texts.<sup>308</sup> It is worth noting that *šūru*-textiles were donated to the goddess Ištar in Old Assyrian times.<sup>309</sup>

*šupālītu halluptu*. This item of clothing is usually defined with these two words;<sup>310</sup> only in few texts we find a *šupālītu* without any other qualification.<sup>311</sup> The adjective *šupālū* means 'lower',<sup>312</sup> while the D-stem feminine nominal form *halluptu* is translated as 'armour' (from *hallupu*, 'to overlay,

cover').<sup>313</sup> AEAD interprets the *šupālītu* as a lower garment, shirt or underwear,<sup>314</sup> while the *šupālītu halluptu* was a reinforced or armoured undergarment.<sup>315</sup> The nature of this article is not clear, and suggestions have been made about the possibility that it was a sort of felt armour.<sup>316</sup> In Assyria, it was produced or traded by the professional called *ša halluptēšu*.<sup>317</sup> Texts from the central administration in Nineveh clearly show that it was made of linen<sup>318</sup> as well as of *biršu*.<sup>319</sup> Different varieties of such a garment were in use; a Phrygian variety is mentioned in a record which enumerates precious commodities, some of which of foreign origin, in connection with state officials.<sup>320</sup> Of the *šupālītu*-garment, black<sup>321</sup> and white<sup>322</sup> types were known. In addition, this garment could be associated with straps or girdles: one text mentions one *šupālītu halluptu* with straps or a girdle (*šibbu*), probably to be identified with the shirts with crossed straps and waist-belt worn by Assyrian soldiers.<sup>323</sup> In

304. BBS 36 v 44, 52, 54, vi 3.

305. SAA 3, 34:32; 35:21.

306. SAA 3, 34:53, 55. See also SAA 3, 35:44-45.

307. PVA 216.

308. CAD Š/III, 367b. This adjective is used in Old Assyrian texts. See Michel & Veenhof 2010, 244-245.

309. BIN 6, 186:18. According to the same text, Aššur receives *kutānu*-textiles. See CAD S/III, 368a.

310. CTN 2, 153:7; K 6323+ iii 25, r. i' 12', 14' (Kwasman 2009, 115); ND 2097:5 (*Iraq* 23 [1961], 18-19, pl. IX); SAA 7, 97:4', 5', r.7; 102:6'; 104:5'; 105:9', 10'; 108 r. ii' 5'; 109 r. ii 3', 5'; 119 r. i' 12', ii' 5'; 124:9'; 126:4; 127:3', 9'; SAA 11, 28:11; StAT 3, 1:6, 13, r.27; ZTT I, 8:1; ZTT II, 33:3. Another occurrence is in ND 2687 r.9 (*Iraq* 23 [1961], 43, pl. XXIII) 3 TÚG.KI—*hal-pat* (Reconstruction by the author).

311. KAN 1, 45:1, 6; KAN 2, 12 (= StAT 1, 12); NATAPA 1, 45A:3'; 45B:1, 6; SAA 7, 94:1.

312. CAD Š/III, 316b.

313. AEAD, 33b.

314. AEAD, 119a.

315. AEAD, 33b: 'felt armor, armored undergarment, mail shirt'.

316. AEAD, 33b.

317. SAA 7, 115 r. i 8; SAA 12, 83 r.14.

318. SAA 7, 108 r. ii' 5'. We may observe that Parpola's interpretation of the *šupālītu halluptu* as a felt armour is based on the assumption that it was exclusively made of felt. The attestation about the linen variety is not taken into consideration by the Finnish scholar in his discussion in Parpola 2008, 56.

319. SAA 7, 97:4', 5'; 105:10'.

320. SAA 7, 126:4-5 2 TÚG.KI.TA—*hal-lu-pat mu-us-ki / ʾab-di-mil-ki* LÚ\*.GAL—*ka-šir*, "Two Phrygian reinforced undergarments – Abdi-milki, the chief tailor".

321. SAA 7, 127:9'.

322. SAA 7, 94:1 (only designated as *šupālītu*).

323. Postgate 2001, 382, 386 and fig. 9; Faist 2007, 14.

324. SAA 7, 127:8'-10' 2 AN.TA.MEŠ GI<sub>6</sub> / 2 šá—IŠ 2 KI—*hal*.MEŠ<sup>1</sup> GI<sub>6</sub> / 2 šip-rat, "Two black upper garments, two ša IŠ garments,

light of the set of clothing articles which formed the equipment of envoys in a document from Nineveh, we may suggest that a *šupālītu halluptu* was usually worn in association with a waist-belt (*šipirtu*), an upper garment (*elītu*), and a *ša IŠ* garment.<sup>324</sup> This ‘ensemble vestimentaire’, whose basic components were the *šupālītu halluptu* and the *šipirtu*,<sup>325</sup> could be enriched by the presence of *maklulus*.<sup>326</sup> In addition, the *šupālītu halluptu* was characterised by the presence of *nītu*-elements<sup>327</sup> and edging (NIGÍN).<sup>328</sup>

*urnutu*. This term has not been explained by scholars as regards its etymology and the dictionaries do not offer any indication about its origin. According to von Soden, the origin of the term is unknown. Morphologically, it appears as a feminine nominal formation possibly to be connected to *urnatu*, ‘strong, manly’, a synonym for male only attested in lexical lists.<sup>329</sup> We cannot exclude

a West Semitic provenance. In Syriac, the adjective based on the root ‘*rn* means ‘hard, harsh’.<sup>330</sup> This is a textile product which frequently occurs in Neo-Assyrian texts.<sup>331</sup> The materials used for this garment were wool,<sup>332</sup> linen,<sup>333</sup> and *biršu*.<sup>334</sup> The wool variety is only attested in a document from Nimrud and in a marriage contract from Assur; it probably represented a common variety of this item of dress. Details on colours and peculiarities of the *urnutu* are also documented. We know that *urnutus* could be multi-coloured,<sup>335</sup> red,<sup>336</sup> violet,<sup>337</sup> black,<sup>338</sup> and with a red front-piece.<sup>339</sup> The red front-part is sometimes specified as ‘red of the country’<sup>340</sup> or ‘red of the port’.<sup>341</sup> This garment also had an edging,<sup>342</sup> often red-coloured.<sup>343</sup> Also the red-coloured edging could come in two varieties: the country-type<sup>344</sup> and the port-type.<sup>345</sup> A Nimrud document lists a densely-woven(?) or a good(-quality) *urnutu* (KAL/*dannu* or SIG<sub>15</sub>/

two black reinforced undergarments (with) two waist-belts”.

325. See ZTT I, 8:1 3 ‘TÚG’.KI.TA—*hal-’pa-te TÚG’ .ši-pi-tú*, “Three reinforced undergarments, one waist-belt”.

326. ZTT II, 33:1-4 7 TÚG.AN.TA.MEŠ / 4 TÚG.*ma-ak-[ul.MEŠ]* / 2 TÚG.KI.TA—*’hal-lu-pat’ / 1 TÚG.ša’—IŠ ša hi-[l]a<sup>2</sup>-nu*, “Seven upper garments, four shaw[ls], two reinforced undergarments, one dust garment with wrappings”. Perhaps, the first two items are also attested in the fragmentary text ZTT II, 36:1-2 [x] TÚG.AN.[TA.MEŠ<sup>?</sup>] / [x] TÚG.*ma-[ak-lul.MEŠ<sup>?</sup>]* (Reconstruction by the author).

327. ND 2687 r.10 (*Iraq* 23 [1961], 43, pl. XXIII).

328. SAA 7, 105:9’, 10’.

329. See AHw, 1431b; CAD U-W, 233b.

330. Sokoloff 2009, 1140b.

331. NATAPA 2, 100:3; ND 2307:15, 16, 18, r.4 (*Iraq* 16 [1954], 37, pl. VI); ND 2311:6 (*Iraq* 23 [1961], 20, pl. X); SAA 7, 94:5; 95:3, 4, 5; 96 r.2, 3; 97:3’, 10’, 12’, r. 2, 6, 9, 10; 98:5’; 99:3, 4, 5; 101:2’; 102:2’; 103 r.1’; 104 r.2’; 107 r.2’; 108 ii’ 6’, r. ii’ 4’; 109 ii 2’, r. iii 4’, 9’; 112 e.11’; 115 ii 10; SAA 11, 28:13; StAT 2, 164:10, 11.

332. ND 2307:15 (*Iraq* 16 [1954], 37, pl. VI); ND 2311:6 (*Iraq* 23 [1961], 20, pl. X); StAT 2, 164:11.

333. ND 2307:16, 18 (*Iraq* 16 [1954], 37, pl. VI); SAA 7, 96 r.3; 97 r.2, 6; StAT 2, 164:10.

334. SAA 7, 95:3, 4, 5; 96 r.2; 97:10’, 12; 98:5’, 6’, 7’; 99:4; 109 r. iii 9’.

335. SAA 7, 97 r.6.

336. SAA 7, 109 ii 6’, 7’.

337. ND 2311:6 (*Iraq* 23 [1961], 20, pl. X).

338. SAA 7, 109 r. iii 11’.

339. SAA 7, 95:3, 4, 5; 97:10’; 98:5’, 6’, 7’; 109 r. iii 9’. See also SAA 7, 94:5. For the *urnutu*’s front-part see also SAA 7, 109 ii 3’.

340. SAA 7, 94:5.

341. SAA 7, 97 r.2.

342. SAA 7, 102:2’; 109 ii 2’.

343. SAA 7, 96 r.2; 97:12’.

344. SAA 7, 98:7’; 109 r. iii 10’.

345. SAA 7, 96 r.2; 97:10’; 98:6’; 109 r. iii 9’.

346. ND 2311:6 (*Iraq* 23 [1961], 20, pl. X).

*damqu*).<sup>346</sup> The Assyrian elite also imported *urnutus* from the Levantine coast; a number of *urnutus* from Byblos are recorded in an administrative list from Nineveh.<sup>347</sup> Decoration in form of animals adorned this garment; in fact, decorations representing bulls<sup>348</sup> and goats<sup>349</sup> are mentioned in a textile list. In another text, *urnutu*-garments are qualified by the word *šippu*,<sup>350</sup> not translated by Fales and Postgate.<sup>351</sup> If this is a designation for a vegetal element,<sup>352</sup> we may conclude that these *urnutus* were probably decorated with vegetal motifs similar to those adorning the king's dress represented in palace reliefs.<sup>353</sup> The mention of one *urnutu* 'covering the entire figure' (*ša muhhi lāni*)<sup>354</sup> could be referring to a feet-length variety. This means that a shorter variety of *urnutu* was also known. Also for the *urnutu* we see that a 'house-variety', *i.e.*, a type of *urnutu* probably to wear at home, was in use in Assyria;<sup>355</sup> the same qualification occurs for the textiles called *gulēnu*, *hullānu*, *maqaṭṭu* and *nahlaptu*. The use of *bētu* as a qualification for clothes

is already attested in the Middle Assyrian period, as witnessed by a reference to *lippu*-garments É.HI.A, 'of the house', in a text from Assur.<sup>356</sup> Presumably, it was an ordinary type to be worn at home. In a number of Neo-Assyrian attestations the *urnutu*-garment is also qualified with the term *sāiu*.<sup>357</sup> It seems that this technical detail also referred to the *urnutu*'s fringe.<sup>358</sup> In one case, this *urnutu* was associated with a *sūnu*-textile.<sup>359</sup>

To come back to the Neo-Assyrian term *sāiu*, we may observe that it is always attested in the plural form *sāiāte*<sup>360</sup> and in connection to *urnutu*-garments.<sup>361</sup> However, *urnutus* could also be defined as 'not *sāiu*' (NU *sa-a*).<sup>362</sup> It is clear that in all the attestations, the garments were of wool. There is only one attestation in which *sāiu* qualifies linen garments of unknown nature.<sup>363</sup> Fales and Postgate prefer translating this term as meaning 'knotted'.<sup>364</sup> Villard follows this interpretation and suggests the translation 'à point noué'.<sup>365</sup> But this is far from certain. Another

347. SAA 7, 108 r. ii' 4' [x+]2 *ur-nat Gu-ub-li*. For textiles imported from Byblos in the documentary evidence from Mari see Durand 2009, 100.

348. SAA 7, 109 ii 3'. See also *ibidem* r. iv 4'.

349. SAA 7, 109 ii 5'.

350. SAA 7, 96 r.3 3 TÚG.*ur-nat* GADA *šip-pi*.

351. Fales & Postgate 1992, 110, 223a.

352. See CDA, 339a. The word is probably at the basis of the term *šippatu* (a vegetable).

353. On vegetal motifs in the Assyrian royal dress of the 9th century BC see Layard 1849-53, I, pls. 6-9. For similar decorative elements in the 7th-century variety of royal garment see, for instance, the breast-piece of Assurbanipal's dress in the relief BM 124867, reproduced in detail in Fales & Postgate 1992, 116, fig. 27.

354. SAA 7, 112 e.11'.

355. StAT 2, 164:11.

356. Postgate 1979, 5. But see Postgate 2014, 424, who does not connect the Middle Assyrian attestations of textile-related word *bētu* with the Neo-Assyrian ones.

357. SAA 7, 97:12'; 108 ii' 7'; 109 ii 3', 5', 6', 7'.

358. SAA 7, 109 ii 4' 2' : : NIGIN :. KA 'MA *sa'-a*.

359. SAA 7, 109 ii 5' 1' : : NIGIN<sup>!!</sup> MÁŠ *sa-'a' su-'ni'*.

360. *E.g.*, *sa-a* SAA 7, 97:12'; 109 i 5', 7', 8', ii 3', 4', 5', 6', r. iii 8', iv 3'; *sa-a-te* SAA 7, 108 i' 4'; *sa-a-a* SAA 7, 109 i 3', 4'; *sa-a-a-te* SAA 7, 108 i' 6', 7', 9'; *sa-a-[a-te]* SAA 7, 108 ii' 7'. See also [*sa-a*]-*a'-te'* SAA 7, 109 ii 7' (Reconstruction of the occurrence by the author). Other attestations of the (same?) word occur in lists of wine and foodstuffs, but the context is not clear. See SAA 7, 140 r.3 and 141:3 (not translated by Fales and Postgate).

361. SAA 7, 97:12'; 108 i' 4', 6', 7', 9', ii' 7'; 109 i 3', 4', 5', 7', 8', ii 3', 4', 5', 6', r. iii 8', iv 3'; 140 r.3; 141:3'.

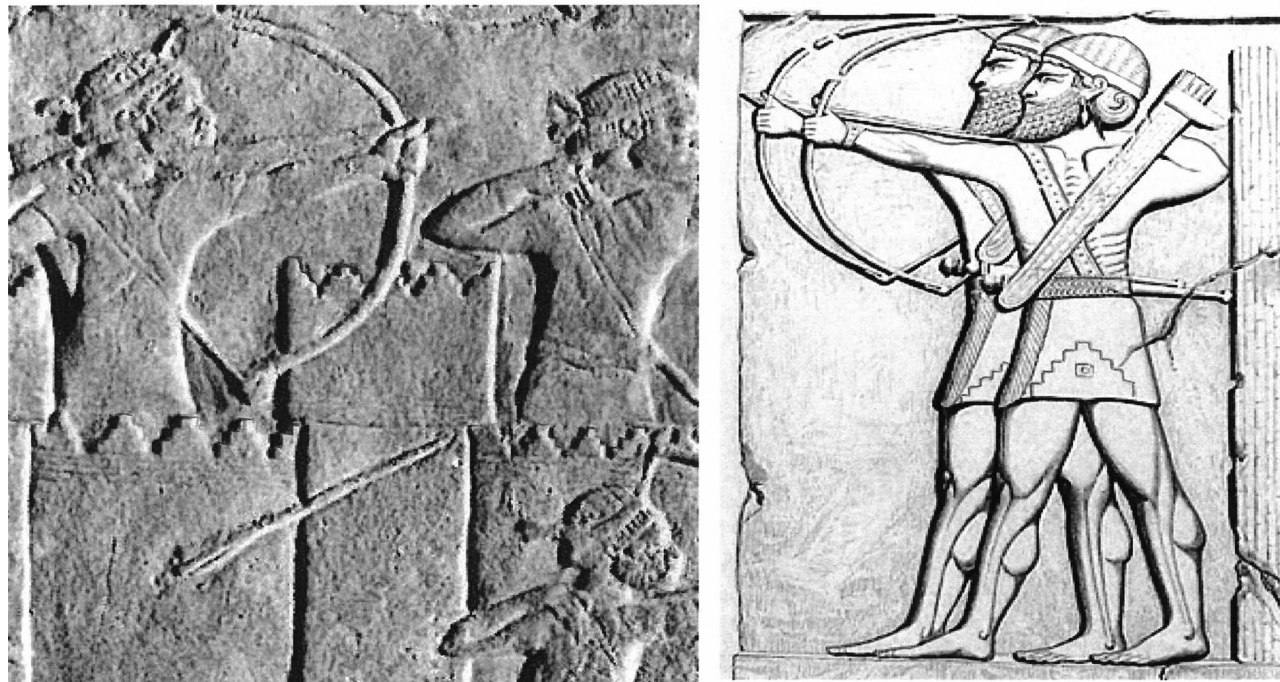
362. SAA 7, 109 r. iii 7'-8'.

363. SAA 7, 109 r. iv 3' [x TÚG].GADA *sa-a*.

364. Fales & Postgate 1992, 221b. The same meaning is also given in AEAD, 97a.

365. Villard 2010, 395.

366. CAD S, 117a.



**Figure 1:** Mural crenellation from a siege scene from Assurbanipal's palace in Nineveh (left, from Barnett 1976, pl. 17, detail) and stepped motif in Assyrian military kilts from Sargon II's palace in Dūr-Šarrukēn (right, from Botta & Flandrin 1849-50, pl. 86, detail).

possibility is considering the form *sāiu* as a variant for *samītu*, a word related to an architectural element.<sup>366</sup> The form *sāiu* as referred to architectures is attested in Neo-Assyrian texts dealing with building activities; as an architectural term, it is translated by Fales and Postgate as 'scaffold'.<sup>367</sup> In fact, in CAD it is suggested that the Neo-Assyrian plural form *sa-a-te*, attested in connection to textiles, could be a rendering of the word *samītu*, 'battlement parapet', or (*a*)*sa'ittu*, 'tower'.<sup>368</sup> In addition, we cannot rule out that the singular form was *sa'ittu*, not *sāiu*. In light of the possible semantic connection with the architectural terminology, it is tempting to identify these *sa'ittu*-elements in wool and linen garments (Fig. 1) with towers or crenellated structures, an ubiquitous motif in Neo-Assyrian art.

Crenellated elements decorated the whole surface of male and female garments<sup>369</sup> as well as their border and tassels.<sup>370</sup> This characteristic element of Neo-Assyrian art had great success and continuity in Central Asia in subsequent centuries, as witnessed by the archers' garments of the Achaemenid palace's glazed-brick walls<sup>371</sup> and the Pazyryk *shabrak* of the 4th century BC discovered in Siberia.<sup>372</sup>

#### ***Designations for Neo-Assyrian garments of West Semitic origin***

A number of garment designations in Akkadian dialects of the 1st millennium BC are understood by scholars as West Semitic loanwords. In the following list, Neo-Assyrian names of garments of possible

367. SAA 11, 15 r. i 2, 7, 8, r. ii 7'; 21:9.

368. CAD S, 117b.

369. See, e.g., Layard 1849-53, I, pl. 20; Fales & Postgate 1992, 116 fig. 27.

370. For this decorative element on tassels, see Crowfoot 1995, 115 fig. 4.

371. Muscarella *et al.* 1992, 226.

372. Details of these decorative elements may be observed in the coloured photograph published in Cardon 2007, 572 fig. 20.

373. CTN 2, 1:12'; K 6323+ r. i' 13' (Kwasman 2009, 116); ND 2307 r.1 (*Iraq* 16 [1954], 37, pl. VI); ND 2687:1, r.7 (*Iraq* 23 [1961],



West Semitic origin, namely Aramaic, are included. *gammīdu* (and *gammīdutu*). This textile is generically intended as a kind of garment.<sup>373</sup> The term, which Kaufman considered as a possible old Aramaic loanword in Akkadian,<sup>374</sup> probably derived from the Aramaic passive participle *gammīd*, has also been interpreted as meaning ‘mangled garment’<sup>375</sup> and ‘smooth gown or cloak’.<sup>376</sup> In fact, Syriac *gmd* means ‘to mangle, smooth’, and refers to linen.<sup>377</sup> The verb is listed in Sokoloff’s Syriac dictionary as meaning ‘to press’ and refers to the fulling process which follows washing.<sup>378</sup> In Jewish Babylonian Aramaic the adjective *gmd*, ‘shrunk’, qualifies felt.<sup>379</sup> From the same root derives the word *gmydh*, indicating a type of garment.<sup>380</sup> Another possibility is that we have here a type of rug or blanket, thus not properly a garment.<sup>381</sup> It seems that the *gammīdu* was made of linen.<sup>382</sup> It is not clear whether the grammatical differentiation of the masculine form (*gammīdu*) and the feminine form (*gammīdutu*), an aspect which also characterises the word *maqat̄tu/maqat̄tutu* (see below), bears witness to different varieties of the same item of clothing, perhaps based on a variation of size. An account of wool and flax records

an amount of 2 minas of linen for the hind-part (*aqqābu*) of one *gammīdu*.<sup>383</sup> From a Neo-Babylonian text concerning manufacture of garments for the Babylonian gods we learn that 10 shekels of red wool, 25 shekels of blue-purple wool, half a mina of alum and, perhaps, also half a mina of apple-colour dye were needed to produce one *gammīdatu*-garment.<sup>384</sup>

*gulēnu*. Of this textile designation no etymology is given in the dictionaries. CAD suggests a possible West Semitic origin, connecting the term to Hebrew *gelōm* and Aramaic *gelīma*, *gelaimā* (*glym*, *glym*).<sup>385</sup> This term designates a coverlet, mantle, or cloak, in any case a sleeveless item of clothing.<sup>386</sup> The change of <*m*> into <*n*> is a phenomenon occurring in Akkadian, Aramaic and Hebrew also in final position.<sup>387</sup> Another possibility is that the Neo-Assyrian and Neo-Babylonian form derive from another West Semitic textile designation. In Syriac we find the words *gallōn*, *gallōnā* (*glwn*, *glwn*), which are usually translated as meaning ‘garment’.<sup>388</sup> These terms are connected to the basic word *gall*, *gallā* (*gl*, *gl*), which means ‘covering, cloak, horse-blanket, and saddle’ in Syriac.<sup>389</sup> The Assyrian term is tentatively translated

43, pl. XXIII); PVA 248; SAA 7, 97 r.8; 104:6; 115 r. ii 18; StAT 3, 1:14; VAT 8659:2-5 (unpubl., but cited in Parpola 2008, 57). See AHw, 279b; CAD G, 36b; CDA, 89b.

374. Kaufman 1974, 51.

375. AEAD, 29b.

376. Parpola 2008, 57.

377. Parpola 2008, 57.

378. Sokoloff 2009, 239b-240a. The author quotes the attestation taken from G. Hoffmann, *Opuscula Nestoriana syriace tradidit* (1880), 159:22: “After (the garment) is washed, the fuller presses it, and removes the rumples”.

379. DJBA, 289a.

380. Porten & Yardeni 1986, B3.8 r.7; D2.19 r.2.

381. Fales & Postgate 1992, xxix.

382. SAA 7, 97 r.8; 115 r. ii 17-18.

383. SAA 7, 115 r. ii 18.

384. Zawadzki 2013, 419, no. 453:1-6 ‘1/3’ MA.NA SÍG.ta-bar-ri / 5/6 MA.NA SÍG.ta-kil-tu<sub>4</sub> / ‘1’ MA.NA NA<sub>4</sub>.gab-bu-ú / [1 MA.] NA GIŠ.HAŠHUR a-na / [šī]-bu-tu<sub>4</sub> šá 2-[ta] / [TÚG.g]a-mi-da-’tu<sub>4</sub>’.

385. CAD G, 127b.

386. LS, 118b; Sokoloff 2009, 237b; DJPA, 130b; DJBA, 287b; Jastrow 1950, 249a (also quoting the Talmudic passage: “it is called *g*. because one looks in it like a shapeless body”).

387. Lipiński 1997, 112 § 11.7.

388. LS, 115a; Sokoloff 2009, 233b.

389. LS, 114b-115a; Sokoloff 2009, 231b-232a.

as referring to a cloak, coat, or tunic.<sup>390</sup> Another candidate for this designation could also be ‘shirt’.<sup>391</sup> The *gulēnu* was a linen garment<sup>392</sup> characterised by a red front-piece,<sup>393</sup> which could be of the country-<sup>394</sup> or of the port-type.<sup>395</sup> Neo-Babylonian documents show that this item of clothing could be made of wool or *biršu*-material.<sup>396</sup> *Gulēnus* were an important component of dowries in Babylonia.<sup>397</sup> From a Babylonian letter of the Assyrian royal correspondence we also learn that there was another category of such a textile, known as *gulēnu* ‘of the house’ (É).<sup>398</sup> This textile often occurs as a standard item of apparel in documents concerning uniforms to be supplied to troops and clothes to palace personnel,<sup>399</sup> but it also constituted a common garment for both men and women, as witnessed by its presence among other marriage gifts in a contract from Nimrud.<sup>400</sup>

*maqattu* (and *maqattutu*). The Assyrian form derives from the Pa“el participle present from *qt*‘, ‘to cut short’.<sup>401</sup> The form *muqattutu*<sup>402</sup> shows that it was understood in Assyrian as a D-stem participle. This garment has been interpreted as a sort of gown, perhaps a short-cut gown.<sup>403</sup> The item is also known with the variant *maqattutu*,<sup>404</sup> also spelled as *muqattutu*,<sup>405</sup> and it is tempting to see in this feminine designation a variety of the basic *maqattu*. Of this textile, both a linen<sup>406</sup> and a *biršu*-variety are known.<sup>407</sup> The former is qualified as having a red coloured front-piece,<sup>408</sup> in one case specified as commercial red.<sup>409</sup> Linen *maqattus* could also be multi-coloured.<sup>410</sup> The variety made with *biršu* could have a black<sup>411</sup> or red<sup>412</sup> front-part. The material called *biršu* (see also above) was probably a course fabric,<sup>413</sup> but some authors think it has to be understood

390. CTN 2, 1:11’; 154 r.2’; ND 267 (*Iraq* 12 [1950], 195, tablet not copied); ND 2097:8 (*Iraq* 23 [1961], 19, pl. IX); ND 2307 r.1 (*Iraq* 16 [1954], 37, pl. VI); ND 2691:9 (*Iraq* 23 [1961], 44, pl. XXIII); PVA 246; SAA 1, 193:4’, r.2, 6; SAA 7, 94:2; 96:2, 4, 5; 98:8, 12; 105:2; 107 r.8; 113:1, 4; 117 r.4; SAA 10, 289 r.5; SAA 11, 28:11; 36 ii 13; SAA 17, 69 r.21; TH 48:10; TH 52 r.13; TH 63:7. See AHw, 296b; CAD G, 127a; CDA, 96a; AEAD, 31b.

391. See Postgate 2001, 385.

392. ND 2097:8 (*Iraq* 23 [1961], 19, pl. IX).

393. PVA 247; SAA 7, 96:5’; 98:8’; 107 r.8’.

394. SAA 7, 96:5’.

395. SAA 7, 107 r.8’.

396. See CAD G, 127b s.v. *gulēnu* b.

397. Roth 1989-90, 30, texts Nbn 990:12; TuM 2-3, 2:27; VAS 6, 275:3.

398. SAA 17, 69 r.21.

399. SAA 1, 193:4’, r.2, 6; SAA 11, 36 ii 13; TH 48:10; TH 63:7.

400. ND 2307 r.1 (*Iraq* 16 [1954], 37, pl. VI).

401. DJBA, 1007b; LS, 660a.

402. StAT 2, 164:12; 255:6’; VAT 8659:2 (quoted in Parpola 2008, 57).

403. ND 2687:3 (*Iraq* 23 [1961], 43, pl. XXIII); ND 3407:5 (*Iraq* 15 [1953], 138, pl. XI); SAA 7, 93:1; 94:4; 95:1, 2, 6; 97 r.1, 3, 5, r.2; 98:4’; 104:1’, 2’, 3’, 4’; 107 r.9’; 108 r. ii’ 3’; 109 iii 2’, r. ii 2, 4, 6; 111:1; 112:10’; 115 ii 9; StAT 3, 1:15. See AHw, 607b; CAD M/I, 251a; CDA, 196b. AEAD, 60a distinguishes two lemmata, *maqattu*, ‘(short) gown’, and *maqattutu*, ‘(short) felt-gown’. A discussion on these terms is in Parpola 2008, 56-57.

404. ND 2311:5 (*Iraq* 23 [1961], 20, pl. X); PVA 249; ZTT I, 8:2.

405. StAT 2, 164:12; 255:6’; VAT 8659:2 (quoted in Parpola 2008, 57).

406. SAA 7, 97 r.1, 5; 108 r. ii’ 3’; 109 iii 2; 112:10’.

407. SAA 7, 95:1, 2; 97 r.3; 98:4’.

408. SAA 7, 97 r.1; 108 r. ii’ 3’. *Maqattus* with a front-piece are also mentioned in SAA 7, 103 r.3’; 104:3’; 109 iii 2’, r. ii 7.

409. SAA 7, 97 r.1.

410. SAA 7, 97 r.5.

411. SAA 7, 95:1; 98:4’. Another *maqattu*-garment with black front-part is mentioned in StAT 3, 1:15, although Faist prefers to translate the occurrence as meaning “*maqātu*-Gewänder (mit) schwarzer Breitseite”.

412. SAA 7, 95:2; 97 r.3.

413. See Postgate 2001, 386. In Villard 2010, 395 the term *biršu* is translated as ‘de texture grossière’ and, alternatively, ‘feutré’.

as felt.<sup>414</sup> However, the term for felt in Assyrian seems to be *tahapšu*.<sup>415</sup> According to CAD, the word indicates a ‘woolen fabric with raised nap’.<sup>416</sup> Villard observes that the word *biršu* referred to wool products and that it probably indicated a finishing process which was executed on textiles of ordinary type.<sup>417</sup> With this coarse cloth other kinds of garments were produced in the Neo-Assyrian period, such as the *muklālu*, the *našbutu*, the *šupālītu halluptu*, and the *urnutu*.<sup>418</sup> A group of textile labels from Nineveh also documents the existence of a ‘*maqattu* of the house’,<sup>419</sup> perhaps an ordinary variety of this textile to be used indoors;<sup>420</sup> it could be red<sup>421</sup> with a (commercial) red-coloured front-part.<sup>422</sup> Interestingly, three exemplars of this piece of apparel occur in a marriage contract from the archive of the Egyptians of Assur (Archive N31); among the garments which Pabba’u gives to his daughter Mullissu-hammat as dowry there are also one house-quality *muqattutu*, one clean *muqattutu*, and a third-one of good-quality.<sup>423</sup> This shows that this garment was used by ladies. In another administrative document from Nineveh we may see that this textile could also be fabricated without front-piece; in this case, the *maqattu* was probably untailed and consisting in the cloth for the rear part of the garment.<sup>424</sup> Alternatively, it is also possible that the front-part of the *maqattu*

in question was not red-coloured and this indication could have been omitted by the scribe. The production of this textile constituted an important activity of the palace-oriented textile industry of the later Assyrian Empire. According to an account of raw materials made by the central administration, 20 talents of madder were issued by the Palace to produce 600 coloured *maqattus* and 600 *urnutus*.<sup>425</sup> Although the text does not give us any piece of information about the recipients and the final destination of these garments, it is clear that the palace dyers used the issued *Rubia tinctorum* as a colorant to dye the textiles in question. As to their destination, it is possible that they were distributed to palace officials and personnel. In a badly preserved memorandum about clothing, a certain Šamaš-iddin, perhaps a government official, is mentioned as the recipient of a *maqattu* and an *urnutu*.<sup>426</sup> The same text also mentions officials who were expected to provide garments to the central administration<sup>427</sup> and were in connection with a *rab hanšê*, ‘commander-of-fifty’.<sup>428</sup> Finely woven *maqattus* produced by the Assyrian palace weavers were also destined to be distributed as luxury goods to foreign leaders, as seems to be suggested by an amount of 2 minas of red wool for the production of gowns for some sheikhs in a short record of wool and flax from Nineveh.<sup>429</sup>

414. See, e.g., Parpola 2008, 56.

415. On *tahapšu* as felt, see Cancik-Kirschbaum 1999; Postgate 2000, 213-217; Postgate 2014, 406-407. On felting in the Ancient Near East see Völling 2008, 150.

416. CAD B, 261a s.v. *biršu* 2.

417. Villard 2010, 395. There is only one occurrence of the term *biršu* in the Middle Assyrian text corpus. See KAV 99:18-19, concerning a yellow and decorated *biršu*-textile. See Postgate 2014, 418 for the translation of *biršu* as ‘rug’.

418. On the use of this material, see SAA 7, 95:1, 2; 96:7’, 11’, r.1, 2; 97:4’, 10’; 98:4’, 5’; 99:4; 100:3’; 102:2’; 105:10’; 107 r.4’; 109 r. iii 9’; 119 r. ii’ 3’.

419. SAA 7, 93:1; 94:4; 99:2; 104:2’.

420. See Fales & Postgate 1992, xxvii.

421. SAA 7, 99:2.

422. SAA 7, 93:1-2; 94:4.

423. StAT 2, 164:12-13.

424. SAA 7, 107 r.9’ [x x (x x) *ma-qa*]-*tī*’ NU ZAG.

425. SAA 7, 115 ii 9-10.

426. SAA 7, 112:10’-e.12’.

427. SAA 7, 112:3’-7’, r.1-5.

428. SAA 7, 112 s.1-3.

429. SAA 7, 111:1-2.

***Other Neo-Assyrian terms for items of clothing of unclear meaning and of non-Semitic origin***

The Neo-Assyrian textile terminology includes garment designations whose etymology has not been elucidated by the scholars. Apart from West Semitic loanwords, the nomenclature of garments in Assyria is characterised by the presence of non-Semitic terms.

*hulsu*. The term only occurs in the lexical list PVA<sup>430</sup> and in a document from Nimrud.<sup>431</sup> No etymology is proposed in the dictionaries, which translate the term as ‘a type of garment’.<sup>432</sup> The term is omitted in CAD and AEAD. In Syriac, the word *ħelsā* (*ħls*, *ħls*’) designates a horse-cloth or saddle.<sup>433</sup>

*huzīqutu*. The word is attested in the form *hazīqatu* only in Akkadian lexical lists as a designation for a head covering.<sup>434</sup> The same form is also documented in Mari.<sup>435</sup> In an administrative text from Nineveh it is attested in the form *huzīqutu*.<sup>436</sup> In this document the term occurs among *šipirtu*-textiles and head-cloths. It has been tentatively interpreted as a nominal form derived from the verb *hazāqu*, whose meaning, however, is unknown.<sup>437</sup> As a working hypothesis, we may suppose that this verb also had the

meaning ‘to gird’, as in Aramaic.<sup>438</sup> A textile designation based on this root is attested in Syriac in the form *ħzāq*, *ħzāqā* (*ħzq*, *ħzq*’), which means ‘belt, bond’.<sup>439</sup>

*huzūnu*. The Neo-Assyrian term occurs in a lexical list and in various administrative and legal documents.<sup>440</sup> The word presents a plural *huzunāte*, also attested in the form *huzu’āte*,<sup>441</sup> with disappearance of [n] in intervocalic position.<sup>442</sup> CDA connects the term to the word *hušannu*, ‘sash, belt’, attested in Neo-Babylonian.<sup>443</sup> In Aramaic, the verb *ħsn* (<*hzn*) means ‘to be strong’.<sup>444</sup> We may then suppose that this designation probably refers to an operation of strengthening of the fabric within or following the weaving process. In an administrative document from Nineveh it is mentioned along with *qirmus*, veils, and *gulēnus*,<sup>445</sup> while in another document which originates from the same bureaucratic context it occurs between *urnutus* and *elītu*-garments.<sup>446</sup> In a marriage contract from the archive of the Egyptians of Assur the *huzūnu* follows *muqaṭtutus* and *našbutu*-garments.<sup>447</sup> Neo-Babylonian texts show that it was a component of wardrobes of statues of divinities and other divine beings.<sup>448</sup>

430. PVA 242.

431. CTN 2, 1:11’.

432. AHw, 354b; CDA, 119b.

433. LS, 235a; Sokoloff 2009, 458a.

434. CAD H, 166a.

435. Durand 2009, 44.

436. SAA 7, 120 ii’ 15.

437. CDA, 113b.

438. See DJPA, 194: ‘to wrap around’; Sokoloff 2009, 440a: ‘to gird’.

439. LS, 225a; Sokoloff 2009, 440b.

440. ND 2307:17, 19, r.5 (*Iraq* 16 [1954], 37, pl. VI); ND 2311:7 (*Iraq* 23 [1961], 20, pl. X); PVA 281; SAA 7, 98:13’; 102:3’; StAT 2, 164:14.

441. ND 2307:17 (*Iraq* 16 [1954], 37, pl. VI).

442. Hämeen-Anttila 2000, 24.

443. CDA, 123b s.v. *huzūnu* II and 122b s.v. *hušannu*.

444. LS, 247b; Sokoloff 2009, 478b; ‘to be strong’; DJPA, 211a: ‘to become strong’; DJBA, 475a: ‘powerful’; Jastrow 1950, 488b; Drower & Macuch 1963, 151a; DNWSI, 391.

445. SAA 7, 98:13’.

446. SAA 7, 102:3’.

447. StAT 2, 164:14.

448. Beaulieu 2003, 15.

*iarītu*. The term, which is attested in documents from the Fort Shalmaneser in Nimrud,<sup>449</sup> is only listed in CDA and AEAD.<sup>450</sup> In CDA it is tentatively interpreted as a feminine nominal form from the word *aiaru*, ‘rosette(-shaped ornament)’, and, consequently, as meaning ‘rosette(-ornamented clothing?)’.<sup>451</sup> Golden *aiaru*-ornaments are documented in the administrative texts from Nineveh in connection with garments.<sup>452</sup> In addition, hundreds of rosette-shaped appliqués were found in the Nimrud tombs; they served to decorate the garments of the buried Assyrian queens.<sup>453</sup> Possibly, rosette-covered garments were referred to as *iarītus* in Assyrian. An alternative hypothesis is that the Neo-Assyrian form is a loanword from West Semitic. The Hebrew word *yerī‘āh* refers to a (tent-)curtain made of goat’s hair.<sup>454</sup> This term is also attested in Jewish Palestinian Aramaic and Syriac.<sup>455</sup> The fact that *iarītu*-textiles also occur in a document from Nimrud dealing with provision of amounts of goat-hair<sup>456</sup> argues against the hypothesis that the *iarītu* was a finely decorated garment.

*išhu*. This word is interpreted as a designation for a cloth or a leather item.<sup>457</sup> CAD only mentions the Neo-Babylonian occurrences, where the word is preceded by the determinative for leather objects

(KUŠ).<sup>458</sup> It may be suggested that the Hurrian textile designation *išhenabe*, which is attested in Middle Assyrian texts,<sup>459</sup> and in Neo-Babylonian texts,<sup>460</sup> is probably based on the same lexical theme with the addition of Hurrian morphemes. Differently from the Neo-Babylonian counterpart, the Neo-Assyrian *išhu* is preceded by the determinative for textiles (TÚG). In addition, this textile is mentioned in an administrative list among other items of clothing (*maqattu*, *urnutu*, *hīlu*, and *nahhaptu*).<sup>461</sup>

*kandiršu*. This item of apparel is listed in dictionaries in different forms, *i.e.*, as *kundirāšu/kundirāšu*, *kundirašši*, *kandiršu*, and *kandirši*.<sup>462</sup> The origin of this textile designation, only attested in Neo-Assyrian documents, is unknown.<sup>463</sup> Apparently, the ending in *-(a)šše* seems to point at Hurrian as the language of derivation.<sup>464</sup> Another plausible hypothesis is that the term entered Assyrian via another language. In Middle Assyrian a textile designation *kuddilu* is attested.<sup>465</sup> Perhaps, this term re-entered Akkadian through the mediation of a Hurrian form with *<r>* and ending in *-(a)šše*. Instead, the word *kandarasānu*,<sup>466</sup> attested in Neo-Babylonian, has nothing to do with *kandiršu*. Neo-Babylonian texts document linen

449. CTN 3, 4 r.10; 5 e.10, r.16; 6:1.

450. CDA, 440b; AEAD, 39b.

451. CDA, 440b.

452. See, *e.g.*, SAA 7, 60 i 5-6.

453. Collon 2008, 105-118.

454. See Postgate 1973, 53 citing a Kwasman’s suggestion.

455. DJPA, 245b; Sokoloff 2009, 584b.

456. CTN 3, 4:7-r.10.

457. AHw, 394b; CAD I-J, 242a; CDA, 133b; AEAD, 42b.

458. CAD I-J, 242a: ‘a leather object’.

459. See CAD I-J, 241a s.v. *išhanabe* a and Postgate 2014, 418.

460. See Beaulieu 2003, 15, concerning clothes for the statues of goddesses.

461. SAA 7, 115 ii 15.

462. AHw, 1569b; CDA, 167a; AEAD, 46a (*kandirši*) and 51b (*kundirašši*). The distinction of two different words in AEAD is probably due to a mistake of the authors of this dictionary. Note that the two forms are included under the same entry in Fales & Postgate 1992, 214a.

463. AHw, 1569b. Note that CAD only lists the Neo-Babylonian attestations.

464. Wegner 2000, 49.

465. KAV 103:9; 200 r.2, 3; KAJ 136:3; 310:34, 35. A large variety of *kuddilu*-textile is attested in KAV 200 r.3. See CAD K, 492b.

466. CAD K, 148b.

*g/kandarasānu*<sup>467</sup> probably coming from *Gandar/Kandara(š)*, a north-eastern region of the Iranian Plateau.<sup>468</sup> The Neo-Assyrian attestations of the term *kandiršu* are limited to three administrative documents from Nineveh<sup>469</sup> and a marriage contract from Assur.<sup>470</sup> In an inventory text listing various objects, especially metal vessels, a section, unfortunately in fragmentary conditions, is devoted to textile products. The preserved lines include names for items of clothing, among which a number of *kundirašši*-garments.<sup>471</sup> Moreover, this item occurs as one of the commodities probably received by the governor of Bēt-nayalāni, among animals, wine and other precious items of clothing of possibly foreign origin: apart from one *kundiraššu* or *kundirašši*, the list of textile products includes four *šaddīnu*-garments and one head-cloth.<sup>472</sup> The second Ninevite inventory list seems to connect this item of clothing to a cultic milieu.<sup>473</sup> In fact, all the listed objects and foodstuffs were used in the Aššur Temple cultic rituals. The mention of a tuft of red wool in the same passage<sup>474</sup> confirms the use of all the listed textiles for ritual purposes, in all likelihood for royal rituals to be celebrated in the main Assyrian temple. It is also worth noting the association of the

*kandiršu*-garment with the *sasuppu*, a textile used in royal rituals<sup>475</sup> as well as in ceremonial banquets.<sup>476</sup> The *sasuppu* and the *kandiršu*-garment occur together also in the *Practical Vocabulary of Assur*;<sup>477</sup> this suggests that these items of clothing were probably complementary. This item of attire was also a component of female wardrobes. In fact, a marriage contract from the Archive N31 of Assur shows that *kundiršu*-garments (written as pl. *kundaraššāni*)<sup>478</sup> occur as a precious item of clothing among various types of garments belonging to the woman Mullissu-hammat. The fact that this woman was the daughter of the horse keeper of the goddess Ištar of Arbela corroborates the connection of this garment with the cultic sphere.

*kindabasi*.<sup>479</sup> This Middle and Neo-Assyrian word derives from Hurrian *kindabašše*.<sup>480</sup> The 1st-millennium form in Assyrian is *kindabasi*, while the Middle Assyrian shows the forms *kindabaše*<sup>481</sup> and *kiddapaše* (with assimilation *nd>dd*).<sup>482</sup> The latter can be compared with the Ugaritic textile designation *kdwt*, which has been explained as an assimilated variant of *kndpnt* (/kiddawaṭ(t)-/ < /kindapant-/).<sup>483</sup> The change <š> to <s> from Middle Assyrian to Neo-Assyrian may be explained in light of the treatment of sibilants in

467. GCCI 2, 361:8 GADA.gan-da-ra-sa-nu; YOS 3, 145:14 GADA.ka-an-da-ra.

468. Zadok 1985, 138; Vallat 1993, 125.

469. Ki 1904-10-9,154+r.48 (*Iraq* 32 [1970], 153, pl. XXVII); SAA 7, 121 i 6'; 174:5'.

470. StAT 2, 164:10.

471. Ki 1904-10-9,154+r.48 (*Iraq* 32 [1970], 153, pl. XXVII) 40' TÚG.kun-dir-a-[še] (Reconstruction of the occurrence by the author).

472. SAA 7, 121 i 4'-6' 4 TÚG.šad-din / 1 TÚG.kar-ZI.MEŠ / 1 kun-dir-a-še.

473. SAA 7, 174:5' TÚG.sa-su-up-pu' TÚG.kan'-dir'-še'.

474. SAA 7, 174:6' ni-ip-šú SÍG.HÉ.MED'.

475. See Menzel 1981, nos. 24 i 16; 28:10; 30:6; 31 i 12.

476. Müller 1937, 62, line ii 17.

477. PVA 286-288 TÚG.sa-su-pu / TÚG.:. ša TÚG.GADA / TÚG.kun-dar-a-ši.

478. StAT 2, 164:10-11 TÚG.ur-na-te GADA 4 TÚG.kun-dar-a-šā-ni / 1 TÚG.ur-nu-tu SÍG. It is interesting to observe that the material of the four *kandiršu*-garments is not indicated in the document. Perhaps, *kandiršu*-garments were not made with linen or wool.

479. Note that the term is recorded as *kindabassu* in AEAD, 50a, although the singular form is actually *kindabasi*, as witnessed by the attestation given in PVA 245 (TÚG.kin-da-ba-š' si').

480. Watson 2007, 88.

481. AfO 19 T.6:5 (Freydank & Saporetti 1989, 52) 1 TÚG.HI.A [ki]-in-da-ba-š[e]. See also Postgate 1979, 5 and Postgate 2014, 418.

482. *Iraq* 35, T.13, 1:1 (Freydank & Saporetti 1989, 84) ki-da-pa-še (with assimilation *nd>dd*).

483. Del Olmo Lete & Sanmartín 1996, 211b s.v. *kdwt*, *ibidem* 220a s.v. *kndpnt*. This textile has been interpreted as 'una prenda de vestir (¿prenda íntima femenina?)'. See also Vita 2010, 329.

the Neo-Assyrian dialect. I wonder whether the term *kindabasi* has something to do with the word *kamdu/kindu*, attested in Akkadian<sup>484</sup> and Ugaritic<sup>485</sup> as a designation derived from the verb *kamādu*, ‘to weave in a specific way’, and possibly referring to a cloth woven according to a special technique. From the ‘Middle Assyrian Harem Edicts’ it seems that it was a woman’s undergarment.<sup>486</sup> This interpretation is also followed by Postgate, who translates the Middle Assyrian term as ‘loincloth’.<sup>487</sup> Neo-Assyrian occurrences are in PVA and in two administrative documents.<sup>488</sup> One of these texts deals with the consignment of an unspecified number of *kindabasi*-garments,<sup>489</sup> presumably for internal palace distribution, while the second document states that this item of apparel was presented as offering material for the gods.<sup>490</sup> In that case, it is reasonable to think that this garment served to clothe the statue of the god.

*kirbīnu*. This term is only attested in PVA. No etymology is proposed in the dictionaries. Aramaic *krbn* is a variant of the verb *kbn*, ‘to gird (garment)’.<sup>491</sup>

*pazibdu*. This term for garment is only attested in a document from Assur<sup>492</sup> and in an inventory text from Nineveh.<sup>493</sup> The word is not included in the dictionaries. While the term is preceded by the determinative for linen items (GADA) in the Assur text, in the Nineveh text it is qualified as a garment

(TÚG). Moreover, in this administrative document it is described as a textile for the bathroom (*bēt ramāki*) and the *qirsu*-place.<sup>494</sup>

*pītu*. This term, which is not included in the dictionaries, occurs in a letter of the royal correspondence, in which Šumu-iddina informs the king about a statue of Bēl in the Esagil temple in Babylon. According to the words of Esarhaddon’s servant, the statue was short one-half of a TÚG.*pi-i*-DA. Cole and Machinist read the occurrence as *pītu* and interpret it as a name for a garment,<sup>495</sup> but the reading is far from certain.

*sibrītu*. The term *sibrītu* or *siprītu* occurs in a document from Kalhu,<sup>496</sup> where it is mentioned in the context of garments and other commodities. CDA tentatively connects the word to the textile designation *šipirtu*, indicating a kind of waist-belt or similar item of clothing (see below).<sup>497</sup>

*šipirtu*. The word is also attested in Neo-Assyrian in the form *šipirtu*,<sup>498</sup> resulting from the assimilation *rt>tt*. No etymology is given in the dictionaries. In CAD, which explains the term as possibly designating a special weaving technique or treatment, a connection with the verb *šepēru*, ‘to strand (hair or linen), trim, decorate’, is suggested.<sup>499</sup> Instead, a possible Aramaic origin is tentatively proposed in CDA,<sup>500</sup> probably on the authority of von Soden,

484. The dictionaries do not treat the forms *kamdu* and *kimdu* as variants of the same term. See, e.g., CAD K, 121a s.v. *kamdu*, 372a s.v. *kimdu*.

485. Del Olmo Lete & Sanmartín 1996, 220a s.v. *knd*.

486. AfO 17, 287:105. See CAD K, 384b.

487. Postgate 2014, 418.

488. PVA 245; SAA 7, 166:2; 176 r.5’. Another occurrence is possibly in Ki 1904-10-9,154+ r.49 (*Iraq* 32 [1970], 153, pl. XXVII) [x TÚG.kin-da-b]a’-si GADA (Reconstruction of the occurrence by the author).

489. SAA 7, 166:2 ša’-az-bu-su / ša TÚG.kin-da-ba-si, ‘‘A consignment of *kindabasi*-garments.’’

490. SAA 7, 176 r.5’-7’.

491. LS, 316a; Sokoloff 2009, 596b; Jastrow 1950, 609a.

492. StAT 2, 164:14 1 GADA.pa-zi-ib-du.

493. SAA 7, 120 ii’ 1 1 TÚG.pa-zi’-[ib-du] (Reconstruction of the occurrence by the author). The second sign of the word may be read as ZI.

494. SAA 7, 120 ii’ 2-3.

495. SAA 13, 181:7.

496. ND 2311:3 (*Iraq* 23 [1961], 20, pl. X).

497. CDA, 324b.

498. ZTT I, 8:1 TÚG` .ši-pi-tú.

499. CAD Š, 201b.

500. CDA, 339a.

who suggested a possible derivation from Aramaic *spr*, ‘flechten’.<sup>501</sup> This West Semitic form has also been related to Arabic *dfr*, ‘to weave, braid, twist’.<sup>502</sup> However, the Aramaic-oriented etymology of the Akkadian word has recently been rejected in light of the fact that a root \**spr* is not attested in Jewish Aramaic.<sup>503</sup> The reference to linen and especially to trimming in the verb *šepēru* could explain the Assyrian word as a designation for a trimmed textile. The term has been understood as referring to a scarf, (woven) girdle, sash, or waist-belt.<sup>504</sup> Given its attestation in the context of textiles for the personnel of the Assyrian royal army, it has been suggested that the *šipirtu* was the well-known broad waist-belt of the Assyrian soldiers.<sup>505</sup> In many pictorial representations of such waist-belts, the textiles in question are characterised by trims bordering them.<sup>506</sup> A red-coloured variety ‘of the port’ is attested in a label from Nineveh,<sup>507</sup> while a Nimrud label shows that also a white variety of *šipirtu* was in use.<sup>508</sup> This term also designated a drape used to cover chairs, probably characterised by the same kind of trim decorating the above-mentioned waist-belts. In an administrative text, an unspecified number of commercial-red

coloured *šiprāt(e)* is listed in connection with a chair.<sup>509</sup> This recalls the issues of wool for stuffing stools of the royal palace in a document from the archive of Tell Ali,<sup>510</sup> although in this case, the Middle Assyrian text does not specify the type of textile. In this Middle Assyrian archive we find another attestation concerning the use of *šipirtus* for furniture; in this case, a number of these textile products appear in association with beds of the royal palace furniture.<sup>511</sup> The same use of *šipirtus* continues in Babylonia in later times, as shown by a Neo-Babylonian contract mentioning a linen *šipirtu* related to a bed.<sup>512</sup> Among the coloured textiles represented in the wall paintings of the Assyrian palace at Til Barsip, in Room 47 we may see a drape with a checkerboard pattern covering the back of the royal throne where the Assyrian king is seated.<sup>513</sup> For this second usage of the *šipirtu*-textile, Postgate suggested the translation ‘rug, blanket’.<sup>514</sup> In Assyria, this textile was produced by a specialised weaver, called *ušpār šiprāti*.<sup>515</sup>

Other terms of the Neo-Assyrian terminology of garments remain obscure. These are *datāiu* (perhaps, formed with a toponym and the nisbe *-āiu*),<sup>516</sup>

501. von Soden 1977, 195. See also AHW, 1103b s.v. *šipirtu* III; DNWSI, 973 s.v. *sprh*<sub>2</sub>; Jastrow 1950, 1249b.

502. See AHW, 1103b.

503. Abraham & Sokoloff 2011, 51, no. 225.

504. K 6323+ r. i’ 8’ (Kwasman 2009, 116); PVA 244; SAA 7, 96:8’; 120 i’ 14, ii’ 12; 124:10’; 127:10’; SAA 11, 28:12; 42 r. i 4’; 67:1; 202 ii 17’; SAA 19, 14:12, r.1, 4; ZTT I, 8:1. The word also occurs in the unpublished text VAT 8659 (quoted in Parpola 2008, 57).

505. Postgate 2001, 385.

506. See, e.g., Fales & Postgate 1992, 124 fig. 30.

507. SAA 7, 96:8’.

508. ND 2086 (*Iraq* 23 [1961], 18).

509. SAA 7, 120 ii’ 12-14. See *ibidem* i’ 14 for another occurrence of *šipirtu*-textiles.

510. Ismail & Postgate 2008, 173, no. 23 e.12-r.15 10 MA.NA SÍG.MEŠ / a-na GIŠ.GU.ZA.MEŠ *šap-pa-la-te* / ša É.GAL-*lim a-na še-a-i* / ta-ad-na.

511. Ismail & Postgate 2008, 172, no. 22 e.5-6 [TÚG].*ši-ip-ra-te* / ša GIŠ.NÁ.MEŠ ša É.GAL-*lim*.

512. Roth 1989, text no. 38:13. See also Joannès 2014, 460, quoting the Neo-Babylonian contract. Joannès suggests that the *šipirtu* for beds was probably a sort of tapestry fabric.

513. Albenda 2005, 63, fig. 23.

514. Postgate 2014, 423.

515. CTN 3, 145 r. ii 14; SAA 6, 301:4; SAA 7, 115 r. i 7; SAA 12, 83 r.8; SAA 16, 55:2. See also the list of professions Sultantepe 52/8 ii 11 (cited in CAD S, 201b).

516. ZTT II, 33:6 4 TÚG.*da-ta-’-a-a*, ‘Four datean garments.’ This textile name is not explained by MacGinnis and Willis Monroe. Perhaps, this textile designation may be compared with two non-Assyrian personal names, namely *Datā* and *Dātāna* (with shortened form *Dātā*). See PNA 1/II, 381b-382a.



*iamnuqu*,<sup>517</sup> *iahilu*,<sup>518</sup> *kirnāiu* (perhaps yet another word formed by a toponym and the nisbe *-āiu*; it has been compared to Eblaic *kirnānu*, a name for a linen textile),<sup>519</sup> *nimrā'u* (a nominal form in *-ānu* from *namāru*, 'to be bright', or a foreign word? Cf. the Neo-Babylonian textile term *guzguzu*, of which the word *nimrā'u* was probably a synonym),<sup>520</sup> *supāqu* (from the verb *sapāqu*, 'to be sufficient?'),<sup>521</sup> [...] *rakkatum* (the occurrence is broken in the tablet, but it refers to a linen textile, perhaps *\*aparakkatu*?),<sup>522</sup> *zanu*[...] (perhaps, to be connected to the verb *zānu*, 'to stud [garments] with precious stones?'),<sup>523</sup> and *zazabtu*<sup>524</sup> (a variant form with allophone [z] from *\*zabzabtu/sabsabtu*? Cf. Middle Assyrian *sapsapu*, 'fringe of a garment').<sup>525</sup>

### Designations for parts of garments

The Neo-Assyrian textile terminology concerning parts of garments is very limited. From the extant attestations of these terms it seems that the interest of Assyrian administrators focused on a very limited set of parts of clothing items, presumably the ones that were considered as the most characteristic features of

certain garments, such as fringes, edging, and decoration. However, the meaning of some of these terms remains unclear.

*ahāte*. The plural term refers to sleeves of garments.

Pieces of clothing for arms were also called by the compound word *bēt ahi* (TÚG.É—Á.MEŠ) in the Neo-Assyrian dialect.<sup>526</sup> Only in a text from Ziyaret Tepe we find the logographic singular form Á. The qualification *ša ahāte* refers to *hullānu*.<sup>527</sup> The word *ahāte* was also used in the Middle Assyrian period as an abbreviated form to indicate 'garments with sleeves'.<sup>528</sup> Sleeves are treated as a separate item of clothing not only in 1st-millennium Assyria, but also in other regions of the Ancient Near East, as witnessed, for instance, by a 2nd-millennium document from Mari.<sup>529</sup> From a look at Neo-Assyrian palace reliefs it is clear that short sleeves characterised royal and, in general, male dresses,<sup>530</sup> while long sleeves were a characteristic of queens' garments.<sup>531</sup>

*appu*, 'fringe'.<sup>532</sup> This term is usually written with the logogram KA, followed by the obscure sign MA,<sup>533</sup> probably an abbreviation for a word indicating a special feature of the fringe. It seems that

517. PVA 241. See CAD I-J, 322a.

518. PVA 268; ZTT II, 33:5. See CAD I-J, 321a.

519. PVA 233. See CAD K, 408b. For the Eblaic *kirnānu* see Pasquali 2010, 180.

520. PVA 255. See CAD N/II, 234b s.v. *nimra'u*. The adjective *namru*, 'bright(ly coloured)', is used as name of a garment in the 2nd millennium BC. See CAD N/I, 241a s.v. *namru* 1 a 4'. The word *nimra'u* could be tentatively explained as a form affected by a change of the [n] of the adjectival ending *-ānu* into ['] for the intervocalic position of the nasal. See von Soden 1995, 42; Hämeen-Anttila 2000, 24. However, the fact that the word is written as *nim-ra-ah* in the tablet could indicate that the term is *nimrah*. Akkadian terms ending in *-ah* like *dardarah* (an ornament), *pirizah* (a plant), and *sirnah* (a garment), are Kassite loanwords. On the *guzguzu*-textile in Neo-Babylonian texts see Quillien 2013, 21-25.

521. PVA 279. See CAD S, 392a.

522. STAT 2, 164:16 [x x x x]-*ra-ka-tum* GADA. The feminine form *\*aparakkatu* is not attested in Akkadian. For the Neo-Assyrian headdress *aparakku*, attested in PVA 276, see CAD A/II, 166b.

523. SAA 7, 124:8'. See CAD Z, 47a.

524. SAA 7, 172 r.9. This term is not included in CAD. See CDA, 446a and AEAD, 133b.

525. MARV I, 24:11 ½ MA.NA SÍG.ZA.GÌN.SA<sub>3</sub> *a-na sa-ap-si-pi* TÚG.lu-bul-tu.

526. K 6323+ r. i' 7' (Kwasman 2009, 116); PVA 282; SAA 7, 120 i' 6 (not translated by Fales and Postgate). Note that in ZTT I, 8:3 this part of garment is indicated logographically as Á. See AEAD, 5a: 'arm piece'.

527. AfO 19, T.6:1-2 (Freydank & Saporetti 1989, 52).

528. KAV 105 r.24 TÚG.a-ha-te, '(garments with) sleeves'.

529. Durand 2009, 29. The French scholar translates the term *ahatum* as 'manche amovible'.

530. See, e.g., Barnett 1976, pls. 49-53.

531. Barnett 1976, pl. 65.

532. SAA 7, 108 i' 5'; 109 i 3', 5', ii 4', iii 4'.

533. SAA 7, 109 i 5', ii 4'.

*appus* were characteristic elements of *urnutu*-garments<sup>534</sup> and linen *maqattu*-garments.<sup>535</sup> Another word for fringe was *sissiqtu* (see below). Representations of fringed garments are ubiquitous in Neo-Assyrian visual art.<sup>536</sup> From the colourful wall paintings of Tiglath-pileser III's palace at Til Barsip we see that fringes of garments could be of different colours in alternation.<sup>537</sup>

*aqqābu*, 'hind-part'.<sup>538</sup> This textile component occurs in association with *gammīdu*-garments.<sup>539</sup> Perhaps, another occurrence of the word may be found in a list of textiles.<sup>540</sup> Von Soden connects this Assyrian word to Jewish Aramaic '*aqqābā*, which he translates as 'Überbleibsel'.<sup>541</sup> However, as pointed out by Abraham and Sokoloff, no such word with such a meaning exists in Aramaic.<sup>542</sup>

*betātu*, 'strings(?)'.<sup>543</sup> This item is interpreted by CAD as a decoration used on garments and leather objects.<sup>544</sup> It is worth noting that this textile term occurs in connection with *nahlaptus*. In fact, PVA also lists a *nahlaptu ša betāti* among different types of *nahlaptu*.<sup>545</sup> The interpretation by MacGinnis and Willis Monroe that the *betātus* mentioned in a Neo-Assyrian document from Ziyaret Tepe refer

to 'slippers'<sup>546</sup> is only based on El-Amarna attestations concerning leather objects.<sup>547</sup> The editors do not consider that the word is also used in Middle Assyrian times in connection with leather containers and, as far as the Neo-Assyrian period is concerned, for qualifying cloaks. Instead of 'decoration' or 'slippers', it is possible that shoelaces and purse strings were named with this term. In the case of *nahlaptus*, it is possible that the *betātus* were strings used to tie the cloaks. In fact, from the Ziyaret Tepe tablet we learn that *betātus* were associated with various items of clothing.<sup>548</sup>

*birmu*, 'multi-coloured trim/border?'.<sup>549</sup> This word is a nominal form from the verb *barāmu*, 'to be multi-coloured'.<sup>550</sup> The item in question is peculiar to the textiles called *kusītu*, *maqattu*, and *qarrāru*. Postgate supposes that the term *birmu* designated a cloth strip used as an edging for garments, which is, presumably, the same function of the *sūnu*-item (see below), although differences between the two textiles are not known.<sup>551</sup> It is interesting to observe that a Middle Assyrian text mentions a *birmu* for the statue of the king;<sup>552</sup> presumably, it served to embellish the

534. SAA 7, 109 ii 4'.

535. SAA 7, 109 iii 4'.

536. See, e.g., Layard 1849-53, I, pl. 25 and *passim*.

537. Guralnick 2004, 223.

538. In AEAD, 9a the word is treated as a variant of *aqbu* and translated as 'heel, lower part, extremity'. Instead, the other dictionaries distinguish the two terms. See, e.g., CAD A/II, 207a s.v. *aqqabu* (not translated) and CAD E, 248b s.v. *eqbu*: 'heel, hoof'.

539. SAA 7, 115 r. ii 17-18.

540. SAA 7, 109 r. iv 1'-2' [*aq-qa*]-*bi* x x[x x x x] / [x] KUN? GÙN.A KUR?, "[The hind-pa]rt of [...-textile(s)], [...] the rear, multi-coloured, of the country" (Reconstruction of the broken part of the occurrence by the author).

541. von Soden 1966, 6.

542. Abraham & Sokoloff 2011, 26, no. 13.

543. PVA 223; ZTT II, 33:7.

544. CAD B, 214b.

545. PVA 223.

546. MacGinnis & Willis Monroe 2013-2014, 52.

547. EA 22 ii 27, iii 26. See CAD B, 214b.

548. ZTT II, 33:1-7 7 TÚG.AN.TA.MEŠ / 4 TÚG.ma-ak-[ul.MEŠ] / 2 TÚG.KI.TA—'hal-lu-pat' / 1 TÚG.ša'—IŠ ša hi-[l]a<sup>2</sup>-nu / 2 TÚG.ia-hi-li / 4 TÚG.da-ta-'-a-a / a-na 5-šú TÚG.bet-ta-tu, "Seven upper garments, four shaw[ls], two reinforced undergarments, one dust garment with wrappings, two *iahilus*, four *datean* garments for five pairs of *betātus*."

549. Billa 71:1, 5 (JCS 7 [1953], 137); K 6323+ ii 17' (Kwasman 2009, 114); RINAP 3/2, 154 r.5'; 223:33; SAA 7, 70 i' 2'; 97 r.5; 99:1; 104 r.3'; 105:6', 7'; 108 i' 8'; 109 r. iv 2', 6'; SAA 12, 35:26; 36:17; SAA 16, 84 r.12; StAT 3, 1:9.

550. CAD B, 103a s.v. *barāmu* B.

551. Postgate 2014, 409-410.

552. MARV III, 71:6 (StAT 5, 92) *bir-mu ša ša-lam* LUGAL.

vestments that covered the statue. The *birmu* was produced by a specialised weaver called *ušpār birmi*.<sup>553</sup> Another plausible hypothesis is that *birmu* indicated a multi-coloured breast-piece which was added to vestments. Royal garments are usually represented in palace reliefs as having a finely-executed round- or rectangular-shaped decorative part in the breast-area,<sup>554</sup> although it is not certain whether such breast-pieces were made of fabric or metal plaques.

*kišiptu*, ‘cut-off piece (of a garment)’.<sup>555</sup> This meaning is not included in the dictionaries, which only record the meaning ‘calculation’ (from the verb *kašāpu/kešēpu*, ‘to think, estimate’).<sup>556</sup> However, it is clear that the textile-related meaning of *kišiptu* hardly derives from the verb *kašāpu/kešēpu*,<sup>557</sup> while the best candidate seems to be *kašāpu* (II), which seems to be a Neo-Assyrian form of *kasāpu*, ‘to cut off’.<sup>558</sup>

*libītu*. This term, derived from *labû* (*lamû*, *lawû*), ‘to encircle’, probably designated the rim or border of garments.<sup>559</sup> It is attested in the logographic form NIGÍN in lists of textiles from Nineveh as a descriptive element of *našbutus*,<sup>560</sup> *urnutus*,<sup>561</sup> and *šupālītu halluptu*-garments.<sup>562</sup> In the case of *urnutu*, the border of this garment was also indicated as *sihru* (see below). The word is not a

novelty of the 1st millennium, since the qualification *ša liwītim*, translated as ‘for wrapping’, occurs in Old Assyrian texts in association with textile products.<sup>563</sup> The border of Neo-Assyrian garments could be decorated by a variety of elements (*e.g.*, rosettes, square-shaped ornaments, *etc.*), often in alternation, and the presence of tassels and fringes.<sup>564</sup> The Nimrud textile remains show that tassels were used to embellish the border of one or more garments of the Assyrian queens buried there.<sup>565</sup>

*nītu*. A Nimrud document shows that *nītu*-element(s) characterised the garment called *šupālītu halluptu* in Neo-Assyrian.<sup>566</sup> In a text from Tell Billa this item occurs in association with *nahlaptu*-garments.<sup>567</sup> The meaning of the word *nītu* is not clear: AEAD suggests that it was a precious item,<sup>568</sup> perhaps used as a decoration for this garment. The verb *nētu* means ‘to enclose, surround’ and the idea of enclosure seems to fit well to the function of a metal clasp as well as of a decorative geometrical element, for example, a circle. However, we cannot rule out that it refers to a specific structural element of *šupālītu halluptus* and *nahlaptus*.

*pūtu*, ‘front-part’.<sup>569</sup> This element, which is indicated in the texts with the logogram ZAG, occurs

553. ADW 9:4; SAA 6, 42 r.8; SAA 12, 27:24; 94:5.

554. See, *e.g.*, Layard 1849-53, I, pls. 5-6, 19; Fales & Postgate 1992, 116 fig. 27.

555. CTN 2, 1:5’, 7’, 8’. This meaning is not included in AEAD, 50b.

556. CDA, 161b.

557. CAD K, 314a.

558. Postgate 1973, 27 fn. ad 5’.

559. CAD L, 191a.

560. SAA 7, 96:11’; 97:11’; 102:1’.

561. SAA 7, 96 r.2; 102:2’.

562. SAA 7, 105:9’, 10’.

563. Michel & Veenhof 2010, 241.

564. Layard 1849-53, I, pls. 5, 12, and *passim*; Barnett 1976, pls. 40, 49, and *passim*.

565. See Crowfoot 1995, 115 fig. 4.

566. ND 2687 r.10 (*Iraq* 23 [1961], 43, pl. XXIII) 1 TÚG.: *ina ni-tú*, ‘One ditto (= reinforced undergarment) with *nītu*-element(s)’ (Reconstruction of the line by the author).

567. Billa 61:19-21 (JCS 7 [1953], 135) [x TÚG.]GÚ.È [x]x x x / [x]x 12 *ni-tu*-[x x x] / [x] *ma-hi-šu*, ‘[... n]ahlaptu-garment(s) [of ..., with] 12 *nītu*-elements(?), [...] the weaver [x x x]’.

568. AEAD, 77b. This meaning is not included in the other dictionaries.

569. SAA 7, 93:1; 94:4; 95:1; 96:5’, 7’, r.1, 2, 4; 97:7’, 10’, r.1, 3; 98:4’, 5’, 8’, 9’; 102:5’; 104:3’; 105:3’, 8’; 107:8’, 9’, 10’; 108:14’, 15’, r. ii’ 3’; 109 r. iii’ 7’, 9’; StAT 3, 1:15.

in descriptions of the items of clothing called *gulēnu*, *maklulu*, *maqaṣtu*, *naṣbutu*, *qirmu*, *rad-didu*, *ša GIL* and *urnutu*, as well as of the *sasuppu*-napkin.<sup>570</sup> It is not clear whether the term *pūtu* indicates the whole surface of the front-part of a garment or a small area of it. In the case of the *nixsu*-textiles mentioned in a list from Assur, the red *pūtu* is associated with red sides (braids?).<sup>571</sup> The *pūtu*-element of Neo-Assyrian garments is usually red, except for some attestations where it is black.<sup>572</sup> These references to coloured front-parts of certain garments suggest that the rear parts had a different colour, probably black in the case of red *pūtus*. On this regard, the literary text of the *Marduk Ordeal* is very informative. In this composition, there is a passage concerning the goddess Ištar, precisely her manifestation in Babylon, who was called ‘The Lady of Babylon’. The text describes the vestment which covered her statue in the temple and uses the word *šipātu* in metonymical function to indicate her garment. What is worth noting here is that her *garment* (literally, ‘wool’) is said to be black on her back (*ina kutallišāni*) and red on her front (*ina pānišāni*).<sup>573</sup> This description of Ištar’s garment matches the attestations of red *pūtus* given in the Nineveh administrative textile lists. If so, the use of the term *pūtu* in textile qualifications may be considered analogous to that of the word *pānu*. The use of the term *pānum* in descriptions of Mari textiles is possibly referring to

the technique of lining, according to Durand.<sup>574</sup> It is possible that the mention of coloured ‘front-parts’ in Assyria was analogously used to indicate lined textiles.

*sihru*. With this term, derived from the verb *sahāru*, ‘to go around, turn’, the edging or border of garments was probably indicated.<sup>575</sup> In the Neo-Assyrian texts, it is attested in its logographic form NIGÍN in connection with *šaddīnus*<sup>576</sup> and *urnutu*-garments.<sup>577</sup> It is not clear whether *sihru* and *libītu* (see above) were synonyms or whether a certain semantic distinction between the two terms was at work in their use in descriptions of textiles. However, the fact that both terms are used for the same item, namely *urnutu*, seems to suggest a synonymic relationship between the two. The possibility that the logographic form NIGIN is used in alternative to NIGÍN is considered by Fales and Postgate.<sup>578</sup>

*sissiqtu* (also *zizziqtu*), ‘hem, fringe’.<sup>579</sup> The form with emphatic velar is confirmed by a Middle Assyrian attestation<sup>580</sup> and suggests to normalize the Babylonian and Assyrian form as *sissiqtu* (from \**siq-siqtu*), instead of *sissiktu*.<sup>581</sup> The phonetical rendering *zizziqtu* in a letter of the royal correspondence of Esarhaddon<sup>582</sup> shows that [z] was an allophone for <š>.<sup>583</sup> The *kusītu*’s hem is only attested in Middle Assyrian texts.<sup>584</sup> It seems that hems of garments were managed as separate items by the state administration, as shown by an attestation

570. For the red-coloured front-part of *sasuppu*-napkins, see SAA 7, 120 ii’ 4-6.

571. StAT 3, 1:10-11.

572. See SAA 7, 95:1; 98:4’; 107:10’; 109 r. iii 11’.

573. SAA 3, 34:42-43 [<sup>a</sup>*be-lit*—KÁ.DINGIR].RA.KI *ša SÍG.MI ina ku-tal-li-šá-ni SÍG.tab-ri-bu ina pa-ni-[šá-ni 0] / [x x x ina pa-na-i]u-uš-šá da-mu ša šur-ri ša tab-ku-u-ni [šú-nu]*, “[The Lady of] Babylon who has black wool on her back and red wool on her front [...]: [the red wool] on her [front] is blood of the heart which was shed [...]”.

574. Durand 2009, 78.

575. CAD S, 239a.

576. SAA 7, 96 r.2; 97:12’; 102:2’; 109 ii 2’.

577. SAA 7, 109 ii 4’, 5’, 6’, 7’.

578. Fales & Postgate 1992, xxviii.

579. PVA 299; SAA 3, 11 r.14; SAA 16, 36 r.16.

580. MARV III, 8 r.25’ *zi-zi-qa-tu-šu-n[u]*.

581. See Postgate 2014, 425-426 for discussion and references.

582. SAA 16, 36 r.16 TÚG.*zi-zi-ik-tú*. For the form with <š>, see, e.g., SAA 10, 298:17 TÚG.*ši-ši-ik-ti-sú*.

583. Hämeen-Anttila 2000, 10.

584. MARV III, 5 r.38’-39’.

in a document from the palace administrator's archive in Assur.<sup>585</sup> The hem of a garment played an important role in Mesopotamian legal transactions. Interestingly, the practice of sealing legal documents with the garment's *sissigtu*<sup>586</sup> seems to be attested also in the Neo-Assyrian period, as witnessed by a clay tablet from Til Barsip, where imprints of two cords ending in a fringe of tiny threads are still visible.<sup>587</sup>

*sūnu*. This term designates a part of a garment. In Mari texts it refers to a textile end product and a type of wool.<sup>588</sup> When related to a textile, Durand translates the word as 'gigot, galon, ourlet'.<sup>589</sup> Also in Nuzi and Kassite Babylonia the *sūnu* was a component of a garment. In Middle Assyrian times, *išhanabe*- and *ašiannu*-garments, as well as *tusahhuri*-wrappings, are mentioned with their own *sūnu*.<sup>590</sup> This cloth-piece could be of *takiltu*-wool, according to Bābu-aha-iddina's archive.<sup>591</sup> In 1st-millennium BC Assyria this textile was associated with other garments. In a document from Kalhu it occurs with a garment called *ša IŠ* (see above).<sup>592</sup> In that case, Postgate translates the term as 'breast-piece'.<sup>593</sup> In an administrative text from Nineveh *sūnu* denotes a part of

an *urnutu*-garment.<sup>594</sup> Dalley's interpretation of the *sūnu* as a 'trimming'<sup>595</sup> seems to accord with the Middle Assyrian attestations.<sup>596</sup> In contrast, in a Neo-Babylonian letter of the royal correspondence *sūnu* is used as a commodity of its own; in fact, the sender of the letter states to have sent one *sūnu* of very good quality,<sup>597</sup> which was probably destined to the gods' statues.<sup>598</sup> In this case, the item in question is understood by Dietrich as a 'sash'.<sup>599</sup> In Neo-Babylonian sources the *sūnu* occurs among the items of dress used to cover the statues of gods Dumuzi, <sup>4</sup>IGI.DU, and 'the Goddesses'.<sup>600</sup>

*ušurtu*. The term indicates the design or pattern of garments. The cloth with designs or patterned fabric, called *ša parāki*(?) (reading uncertain, written as *ša GIL*), occurs as a separate textile item in administrative records;<sup>601</sup> it was probably added to various areas of garments, especially on the chest, the sleeves and the border.<sup>602</sup> We also know that the *nahlaptus* could be enriched by decorative designs.<sup>603</sup> Different elements of the decorative design characterising Assyrian luxury garments are explicitly mentioned in an administrative text from Nineveh: unfortunately, the name of the garment decorated with pomegranates (*nurmū*)

585. MARV X, 54:10 (Stat 5, 54) PAB 5 TÚG.zi-zíq-qa-[te]. But note that Prechel and Freydank transliterate the occurrence as TÚG. si-sik-k[a<sup>21</sup>-tu].

586. CAD S, 323a s.v. *sissiktu* b.

587. Bunnens 2012, 79 and fig. 13.

588. Durand 2009, 93-95, 149.

589. Durand 2009, 94.

590. Donbaz 1991, 77, A 70:1-2 1 TÚG.iš-ha-na-be / ša ÚR BABBAR. See also Postgate 1979, 7.

591. Donbaz 1991, 74-75, A 1722:1-2; AfO 19, T.6:9-10 (Freydank & Saporetti 1989, 52).

592. CTN 2, 153:2. In the same text, *ša IŠ* garments without breast-piece occur. See *ibidem* 3.

593. Postgate 1973, 166.

594. SAA 7, 109 ii 5'. The term is not translated by Fales and Postgate.

595. Dalley 1980, 72-73.

596. Postgate 2014, 422-423.

597. SAA 17, 77 r.15' 1'-en' TÚG'.ÚR bab-ba-nu-ú.

598. See SAA 17, 77 r.18e TÚG.ÚR' šá [x] DINGIR.MEŠ.

599. Dietrich 2003, 71.

600. Beaulieu 2003, 15.

601. SAA 7, 108 r. ii' 6' [x x š]a<sup>2</sup>—GIL' GIŠ.HUR.MEŠ, "[... c]loth (with) designs." See also SAA 7, 117 s.1 1 TÚG.šá—GIL 'GIŠ'.H[UR.MEŠ'] (Reconstruction of the occurrence by the author). The *ša parāki*(?) also occurs in SAA 7, 63 iii 20' [x x] šá<sup>2</sup>—GIL.MEŠ x[x x x]; SAA 7, 96 r.4 9 TÚG.šá—GIL ZAG' [x x (x x)].

602. See Guralnick 2004, 231 for the hypothesis that some borders of patterned fabric were separately woven and attached.

603. See PVA 225 TÚG : ša 'GIŠ.HUR'.MEŠ.

is not preserved in the document,<sup>604</sup> while a bull (*alpu*)<sup>605</sup> and a goat (*šibtu*)<sup>606</sup> are mentioned as decorative elements of *urnutus*. These decorative elements may be identified, for instance, with the bulls, goats and pomegranates represented on Assurnāširpal II's garments.<sup>607</sup> It seems that fabrics decorated with mythological beings and religious scenes were limited to the reign periods of Assurnāširpal II (883-859 BC) and Assurbanipal (668-631? BC).<sup>608</sup> As regards vegetal motifs, petals and leaves have been detected on the tiny fragments of patterned textiles found in the Tomb 1 at Nimrud.<sup>609</sup>

*zibbutu*, 'tail, tail-end'. This term, logographically written as KUN,<sup>610</sup> is interpreted as referring to the rear part of garments.<sup>611</sup> From the extant attestations in the Nineveh administrative text corpus, it seems that the *zibbutu*-element characterised red garments.<sup>612</sup> In one case, both the front-part (*pūtu*) and the rear part of a garment are mentioned.<sup>613</sup> We also know that garments with a *zibbutu*-element also had fringes.<sup>614</sup> It is also possible that this designation indicated the lower part of garments ending in a sort of 'pointed tail'. The lower part of a variety of male garment of the 7th century BC seems to be the best candidate of the *zibbutu* mentioned in texts. Assurbanipal is depicted in his reliefs from Nineveh<sup>615</sup> as wearing an asymmetrical skirt; in other words, a skirt which is short in front and long in back and ending with a 'pointed tail' in the rear part.

### Textile techniques from garment designations

If we consider the Neo-Assyrian vocabulary of genuine Assyrian descent, apart from the general idea of covering, which inspired the designations of many Assyrian garments (*lubuštu*, *kusītu*, *nahlaptu*, *qirmu*, and *ša hīli*) or of binding, girdling, or tying (*kirbīnu?*, *nēbettu*, *nēbuhu*, and *sunābu*), which confirm the idea that most items of clothing were untailed and in form of wrap-cloths, a number of terms are based on the idea of holding, seizing (see *našbutu*, but *šubātu* is problematic<sup>616</sup>). Others, however, refer to the position of the textile on the body and/or are in association with other items of clothing (*elītu*, *ša muhhi*, *ša qabli*, and *šupālītu*). Others may possibly be connected to their workmanship (*maklulu*, 'the light one?'). Some visual characteristics of the end product, such as the *ša taluk širri*, probably indicate the use of a finely-woven fabric, which generated an undulating movement when its wearer walked.

Some Neo-Assyrian terms for garments may be connected to specific textile techniques (see also Table 1), such as rubbing down (*mušiptu*, if this word derives from *šuppu* II, 'to decorate, overlay, rub down'. See also *gammīdu*, 'smooth cloak'); washing or rinsing (*šuhattu*); reinforcing or strengthening (*halluptu*, perhaps also *huzūnu?*); trimming (*šipirtu?*), and cutting (*maqaṭtu*, *niksu*). Perhaps, the operation of rubbing down (*mušiptu*) can be identified with the action of smoothing, which was executed on a textile's surface to make it shining and smooth, especially in

604. SAA 7, 109 i 2'.

605. SAA 7, 109 ii 3'.

606. SAA 7, 109 ii 5'.

607. See Layard 1849-53, I, pl. 5 and pls. 8 and 9 for details. See also *ibidem* pls. 43-50 for other attestations of bulls and goats as decorative elements of dresses. For pomegranates, see *ibid.* pl. 48 no. 3.

608. Guralnick 2004, 231.

609. Crowfoot 1995, 114, 117.

610. SAA 7, 106:2, 4; 107:2'; 108 i' 5'; 109 r. iv 2'.

611. See CAD Z, 102a s.v. *zibbatu* 2; Fales & Postgate 1992, 114 and *passim*.

612. SAA 7, 106:2, 4.

613. SAA 7, 107:2'.

614. SAA 7, 108 i' 5'.

615. See, e.g., Barnett 1976, pls. 50, 51, 52.

616. A derivation from the verb *šabātu* is rejected in Kaufman 1974, 95, where the scholar underlines the connection with the Neo-Babylonian garment name *šibtu*.

case of linen.<sup>617</sup> Washing, also an integral part of the textile production cycle, was done after the fabrics were woven. Other names for garments are based on the concept of reinforcing or strengthening. Here, different explanations may be proposed. A dense and coarse weave, namely a weave with closely packed threads, was probably the main characteristic of clothing items used as outer garments<sup>618</sup> for different functions. Coarse garments could be used as protection during the cold season but also as working clothes for menial activities or, just as importantly, as the standard dress for soldiers of the royal army. It is also possible that the reinforcing of fabric could be achieved through a fulling or smoothing process. Fulling the textile made it denser,<sup>619</sup> and kneading and stomping the fabric in wet and warm conditions thickened the fabric and closed its gaps.<sup>620</sup> In this way, textiles were made more waterproof<sup>621</sup> and thus more suitable for indoor and/or working use. Cutting and trimming actions could refer to operations executed after the cloth came off the loom, namely in the phase of manufacturing the item of clothing through the tailor's work. There are also words possibly related to the quality of the fabric (*qatattu*, *harīru*?) and others based on qualifications of wool varieties (see, e.g., *šer ʾitu*), as suggested above. Lower quality fabrics were probably referred to by those qualifications of garments based on the word *bētu*, 'house'. House-garments were probably made of coarse fabric, more suitable for everyday domestic activities. The opposite of the indoor or house-garment was the ceremonial vestment, made of fine fabric and for use on important public occasions outside the domestic milieu. In the case of garments explicitly related to women (*ša issi*), it is possible that their sizes differed from their male counterparts.<sup>622</sup> As regards internal differences within the same category of garment, it is unclear whether feminine forms of the same garment name were used to designate specific items of clothing (a small-sized variant of the

same garment?) or whether both masculine and feminine forms were used to indicate the same vestment. We cannot rule out that these forms reflect local differences within the Neo-Assyrian textile vocabulary.

More specific structural elements of Neo-Assyrian garments cannot be detected on the basis of the designations analysed in this study, but the archaeological evidence grants us a clearer idea of some material characteristics of the Neo-Assyrian clothes. As regards the weave of Neo-Assyrian garments used by urban social elites, for example, the few textile remains found in Assur and Nimrud demonstrate that rep weave and tabby weave characterised the dresses fabricated in Assyria during the 9th and 7th centuries BC respectively.<sup>623</sup>

### Conclusions

This study has shown that the Assyrian textile lexicon is characterised by a substantial continuity from the Middle Assyrian to the Neo-Assyrian dialects for a number of designations of garments. Other terms belong to the common 1st-millennium BC textile vocabulary, characterised by compound names with *ša* and West Semitic loanwords. A peculiar trait of the Neo-Assyrian vocabulary is vowel harmony, inherited from earlier stages of the dialect (e.g., Neo-Assyrian *nēbuhu* vs. Neo-Babylonian *nēbehu*; NA *našbutu* vs. NB *našbatu*; NA *gammīdutu* vs. NB *gammīdatu*). The mutual influence between Assyrian and Babylonian textile terminologies, which disseminated the same designations across both dialects, was probably due both to the Babylonian language's role in various sectors of imperial Assyrian society, especially as a scholarly and official language, and to the displacement of Assyrian-speaking groups (e.g., members of the royal army, merchants, and palace envoys) to various regions of the imperial territory, including Babylonia. The spread of Babylonian in

617. Andersson Strand 2010, 21.

618. Andersson Strand 2010, 16-17.

619. Völling 2008, 150.

620. On fulling, see Barber 1991, 216; Völling 2008, 149-150.

621. Andersson Strand 2010, 20-21.

622. See Durand 2009, 12 for analogous observations on male and female clothes in Mari.

623. Völling 2008, 124, table 2, 211.

1. Basic meanings	Textile terms	No textile techniques detectable
Covering	<i>labussu, kusītu, nahlaptu, qirmu, ša hīli</i>	--
Binding, girdling, tying	<i>nēbettu, nēbuhu, sunābu</i>	--
2. Meanings indicating specific operations	Textile terms	Textile techniques detectable(?)
Rubbing down	<i>mušiptu</i>	Smoothing linen?
Washing	<i>šuhattu</i>	Washing/rinsing
Reinforcing, strengthening	<i>halluptu</i>	Reinforcing through fulling or smoothing?
Cutting	<i>maqaṭtu, nīksu</i>	(As part of finishing procedures?)
Trimming	<i>šipirtu</i>	(As part of finishing procedures?)

**Table 1:** Neo-Assyrian garment designations and textile techniques.

the Assyrian state sector probably determined the reduction in the number of Hurrian terms in the written form of the Neo-Assyrian dialect. This may be surmised in light of the greater number of Hurrianisms in the Middle Assyrian dialect. Moreover, both Assyrian and Babylonian were affected by Aramaic influence in the 1st millennium, as illustrated by the various loanwords present in these late dialects of Akkadian. The limits of the extant written evidence from Neo-Assyrian archives prevent us from reaching a full understanding of the impact of Aramaic in the Assyrian textile terminology, but it is possible that loanwords were also present in those sectors of the Neo-Assyrian textile vocabulary reflecting textile activities predominantly performed by Aramaic-speaking workers. These West Semitic immigrants probably brought their textile know-how and terminology into the Assyrian imperial culture.

The ‘new entries’ in the Akkadian textile terminology of the 1st millennium are not limited to the nomenclature of end products but also concern the materials used to fabricate garments, such as the precious material called *būšu*. In addition, toponymic cloth designations continued to be used also in the

Neo-Assyrian terminology and reflect the interests of the Assyrian ruling elite towards specific areas touched by the Empire’s military and commercial expansion. References to *kuzippus* from Hamath, *urnutus* from Byblos, and Phrygian reinforced undergarments attest to the increased demand for special varieties of clothes for the needs of the palace sector and the royal army in 1st-millennium Assyria, two important factors for the development of the textile trade and production in the Empire’s economy. Renowned textiles from the Levant were imported in Assyria<sup>624</sup> and, thanks to the vast trade network of the Empire, became an important part of the urban elites’ wardrobes. Perhaps, these exotic textiles also contributed to the spread of ‘royal fashions’ in various Near Eastern areas. The strengthening of trade contacts with Anatolia in the Sargonid Age in the field of imported textiles is also confirmed by a Sennacherib’s letter mentioning wool from the land of Kummuh, corresponding to Classical Commagene.<sup>625</sup>

Another important point concerns the legacy of the textile terminology of the language (or languages) spoken in the Assyrian Empire. After the collapse of the first world empire (612 BC), the Akkadian dialect

624. The import of linen and multi-coloured garments from the Levant, a well-known *topos* in descriptions of booty of Neo-Assyrian royal inscriptions, is also present in the Old Testament. See, e.g., Ezekiel’s description of choice fabrics, textiles with multi-coloured trim and fine linen as characteristic goods produced in Tyre and Aram and exchanged with foreign merchants. See Ezek. 27:16, 22, 23.

625. SAA 1, 33:19-r.3.



used by the Assyrians disappeared from the written documentation. However, it is reasonable to assume that Neo-Assyrian textile terms continued to be used by the Assyro-Aramaic population under the Chaldean dominion of Mesopotamia as well even though Aramaic progressively became the most diffused spoken language for large social strata of Assyrian society in post-Assyrian times. In addition, many 1st-millennium terms, some of which are of Aramaic origin, continued to be used in the Neo- and Late Babylonian dialects, as evidenced by the use of *gammīdatus*, *gulēnus*, and *qirmus* in Babylonia even during the Hellenistic period.<sup>626</sup> As far as the nomenclature of garments is concerned, we may observe that borrowings from the Assyrian dialect in Babylonian are very rare. A typical Neo-Assyrian term entering the Neo-Babylonian textile vocabulary is the word *šipirtu*, which appears in the domestic textile terminology of Babylonia in the Hellenistic period as a qualification limited to furniture.<sup>627</sup>

Former and recent Neo-Assyrian studies have elucidated a number of grammatical and lexical elements of the language spoken by the Assyrians in the 1st millennium BC. Various sectors of the Assyrian vocabulary of material culture remain unexplored however. It is hoped that this study, as well as contributions by other colleagues concerning Middle and Neo-Assyrian textiles that have appeared in recent years,<sup>628</sup> mark another step toward understanding the Assyrian *realia*. Further studies on the Neo- and Late Babylonian textile vocabulary will certainly complete our knowledge of 1st-millennium Akkadian terminology of garments and their parts, thereby contributing to a more in-depth understanding of the Assyrian legacy (or its absence) in the textile vocabulary of the late centuries of the cuneiform world in the Land of the Two Rivers. The memory of the luxury clothes that characterised the imperial *dolce vita* of the Assyrian elite and of the importance of textile production for court life in Nineveh seems in any case to have reached the Classical world. This may be recognised, for instance, in Diodorus' disparaging depiction

of King Sardanapalus, who is described as wearing a female robe and as being primarily occupied in dealing with purple garments and wool.<sup>629</sup>

### Acknowledgments

I wish to thank Marie-Louise Nosch and Cécile Michel for fruitful discussions on different aspects about textile production and terminology in the framework of the research activities of the Marie Curie Intra-European Fellowship Programme (2013-2015) and of the French-Danish scholarly cooperation (Research Programmes *TexOrMed* 2012-2014 and *ATOM* 2015-2018).

### Abbreviations

- ADW = A. Y. Ahmad & J. N. Postgate, *Archives from the Domestic Wing of the North-West Palace at Kalhu/Nimrud*. Edubba 10. London 2007.
- AEAD = S. Parpola & R. M. Whiting, *Assyrian-English-Assyrian Dictionary*, Helsinki-Winona Lake 2007.
- AHw = W. von Soden, *Akkadisches Handwörterbuch*, I-III. Wiesbaden 1958-81.
- BWL = W. G. Lambert, *Babylonian Wisdom Literature*. Oxford 1960 (Reprint 1996).
- CAD = *The Assyrian Dictionary of the Oriental Institute of the University of Chicago*. Chicago 1956-2010.
- CDA = J. Black, A. George & N. Postgate, *A Concise Dictionary of Akkadian*. SANTAG: Arbeiten und Untersuchungen zur Keilschriftkunde 5. Wiesbaden 2000 (Second corrected printing).
- CTN 2 = J. N. Postgate, *The Governor's Palace Archive*. Cuneiform Texts from Nimrud 2. London 1973.
- CTN 3 = S. Dalley & J. N. Postgate, *The Tablets from Fort Shalmaneser*. Cuneiform Texts from Nimrud 3. London 1984.
- DJBA = M. Sokoloff, *A Dictionary of Jewish Babylonian Aramaic*. Dictionaries of Talmud, Midrash and Targum 3. Ramat-Gan 2002.
- DJPA = M. Sokoloff, *A Dictionary of Jewish Palestinian Aramaic of the Byzantine Period*. Dictionaries of Talmud, Midrash and Targum 2. Ramat-Gan 2002 (Second edition).

626. See Joannès 2014, 459.

627. See Joannès 2014, 460.

628. See Villard 2010; Postgate 2001; Postgate 2014.

629. Diodorus of Sicily, *Library of History*, II.23, 1. The Greek author also mentions the rich wardrobe of this king, see *ibidem* II.27, 2.

- DNWSI = J. Hoftijzer & K. Jongeling, *Dictionary of the North-West Semitic Inscriptions*, I-II. Handbuch der Orientalistik 21. Leiden 1995.
- KAJ = E. Ebeling, *Keilschrifttexte aus Assur juristischen Inhalts*. Wissenschaftliche Veröffentlichung der Deutschen Orient-Gesellschaft 50. Leipzig 1927.
- KAN 1 = L. Jakob-Rost & F. M. Fales, *Neuassyrische Rechtsurkunden*, I. Wissenschaftliche Veröffentlichungen der Deutschen Orient-Gesellschaft 94. Berlin 1996.
- KAN 2 = L. Jakob-Rost, K. Radner, & V. Donbaz, *Neuassyrische Rechtsurkunden*, II. Wissenschaftliche Veröffentlichungen der Deutschen Orient-Gesellschaft 98. Saarbrücken 2000.
- KAR = E. Ebeling, *Keilschrifttexte aus Assur religiösen Inhalts*, I-II. Wissenschaftliche Veröffentlichungen der Deutschen Orient-Gesellschaft 28/34. Leipzig 1919/22.
- KAV = O. Schroeder, *Keilschrifttexte aus Assur verschiedenen Inhalts*. Wissenschaftliche Veröffentlichungen der Deutschen Orient-Gesellschaft 35. Leipzig 1920.
- LAS = S. Parpola, *Letters from Assyrian Scholars to the Kings Esarhaddon and Assurbanipal. Part I: Texts*. Alter Orient und Altes Testament 5/1. Neukirchen-Vluyn 1970.
- LS = K. Brockelmann, *Lexicon syriacum*. Halle 1928.
- MARV = H. Freydank *et al.*, *Mittelassyrische Rechtsurkunden und Verwaltungstexte*, I-X. Berlin/Saarbrücken/Saarwellingen/Wiesbaden 1976-2011.
- NATAPA 1 = F. M. Fales & L. Jakob-Rost, Neo-Assyrian Texts from Assur. Private Archives in the Vorderasiatisches Museum of Berlin, Part I, *State Archives of Assyria Bulletin* 5 (1991).
- NATAPA 2 = K. Deller, F. M. Fales & L. Jakob-Rost, Neo-Assyrian Texts from Assur. Private Archives in the Vorderasiatisches Museum of Berlin, Part II, *State Archives of Assyria Bulletin* 9 (1995).
- ND = *siglum* of the texts from Nimrud (Kalhu).
- PNA 1/II = K. Radner (ed.), *The Prosopography of the Neo-Assyrian Empire, Volume 1, Part II: B-G*, Helsinki 1999.
- PVA = B. Landsberger & O. R. Gurney, The Practical Vocabulary of Assur, *Archiv für Orientforschung* 18 (1957-58), 328-341.
- RINAP 1 = H. Tadmor & Sh. Yamada, *The Royal Inscriptions of Tiglath-pileser III (744-727 BC) and Shalmaneser V (726-722 BC), Kings of Assyria*. The Royal Inscriptions of the Neo-Assyrian Period 1. Winona Lake 2011.
- RINAP 3/2 = A. K. Grayson & J. R. Novotny, *The Royal Inscriptions of Sennacherib, King of Assyria (704-681 BC), Part 2*. The Royal Inscriptions of the Neo-Assyrian Period 3/2. Winona Lake 2014.
- RINAP 4 = E. Leichty, *The Royal Inscriptions of Esarhaddon, King of Assyria (680-669 BC)*. The Royal Inscriptions of the Neo-Assyrian Period 4. Winona Lake 2011.
- SAA = State Archives of Assyria, 1-19. Helsinki 1987-.
- StAT 1 = K. Radner, *Ein neuassyrisches Privatarchiv der Tempelgoldschmiede von Assur*. Studien zu den Assur-Texten 1. Saarbrücken 1999.
- StAT 2 = V. Donbaz & S. Parpola, *Neo-Assyrian Legal Texts in Istanbul*. Studien zu den Assur-Texten 2. Saarbrücken 2001.
- StAT 3 = B. Faist, *Alltagstexte aus neuassyrischen Archiven und Bibliotheken der Stadt Assur*. Studien zu den Assur-Texten 3. Wiesbaden 2007.
- StAT 5 = D. Prechel & H. Freydank, *Urkunden der königlichen Palastverwalter vom Ende des 2. Jt. v. Chr. Das „Archiv“ Assur 21101 (M7 F)*. Studien zu den Assur-Texten 5. Wiesbaden 2014.
- TCAE = J. N. Postgate, *Taxation and Conscription in the Assyrian Empire*. Studia Pohl: Series Maior 3. Roma 1974.
- TH = J. Friedrich *et al.*, *Die Inschriften vom Tell Halaf. Keilschrifttexte und aramäische Urkunden aus einer assyrischen Provinzhauptstadt*. Archiv für Orientforschung, Beiheft 6. Berlin 1940 (Reprint 1967).
- VAT = *siglum* of the texts in the collections of the Vorderasiatisches Museum in Berlin.
- ZTT I = *siglum* of the texts nos. 1-28 from Ziyaret Tepe (Tušhan), for which see Parpola 2008.
- ZTT II = *siglum* of the texts nos. 29-36 from Ziyaret Tepe (Tušhan), for which see MacGinnis & Willis Monroe 2013-2014.

## Bibliography

- Abraham, K. & M. Sokoloff (2011) Aramaic Loanwords in Akkadian – A Reassessment of the Proposal, *Archiv für Orientforschung* 52, 22-76.
- Albenda, P. (2005) *Ornamental Wall Painting in the Art of the Assyrian Empire*. Cuneiform Monographs 28. Leiden-Boston.
- Andersson Strand, E. (2010) The Basic of Textile Tools and Textile Technology: From Fibre to Fabric. In C. Michel & M.-L. Nosch (eds.), *Textile Terminologies in the Ancient Near East and Mediterranean from the Third to the First Millennia BC*, 10-22. Ancient Textiles Series 8. Oxford.
- Andersson Strand, E. (2015) The Basic of Textile Tools and Textile Technology – From Fibre to Fabric. In

- Andersson Strand, E. & M.-L. Nosch (eds.) *Tools, Textiles and Contexts. Textile Production in the Aegean and Eastern Mediterranean Bronze Age*, 40-60. Ancient Textiles Series 21. Oxford-Philadelphia.
- Barber, E. J. W. (1991) *Prehistoric Textiles. The Development of Cloth in the Neolithic and Bronze Ages with Special Reference to the Aegean*. Princeton-Oxford (Third printing of 1940 edition).
- Barnett, R. D. (1976) *Sculptures from the North Palace of Ashurbanipal at Nineveh (668-627 BC)*. London.
- Beaugéard, A.-C. (2010) Les textiles du Moyen-Euphrate à l'époque paléo-babylonienne d'après un ouvrage récent. In C. Michel & M.-L. Nosch (eds.), *Textile Terminologies in the Ancient Near East and Mediterranean from the Third to the First Millennia BC*, 283-289. Ancient Textiles Series 8. Oxford.
- Beaulieu, P.-A. (1989) Textes administratifs inédits d'époque hellénistique provenant des archives du Bīt Rēš, *Revue d'assyriologie et d'archéologie orientale* 83, 53-80.
- Beaulieu, P.-A. (2003) *The Pantheon of Uruk During the Neo-Babylonian Period*. Cuneiform Monographs 23. Leiden-Boston.
- Botta, P. E. & E. Flandin (1849-50) *Monuments de Ninive, découvert et décrit par M. P. E. Botta, mesuré et dessiné par M. E. Flandin*, I-V. Paris.
- Bunnens, G. (1997) Til Barsip under Assyrian Domination: A Brief Account of the Melbourne University Excavations at Tell Ahmar. In S. Parpola & R. M. Whiting (eds.), *Assyria 1995. Proceedings of the 10<sup>th</sup> Anniversary of the Neo-Assyrian Text Corpus Project*, 17-28. Helsinki.
- Bunnens, G. (2012) Sealing Practices at Neo-Assyrian Til Barsip: Cylinders – Stamps – *Sissiktu* – Seal Box. In T. Boiy et al. (eds.), *The Ancient Near East, A Life! Festschrift Karel Van Lerberghe*, 75-89. Orientalia Lovaniensia Analecta 220. Leuven.
- Cancik-Kirschbaum, E. (1999) <sup>1a</sup>*sāpi 'u/sēpû*. Eine akkadische Berufszeichnung aus dem Bereich der Textilerstellung. In B. Böck, E. Cancik-Kirschbaum, & T. Richter (eds.), *Munuscula Mesopotamica. Festschrift für Johannes Renger*, 79-93. Alter Orient und Altes Testament 267. Münster.
- Cardon, D. (2007) *Natural Dyes. Sources, Tradition, Technology and Science*. London (English translation of *Le monde des teintures naturelles*. Paris 2003).
- Chantraine, P. (1968) *Dictionnaire étymologique de la langue grecque: histoire des mots*. Paris.
- Collon, D. (ed.) (2008) Nimrud Treasures: Panel Discussion. In J. E. Curtis et al. (eds.), *New Light on Nimrud. Proceedings of the Nimrud Conference, 11<sup>th</sup>-13<sup>th</sup> March 2002*, 105-118. London.
- Crowfoot, E. (1995) Textiles from Recent Excavations at Nimrud, *Iraq* 57, 113-118.
- Curtis, J. & A. Green (1997) *Excavations at Khirbet Khartuniyeh*. Saddam Dam Report 11. London.
- Dalley, S. (1980) Old Babylonian Dowries, *Iraq* 42, 53-74.
- Del Olmo Lete, G. & J. Sanmartín (1996) *Diccionario de la lengua ugarítica*, I-II. Aula Orientalis Supplementa 7. Sabadell-Barcelona.
- Dietrich, M. (2003) *The Babylonian Correspondence of Sargon and Sennacherib*. State Archives of Assyria 17. Helsinki.
- Diodorus of Sicily *Library of History, Book II*, trans. C. H. Oldfather, vol. I. Cambridge 1946.
- Donbaz, V. (1991) The Date of the Eponym Nabû-bēla-ušur. In D. Charpin & F. Joannès (eds.), *Marchands, diplomats et empereurs. Études sur la civilisation mésopotamienne offertes à Paul Garelli*, 73-80. Paris.
- Drower, E. S. & R. Macuch (1963) *A Mandaic Dictionary*. Oxford.
- Durand, J.-M. (2009) *La nomenclature des habits et des textiles dans les textes de Mari*. Archives royales de Mari 30: Matériaux pour le Dictionnaire de Babylonien de Paris, I. Paris.
- Ebeling, E. (1931) *Tod und Leben nach den Vorstellungen der Babylonier*. Leipzig.
- Ebeling, E. (1952) *Parfümrezepte und kultische Texte aus Assur*. Roma.
- Ellis, R. S. (1976) Mesopotamian Crafts in Modern and Ancient Times: Ancient Near Eastern Weaving, *American Journal of Archaeology* 80, 76-77.
- Faist, B. (2001) *Der Fernhandel des assyrischen Reiches zwischen dem 14. und 11 Jh. v. Chr.* Alter Orient und Altes Testament 265. Münster.
- Faist, B. (2007) *Alltagstexte aus neuassyrischen Archiven und Bibliotheken der Stadt Assur*. Studien zu den Assur-Texten 3. Wiesbaden.
- Fales, F. M. (1983) *Cento lettere neo-assire, traslitterazione e traduzione, commento e note. Parte I: nn. 1-45*. Quaderni del Seminario di Iranistica, Uralo-Altaistica e Caucasologia dell'Università degli studi di Venezia 17. Venezia.
- Fales, F. M. & J. N. Postgate (1992) *Imperial Administrative Records, Part I: Palace and Temple Administration*. State Archives of Assyria 7. Helsinki.
- Fales, F. M. & J. N. Postgate (1995) *Imperial Administrative Records, Part II: Provincial and Military Administration*. State Archives of Assyria 11. Helsinki.
- Freydank, H. & C. Saporetti (1989) *Bābu-aha-iddina: Die Texte*. Corpus Medio-Assiro 2. Roma.

- Gaspa, S. (2013) Textile Production and Consumption in the Neo-Assyrian Empire. In E. Andersson Strand, H. Koefoed & M.-L. Nosch (eds.), *Textile Production and Consumption in the Ancient Near East: Archaeology, Epigraphy, Iconography*, 224-247. Ancient Textiles Series 12. Oxford.
- Groneberg, B. (1980) *Die Orts- und Gewässernamen der altbabylonischen Zeit*. Répertoire Géographique des Textes Cunéiformes 3. Wiesbaden.
- Guralnick, E. (2004) Neo-Assyrian Patterned Fabrics, *Iraq* 66, 221-232.
- Hallo, W. W. & K. L. Younger (eds.) (2000) *The Context of Scripture, vol. II: Monumental Inscriptions from the Biblical World*. Leiden-Boston-Köln.
- Hämeen-Anttila, J. (2000) *A Sketch of Neo-Assyrian Grammar*. State Archives of Assyria Studies 13. Helsinki.
- Hecker, K. et al. (1998) *Kappadokische Keilschrifttafeln aus den Sammlungen der Karlsuniversität Prag*. Praha.
- Herodotus *Historiae, Books I-II*, transl. A. D. Godley. London 1920 (Reprint 1999).
- Herodotus *Historiae, Books V-VII*, transl. A. D. Godley. London 1922 (Reprint 1998).
- Ismail, B. Kh. & J. N. Postgate (2008) A Middle Assyrian Flock-Master's Archive from Tell Ali, *Iraq* 70, 147-178.
- Jakob, S. (2003) *Mittelassyrische Verwaltung und Sozialstruktur*. Cuneiform Monographs 23. Leiden-Boston.
- Jastrow, M. (1950) *Dictionary of the Targumim, Talmud Babli, Yerushalmi and Midrashic Literature*. London-New York.
- Joannès, F. (2010) Textile Terminology in the Neo-Babylonian Documentation. In C. Michel & M.-L. Nosch (eds.), *Textile Terminologies in the Ancient Near East and Mediterranean from the Third to the First Millennium BC*, 401-408. Ancient Textiles Series 8. Oxford.
- Joannès, F. (2014) Fabrics and Clothes from Mesopotamia During the Achaemenid and Seleucid Periods: The Textual References. In C. Breniquet & C. Michel (eds.), *Wool Economy in the Ancient Near East and the Aegean. From the Beginnings of Sheep Husbandry to Institutional Textile Industry*, 452-463. Ancient Textiles Series 17. Oxford-Philadelphia.
- Kaufman, S. A. (1974) *The Akkadian Influences on Aramaic*. Assyriological Studies 19. Chicago.
- Kwasman, Th. (2009) A Neo-Assyrian Royal Funerary Text. In M. Luukko, S. Svärd, & R. Mattila (eds.), *Of God(s), Trees, Kings, and Scholars. Neo-Assyrian and Related Studies in Honour of Simo Parpola*, 111-125. Studia Orientalia 106. Helsinki.
- Layard, A. H. (1849-53) *The Monuments of Nineveh, I-II*. London.
- Lipiński, E. (1997) *Semitic Languages – Outline of a Comparative Grammar*. Orientalia Lovaniensia Analecta 80. Leuven.
- Lipiński, E. (2000) *The Aramaeans: Their Ancient History, Culture, Religion*. Orientalia Lovaniensia Analecta 100. Leuven.
- Luukko, M. & G. Van Buylaere (2002) *The Political Correspondence of Esarhaddon*. State Archives of Assyria 16. Helsinki.
- MacGinnis, J. & M. Willis Monroe (2013-2014) Recent Texts from Ziyaret Tepe, *State Archives of Assyria Bulletin* 20, 47-56.
- Mankowski, S. J. (2000) *Akkadian Loanwords in Biblical Hebrew*. Harvard Semitic Studies 47. Winona Lake.
- Menzel, B. (1981) *Assyrische Tempel, I-II*. Studia Pohl: Series Maior 10. Roma.
- Michel, C. & K. R. Veenhof (2010) The Textiles Traded by the Assyrians in Anatolia (19<sup>th</sup>-18<sup>th</sup> Centuries BC). In C. Michel & M.-L. Nosch (eds.), *Textile Terminologies in the Ancient Near East and Mediterranean from the Third to the First Millennium BC*, 210-271. Ancient Textiles Series 8. Oxford.
- Müller, K. F. (1937) *Das assyrische Ritual, Teil I: Texte zum assyrischen Königsritual*. Mitteilungen der Vorderasiatisch-Aegyptischen Gesellschaft 41/3. Leipzig.
- Muscarella, O. W., A. Caubet & F. Tallon (1992) Achaemenid Brick Decoration. In P. O. Harper, J. Aruz & F. Tallon (eds.), *The Royal City of Susa. Ancient Near Eastern Treasures in the Louvre*, 215-241. New York.
- Parpola, S. (1987) *The Correspondence of Sargon II, Part I: Letters from Assyria and the West*. State Archives of Assyria 1. Helsinki.
- Parpola, S. (2008) Cuneiform Texts from Ziyaret Tepe (Tušhan), 2002-2003, *State Archives of Assyria Bulletin* 17, 1-113.
- Pasquali, J. (2010) Les noms sémitiques des tissus dans les textes d'Ebla. In C. Michel & M.-L. Nosch (eds.), *Textile Terminologies in the Ancient Near East and Mediterranean from the Third to the First Millennium BC*, 173-185. Ancient Textiles Series 8. Oxford.
- Peyronel, L. (2004) *Gli strumenti di tessitura dall'Età del Bronzo all'Epoca persiana*. Materiali e studi archeologici di Ebla 4. Roma.
- Porten, B. & A. Yardeni (1986) *Textbook of Aramaic Documents from Ancient Egypt*. Winona Lake.
- Postgate, J. N. (1973) *The Governor's Palace Archive*. Cuneiform Texts from Nimrud 2. London.
- Postgate, J. N. (1979) Assyrian Documents in the Musée d'Art et d'Histoire, Geneva, *Assur* 2/iv, 1-15.
- Postgate, J. N. (1988) *The Archive of Urad-Šerūa and His Family. A Middle Assyrian Household in Government*

- Service*. Corpus Medio Assiro I. Roma.
- Postgate, J. N. (2000) Assyrian Felt. In P. Negri Scafa & P. Gentili (eds.), *Donum natalicium: Studi in onore di Claudio Saporetti in occasione del suo 60° compleanno*, 213-217. Roma.
- Postgate, J. N. (2001) Assyrian Uniforms. In W. H. van Soldt *et al.* (eds.), *Veenhof Anniversary Volume. Studies Presented to Klaas R. Veenhof on the Occasion of His Sixty-Fifth Birthday*, 373-388. Publications de l'Institut historique-archéologique néerlandais de Stamboul 89. Leiden.
- Postgate, J. N. (2014) Wool, Hair and Textiles in Assyria. In C. Breniquet & C. Michel (eds.), *Wool Economy in the Ancient Near East and the Aegean. From the Beginnings of Sheep Husbandry to Institutional Textile Industry*, 399-426. Ancient Textiles Series 17. Oxford-Philadelphia.
- Postgate, J. N & D. Collon (1999-2001) More Stray Assur Tablets, *State Archives of Assyria Bulletin* 13, 1-16.
- Quillien, L. (2013) Tûg-LUM-LUM = tûg-guz-guz; a new interpretation of the 'guzguzu' garment in first millennium BC Mesopotamia, *Nouvelles assyriologiques brèves et utilitaires* 2013/2014, 21-25.
- Quillien, L. (2014) Flax and Linen in the First Millennium BC Babylonia: The Origins, Craft Industry and Uses of a Remarkable Textile. In M. Harlow, C. Michel, & M.-L. Nosch (eds.), *Prehistoric, Ancient Near Eastern and Aegean Textiles and Dress: An Interdisciplinary Anthology*, 271-296. Ancient Textiles Series 18. Oxford-Philadelphia.
- Radner, K. (1999) *Ein neuassyrisches Privatsarchiv der Tempelgoldschmiede von Aššur*. Studien zu den Assur-Texten I. Saarbrücken.
- Radner, K. (2004) *Das mittelassyrische Tontafelarchiv von Giricano/Dunnu-ša-Uzibi*. Subartu 14. Turnhout.
- Reade, J. (2012) Visual Evidence for the Status and Activities of Assyrian Scribes. In G. B. Lanfranchi *et al.* (eds.), *Leggo! Studies Presented to Frederick Mario Fales on the Occasion of His 65<sup>th</sup> Birthday*, 699-717. Leipziger Altorientalische Studien 2. Wiesbaden.
- Reynolds, F. (2003) *The Babylonian Correspondence of Esarhaddon and Letters to Assurbanipal and Šîn-šarru-iškun from Northern and Central Babylonia*. State Archives of Assyria 18. Helsinki.
- Röllig, W. (2002) Aus der Kleiderkammer einer mittelassyrischen Palastverwaltung *mašhuru*-Kleider. In O. Loretz, K. A. Metzler & H. Schaudig (eds.), *Ex Mesopotamia et Syria Lux. Festschrift für Manfred Dietrich*, 581-594. Alter Orient und Altes Testament 281. Münster.
- Roth, M. (1989) *Babylonian Marriage Agreements 7th-3rd Centuries BC*. Alter Oriens und Altes Testament 222. Neukirchen-Vluyn.
- Roth, M. (1989-90) The Material Composition of the Neo-Babylonian Dowry, *Archiv für Orientforschung* 36/37, 1-55.
- von Soden, W. (1966) Aramäische Wörter in neuassyrischen und neu- und spätbabylonischen Texten. Ein Vorbericht. I (*agâ* - \**mūš*), *Orientalia Nova Series* 35, 1-20.
- von Soden, W. (1977) Aramäische Wörter in neuassyrischen und neu- und spätbabylonischen Texten. Ein Vorbericht. III, *Orientalia Nova Series* 46, 183-197.
- von Soden, W. (1995) *Grundriss der akkadischen Grammatik*. Analecta Orientalia 35. Roma.
- Sokoloff, M. (2009) *A Syriac Lexicon. A Translation from the Latin, Correction, Expansion, and Update of C. Brockelmann's Lexicon Syriacum*. Winona Lake-Piscataway.
- Staubli, Th. (2012) *Kleider in biblischer Zeit*. Freiburg.
- Vallat, F. (1993) *Les noms géographiques des sources suso-élamites*. Répertoire Géographique des Textes Cunéiformes 11. Wiesbaden.
- Villard, P. (2010) Les textiles néo-assyriens et leur couleurs. In C. Michel & M.-L. Nosch (eds.), *Textile Terminologies in the Ancient Near East and Mediterranean from the Third to the First Millennia BC*, 388-399. Ancient Textiles Series 8. Oxford.
- Vita, J.-P. (2010) Textile Terminology in the Ugaritic Texts. In C. Michel & M.-L. Nosch (eds.), *Textile Terminologies in the Ancient Near East and Mediterranean from the Third to the First Millennia BC*, 323-337. Ancient Textiles Series 8. Oxford.
- Völling, E. (2008) *Textiltechnik im Alten Orient. Rohstoffe und Herstellung*. Würzburg.
- Watson, W. G. E. (2007) *Lexical Studies in Ugaritic*. Sabadell-Barcelona.
- Wegner, I. (2000) *Hurritisch: Eine Einführung*. Wiesbaden.
- Weidner, E. F. (1954-56) Hof- und Harems-Erlasse assyrischer Könige aus den 2. Jahrtausend v. Chr., *Archiv für Orientforschung* 17, 257-293.
- Zadok, R. (1985) *Geographical Names According to New- and Late-Babylonian Texts*. Répertoire Géographique des Textes Cunéiformes 8. Wiesbaden.
- Zawadzki, S. (2013) *Garments of the Gods, vol. 2: Texts*. Orbis Biblicus et Orientalis 260. Fribourg-Göttingen.

# 4

## Tools and Crafts, the Terminology of Textile Manufacturing in 1st-Millennium BC Babylonia

Louise Quillien

What did sheep shears in the 1<sup>st</sup> millennium BC Babylonia look like? We are not sure. Many cuneiform texts were written about textile work in Babylonia, but it was largely about administration or accounting. There were hardly any descriptions of the actual tools and processes. In this article we go back over the words, the iconography, and the archaeology in an attempt to find these missing descriptions. This study is limited to Babylonia during the 1st millennium BC, and this period correspond to a state of the Akkadian language, called Neo-Babylonian. At these times, major evolution took place. Mesopotamia entered in the Iron Age at the end of the 2<sup>nd</sup> millennium BC. Empires were built (Neo-Assyrian 911-610 BC, Neo-Babylonian 610-539 BC, Achaemenid 539-330 and Hellenistic 330-64 BC). Most of the cuneiform documentation of that period discovered by the archaeological excavations is dated from the “long 6th century BC”.<sup>2</sup> At these times, Babylonia enjoyed an economic growth, long-distance trade developed, and the temples has an important economic weight.<sup>3</sup> All these factors induce

changes in the textile craft that are visible through an analysis of the vocabulary.

Textile tools were objects of everyday life, they were handled manually to transform the raw materials into finished woven products. They included all the implements used at different stages of fibre preparation, spinning, and weaving, as well as dyeing, washing, decorating and the repair of fabrics. An approach that combines the study of vocabulary of tools with the study of action verbs related to textile manufacturing can bring information about the techniques known in 1<sup>st</sup> millennium BC.

In Babylonia, during the 1<sup>st</sup> millennium BC, the textile craft was well-developed. Textiles were widely used in transportation, in home furnishing as well as for clothing. Common domestic production and luxury production both existed with the former being much less documented than the latter. Luxury production was organized by the temples, and probably also by the palaces.<sup>4</sup> Wool was the most commonly used raw material.<sup>5</sup> Flax was rare but present, and cotton appeared at these times in Babylonia.<sup>6</sup> Special

1. I deeply thank Elizabeth Payne and Michael Jursa for sharing with me transliterations of unpublished texts from the Yale Babylonian Collection, and Walter Farber for providing permission to reproduce the image of the amulets of the Lamaštu. I also warmly thank Marie-Louise Nosch, Cécile Michel, Salvatore Gaspa, Ariel Rosenblum and Arch Naylor for their help in improving my paper. Responsibility for any errors lies with me.

2. Jursa 2010, 7. A synthesis of the Neo-Babylonian cuneiform documentation can be found in Jursa 2005.

3. See Jursa 2010 for the evolution of the economy of Mesopotamia in 1<sup>st</sup> millennium BC.

4. About the use of textiles in the temples during the Neo-Babylonian period see Zawadzki 2006 and 2013; Beaulieu 2003. The Neo-Babylonian and Achaemenid textile production in the palaces is poorly documented, but if we compare with the situation in Mari or in the Neo-Assyrian period, one can hypothesis that the Babylonian palaces were important centres of a luxury textile production.

5. The volume of Breniquet & Michel 2014 has demonstrated the importance of wool in Mesopotamia’s economy since the 4<sup>th</sup> millennium BC.

6. About flax, see Quillien 2014 and about cotton, see Zawadzki 2006, 25-29 and Muthukumaran 2016, 98-105.

products like Egyptian flax, purple wool or special dyes, especially destined for luxury production, were imported through long distance trade.<sup>7</sup> Manufacturing techniques were complex: the luxury textiles were adorned with metal appliqué, tassels, and embroidery.<sup>8</sup> The vocabulary of tools and action verbs dealing with textile production gives some information about the different tasks accomplished by the textile craftsmen, and about the techniques they mastered.

Important works about textile tools in Mesopotamia include the book by Catherine Breniquet *Essai sur le tissage en Mesopotamie* and the articles by Eva Andersson Strand, Agnete Wisti Lassen, and Caroline Sauvage.<sup>9</sup> Using the context of these previous works supported by the Neo-Babylonian documentation, the question is how studying tool terminology and action verbs can improve our understanding of the function of the textile production in 1<sup>st</sup>-millennium BC Mesopotamia. Does textile terminology reveal evolutions at this late period of Mesopotamian history?

### The sources

The cuneiform sources from Babylonia dealing with textiles and dated from the 1<sup>st</sup> millennium BC mostly comes from the temples of Uruk and Sippar. They are administrative documents, written by scribes whose purpose was to organize and control the production of the textiles made especially for the clothing of gods' statues and for the cult. In the temples, the garments of deities were regularly renewed, and the statues' attires were changed several times a year during ceremonies called *lubuštu* (dressing).<sup>10</sup> This regular need for clean or new items was an important factor for the growing production of luxury textiles in the Neo-Babylonian temples.

The texts from Babylonian temple archives dealing with textile production mostly date to the "long 6th century BC". They record materials given to craftsmen by the temple's administration to perform

specific tasks (to spin, to weave, to decorate, to dye, to wash, to repair) and finished products delivered to the temples by craftsmen. These texts were written by temple scribes to control the quality and quantity of textiles made by the craftsmen and to managed their work.<sup>11</sup> However, these texts do not describe specifics of workers tasks, and most of the time craftsmen used their own tools. What was common was not written down, for instance the clay tools like loom weights were not recorded in the texts. Therefore, with the exception of some metal objects, the descriptive vocabulary of textile tools themselves remains scarce throughout these cuneiform tablets. The action verbs of textile work are more frequent because texts sometimes mention which task has to be performed by the craftsmen with the material given to them. These verbs reveal some of the stages of the *chaîne opératoire* and show the specialisation of the craftsmen in one or several tasks. This temple administrative documentation is complemented by some ritual texts and lexical lists where the terminology of textile tools is mentioned. Private archives of rich urban families sometimes mention textile work, for instance in letters. They come from a greater number of cities: Uruk, Sippar, Babylon, Ur, Nippur, Borsippa. Although the textual records are the primary sources that elucidate the meaning of this vocabulary, sometimes it is possible to compare these terms with the iconographical representations and with the archaeological remains.

### From fibre to thread

#### *The collection of the fibres*

Cuneiform texts do not describe the processes of preparing fibres for spinning. Indeed, these steps were very commonly performed and there was no need to put them down in writing. Only shearing is well documented in texts dealing with the managing of the

7. Graslin 2009, Quillien 2015.

8. These different techniques can be seen, for the Neo-Assyrian period, on the palaces' bas-reliefs and the paintings. We will see that they were also known by Neo-Babylonian craftsmen.

9. Breniquet 2008; Andersson 2010; Wisti Lassen 2010; Sauvage 2015.

10. About the *lubuštu* ceremony and the garments of the gods see Matsushima 1994 and 1998, Beaulieu 2003, Zawadzki 2006.

11. Zawadzki 2006 explains in detail this organization for the temple of Sippar.

temples' large flocks.<sup>12</sup> The tool used for shearing is named *sirpu* in Akkadian. The *Chicago Assyrian Dictionary* (CAD) translates it as 'shears, scissors'.<sup>13</sup> We do not know if this tool had one or two blades. The date of appearance of shears with two blades linked together in a U-shape in Mesopotamia is not clear.<sup>14</sup> If it were a tool with one blade only, the translation 'knife' would be more appropriate. The following text from the Ebabbar temple of Sippar in the Neo-Babylonian period describes iron shears as weighing up to 163 grams, and made by a blacksmith.

“{1/2?} talent 8 minas of iron had been given to Sūqaiā, blacksmith, to make iron scissors for the shearing. Of that amount, Sūqaiā delivered to the Ebabbar 4 minas 15 shekels, weight of 13 shears, (and) 15 shekels, weight of three iron sickles, a total of 4.5 minas in full, month Dūzu, 18th day, 15th year, Nabonidus, king of Babylon.”<sup>15</sup>

As iron was an expensive metal, specific instructions were given to the blacksmiths working for the temples of Sippar to make the shears and then to entrust the tools to the shepherds or to professional shearers for the shearing season.<sup>16</sup> The workers had to give back

the tools after the completion of their tasks, probably at the end of the season.<sup>17</sup> Sometimes, the Ebabbar temple of Sippar did not have enough *sirpu* and had to borrow equipment from its dependant sanctuaries, for instance from the Bēl-šarbi temple at Bāš.<sup>18</sup>

The *sirpu* are also found in private archives, without indication of their use within a household. However, the terminology is ambiguous because the *sirpu* were also used by carpenters.<sup>19</sup> The *sirpu* found in the three texts Nbn 258, Camb 330 and Camb 331 which contain inventories of houses where beer was brewed.<sup>20</sup>

It is interesting that the word *sirpu* seems to appear in cuneiform documentation during the 1<sup>st</sup> millennium BC. This “new entry” in the Akkadian vocabulary of the 1<sup>st</sup> millennium BC supports the hypothesis that sheep were mostly sheared, and no longer plucked in this period.<sup>21</sup> Indeed, the genetic evolution of the continuous growth of sheep hair occurred around 1200 BC in Europe, whereas previously, the sheep moulted there every year.<sup>22</sup> If one supposes the same evolution in Mesopotamia, the shearing would be the most used technique at the end of the 2<sup>nd</sup> millennium BC. Furthermore, one can suppose that the development of iron technology in the end of the 2<sup>nd</sup> millennium BC results in the appearance of new, more efficient tools, like iron shears.

12. About sheep breeding in 1<sup>st</sup> millennium BC Babylonia, see van Driel 1993 and Kozuh 2014; on the wool economy in Mesopotamian society, see Breniquet & Michel 2014.

13. CAD S, 316; also AHW III, 1037, *serpu*, *serapu* ‘Schermesser’.

14. For instance, the comprehensive inventory of bronze tools in Mesopotamia compiled by Deshayes 1960 does not mention such scissors. Margueron 1995, 134 refers to the discovery of ‘scissors’ at Emar, a Syrian archaeological site of the 14<sup>th</sup> century BC, but he does not describe the object. According to Barber 1991, 29 the most ancient scissors were discovered in France (Iron Age), in Roman Egypt, and in Parthian Iran. According to Ryder 1993, 15, bronze knives can also be used for the sheep shearing, even if there is no evidence of it in Mesopotamia.

15. Nbn 867: “(1) ‘1/2?’ gú-un 8 ma-na an-bar šá a-na e-peš si-ra-pi an-bar šá gi-iz-zu a-na ‘su-‘qa-a-a’<sup>16</sup>simug an-bar si-nu ina lib-bi 4 ma-na 15 gín ki-lá (5) 13 si-ra-pi 15 gín ki-lá 3-ta níg-gál-la-a-tu<sub>4</sub> an-bar pap 4 ½ ma-na gam-ri ‘su-qa-a-a a-na e-babbar-ra it-ta-din iti šu u<sub>4</sub> 18-kam mu 15-kam (10) ‘dnā-i lugal e<sup>ki</sup>?”.

16. The specialists of the shearing were called (GCC I, 93, GCC I, 139 and GCC I, 183).

17. In the texts Nbn 867, Nbn 960, CT 55, 252 the use of iron shears “for the shearing” is mentioned. In the last text, the temple give to a man 40 iron shears in the 3<sup>rd</sup> month of the year, beginning of the shearing season at Sippar.

18. CT 55, 252.

19. CT 55, 445. In this context the word probably meant ‘chisel’.

20. Nbn 258, a dowry text; Camb 330 and Camb 331, two inventories of a cabaret from the Egibi archive, edited by Joannès 1992.

The *sirpu* might have been used during the process of beer preparation. The three texts indeed mention containers for the brewing.

21. Wisti-Lassen 2010, 276; Barber 1991, 29.

22. See Rast-Eicher 2012, 14-15. The data about this evolution are lacking for Middle East.



Evidence of this change in wool collection methods is supported by the textual sources. The verb ‘to shear’, *gazāzu*, becomes progressively very frequent in comparison to the verb ‘to pluck’, *baqāmu*.<sup>23</sup> Although the word *gazāzu* is attested from the 3<sup>rd</sup> millennium BC onwards, it was scarcely employed before the Nuzi period of the 15<sup>th</sup>–14<sup>th</sup> century BC, and the two methods were both used at Ugarit in the 14<sup>th</sup>–13<sup>th</sup> century BC.<sup>24</sup>

In the available 1<sup>st</sup> millennium documentation from Babylonia, the verb *baqāmu* (to pluck) is mentioned at least once, in the text CT 22, 214, a letter dated to the Neo-Babylonian period, “sheep *ša baqanu’u guzzu*”, “the sheep have been plucked and shorn.”<sup>25</sup> As the word *gazāzu* ‘to shear’ is preferred in the administrative document, this letter shows that in everyday life, outside the institutions, the plucking may have still continued to be in use, and that maybe not everybody had shears at their disposal.

In comparison to wool, the vocabulary for the collection and preparation of flax is not well attested in cuneiform texts. However, we know of its existence in earlier periods.<sup>26</sup> Archaeological excavations have shown tools such as sickles and combs used for the preparation of flax fibres for spinning in Mesopotamia, but they are older than our present period of study.<sup>27</sup>

### *The preparation of fibres for spinning*

All the steps of the preparation of wool for the spinning are not mentioned in the cuneiform texts. It is

possible to identify some terms dealing with this work in the Neo-Babylonian corpus.<sup>28</sup> The Akkadian term for the comb is *muštu*.<sup>29</sup> The term *muštu*, in Akkadian, is not mentioned in the Neo-Babylonian texts from the temples’ archive dealing with textile manufacturing, probably because it was a common object of low value. But the word does appear in 1<sup>st</sup> millennium rituals against the *Lamaštu*, a demon responsible for the death of new-born babies. To keep this evil female creature away from the house, the ritual issues instructions that she must be given, among other things, objects associated with textile work and/or toiletry: comb, distaff, spindle, oil, pin, needle.

“You give her a comb, a d[is]taff/spindle?, (and) a half-*sūtu* fla[sk] of oil” *Lamaštu Series I: 50*.<sup>30</sup>

“Accept from the woodworker a comb, a distaff/spindle?, and a needle for your sewing needs” The Incantation Thureau-Dan-gin RA 18, 163: rev. 21.<sup>31</sup>

From this text the comb (*muštu*) seems to be related to textile fibre preparation rather than to women’s toiletry. The oil can also be used for spinning, as well as for toiletry.<sup>32</sup> The word for distaff/spindle will be discussed later. These objects are found together in images of the *Lamaštu* presented below.<sup>33</sup> One also learns from the second text that these tools were made of wood, even the needles. The combing

23. The verb *gazāzu* is translated “to shear (sheep and goats)” according to CAD G, 59 and “scheren” according to the AHW II, 284. CAD B, 97 translates *baqāmu* (*baqāmu*) as “to pluck”, and the AHW I, 104 “ausraufen, scheren”. The word is attested since the 3<sup>rd</sup> millennium BC. In Hebrew two different words are also used for shearing and plucking, and the verb for shearing, Hebrew *gazaz* has the same root as the Akkadian *gazāzu*, according to Delcor 1955, 384-385.

24. At Nuzi, Abrahami 2014, 286, at Ugarit Vita 2016, 139-147. They may have used bronze tools.

25. CT 22, 214: 16–18 “<sup>id</sup>amar-utu-re-man-ni i-ta-mar-ru-šū-nu-ut šá ba-qa-nu-’u u ga-zu-’u””; “Marduk-rēmanni has inspected them (the sheep) which have been plucked or sheared”. Ebeling 1930 n°214.

26. See the Sumerian poem “The song of Utu to Inanna”, in Jacobsen 1987, 13-15.

27. Breniquet 2006, 167-173; Breniquet 2008, 103-107.

28. In the same way, Salvatore Gaspa has studied the Neo-Assyrian terminology of wool processing. See Gaspa 2013, 225–226.

29. The word *muštu*, equivalent of the Sumerian *giš-ga-ríg* and is translated, according to the CAD M/II, 290, ‘comb’. See also AHW III, 687, ‘Kamm’.

30. “*mulṭā pi[la]qqa šik[kat] šamni bitqu tanaddinš?*”, translation by Farber 2014, 150-151.

31. “*muhrī ša naggāri mulṭā pilaqqa u kirissa šimat qēki*”, Translation by Farber 2014, 298-299. As for the comb, the needle *kirissa* can be related to textile work (needle) but also to toiletry (hair clasp, pin) according to CAD K, 407. But here the term is specifically linked to spinning.

32. If the wool is dry one can add oil to make the fibres stick together during the spinning. (I thank Eva Andersson-Strand for this information). In the wool industry in 19<sup>th</sup> century Europe, the wool, before being carded or combed, and after being washed to remove impurities and fat, was soaked with some oil, to facilitate the spinning of a fine thread. See also Blanqui 1839, 159.

33. Götting 2009, 68-71.

of the wool is mentioned in cuneiform texts since the Ur III period.<sup>34</sup> In the 3<sup>rd</sup> millennium BC an ideogram had the shape of a comb.<sup>35</sup> Combs have been found in the archaeological remains in Mesopotamia but it is difficult to know the functions of these objects and to identify which ones were employed for textile work.<sup>36</sup>

The verbs *napāšu* and *mašādum*, translated ‘to comb wool’ by the *Chicago Assyrian Dictionary*, do not appear in the Neo-Babylonian texts.<sup>37</sup> It is not clear if carding, being the action of homogenizing fibres by brushing them loosely, was known in Mesopotamia, or if only combing was used. Carding sorts the long fibres from the short ones and makes the fibres lie parallel.<sup>38</sup> The two techniques do not produce the same quality of thread.

Several terms mean raw fibres at different stages of the preparation for spinning, in Neo-Babylonian. In the texts issued from temple archives, one finds the term ‘combed flax’ *gada ḫalši*.<sup>39</sup> The CAD gives

the following translation for *ḫalšu*: “(1) obtained by *ḫalāšu* (said of oil, etc.) (2) pressed out (said of sesame seeds) (3) combed (said of flax).”<sup>40</sup> The linen *ḫalšu* is given by the temple administration to the linen weavers or bleachers to make fabrics.<sup>41</sup> The wool also can be *ḫalši*, even if this word is more rare.<sup>42</sup> Another term, *ḫilšu* appears once in a text from Sippar to qualify wool. Even though it is translated “combed wool” by the CAD, it may refer, instead, to the *ḫilšu* ceremony.<sup>43</sup>

The word *pušikku* is another term translated as “combed wool” by the CAD.<sup>44</sup> It appears, for instance, in the following text:

“Wool issued, 8 talents (for) the female weavers, for *pušikku*-wool, the month Abu, 20th day, 7th year, king”, BRM 1, 7.<sup>45</sup>

But in another text where *pušikku*-wool is issued to a high official, Mac Ewan proposes the translation

34. Waetzoldt 1972, 115-119.

35. The ideogram ZATU 719, in shape of a comb, refers to the combing of the wool according to Charvát 2014, 81.

36. Breniquet 2006. Breniquet 2014, 66.

37. CAD N/I, 291 “1. To comb and clean wool, to pluck apart”, AHW III, 737 *napāšu* II “(Wolle) auszupfen”. CAD M/I, 351 “3. to comb hair, to comb wool”, but AHW III, 623 “schlagen, walken”.

38. Barber 1991, 29 and 261-262 explains that carding appeared late in History, probably in Medieval times. But according to Grömer, tools for carding have been discovered in the Hallstatt salt mines and date from 300 BC (Grömer 2016, 69-73). A Neo-Assyrian text seems to refer to carding at first sight but probably deals with the airing of the wool instead. This text is the prophecy for the crown prince Aššurbanipal, SAA 9, 7 e.14-r.1-2: “Secondly, let me tell you: I will finish the land of Gomer like (I finished) Elam. ... I will break the thorn, I will pluck the bramble into a tuft of wool, I will turn the wasps into a squash.” (“*mur-din-nu a-na ni-ip-ši a-nap-pa-āš*”). In the text quoted, the verb *napāšu* is used. It usually means the airing of the wool, before the combing, according to Michel, 2014, 239, and Michel 1998. Airing ‘opens’ the wool, removes the bulk of the impurities and facilitates the cleaning. The tool used is a *murdinnu* or *amurdinnu*, translated “bramble” by the authors of the CAD A II, 90. Maybe the image here is the removing of foreign bodies in the wool by airing it and plucking it apart, to make the wool smooth for the spinning.

39. *gada ḫalši*: UCP 9/I 68, GCCI 2, 381, NBC 8350.

40. CAD H, 50; AHW II, 313: “ausgekämmt, ausgepresst”. The verb *ḫalāšu* is translated as “(1) to press, squeeze out (2) to clean by combing,” but it is not attested for textile work in the 1<sup>st</sup> millennium BC, only for combing human hair, CAD H, 40; AHW II, 311 “auskämmen, auspressen”.

41. For instance, to make the linen curtain, according to the text UCP 9/I 68 from the Eanna archive of Uruk.

42. Zawadzki Garments II 546, “8 ma-na sig *ḫal-ši*” translated “8 minas of combed wool” by Stefan Zawadzki.

43. The term *ḫilšu* is mentioned in the text Zawadzki Garments II 462: “10 gín <sup>sig</sup>za-gin-[kur-ra] *šá ḫi-il-šu*”. Stefan Zawadzki translates this extract in the following way: “10 shekels of blue-pu[rple] wool for the *ḫilšu* ceremony” (Zawadzki 2013, 424). According to Bongenaar 1997, 267, the *ḫilšu* is a kind of perfume or incense, or the ceremony when this perfume/incense is used. The CAD H, 187 translate *ḫilšu* “A. a cleaning process performed on sesame seeds”, the only meaning attested for the 1<sup>st</sup> millennium BC and “C. combed wool”, in lexical lists where this term is linked to wool. The place named *bīt ḫilši* in the Neo-Babylonian temples of the Egišnugal at Ur, of the Eanna at Uruk and of the Esabad at Babylone are dedicated to the manufacturing of oils, ointments and other medicine. CAD H, 187-188, Joannès 2006.

44. CAD P, 541-542; AHW III, 883: “gekämmte Wolle”. This term appears also, once, in the Nuzi texts according to Abrahams 2014, 294 who choose the translation “combed wool”.

45. “(1) sig<sup>hi-a</sup> zi-ga mu-ni 8 gú-un mi-uš-bar-meš *a-na sig pu-sik-ki* iti-ne u<sub>4</sub>-20-kam (5) mu 7-kam <sup>na</sup>pap lugal”, BRM 1, 7. Reign of Nabû-nāšir (747-734 BC).

“wool ration.”<sup>46</sup> In a third text the *pušikku*-wool is used in a ritual with other precious raw materials including purple wool and red wool, two precious materials.<sup>47</sup> One can deduce from these two last texts that it was a high quality wool, probably carefully selected, by combing, or other process.

The word *šuppu* is translated “strip of carded wool,” in the CAD, thanks to linguistic arguments.<sup>48</sup> This translation is problematic, because the existence of the carding at these times is not proved, and because *šuppu* applies not only to wool, but also to flax. The word *šuppu* appears in several documents from the Neo-Babylonian temples’ archives,<sup>49</sup> always in the plural form (*šuppātu*), which indicates that it is a kind of raw material rather than a fabric. The *šuppu* can be counted or weighted whereas raw is just weighted.<sup>50</sup> In the texts from the temples’ archive, *šuppu* are never given to craftsmen to spin thread, they are sometimes dyed or even used directly made into belts, as in the following text.<sup>51</sup>

“Nine minas 25 shekels, weight of sashes — *šiprirtu* (made) of skeins of combed fibres (*šuppātu*), had been delivered by Rēhētu. The skeins of combed fibres (*šuppātu*) on the account of Bunene-šimāni [...] the month Simānu, 25th day, 4<sup>th</sup> year, Cambyses king of Babylon, king of Lands”, Camb 235.<sup>52</sup>

If the *šuppātu* are strips of combed or carded wool, as the proximity of the word with the Aramaic *šuppā* (carded wool) suggests, they are not destined to the spinning but used directly for the manufacturing of pieces of clothing or decoration. They were delivered by the craftsmen in important quantities (8.5 kg in the text Bertin 1884) and sometimes with the *išhunnu* which are woollen decorations.<sup>53</sup> Nevertheless, at Uruk the term *šuppu* was preceded by the determinative *gada* and Paul-Alain Beaulieu proposes the meaning ‘braided curtain’.<sup>54</sup> Indeed, the text PTS 2492 mentions 2 *šuppātu* for the door of a cella, as if they were curtains and not a raw material.<sup>55</sup> So the material and use of the *šuppu/šuppātu* may have differed within Babylonia according to the city considered.

### *The spinning*

As with fibre preparation, spinning is poorly documented in cuneiform documentation, even if it was a routine task for textile workers. However, at least one spinning tool is well attested in the cuneiform texts dated from the 1st millennium Babylonia: the spindle. The word for spindle, *pilakku* or *pilaqu*,<sup>56</sup> is attested in Akkadian texts since the Old Babylonian period. In Antiquity, spindles were made of various materials including wood, stone, and bone.<sup>57</sup> Assyrian

46. McEwan LB Tablets No. 48: 5

47. TuM 2-3, 250: 5-6 “<sup>sig</sup>ga-rik-ak-a <sup>sig</sup>za-gin <sup>sig</sup>hé-me-da”, among plants and vessels for a ritual.

48. CAD S, 249 “*šuppu* C”, translation suggested by the Talmudic *šuppā/šippā*; AHw III, 1112 *suppatu* II: “Lage gekämmte Wolle”; according to Abraham & Sokoloff 2011, 51, Talmudic *šuppā* mean “hatched wool”, and is an Aramaic ghost word. They doubt that the word *šuppātu* was a loanword from Aramaic. On the influence of Aramaic on the textile terminology, see Joannès 2010, 4 and 8, Abraham & Sokoloff 2011.

49. Nbk 286; Camb 235; Nbn 731; YOS 3, 117; YOS 21, 139; CT 55, 792; Bertin 1884.

50. Counted: Nbk 286, CT 55, 792; weighted: Camb 235, Nbn 731, Bertin 1884.

51. Dyed: Camb 235.

52. “(1) 9 ma-na 1/3 5 gin ki-lá *ši-pi-ri-e-tu*, *ša šu-up-pa-a-tu* <sup>11</sup>ri-<sup>12</sup>he-tú it-ta-din *šu-up-pa-tu*, ina [*muh-hi*(?) ...] (5) <sup>13</sup>saggár-šiman-ni [...] iti sig<sub>4</sub> u<sub>4</sub> 25-kam mu 4-kam <sup>14</sup>kam-bu-zi-ia lugal e<sup>ki</sup> lugal kur-kur” Camb 235. The *ši-pi-ri-e-tu* here probably does not mean *šiprētu*, “a dye” (CAD S, 204) but *šipirtu* (plural form), “a sash woven or threaded in a special technique” (CAD S, 201).

53. The first meaning of the term *išhunnu* is, according to the CAD I-J, 190, *išhunnatu* “cluster of grapes” and *išhunnu* “bunch of grapes” and the AHw I, 387 *išhunnatu(m)* “Weintraube”. The word can also mean a wool decoration, as the text Nbk 286: 1-5. attests: “14 ma-na *dul-lu gam-ru* ki-lá 10 <sup>16</sup>is-<sup>17</sup>hu-nu ù 3-ta <sup>18</sup>šu-up-pa-a-ta <sup>19</sup>dub-numun a-na é-babbar-ra it-ta-din”, “14 minas, complete work, weight of 10 *išhunnu* and 3 *šuppātu*, Šapīk-zēri (a weaver of coloured clothes) delivered to the Ebabbar”. See also Bertin 1884. It may be trimmings in the form of bunches of grapes.

54. Beaulieu 2003, 387.

55. PTS 2491: 4 “2-ta <sup>20</sup>ga<sup>21</sup>šu-up-pa-a-ta a-na ká pa-pa-hu”, “2 braided curtains *šuppātu* for the gate of the inner cella”. Beaulieu 2003, 283.

56. Sumerian giš-bal, CAD P, 371-373; AHw III, 863: “Stilett, Spindel”.

57. Andersson-Strand 2010, 12.

texts indicate that they were in wood.<sup>58</sup> Only one text from the Neo-Babylonian temple archives mentions this tool. These finds are rare in the documentation because the spindle was a very common object, and the temple archives listed primarily precious or rare materials, belonging to the temple, that the administration wanted to track. In the text CT 56, 454, silver was given by the temple's administration to a craftsman for making or buying a spindle, but the amount of money spent is lost in a break of the tablet.<sup>59</sup> But most of the time the craftsmen probably used their own spindle, and it is possible that this text may refer to religious objects rather than to real tools.

The word for spindle whorl, literally the head of the spindle *qaqqad pilakki* is not attested in the Neo-Babylonian texts. The distaff, a tool used in spinning to hold the unspun fibres, was not distinguished from the spindle in the vocabulary, according to the CAD, which occasionally translates *pilakku* by 'distaff'.<sup>60</sup> We know that spinning tasks were accomplished for the temples, because the craftsmen working for the sanctuaries received raw flax and wool and delivered threads and fabrics.<sup>61</sup> But the verbs to spin, *ṭamûm* and to ply, *eṣēpum* are not attested in the Neo-Babylonian documentation.<sup>62</sup> The absence of this vocabulary does not mean that these words were not employed; rather it indicates the purpose of the cuneiform documentation, which did not aim to describe in detail the technical work of craftsmen. Outside the temples, many people were surely spinning at home, but the domestic work was usually not recorded by writing.

The spindle has symbolic uses in Mesopotamia.



**Fig. 1.** Lamaštu amulet no. 14, Teheran, photo taken in 1982 by P. Calmeyer, 34x40 mm. (From Farber 2014, 5).

Archaeological remains from the 1<sup>st</sup> millennium BC provide an example of a distaff, made in onyx, a semi-precious stone, discovered in the palace of Babylon.<sup>63</sup> The spindle object is present in omen texts and rituals linked to femininity, to assist delivery, to avoid the death of a new-born baby.<sup>64</sup> Representations of

58. CT 54, 219: 5 “<sup>60</sup>pi-laq-qa ta-na-áš-ši-i-ma”, “you are carrying a wooden spindle”, in a broken text.

59. CT 56, 454 rev. 8. “[...]” gín kù-babbar šá a-na pi-la-qu a-na <sup>1</sup>du-tu-sig-<sup>5</sup>iq’ si-’nu’ [...] 40<sup>7</sup> 1/2 gín kù-babbar ina pi-la-ki”, “[...] shekels of silver that were given for a spindle, to Šamaš-udammiq [...] 40<sup>7</sup> 1/2 shekels of silver in the spindles?”, in a broken list of transactions from Sippar.

60. The CAD translates *pilakku* by distaff in the texts dealing with Lamaštu’s objects (examples quoted above), for instance CAD D, 170, col. 1, probably following the usual translations of these texts. But *pilakku* could mean the spindle in this context. Maybe the Akkadian word for the distaff is simply unknown to us. It is not necessary to use a distaff to spin.

61. For example, the administration gives to a team of craftsmen raw flax and asks in exchange thread and fabrics, Nbn 163; Nbn 164.

62. *ṭamûm*: CAD T, 45: “to spin, twist, braid, entwine”; AHW III, 1379: “gezwirnt”; *eṣēpum*: CAD E, 345: “to twine, to double, to multiply”; AHW I, 252: “verdoppeln”.

63. This object was also identified as a sceptre. Völling 1998, 102-104, has shown the parallel with the shape the distaff. See also Sauvage 2014.

64. Opp. Dream-book 332; SAA 10, 92; Lamaštu ritual, see Farber 2014. “The symbol of womanhood were the spindle and a specific pin (or thimble)”, according to Stol 1995, 124 quoting Sjöberg 1975, 224. In the hymn to the goddess Inanna edited by Sjöberg, the spindle and comb are part of the feminine paraphernalia “she may dress them in a clothing of a woman, she may place the speech of a woman in their mouth and give them a spindle and a hair clasp”. See also Cassin 1964, 293 for the meaning of the spindle in Mesopotamia and Baccelli *et al.* 2014, 117 about the spindle and femininity in Anatolia and neighbouring areas.

these tools can be found on the amulets against the Lamaštu-demon, as mentioned above.<sup>65</sup> In one iconographic representation, we can see a spindle, a comb and a third object in the form of a stick with double crochet, probably a distaff.

Another term, *suppinnu*, is translated as “a tool for spinning.”<sup>66</sup> But this word has several meanings, as it also describes a tool to make bricks. The Neo-Babylonian texts mentioning the *suppinnu* list others tools related with the manufacture of bricks, agriculture and woodworking. The use of this term in the textile manufacture is not attested in the Neo-Babylonian texts. Indeed, the word appears on lists of utensils that are not related to textile work.<sup>67</sup>

## From thread to fabric

### *The terminology of the loom*

The terminology of weaving tools is also obscure. Several types of loom existed in the Ancient Near East. The Mesopotamian people used the horizontal loom, the warp weighted loom and the vertical loom with two beams. They also wove with small belt looms and tablet looms.<sup>68</sup> These looms were made of wood. An Akkadian fable make this point. In it the tamarisk and the palm tree both claim to be weavers, the former says: “I am a weaver and beat-up the threads.” and the later “I am superior to you in every craft (...) I am a weaver and beat-up the threads.”<sup>69</sup> The Akkadian vocabulary for the loom is known

thanks to the lexical list *Ḫar-ra = ḫubullu*, dated to the 2<sup>nd</sup> half of the 2<sup>nd</sup> millennium BC.<sup>70</sup> When one looks for these terms in the Neo-Babylonian documentation of the 1<sup>st</sup> millennium BC, only a few of them can be identified. This is not only because the lexical list is older, but also because this text records all the terms in the Sumerian and Akkadian literature, even rare occurrences. Many of the words in this list are not found elsewhere. It does not reflect the real spoken or written language<sup>71</sup>. Only two words of the lexical list related to the loom appear in the Neo-Babylonian texts: *nanšu* and *mušabittu*. The word *nanšu*, included as a part of the loom in the lexical lists, means a lever according to the CAD.<sup>72</sup> It comes from the verb *našû*, ‘to rise’.<sup>73</sup> This word appears only in a list of utensils for a ritual.<sup>74</sup> We know that the *nanšu* was made in wood, because the word is preceded by the Sumerian determinative *giš*. If this word still meant a wooden part of the loom in the Neo-Babylonian texts, and according to its root, the verb ‘to rise’, we can propose the hypothesis that it refers to the wooden beam where the heddles are attached. The heddles are the set of parallel cords in a loom used to separate warp threads and make a path for the shuttle.

The word *mušabittu* is mentioned again as a part of the loom the lexical list, *Ḫar-ra = ḫubullu*.<sup>75</sup> The word *mušabittu* or *mušabbittu* is the participle of the verb *šabāṭum*, ‘to seize’ (in G-stem): “the one who envelop, knot, attach the threads” according to the CAD.<sup>76</sup> Following this definition, it might be the upper beam, where the warp threads were attached. The

65. About the Lamaštu Incantation see Farber 2014. About her iconography see Götting 2009.

66. Sumerian *giš-ba* or *giš-ba-bal*, CAD S, 392 “a tool used in brick-making and spinning”; AHw III, 1060: “ein Bau-Werkzeug”.

67. BIN 1, 173: 3 (among tools for the jeweller); YOS 6, 236: 8 (text concerning bricks); YOS 6, 146: 5 (in a list of tools); GCCI 2, 7: 4 (with a tool to make bricks).

68. Breniquet 2008, 133, presents all these looms with pictures.

69. Lambert 1960, 155-161. to ‘beat the thread’ is a metaphor for the weaving.

70. Hh V 298-320. This list is a long enumeration of Sumerian vocabulary with translations in Akkadian, organized by topic.

71. Cavigneaux, 1980-83, 609-641.

72. Reference of the lexical list: Hh. V 314. According to the CAD N/I, 261, *nanšu* (Sumerian *giš-íl-lá*) means “lever (of a loom)”. For AHw III, 731 it is “ein Heber?”.

73. Wisti Lassen 2010, 278 has identified the word *asû* (CAD A/II, 347, *asû* B) as the upper beam of the loom, but it is not attested in the 1<sup>st</sup> millennium documentation, except in a Neo-Assyrian lexical list.

74. TuM 2-3 249: 6.

75. CAD M/II, 240 Sumerian “*giš-nir-ra*”, “(1) part of a loom (2) an implement”; AHw III, 678 “ein ‘Fasser’ am Webstuhl”. Reference of the Lexical list: Hh V 311.

76. CAD M/II, 240.

word *mušabittu* is attested in two Neo-Babylonian texts from Uruk's archives.<sup>77</sup> One, the text NCBT 616, lists several iron tools delivered to the temple by a blacksmith.<sup>78</sup> Among these tools are the iron *mušabittu* and the iron *šišītu*, which could be a part of the loom, maybe the heddle according to the CAD and which means the loom itself according to the Ḫar-ra = *hubullu* lexical list.<sup>79</sup> The following objects listed in this text are an iron knife (*quppū*), an iron bowl (*nalpattu*), and an iron needle (*natkapu*).<sup>80</sup> These words may be linked with weaving work, but iron is not typical for a loom. If these objects are destined to a ritual it would explain their unusual material. The text comes from Uruk temple archive. The tools listed in NCBT 791 where the *mušabittu* also appears are not related to textile work.<sup>81</sup> It is possible that the meaning of the terms recorded in the lexical lists Ḫar-ra = *hubullu*, dated from the 2<sup>nd</sup> millennium BC have changed in the 1<sup>st</sup> millennium texts from Babylonia.

Another weaving word documented in Neo-Babylonian texts is not a tool but a part of the loom: the *šutū*, 'warp'.<sup>82</sup> This word is well attested in Old Babylonian texts but has been found in only one document of the 1<sup>st</sup> millennium BC Babylonia. According to this tablet from Sippar, some quantities of red and green dyed wool were delivered to a craftsman, with 14 shekels (117 grams) of warp thread (*šutū*).<sup>83</sup> The dyed threads were probably for the weft. It would suggest that the coloured patterns were made in the weft, as no colour is mentioned for the warp. But the beginning of the text is obscure, so hypothesis needs further support.

Why loom terminology is not often found in the Neo-Babylonian texts? One has to suppose that the looms were property of the craftsmen working for the temples because they were not mentioned in the texts listing the materials that the institution supplied to them. The horizontal loom, for instance, did not have many parts and could be disassembled easily. It was made with ordinary materials (palm or tamarisk wood). As a common object, the loom was not considered significant either to be recorded in dowries texts, recording all the precious belongings brought by the bride to the house of her husband.

### *The verbs for the weaving*

A verb 'to weave' in Neo-Babylonian Akkadian is *mahāšu*.<sup>84</sup> Its most common meaning is 'to beat'. It is not surprising that the verb for beating meant, by metonymy, the action of weaving because the main gesture of the weaver is the beating of the threads to create a uniform fabric.<sup>85</sup> This verb is present in texts dealing with the fabrication of domestic textile, like for instance, in the following text :

“Arrabi will deliver yearly a *gulēnu*-garment to Ṭābia. Ṭābia has given to him 5 minas of wool, for the weaving of a *gulēnu*.” VS 5, 24: 14-17.<sup>86</sup>

According to this text from Babylon, coming from the Sîn-ilī private archive; Ṭābia rented his palm grove for 10 years to his slave Arrabi, with the gardening equipment. He also gives him wool. In exchange the

77. NCBT 616: 2; NCBT 791: 2.

78. This text is mentioned by courtesy of Elizabeth Payne.

79. CAD S, 214: “a part of the loom”, “probably the harness of the loom or simply the heddle”. AHW III, 1105: “Qaste, Troddel”

80. *Quppū*: CAD Q, 311, AHW III, 928: “Stilett, Messer”; *nalpattu*: CAD N/I, 202, AHW III, 724 meaning 2: “eine Schale, Tiegel”; and *natkapu*: hapax, see below.

81. This text is mentioned by courtesy of Elizabeth Payne.

82. CAD Š/III, 408, *šutū* A: “warp”, AHW III, 1293: “Gewebe”.

83. ZA 4, 145 n. 18: 1-5 “1/3? 2-me 60? <sup>sig</sup>ta-bar-ru ù <sup>sig</sup>ha-ša-áš-ti 14 gín šu-tu-ú ina igi <sup>ld</sup>u-gur-din-iṭ <sup>lu</sup>uš-<bar> bir-mu”, “... red wool and green wool, 14 shekels, the wrap, at the disposal of Nergal-uballit, weaver of coloured clothes”.

84. CAD M/I, 71-84, meaning 3 “to weave”; AHW III, 580: “schlagen, weben”.

85. Cassin 1964, 974-975.

86. VS 5, 24: 14-17 “*ina* mu-an-na<sup>mes</sup> [tūg] *gu* <sup>le</sup>-e-ni <sup>ar</sup>-rab-bi a-na <sup>du</sup><sub>10</sub>-ga-iá [i]-nam-din 5 ma-na <sup>sig</sup>hi-a a-na ma-ḫa-šu [tūg]-gu-le-e-ni <sup>du</sup><sub>10</sub>-ga-iá id!-da-áš-šú”, Babylon, Nabonidus' reign. Michigan Coll. 47: 1-3 also deals with the weaving of the *gulēnu*: a woman is supposed to weave (*ta-ma-aḫ-šu*) one *gulēnu* yearly. The text NBC 6189: 6 mentions the verb *mahāšu* in the expression “*ana ma-ḫa-aḫ qu*”, literally “for the beating of the thread”. I thank M. Jursa his transliteration of this text.

slave own him a part of the harvest and a garment.

The verb *šatû*, which also means ‘to weave’, was no longer used in the 1<sup>st</sup> millennium BC.<sup>87</sup>

## Ornamentation and care of the garments

### *The dyeing*

While the vocabulary of the loom and weaving is not often used in written documentation dealing with textile fabrication, the terminology for the preparation of garments (decoration, washing, *etc.*) is found more frequently. Garments and fabrics offered to the gods in order to dress their cultic statues were richly decorated with golden appliqués and coloured wool. The texts coming from 1<sup>st</sup> millennium BC temple archives and dealing with the manufacturing of garments for the gods’ statues indicate which materials were used for dyeing, but they rarely mention tools. Only the vocabulary for the containers for dyes is mentioned. The word *našraptu* is translated “dyeing vat” by the CAD.<sup>88</sup> But in some Neo-Babylonian texts, for instance TCL 12, 84, the word means linen textile.<sup>89</sup> The cauldron used for dyeing the wool is named *ruqqu* in the Neo-Babylonian texts.<sup>90</sup> It appears only in the context of the blue dyes, in the expression “*ša pî ruqqi*” which mean (wool) from the cauldron. This expression is only applied to blue and blue-purple dye.<sup>91</sup> It

could express the process of the vat dye, especially used for dyes containing indigotine<sup>92</sup>.

The verb meaning the action of dyeing comes from the verb “to soak”, *šabû*.<sup>93</sup> It is used in the Neo-Babylonian texts in the form of the noun *šîpu*.<sup>94</sup> It is often mentioned in temple archives dealing with the textile industry. Materials were given to the craftsmen *ana šapê* “for dyeing”. These craftsmen were specialised in the work of coloured wool, including the dyeing and the manufacturing of small coloured woollen items. At Sippar, they were named “the weavers of coloured wool,” *išpar birmu*.<sup>95</sup>

### *The decoration*

According to the temple archive of Sippar and Uruk, many cultic garments were decorated with coloured wool. Techniques for embroidery, tapestry or carpet, and tassels were known in Mesopotamia.<sup>96</sup> The Neo-Assyrian bas-reliefs show that royal garments were decorated with tassels and with complex scenes, for instance of hunting or mythology, probably embroidered.<sup>97</sup> A Babylonian ritual written in the Hellenistic period, maybe a copy of an older text, describes the garments of the king. They were adorned with complex embroideries depicting gods symbols or astral motives.<sup>98</sup> The Babylonian craftsmen would have used needles for these embroideries or for sewing the

87. *šatû* CAD Š/ II, 217 *šatû* B, “to weave, to spin, to entwine, interlace, to join battle”; AHW III, 1203 *šatû* III: “(Fäden) knüpfen”.

88. CAD N/II, 51, AHW III, 757: “Färbottich”.

89. TCL 12, 84: 12–13 and 16 “11 ma-na 1/3 gín <sup>[sig]</sup>za-gin-kur-ra a-di 2 <sup>gada</sup>na-aš-ra-pa-a-tú gu-ra-[bu]” and “2 na-aš-ra-pa-a-tú šá <sup>sig</sup>za-gin-kur-a” “11 minas 1/3 shekel of blue purple (wool) together with two linen *našrapātu* in a bag”; “Two *našrapātu* of blue purple wool”; Transcription Joannès 1999, 194.

90. CAD R, 416 “1. kettle, cauldron”; AHW III, 995 “(Metall-)Kessel, Schale”.

91. Purple wool out of the cauldron: PTS 3230, YOS 19 74 (Payne 2007, 132); blue wool out of the cauldron: NCBT 632 (Payne 2007, 128). See Payne 2007, 137 who quotes these texts and translates the expression “wool fresh from the cauldron”, and the parallel YBC 7436 (Beaulieu 2003, 361–362).

92. This process requires to soak the wool in hot alkaline water with the blue dye (for instance woad) in a closed vat. The blue dye then became soluble and fix into the wool. Then the wool is exposed to air and become blue by oxidation.

93. CAD S, 45. AHW III, 1104: “Durchfeuchtung, 3. Färbung”

94. CAD S, 205, AHW III, 1104 meaning 3: “Färbung”.

95. This profession also existed during the Neo-Assyrian period, according to Gaspa 2013, 232.

96. Several texts indicate that a same garment could be made of linen and wool at the same time. Usually, a big quantity of linen is used with a small quantity of coloured wool. For example, in the text GCCI 2 381, Amēl-Nanāia, a bleacher, receives 250 grams of purple wool and 2,7 kilograms of flax to make a *šiddu*-curtain. We can suppose that the fabric was in white linen and the decoration in coloured wool.

97. Lion forthcoming.

98. UVB 15 40, Falkenstein 1959, 40-41 and Joannès 2014, 447. The garments “embroidered” are said “*šapû*”. On this verb, see below.

golden attachés that adorned the god's garments. The word *šillû*, meaning needle in the Old Babylonian period, seems to have changed its meaning in the 1<sup>st</sup> millennium.<sup>99</sup> Indeed, according to the texts GCCI 1, 130 and GCCI 1, 75 the *šillû* is an iron object weighing more than one kilogram, too heavy for a sewing needle. It refers to a tool for working wood.<sup>100</sup> It is probable that the same word, *šillû*, was used for several pointed objects, from small to large.

Lastly, the term *natkapu* is mentioned once in a Neo-Babylonian text from Uruk, NCBT 616, and could mean an iron needle, because it comes from the verb *takāpu*, “to pierce, to puncture, to stitch.”<sup>101</sup> The words *dalû* and *katātu*, which also mean needle, are not attested in the 1<sup>st</sup> millennium documentation from Babylonia.<sup>102</sup> The action of sewing may have been expressed by the two verbs: *takāpu* “to pierce” and *rakāsum* “to attach.” It is expressed in the Neo-Babylonian letter BIN 1 6:

“Tablet of Šillaia, to Kalbaia(?) his sister, may Bēl and Nabû ordain well-being of my sister. Sew (and) seal a *šabbatu*-garment, (taken) in the clean garments. Send it to me through the messenger of Nādin.”<sup>103</sup>

To understand more about the techniques of ornamenting textiles, one has to examine the verbs.

The verb *kubbû* or *hubbû* means “to patch, to sew” or “to burnish, to attach” according to the CAD.<sup>104</sup> In the text GCCI 2, 69 from Uruk, concerning the manufacturing of the god's garments, one reads “172 rosettes and *tenšû*-sequins have been taken off the *mušiptu*-garment to be *kubbû* (written *hubbû*). Here this verb may also mean “polish, repair.”<sup>105</sup> It refers to the sewing and repairs of the little golden decorations sewn on the garments adorning the gods' statues.<sup>106</sup> The verb may also have mean the sewing of simple textiles with no mention of golden decorations, as in the following text from Uruk temple archive:

“One *lubāru* garment, one linen *salhu*-tunic, at the disposal of Hīpaia for the sewing.”<sup>107</sup> Eames R 27: 1-3.

The verb *hatû* also refers to the action of sewing golden appliqués onto a garment according to the CAD, and appear in that sense in two Neo-Babylonian texts.<sup>108</sup> For the application of woollen decorations, another verb is employed, *šapû*. It is translated “to wrap, to fasten with laces, thongs” by the CAD.<sup>109</sup> This word is employed in the texts in the form of a substantive in the expression *ana šapê*. According to the texts coming from temples' archive of Uruk and Sippar, the verb means an action of applying small quantities of coloured wool on the garments

99. CAD S, 193-194 *šillû* A; AHW III, 1101-1102 *šillû* II, 3: “Nadel”.

100. The texts GCCI 1, 130, GCCI 1, 75 and GCCI 1, 187 give clues about the weight of the *šillû*. It weighs less than 1.25 kilograms.

101. CAD T, 68; AHW III, 1305: “durch Stiche punktieren, sticheln, tüpfeln”. NCBT 616 is a list of iron tools including several terms, which can be linked to textile work.

102. CAD D, 56 *dalû* A: “a spear or a needle”; CAD K, 304 *katātu*: “needle”.

103. BIN 1, 6 “(1) im <sup>1</sup>šil-la-a a-na <sup>m</sup>ur-a nin-šû den u <sup>n</sup>à šû-lum šá nin-ia liq-bu-ú (5) 1-et <sup>u</sup>gšab-bat bab-ba-ni-ti ina <sup>u</sup>mu-šip-ti eb-bé-ti ti-ik-pi-i” (10) ru-ku-us <sup>i</sup>ku-nu-uk-i u ina <sup>š</sup>u<sup>ll</sup>a-kin <sup>m</sup>šá <sup>n</sup>na-din šu-bi-la”, transliteration of Hackl, Jursa and Schmidl 2014, 351-352. Another edition is Ebeling 1930, K 6.

104. “To patch, to sew”, according to the CAD K, 482, and “to burnish” or “to attach” according to the CAD H, 213; AHW I, 497: “benäht”.

105. Furthermore, the term appears as an adjective in a text to praise the gods “a god whose glory was *hubbû* (radiant)” Hinke Kudurru I, 13. In the same way, a Neo-Assyrian document describes the bed of a deity in these terms: “the lower mattress with golden decorations (in form of) water *hubbû* (radiant)”; Streck Asb. 296: 22.

106. About these golden ornaments, see Gaspa 2014 for the Neo-Assyrian period, and Beaulieu 2003, 21-25 for the Neo-Babylonian period.

107. Eames R27: 1-3 “1 <sup>u</sup>glu-bar 1 <sup>g</sup>ada<sup>s</sup>sal-ḥu / a-na ku-ub-bi-i / ina igi mí<sup>f</sup>ḥi-pa-a”.

108. CAD H, 152 “*hatû* B: (1) to attach (gold ornaments)”, AHW II, 336 *hatû* I: “verziert”. The two texts mentioned in the CAD can also relates with the weighing of the golden appliqué (verb *hātu*) (GCCI 1, 59: 7-8 [ina] ugu ḥa-te-e [šá] a-a-ri u te-en-še-e” and VS 6, 1: 4 “a-na [ḥa]-ti šá a-a-ri šá a-a”.

109. CAD Š/I, 490 *šapû* B.



for the gods.<sup>110</sup> The garments concerned are specified, the headbands *lubār mētu* and *lubār kulūlu*, and the *kusītu* dress. The latter was a feminine divine garment adorned with coloured wool and qualified *birmu* (adorned with coloured woollen embroideries or trimmings).<sup>111</sup> For the verb *šapû* in this context, we can suggest the translation “to embroider” or “to decorate (with trimmings)”.

The verb *nasāhu* in the context of textile work meant the action of removing a part of a garment.<sup>112</sup> At Sippar, we find the same formulae in several texts: “250 grams of blue-purple wool coming from the garments of Šamaš, 100 grams of blue-purple wool coming from the garments of Bunene, from these garments (the wool) was removed.”<sup>113</sup> It seems that what was removed was not the wool of the fabric, thread by thread, but tassels or woollen braids, because their removal does not destroy the garment *lubāru* on which the wool was taken.

### *The care of the garments*

The maintenance of the garments is well documented in temple archives dealing with the luxury textile craft. Professional craftsmen called *ašlāku*, ‘washermen’, regularly washed the woollen and linen textiles.<sup>114</sup> These craftsmen received tens of items of clothing for various deities at the same time, and were in charge of the *zikūtu*, the cleaning of the garments.<sup>115</sup>

For example, in CT 55, 814, 27 new linen fabrics are given to Šamaš-zēr-ušabši, the washer, for washing.<sup>116</sup> The linen fabrics were never dyed, they were bleached to further whiten them by the *pūsaia*.<sup>117</sup>

The tools used for washing and bleaching are not mentioned, but the texts do indicate which materials were needed. For instance, for the bleaching of linen, involve intensive washing with soap made from a special oil and a soda, plus sunlight exposure. In the text BM 84054, the craftsman Bunene-šimanni received tamarisk wood, alkali (soda) and an oil plant for the washing of linen door curtains.<sup>118</sup> The mixing of soda and oil gives soap, and the wood was used as a fuel.

The garments were also often entrusted to the menders *mukabbû* to be ‘repaired’, *ana batqa*.<sup>119</sup> They received a small number of garments, usually less than a tens, and they can be new or worn<sup>120</sup>. In a legal text, Bēl-ittannu, a linen weaver of the Ebabbar temple of Sippar described his work. He declared before the temple’s authorities the disappearance of a linen fabric belonging to the god Šamaš while he was working on it, in those terms:

“(Concerning) A threadbare linen fabric that was at my disposal for repair, I was tearing it in strips for making the bed-cover of Šarrat-Sippar’s bed, and there were no strips left”.<sup>121</sup>

110. For instance: CT 44, 73:22 = Zawadzki Garments II, 67; BM 75567/9 = Zawadzki Garments II, 472; NCBT 988:3; NCBT 90:1; YOS 19, 275:5; VS 20, 15:12; PTS 2576:4; YOS 19, 218:3.

111. Zawadzki 2006, 117-118.

112. CAD N/II, 1-15; AHW III, “ausreissen”.

113. See Zawadzki Garments II, 293; 294; 295; 297; 299; 304; 307.

114. CAD A/II, 445-446: “washerman”; AHW I, 81: “Wäscher” About the textile craftsmen at Sippar see Zawadzki 2006, 50-86; Bongenaar 1997, 300-353. For these artisans in Uruk, see Payne 2007. See also Waerzeggers, 2006, for a study of the profession of washerman in Neo-Babylonian cities.

115. CAD Z, 117 “meaning uncertain”, the dictionary suggest a hypothetic translation “cleaning work”, based on the verbal form *iza-kku* coming from *zākū* “to become clean, clear, light” (CAD Z 25).

116. CT 55, 814: 27-28 “[pap] 27 gada *a-na zi-ku-tu* / [*a-na*] <sup>l</sup>utu-numun-gál-šī <sup>l</sup>utūg-babbar si-in”.

117. CAD P, 538: “lauderer”; AHW III, 883: “Weisswäscher”. For instance, in the text Nbn 492: 8 from Sippar, craftsmen were entrusted with a linen fabric *sīnu* to bleach it “*a-na pu-uš-ši-[e]*”.

118. Zawadzki 2006, 62-63.

119. *mukabbû*: CAD M, 181 “clothes mender”; AHW III, 669: “Näher, Flickschneider”.

120. For instance Nbn 115, Nbn 507, Nbn 137.

121. CT 2, 2: 3-4 “1+en *ki-tu-ú qa-al-pu* / šá *a-na bat-qa ina igi-ia a-na mu-še-zib* šu<sup>l</sup>-meš šá <sup>g</sup>na<sup>s</sup> ná<sup>d</sup> gašan zimbi<sup>h</sup>i ú-še-ra-tu 1+en *ši-iš-ṭi ina lib-bi ia-a-nu*” (Joannès 1992, 182-183).

The verb used is *šarātu*, meaning here “to tear into strips, to shred”.<sup>122</sup> Perhaps the craftsman is using these strips of linen fabrics to make the padding of the coverlet. The tools of the menders are not described in the documentation.

## Conclusion

Thanks to an analysis of the terminology, with the help of iconography and archaeology, it is possible to find some of the techniques known by the Babylonian textile craftsmen in the first millennium BC. The study of the Akkadian vocabulary in the Neo-Babylonian texts reveals evolutions. New words appeared in this period, like the term *šuppu*, as well as new techniques, such as the shearing of sheep with iron shears. Another characteristic of textile making in Babylonia during the 1<sup>st</sup> millennium BC is the growing specialization of craftsmen, at least in Neo-Babylonian temples. The tasks of the craftsmen were not limited to the weaving of textiles. The importance of the decoration of the garments, with coloured wool or golden appliqués, is obvious in the luxury textile production of the temples. In the domestic context, visible in the private archive, the textiles were also, not only woven but also sewn and prepared in specific ways. Textiles were valuable goods and their care was important. Even the precious textiles destined to the cult were re-used and cleaned repeatedly. When the garments of the gods were worn, they were recycled in other textiles like bed-covers. The study of tool terminology and action verbs confirms that the textile industry of 1<sup>st</sup> millennium BC Babylonia had reached a high level of specialization and technical knowledge, especially in luxury production of the temples.

## Abbreviations

ABL = Harper, R. F. (1892-1914) *Assyrian and Babylonian Letters*. London-Chicago.  
 ABRT = Craig, J. (1895-1897) *Assyrian and Babylonian Religious Texts*, I-II. Assyriologische Bibliothek 13. Leipzig.

ADD = Johns, C. H. W. (1898-1923) *Assyrian Deeds and Documents*. Cambridge.

AfO = Archiv für Orientforschung

AHw = von Soden, W. (1959-1981) *Akkadisches Handwörterbuch*, I-III. Wiesbaden.

AOAT = Alter Orient und Altes Testament.

ASJ = Acta Sumerologica.

BAR = British Archaeological Reports

BBR = Zimmern, H. (1896-1901) *Beiträge zur Kenntnis der babylonischen Religion, Beschwörungstafeln Surpu, Ritualtafeln für Wahrsager, Beschwörer und Sänger*. I-II. Assyriologische Bibliothek 12. Leipzig.

Bertin = Bertin, G. (1883) *Copies of Babylonian Terracotta dated Tablets, principally Contracts, seven volumes*, unpublished, held by the Department of Western Asiatic Antiquities in the British Museum.

BIN I = Keiser, C. E. (1917) *Babylonian Inscriptions in the Collection of J. B. Nies*, New Haven.

BM = Tablets in the British Museum.

BRM I = *Babylonian Records in the Library of J. Pierpont Morgan*, New Haven 1917.

CAD = *The Assyrian Dictionary of the University of Chicago*. Chicago 1956-2010.

Camb = Strassmaier, J. N. (1890) *Inschriften von Cambyses, König von Babylon (529-521), Babylonische Texte Heft VIII-IX*. Leipzig.

CT 22 = Campbell Thompson, M. R. (1906) *Cuneiform Texts from Babylonian Tablets in the British Museum, Part XXII*. London.

CT 44 = Pinches T. G. (1963) *Cuneiform Texts from Babylonian Tablets in the British Museum, 44, Miscellaneous Texts*. London.

CT 54 = Dietrich, M. (1979) *Cuneiform Texts from Babylonian Tablets in the British Museum Part 54, Neo-Babylonian Letters from The Kuyunjik Collection*. London.

CT 55, 56, 57 = Pinches, T. G. & Finkel, I. L. (1981) *Neo-Babylonian and Achaemenid Economic Texts. Cuneiform Texts from Babylonian Tablets in the British Museum, band LV, LVI and LVII*. London.

Eames R27 = Oppenheim, A. L. (1948) *Catalogue of the cuneiform tablets of the Wilberforce Eames Babylonian collection in the New York Public Library*. New York.

GCCI 1 = Dougherty, R. P. (1923) *Goucher College Cuneiform Inscriptions, Archives from Erech, time of Nabuchadrezzar and Nabonidus*. New Haven.

122. CAD Š/II, 59 “2. *šurrutu* to tear into strips, to shread”.

- GCCI 2 = Dougherty, R. P. (1933) *Goucher College Cuneiform Inscriptions, Archives from Erech, Neo-Babylonian and Persian periods*. New Heaven.
- Hh V = Landsberger, B (1957) *Material for Sumerian Lexicon V. The Series HAR-ra hubullu*. Rome.
- Hinke Kudurru = Hinke, W. J. (1911) *Selected Babylonian Kudurru Inscriptions*. Leiden.
- ITT 5 = Inventaire des tablettes de Tello
- JRAS = *Journal of the Royal Asiatic Society of Great Britain and Ireland*. London.
- McEwan LB = Mc Ewan, G. J. P. (1982) *The Late Babylonian Tablets in the Royal Ontario Museum*. Toronto.
- MDOG = Mitteilungen der Deutschen Orient-Gesellschaft.
- Michigan Coll. 47 = Moore, E. (1939) *Neo-Babylonian Documents in the University of Michigan Collection*. Michigan.
- NBC = *Tablets in the Nies Babylonian Collection*. Yale University.
- Nbk = Strassmaier, J.N. (1889) *Inschriften von Nabuchodonosor, König von Babylon (604-561 v. Chr). Babylonische Texte Band V-VI*. Leipzig.
- Nbn = Strassmaier, J.N. (1889) *Inschriften von Nabonidus, König von Babylon (555-538). Babylonische Texte Band I-IV*. Leipzig.
- NCBT = *Newell Collection of Babylonian Tablets*. Yale University.
- OBO = Orbis Biblicus et Orientalis.
- Oppenheim Dream-book  
Oppenheim A. L. (1956), *The Interpretation of Dreams in the Ancient Near East, with a Translation of an Assyrian Dream Book*. Philadelphia.
- PIHANS = Publications de l'Institut historique-archéologique néerlandais de Stamboul.
- PTS = *Tablets in the Princeton Theological Seminary*.
- RA = *Revue d'assyriologie et d'archéologie orientale*.
- SAA = State Archives of Assyria. Vols. 1-19. Helsinki.
- SAALT = State Archives of Assyria Literary Texts. Helsinki.
- Streck Asb. = Streck, M. (1916) *Assurbanipal und die letzten assyrischen Könige bis zum Untergange Niniveh's*. Leipzig.
- TCL 12 = Conteneau P. (1927) *Contrats Néo-Babyloniens, de Téglath Phalasar à Nabonide. Textes Cunéiformes du Louvre XII*. Paris.
- TuM 2 = Krückmann, O. (1933) *Neubabylonische Rechts- und Verwaltungs-Texte*. Leipzig.
- UCP 9/1 and 2 = Lutz, H.F. (1927) *Neo-Babylonian Administrative Documents from Erech, I & II*. University of California.
- VS = *Vorderasiatische Schriftdenkmäler der (Königlichen) Museen zu Berlin*.
- YOS 6 = Dougherty, R. P. (1920) *Records from Erech, time of Nabonidus*. Yale Oriental Series VI, Babylonian Texts. New Heaven-London.
- YOS 19 = Beaulieu, P.-A. (2000) *Legal and administrative texts from the reign of Nabonidus*. Yale Oriental Series XIX. New-Haven-London.
- ZA = *Zeitschrift für Assyriologie und vorderasiatische Archäologie*.
- Zawadzki Garments II = Zawadzki, S. (2013) *Garments of the Gods. Texts. Band 2*. OBO 260. Fribourg.

## Bibliography

- Abrahami, P. (2014) Wool in the Nuzi Texts. In C. Breniquet & C. Michel, *Wool Economy in the Ancient Near East and the Aegean, From the Beginnings of Sheep Husbandry to Institutional Textile Industry*. 283-309. Ancient Textiles Series 17. Oxford.
- Abraham, K. & Sokoloff, M. (2011) Aramaic Loanwords in Akkadian – A Reassessment of the Proposals, *AfO* 52, 22-76.
- Andersson Strand, E. (2010) The Basics of Textile Tools and Textile Technology – From Fibre to Fabric. In C. Michel & M.-L. Nosch (eds.), *Textile Terminologies, in the Ancient Near East and Mediterranean from the Third to the First Millennium BC*, 10-22. Ancient Textiles Series 8, Oxford.
- Baccelli, J., Bellucci, B. & Vigo, M. (2014) Elements for a Comparative Study of Textile Production and Use in Hittite Anatolia and in Neighbouring Areas. In M. Harlow, C. Michel & M.-L. Nosch (eds.), *Prehistoric, Ancient Near Eastern and Aegean Textiles and Dress: An Interdisciplinary Anthology*, 96-142. Ancient Textiles Series 18. Oxford-Philadelphia.
- Barber, E. J. W. (1991) *Prehistoric Textiles, The Development of Cloth in the Neolithic and Bronze Ages with Special Reference to the Aegean*. Princeton.
- Beaulieu, P.-A. (2003) *The Pantheon of Uruk During the Neo-Babylonian Period*. Cuneiform Monographs 23. Leiden-Boston.
- Blanqui, A.-J. M. (1839) *Dictionnaire du Commerce et de l'Industrie, tome troisième*. Brussels.
- Bongenaar, A.C.V.M. (1997) *The Neo-Babylonian Ebabbar*

- Temple at Sippar: Its Administration and its Prosopography*. PIHANS 80. Leiden.
- Breniquet, C. (2006) Ce lin, qui me le peignera ? Enquête sur la fonction des peignes en os du Néolithique précéramique levantin, *Syria* 83, 167-176.
- Breniquet, C. (2008) *Essai sur le tissage en Mésopotamie, des premières communautés sédentaires au milieu du IIIème millénaire av. J.-C.* Paris.
- Breniquet, C. (2014), The Archaeology of Wool in Early Mesopotamia, Sources, Methods, Perspectives. In C. Breniquet & C. Michel (eds.), *Wool Economy in the Ancient Near East and the Aegean, From the Beginnings of Sheep Husbandry to Institutional Textile Industry*, 52-78. Ancient Textiles Series 17. Oxford-Philadelphia.
- Breniquet, C. & Michel, C. (eds.) (2014) *Wool Economy in the Ancient Near East and the Aegean. From the Beginnings of Sheep Husbandry to Institutional Textile Industry*. Ancient Textiles Series 17. Oxford-Philadelphia.
- Cassin, E. (1964) Tissage. In *Dictionnaire archéologique des techniques* II, 974-977. Paris.
- Cavigneaux, A. Lexikalische Listen, *Reallexikon der Assyriologie* 6, 1980-1983, 609-641.
- Charvát, P. (2014) Lambs of the Gods. The Beginnings of the Wool Economy in Proto-Cuneiform Texts. In C. Breniquet & C. Michel (eds.), *Wool Economy in the Ancient Near East and the Aegean, From the Beginnings of Sheep Husbandry to Institutional Textile Industry*, 79-93. Ancient Textiles Series 17. Oxford-Philadelphia.
- Delcor, M. (1979) Quelques termes relatifs à l'élevage des ovins en hébreu classique et dans les langues sémitiques voisines. In *Études bibliques et orientales de religions comparées*, 373-392. Leiden.
- Deshaye, J. (1960) *Les outils de l'âge du bronze, de l'Indus au Danube, IV<sup>e</sup>-II<sup>e</sup> millénaire*, I-II, Paris.
- Driel van, G. (1993) Neo-Babylonian Sheep and Goats, *Bulletin of Sumerian Agriculture* 7, 219-258.
- Ebeling, E. (1930) *Neubabylonische Briefe aus Uruk*. München.
- Falkenstein, A. (1959) Zwei Rituale aus seleukidischer Zeit. In H. Lenzen (ed.) *Vorläufiger Bericht über die von dem Deutschen Archäologischen Institut und der Deutschen Orient-Gesellschaft aus Mitteln der Deutschen Forschungsgemeinschaft unternommenen Ausgrabungen in Uruk-Warka, Winter 1956-1957*. Berlin.
- Farber, W. (2014) *Lamaštu. An Edition of the Canonical Series of Lamaštu Incantations and Rituals and Related Texts from the Second and First Millennia B.C.* Winona Lake, Indiana.
- Gaspa, S. (2013) Textile Production and Consumption in the Neo-Assyrian Empire. In M.-L. Nosch, H. Koefoed & E. Andersson Strand (eds.), *Textile Production and Consumption in the Ancient Near East*, 224-247. Ancient Textiles Series 12. Oxford.
- Gaspa, S. (2014) Golden Decorations in Assyrian Textiles: An Interdisciplinary Approach. In M. Harlow, C. Michel & M.-L. Nosch (eds.) *Prehistoric, Ancient Near Eastern and Aegean Textiles and Dress: An Interdisciplinary Anthology*, 227-244. Ancient Textiles Series 18. Oxford-Philadelphia.
- Götting, E. (2009 - unpublished) *Ikonographie einer altorientalischen Dämonin*, Magisterarbeit, Freie Universität Berlin.
- Graslin, L. (2009) *Les échanges à longue distance en Mésopotamie au I<sup>er</sup> millénaire, une approche économique*. Orient et Méditerranée 5. Paris.
- Grömer, K. (2016) *The Art of Prehistoric Textile Making – The development of craft traditions and clothing in Central Europe*. Vienna.
- Hackl, J., Jursa, M. & Schmidl, M. (2014) *Spätbabylonische Privatbriefe*. AOAT 414/1, Late Babylonian Private Letters, Band 1. Münster.
- Jacobsen, Th. (1987) *The Harps that Once, Sumerian Poetry in Translation*. New Haven & London.
- Joannès, F. (1992) Les temples de Sippar et leurs trésors à l'époque néo-babylonienne. In *Revue d'Assyriologie* 86, 159-184.
- Joannès, F. (1992) Inventaire d'un cabaret, *NABU* 1992/64, 48-50.
- Joannès, F. (1999) Structures et opérations commerciales en Babylonie à l'époque néo-babylonienne. In J. G. Dercksen (eds.), *Trade and Finance in Ancient Mesopotamia (MOS Studies 1). Proceedings of the First MOS Symposium, Leiden 1997*. 175-194. PIHANS 84. Istanbul.
- Joannès, F. (2006) Traitement des malades et *bît hilši* en Babylonie récente. In L. Battini & P. Villard (eds.), *Médecine et médecins au Proche-Orient ancien*, 73-90. BAR 1528. Oxford.
- Joannès, F. (2010) Textile in the Neo-Babylonian Documentation. In C. Michel & M.-L. Nosch (eds.) *Textile Terminologies from the 3<sup>rd</sup> to the 1<sup>st</sup> Millennia BC in the Ancient Near East and the Eastern Mediterranean Area*. 400-408. Ancient Textiles Series 8. Oxford.
- Joannès, F. (2014) Fabrics and Clothes from Mesopotamia during the Achaemenid and Seleucid Periods: The Textual references. In C. Breniquet & C. Michel, *Wool Economy in the Ancient Near East and the Aegean, From the Beginnings of Sheep Husbandry to Institutional Textile Industry*. 453-464. Ancient Textiles Series 17. Oxford.
- Jursa, M. (2005) *Neo-Babylonian Legal and Administrative Documents, Typology, Contents and Archives*.

- Guides to the Mesopotamian Textual Record 1. Münster.
- Jursa, M. (2010) *Aspects of the Economic History of Babylonia in the First Millennium BC, Economic Geography, Economic Mentalities, Agriculture, the Use of Money and the Problem of Economic Growth*. AOAT 337. Münster.
- Kozuh, M. G. (2014) The Sacrificial Economy: Assessors, Contractors, and Thieves in the Management of Sacrificial Sheep at the Eanna Temple of Uruk (ca. 625–520 B.C.) *Exploration in Ancient Near Eastern Civilizations* 2, Winona Lake-Indiana
- Lambert, W. (1960) *Babylonian Wisdom Literature*, Oxford.
- Lion, B. (forthcoming) Les vêtements brodés du roi d'Assyrie. Communication à la 4<sup>ème</sup> journée d'étude du programme corps, gestes et vêtements, *Les manifestations du Politique, Université de Caen, 3-4 octobre 2013*.
- Margueron, J.-Cl. (1995) Emar, Capital of Aštata in the Fourteenth Century BCE, *Biblical Archaeologist* 58, 126-138.
- Matsushima, E. (1994) On the Material Related to the Clothing Ceremony- *lubuštu* in the Later Periods in Babylonia, *ASJ* 16, 177-200
- Matsushima, E. (1998) On the Lubuštu-Ceremony of Bêl in the Seventh Century B.C., *ASJ* 20, 111-119.
- Michel, C. (1998) Les mites d'Assyrie, Moth in the Assyrian Texts of the Second Millennium B.C., *JAOS* 118 n.3, 325-331.
- Michel, C. (2014) Wool Trade in Upper Mesopotamia and Syria According to Old Babylonian and Old Assyrian Texts. In C. Breniquet & C. Michel (eds.), *Wool Economy in the Ancient Near East and the Aegean, From the Beginnings of Sheep Husbandry to Institutional Textile Industry*, 232-254. Ancient Textiles Series 17. Oxford-Philadelphia.
- Michel, C. & Nosch, M.-L. (eds.) (2010) *Textile Terminologies from the 3<sup>rd</sup> to the 1<sup>st</sup> Millennia BC in the Ancient Near East and the Eastern Mediterranean Area*. Ancient Textiles Series 8. Oxford.
- Muthukumar, S. (2016), Trees cotton (*G. arboreum*) in Babylonia. In E. Foyetta et al. (eds.), *Cultural and Material Contacts in the Ancient Near East, Proceedings of the International Workshop 1-2 December 2014, Torino*, 98-105. Sesto Fiorentino.
- Payne, E. E. (2007) *The Craftsmen of the Neo-Babylonian Period: A Study of the Textile and Metal Workers of the Eanna Temple*. Yale University. (Unpublished, provided by the author).
- Quillien, L. (2014) Flax and linen in the First Millennium BC Babylonia: The Origins, Craft Industry and Uses of a Remarkable Textile. In M. Harlow, C. Michel & M.-L. Nosch (eds.), *Prehistoric, Ancient Near Eastern and Aegean Textiles and Dress: An Interdisciplinary Anthology*, 271-296. Ancient Textiles Series 18. Oxford-Philadelphia.
- Quillien, L. (2015) Le manteau pourpre de Nabuchodonosor : circulations économiques de la laine de couleur pourpre en Mésopotamie au Ier millénaire av. J.-C., *Hypothèses 2014*, 105-118.
- Rast-Eicher, A. & Bender Jorgensen, L. (2012) Sheep wool in Bronze Age and Iron Age Europe. *Journal of Archaeological Science* 40, 1224-1241.
- Ryder, M. L. (1993) Sheep and Goat Husbandry, with Particular Reference to Textile Fibre and Milk Production. *Bulletin of Sumerian Agriculture* 7/1, 9-32.
- Sauvage, C. (2014) Spindles and Distaffs: Late Bronze and Early Iron Age Eastern Mediterranean Use of Solid and Tapered Ivory/Bone Shafts. In M. Harlow, C. Michel & M.-L. Nosch (eds.), *Prehistoric, Ancient Near Eastern and Aegean Textiles and Dress: An Interdisciplinary Anthology*, 184-226. Ancient Textiles Series 18. Oxford-Philadelphia.
- Sjöberg, A. W. (1975) A Hymn to the Goddess Inanna by the en-Priestess Enĥeduanna, *ZA* 65, 161-253.
- Stol, M. (1995) Women in Mesopotamia. *Journal of the Economic and Social History of the Orient* 38/2, 123-144.
- Vita, J. P. (2016) Les gzzm “tondeurs” à Ougarit. In V. Matoïan & M. Al-Maqdissi (eds), *Études ougaritiques IV, Ras Shamra – Ougarit XXIV*, 139-147. Leuven.
- Völling, E. (1998) Bemerkungen zu einem Onyxfund aus Babylon. *MDOG* 130, 197-221.
- Waetzoldt, H. (1972) *Untersuchungen zur neusumerischen Textilindustrie*. Studi economici e tecnologici 1. Roma.
- Wisti Lassen, A. (2010) Tools, Procedures and Profession: a review of the Akkadian textile terminology. In C. Michel & M.-L. Nosch (eds.), *Textile Terminologies, in the Ancient Near East and Mediterranean from the third to the first Millennium B.C.*, 272-282. Ancient Textiles Series 8. Oxford.
- Zawadzki, S. (2006) *Garments of the Gods. Studies on the Textile Industry and the Pantheon of Sippar according to the Texts from the Ebabbar Archive. 1*. OBO 218. Fribourg.
- Zawadzki, S. (2013) *Garments of the Gods. Vol. 2: Texts*. OBO 260. Fribourg.

# 5

## Ordinary People's Garments in Neo- and Late-Babylonian Sources<sup>1</sup>

Luigi Malatucca

The investigation of textiles and clothes in ancient Mesopotamia has been anything but neglected in Assyriological studies. For the Neo- and Late Babylonian periods, in particular, two fundamental monographs have shed light on the clothes worn by the deities worshiped in lower Mesopotamia.<sup>2</sup> Scholars, however, have focused almost exclusively on clothing in the cultic context. This is due to a prevalence of textual sources – mostly economic or administrative documents – recording clothing items worn by divine images during festivals and rituals. Sources on the clothes worn by common people, instead, are close to non-existent. Still, we cannot overlook the fact that Mesopotamian towns were crowded by people rather than by gods. These people were workers, slaves and soldiers, and each one of them – man or woman – wore clothes in his or her everyday life. The objective of the present paper is to examine the three main clothing items worn by common people, using textual sources of the Neo- and Late Babylonian periods. These items were *túg-kurra* (a blanket of a sort used as garment), *mušiptu* (a generic garment), and *šir'am* (a jerkin).

### Methodology

Two essays in the book *Textile Terminologies in the Ancient Near East and Mediterranean from the Third to the First Millennia BC* (2010) focus on textiles and clothing in the Neo-Babylonian period.<sup>3</sup> In his article, Stefan Zawadzki investigates clothing in non-cultic contexts. As a guideline for the study of non-cultic attire, I list below the different types of documents singled out by Zawadzki as being most likely to include references to clothing items not destined for the statues of gods.<sup>4</sup>

- dowries;
- quittances for rations;
- payments for wet nurses;
- text concerning military uniforms;
- texts concerning workmen's clothes.

My focus and Zawadzki's, however, are different. Zawadzki, in his article, deals with clothing in non-cultic contexts, whereas here I discuss clothing for common people. The non-divine clothing items mentioned in text usually belong to the fine apparel

1. This essay is drawn from a poster I presented at the conference cycle *Textile Terminologies from the Orient to the Mediterranean and Europe 1000 BC – AD 1000*. I would like to thank Professors Stefan Zawadzki and Michael Jursa for their valuable advice and Professor Federico Poole for the English version of this article.

2. In his study of the pantheon of Uruk, Beaulieu 2003 discusses at length the clothing destined for the divine statues of the Eanna, the temple complex of the city. Zawadzki 2006, instead, focuses entirely on the apparel of the gods of the Ebabbar, the main temple of the town of Sippar.

3. Joannès 2010; Zawadzki 2010.

4. Zawadzki 2010, 410.

of the privileged classes of Mesopotamian society. These fall outside of the scope of the present study, which concentrates exclusively on inexpensive clothing items worn by the middle-low classes in Babylon. But who exactly were these ‘common people’?

Neo- and Late Babylonian society was roughly divided into two classes. The first was that of the *mār banê*, the free citizens, while the second gathered individuals legally depending from the central administration (the temple or the palace) or in a condition of slavery. The *mār banê* enjoyed full rights in front of the law and could own one or more slaves. They included temple officials, merchants, bankers, craftsmen, farmers, and also individuals living in poverty.<sup>5</sup> The second class, instead, included both free individuals deprived of civil rights, such as the ‘royal soldier’ (*bēl qašti*), the ‘partially free dependents’ (*šušānū*),<sup>6</sup> and totally unfree individuals such as the slaves (*ardū* or *qallū*) or the servants of the temple (*širkū*). Evidently, when we speak of common people we are mainly referring to people belonging to this second class, although we cannot overlook the *mār banê* class, insofar as it also included non-wealthy individuals. To sum up, by ‘common people’ I mean here all the members of Babylonian society, whether free or not, who did not hold prestigious positions, such as dependent workers (workmen, craftsmen, *etc.*), apprentices, or slaves.

The existence in Babylonian society of a clear-cut distinction between higher and lower social classes can also be deduced from the diversity of the clothing worn by the two classes. Obviously, a rich individual

had the means to buy fine clothes, while this possibility was denied to economically disadvantaged persons. It even appears that the lower social classes were forbidden from wearing the garments worn by the elites. Text Camb. 321 is especially illuminating in this regard.<sup>7</sup> In this legal document, Nabû-ētir, a rich man of the Ētiru family, strikes the slave Madānubēl-ušur, reproaching him for wearing a *šibtu* dress.<sup>8</sup> Other than this document, there is indeed no evidence of the *šibtu* dress being worn by slaves, workmen, or soldiers. It was often used, instead, in religious ceremonies,<sup>9</sup> and there is also evidence of its secular use.<sup>10</sup>

Thus, starting from Zawadzki’s list of documents to determine what garments the majority of the population wore, we need to exclude both the fine, expensive clothes worn by the upper classes,<sup>11</sup> which also appear in Neo- and Late Babylonian documents,<sup>12</sup> and the clothes worn by divine statues. We can thus narrow down our examination to the three garments I will be looking at in detail in the following sections.

### túg-kur-ra

The túg-kur-ra is frequently mentioned in Neo- and Late Babylonian documents. Many scholars have dealt with this garment and the various questions concerning it.<sup>13</sup> The main issue is the actual Akkadian reading of the logograms túg-kur-ra.<sup>14</sup> We owe one of the first hypotheses about túg-kur-ra and its Akkadian equivalent to Dougherty.<sup>15</sup> On the basis of the kur-ra = *šadū* equivalence, this scholar proposed translating the word as ‘mountain garment.’<sup>16</sup> A later reading

5. MacGinnis 1995, 5-6.

6. Stolper 1985, 78-82.

7. The text is collated, translated and commented in Wunsch & Magdalene 2012.

8. The name of the garment is written with the signs <sup>u</sup>g.sal.i.dab. For the Akkadian reading of these logograms as *šibtu*, see Wunsch & Magdalene 2012, 110.

9. Principally used to cover divine statues, the *šibtu* was also worn by priests during the *lilissu*-drum ritual; cf. text UVB 15, 40 and Çağırhan & Lambert 1991-1993, 93.

10. CAD S, 162b.

11. Some individuals belonging to the elites can be identified, especially thanks to the prosopographical studies of Kümmel 1979, Bongenaar 1997, and Payne 2007.

12. Luxury garments include the *gulēnu* (Zawadzki 2010, 419), the *guzguzu* (Quillien 2013), and the *suḫattu* (Jursa 2006, 206-207).

13. Dougherty 1933 (= GC 2), Ungnad 1937, San Nicolò 1945, Oppenheim 1950, Ebeling 1953, Borger 1981, Bongenaar 1997, Janković 2008, Zawadzki 2010, Jursa 2010, Jursa 2014 (= CTMMA 4).

14. Most recently addressed by Zawadzki 2010, 413-414.

15. Dougherty 1933, 21<sup>1</sup>.

16. Labat 1995, 167 no. 366.

is found in the *Chicago Assyrian Dictionary* (CAD), where kur-ra is regarded as syllabic rather than logographic writing, and is hence read *sad-ra*<sup>17</sup> and translated as 'ordinary garment'. Later on, the CAD itself, following the indications of R. Borger, no longer accepted the reading of kur-ra as *sad-ra*.<sup>18</sup> Once the logographic value of kur-ra was firmly established, several Akkadian readings were proposed over the years, viz., *mušiptu*,<sup>19</sup> *suḫattu* and *kanzu*.

As regards the reading *suḫattu*, S. Zawadzki leans towards the reading proposed in CAD S, 346,<sup>20</sup> on the basis of the parallelism between two texts, UCP 9, 271 and Dar. 253, where the word *suḫattu* is evidently used instead of túg-kur-ra, and *vice versa*. This leads the scholar to tentatively suggest that túg-kur-ra be read as *suḫattu*.<sup>21</sup> Evidence from other sources, however, speaks against this hypothesis. In at least two loci, the terms *suḫattu* and túg-kur-ra appear side-by-side, viz., in CTMMA 4, 13<sup>22</sup> and TU 44.<sup>23</sup> This enables us to rule out their equivalence. Furthermore, in the apprenticeship contract BM 54558,<sup>24</sup> from the Hellenistic period, a certain Libluṭ, the son of the woman slave Guzasigu, has to learn how to make a *suḫattu birmi*, 'a multicolor *suḫattu*'.<sup>25</sup> Now, multicolor túg-kur-ra never occurs in the documentation, probably because the túg-kur-ra is not a fancy and, hence, prestigious garment.<sup>26</sup> Finally, in CT 4, 29d *suḫattu* occurs as a royal gift,<sup>27</sup> whereas, again, túg-kur-ra does not seem to be a luxury commodity.

Basing himself on text CTMMA 4, 38, Michael

Jursa has recently proposed the Akkadian reading *kanzu* for túg-kur-ra:

#### CTMMA 4, 38

##### Obverse

1. 2 gun 1<sup>en</sup> túg<sup>ka</sup>-an-zu
2. šá ul-tu úḫ<sup>ki</sup>
3. na-šá-'<sup>ma</sup>-a u<sup>md</sup>utu-gi
4. iḫ-ḫi-iṭ iti.kin ud.8.kám
5. mu.sag.nam.lugal.e<sup>mag</sup>-níg.du-pab

##### Lower edge

6. lugal tin.tir<sup>ki</sup>

##### Reverse

7. ina gub<sup>zu</sup> šá<sup>md</sup>en-da
8. <sup>meri</sup>-ba-<sup>d</sup>amar.utu <sup>mzi</sup>-ka-ri
9. <sup>ma</sup>-a u<sup>md</sup>utu-pab
10. túg-kur-ra ina é.gur<sup>meš</sup>

"Two talents (of wool?) (and) one *packing cloth* that where brought from Opis: Aplāya and Šamaš-ušallim weighed (it). Month of Ulūlu, day 8 accession year of Nebuchadnezzar, king of Babylon. In the presence of Bēl-lē'i, Erība-Marduk, Zikaru, Aplāya, and Šamaš-nāšir the blanket (was put) in the storehouse."<sup>28</sup>

In the above-quoted text, it is evident, as Jursa remarked, that the term túg-kur-ra is used as a synonym for *kanzu*.<sup>29</sup> As for túg<sup>kanzu</sup>, the term is never attested

17. CAD S, 225e. *Sad* and *kur* are written with the same sign, so either reading is possible.

18. CAD S, 19-20 s.v. *sadru* 'ordinary'; cf. Borger 1981, 187 no. 536 and Zawadzki 2010, 413.

19. The clearest proof that túg-kur-ra and *mušiptu* are not identical is that *mušiptu* is a feminine noun, while túg-kur-ra is certainly masculine, being regularly followed by masculine adjectives. See Oppenheim 1950, 188-189, and Zawadzki 2010, 413.

20. Zawadzki 2010, 413-414.

21. "The parallelism between both texts is striking, and the probability that túg-kur-ra should be read *suḫattu* or *supātu* is high, though some doubt still exist," Zawadzki 2010, 413.

22. *suḫattu* in obv. l.1; túg-kur-ra in rev. l.18.

23. túg-kur-ra in col. IV l.14; *suḫattu* in col. IV, l.28; on this text, see Linszen 2004, 252-262.

24. Published in Jursa 2006, 216.

25. <sup>gu</sup>-za-si-gu gé[me x x x x] ina ḫu-ud lib-bi-šú<sup>m</sup>lib-luṭ<sup>r</sup> dumu-šú<sup>a</sup>-[na] la-ma-du dul-lu su-hat-tu<sup>4</sup> bir-[mi]; BM 54558 obv. ll. 1-3. A multicolored *suḫattu* (*suḫattu ša birmi*) also appears in NBC 6164, where it is used as payment for a weaver, Jursa 2006, 207.

26. In the Neo-Babylonian period, the adjective *birmu* often refers to clothing items used in the context of cult, cf. CAD B, 258i.

27. McEwan 1985.

28. Transliteration and translation by Jursa in the volume CTMMA 4, 66-67; the copy of the tablet is on Plate 33.

29. See commentary in CTMMA 4, 38 l. 10.



in Akkadian documents. It could well be a loanword from the Aramaic root *knz* ‘to deposit’<sup>30</sup> or it could be interpreted as a Persian loanword, based on the Old-Persian word *kanz* ‘treasure’.<sup>31</sup> The *túg-kur-ra* = *kanzu* equivalence is possible for two reasons. The first we have already seen, namely, that in CTMMA 4, 38 *kanzu* and *túg-kur-ra* are two different terms used to describe the same object. The second is that the use of *túg-kur-ra* as packing material is also attested in other documents. In the Uruk letter YOS 3, 11, a given quantity of wool is placed inside some *túg-kur-ra*. This is an analogous situation to the one we have seen in CTMMA 4, 38.<sup>32</sup> In ritual text TU 44, of the Hellenistic period, a *túg-kur-ra* is used to wrap the carcass of a bull.<sup>33</sup> It is thus clear that, in the present state of the evidence, the term *kanzu* is the best candidate for the Akkadian reading of *túg-kur-ra*. Still, some problems remain unsolved, namely:

- 1) CTMMA 4, 38 is the only occurrence of *kanzu* where it is qualified as a textile;
- 2) *túg-kur-ra* in CTMMA 4, 38 could be a generic term used to qualify the textile *kanzu* as a ‘blanket’;
- 3) wrapping objects is not the main use of *túg-kur-ra*, while the term *kanzu* seems to refer exclusively to a textile used for that purpose.

Although the correct Akkadian reading of *túg-kur-ra* is still not defined, the use of this textile is documented by a wide range of evidence.

In the letter YOS 21, 98, from Uruk, the *túg-kur-ra* is clearly indicated as a garment worn by the workmen: “send 20 *túg-kur-ra*-garments. Here there are many naked workmen.”<sup>34</sup>

Another document where *túg-kur-ra* are given to workers is BM 63343:<sup>35</sup>

### BM 63343

Reverse

1. 10 gú.un 20 ma.na s[íg.ħi.a]
2. *a-na* 49 *túg-kur-ra*<sup>meš</sup>
3. *šá* <sup>lu</sup>*erín*<sup>meš</sup> *e-peš dul-lu*
4. *šá qi-i-pi a-na* <sup>md</sup>*utu-še*[š<sup>meš</sup>-su]

Ten talents and 20 minas of w[ool] for 49 *túg-kur-ras* of the workers of the *qīpu* to Šamaš-ah[ħē-erība]

In this text, the 49 *túg-kur-ras* appear to be used as a medium for payment. The use of these textiles as rations of sorts is well attested in Neo- and Late Babylonian sources.<sup>36</sup> Thanks to BM 63343, we know how much wool was required to buy a *túg-kur-ra* at Sippar (during the reign of Nabonidus – 556-539 BC). A *túg-kur-ra* costs 12.65 mine of wool, about six kilograms.<sup>37</sup> Other textual sources give different quantities of wool for one *túg-kur-ra*,<sup>38</sup> indicating that this price fluctuated. Unfortunately, these texts only tell us how much a *túg-kur-ra* was worth in wool, not how much wool was needed to make one. This information seems to be found, instead, in CT 55, 783, from Sippar:

### CT 55, 783

Obverse

1. [12<sup>7</sup> ma.na síg.]ħi.a *a-na* 2 *túg-kur-ra*<sup>meš</sup>

30. CAD K, 148 s.v. *kanāzu*. *Kunzu* also repeatedly occurs as a leather bag in CAD K, 549 s.v. *kunzu*. See, again, the commentary in CTMMA 4, 38 l. 1.

31. See CDA, 145. I am grateful to C. Michel for this suggestion.

32. 10 gú síg.ħi.a *ina* *túg-kur-ra*<sup>meš</sup>-šú-nu *ħi-ṭi-ma* (YOS 3, 11: 13-15); see commentary in CTMMA 4, 38 l. 10.

33. ad<sub>6</sub> gu<sub>4</sub> *šá-a-šú ina* 1<sup>en</sup> *túg-kur-ra sa, ta-qeb-bir* “you will bury the carcass of that bull in a red *túg-kur-ra*” (TU 44, col. II, l. 19); Linsens 2004, 253.

34. 20 *túg-kur-ra*<sup>me</sup> *šu-bi-la erín*<sup>me</sup> *e-re-šá-ni-ia a-kan-na ma-'a-du-[tu]* (YOS 21, 98 l. 34-35).

35. Published in Zawadzki 2002, 156-157.

36. See Jursa 2010, 619-623. In particular, see the table of prices on pp. 620-622, showing all the prices of *túg-kur-ra* attested between the reign of Assurbanipal (668-628 BC) and that of Darius (521-486 BC). The average price of a *túg-kur-ra* was thus roughly 5 shekels of silver in Uruk, roughly 6 shekels of silver in Sippar.

37. One shekel = 8.3 grams; one mina = 500 grams; one talent = 30 kilograms. One mina = 60 shekels; one talent = 60 minas.

38. GC 1, 161, from Uruk (Nabucodonosor II – 605-559 BC) has eight minas for one *túg-kur-ra* (four kilograms); NCBT 641 (Uruk – Nabucodonosor II) has eight minas and ten shekels for one *túg-kur-ra* (3.5 kilograms); PTS 2370 (Uruk - Nabonedus) has ten minas for one *túg-kur-ra* (five kilograms).

2. <sup>f</sup>ar-na-bé u dumu.sal<sup>meš</sup>-šú
3. 6 ma.na a-na 1<sup>en</sup> túg-kur-ra
4. <sup>f</sup>di-di-i-tu<sub>4</sub>

“[12<sup>7</sup> minas of w]ool for two túg-kur-ras to Arnabe and her daughters. Six minas for one túg-kur-ra to Didītu”

In this text, each woman is given a standard quantity of wool (six minas) to make túg-kur-ra. In all likelihood, these women are weavers in the service of an *išparu* (chief weaver).<sup>39</sup> Woman weavers are not uncommon in Near Eastern sources, whether epigraphic or iconographic. It is likely that in this geographical area, as well as elsewhere, weaving was an exclusively female occupation.<sup>40</sup> Other women, probably engaged in spinning, are recorded on some clay dockets dated to the reign of Merodach-baldan II (722-703 BC). Each docket gives the name of the spinner and her supervisor, and was presumably tied with a string to the wool to be spun.<sup>41</sup> Another textual source, Camb. 398, adds some useful information about the characteristics of túg-kur-ra:

### Camb. 398

1. 2 túg-kur-ra<sup>meš</sup> eš-šu-tu šá 8 kùš
2. gíd.da-’ ‘8?’ [kùš dagal]-’ ù
3. 12 ma.na ki.lá-šú-nu

“Two new túg-kur-ra, 8 cubits long each, 8<sup>7</sup> [cubits wide] each and their weight (being together) 12 minas”.<sup>42</sup>

According to Camb 398, a regular túg-kur-ra weighing 6 minas (like the túg-kur-ra mentioned in CT 55, 783) should be 8 cubits (about four meters) long, and probably 7 or 8 cubits wide. This is the only Neo-Babylonian record of the measurements of this kind

of garment, although in the text TC 3, 17, of the Old Assyrian period (2000-1740 BC), the measurements of a finished cloth roughly coincide with those of the túg-kur-ra of Camb. 398,<sup>43</sup> and the same is true of ITT V, 1921, pl. 63, no. 9996, (Ur III period – 2112-2004 BC), where a cloth measures 8 by 7 cubits.<sup>44</sup>

The large size of the túg-kur-ra induced A. L. Oppenheim to proposed translating the term generically as ‘blanket’.<sup>45</sup> His intuition seems to have hit the mark, having been adopted in many later studies.<sup>46</sup> The final test – as Oppenheim himself regards it to be – of whether túg-kur-ra was a blanket is possibly found in text Nbn. 662, where two individuals each receive one half (*mišil*) of the same túg-kur-ra.<sup>47</sup> Túg-kur-ra could be, therefore, a blanket wrapped around the body as a garment, and it was not used only by workers. The garment is also mentioned as being worn by priests (during particular ritual acts?), slaves, wet nurses, travelers, and soldiers.

Concerning priests, clearly these must be regarded as part of the elite, which, as I specified above, I will not be dealing with in the present study. However, I think it is important to mention, if only in passing, the role of the túg-kur-ra worn by a *galamaḥḥu*-priest in a ritual of the Hellenistic period:

### UVB 15, 40

13. <sup>lú</sup>galamaḥḥu <sup>tú</sup>lu-bar kitî ḥa-líp u <sup>tú</sup>gsūna šá šapal rēši qaqqad-su rakis
14. [ina] l[i-l]i-[i]s siparri ina a-šá-bi-šú <sup>tú</sup>lu-bar du<sub>8</sub>-ma
15. [<sup>tú</sup>g<sub>x</sub> x x] u túg-kur-ra il-lab-biš

“The *galamaḥḥu*-priest will wear a linen *lubāru*-garment and he will tie a *sūnu*-hat for the lower head, but if he wants to

39. Like CT 55, 783, another document, NBC 4920, mentions a *zakītu* weaving túg-kur-ra; see Jursa 2010, 596<sup>3217</sup>.

40. Nemet-Nejat 1999, 106-107.

41. Joannès 2010, 401-402.

42. See also Oppenheim 1950, 189.

43. *ga-am-ra-am šu-ba-ta-am ša té-pí-ši-ni tí-šé i-na-mì-tim lu ú-ru-uk-šu ša-ma-né ina a-mì-tim lu ru-pu-šu* “a finished textile that you make must be nine cubits long and eight cubits wide” (ll. 33-36). See Michel & Veenhof 2010, 250-251.

44. Veenhof 1972, 91-92.

45. Oppenheim 1950, 189.

46. For example, Bongenaar 1997, 39; Janković 2008, 452; Jursa 2010, 619.

47. Oppenheim 1950, 189; cf. Zawadzki 2010, 414.

sit near the bronze kettledrum, he will divest the *lubāru* and he will wear [...] and a *túg-kur-ra*”

In this text, it is evident that *túg-kur-ra* is somehow distinct from the other prestige clothing items mentioned in the text, as it is used by the priest in replacement of a *lubāru*-dress made of linen, a garment frequently used to clothe divine images. This change of clothes occurs at a specific point in the ritual, that is, when the priest is about to sit on the *lilissu*-tympanum. It is not clear why it is required, since the tympanum is usually not viewed negatively or regarded as impure.<sup>48</sup> Linen was not regarded as an impure fiber either; the opposite, if anything, is true. Probably some actions the priest was called upon to perform were regarded as being somehow impure, and this is why he needed to change his dress into an ordinary garment.<sup>49</sup> *Túg-kur-ra* are rarely mentioned as being worn by slaves or servants. The text GC 1, 161 records the giving of the garment to a slave, more specifically to a *širku*:

#### GC 1, 161

1. 1 *túg-kur-ra*
2. *šá a-na* 8 ma.na síg.ḫi.a
3. *ana-šá-*
4. *a-na* <sup>md</sup>en-e-*tè-ru*
5. <sup>lúšim</sup>ki na-din

“One *túg-kur-ra*, which for 8 minas of wool is brought, to Bēl-ēṭeru, the oblate, is given”.

The *širku* or ‘oblate’ is a particular kind of slave enjoying a rather privileged position, as he is consecrated to the temple and a specific deity. As for mere slaves (*qallū* or *ardū*), instead, they are more frequently mentioned as wearing *šir’am* or *mušiptu*.<sup>50</sup>

48. Linssen 2004, 93.

49. See Zawadzki 2006, 91.

50. For these garments, see below.

51. I will discuss *túg-kur-ra* and *šir’am* for travelers and soldiers below, in my section on *šir’am*.

52. Wunsch 2003-2004, no. 20.

I mentioned above that the *túg-kur-ra* was part of the attire of travelers and soldiers. When clothes are mentioned in connection with travelers or soldiers, these are almost certain to be *túg-kur-ra* and *šir’am*; in most cases, the two clothes are recorded together as the constituent elements of a uniform of sorts.<sup>51</sup> Finally, BM 33978<sup>52</sup> shows that the *túg-kur-ra* could be one of the items that wet nurses were paid with:

#### BM 33978

##### Obverse

1. <sup>f</sup>nu-up-ta-a dumu.sal *šá* <sup>md</sup>ag-šes-i[t-tan-nu ...]
2. *a-na* um.me.ga.lá-ú-tu <sup>r</sup>a-<sup>di</sup> 2-<sup>r</sup>ta <sup>r</sup>mu.an.na<sup>meš</sup>
3. dumu.sal *šá* <sup>f</sup>gemé-ia dumu.sal *šá* <sup>mki</sup>-<sup>r</sup>ag-<sup>tin</sup> dumu <sup>md</sup>en-e-*tè-ru*
4. *tu-še-šab ina* mu.an.na 1<sup>en</sup> *túg-kur-ra*
5. 3 gín kù.babbar iti 1 *qa* <sup>r</sup>mun-<sup>ḫi</sup>.a 1 *qa saḫ-le-e*
6. 1<sup>en</sup> <sup>r</sup>su-um-mu-nu *šá* <sup>r</sup>i.giš <sup>u</sup><sub>4</sub>-mu 2 *qa qí-me*
7. <sup>r</sup>4<sup>?</sup> ninda.ḫi.a 1 *qa* kaš.sag <sup>f</sup>gemé-ia
8. [*a-na*] [<sup>f</sup>nu-up-ta-a ta-nam-din
9. [...] <sup>r</sup>x x <sup>r</sup>[...]

##### Reverse

10. [1<sup>en</sup> *túg*].kur.ra <sup>f</sup>gemé-ia *a-na* <sup>f</sup>nu-up-t[*a-a*]
11. [*ta-n*]am-din  
(witnesses and date)

“Nūptāya, daughter of Nabû-aḫa-it[tannu ...], receives the daughter of Amtiya, the daughter of Itti-Nabû-balātu, of the Egibi family, for a breastfeeding lasting two years. Amtiya will give [to] Nūptāya: annually 1 *túg-kur-ra* (and) 3 shekels of silver; monthly 1 litre of salt, 1 litre of cress, 1 *summunu*-vessel (full) of oil; daily 2 litres of flour, 4<sup>?</sup> loaves (and) 1 litre of first

quality beer [...] Amtiya [will] give [the túg].kur.ra to Nūptāya [...]"

The text, written in Babylon and dated to the reign of Xerxes (485-465 BC), is a contract for the payment of the wet nurse Nūptāya. She is charged with breastfeeding Amtiya's daughter, in exchange for which she will be paid with silver, staple foods, and a túg-kur-ra.<sup>53</sup>

Interestingly, in at least two such wet-nurse contracts the term túg-kur-ra is replaced by the term <sup>túg</sup>*kabru*.<sup>54</sup> For example, in BM 74330 a wet nurse is paid four silver shekels and a *kabru*-garment.<sup>55</sup> This does not enable us to conclude that *kabru* is the Akkadian reading of túg-kur-ra. However, if the *kabru*-garment is actually made of heavy cloth, the very fact that it takes the place of túg-kur-ra in the same type of document suggests that the túg-kur-ra was also made of heavy cloth, at least in this case.

### *muṣiptu*

In 1953, in the like-titled entry in his *Glossar zu den neubabylonischen Briefe*, Erich Ebeling explains the word *muṣēptu* as follows: “**muṣēptu** (D Part. von *ṣēpu*) “Hülle”, eine Art Burnus, Idgr. <sup>túg</sup>kur.ra.”<sup>56</sup> Although Ebeling's work remains to this day one of the most important studies ever carried out on Neo-Babylonian correspondence, since then some progress has been made in the understanding of the term. In 1950, A.L. Oppenheim had already solved the problem of the incorrect identification of

túg-kur-ra with *muṣiptu* by proving that the latter has no ideographic equivalent.<sup>57</sup> The name *muṣiptu* is very likely to derive from *ṣuppu* ‘to rub’, attested in the Middle Assyrian period (1350-1100 BC) in the context of horse husbandry with the specific meaning ‘to groom’.<sup>58</sup> Its nominal form *muṣiptu* possibly designates the dressing of wool.<sup>59</sup> According to the authors of the *Concise Dictionary of Akkadian* (CDA), the verb *ṣuppu* may also have the meaning of ‘decorating,’ which however is not applicable to *muṣiptu*, because evidence for decorated *muṣiptu* is just about nonexistent.<sup>60</sup> In Neo-Babylonian documents, the term *muṣiptu* often occurs with the generic meaning of ‘garment.’<sup>61</sup> The *Akkadisches Handwörterbuch* (AHw) and the CDA hence translate it, respectively, as ‘Gewand’ and ‘garment,’<sup>62</sup> while the *Assyrian Dictionary of Chicago* (CAD) attempts a more detailed translation ‘(standard size) piece of cloth.’<sup>63</sup> By placing ‘standard size’ between parentheses, the authors admit to doubts regarding the actual standardization of the measurements of a *muṣiptu* garment, and indeed no text indicating these measurements is known so far. Some sources provide other kinds of information:

### YOS 6, 91

1. 5 gín kù.babbar ṣ[ám] 4 *mu-ṣip-ti*

“5 shekels of silver, the price of 4 *muṣiptus*”

53. In rev. 1, it appears that Amtiya gives another túg-kur-ra to Nūptāya. It is likely that this túg-kur-ra is actually part of an annual payment given immediately to Nūptāya together with 3 silver shekels, which were possibly mentioned in the damaged portion of the tablet (obv. 9).

54. Wunsch 2003-2004, no. 214. According to CAD K, 23 s.v. d, *kabru* could be a heavy garment.

55. Wunsch 2003-2004, no. 19 (obv. 8): *i-na mu 4 gín kù.babbar 1<sup>en</sup> <sup>túg</sup>kab-ri*.

56. Ebeling 1953, 140-141.

57. Oppenheim 1950, 188-189; see also the section on túg-kur-ra in the present essay, and Zawadzki 2010, 413.

58. CAD Ṣ, 250; on this term see also Gaspa in the present volume.

59. CAD Ṣ, 249 s.v. \**ṣuppu* C “strip of carded wool.”

60. CDA, 341 s.v. *ṣuppu* II “to decorate, inlay ?, overlay ?”; cf. Zawadzki 2010, 417.

61. This is true, for example, of texts relative to dowries, where different types of garments are listed under the term *muṣiptu*; cf. Roth 1989-1990, 29.

62. AHw, 679; CDA, 220.

63. CAD M2, 242.

## YOS 3, 104

10. 5 <sup>túg</sup>mu-šip-<sup>r</sup>tu<sub>4</sub><sup>7</sup>
11. šu-bi-lam
12. udu.níta
13. lu-bu-uk-kam-ma
14. lu-uš-pur-ka

“Send me 5 *mušiptus* and I will take and send you a ram.”

## Evetts Lab. 6

1. *i-na* maš ma.na 3 gín kù.babbar
2. *šá a-na mu-šip-tu*<sub>4</sub> sum<sup>in</sup>

“Out of a half mina (of silver), 3 shekels of silver were given for a *mušiptu*”<sup>6</sup>

## VAS 6, 58

5. “2” gín 4-ut *šá mu-šip-e-tu*<sub>4</sub>
- “2 shekels (and) ¼ for a *mušiptu*”

According to the indications of these four texts, a *mušiptu* was not especially valuable. YOS 6, 91 indicates a price of 1.25 shekels of silver, and the Uruk letter YOS 3, 104 clearly states that five *mušiptus* were worth the same price as a sheep. Assuming the average price of a sheep to be around three shekels of silver,<sup>65</sup> this *mušiptu* would be worth about half a shekel. These are of course approximate figures, but they clearly suggest that the *mušiptu* was an inexpensive clothing item. The other two documents record, respectively 3, and 2.25 shekels per item. These prices match those attested for a *túg-kur-ra*.

Not only is the cost of a *mušiptu* about the same, in some cases, as that of a *túg-kur-ra*, but the two garments are also used in the same ways. GC 2, 349, where some workers are given large quantities of clothing items, is the best evidence of the fact that the *mušiptu* was not only inexpensive, but also used by common people.<sup>66</sup>

64. CAD M2, 243, has this differently: *ina* 33 gín *kaspi šá ana mušiptu nadin*. According to this reading, the cost of a *mušiptu* is of 33 silver shekels.

65. Jursa 2010, 739.

66. Zawadzki 2010, 417.

## GC 2, 349:

Obverse

1. “40” <sup>túg</sup>mu-šip-ti <sup>md</sup>15-mu-mu a-šú *šá*  
<sup>md</sup>ag-[x x]
2. 30 <sup>md</sup>a g-na-din-mu a-šú *šá*  
<sup>mri</sup>mut-<sup>d</sup>gu-la
3. 10-ta <sup>m</sup>gar.mu a-šú *šá* <sup>md</sup>dù-<sup>d</sup>15
4. 10-ta <sup>md</sup>en-gi a-šú *šá* <sup>md</sup>utu-mu
5. 10-ta <sup>md</sup>dù-<sup>d</sup>15 a-šú *šá* <sup>mšá</sup>-<sup>d</sup>ag-šú-ú
6. 10-ta <sup>md</sup>innin-na-mu-šeš a-šú *šá*  
<sup>m</sup>mu-<sup>d</sup>ag
7. 10-ta <sup>md</sup>innin-na-numun-be a-šú *šá*  
<sup>m</sup>gin-numun
8. 10-ta <sup>md</sup>innin-na-numun-giš a-šú *šá*  
<sup>md</sup>en-mu-gar<sup>un</sup>
9. 5-ta <sup>md</sup>x x-dù-uš a-šú *šá* <sup>md</sup>en-din<sup>it</sup>

Lower edge

10. pap 135-ta <sup>túg</sup>mu-šip-ti

Reverse

11. *ina ú-il-tim šá é.an.na ina ugu*
12. <sup>lú</sup>gal<sup>meš</sup> 50<sup>meš</sup> *a-di qí-it*
13. *šá iti.kin a-na é.an.na i-nam-di-nu*

“40 *mušiptus* (for) Ištar-šum-iddin son of Nabû?-x-x

30 (for) Nabû-nadin-šumi son of Rimût-Gula

10 (for) Šākin-šumi son of Ibni-Ištar

10 (for) Bēl-ušallim son of Šamaš-iddin

10 (for) Ibni-Ištar son of Ša-Nabû-šu-ú

10 (for) Innina-šum-ušur son of Iddin-Nabû

10 (for) Innina-zēr-ušabši son of Mukīn-zēri

10 (for) Innina-zēr-Iššir son of Bēl-šum-iškun

5 (for) x-x-epuš son of Bēl-uballit

Total 135 *mušiptus*

the debit of the Eanna temple over the *rab hanše*. Up to the end of the month of Elūlu they will give (back) to Eanna temple.”

Actually, the text records a total of 135 clothing items to be distributed, in lots of 40, 30, 10, 5, among nine supervisors of working units of 40, 30, 10, and 5 workers. In the final part of the text, these supervisors are identified as *rab hanše*.<sup>67</sup> One of the tasks of these supervisors was to return some of the *mušiptu* within the month of Elūlu, probably the date established for completion of the work. The returning of the clothes to the temple – in this particular case, the Eanna – is undisputable proof that institutions possessed clothes, presumably kept in their storerooms,<sup>68</sup> which they would distribute among dependents when work was to be done.

A particular feature of *mušiptu*, probably shared with the *guzuzu* clothing item,<sup>69</sup> was that they could be rolled up.<sup>70</sup> In the text Nbk. 369, we read: 1<sup>en</sup> gišná ki-ir-ka túg-guz-guz túg-mu-ši-pe-ti “a bed (with) rolled up *guzguzu* and *mušiptu*.” Dar. 530 reads: giša-ra-an-nu mu-ši-pe-e-tu<sub>4</sub> ki-iš-ki, where it is evident that rolled up (*kišku*) *mušiptu* were gathered in a basket (*arannu*).

As to how *mušiptu* were used, the information found in letter BIN 1, 6 is particularly surprising:

#### BIN 1, 6

Obverse

1. im <sup>m</sup>šil-la-a a-na
2. <sup>f</sup>ur-a nin-šú
3. <sup>d</sup>en u <sup>d</sup>ag šu-lum šá
4. nin-ia liq-bu-ú
5. 1<sup>er</sup> túgšab-bat
6. bab-ba-ni-ti
7. ina túg-mu-šip-ti
8. eb-bé-ti

9. ti-ik-pi-i'
10. ru-'ku'-us-i
11. ku-nu-uk-i
12. u ina šu<sup>II</sup> lu<sup>a</sup>.kin<sup>me</sup>
13. šá <sup>m</sup>na-din
14. šu-bi-la

“Letter of Šillāya to Kalbāya, his sister. May Bel and Nabû decree good health to my sister. Sew, tie and seal one good-quality *šabbatu* in a clean *mušiptu* and send it through the messengers of Nadin.”

In this document from Uruk, a man named Šillāya asks a woman, Kalbāya, to send him a fine *šabbatu*.<sup>71</sup> To do so, the woman must first of all *sew* the prized garment inside a clean *mušiptu*, tie it, and seal it. Here the verb *to sew* seems to be rendered with the word *ti-ik-pi-i'*, presumably the imperative of the second person singular of the verb *takāpu*. The translation as ‘sew,’ however, is questionable, as the commonly accepted translation for this verb is ‘to bore, to sting.’<sup>72</sup> The CAD, however, also includes ‘to sew’ among the possible translations of *takāpu*, as an extension of the original meaning, since sewing is done by boring a hole through a textile.<sup>73</sup> Leaving aside the yet unsolved issue of the meaning of the verb *takāpu*, the subsequent lines of BIN 1, 6 bear witness to a practice that is rarely attested in the Neo- and Late Babylonian periods, but well-documented for early Assyrian times, namely, the use of packaging and sealing textiles to send them to third parties.<sup>74</sup> The only other known Neo-Babylonian attestation of the packaging of textiles is a letter (YOS 21, 31) where a garment of the *šir'am* type undergoes the same treatment as the garment *šabbatu* before being sent.<sup>75</sup> To conclude,

67. The *rab hanšū* (CAD H, 81) is the head of a team of 50 workmen or soldiers. A typical team was composed of ten men under the supervision of a *rab eširti*; cf. CAD E, 365.

68. As was the case for túg-kur-ra, cf. Nbn. 290: 9 túg-kur-ra ta è šu<sup>II</sup> “nine túg-kur-ra in the storeroom (*bīt qāti*)”. For *bīt qāti*, see CAD Q, 199 and Joannès 2010, 401.

69. Quillien 2013, 22.

70. See CAD M2, 242b; Zawadzki 2010, 411 and Roth 1989-1990, 30.

71. The garment called *šabbatu*, mentioned in earlier periods as a luxury clothing item, is never mentioned in Neo-Babylonian documents, except in this case: cf. CAD Š1, 8 s.v. *šabattu*.

72. In the Neo-Babylonian period, the verb for “sewing” is *kubbū*; cf. CAD K, 482-483.

73. CAD T, 68.

74. Veenhof 1972, 41-44.

75. *šir-a-am rak-su-ú u ka-an-gu-ú* “a *šir'am* packaged and sealed” (YOS 21, 31: l.10).

on the evidence of BIN 1, 6 and on the basis of other considerations, it is reasonable to affirm that *mušiptu* is a length of an inexpensive textile used as a garment, but also to wrap things up (possibly by sewing it) and protect fine clothes during transportation.

The term *mušiptu* also occurs as a designation for garments worn by various members of Babylonian society. In several textual sources we learn of *mušiptus* used as female garments. For example, in Dar. 575, a slave woman called Mušezibtum receives a *mušiptu*,<sup>76</sup> and the legal text BM 103452<sup>77</sup> refers to the stealing of a *mušiptu* belonging to a woman named Rišāya, possibly a widow:

#### BM 103452

6. <sup>m</sup>ki'-<sup>d</sup>utu-tin a-šú <sup>m</sup>la-ba-ši a-na da-na-na a-na é

7. a-na muḥ-ḥi-ia ki-i i-ru-ub iṭ-ṭi-ra-an-ni

8. u <sup>túg</sup>mu-šip-ti-ia it-ta-ši

“Itti-Šamaš-balātu, the son of Lâbâši had broken into my house by force, he beat me, took away my *mušiptu*.”

A garment of the *mušiptu* type is mentioned in connection with animal husbandry in BE 8, 106. Here a slave, charged with pasturing cows, receives food rations and a *mušiptu* from the *rē'û* (herdsman) Nabûmukîn-zēri for carrying out the task.

Finally, *mušiptu* are prominently featured in apprenticeship contracts, for example Cyr. 64:

#### Cyr. 64

1. <sup>f</sup>nu-up-ta-a dumu.sal-su šá <sup>m</sup>mu-<sup>d</sup>amar.utu a <sup>m</sup>zálag-<sup>d</sup>30

2. <sup>m</sup>at-kal-a-na-<sup>d</sup>amar.utu <sup>lú</sup>qal-la šá <sup>m</sup>ki-<sup>d</sup>amar.utu-tin

3. a-šú šá <sup>m</sup>ag-šeš<sup>mes</sup>-mu a <sup>m</sup>e-gi-bi a-na <sup>lú</sup>iš-pa-ru-tu

4. a-di 5 mu.an.na<sup>mes</sup> a-na <sup>m</sup>d-en-kar<sup>er</sup> a-šú

5. šá <sup>m</sup>ap-la-a a <sup>m</sup>d-en-e-ṭè-ru ta-ad-di-in

6. iš-pa-ru-tu gab-bi u-lam-mad-su

7. ṭup-pi ṭup-pi u<sub>4</sub>-mu 1 qa pad.hi.a ù

8. mu-šip-tu<sub>4</sub> <sup>f</sup>nu-up-ta-a a-na <sup>m</sup>at-kal-a-na-<sup>d</sup>amar.utu

9. ta-nam-din ...

“Nūptāya, daughter of Iddin-Marduk, son of Nūr-Sîn, has given Atkal-ana-Marduk, the slave of Itti-Marduk-balātu, son of Nabû-ahhē-iddin of the Egibi family, to Bēl-ēter son of Aplāya son of Bēl-ēteru, for learning the weaver’s craft for a period of 5 years. For the entire period of his training, Nūptāya will give daily one *qû* of bread and a *mušiptu* to Atkal-ana-Marduk [...]”

Apprenticeship contracts are typical of the Late Babylonian period.<sup>78</sup> They consist of a contract between a free citizen and a master craftsman. The citizen entrusts his or her son, daughter or slave to the master for a given period of time for training in a specific craft. Once taken in charge, the practitioner’s keep is paid for by the parent or owner, not the tutor, who in some cases also receives additional payment. The *mušiptu*-garment is one of the most frequently mentioned items among the provisions given to the apprentice, whereas *túg-kur-ra* or *uzāru*-garments<sup>79</sup> are mentioned, albeit rarely, among the goods given to the teacher in payment, but never *mušiptu*.

#### šir'am

The *šir'am*-garment occurs quite frequently in Mesopotamian documents. It originally was exclusively an item of military apparel, a cuirass of sorts. It is mentioned as such, for example, in EA 22, a text from the El-Amarna period (ca. 1350 BC):

#### EA 22, col. III

37. 1 šu sa-ri-am zabar 1 gur-sí-ib zabar ša lú

76. *mu-šip-tu*<sub>4</sub> <sup>m</sup>i-gi-ir-ki a-na <sup>f</sup>mu-še-zib-tum ú-kát-[tam] (Dar. 575 ll. 10-11)

77. Published in Jursa, Paszkowiak & Waerzeggers 2003-2004, 265-268.

78. J. Hackl has dealt extensively with this theme in Jursa 2010, 700-725.

79. *uzāru* appears in apprenticeship contract BOR 1, 83, *túg-kur-ra* in Cyr. 313.

38. 1 šu *sa-ri-am ša* kuš 1 *gur-sí-ib* zabar  
39. *ša lú za-ar-gu-ti* ...

“1 bronze cuirass set, 1 bronze helmet for a man, 1 leather cuirass set, 1 bronze helmet for the *sarku*-soldiers”

In the Neo-Babylonian period, the *šir'am* is still part of the military uniform, but also occurs among the garments worn by civilians. Neo-Babylonian cuneiform sources quite commonly mention *šir'am* as military apparel:

#### Dar. 253

6. 12 túg-kur-ra 12-ta túgšir-a-am  
7. 12-ta kar-bal-la-tu<sub>4</sub> 12 kušnu-ú-tu  
8. 24 kušše-e-nu ...

“12 túg-kur-ras, 12 *šir'am*, 12 *karballatus*, 12 *nūtu*s, 24 *šenu*s”

Dar. 253 enumerates the items making up the equipment of 12 soldiers, and is thus a valuable example of the composition of a military uniform. The specific function of each item is well known, not only thanks to abundant data in epigraphic sources, both coeval and from other periods, but also and especially thanks to the availability of iconographic sources that one can compare with textual ones. The persistent depiction of fully armed and clad soldiers in Neo-Assyrian palace reliefs is certainly the most informative source for a comparison between the Akkadian term and the actual garment it designated.

In military uniforms, the túg-kur-ra is used as underwear and placed under the *šir'am*. The best translation for *šir'am* seems to be the one proposed by J. MacGinnis,<sup>80</sup> who renders the Akkadian term as ‘jerkin.’<sup>81</sup> Soldiers wore it either as a simple wool garment or as a cuirass reinforced with pieces of

metal. As regards the *šir'am* as a cuirass, one text more than any other, UCP 9, 271, adds important information, as it mentions a *sir'annu* (= *šir'am*) reinforced with iron (*parzillu*). A *šir'am* of cloth could be a jerkin, but also a tunic of sorts.<sup>82</sup> This is borne out by Neo-Assyrian reliefs where archers, in particular, wear a long dress reinforced with plates.<sup>83</sup> The *karballatu*, made of wool or linen, is the most frequently mentioned headwear in Neo- and Late Babylonian documents.<sup>84</sup> The above-cited text UCP 9, 271 mentions a *karballatu ša sir'annu*. This suggests that there was a connection between *karballatu* and the iron *šir'am*. It is possible that the headwear was somehow connected to the jerkin, or that the expression *karballatu ša sir'annu* alludes to the fact that the *karballatu* is of metal, just like the *šir'am*. The two remaining elements – which were made of leather, since the term is preceded by the determinative kuš – are *nūtu* and *šenu*. The former term designates a bag used to carry goods, while the latter was normally employed for footwear.

Túg-kur-ra and *šir'am* (often mentioned together with *karballatu*, *nūtu* and *šenu*) were not merely elements of military apparel; they were also worn by individuals undertaking long journeys (*šidītu*) at the behest of the temple or the palace.<sup>85</sup> A good example of this is BM 78828,<sup>86</sup> where some carpenters (*naggāru*) receive túg-kur-ra and *šir'am* garments that they may travel to a military camp (*madāktu*).<sup>87</sup> As F. Joannès had already noted, there existed a broad range of *šir'am*:<sup>88</sup> for men (*šir'am ša zikāri* in Evetts Ner. 28) and for women (*šir'am ša kitī amilti* in Evetts Ner. 28); of linen (*šir'am ša kitī* in TCL 9, 117); red-dyed (*šir'am ša tabāri* in Nbn. 661), blue-dyed (*šir'am ša inzahurēti* in YOS 7, 7), or of purple-dyed wool (*šir'am ša si<sup>g</sup>hé.me.da* in GC 1, 299); fine *šir'am* worn as undergarments (*šir'am šupālītu eššetū babbanītu* in Nbk. 12); and luxury *šir'am*

80. MacGinnis 2012.

81. The same translation is used by Zawadzki 2010, 414.

82. Janković 2008, 453, gives the same translation.

83. See for example Paterson 1915, Plate 14.

84. CAD K, 215.

85. See Janković 2008, esp. 452-454.

86. MacGinnis 2012, no. 35.

87. The carpenters were probably headed to a military camp to repair wooden objects, such as boats; cf. Zawadzki 2008, 334-335.



worn as outer garments (*šir'am elēnītu murruqītu babbanītu* in AJSL 16, 73 no. 16). This piece of evidence enables us to conclude that the *šir'am* was used in Babylonian society both as an ordinary garment – there are quite a few testimonies of *šir'am* worn by slave men or women<sup>89</sup> – and as a fine one.<sup>90</sup> *Šir'am* may have had different values depending on how they were manufactured. This is suggested by some documents indicating their prices:

#### YOS 19, 242

1. 1/3 1/2 gín kù.babbar 4 túg-kur-ra<sup>meš</sup>
  2. ù 1 <sup>túg</sup>*šir-a-am a-na* 10 gín kù.babbar
  3. pap 1/2 ma.na 1/2 gín kù.babbar šám é
- “1/3 (mina) half shekel, 4 túg-kur-ras and 1 *šir'am* for 10 shekels. The house price is in total half 1/2 and 1/2 a shekel”

In YOS 19, 242, the price of the *šir'am* can be interpreted in two different ways: the ten silver shekels may be the price of the *šir'am* alone,<sup>91</sup> or the overall price of the *šir'am* and the túg-kur-ra. Both interpretations pose problems, of a different order. If we assume the ten shekels to be the price of the two items together, we are unable to determine the exact price of either.<sup>92</sup> If, instead, we assume the ten shekels to be the price of the *šir'am* alone, it appears to be too high compared to the other recorded prices for a *šir'am*.<sup>93</sup>

#### Conclusions

The aim of this article was to investigate a field fraught with insurmountable hurdles. The main difficulty besetting a study of clothing worn by ordinary people is that epigraphic documents provide little information about the lives of those who do not belong to the upper echelons of Babylonian society. In the rare cases when Babylonian common people are mentioned, their role is merely accessory, their actions only being noted down because they are correlated to individuals or events worthy of being recorded.

Another extremely complicated question is that of terminology. The clothes of common people are often generically described as ‘dress’ or ‘garment.’ Túg-kur-ra and *mušiptu*, in particular, are used in this generic way. It is thus hard to understand, in the lack of a clear textual context, whether a *mušiptu* in a given document is just any clothing item or the clothing item thus designated.

The best sources on the wearing of túg-kur-ra, *mušiptu* and *šir'am* by common people are texts recording their donation to groups of people, such as workmen or soldiers.<sup>94</sup> In exceptional cases, some particular categories of workers to whom specific clothing items were assigned can be discerned. As we have seen, túg-kur-ra, besides being a garment donned by workmen and soldiers was also donated to wet nurses as part of their sustenance. The *mušiptu* was worn by workmen, but above I have indicated one case where it was used in an animal husbandry

88. Joannès 2010, 407; cf. CAD S, 314b and Zawadzki 2010, 414.

89. In Nbk. 408, the slave Apatšu receives a *šir'am* from Tatāya, a freewoman: 1<sup>en</sup> <sup>túg</sup>*šir-a-am* <sup>ta-ta-a</sup> *a-na* <sup>a-pa-at-šú</sup> sum<sup>[in]</sup> (rev. ll.23-24). Other texts mentioning *šir'am* for slave women are Evetts Ner. 28 and UET 4, 118; in Nbn. 1116, a *šir'am* is given to a slave man, while in NCBT 4692 it is given to *širku* and *zakītu*.

90. This is the case for *šir'am* in dowry texts; cf. Roth 1989-1990, 31.

91. This is the interpretation favored by Janković 2008, 453<sup>109</sup>.

92. YOS 19, 242 is dated to the fourth year of Nabonidus. The prices attested for a túg-kur-ra in that year are: 1 shekel, 2 shekels, and 3.5 shekels (see Jursa 2010, 621). Usually the price of a túg-kur-ra is higher than that of a *šir'am*. This suggests that the price of a túg-kur-ra was around 2.125 silver shekels, that of a *šir'am* around 1.5 shekels.

93. 1 shekel (GC 1, 198), 1.25 shekels (GC 1, 299), 1.5 shekels (NCBT 826), 2 shekels (BM 74398), 3.3 shekels (Camb. 340). In CT 56, 317 a bag-maker (*sabsinnu*), Bēl-šulmu-šukun, receives from the temple of Ebabbar 4 silver shekels for a *šir'am*: 4 gín kù'.babbar *a-na* <sup>túg</sup>*šir-a-a[m]* *a-na* <sup>md</sup>en-šū-lum-šū-kun (ll. 4-5). This is a clear proof that the cost of a *šir'am* was not of 4 shekels, since we need to factor in the labor employed to produce the item.

94. For túg-kur-ra, see YOS 21, 98; for *mušiptu*, see GC 2, 349; for *šir'am*, see BM 78828. The Akkadian term commonly used to indicate groups of people is *šābu* (often in the logographic form <sup>lu</sup>erín); cf. CAD S, 46-55.

context. More importantly, as we have seen, *mušiptu* are regularly featured in apprenticeship contracts. Finally, *šir'am*, like *túg-kur-ra*, were worn by workmen and soldiers, and it appears it was not unusual for them to be worn by slaves, on the evidence of a number of textual sources.

The present essay, following in the wake of S. Zawadzki's study on clothes in non-cultic contexts,<sup>95</sup> is a first attempt to investigate clothes worn by common people in Babylonian society. I hope it will provide a stimulus for further research, confirming or contradicting what I have stated in the previous pages.

### Abbreviations

ADOG	Abhandlungen der Deutschen Orient-Gesellschaft	CM	Cuneiform Monographs
AHw	W. von Soden, <i>Akkadisches Handwörterbuch</i> . Wiesbaden 1965-1981	CT	Cuneiform Texts from Babylonian Tablets in the British Museum
AJSL	<i>American Journal of Semitic Languages and Literatures</i>	CTMMA	Cuneiform Texts in the Metropolitan Museum of Art
AO	tablets in the collections of the Musée du Louvre, Paris	CTMMA 4	I. Spar & M. Jursa, <i>The Ebabbar Temple Archive and Other Texts from the Fourth to the First Millennium B.C.</i> CTMMA 4. New York 2014
AfO	<i>Archiv für Orientforschung</i>	Cyr.	J. N. Strassmaier, <i>Inschriften von Cyrus, König von Babylon</i> . Leipzig 1890
AOAT	Alter Orient und Altes Testament. Neukirchen-Vluyn	Dar.	J. N. Strassmaier, <i>Inschriften von Darius, König von Babylon</i> . Leipzig 1897
BE	Babylonian Expedition of the University of Pennsylvania, Series A: Cuneiform Texts BINBabylonian Inscriptions in the Collection of James Buchanan Nies	EA	J. A. Knudtzon, <i>Die El-Amarna Tafeln</i> . Leipzig 1915
BIN 1	C. E. Keiser, <i>Letters and Contracts from Erech Written in Neo-Babylonian Period</i> . New Haven-London 1917	Evetts Lab.	B. T. A. Evetts, <i>Inscriptions of the Reign of Laborosoarchod</i> . Leipzig 1892
BM	Tablets in the collections of the British Museum	Evetts Ner.	B. T. A. Evetts, <i>Inscriptions of the Reign of Neriglissar</i> . Leipzig 1892
BRM	Babylonian Records in the Library of J. Pierpont Morgan	GC 1	R. P. Dougherty, <i>Archives from Erech, Time of Nebuchadnezzar and Nabonidus</i> . Goucher College Cuneiform Inscriptions 1. New Haven 1923
CAD	The Assyrian Dictionary of the Oriental Institute of the University of Chicago. Chicago 1956-2010	GC 2	R. P. Dougherty, <i>Archives from Erech, Neo-Babylonian and Persian Periods</i> . Goucher College Cuneiform Inscriptions 2. New Haven 1933
Camb.	J. N. Strassmaier, <i>Inschriften von Cambyses, König von Babylon</i> . Leipzig 1890	ITT	Inventaire des tablettes de Tello
CDA	J. Black <i>et al.</i> (eds.), <i>A Concise Dictionary of Akkadian</i> . Wiesbaden 1999-2000	JCS	<i>Journal of Cuneiform Studies</i>
		JSS	<i>Journal of Semitic Studies</i>
		KASKAL	<i>Rivista di storia, ambienti e culture del Vicino Oriente Antico</i>
		N.A.B.U.	<i>Nouvelles assyriologiques brèves et utilitaires</i>
		NBC	Tablets in the Nies Babylonian Collection, Yale University Library
		NCBT	Tablets in the Newell Collection of Babylonian Tablets, Yale University Library
		Nbk.	J. N. Strassmaier, <i>Inschriften von Nabuchodonosor, König von Babylon</i> . Leipzig 1889
		Nbn.	J. N. Strassmaier, <i>Inschriften von Nabonidus, König von Babylon</i> . Leipzig 1887
		OIP	Oriental Institute Publications
		OIP 122	D. B. Weisberg, <i>Neo-Babylonian Texts in</i>

95. Zawadzki 2010.

- the Oriental Institute Collection*. Chicago 2003
- PIHANS Publications de l'Institut historique et archéologique néerlandais de Stamboul
- RA *Revue d'assyriologie et archéologie orientale*
- TC Textes cappadociennes du Louvre (Paris)
- TCL Textes cunéiformes du Louvre
- TU F. Thureau-Dangin, *Tablettes D'Uruk à l'usage des prêtres du Temple d'Anu au temps des Séleucides*. Paris 1922
- UCP University of California Publications in Semitic Philology
- UET 4 H. H. Figulla, *Business Documents of New-Babylonian Period*. Ur Excavations Texts 4. London 1949
- YOS Yale Oriental Series – Babylonian Texts
- YOS 3 A. T. Clay, *Neo-Babylonian Letters from Erech*. New Haven-London 1919
- YOS 6 R. P. Dougherty, *Records from Erech, Time of Nabonidus*. New Haven-London 1920
- YOS 19 P.-A. Beaulieu, *Legal and Administrative Texts from the Reign of Nabonidus*, New Haven-London 2000
- YOS 21 E. Frahm & M. Jursa, *Neo-Babylonian Letters and Contracts from the Eanna Archive*. New Haven-London 2011
- UVB *Vorläufige Bericht über ... Ausgrabungen in Uruk-Warka*
- des Fortifications de Persépolis. État des questions et perspectives de recherches*, 429-464. Paris.
- Joannès, F. (2010) Textile Terminology in the Neo-Babylonian Documentation. In C. Michel & M.-L. Nosch (eds.), *Textile Terminologies in the Ancient Near East and Mediterranean from the Third to the First Millennium BC*, 400-408. Ancient Textiles Series 8. Oxford.
- Jursa, M. (2006) Agricultural Management, Tax Farming and Banking: Aspects of Entrepreneurial Activity in Babylonia in the Late Achaemenid and Hellenistic Periods. In P. Briant & F. Joannès (eds.), *La transition entre l'empire achéménide et les royaumes hellénistique (vers 350-300 av. J.-C.)*, 137-222. Paris.
- Jursa, M. (2010) *Aspects of the Economic History of Babylonia in the First Millennium BC*. AOAT 377. Münster.
- Jursa, M., Paszkowiak, J. & Waerzeggers, C. (2003-2004) Three Court Records, *AfO* 50, 255-268.
- Kümmel, H. M (1979) *Familie, Beruf und Amt im spätbabylonischen Uruk*. ADOG 20. Berlin.
- Labat, R. (1995) *Manuel d'épigraphie akkadienne*. *Revue et augmenté par Florence Malbran-Labat*. Paris.
- MacGinnis, J. (1995) *Letter Orders From Sippar and the Administration of the Ebabbara in the Late-Babylonian Period*. Poznań.
- MacGinnis, J. (2012) *The Arrows of the Sun: Armed Forces in Sippar in the First Millennium B.C*. Babylonische Archive 4. Dresden.
- McEwan, G. J. P. (1985) The First Seleucid Document from Babylonia, *JSS* 30, 169-180.
- Michel, C. & Veenhof, K. R (2010) The Textiles Traded by the Assyrians in Anatolia. In C. Michel & M.-L. Nosch (eds.), *Textile Terminologies in the Ancient Near East and Mediterranean from the Third to the First Millennium BC*, 210-271. Ancient Textiles Series 8. Oxford.
- Nemet-Nejat, K. R. (1999) Women in Ancient Mesopotamia. In B. Vivante (ed.), *Women's Role in Ancient Civilizations. A Reference Guide*, 85-114. Westport, Connecticut-London.
- Oppenheim, A. L. (1950) Review of H. H. Figulla, *Business Documents of the Neo-Babylonian Period*, UET 4, 1949, *JCS* 4, 188-195.
- Paterson, A., 1915. *Assyrian Sculptures: Palace of Sinacherib*, The Hauge, 1915.
- Payne, E. E. (2007) *The Craftsmen of the Neo-Babylonian Period: A Study of the Textile and Metal Workers of the Eanna Temple*, Ph.D. diss. Yale University.
- Quillien, L. (2013) tûg-LUM-LUM = tûg-guz-guz; a new interpretation of the «guzguzu» garment in first millennium BC Mesopotamia, *N.A.B.U.* 2013/1, 21-25.
- Roth, M. (1989-1990) The Material Composition of the Neo-Babylonian Dowry, *AfO* 63, 1-55.

## Bibliography

- Beaulieu, P.-A. (2003) *The Pantheon of Uruk During the Neo-Babylonian Period*. CM 23. Leiden-Boston.
- Bongenaar, A. C. V. M (1997) *The Neo-Babylonian Ebabbar Temple at Sippar: its Administration and its Prosopography*. PIHANS 80. Leiden.
- Borger, R. (1981) *Assyrisch-babylonische Zeichenliste*. Neukirchen-Vluyn.
- Çağırhan, G. & Lambert, W. G. (1991-1993) The Late-Babylonian Kislîmu Ritual for Esagil, *JCS* 43-45, 86-106.
- Dougherty, R. P. (1933) *Archives from Erech, Neo-Babylonian and Persian Periods*. GC 2. New Haven.
- Ebeling, E. (1953) *Glossar zu den Neubabylonischen Briefen*. München.
- Jankovic, B. (2008) Travel Provisions in Babylonia in the First Millennium BC. In P. Briant et al. (eds.), *L'archive*

- San Nicolò, M. (1945), *Festschrift für Leopold Wenger*, vol. 2. München.
- Stolper, M. W. (1985) *Entrepreneurs and Empire. The Murašû Archive, the Murašû Firm, and Persian Rule in Babylonia*. PIHANS 54. Leiden.
- Ungnad, A. (1937) *Neubabylonische Rechts- und Verwaltungsurkunden. Glossar*. Leipzig.
- Veenhof, K. R. (1972) *Aspects of Old Assyrian Trade and its Terminology*. *Studia et documenta ad iura orientis antiquae pertinentia* 10. Leiden.
- Wunsch, C. (2003-2004) Findelkinder und Adoption nach neubabylonischen Quellen, *AfO* 50, 174-244.
- Wunsch, C. & Magdalene, F. R. (2012) A Slave Is Not Supposed to Wear Such a Garment!, *KASKAL* 9, 99-120.
- Zawadzki, S. (2002) Payment in Wool in the Economy of the Ebabbar Temple at Sippar, *RA* 96, 149-167.
- Zawadzki, S. (2006) *Garments of the Gods. Studies on the Textile Industry and the Pantheon of Sippar according to the Texts from the Ebabbar Archive*. *Orbis Biblicus et Orientalis* 218. Fribourg-Göttingen.
- Zawadzki, S. (2008) Nebuchadnezzar's Campaign in the 30<sup>th</sup> Year (575 B.C.): A Conflict with Tyre? In M. Cogan & D. Kahn (eds.) *Treasures on Camels' Humps: Historical and Literary Studies from the Ancient Near East Presented to Israel Eph'al*, 331-336. Jerusalem.
- Zawadzki, S. (2010) Garments in Non-Cultic Context (Neo-Babylonian Period). In C. Michel & M.-L. Nosch (eds.), *Textile Terminologies in the Ancient Near East and Mediterranean from the Third to the First Millennium BC*, 409-429. *Ancient Textiles Series* 8. Oxford.

## Flax and Linen Terminology in Talmudic Literature

Nahum Ben-Yehuda<sup>1</sup>

Material culture data is mentioned in Talmudic (or ‘rabbinical’) literature when a relevant legal (‘*halakhic*’) or homiletic (‘*midrashic*’) context arises. Therefore, certain details may be lacking or ambiguously stated. This however is not presented in a systematic and detailed manner, such as in ‘Pliny’s Natural History’.<sup>2</sup> Additional classical authors mention flax and linen. First and foremost: Diocletian<sup>3</sup> in his edict of maximum prices. And in less scope and detail: Xenophon,<sup>4</sup> Virgil,<sup>5</sup> Strabo,<sup>6</sup> Columella,<sup>7</sup> Pausanias,<sup>8</sup> and Theodosius II<sup>9</sup> – in his codex. In some instances, these sources may be useful for comparison, contrast and clarification – to Talmudic sources.

It is difficult to gauge the exact societal extent of the phenomena mentioned in this literature, however it may be assumed that they can be viewed as a representative sampling, or reliable cross-section of the material culture found in contemporaneous society in

those periods (c. 2<sup>nd</sup> - 5<sup>th</sup> centuries AD) and regions (Land of Israel and Babylonia). This premise is unaffected by the academic disagreement which exists regarding the extent to which Talmudic laws were actually practiced by the general populace outside of the sphere of the Sages themselves. There is, however, academic consensus regarding those aspects of material culture which are described in this literature as reflecting *Sitz im Leben*.

Historiography based upon Talmudic literature source material is a complex and challenging science. It will encompass aspects such as the use of various Aramaic dialects, the identities, backgrounds, times and locales of tradents<sup>10</sup> and the legal and homiletic contexts in which the material culture data is presented. Nevertheless, these are outside of the scope of the current paper, which will focus strictly on material culture itself.

The principal rabbinic works from which data is

1. This research was assisted by grants from the Memorial Foundation for Jewish Culture and “Targum Shlishi” Foundation – for which I am grateful. I offer my thanks to Professor Steven Fassberg, Professor Leib Moskowitz, Dr. Yitzhak Shlesinger, Professor Michael Sokoloff, and Dr. John Peter Wild for their respective good advice and patience with my numerous queries.

2. (23-79 AD) Primarily in book 19, chapters 1-6.

3. (244-311 AD)

4. (430-354 BC)

5. (70-19 BC)

6. (64 BC-24 AD)

7. (4-70 AD)

8. (110-180 AD)

9. (401-450 AD)

10. One who is responsible for preserving and handing on the oral tradition, in this case the Rabbis or “Sages”. Oxford Bible Studies Online.

gleaned include: Mishna, Tosefta, Mekhilta, Sifra, Sifre,<sup>11</sup> Jerusalem Talmud,<sup>12</sup> Babylonian Talmud,<sup>13</sup> Midrash Bereshit Rabba, Midrash Tanḥuma,<sup>14</sup> and Aramaic ‘Targums’<sup>15</sup> of the Pentateuch and Hebrew Bible. Each of these works embodies content originating in various periods, some of them long before the date of their respective final redactions.

Pioneers in this field of Talmudic material culture research in general, and textiles specifically, were Gustav Dalman,<sup>16</sup> R.J. Forbes,<sup>17</sup> Abraham Herszberg,<sup>18</sup> Samuel Krauss,<sup>19</sup> and Saul Lieberman.<sup>20</sup> Since then, our knowledge of Roman-era textiles has been greatly enhanced, due to research advances<sup>21</sup> in the fields of archaeology, botany, iconography and philology. Notable among those whom have contributed to this field are Yehuda Feliks,<sup>22</sup> John Peter Wild,<sup>23</sup> Daniel Sperber,<sup>24</sup> Ze’ev Safrai,<sup>25</sup> and Michael Sokoloff.<sup>26</sup> All of the above will be accounted for in the current paper.

### Flax-linen<sup>27</sup> production: *longue durée*

Reconstruction of the complete flax-linen *chaîne opératoire* may be performed by comparison and cross-checking flax-linen production in the Land of Israel<sup>28</sup> with that in various other regions and periods, such as Ancient Egypt,<sup>29</sup> Roman-era Europe, Asia Minor and Egypt, Roman<sup>30</sup> and Medieval Iberia,<sup>31</sup> and modern-day Northern Ireland and Great Britain,<sup>32</sup> Croatia,<sup>33</sup> Lithuania<sup>34</sup> and Flanders.<sup>35</sup> In light of parallel descriptions, we can deduce that the processes of flax-linen production are a *longue durée* phenomenon with quite similar *chaîne opératoire*, notwithstanding some minor variations. This basis corroborates the Talmudic information, enables filling of any gaps and enhances clarification of ambiguities which may exist therein.

An additional benefit of this deduction is that the implements historically used in the various stages of

11. Final redactions of these five works: 3<sup>rd</sup> century AD, Land of Israel.

12. (Also known as the Palestinian Talmud, or Talmud of the Land of Israel) Final redaction: c. 4<sup>th</sup> century AD, Land of Israel.

13. Final redaction: c. 6<sup>th</sup> century AD, Babylonia.

14. Final redactions: c. 5<sup>th</sup> century AD, Land of Israel.

15. ‘Translations’. Final redactions: c. 3<sup>rd</sup>-5<sup>th</sup> centuries AD.

16. Published 1937.

17. Published 1956.

18. Published 1924.

19. Published 1945.

20. Publications 1939 - 1968.

21. Research in textile history and archaeology has advanced in recent years, partly thanks to research consortia such as CTR, NESAT, Purpureae Vestes, DressID, TRC, CIETA, and the Archaeological Textile Review (ATR).

22. Publications 1963 - 2005.

23. Publications 1963 - present. Several additional publications relevant to this paper are listed in the bibliography.

24. Publications 1974 - present.

25. Publications 1977- present.

26. Publications 1974 - present.

27. The term “flax” in this paper indicates the plant *Linum usitatissimum* and its derived fiber. “Linen” in turn indicates yarn and cloth derived from that fiber. This is in accordance with ASTM Designation: D 6798–02 Standard Terminology Relating to Flax and Linen.

28. Amar 2002 (160, 331, 336, and 340) tracks the cultivation and use of flax in the Land of Israel from the Byzantine Period (330 AD) through the Muslim conquest (640 AD and onwards) and up to the Middle Ages.

29. Vogelsang-Eastwood 1992.

30. Alfaro 1984, 49-58

31. Córdoba De La Llave 1990, 85-93. Veiga de Oliveira 1978, 8-23. In addition, presented there is a detailed essay on modern flax-linen production in Portugal.

32. Warden 1967, 248-680.

33. Cruickshank 2011.

34. Meek 2000.

35. DeWilde 1999.

manufacture, which have indeed become more sophisticated or mechanized with time, but their respective basic functions remain essentially the same. One may choose, therefore, to illustrate Talmudic era production processes with implements from other periods and regions when contemporaneous and local illustrations are not available.

A noticeable exception to the above rule is modern field or dew retting<sup>36</sup> as opposed to historical pool retting. The hot dry climates of Egypt and the Land of Israel<sup>37</sup> proximate to the flax-pulling season do not enable the growth of fungi essential for to this process, in contrast to the respective damp temperate climates of Western and Eastern Europe. Therefore, field retting apparently did not and does not exist in the

regions generally relevant to Talmudic literature.<sup>38</sup>

**Detailed *chaîne opératoire*** (with respective occupational names)

- {1}<sup>39</sup> Soil preparation<sup>40</sup>
- {2} Sowing (**Sower**)<sup>41</sup>
- {3} Weeding (**Weeder**)<sup>42</sup>
- {4} Commerce – of plants currently growing in the field.<sup>43</sup>(**Trader, Merchant**) This procedure is optional, for the flax may be further processed by the farmer (and his family) himself.<sup>44</sup>
- {5} Pulling, uprooting (**Puller**)<sup>45</sup>
- {6} Drying, stooking (**Stooker**)<sup>46</sup> This procedure is optional, for sometimes the flax straw is already

36. Nowadays, pool retting is subject to strict regulation by the European Union, and therefore rarely used. [http://eur-lex.europa.eu/legal-content/EN/TXT/?uri=OJ%3AJOL\\_2014\\_174\\_R\\_0015](http://eur-lex.europa.eu/legal-content/EN/TXT/?uri=OJ%3AJOL_2014_174_R_0015). Criterion 2. Flax and other bast fibres. The historical record of dew-retting is currently obscure.

37. Pausanias, *Elis I*, v. 2-5: “The fine flax of Ellis (Approximately 38° N. latitude, 70 M elevation) is as fine as that of the Hebrews, but it is not so yellow.” Assumedly he is referring to the flax fiber. Pool-retted flax in the hot climate of the Land of Israel (Beth Shean is 32.5° N. latitude, 121M **below sea level** elevation) produces blond-colored fibers. Dew-retted fibers range in color from ecru through dark gray. (NBY) See Carter 1920, 32: Different colors of flax under various water-retting conditions.

38. Freckman 1979, 91-102: Retting could be undertaken in ponds or tanks – or simply by long exposure in the fields. Dew retting in the climatic conditions of modern and historical Mesopotamia is a topic which has not yet been researched (NBY).

39. For the significance of the various types of parentheses and brackets used in this paper, see “**Symbols**” *infra*.

40. Pliny, Book 19, chapter 2: “Flax is chiefly grown in sandy soils, and with a single ploughing. No other plant grows more quickly: it is sown in spring and plucked in summer, and owing to this also it does damage to the land.” Bradbury 1920, 39-41. Carter 1920, 19. DeWilde 1999, 19-22.

41. Columella Book II. x.17: “Flax-seed should not be sown unless it yields a heavy crop and brings a good price in the region where you farm; for it is particularly hurtful to land. For this reason it requires a soil which is very rich and moderately moist. It is sown from the first of October to the rising of Aquila, which falls on the seventh day before the Ides of December 6. An *iugerum* of land is sown with eight modii of it. Some hold that it should be sown in poor land, and very thickly, so that the flax may grow with a more slender stem. The same people also say that if it is sown in rich ground in February, ten modii should be broadcast to the *iugerum*.” Vogelsang-Eastwood 1992, 5 mentions that flax is sown in Egypt in mid-November. That is nearly identical to the sowing date in the Land of Israel, in contrast to Spring sowing in many other regions. DeWilde 1999, 32-29. Feliks 1963, 149 examines the dates for sowing flax in the Land of Israel. On p. 156 he discusses the proper density of seeds necessary to obtain the desired non-branching plants.

42. Columella Book II. xii.5: “Eight or ten *modii* of flax seed are sown with four days ploughing, harrowed with three days’ work, weeded with one, and pulled with three, the total amounting to eleven days’ work.”

43. Wipszycka 1965, 45-46 mentions merchants and trade of “raw materials” in flax context. The exact stage of production is not indicated, and could vary. DeWilde 1999, 203. See: *infra* **Temporary and auxiliary professions: commerce**.

44. Safrai 1994, 229; “A number of sources also indicate that the wife of a farmer, who raised sheep or cultivated flax, would sell clothes woven from either wool or linen.” Presumably, she herself either performed the labors herself or supervised them being performed on site.

45. Pliny, Book 19, chapter 3: “With us the ripeness of flax is ascertained by two indications, the swelling of the seed or its assuming a yellowish color. It is then plucked up and tied together in little bundles each about the size of a handful, hung up in the sun to dry for one day with the roots turned upward...” Vogelsang-Eastwood 1992, 45 provides an illustration of Ancient Egyptian flax pulling. DeWilde 1999, 49-64. Feliks 1963, 197-198 examines the dates for pulling flax in the Land of Israel. On p. 219 emphasis is placed on the method of harvesting – by pulling, not cut with a sickle as grain crops.

46. Bradbury 1920, 80-81. DeWilde 1999, 65-66.

- dry when pulled and suitable for retting, or is retted while still moist.
- (7) Binding, stacking, storing (with seed bolls still attached to their stems).<sup>47</sup> This procedure is optional, for the flax straw may be deseeded and retted immediately after pulling.
- (8) Transport of the flax straw to site of deseeding.<sup>48</sup> Transport in antiquity was executed by porter, donkey or camel.<sup>49</sup> This procedure is possible, not mandatory, as deseeding may be performed on-site, without need for transport at this stage. (**Porter, Cameleer, Donkey driver**)<sup>50</sup>
- (9) Commerce – in pulled and dried flax straw. This procedure is possible, not mandatory, as further stages of production may be performed by the farmer himself. (**Trader, Merchant**)
- [10a] Crushing seed bolls [with a mallet] – to de-seed before retting (the retting process would ruin the seeds, rendering them unusable for sowing the next year).<sup>51</sup> (**Crusher**)
- [10b] Rippling [with a “ripple”- a comb with widely spaced tines] seed bolls from the remainder of the flax plant, to deseed before retting.<sup>52</sup> Sometimes flax straw is retted without deseeding, either when the seeds are immature due to early pulling (in order to obtain very fine fibers), or when new seeds are purchased to sow each year, rendering deseeding extraneous.<sup>53</sup> Only one of the above two procedures is performed.<sup>54</sup> (**Rippler**)
- {11} Rebinding – in preparation for subsequent pool retting.<sup>55</sup>
- [12a] Pond (or: pool, pit) retting (or: steeping, watering<sup>56</sup>).<sup>57</sup> In this process, bacteria such as *Clostridium butyricum* and/or *Clostridium pectinovorum*<sup>58</sup> which are naturally present in the environment multiply and create a culture, in turn producing the enzyme pectinase which dissolves the naturally-occurring pectin present in the flax stalks and has glued the fibers together. Only after this procedure, can the further processing of the flax
47. DeWilde 1999, 67-73.
48. DeWilde 1999, 74-79.
49. Safrai 1994, 289 calculates the respective mass of each method’s maximum load while transporting wheat. Figures for flax (at different stages of production) may be different due to its reduced specific gravity (especially retted and dried flax straw). Porter – 42.7 liters (= 32 kg). Donkey – 128 liters (= 96 kg). Camel – 256 liters (= 192 kg). Safrai 1995, 190 comments that commerce between the small villages was enabled by transporting goods via camel-train or donkey-train. In this paper, we will quote Talmudic passages which mention the transport of flax (at some stage of production) by porter, by donkey and/or by camel.
50. The above methods of overland transport are all mentioned in Talmudic literature. See: Sperber 1976, 113-114, 123-125, and 133-136: Re transport of goods by boat to and from Egypt. Flax and linen in various stages of production were exported and imported between the Land of Israel and Egypt. The commerce and transport of flax-line via inland waterways (The Sea of Galilee, The Dead Sea, or The Jordan River) and the coastal seaways of the Mediterranean (between locales in the Land of Israel, e.g. Jaffa and *Caesarea Maritima* or Acre, or to and from Asia Minor, the Aegean Sea, and Rome) and the Red Sea require additional research.
51. Dewilde 1999, 82-86.
52. See Georgacas 1959, 259: ξελιπίζω “beat the dry flax so that its seeds fall away”. DeWilde 1999, 86-94.
53. Warden 1967, 18: “If good seed is required for future sowing, a little of the flax should be allowed to remain after the bulk of the crop is pulled, that it may ripen fully, and yield seed with the germinating principle really in it.” Carter 1920, 19: Preservation of the seeds for future sowing may be unimportant. Feliks 1968, 282, and Feliks 2005, 262: Flax seeds were used for food, but since this use requires later pulling - after the seeds have ripened - it damages the crop which is primarily intended for its fine fibers, it was therefore discouraged. Flax seed oil for consumption as food and use in oil lamps was used in Asia Minor during this period, but is not mentioned in Talmudic literature – NBY. See: Ertuğ 2000, 171-185.
54. Weindling 1947, 238 suggests that rippling is done if the straw is green and crushing if the straw is dry. If the green seed bolls are rippled, they will have to be dried and subsequently threshed.
55. Carter 1920, 28: Flax straw is carted to the retting dam.
56. Hann 2005, 8-9. DeWilde 1999, 103-126.
57. Pliny Book 19, Chapter 3: “...the actual stalks of the flax are plunged in water that has been left to get warm in the sun, and a weight is put on them to press them down, as flax floats very readily. The outer coat becoming looser is a sign that they are completely soaked, and they are again dried in the sun, turned head downwards as before...”. Theodosius (NVal 13-1) mentions municipally operated flax steeping in Numidia (Tunisia).
58. Hellinger 1951. Rahman 1963. Kozłowski 2012, 70-71.



be done. Removal of the flax straw from the retting liquor must be done at the proper time, by an expert. Early removal, while the flax is still under-retted, will render fiber separation impossible. Second-retting can rectify this situation, but is obviously time and money-consuming. Late removal from retting will cause the fibers themselves to be damaged (a state which is irreversible) by the enzyme and unfit for further use. The retting process is malodorous, and the acidic effluent<sup>59</sup> may leach into adjacent soil thus causing damage to crops. (**Retter**)

[12b<sup>1</sup>] Drawing (or pulling out) of the retting pond, and transport to the drying area.<sup>60</sup>

[12b<sup>2</sup>] Ringing out the excess retting fluid, to expedite drying.

[12c] Dew (or field) retting. In this process, fungi such as *Alternaria alternate* or *Alternaria linicola* reproduce in warm and moist conditions, and disintegrate the pectin of the flax straw, enabling subsequent fiber separation.<sup>61</sup> This method is suitable in some European and Russian climates and is widely used in modern production, in place of pond-retting. Egypt and the Land of Israel are both unsuitable for this manner of retting, due to their respective hot and arid climates, which deter fungus growth, adjacent to the season of flax pulling.

{13} Drying (or: grassing, spreading) and gaiting (erecting ‘chapels’, and subsequent rebinding). Drying is essential after pool retting, before subsequent processes of fiber separation.<sup>62</sup>

{14} Transport – to (and from) the scutching mill. In antiquity, this was executed by porter, camel or donkey. This procedure is possible, not mandatory, for scutching may have been done adjacent to the retting pool. (**Porter, Cameleer, Donkey driver**)

{15} Commerce – of retted and dried flax straw. Again, this procedure is possible, not mandatory,

as subsequent fiber processing may be done by the retter himself. (**Trader, Merchant**)

{16} Breaking (or ‘braking’) – preliminary separating of the flax fibers by breaking up the woody parts of the stalks, using a mallet or similar implement.<sup>63</sup>(**Braker**)

[17a] Roughing – combing or hackling by hand to remove woody impurities and short fibers and to square them on the root end thereby producing a piece of flax which could be gripped by the hacklers with improved yields as result.<sup>64</sup> Apparently, this terminology and separate procedure were traditionally used only in Northern Ireland, and in other regions would be included in scutching. (**Rougher**)

[17b] Scutching – scraping, batting, shaking and/or flailing the flax fibers to begin their alignment and remove remaining woody impurities and short fibers.<sup>65</sup> The product of this procedure is “scutched line” (long fibers) and the by-products produced are “scutched (coarse) tow” and coarse shives. (**Scutcher**)

{18} Hackling – combing the scutched flax fibers in series of ‘hackles’ (combs) with increasingly compact tines, to remove the remaining short fibers and shives, and to straighten them in preparation for spinning. The product of this procedure is ‘hackled line’ (long fibers), and the by-products are ‘hackled (fine) tow’, and fine shives. In modern industry, the hackled line is converted into continuous ribbons – ‘sliver’, and subsequently given a slight twist – ‘roving’, in preparation for spinning.<sup>66</sup> (**Hackler**)

{19} Transport – to the spinning mill. (**Porter, Cameleer, Donkey driver**) An optional procedure. In antiquity, it is possible that most or all of the intermediate stages of production were done in the same vicinity, by the farmer and his laborers.

59. Kempa & Bartoszewski 1992, 515-517.

60. DeWilde 1999, 133, 136, and 140.

61. Kozłowski 2012, 71-72. DeWilde 1999, 100-103.

62. Carter 1920, 45. DeWilde 1999, 126-133.

63. Pliny Book 19, Chapter 3: “...afterwards when thoroughly dry they are pounded on a stone with a tow-hammer.” DeWilde 1999, 151-161.

64. Carter 1920, 73. Weindling 1947, 255-256. Elaine Flanigan, Keeper of Collections, Irish Linen Center, Lisburn, NI – personal correspondence.

65. DeWilde 1999, 162-188.

66. DeWilde 1999, 192-197.

{20} Commerce – line, tow, and shives.<sup>67</sup> Commerce at this stage is optional, as above. (**Trader, Merchant**)

{21} Spinning. In antiquity, as today, flax was often wet-spun, utilizing water or saliva to soften the fibers. This will produce a finer quality yarn, and in turn finer cloth. In modern industry; ‘line’ (long fiber) is spun wet,<sup>68</sup> dry or semi-wet; and ‘tow’ (short fiber) is usually spun dry. Plying (or: ‘doubling’) may also be done wet for certain applications.<sup>69</sup> (**Spinner**)

{22} Transport – as above, to the weaver. (**Porter, Cameleer, Donkey driver**)

{23} Commerce – in spun yarn.<sup>70</sup> (**Trader, Merchant**)

{24} Weaving<sup>71</sup> (**Weaver**)

{25} Boiling (and bleaching) – may be done at different stages of production: hackled fiber (in modern industry – sliver or roving<sup>72</sup>), spun yarn, or as a post-loom process to woven cloth.<sup>73</sup> Boiling, which is an integral part of some historical and modern production processes - and is often integrated with bleaching,<sup>74</sup> softens the fiber and further dissolves remaining impurities such as pectin and wax, and thus enables a finer yarn to be spun. When performed after weaving, this improves the handle of the woven cloth.<sup>75</sup> (**Bleacher, Boiler**)

{25a} Beetling<sup>76</sup> – woven cloth may be (wetted and subsequently) beaten with a mallet or similar implement, in order to provide it with a smoother

tactile surface and visual sheen. Pliny the Elder mentions that, in antiquity, this was also done to yarn. In the modern era, this is considered a procedure characteristic to Northern Ireland.<sup>77</sup> (**Beetler**)

{25b} Polishing – rubbing with a glass, stone or bone implement to give smoothness and sheen to the cloth. Initially this may be performed after weaving and subsequently after each laundering. In the medieval period this was practiced in Western Europe, and in the early-modern era, is considered a characteristically Scandinavian procedure.<sup>78</sup>

{26} Transport of woven cloth.<sup>79</sup> (**Porter, Cameleer, Donkey driver**)

{27} Commerce of woven cloth. (**Trader, Merchant**)

{28} Rope, cord and twine manufacture – by two possible different methods: ‘laying’ (or: ‘twisting’)<sup>80</sup> or ‘plaiting’ (or: ‘braiding’).

{29} Production of other end products – nets, garments, and various textile applications.

{30} Laundering and post-laundry treatment of linen textiles.

### Linguistic and etymological fundamentals

This paper focuses on the Hebrew and Aramaic language flax production terminology in Talmudic literature. Nevertheless, the language of the Hebrew Bible is a predecessor dialect, and will be presented herein. Standard Biblical Hebrew (SBH) is the stratum of

67. Curchin 1985, 35 quotes Diokletian 32.26 that “raw flax was purchased in bundles”, but this partial text offered by Graser 1959, 416, is omitted by Lauffer 1971. DeWilde 1999, 200-201.

68. Carter 1919, 213-239.

69. Sándor Nagy, managing director, Hungaro-Len spinning mill, personal correspondence. In addition, fine linen spun threads may be cold-water polished. Plyed linen twines may be hot-water polished with added starch.

70. Marzuq 1955, 39 – yarn merchants. Curchin 1985, 35 – barter of spun skeins.

71. Wild 1967, 656 mentions “*linyphi*” – the linen-weavers of Scythopolis, as liable to the state levy (*publico canon obnoxii*).

72. Hann 2005, 17.

73. Bleaching and beating woven cloth in Ancient Egypt: Allgrove-McDowell 2003, 36.

74. Woodhouse 1928, 261-273. Hann 2005, 24-26.

75. Wild 2003, 102 “flax boilers”. Carter 1920, 97. Kernaghan & Kiekens 1992, 343-445.

76. Pliny book 19, Chapter 3: “...Then it (the fiber) is polished in the thread a second time, after being soaked in water and repeatedly beaten out against a stone, and it is woven into a fabric and then again beaten with clubs, as it is always better for rough treatment.”

77. Woodhouse 1928, 308-320. Carter 1920, 98. Hall 1957, 131-134.

78. Macquet 1990, 319-334. Scott 1953-1955, 226-227. Steppuhn 1998, 74-76. Noss 1976. My thanks to Professor Eva Andersson Strand for her assistance with this topic.

79. Theodosian Code 8.5.48: “(Coarse) linen and cloaks... shall no longer be dispatched by carriages but by (express) postwagons or boats... But the other delicate garments and the (fine) linen for cloaks... shall be sent by (express) carriages... The additions in parentheses are after Wild 1967, 662. Forbes 1956, 43 mentions that in Ancient Egypt flax was transported in bundles or bales.

80. Denton & Daniels 2002, 41, 194, and 286-287.

language used in the relatively early books of the Hebrew Bible, prior to the Babylonian exile, and often embodies Egyptian loanwords. Late Biblical Hebrew (LBH) is used in relatively late books of the Hebrew Bible, during and after the Babylonian exile, and is increasingly influenced by Aramaic.<sup>81</sup> In these two linguistic strata, there are several different terms referring to flax-linen.

### SBH terminology of flax-linen

#### **Bād**<sup>82</sup>

Etym: Of unknown etymology.<sup>83</sup>

Selected HB pericopes:

He shall be dressed in a sacral **bād**<sup>84</sup> tunic, with **bād** breeches next to his flesh, and be girt with a **bād** sash, and he shall wear a **bād** turban...<sup>85</sup> (Leviticus 16:4)

Samuel was engaged in the service of the Lord as an attendant, girded with a **bād** ephod. (I Samuel 2:18)

One said to the man clothed in **bādīm**,<sup>86</sup> who was above the water of the river... (Daniel 12:6)

It is currently impossible to discern the textile differentiation between this and the term **šeš**, both of which have the identical LBH (and Targumic) parallel – **būš** (*infra*).

**Kūtōnet** > **Kūtōnōt**. Construct state: **Kʾtōnet** > **Kōtnōt**  
Etym: This term originates from the Akkadian *kītū*, *kītītū*, *kītīntu* – linen, flax, or linen garment; and the Aramaic *kītan*.<sup>87</sup> It subsequently became the Greek *χιτών*, and later the Latin *tunic* – after metathesis.<sup>88</sup> It is the name of a garment, originally made of linen, but later on became a generic name for a shirt-like tunic made of any textile material.<sup>89</sup> Sometimes a modifier is used<sup>90</sup> to specifically indicate a linen garment.<sup>91</sup>

Selected HB pericopes:

And the Lord God made skin **kōtnōt** for Adam and his wife, and clothed them. (Genesis 3:21)

You shall make the fringed **kʾtōnet** **šeš**... (Exodus 28:39)

He shall be dressed in a sacral **kʾtōnet** **bād**... (Leviticus 16:4)

**Nʾōret**<sup>92</sup> – flax tow. Short fibers, often with remnants of shives, usually of lesser value.<sup>93</sup>

81. Hurvitz 2014, 3-4.

82. **Bād** is a homonym in HB with four meanings: 1) linen cloth, 2) a branch or pole, 3) a part or portion, 4) a lie, boasting. Apparently there is no connection between them. Nevertheless, Murtonen 1990, 105 suggests that all shades of meaning are derived from the basic notion of separation, and the word for fine linen fits that pattern on the assumption that it originally referred to a *piece* of linen.

83. HALOT 1994, 109. Gesenius 1987, 105. Grntz 1975, 13-15 Identifies a rare, archaic Egyptian term for a hard stiff cloth. Dickson 2006, 47: [bDA] stiff roll of linen.

84. TO (Pentateuch), TY (Prophets) both consistently translate **bād** as **būš**, or the determined **būšā**. The term **bād** is not used independently in Talmudic literature, excluding Biblical quotes and their respective Talmudic discussions.

85. LXX, VUL, KJV, NIV: linen. RVR: lino. LUT: leinenen.

86. Masculine plural form

87. Gesenius 1987, 480-481. Murtonen 1990, 241-242.

88. Kutscher 1961, 98.

89. HALOT Vol. 2, 505

90. Presumably, all of the **Kūtōnōt** mentioned in priestly vestments' context (Exodus, Leviticus, Ezra, and Nehemiah) are made of linen. Additional **Kūtōnōt**, mentioned in Genesis, Exodus, and II Samuel may not be linen. Ezekiel Ch. 44 describes these priestly vestments using the term **bīgdei pīšīm**, and does not use the term "kūtōnet". Ezekiel also uses the alternative terms: **Šeš** (16:10, 16:13, 27:7) and **Būš** (27:16) albeit in other contexts.

91. The Aramaic Targums - Onqelos, Neofiti and Pseudo-Yonatan - of the Pentateuch consistently translate this term using the respective parallel Aramaic forms e.g. **Kītūnā**, **Kītūnīn**, **Kōtnān**, etc.

92. TY consistently translates this term **kītānā**. **Nʾōret** (and its Aramaic parallel **dāqtā**) appear in Talmudic literature in several contexts (*infra*).

93. The production of hemp and jute fibers also creates tow. These textile materials are not present in HB *Sitz im Leben*. The contexts of hemp in Talmudic literature infer to its production process being similar to that of flax.

Etym:<sup>94</sup> Something which is shaken out or shaken off, as is done in scutching and hackling.<sup>95</sup>

HB pericopes:

... Whereat he pulled the tendons apart, as a strand of **n<sup>o</sup>ōreṭ** comes apart at the touch of fire...<sup>96</sup> (Judges 16:9)

Stored wealth shall become as **n<sup>o</sup>ōreṭ**, and he who amassed it a spark; and the two shall burn together, with none to quench. (Isaiah 1:31)

### Pšt

Etym: This is the basic consonantal form of a Semitic term, a primary noun.<sup>97</sup> It is found in the non-vocalized Gezer Calendar from 10th century BCE.<sup>98</sup> Its vocalized variants are as follows:

a) **Pešet** – “flax”. In HB, found only in Hosea. This is a dialectic variation, possibly of Phoenician influence.<sup>99</sup>

... I will go after my lovers, who supply my bread and my water, my wool and **pīštī**,<sup>100</sup> my oil and my drink. (Hosea 2:7)

b) **Pīštā**

1) A collective, comprehensive designation – “all of the flax”, or “flax in the field”.<sup>101</sup>

Now the **pīštā** and the barley were ruined, for the barley was in the ear and the **pīštā** was in bud.<sup>102</sup> (Exodus 9:31)

2) *Nomen unitatus*– *i.e.* a single example of a class – “a flax fiber”, “a flax plant”.<sup>103</sup>

... they lay down to rise no more, they were extinguished, quenched like **pīštā**.<sup>104</sup> (Isaiah 42:17)

c) **Pīštīm** – linen. This morphological plural-like form indicates a natural/raw product when represented in a manufactured condition.<sup>105</sup>

Selected HB pericopes:

The cloth, whether warp or woof, in wool or **pīštīm**, or any article of leather in which the affection is found, shall be burned...<sup>106</sup> (Leviticus 13:52)

... Go buy yourself a loincloth of **pīštīm**, and put it around your loins...<sup>107</sup> (Jeremiah 13:1)

They shall have **pīštīm** turbans on their heads and **pīštīm** breeches on their loins...<sup>108</sup> (Ezekiel 44:18)

94. HALOT, 707-708, Kadari 2006, 721 “refuse of the flax”, “something small(er)”, Gesenius 1987, 654. Murtonen 1990, 254-255 “*ofall* (tow, scraps, chips)”. Also known as “oakum”. [http://www.etymonline.com/index.php?allowed\\_in\\_frame=0&search=oakum](http://www.etymonline.com/index.php?allowed_in_frame=0&search=oakum)

95. A probable BT synonym, and certain Syriac synonym – “*s<sup>o</sup>rāqt<sup>o</sup>ā*” – indicates “something which has been combed out”. DJBA 833, ASR 1051.

96. Cf. Judges 15:14 for similar phrasing, albeit the text uses the term **pīštīm** and TY translates **kītānā**.

97. HALOT, 983.

98. Borowski 2002, 34-35. Gil<sup>o</sup>ad 1976, 543-549. Talmon 1968, 3-14. Amar 2012, 57-58.

99. Murtonen 1990, 351. Morag 1995, 82, 103.

100. “... my flax”. With suffixed possessive pronoun – first person. Also *Ibid.* verse 11. TY translates both as **būš**.

101. Kautsch 1966, 394. HALOT *ibid.*

102. TO translates **kītānā**.

103. Kautsch *ibid.* HALOT *ibid.*

104. JPS translates “a wick”. Also *Ibid.* 42:3. TY translates both occurrences **būšīm** (plural form).

105. Kautsch 1966, 400.

106. TO consistently translates **pīštīm** as **kītān** or the determined **kītānā**.

107. TY translates **pīštīm** as **kītān** (or the determined **kītānā**) or **būš**. In contrast to TO’s translation consistency, *i.e.* **pīštīm** = **kītān**. We have not found the key to resolve which translation was chosen by TY for each specific context.

108. LXX, VUL, KJV, NIV: linen. RVR: lino. LUT: leinenen. Examination of the Aramaic Targums to the HB indicates that **šeš**, **bād**, **būš**, and **pīštīm** (and **kītān**) are interchangeable terms, thus casting doubt upon English translations of “fine linen” or “white linen” vs. (plain) “linen” in various contexts. The Aramaic Targums’ collective advantage over other translations is their continuous diachronic tradition of Biblical Hebrew.

**Šeš**<sup>109</sup>

Etym: An Egyptian loanword – šš with the clothing determinative.<sup>110</sup>

Selected HB pericopes:

... Pharaoh put it on Joseph's hand; and he had him dressed in robes of šeš<sup>111</sup>... (Genesis 41:42)

You shall make the fringed tunic of šeš. You shall make the headdress of šeš.<sup>112</sup> (Exodus 28:39)

... Her clothing is šeš and royal-purple. (Proverbs 31:22)

indicates that it is a newcomer on the Akkadian linguistic scene ... Although its ultimate origin has not yet been definitely established, its geographical diffusion points to a northern milieu."<sup>114</sup> Or, a *Kulturwort* of unknown origin.<sup>115</sup>

Selected HB pericopes:<sup>116</sup>

... with a magnificent crown of gold and a mantle of būš and royal-purple.<sup>117</sup> (Esther 8:15)

... and the families of the būš factory at Beṭ-ʿašbea<sup>118</sup> (I Chronicles 4:21)

All the Levite singers, Asap, Heman, Yeduṭun, their sons and their brothers, dressed in būš.<sup>119</sup> (II Chronicles 5:12)

**LBH terminology****Būš** – The LBH parallel to **Šeš** and **Bād**.<sup>113</sup>

Etym: “The distribution pattern of the Akkadian *bušu*

109. Šeš appears only once independently (not as an explanation of a Biblical text) in Talmudic literature. Tosefta Tractate M<sup>o</sup>naḥoṭ 9:17, in context of the raw materials used to produce articles required for use in the Temple. This subchapter states that “šeš” (*sic*)—required for priestly vestments – is **pištān** (flax), and if they are produced from **qanabūs** (hemp), they are unfit (and therefore forbidden) for use. I am not aware of an explanation for the use of this term there. **Qanabūs** is familiar to the Mishnah (Tractates Kīlʿayīm 9:1 and N<sup>o</sup>gaʿīm 11:2) as a textile fiber similar to flax.

110. Lambdin 1953, 155. Murtonen 1990, 439. Kadari 2006, 1150. Gesenius 1987, 1534. HALOT, 1663 entry III: “Homonymous with the Egyptian loanword for limestone alabaster. Both share the same property in that they are dazzling white.” Loanwords may change from their exact original meaning in transition from the donor language to the recipient language. Therefore, šeš in HB may not necessarily be “dazzling white”. Actually, the color **white** is not mentioned in context with garments anywhere in the HB, as it is in other contexts, e.g. “teeth” (Genesis 49:15), “manna” (Exodus 16:31), skin and hair affections (Leviticus 13 *passim*). Notably, Mishna Yoma chapters 3 and 7, indeed describes the high-priest’s vestments used on the Day of Atonement as being **white**, in contrast to his daily vestments which are multi-colored. Rabbinic literature does not define the degree of whiteness of these garments, as it does regarding affections of the skin. (Mishna N<sup>o</sup>gaʿīm Ch. 1, 1.)

111. TO (Pentateuch), TY (Prophets), and the Targum of Proverbs – all consistently translate šeš as būš, or the determined būša.

112. LXX, VUL, KJV, NIV: fine linen. RVR: lino. LUT: weißer Leinwand.

113. Hurvitz 2014, 50. TO (Pentateuch) and TY (Prophets) – all consistently translate šeš and bād (in their textile contexts) as būš, or the determined būša.

114. Hurvitz *Ibid*.

115. Murtonen 1990, 108. Gesenius 1987, 132.

116. This term is used in Talmudic literature rarely, and in only three specific contexts: 1) The white vestments of the High Priest, worn during his parts of his service in the Jerusalem Temple on the Day of Atonement, (Mishna Yoma Chapter 3, subchapters 4 and 6, and parallels in Sīfrā and the Talmuds), 2) The curtain or screen (**sādīm**) used in the Temple on that same day to conceal the High Priest while he is doffing and donning his vestments. (*Ibid*. Chapter 7, subchapter 1, and 3) A curtain used in the Temple to conceal the procedure in which a women suspect of adultery (“**sōṭā**”) has her head bared. (Numbers 5:18, Sīfrei BaMīdbar chapter 11) This philological phenomenon may be explained thus, that both the **Yoma** and **Sōṭā** respective ceremonies’ descriptions are relatively ancient literary works – from the second Temple period – in relation to most other content in Talmudic literature (Melamed 1973, 61-62). Therefore, ancient second Temple biblical terminology was selected, instead of the regular Mishnaic **pištān**. A *hapax* is the *Nomina agentis* used in Geonic literature – būšaʿei *infra*.

117. Parallel to Genesis 41:42 *supra*.

118. A guild, factory or workshop. Demsky 1966, 213-214

119. Parallel to Leviticus 16:4 *supra*. LXX: linen. VUL, NIV: fine linen. KJV: white linen. RVR: lino fino. LUT: feiner Leinwand. We have commented (*supra*) on this usage.

### Talmudic terminology

The evolutionary process of the regular Rabbinical Hebrew term for flax-linen **pištān** – is as follows. The HB term **pištā** was adopted as the basis, and subsequently the final character “nun” was added to close the ultimate open syllable.<sup>120</sup> This is a familiar linguistic-phonetic phenomenon in later Hebrew dialects. Following are several similar examples:

- Pištā (Exodus 9:31) ► Pištān (RH passim)  
 Y<sup>h</sup>hūdā (Genesis 29:35, passim) ► Yūdān (RH passim)  
 Kaisāreia (Greek) ► Qesārī (RH passim)  
 ► Qesārīn (RH passim)  
 Sepphoris (Greek) ► Šipōrī (RH passim)  
 ► Šipōrīn (RH passim)  
 M<sup>g</sup>iddō (Joshua 12:21, passim) ►  
 M<sup>g</sup>iddōn (Zekhariah [LBH] 12:11)  
 ► Ἀρμαγεδών (LXX NT Revelations 16:16) ► Armageddon (KJV *ibid.*)  
 Š<sup>l</sup>ōmō (II Samuel 12:24, passim) ►  
 Šlemun (Syriac) ► Σαλωμών (LXX passim) ► Solomon (KJV passim)

Unfortunately, the HB differentiation between flax and linen is lost in Mishnaic Hebrew. **Pištān**, as well as **kītān** in Aramaic, indicate both flax and linen, and therefore require a suitable interpretation in each context.

Modern languages vary in this same aspect:

Some differentiate:

- English: Flax – Linen  
 Hungarian: Len – Vászón  
 Swedish: Lin – Linne  
 German: Flachs – Leinen  
 Dutch: Vlas – Linnen

Others do not differentiate:

Spanish: Lino

Russian: “лѣн” - in transcription [le<sup>3</sup>n]<sup>121</sup>

In the continuation of this linguistic process, the noun **pištān** may become adjectival by *nisba*<sup>122</sup> form, *i.e.* the addition of the suffix “-ī”, hence “**pištānī**” – flaxen,<sup>123</sup> or “related to flax”. By addition of “man”, in Hebrew – “<sup>ʔ</sup>š”, “<sup>ʔ</sup>š pištānī” = “a man dealing with flax”. With nominalization, “<sup>ʔ</sup>š” is omitted, and “**pištāni**” retained, now forming an occupational name (*Nomina agentis*). The occupational name does not indicate what specific activity is done, *e.g.* flax-farmer, flax-worker, flax-producer, flax-trader or flax-transporter – only “**flaxman**” or “**flaxist**”, quite similar to the Spanish “linero”. Again, additional information must be gleaned from textual context, and may be translated using periphrasis. The Aramaic parallel to **pištāni** is **kītānāi**.<sup>124</sup> There are additional forms of occupational names in Hebrew, *e.g.* qāṭṭāl, qatlan, qatōl, and the use of the participle - qōṭel.<sup>125</sup> All have applications in our context.

### Glossary of Talmudic flax-linen terminology<sup>126</sup>

The terms are arranged in accordance with the stages in the *chaîne opératoire* with which they are affiliated. When a number of possible affiliations are applicable, such will be indicated.

Selected quotes from rabbinic literature will be cited.

### Procedures

Entries are presented alphabetically,<sup>127</sup> in Semitic tri-consonantal<sup>128</sup> verbal root form.

120. This process is referred to as “nunation”. Ben-Ḥayim 1972, 46: This is not an actual “nun”, but “nasalization”. Nevertheless, the common pronunciation is “n”. (NBY)

121. This information was provided by Professor Igor Uschapovsky, All-Russian Research and Engineering Institute for Flax Production.

122. Hilman 2016: The gentilic suffix <sup>ʔ</sup>-ī (sometimes referred to by the Arabic term *nisba*) is used to form adjectives that denote some form of relation, such as affiliation, origin, or numerical order.

123. *Cf.* silk – silken, wood – wooden, wool – woolen.

124. More on this topic *infra*.

125. Bendavid 1971, 441, 445, 446. Gross 1994, 265.

126. The transliterations of Talmudic texts in this paper are vocalized generally accordant to Sokoloff 2012, Melamed 1992, Jastrow 1903 or Kohut 1878.

127. <sup>ʔ</sup> (aleph) and <sup>ʿ</sup> (ayin) are placed before “a”. Subsequently: b, c, d, g, h, ḥ, k, l, m, n, p, q, r, s, š, ś, š, t, ṭ, w, y, z.

128. Also referred to as **trilateral**. Occasionally, the verbal root form is **quadrilateral**.

**ʾrg** (Hb) ± **mḥy**, **nwl** (Ar). To weave linen, wool,<sup>129</sup> etc. Literally – “to beat-up (weft insertions)<sup>130</sup>”. “... I told him, to buy flax (“leʿerōg”) to weave...” (Midrash Tanḥūmā Wāyeleḵ 2). “‘ōbād māḥei” (weaver’s<sup>131</sup> work) of the linen tunics... (TO Exodus 39:27). A certain woman when she (“māḥya”) beats-up on the Sabbath is liable for the labor of weaving (JT Šabbat 10g). DJPA 300, DJBA656, 735. {24}

ʿly↓šly  
 ʿqr↓tlš  
 ʿzl↓ṭwy  
 bqʿ↓pšl

**dqq** (Ar). 1) To make thin (or fine) by beating (or rolling out). {25a}{25b} “Rāḥā permitted to beat (“lʾmedāq”) rough-cloth garments (“šādreī”) during the intermediate days of the festival” (BT Bāḥā Mʾšiʿā 60b). 2) Braking flax stalks. “Flax which is braked (“dāyīq”) but not (yet) scutched.” (BT Šabbat 20b) {16} DJBA 349.

± **nqš** (Hb, Ar). To hammer, beat (beetle), pound.<sup>132</sup> {16}{25a} “This pīštānī (flax worker), when he knows that his flax is good... the more he beats (“māqīš”) it, the more it shines...” (Bereshit Rabba 32:3, Codex Vatican 30). DJBA 776. DJPA 361.

± **ktš** (Hb, Ar). To “pestle”<sup>133</sup> (pound and rub, to apply pressure and friction). {16}{25a}{25b} “This pīštānī (flax worker), when he knows that his flax is good... the more he beats (“kōteš”) it, the more it improves ...” (Bereshit Rabba Codex 32:3, Vatican 30). DJBA 610. DJPA 273. See also: Māʿārōḵā *infra*.

**dwš** (Hb, Ar). [10a] To thresh – remove the seed bolls from the flax straw, by striking them with a mallet or other implement. “That flax-worker (“kītānāyā”) – using a mallet (on the Sabbath), is liable for performing the labor of (“dāš”) threshing”. (JT Šabbat 10a) DJBA 322-323.

**gdl** (Hb, Ar) ± **qlʿ** (Hb/Ar). To twist or plait various items (cord, hair, wreaths, fringes, etc.) or to make nets. “Rabbi Ḥīyyā planted flax and gāḏelnā (made) nets<sup>134</sup>...” (BT Kʾtūbōṭ 103b). {27} “One strand of (yarn), doubled into two, (“qʾlīʿā”)<sup>135</sup> into three, plied into six, and “double plied” into twelve...” (JT Šʾqālīm 51b) {21} DJBA 261, 1021. DJPA 494-495. “One who (“gāḏel”) braids/plaits a chain (braided cord). (BT Pʾsāḥīm 72a). {26}

**ghš** (Hb). To rub<sup>136</sup> (and therefore polish) with a round stone or glass<sup>137</sup> a linen [especially white] or wool garment, or to launder well. “Rav Yosep teaches:

129. We do not find in Talmudic literature specific occupational names: “linen weaver” (or “wool weaver”) as in Greek λινολόκος or λινουργός. Nevertheless, two foreign-originated terms for weavers are fairly common in Talmudic literature: **Tarsi** (a weaver originally from Tarsus?) [DJPA 231] and **Gardi** (from the Greek γερδιός) [DJPA 135. DJBA 283, 299]. Further research is required to assess if, in Talmudic literature, either term indicates one who weaves linen. See: Blackwell 1974, 359. Rosenfeld & Menirav 1999. Wild 1969.

130. Denton & Daniels 2002, 23. Or: “to throw the shuttle”. <http://cal1.cn.huc.edu/mḥy> G1a.

131. Here serving as an active participle.

132. Cf. “There is an art of combing out and separating flax: it is a fair amount for fifteen ... to be carried out from fifty pounds’ weight of bundles; and spinning flax is a respectable occupation even for men. Then it is polished in the thread a second time, after being soaked in water and repeatedly beaten out against a stone, and it is woven into a fabric and then again beaten with clubs, **as it is always better for rough treatment.**” (Pliny’s Natural History, Book XIX, Chapter III)

133. Archaic transitive verb: to beat, pound, or pulverize with or as if with a pestle. <http://www.merriam-webster.com/dictionary/pestle>. Cf. **ghš** *infra*.

134. For various types of nets, see: Denton & Daniels 2002, 233. These were probably knotted nets, which are suitable for trapping animals. See: Davidson 2012, 6.

135. I am uncertain exactly how to explain this technique, literally “braided”. (NBY)

136. Cf. **dqq**, **nqš** and **ktš** *supra*.

137. Rashi BT Kʾtūbōṭ 10b (s.v. gīhūš) identifies this as: “*lischier* – with a glass stone” (Catane 1996, 92). There is currently no firm evidence that this procedure was actually practiced in the Land of Israel or Babylonia during the Talmudic period.

In the Land of Israel one should purchase – for his wife, as a festival gift – (“m<sup>o</sup>gōhāšīm”) pressed linen garments.” (BT P<sup>o</sup>sāhīm 109a). “Linen garments are not restricted from (“gīhūs”) being pressed adjacent to the fast of Ab” (BT Tā<sup>o</sup>ānīt 29b).{25b}, {28}

**hbl** (Hb). To steam, in order to soften and/or bleach flax. “...It is forbidden to place (“ūnīm”) [moistened and] hackled flax fibers<sup>138</sup> into the oven on Friday, unless they (“yāhābīlū”) steam before (the entrance of Šābbāt in) the evening...” {25}

### **kbr** ↓ **lbn**

**kbš** (Hb, Ar). To press<sup>139</sup>{28} [See: Mākbeš *infra*] “On the Sabbath, it is permitted to open (or “release”) a homeowner’s press, but not to begin (“kōb<sup>o</sup>šīm”) pressing. A professional fuller’s press may not be touched.” (Mishna Šābbāt 20:5) DJBA, 551. DJPA, 249.

**kbs** (Hb). To launder.<sup>140</sup> “Linen garments are permitted (“kābsān”) to be laundered during the intermediate days<sup>141</sup> of the Festival”. (BT Mōeđ Qāṭān 18a){28}

**kss** ► **ksks**<sup>142</sup> (Hb, Ar). To rub or knead (with the fingers) a linen garment after laundering, in order to soften and whiten it. {28} “Is it permitted to

(“k<sup>o</sup>kāskōsei”) rub a (“kītānītā”) linen tunic on the Sabbath? ... If one’s intention is to soften it, then it is permitted. But if the intention is to whiten it, then it is prohibited.” (BT Šābbāt 140a) DJBA 592.

### **ktš** ↑ **dqq**

**lbn** (Hb) ± **kbr** (Ar). To bleach, literally “to whiten” (“kbr” = with sulfur). “Hackled flax fibers (become susceptible to halakhic impurity) only after they have been (“mīš<sup>o</sup>yītlābb<sup>o</sup>nū”) bleached.” (Mishna N<sup>o</sup>gā<sup>o</sup>īm 11:8) “...d<sup>o</sup>kābrei kab<sup>o</sup>rōyei...” They have certainly been (sulfured) bleached. (BT Bābā Qāmā 93b) DJBA 551.<sup>143</sup>{25}

### **mhy** ↑ **’rg**

**mzr** (Hb, Ar). To spin yarn. {21} “One who has had ‘a fit of jealousy and is wrought up’ about his wife, that she has ‘secretly gone astray’<sup>144</sup> must divorce her and remit the k<sup>o</sup>tūbā<sup>145</sup> ... only if this has been gossiped about by the women (“mōz<sup>o</sup>rōl”) whom are spinning by moonlight.” (Mishna Sōṭā 6:1). In JT Sōṭā 20d it is offered that the following are variant readings of this verbal root. DJPA 311, 326, 543. (Cf. “Māmzōr” *infra*)

→ **mšr**<sup>146</sup> (Hb, Ar). To spin wool yarn. “One who reads “mōš<sup>o</sup>rōl” – understands the text to indicate ‘spinners (f.pl.) (“māš<sup>o</sup>rān”) of wool.” (JT *ibid.*)

138. Or spun yarn. See: ‘ūn *infra*.

139. Further research is required to determine to what extent linen garments were pressed in this fashion, in comparison to wool. Flohr 2013, 116-117, 145-148 describes this process and its respective apparatus in detail. The “homeowner’s press” is not mentioned.

140. Flohr 2013, 63-64 leans toward the position that linen garments were not usually laundered by a professional *fullo*.

141. This may refer to either the Festival of Unleavened Bread, of the Festival of Booths. Generally speaking, laundering (among other secular and time-consuming activities which should be performed **before** the festival) is prohibited during this period, in order to both ensure that the entry to the festival will be with an honorable appearance, and to preserve free time to rejoice. Several explanations have been offered regarding this specific permit: 1) Linen garments soil quickly even if they were (as required) laundered immediately before the festival. (Linen garments were as a rule white – in contrast to woolens which were dyed - so that soiling was quite noticeable, and considered dishonorable particularly during a festival – NBY.) 2) Laundering linen garments is relatively easy and not very bothersome. (In contrast with laundering and fulling wool garments, which is both difficult and time-consuming – NBY.)

142. Originally from a biconsonantal root - just two root letters (*ks*), which subsequently became a triconsonantal or quadriconsonantal root by either geminating the last letter (*kss*) or reduplicating both root letters (*ksks*).

143. Sokoloff assigns this to linen, notwithstanding the local context of wool.

144. Translation of Numbers 5:13-24 - after JPS.

145. Marital monetary compensation obligated by rabbinical law.

146. The second radical shifts from “z” to the phonetically similar “š”.



→ **šzr**<sup>147</sup> (Hb, Ar). To ply flax yarn. (Cf. **gdl**, **qlʿ** *supra*) “One who reads “mōzʾrōt̄” – understands ‘pliers (f.pl.) (“šāzʾrān”) of flax.” (JT *ibid.*)

**npš** נִּפְּשׁ **nps** (Hb, Ar). To scutch (by beating and/or by flailing) or hackle (comb) flax fibers. “In the household of Bar Marion son of Rabin, when they were (“nāpšī”) scutching flax, the shives and tow would go out and damage people...” (BT Bāḇā Bātrā 26a). “Rāḇa said: Flax that was braked but not yet (“nāpīš”) scutched.” (BT Šābbāt 20b). “When one separates flax fibers on the Sabbath, he is liable for the labor of (“mānāpes”) scutching (and/or hackling)...” (JT Šābbāt 10a).<sup>148</sup> DJPA 356. DJBA 763. [17a-b] {18}

**nqš** ↑ **dqq**

**nwl** ↑ **ʾrg**

**plg** (Ar). To separate flax fibers by scutching. “When one (“māpāleg) separates flax fibers on the Sabbath, he is liable for the labor of scutching (and/or hackling)...” (JT Shabbat 10b) DJBA 908. DJPA 433. [17a-b] {18}

**pqʿ** ↓ **pšl**

**pšl** (Hb, Ar) ± **pqʿ** ≈ **bqʿ**.<sup>149</sup> To lay/twist (and/or braid/plait?) rope.<sup>150</sup> “It is forbidden to ... and to

make (“lḥāpšīl”) ropes ... (...in a desolate synagogue)” (Mishna Mōgīllā 3, 3). {26} “Everybody else makes (“mapqīʾin”) ropes of regular wool and flax, but he (King Ahasuerus) makes them (for his banquet) of fine linen and royal-purple.” (Esther Raba 2:7). DJBA 926-927, 944. DJPA 110, 443.

**qlʿ** ↑ **gdl**

**rty** (Hb). To wring or spin out (liquid) from flax to expedite the drying process (?). The term is exclusive to the Tosefta lexicon<sup>151</sup> and of unclear application in the *chaîne opératoire*.<sup>152</sup> “One who launders his garment, or wrings out his hair or “rōṭeh” his flax...” (Tosefta Tāhōrōt̄ 5:16). [12b<sup>2</sup>] {25}

**šdy** ↓ **zrʿ**

**šdy** #2. To spin yarn. ↓ **ṭwy**

**šly** (Hb, Ar) ± **ʾly** (Hb). To pull or draw flax out of (retting) water. “(One is permitted) to (“šōleh”) pull his flax out of the retting pool (during the intermediate days of the Festival of Unleavened Bread<sup>153</sup>)” (Mishna Mōʾeḏ Qāṭān 2:3). “One whom has hired workers to (“lḥaʿalōt̄”) pull his flax out of the retting pool...” (Mishna Bāḇā Mōšṭʾā 6:1) [12b<sup>1</sup>] DJBA 1149 2#. DJPA 553 2#.

147. The relationship between the verbal roots √**mzr** and √**šzr** may be based upon the Akkadian biconsonantal verb ‘zāru’ – to twist, (CAD z 72) and adjective ‘zēru’ – braided, plaited. (CAD z 89).

148. Perhaps this is also a *hapax nomen agentis*: **nppš** (Hb) ≈ **nāppsʾā** (Ar) (BT Yʾḇāmōt̄ 118b).

149. This is a rare usage of **pqʿ** (3 or 4 times in Talmudic literature), as opposed to other, more frequent meanings: “to rend (tear), to unravel, to break, to confiscate, etc.” – all destructive. In this instance, the meaning is converse - constructive, *i.e.* “to build or manufacture (rope)”. This is an example of one verbal root which expresses both a meaning and its opposite meaning. The other sources for this meaning are: JT Sūkkā 55g, Bereshit Raba 68:12. The consonant shift from “p” to “b” is (alternation of voiced and non-voiced counterparts) is common.

150. Cf. **ḥebel**.

151. The only other occurrence is in this same tractate 4:11.

152. Cf. Wipszycka 1965, 23: “The artisans boiled flax (hackled fiber), in large vases of clay or metal in water containing oil and sodium carbonate (Na<sub>2</sub>CO<sub>3</sub>) which formed a kind of soapy substance... Finally, they would **sponge (wring out)** and wash the flax, wrapping the tangles around poles and exposing them to the sun decomposed coloring and fats.” I have not found any parallel to this description – NBY. See also Liebermann 1939, Part IV, P. 68, footnote 32 at end.

153. This festival falls in March-April, adjacent to the season of flax pulling in the Land of Israel. Retting is done as soon as possible after pulling the dry straw. In addition, the warm temperatures at this time are suitable to support the necessary bacterial culture for retting. The other festival which has intermediate days is the Festival of Booths, which falls in September-October, months after pulling flax, and the temperatures are too cool to support the bacterial culture. Labor is permitted during the intermediate days of a festival, in order to prevent monetary loss. In this case, flax which is not pulled out of the water at the correct time will be over-retted and therefore almost worthless. The exact time of pulling is difficult to plan, as it depends on climatic and other natural conditions.

**srq** (Hb, Ar). To comb, hackle, or ripple flax. “(The *wadi*<sup>154</sup> where the calf’s neck has been broken) may not be sown nor tilled, but it is permitted to (“līsrōq”) comb<sup>155</sup> there flax.” [10b], {18} DJPA 339. DJBA 832 2#. See: **Sreq** *infra*.

**šry**<sup>156</sup> (Hb) ± **try** (Ar). To steep (ret) flax in water. “It is prohibited to bring flax straw from outside of the country (Land of Israel) and (“šōrīn”) ret it in the country.” (Tosefta Šōḥrīt 4:19). “After he saw that they were using it (the water drawn out by a “water wheel”<sup>157</sup> on the Sabbath) for (“tārū”) retting flax, he forbade it.” (BT ‘erūbīn 104b).[12a] DJPA 591. DJBA 1233 2#.

**šzr** ↑ **mzr**

**tlš** (Hb) ± **qr** (Hb, Ar). To pull(-up), uproot. Flax is not harvested as grains are with a scythe, the entire plant is pulled up for cutting is difficult due to the fibrous stem, and in order to gain the fibers in their entirety. {5} “Rav Yehuda permitted to pull up (“lōme‘āqer”) flax... during the intermediate days of the Festival of Unleaved Bread.”<sup>158</sup> (BT Mō‘ed Qātān 12b). “One who purchases a crop of flax from a fellow man ... if the flax is still rooted in the ground, and he (“tālāš”) pulled-up any amount, this is considered a purchase (of

the entire crop).” (Mishna Bāḥā Bāḥrā 5:7) DJPA 416, 583. DJBA 877, 1211.

**try** ↑ **šry**

**twy** (Hb/Ar) ± **‘zl** √ **’zl**, **šdy** (Ar). To spin flax (or wool) yarn.<sup>159</sup> “As one (f.) who lifts her left arm to spin flax...” (Mishna Nōgāīm 2:4). “Flax which was spun by a woman during her menstrual period... if it was (still) damp<sup>160</sup>, one who moves it is rendered halakhically impure.” (Tosefta Tāhōrōt 4:11). “He saw Orpah<sup>161</sup> Ishbi’s<sup>162</sup> mother, and she is (“āzlā”) spinning flax...” (Midrash Tehilim 18:30). {21} DJBA 102, 496, 849-850. DJPA 322, 401.

**zr**<sup>c</sup> (Hb) ± **šdy** (Ar). To sow. “One who leases a field from another for only a few years is prohibited to (“yīzrā‘enā) sow flax...” (Mishna Bāḥā Mōšī‘ā 9:9). “I go and (“šādenā”) sow flax and make nets...” (BT Bāḥā Mōšī‘ā 84b). “Raḥ saw a man that was (“šādeh”) sowing flax on (the holiday of) Pūrīm...” (BT Mōgillā 5b). {2} DJBA 1111.13.

### Workplaces

**Bei Kitānā** (Ar). An area (where an unspecified activity is performed) of flax. “A bill of divorce

154. After Deuteronomy 21:4, JPS translation: “...and the elders of that town shall bring the calf down to an everflowing wadi (creek), which is not tilled or sown. There, in the wadi, they shall break the calf’s neck.”

155. It may be assumed that the intention is to rippling, **before** the flax straw is to be retted in the adjacent everflowing wadi (creek). A parallel reading, Midrash Tanaim to Devarim 21:4, mentions also “laying out wool fleece and flax fibers to dry”. Perhaps, according to that version, the flax was also scutched and hackled on site, **after** be retted in the wadi (creek). And perhaps all three of these combing processes were performed there.

156. See also: Mīšrā *infra* workplaces.

157. Apparently: ἀντλεῖν (antlein): <http://www.n-k.org.il/?CategoryID=321&ArticleID=251> Or perhaps: Archimedes’ screw. [https://en.wikipedia.org/wiki/Archimedes%27\\_screw](https://en.wikipedia.org/wiki/Archimedes%27_screw)

158. In the Land of Israel, flax ripens during March-April, and may coincide with this festival (whose date is based on the lunar calendar). Not all labors are permitted during the intermediate days, but if the flax is not pulled on time, it will continue to develop thicker and less valuable fibers, which incurs a monetary loss for the farmer.

159. Peshitta (Syriac targum to the Pentateuch) translates **plied** linen (Exodus 26:1, *passim*) as “āzīlā” (passive determined participle, serving as an adjective). ASR 1090. The *nomen agentis* derived from this root is “āzālwayā” – a spinner (m.s.). DJBA 102.

160. Dampened – with her saliva, as historically used for wet-spinning flax. See also Lieberman 1967, 262-263, Ketubot Ch. 5 – “One shall not compel his wife to spin flax”.

161. After Ruth 1:4 “They married Moabite women, one named Orpah...”

162. After II Samuel 21:16 “...and Ishbi-benob tried to kill David.”

was found in “an area of flax” in Pumbedita...” (BT Gīṭīn 27a, BT Bāḇā Mṣṣṣṣā 18b). DJBA 199, 208 #1, 6.

→ **Dūktā hekā dṣtarū kītānā** (Ar). A place where flax is steeped. (See: **try**√ *supra*, **Mišrā** *infra*). “... some say that it was an area (“hekā dṣtarū kītānā”) in which flax is retted, and convoys (passersby) **are not** present... (*Ibid.*). [12a]

→ **Dūktā dṣmṣzabnei kītānā** (Ar). A place where flax is sold. “...some say that it was an area in which (“dṣmṣzabnei kītānā”) flax is sold...and convoys (passersby) **are** present...” (*Ibid.*). (9), (15), (20), (23), and/or (27).

**Ḥanwātā** (Ar f. pl.). Stores, workshops, or guild offices.<sup>163</sup> “At the (“ḥanwātā”) workshops of (“kītānā’y”) flaxmen there was a meeting ...” (JT Peṣā 16a, Leiden codex). DJPA 208, 460. DJBA 473, 967 #2.<sup>164</sup>

**Mišrā** (Hb). A rettery<sup>165</sup> - place of steeping (retting) flax. “One may draw out his flax from the (“mīšrā”) rettery (during the intermediate days of the Festival of Unleavened Bread) in order to prevent it from being damaged ...”.<sup>166</sup> (Mishna Mōṣeḏ Qāṭān 2:3). [12a]

### *Tools and implements*

**ṣōr** (HB). A hide (leather) apron. See: Kāttān *infra*, and various uses for an apron in flax manufacture.

**Koš ha-ṣArbelī** (Hb). A spindle<sup>167</sup> that was probably used in the town Arbel<sup>168</sup> for spinning relatively coarse flax. The whorl of this spindle is more firmly attached to the shaft than a regular flax spindle. “Koš ha-ṣArbelī – its parts are considered fastened together for applications of susceptibility to halakhic impurity, and the sprinkling of the ‘water of lustration’<sup>169</sup>...” (Tosefta Pārā 12:16){21}

**Koš šel pīštān** (Hb). A spindle used especially for spinning regular flax (in contrast to one designated to use for rope or for coarse flax). The whorl is relatively loosely attached; therefore each part should be sprayed separately. Nevertheless, if it happened that one part has been sprayed (while the implement is assembled), the entire spindle has still been purified. (Tosefta Pārā *supra*, Mishna Pārā 12:8 and Maimonides commentary *ad. loc.*){21}

163. See: I Chronicles 4:21 “families of flax/linen-workers” – guild, factory or workshop. After Demsky 1966, 213-214. See also: Theodosian Code 10-20-6 “... guild of imperial weavers, either a linen weaver or a linen worker ...” *Ibid.* 10-20-8 “Scythopolitan (Hebrew: Beth Shean) linen workers” – are probably a guild. Safrai 1994, 225: “... the store or shop is synonymous with the workshop.” Kasher 1979, 311-313 and 1985, 352-353 describes Jewish textile guilds in the Land of Israel. Retzleff & Mjely 2004, 40 report that a section of the 3<sup>rd</sup> century AD odeum of Gerasa Trans-Jordan (50 km east from Beth Shean) was designated by inscription: “The place of the linen-workers”. This was most likely the section in which guild members were seated.

164. From available literary context, it is impossible to determine exactly which activities of the chaîne opératoire usually took place there.

165. <http://www.merriam-webster.com/dictionary/rettery>. Georgacas 1959, 257: λιναρίτης “water in which flax is retted”.

166. Safrai & Lin 1988, 129-162, 171, 178-180. Ancient facilities which have been tentatively identified as a rettery have been discovered in Kibbutz Geva.

167. **Koš** literally means shaft, spindle or stick. In this context it probably indicates the entire spindle, including whorl, stick and possibly hook.

168. Leibner 2009, 257-258. Cf. Bereshit Rabba 19:1 “Garments (or textile products) of linen made in Arbel – what is their worth? What is their price?”. This is in contrast to the linen products produced in Beth Shean (Scythopolis) – the center of production of fine linen in the Land of Israel, which are “very fine and therefore ignite (or become soiled by ashes) easily”. These products are alluded to in Bereshit Rabba 32:3, Codex Vatican 30. See: √ktš and √nkš. Diokletian consistently ranks Scythopolis-produced linen garments as the highest quality and consequently most expensive. XXVI 13-63, 78-134. XXVII 8-22, 16-30. Lauffer 1971, 168-177. In accordance, “*Expositio totius mundi et gentium*” (c. 459 AD) ranks Scythopolis as the source of finest quality linen clothes. Stern 1974-1984, 497. Possible reasons for the production of inferior linen products in Arbel have been presented in Ben-Yehuda N. 2011. “The Mysterious Flax Industry of Arbel” (unpublished, in Hebrew).

169. HB Numbers 19:3 “A man who is clean shall gather up the ashes of the cow and deposit them outside the camp in a clean place, to be kept for water of lustration for the Israelite community. It is for cleansing.”

**Mā'ārōkā** (Hb ~ Ar). A pestle, or rolling pin used for crushing seed pods or braking flax straw.<sup>170</sup> “That flaxman ... when using a (“mā'ārōkā”) pestle (on the Sabbath), is liable for the labor of grinding...” (JT Šabbat 10a). DJPA 323.[10a] {16} See: **ktš**√↑.

**Mākbeš** (Hb). A clothing press.<sup>171</sup> (See **kbš**√*supra*) (28)

**Māsreq šel pīštān** (Hb). A comb, hackle or ripple for flax (in contrast to that used for wool).<sup>172</sup> “A (“māsreq šel pīštān”) comb for flax, if some of its teeth have been broken off, and two remain it is still susceptible to halakhic impurity...” (Mishna Kelīm 13:8). [10b] {18}

**Mei Mīšrā** (Hb). The water (or: “liquor”) of the retting process. See: **šry**√↑. “One whom is reciting (“Qārī'at Š'mā")<sup>173</sup>...shall not do so while he is immersed in foul-smelling water or (“mei mīšrā”) retting liquor,<sup>174</sup> unless he dilutes them.” (Mishna B'rākōt 3:5) [12a]

**Nāwlā** ≈ **Nābāl d'kītān**<sup>174b</sup> (Ar). Loom. “One must not place a loom which being used for wool near a (“nābāl d'kītān”) loom which is being used for flax,<sup>175</sup> because of the dangling yarns (that may become attached to one another)”. (JT Kīl'ā'im 32a) {24} DJPA 344. DJBA 735 #1.

**Qāsiyā**.<sup>176</sup> Leather glove(s), worn by a flax worker. See: **ōsei pīštān** *infra*.

**Qōpnā** (Ar < κόπανος Gr).<sup>177</sup> A mallet<sup>178</sup> used for braking flax straw or crushing seed pods. This context does not infer the use of Qōfnā for beetling, although a similar implement may be used for that purpose. “That flaxman who uses a (“qōfnā”) mallet on the Sabbath is liable for the labor of threshing” (JT Šabbat 10a). DJPA 483 (hapax). [10a] (15) {25a} See: **dwš**√, **dqq**√↑.

### *Materials and products*

#### *Raw materials*

**Pīštān** (Hb) ± **Kītān** ~ **Kītānā** (Ar). Flax, linen (*Linum usitatissimum*). *Passim*. DJBA 579. DJPA 257.

**Qānābūs** (Hb) ± **Qīnbā** (Ar). Hemp (*Cannabis sativa*). “...also the (“pīštān”) flax-linen and the (“qānābūs”) hemp, when they are blended together<sup>179</sup>...” (Mishna N'gā'im 11:2, Kīl'āyim *infra*). DJBA 1014.

**Šemer** (Hb) ± **āmār** ~ **āmārā** (Ar). Sheep's wool (*Ovis aries*). “There is no prohibition of mixed species (in garment context) other than (“šemer”) (sheep's) wool and (“pīštīm”) flax-linen...” (Mishna Kīl'āyim 9:1, N'gā'im *supra*) DJBA 870. DJPA 411.

**Šemer Gefen** (Hb) ± **āmār Gūfnā** (Ar). Cotton

170. In Mishna Kelīm 15:2 this refers to a baker's rolling pin.

171. See: Sperber 2014 and Granger-Taylor 1987 for description of this implement and its use. Additional research is required to examine its specific usage for wool and linen garments.

172. See Wild 1968 for a discussion of the roman flax-hackle. Barber 1991, 14 illustrates a possible ancient flax hackle.

173. This prayer-like recitation consists of passages from the HB, and therefore is considered holy and must be performed in a clean environment.

174. Kozłowski 1992, 252-253. The odor is a result of toxic and acidic gases which are released during water retting.

174b. The w/b labial consonant alternation is a familiar phenomenon in Mishnaic Hebrew due to their similar or identical pronunciation (Steve Kaufman, personal correspondence). Sharvit 2016, 288-291

175. We do not currently have information regarding the exact construction of these looms themselves, and if it varies from a “wool loom” to a “flax loom”.

176. Etymology unknown.

177. See Georgacas 1959, 257: λιναροκόπανος – “wooden beater of flax.

178. Vogelsang-Eastwood 1992, 12 presents illustrations of possible flax mallets.

179. The literary context (and current textile science) indicate that these two fibers are similar in appearance and feel, and therefore compatible to be blended together.

(*Gossypium arboretum*).<sup>180</sup> “This proselyte is similar to (“amrā gūfnā”) ‘grape wool’ (cotton), whether you want to put it with (“āmra”) wool – that is permitted, or with (“kītānā”) flax – that is also permitted...” (JT Qīdūšīn 64c). DJBA 870. DJPA 411.

*Materials and products (intermediate and final)*<sup>181</sup>

**Hōšen > Hōšānīm > Hōšānei** (construct state) ≈ **Hōšen**<sup>182</sup> (Hb/Ar). Stalks of flax, flax straw. “Two (“hōšānei”) stalks of flax left in the field shall not be retrieved;<sup>183</sup> three or more may be retrieved...” (Mishna Pe’ra 6:5). “If one roofed his festival booth with (“hōšānei”) flax straw, it is fit for use. However, if that was done with (“ānīšei”) scutched flax fibers, it is unfit.”<sup>184</sup> (Tosefta Sūkkā 1:5). {4} – {15}. DJBA 374.

-----

**Kītānā’ d’āvīd b’ṭūnei** (Ar). A load of flax straw. “A live fowl that fell on a load of flax – there is concern that it has been internally injured, and is subsequently unfit for use as (edible) poultry.” (BT Ḥūlīn 51b). DJBA 508. {7} – {15}

**’Īsorītā > ’Īsoryātā** (Ar). Bundle(s) of flax sheaves or cane. “A live fowl that fell on bundles of flax sheaves – there is concern that it has been internally injured, and is subsequently unfit for use as (edible) poultry.” (BT Ḥūlīn 51b). DJBA 121. {7} – {15}

**Kepa > Kep’eh** (pl. construct state) **d’kītānā** (Ar). Sheaves of flax. “A man whose son stole sheaves of flax,<sup>185</sup> he (the father) vowed that his possessions would be forbidden to that son.” (BT Nēdārīm 48b). DJBA 578. {7} – {15}

**Qīršīn** (Hb pl.). “Divisions” – piles ready for division into shares.<sup>186</sup> “One who leases (as tenant) a flax field from another, is required to tend to it through to the phase of preparing piles of (pulled) flax.” (Tosefta Bāḥā M’šī’ā 9:19) Jastrow 1903, 1425. DJPA 507 2#. {7} – {15}

**Māšeḇeṭ šel pīštān** (Hb). ‘Chapels’ of flax. “These materials are flammable ... chapels of flax ...” (M’kīlīt’ā D’Rābī Šīm’ōn Bār Yōḥāy 22:5). Krauss 1945, 61. Literally: ‘column’ or ‘pillar’. {7} – {15}

-----

**Kītānā d’āvīd bīzrei** (Ar). Flax straw that has seed bolls attached – prior to rippling and retting. “A live fowl that fell on flax straw that has seed bolls attached, there is concern that it has been internally injured because of the protrusions, and is subsequently unfit for use as (edible) poultry.” (BT Ḥūlīn 51b). DJBA 195. {5} – [10b]

-----

**(Kītānā) d’ḏāyīq w’lā n’pīš** (Ar). Flax which has been braked but **not** scutched. “A live fowl that fell on flax straw that has been braked but not yet scutched, there is concern that it has been internally injured, and is subsequently unfit for use as (edible) poultry.” (BT Ḥūlīn 51b). {16} See: dqq√ nps√.

**(Kītānā) d’ḏāyīq w’n’pīš** (Ar) Flax which has been both braked and scutched. “A live fowl that fell on flax straw that has been both braked and scutched, there is **no** concern that it has been internally injured, and is subsequently **fit**<sup>187</sup> for use as (edible) poultry.” (BT Ḥūlīn 51b). {16} – [17b] See: dqq√ nps√.

-----

180. Talmudic terminology related to various silks and other minor fibers is not within the scope of the current paper.

181. Arranged according to *chaîne opératoire*.

182. Possibly ✱.

183. Based upon HB Deuteronomy 24:19 “When you reap the harvest in your field and overlook a sheaf in the field, do not turn back to get it; it shall go to the stranger, the fatherless, and the widow...” Flax is considered a food crop in this context, as the (ground) seeds are edible and edible oil can be extracted from them.

184. The regulation is that roofing for the festival booth, must be of non-edible vegetable matter, in its natural state. Flax straw is considered natural, whereas flax fiber is considered a manufactured product, and therefore unsuitable.

185. Rashi *ad. loc.* offers an additional interpretation: “The son worked with sheaves of flax and therefore neglected his study of Tora.”

186. Safrai 1994, 194. See also: Lieberman 1967, 290 *ad loc* for a different, albeit unlikely, interpretation.

187. The fowl must be ritually slaughtered before consumption.

**N<sup>o</sup>oreṭ**<sup>188</sup> (Hb) ± **Srāqtʿā** (Ar). Flax tow. “How did they ignite the beacons? They brought long poles of cedar-wood, reeds, pine-wood (“oilwood”) and (“n<sup>o</sup>oreṭ šel pīštān”) flax tow, which they wrapped with twine ...” (Mishna Rōš Hā-Šānā 2:3). “A fast is effective for dissipating a (bad) dream, just as fire rapidly burns (“n<sup>o</sup>oreṭ”) tow.” (BT Šābbāt 11a). DJBA 833 (- corrected according to ASL 1051)

→ **Gāsā** (Hb). Coarse (scutched) tow (probably with shives). “It is permissible to cover up food (to keep it warm on the Sabbath) with (“dāqā”) fine tow. Rabbi Yehuda prohibits (“dāqā”) fine tow and permits (“gāsā”) coarse tow.” (Mishna Šābbāt 4:1). [17b]

→ **Dāqā** (Hb). Fine (hackled) tow (probably without shives). See previous entry. {18}

→ **Dāqtā** (Ar). Fine (scutched) tow (probably with shives). “A live fowl that fell on (“dāqtā”) fine tow, there is concern that it has been internally injured, and is subsequently unfit for use as (edible) poultry.” (BT Ḥūlīn 51b). DJBA 349. [17b]

→ **Dāqdāqtā** (Ar). Very fine (hackled) tow (without shives). “A live fowl that fell on (“dāqdāqtā”) very fine tow, there is **no** concern that it has been internally injured, and is subsequently **fit** for use as (edible) poultry.” (BT Ḥūlīn 51b). DJBA 348. {18}<sup>189</sup>

-----

**ʿānīš** > **ʿānīšin** > **ʿānīsei** (construct state) ≈ **ʿānīš**, **ʿānūš** (Hb). Scutched or hackled flax fibers. “One who has vowed not to don linen is permitted to cover himself with (“ʿānīsei pīštān”) flax fibers.” (Mishna N<sup>o</sup>dārīm 7:3). “One who has found

abandoned (“ʿānīsei pīštān”) flax fibers – they belong to him...” (Mishna Bābā M<sup>o</sup>šīʿā 2:1). [17b] {18} See: **Sereq** *infra*.

-----

**Sereq**<sup>190</sup> (Hb). Flax sliver. “One who is suspected that he violates the laws of the Sabbatical Year – it is forbidden to purchase from him flax even (“sereq”) sliver, but spun or woven material is permitted.” (Mishna B<sup>o</sup>kōrōṭ 4:8). {18} See: **ʿānīš** *supra*.

**Sereṭ** (Hb). Band or ribbon. “It is prohibited to tie together a (“sereṭ”) ribbon of wool and a (“sereṭ”) ribbon of flax to use as a belt, even if there is a leather strap between them.” (Mishna Kīlʿāyīm 9:9). {18} {24}<sup>191</sup> {29?}

-----

**ʿūn** > **ʿūnīn** (Hb). {22} A hank (or: ‘skein’) of spun linen.<sup>192</sup> “...and the (“ʿūnīn”) after they have been bleached...will be susceptible to the impurity of an eruptive affection”.<sup>193</sup> (Mishna N<sup>o</sup>gaʿim 11:8 and Maimonides commentary *ad loc.*) “[Utensils which are permitted to be loaned out during the Sabbatical Year, notwithstanding their conventional use for currently forbidden agricultural products, because it is possible that they will be employed for a permitted use, for example]... an oven to conceal therein **ʿūnīn** of **pīštān**...” (JT Š<sup>o</sup>bīʿīt 36a). {21}

-----

**Ḥūṭ Pīštān** (Hb) > **Ḥūṭei** ± **Ḥūṭʿa D<sup>o</sup>Kītanā** (Ar) ± **ʿAzil** (Ar). Linen yarn or string.<sup>194</sup> “One who

188. Liddell & Scott 1996, 1658: στρωπειον – tow, oakum. Appropriate Greek suffixes form nomina agentis: tow-dealer, tow-maker, and tow-worker. These specific occupational names do not exist in Hebrew. Cleland, Davies & Llewellyn-Jones 2008, 113 provide differentiation between fine linen fabrics “*amorginon*” (made from long fibers – “line”), and coarse ones “*stuppionon*” (made with short fibers – “tow”). Three grades of tow are mentioned (from fine to coarse) by Diokletian XXVI, 1-3, Lauffer 1971, 169.

189. The last three descriptions of different grades of fine tow may overlap.

190. JT Mā<sup>o</sup>serōṭ 52g quotes this Mishna, but reads: “pīštān sārūq” (hackled flax). “ʿānīš” and “sereq” could be of overlapping meaning. In any case, **sereq** is a mass noun, in contrast to **ʿānīš**, which is a count noun.

191. Perhaps this is a narrow fabric, woven with a belt loom or tablets. The parallel Tosefta (5:22), in place of **sereṭ** (‘band’ or ‘ribbon’), reads “**sereq**” (flax sliver). Cf. *supra*. Perhaps sliver was used as part of a belt (?).

192. Feliks 1970, 356. Cf. **hbl** *supra*.

193. After HB Leviticus 13:47 “When an eruptive affection occurs in a cloth of wool or linen fabric...”

194. Nine grades of linen yarn are mentioned (from fine to coarse) by Diokletian XXVI 4-12, Lauffer 1971, 169.

found a (“ḥūṭ<sup>9</sup>a d<sup>9</sup>kītānā”) linen yarn in his woolen cloak and pulled it out. He wasn’t sure if it had been entirely pulled out or not...” (BT Nīdā 61b). “One who makes a tunic entirely of camel hair or rabbit hair, and wove one strand of woolen yarn on one side and one strand of (“ḥūṭ pīštān”) linen yarn on the other side – the garment is forbidden.” (Tosefta Kīl’āyīm 5:12). “A woman shall not go out<sup>195</sup> on the Sabbath with (“ḥūṭei ṣemer”) wool yarns or (“ḥūṭei pīštān”) flax yarns or laces in her hair. (Mishna Šābbāt 6:1). DJPA 401. DJBA 436. {21}

**Ṭ<sup>9</sup>wy** (Hb - RH<sup>196</sup>). Spun material (thread, yarn, etc.). “One who is suspected of violating the laws of the Sabbatical Year, it is forbidden to purchase from him flax, even it is hackled. But it is permitted to purchase (“ṭ<sup>9</sup>wy”) spun or (“ārīg”) woven material.” (Mishna B<sup>9</sup>kōrōṭ 4:8) {21}

**Māmzōr** (Hb). Plied linen yarn. Cf. √mzr↑. “One who makes (or plies) (“māmzōr”) plied yarn (or cord) on the Sabbath is liable for the labor of spinning.” (JT Šābbāt 10g). {21}

-----

**Š<sup>9</sup>ṭiy LāPīštīm/BāPīštīm** (Hb) ± **Š<sup>9</sup>ṭiyā L<sup>9</sup>Kītānā<sup>9</sup>/B<sup>9</sup>Kītānā<sup>9</sup>** (Ar). Flax yarn intended for use as warp. The Hebrew phrases are Biblical quotations (Leviticus 13:48-58), which are quoted in

Rabbinic literature (Sifra 5:13, 15) for the purpose of halakhic discussion. The Aramaic phrases are from the targums of the respective Biblical verses. {21/24}

**‘ereḥ LāPīštīm/BāPīštīm** (Hb) ± **‘irba<sup>9</sup> L<sup>9</sup>Kītānā<sup>9</sup>/B<sup>9</sup>Kītānā<sup>9</sup>** (Ar). Flax yarn intended for use as weft.<sup>197</sup> See previous entry, for parallel phrases and sources. {21/24}

**P<sup>9</sup>qa<sup>9</sup>at** (Hb). Skein, of one of the above two types of yarn. (Mishna N<sup>9</sup>gā<sup>9</sup>īm 11:8) {21/24}

**‘ārīg** (Hb). Woven material. “...but it is permitted to purchase from him (“‘ārīg”) woven material (of linen).” (Mishnah B<sup>9</sup>kōrōṭ 4:8) {24}

-----

**Nāšbā** > **Nīšbei** (Ar) ± **Rešet** (Hr). Net.<sup>198</sup> “Rabbi Ḥīyyā planted flax and (from it) made (“nīšbei”) nets<sup>199</sup> to trap gazelles...” (BT K<sup>9</sup>tūbōṭ 103b) DJBA 778. {30}

**Ḥebel** > **Ḥābālīm/n** (Hb, Ar) ± **‘ašlā** ≈ **Ḥāšlā** (Ar) ± **‘aṭūnei** (Ar) ± **Mīṭn<sup>9</sup>a** (Ar). Rope or cord. “There are three materials from which (“ḥābālīm”) ropes are made... from flax for measuring (or surveying).” (BT ‘erūbīn 58a). “Ropes (“ḥābālīm”) of flax are forbidden to use as the roofing for the festival booth.” (JT Sūkkā 52b). “Rabbi Ḥīyyā

195. The reason for this prohibition is that the woman might take the yarns out of her hair and carry them in her hands in the public domain, which is forbidden on the Sabbath.

196. BH = Māṭweh (Exodus 35:25). This is a Biblical *hapax legomenon*.

197. The difference between warp and weft yarns is not mentioned in these sources. There are a number of possibilities: 1) The yarns may be of different twist directions (‘S’ or ‘Z’) to enhance interlock, or of different counts (thicknesses). Cf. BT ‘abōdā zārā 17b. 2) The warp yarn may be of a tighter twist than the weft. 3) The warp yarn may be sized (treated with starch or the likes) or boiled to make it more durable. Cf. Rashi to BT M<sup>9</sup>īlā s.v. ‘mai l<sup>9</sup>‘āhīzā’- “...he smoothes (or: ‘polishes’) the yarn for weaving with bran or anything else...” 4) Different qualities of fibers may be used, e.g. (stronger) long fiber flax for the warp and short fiber for the weft. (After John Peter Wild, personal correspondence.)

198. Pliny Book 19, chapter 2: “From the same province of Spain Zoēla flax has recently been imported into Italy, a flax especially useful for hunting-nets; Zoelā is a city of Gallacia near the Atlantic coast. The flax of Comae in Campania also has a reputation of its own for nets for fishing and fowling, and it is also used as a material for making hunting-nets.” Xenophon, On Hunting, Chapter 2, Section 7: “The net-keeper should be a man with a keen interest in the business, one who speaks Greek, about twenty years old, agile and strong, and resolute, that, being well qualified to overcome his tasks, he may take pleasure in the business. The purse-nets should be made of fine Phasian (Colchian) or Carthaginian flax, and the road-nets and *hayes* (meaning unclear – NBY) of the same material.” *Ibid.*, Chapter 10, Section 2: “The nets must be made of the same flax as those used for hares, of forty-five threads woven in three strands, each strand containing fifteen threads.”

199. Cf. JT M<sup>9</sup>gīllā 74d that he made ropes for this purpose.

bought flax seeds, planted them, harvested them, and made (“ḥāḇālīn”) ropes<sup>200</sup> ...” JT M<sup>o</sup>gillā 74d). “...A diver descended, and tied (“ʿaṭūnei”) ropes of flax to a reef, and to the ship.” (BT Rosh HaShana 23b). “...One who tied a (“mīṭnʿa”) cord of wet flax to his loins ...” (BT Baḇa M<sup>o</sup>ṣṭʿa 113b). DJPA 185. DJBA 173, 427, 721. {28}

**M<sup>o</sup>ṣṭʿā** (Hb/Ar). Cord or twine, often used for surveying.<sup>201</sup> Māšōḥā – surveyor.<sup>202</sup> √mšḥ – to measure or survey. “The surveyors (māšōḥōṭ) do not measure exhaustively...” (Mishnah ʿerūḇīn 4:11). DJPA 333-334, DJBA 712. {28}

-----

**Dardas** > **Dardasin** (Ar). Stockings or foot coverings made of linen or wool. “‘Dardasin’ of wool on one foot and ‘dardasin’ of linen on the other foot...” (JT Kīlʿayīm 32d). DJPA 154, 155. {29}

**K<sup>o</sup>lei Pīštān ± Bīgdei Pīštān** (Hb) ≈ **Mānei D<sup>o</sup>Kītānā** (Ar). Flaxen or linen garments or other textile product. “One may purchase, from a (married) woman, woolen items in Yehuda, and (“k<sup>o</sup>lei pīštān”) flaxen items in the Galilee.” (Mishna Bāḇā Qāmā 10:9). “One must delight his wife during the festival, with a gift that is appropriate for her. In Babylonia – dyed (woolen) garments, in the Land of Israel – pressed (“bīgdei pīštān”) linen garments.” (BT P<sup>o</sup>saḥīm 109a). DJBA 579. {29}

→ **Kītānā Rōmītā** ≈ **Rōmʿāʿā** (Ar). Very expensive

and quickly worn-out linen garments, or very fine flax yarn. “One who inherited a large sum or money and wants to waste it should wear linen garments, specifically ‘kītānā rōmītā’.” (BT Bāḇā M<sup>o</sup>ṣṭʿā 29b). “One shall not compel his wife to (wet-) spin flax yarn (through her mouth), because it causes halitosis and scars the lips.<sup>203</sup> Specifically, ‘kītānā rōmʿāʿā’.” (BT K<sup>o</sup>tūbōṭ 61b). {29}

**Kītūnā, Kītānītā, Kītōnītā** (Ar). A tunic or garment, presumably made of linen. “Rav Hīsdā says: ‘A rabbinic disciple who wants to purchase a (“kītōnītā”) linen tunic, should purchase it in ‘Nahar Abba’ (toponym). He should launder it every thirty days, and then it will last twelve months. I guarantee that!’” (BT Šābbāt 140b). DJBA 579. {29}

**Sādīn** > **S<sup>o</sup>dīnīm** (Hb) ≈ **S<sup>o</sup>dīnā** > **S<sup>o</sup>dīnāyā** (Ar). One of various simple (flat) textile products, e.g. bed sheet, curtain, veil or awning; possibly made of linen. Also, a *specifically* linen wrapped-garment.

This is a rare HB term, appearing three times:<sup>204</sup> “I shall give you thirty “s<sup>o</sup>dīnīm” and thirty sets of clothing.” (Judges 14:12-13). “And the lace gowns, and the “s<sup>o</sup>dīnīm”, and the kerchiefs and the capes.” (Isaiah 3:23). In these two appearances, the context is garments. The following offers no direct inference as to the identity of the item: “She makes a sādīn and sells it...” (Proverbs 31:24)<sup>205</sup>. None of the HB texts indicate what material the sādīn is made of.<sup>206</sup>

200. Cf. BT K<sup>o</sup>tūbōṭ 103b reading, in which he made **nets**. See “Nāšbā”.

201. Not mentioned as being of flax, but flax **rope** is recommended for surveying (BT ʿerūḇīn 58a), therefore extrapolation here is probable.

202. An additional nominal form (Ar) of this root – **mīšḥāʿ** – translates: ‘measurement’, ‘dimension’, or ‘size’. DJPA 333, DJBA 712. Worthy of mention is the homonymic root, meaning ‘oil’ (n. Ar) and ‘to anoint’ (v. Hb).

203. See also Lieberman 1967, 262-263, Ketubot Ch. 5 - “One shall not compel his wife to spin flax”.

204. Etymology: Akkadian *sadinnu* – item of clothing (HALOT, 743-744). Perhaps a foreign word. (Gesenius 1987, 1381).

205. Nevertheless, this is obviously a textile product, as are additional products, materials and implements mentioned in this chapter: vs. 13: wool and flax, vs. 19: spinning implements, vs. 21: crimson dyed garments, vs. 22: “mārḇādīm” (coverings), Egyptian linen and Tyrian-purple dyed garments.

206. Lacking any modifier which could identify the material being used, and/or the specific use of this object, the term **sādīn** is open to polysemy. Testimony to this can be found in the respective Aramaic Targums of (the identical term) in each of these three verses, in each instance using a different (and often obscure) term. Judges 14:12: TY: **pldys** (of uncertain origin), PS: **ʿpqrsʿ** (from Greek ἐπικάρσιον – “striped garment”). Isaiah 3:23: TY: **qrṭys** (a type of head covering??), PS: **tklytʿ** (hyacinth blue). Proverbs 31:24: TP: **ptḡ** (unknown), PS: **ktnʿ** (linen).



Talmudic sources may or may not indicate that this product is made of linen:<sup>207</sup>

“She spread a (“**sādīn**”) bed sheet of (“**pīštān**”) linen on his bed...” (BT B<sup>ṛ</sup>rākōt 10b). “(“**Sādīn**”) with attached (“**šīšīt**”) fringes<sup>208</sup> (or: ‘tassels’)<sup>209</sup> – what is the law?” (Mishna ‘edūyōt 4:10)<sup>210</sup> “A (“**sādīn**”) curtain (or: ‘screen’) of “**būš**” was placed (or: ‘drawn’) between the High Priest and the people...” (Mishna Yōmā 3:4). “(A) **sādīnā** of “**kītānā**” (linen) and its tatters.” (BT Š<sup>ḥ</sup>ḥōt 6b). DJBA 788. DJPA 368.

### *Occupational names* (Nomina agentis)

The challenges involved in accurately defining these occupational names emanate from both the ambiguity of context in ancient text and the uncertain organization of the historical labor force. Curchin<sup>211</sup> encounters these very difficulties regarding the definition of two Greek occupational names in this industry. His discussion is quite relevant, if not parallel, to our own deliberations in this paper. Here we will quote selected portions:

*Lintearius*<sup>212</sup> is presumably a producer. One can therefore readily understand the translation “linen-weaver”,<sup>213</sup> adopted by

Lewis and Short... Susan Treggiari suggests that *linteariae* were basically linen-sellers who may, however, have woven the linen they sold... I (Curchin) would alter the emphasis... and see the *lintearius* as primarily a linen-weaver who could (and frequently would) sell his own products in his shop<sup>214</sup> ... This does not explain the difference between *lintearius* and *linarius* or the need for two types of tradesman<sup>215</sup> in the same product in the same town... *Linarius* may be a dealer in *linum* – flax, and *lintearius* a dealer in *linteum* – linen cloth... In the East we find... flax could be purchased raw in bundles... or to barter the spun skeins... Merchants of linen yarn – *linemporoi* – are attested selling to professional weavers, and the guilds of such merchants are attested ...

In synopsis, linen-merchants themselves may be linen-weavers, or perhaps linen-workers at other previous steps of production. The distinction between merchants and workers is therefore blurred. We shall find similar ambiguities/complexities in Talmudic terminology, as follows.<sup>216</sup>

Following are the five major *nomina agentis* for this field in rabbinic literature:<sup>217</sup>

- 1) ‘ōsei (construct state) **Pīštān** (Hb pl.)
- 2) **Būš’ai** > **Būš’a’ei** (Ar)
- 3) **Kāttān** (Hb)

207. Cf. also: **būš** *supra* and footnote on the curtains (or: ‘screens’) used in the Jerusalem Temple.

208. Numbers Ch. 15:37-38 “The Lord said to Moses as follows: Speak to the Israelite people and instruct them to make for themselves fringes on the corners of their garments throughout the ages; let them attach a cord of blue to the fringe at each corner.” (JPS)

209. NIV

210. The legal discussion here deals with affixing woolen fringes on this linen garment, which may violate the HB prohibition of mixed species. (Maimonides commentary *ad loc.* Leviticus 19:19 “... a garment from a mixture of two kinds of material shall not come upon you.” Deuteronomy 22:11 “You shall not wear a garment combining wool and linen.”)

211. Vol. 10, no. 1. 34-35.

212. The Theodosian Code mentions the public tax on “Scythopolitan linen workers” (10.20.8). “*Linteones* and *linyfi* are apparently synonymous there as elsewhere.” Wild 1967, 656 Identifies these workers as linen-weavers, and the state levy as *publico canoni obnoxii*.

213. Cf. Georgacas 1959, 254: λινλόκος “linen-weaver”.

214. Jerrard 2000 (no pagination) presents evidence for the connection between retailing and manufacture in the Roman textile industry in *collegia* (craft union) inscriptions. Both retailers and manufacturers were members of the same *collegium*.

215. Cf. Georgacas 1959, 254: λινοπώλης “linen merchant”.

216. Shatzmiller 1994, 121 presents a similar situation of ambiguity in Medieval Arabic flax-related nomina agentis: **Kattān** = weaver of flax, linen flax manufacturer, seller, flax spinner, or flax comb. **Ḳattān** = cotton spinner and/or seller, cotton manufacturer and/or seller, carder. **Kattānī** = flax spinner.

217. A second group of temporary and auxiliary flax-linen nomina agentis will follow.

4) **Kītān'āi, Kītānyā'** (definite) > **Kītān'a'ei** (Ar)

5) **Pīštānī** (Hb)

The common denominator of this group of occupational names in various forms is the often lack of mention of any specific activity, whether it is commerce or some stage of production. The only fact mentioned is that the occupation deals with flax-linen, which is indeed ambiguous. English does not have a conventional word for accurate translation of these terms without applying circumlocution. The Spanish “linero” is an excellent candidate. Innovative terms, either “flaxman”<sup>218</sup> or “flaxist”<sup>219</sup> would serve this purpose well. We will attempt to extrapolate each name’s more definite application from its contexts, but that does not eliminate the possibility that the same occupational name included additional applications.

-----

1) **‘ōsei pištān** (Hb pl.). Flax makers or producers.<sup>220</sup>

*Qasiya* (leather gloves) of *zor<sup>o</sup>ei g<sup>o</sup>ranot* (winnowers of granaries), of *hol<sup>o</sup>kei d<sup>o</sup>raḳim* (wayfarers), of **‘ōsei pištān** (flax makers or producers) – are susceptible to (halakhic) impurity. But those of *šabba<sup>i</sup>im* (dyers) and of *nappaḥim* (blacksmiths) are insusceptible...” (Mishna Kelim 16:6)

This occupational name embodies both the material used and the procedure performed, at least in general. Therefore we have translated “flax producers” – in accordance with the participle’s meaning. In order to determine in what specific activity these “flax producers” are engaged, we must

identify the purpose of this leather glove. Perhaps it is worn while pulling flax in the field, both to enable a good grip on the plants and to prevent wounding the hands – thus they are “flax pullers”.<sup>221</sup> Or it is worn during the subsequent braking, scutching and hackling processes – again enabling a good grip on the stalks and fibers while working – they are “flax brakers”, “flax scutchers” or “flax hacklers”.

Notice should be taken of the two groups of occupational names in this subchapter, arranged by rhyme and prosody: 1) *zor<sup>o</sup>ei g<sup>o</sup>ranot*, *hol<sup>o</sup>kei d<sup>o</sup>raḳim*, *‘ōsei pištān* – all plural participles. 2) *šabba<sup>i</sup>im*, *nappaḥim* – both in the qāṭṭāl pattern, in plural form. We will mention this phenomenon in the **kattān** entry.

An additional direction of inference to differentiate between the two occupational names – **kattān** (*infra*) and the current *‘ōsei pištān* is by comparison with a similar pair of occupational names – *zāggāg* and *‘ōsei z<sup>o</sup>kūḳīt*. Both occupations are glass workers, and appear jointly in the same subchapter of Mishna (Kelim 8:9) and Tosefta (Kelim Baḥa M<sup>o</sup>ṣṭ’a 3:10) or separately (*zāggāg*– Mishna Kelim 24:8, *‘ōsei z<sup>o</sup>kūḳīt* - Tosefta Kelim Bava M<sup>o</sup>ṣṭ’a 3:11). The joint appearances indicate that they are two different occupations, not synonyms. Here, as in our own context, *zāggāg* is in qāṭṭāl form, based on the material being worked with – glass. A literal translation would be “glazier” notwithstanding the current dictionary definition – “one who fits glass into windows”, or a synthetic “glassman” or “glassist”. And just as “*√ktn*”, “*√zgg*” is an Aramaic nominal root, imported into the Mishna. These have become Hebrew words.

218. All of the current *nomina agentis* appear in masculine gender in rabbinical literature, which is the default option. Other, predominantly or exclusively women’s occupations, may appear in feminine gender, cf. *mōz<sup>r</sup>rōt* (spinners or plyers) *mzr<sup>l</sup> supra*, *‘ō<sup>r</sup>rgōt* (weavers), *tōwōt* (spinners). *Sārōqōt* (*infra*) is the exclusive non-gendered plural form of the *qāṭōl* *nomina agentis*. According to Tosefta Qidushin 5:14, they are men.

219. English language occupational names, often based upon the material or object involved, may appear with suffixes “-ist” and “-man”. Due to the intended vagueness of our proposals, it is equally possible that he is a **flax craftsman, tradesman, or transporter**. Cf. cowman, horseman, iceman, laundryman, milkman, woolman, etc. And florist, colorist, machinist, etc.

220. Cf. Isaiah 19:9 “Flax workers (“*‘ōhdei pištūm*”) too shall be dismayed, both hacklers and weavers of white (or: ‘nets’) chagrined.”

221. Moore 1922, 86: “These experts are ever ready to explain the knack which ensures no blistering of hands and no creaking of stooped backs...” Ibid. 87-88: “Pulling flax calls for skill... A schoolmaster, who presumes himself to be adept, is eager to demonstrate to others the right finesse of the pulling art. Just a few minutes later he has retired... to have oiled silk affixed to his lacerated finger.” DeWilde 1999, 53-54: “Another frequent inconvenience, especially with the young pullers, was the blisters that formed on the hands... Pricks from thistles and other weeds sometimes caused chaps or other wounds...”

In contrast,  $\text{ʿōsei z}^{\text{ʿ}}\text{kū}^{\text{ʿ}}\text{kī}^{\text{ʿ}}$ , are literally “glass producers”. Grossmark<sup>222</sup> identifies “ $\text{ʿōsei z}^{\text{ʿ}}\text{kū}^{\text{ʿ}}\text{kī}^{\text{ʿ}}$ ” as the producers of slabs or chunks of glass – the raw material, and “ $\text{zāggāg}$ ” as the artisan who manufactures (and often sells them himself) glass utensils – the end product. Perhaps the redactors of the Mishnah were consistent in this formula, and we may deduce that “ $\text{ʿōsei pištan}$ ” is one who works in early stages of production (e.g. pulling – with gloves), and “ $\text{kāttān}$ ” in later stages of production (e.g. hackling – with an apron).

## 2) **Būšʿai** > **Būšʿaʿei** (Ar). A flaxman or flaxist.

“When the *Sanhedrin* ceased to exist, song ceased from the places of feasting; as it is said, they shall not drink wine with a song...” (Mishna Soṭa, 9:11)

The authority of the *Sanhedrin* (‘Synedrion’ – the supreme court of Israel) was terminated by Roman General Gabinius in the middle of the first century BCE.<sup>223</sup> That was considered a national disaster, and as a result appropriately solemn behavior was enacted. Among the restrictions, certain types of song were prohibited. This concept is based upon the HB verse: “They drink their wine without song...” (Isaiah 24:9).

The Talmud discusses the above Mishnaic law. “Rav Huna said: The singing of boat-draggers and herdsmen is permitted, but that of weavers is prohibited.” (BT Soṭa 48a)

Here, the Talmud discerns between different types of song, for the purpose of defining their respective legal standing in this context. Apparently, singing only assists the boat-draggers and herdsmen in their work and is considered solemn, and therefore permissible. In contrast, the singing of weavers it is joyful and therefore forbidden, because it contradicts the appropriately solemn

national mood.<sup>224</sup> These historical work songs are not currently identifiable.

Šʿeltōt of Aḥai Gaon<sup>225</sup> (a post-Talmudic work) adds (or: ‘reads’): “...but that of weavers **and būšʿaʿei** is forbidden.”<sup>226</sup>

**Būšʿaʿei** are “flaxists”, as no specific activity is inferred, only the material dealt with.<sup>226b</sup> From this source, we cannot correctly extrapolate which activity in the production process is performed by them. We have chosen “flaxist” (cf. *supra*), an occupational name consisting of the material used with an added noun suffix, as an attempt to accurately and elegantly reflect the original terminology.

This agent noun is a *hapax legomenon* in Talmudic and post-Talmudic literature. It is parallel in form to the Hebrew *pištani/pištanim* and Aramaic *kitaṅʿai/kitaṅʿaʿei*.

## 3) **Kāttān** (Hb). A flaxman or flaxist.

“These hides are susceptible to “*mīdrās*” (a specific class of halakhic impurity)... the hide of the *ḥāmmār* (donkey driver), the hide of the **kāttān** (flaxman), the hide of the *kāttāp* (porter<sup>227</sup>)...” (Mishna Kelīm 26:5)

This occupational name requires some linguistic explanation. Despite the Mishnah being a primarily Hebrew language work, an imported Aramaic nominal root  $\sqrt{\text{ktn}}$  is employed here,<sup>228</sup> in the Hebrew *qāṭṭāl* pattern of *nomina agentis*, thus resulting in a Mishnaic *hapax legomenon*. Perhaps this relatively uncommon stylistic choice was deemed necessary by the editors of the Mishna (and Tosefta - *infra*) which was intended primarily for oral rote learning - in order to avoid the aural ambiguity of the possible Hebrew “*pāššāt*” (flaxman, extracted from “*pešet*”) and “*pāššāt*”

222. Grossmark 2008, 47.

223. Cf. Josephus, Ant. XIV, v. 4.

224. Mirsky 1977, 50.

225. Rav Aḥai Gaon, Babylonia 680 - LOI 752 AD.

226. Cf. Mirsky 1977, 50. Epstein 1987, 438.

226b. Cf. *Būš supra*.

227. Literally, a “shoulderer”.

228. Gluska 1987, V-VI.

(animal skinner) - both of which could well use an apron while working. During the Mishnaic period, the differentiation in pronunciation between emphatic consonants and their respective contrasting non-emphatic (”ט” vs. “t”) had been weakened, and as a result these became homophones (albeit not homograms). The use of the Aramaic root in qāṭṭāl form here, and not the more expected Hebrew “ōsei pištān” - flax producers (Mishna Kelim 16:6), is also necessitated by the poetic character of Mishnah, which incorporates rhyming and prosodic passages. This particular subchapter lists leather products related to various uses and occupations, which are in turn grouped for rhyme and prosody: 1) “hide of s’cortīā’ (table-cover), 2) hide of qatabolīā’ (bed-cover) – both Greek loanwords; 3) hide of the ḥāmmār (donkey-driver), 4) hide of the kāttān (flaxman), 5) hide of the kāttāp (porter) – all qāṭṭāl pattern agent nouns. A pertinent parallel to this prosodic phenomenon may be offered from the same tractate (16:6) in context with “ōsei pištān”, and has been discussed *supra*.

The specific activity of the kāttān is unclear; as a result we prefer to translate “flaxman”, as the most faithful representation of the original term which does not allude to any specific activity, only to the material being dealt with.

Maimonides, in his commentary to the Mishnah *ad loc.* identifies these particular hides as aprons. He explains that the worker is engaged in scutching or hackling and that the leather apron protects his garments from tow, shives and dust – a “flax scutcher”.<sup>229</sup> Other possibilities are that the apron is worn while pulling the flax straw from the retting water hence a “flax retter”<sup>230</sup> and subsequently

while “gaiting” or “stooking” for drying – a “flax stooker”. In that case, the leather apron protects the worker’s clothes (at least partially) from becoming wet and malodorous. We also find that in modern Flanders, a leather apron was worn by “flax pullers”, to protect their garments from dew.<sup>231</sup> In modern industrial wet-spinning, waterproof bibs and aprons were donned by workers.<sup>232</sup>

The parallel Tosefta (Kelim Bābā Bātrā 4:8) repeats this term. In one variant (Zukermantel edition) “pāttān” replaces kāttān. Perhaps this is a visual-mistake (graphic) scribal error, or “permutation”, for these two Hebrew letters “k” (כ) and “p” (פ) are similarly shaped.<sup>233</sup> In addition, kāttān is a *hapax* and unfamiliar to the scribe. Another possibility may be suggested, that this variant represents an attempt (or a textual tradition) in which this qāṭṭāl patterned *nomen agentis* is based on the Mishnaic Hebrew pštān (deleting the “š” from the quadruple form<sup>234</sup>), instead of the Aramaic “kītān”.

4) **Kītān’āi, Kītānyā’** (definite) > **Kītān’ā’ei** (Ar). A flaxman or flaxist – flax worker, flax merchant.<sup>235</sup> See *supra*: **Ḥanwātā, Hōšen** (JT Pe’<sup>2</sup>a 16a), **Qōfnā** (JT Šābbāt 10a), **dwš**√, **npš**√. DJPA 257.

5) **Pištānī** (Hb). A flaxman or flaxist. There are three examples: “Once a young girl entered to obtain flax from the (“pištānī”) flaxman, and he said to her: ‘this is for your engagement<sup>236</sup> to me’”. (JT Y<sup>2</sup>ḥāmōt 13g). It is difficult to identify the specific procedure performed by this **pištānī**, other than being a merchant of flax or linen.

“This (“pištānī”) flaxman, at the time he knows

229. “Breaking Flax”, c.1850-1851, painting by Jean-Francois Millet (Normandy – Paris). <http://www.jeanmillet.org/Breaking-Flax,-c.1850-51.html> DeWilde 1999, 82.

230. DeWilde 1999, 128. This was originally a **leather** apron.

231. DeWilde 1999, 50.

232. Carter 1920, 81.

233. See however: Lieberman 1939, Part 3, 83 who rejects this reading.

234. The middle consonant of this qāṭṭāl pattern is **not actually doubled** in Hebrew, it is emphasized by a dot in its center (in this case: ‘n’), called ‘*dageš characteristic*’. Nevertheless, scientific transliteration requires doubling the English consonant. Also worthy of mention, the parallel Phoenician root is √ptt. Nevertheless, this is certainly unknown to the Mishna.

235. An unpublished 5<sup>th</sup> century AD plaster inscription from the R<sup>2</sup>ḥōḥ synagogue in the Beth Shean Valley mentions “*ktnh*” (*Nomina agentis*). Dr. Hagai Misgav, personal correspondence.

236. The attempt to engage her was later deemed invalid.

that his flax is strong, the more he beats it – the finer and shinier it gets, and when he knows that it is weak he doesn't even beat it more than once and it breaks up..." (BR 32:3 Vatican codex 30). See: **ktš**√. This **pīštānī** is a flax beater (or: "beetler").

"This ("pīštānī") flaxman, his camels entered loaded with flax. The collier wondered: 'How where can all that flax fit in?' There was an ingenious person on hand who remarked: 'One spark from your bellows and the flax will burn up!'" (Rashi to Genesis 37:1<sup>237</sup>). In this case, the **pīštānī** is probably either a merchant or transporter of flax straw.<sup>238</sup>

### *Temporary and auxiliary professions*

#### *Commerce*

6) **Hāwā 'āseq ('āsīq)**<sup>239</sup> ≈ **'āsāq bāhādā kītānā**<sup>240</sup> (Ar). "(He) was engaged in, or was dealing with flax". This indicates a long term affiliation with the occupation. Further details are gleaned from context. "Rabbi Zerā' was engaged in flax. He went to ask Rabbi Abhū: 'Am I permitted to improve

the appearance<sup>241</sup> of the flax (which may be deceptive to a prospective consumer, and gain a higher price)? Rabbi Abhū answered: 'You may do as you see fit!'" (JT Bāḅā Mʿšī'ā 9d). Apparently, Rabbi Zerā' is a merchant of flax fibers. "(Rabbi) Šim'on Ben Šeṭāḥ was engaged with that flax. His pupils told him: 'Rabbi! Release yourself from that, and we will buy you a donkey so that you will not have to exert yourself.'" (JT Bāḅā Mʿšī'ā 8g). Perhaps Šim'on Ben Šeṭāḥ was a flax merchant and he himself had delivered the merchandise while functioning as a porter.<sup>242</sup>

7) **Hāwā lei kītān** (Ar). "(He) had flax". This indicates a short term affiliation with this occupation. "Rav (PN) had flax and it was damaged<sup>243</sup>. He asked Rabbi Hīyyā Rūbā<sup>244</sup> (the elder): 'Am I permitted to slaughter a fowl and mix its blood into the flax seed?'"<sup>245</sup> (JT Ma'aser Šenī 56d, BT Hūlīn 85b<sup>246</sup>). Presumably, Rav had cultivated flax.

8) **Broker** "Rav Kahana made a down payment<sup>247</sup> on flax,<sup>248</sup> later on it became more expensive.<sup>249</sup> The owners (or: 'customers') of the flax bought

237. Probably quoted from a rabbinical midrash aggada, which is not currently known.

238. Note terminological differentiation between occupations. "Collier" is a charcoal producer, while "coalman" is one who delivers coal to houses. [http://www.etymonline.com/index.php?term=collier&allowed\\_in\\_frame=0](http://www.etymonline.com/index.php?term=collier&allowed_in_frame=0) <http://www.oxforddictionaries.com/definition/english/coalman>

239. The two different possible vocalizations represent either the active or passive forms of the participle. The original text is not vocalized.

240. Perhaps: "Was once dealing with flax."

241. It is unclear to me exactly how that would be done (NBY).

242. Mishna Bāḅā Qāmā 3:5 describes various encounters between two porters in which an accident and subsequent damage occurs. One encounter involves a collision between a porter of flax (straw) and one carrying a (burning) lamp. Small quantities of flax could be delivered by porter instead of by beast of burden.

243. It is unclear exactly what happened. Perhaps the seed had gone bad (become moldy?) and he knew that it would not properly germinate, or he had made a test plot, or there was still enough time to re-sow his field after germination failure, so he sought a way to cure the malady with fowl blood.

244. Rabbi Hīyyā himself had raised flax, at least once. Cf. *supra* √**gdI**, **Nāšbā**.

245. According to Biblical law, (most of) the blood of a slaughtered fowl must be covered with soil, and not otherwise used. After HB Leviticus 17:13 "And if any Israelite or any stranger who resides among them hunts down an animal or a bird that may be eaten, he shall pour out its blood and cover it with earth."

246. In the BT version, Rabbi Hīyyā is he who had the flax and asked Rabi (PN) the question.

247. It is not clear if he did this just once, or was accustomed to doing so. Also unclear if this was for his own purchase, or that he was acting as an intermediary for clients.

248. Perhaps a flax crop growing in the field, or possibly other intermediate stages of production.

249. The reason is not indicated, probably price fluctuations in the marketplace.

it themselves and reimbursed Rav Kahana.” (BT Bāḥā Mʿṣīʿā 49a, Bāḥā Qāmā 103a, JT Bāḥā Mʿṣīʿā 10g). “Ṭbo (PN) deposited flax at the estate of Bar Ronia (PN). The flax was stolen...” (BT Bāḥā Mʿṣīʿā 93b).<sup>250</sup>

### Comber

9) **Sōreq** ± **Sārōq** > **Sārōqōṭ** (Hb). Flax ‘hackler’ or wool ‘comber’.<sup>251</sup> See: **srq**√, **Māsreq**, and **Sereq** *supra*. “...the hide of the (‘sōreq’) comber...” (Mishna Kelīm 26:5). Major commentators<sup>252</sup> of the Mishna have interpreted this as either a flax hackler or wool comber.<sup>253</sup> “The rod of the (‘sārōqōṭ’) combers’ scale...” (Mishna Kelim 12:2). Maimonides in his commentary to the Mishna explains that a scale of this type is used both by wool combers and flax hacklers. {18}

### Conclusions and Future Research

In this paper we have compiled and analyzed the textile terminology of flax and linen in Talmudic (rabbinical) literature. We have found that there is quite an extensive vocabulary for this field. That may well indicate certain ethnographic characteristics, such as the centrality of flax-linen production and use in the Talmudic era Jewish society of the Land of Israel and Babylonia.<sup>254</sup> In addition, virtually all of these terms are linguistically Semitic, *i.e.* Hebrew or Aramaic.<sup>255</sup> This contrasts to Talmudic nautical terminology, which consists almost entirely of Greek loanwords.<sup>256</sup> The primarily Semitic vocabulary aspect may indicate an indigenous and perhaps ancient industry.

Research is never complete. Future expansion of this topic may proceed in various directions. In

addition to flax and linen, wools and silks have a significant place in this literature, and their respective terminologies should be treated in a similar fashion. The etymologies of the terms may be further pursued. Illustrations of the materials mentioned (*e.g.* textiles and implements) from contemporaneous archaeological finds in the appropriate regions may be furnished and their relation to the texts analyzed.<sup>257</sup> Parallel and geographically adjacent contemporaneous literary sources, such as Latin, Greek,<sup>258</sup> Syriac, Mandaic and Middle Persian (Pahlavi) can be examined and their terminology’s relation to the Talmudic terminology analyzed. And, as mentioned in the introduction to this paper, semantic nuances within Talmudic literature itself, emanating from various tradents, dialects, time periods and locales can be addressed.

### Bibliography

#### *Primary Jewish sources*

##### *HB translations*

##### *Aramaic:*

Targum Onqelos (to the Pentateuch): Miqraot Gedolot Ha-Keter. 2012. Ramat Gan.

Targum Neophiti (to the Pentateuch): Macho A.D. (ed.), Consejo Superior de Investigaciones Cientificas. 1968-1979. Madrid.

Targum Yonatan (to the Prophets): Miqraot Gedolot Ha-Keter. 2012. Ramat Gan.

Targum Proverbs: <http://call.cn.huc.edu/showtargum.php>

Peshitta (Syriac Targum to the HB): The Old Testament in Syriac According to the Peshitta Version. 1979. Leiden.

250. Insight into this issue is from Beer 1974, 189-191 - although I have altered it somewhat.

251. Wool “carding”, as opposed to “combing”, did not exist until the Middle Ages. (John Peter Wild, personal correspondence.)

252. Ovadiah ben Abraham of Bartenura (*c.* 1445, Bertinoro, Italy - *c.* 1515, Jerusalem), and Shʿlomo bar Yʿhoshua Adeni (1567-1625, Ṣanʿa and Aden in southern Arabia).

253. See also: Ayali 1984, 49-50.

254. The well-known legend maintains that there are innumerable terms for camels in Arabic, as a result of the camel’s centrality in Arab society.

255. Qānābūs, Qōpnā, and Qāsiyā are foreign loan-words.

256. After Sperber 1986, with my own deductive conclusion (NBY).

257. Discrepancy between historical literary, iconographic and archaeological sources is a well-known and challenging phenomenon.

258. See: Georgacas 1959.

*Other Languages:*

JPS: Jewish Publication Society <http://taggedtanakh.org/>  
(This is the default translation used in the paper, unless otherwise indicated.)

KJV: King James Version <https://www.biblegateway.com/versions/King-James-Version-KJV-Bible/>

LUT: Luther <https://www.die-bibel.de/online-bibel/luther-bibel-1984/bibeltxt/>

LXX: Septuagint <http://www.ellopos.net/elpenor/greek-texts/septuagint/>

NIV: New International Version <https://www.biblegateway.com/passage/?search=1+Chronicles+1&version=NIV>

RVR: Reina-Valera <https://www.biblegateway.com/versions/Reina-Valera-1960-RVR1960-Biblia/>

VUL: Vulgate <http://vulgate.org/>

*Mishnah:*

Vilna edition (1880)

Codices: <http://www.jnul.huji.ac.il/dl/talmud/mishna/selectmi.asp>

*Tosefta:*

Tractate Kelim. Zukermandel edition. 1974. Jerusalem.

The Order of Zera'im. With Brief Commentary by Liberman S. 1955-1988. New York.

Tosefta Ki-Pshutah: A Comprehensive Commentary on the Tosefta by Liberman S. 1988. New York.

Codices: <http://www.jnul.huji.ac.il/dl/talmud/tosefta/selectti.asp>

*Jerusalem Talmud:*

Venice edition (1522)

Leiden codex (1289): <http://maagarim.hebrew-academy.org.il/Pages/PMain.aspx>

Tractate Ma'asrot - The Jerusalem Talmud. Annotated critical edition by Feliks Y. 2005. Ramat Gan.

Tractate Šeḥitot - The Jerusalem Talmud. Annotated critical edition by Feliks Y. 1980. Jerusalem.

*Babylonian Talmud:*

Vilna edition (1870)

Codices: <http://www.jnul.huji.ac.il/dl/talmud/bavly/selectbavly.asp>

*Midrash Aggada:*

Midrash Bereshit Rabba. Theodor-Albeck edition. 1903. Berlin.

Codex Vatican 30: <http://maagarim.hebrew-academy.org.il/Pages/PMain.aspx>

Midrash Tanḥuma. 1874. Warsaw.

Midrash Tehilim. Buber edition. 1890. Vilna.

*Post-Talmudic works:*

Sh<sup>o</sup>eltot de Rab Ahai Gaon. Mirsky S. (ed.) Vol. V. 1977. Jerusalem.

Maimonides M. Commentary to the Mishnah (1168 CE). Translated to Hebrew by Qafiḥ Y. 1967. Jerusalem.

Rashi – R' Sh<sup>o</sup>lomo Yīṣḥaḳi, commentary to the Pentateuch. Miqraot Gedolot HaKeter. 2012. Ramat Gan.

Rashi – R' Sh<sup>o</sup>lomo Yīṣḥaḳi, commentary to the Babylonian Talmud. 1880-1886. Vilna.

*Primary Sources – General*

Columella, Lucius Junius Moderatus. *On agriculture*, with a recension of the text and an English translation by Ash H. B. Vol. I. 1941-1955. Cambridge.

Diocletian, Edict of. Appendix by Glaser E.R. 307-421. In T. Frank (ed.), *Rome and Italy of the Empire*. Vol. 5. 1959. Paterson.

Diocletian, *Preisedikt*. Ed. Lauffer S. 1971. Berlin.

*Expositio totius mundi et gentium*. Translated by Stern M. In *Greek and Latin authors on Jews and Judaism*. 1974-1984. Jerusalem.

Pausanias, *Description of Greece*. Translated by Jones W. H. S. & Ormerod H. A. 1935. Cambridge.

Pliny, *Natural History*. Ed. Rackham H., Jones W. H. S. & Eichholz D. E. 1949-54. Cambridge.

Strabo, *The geography of Strabo*. Translated by Falconer, W. 1903. London.

Theodosian Code. Ed. Pharr C. 1952. New York.

Xenophon, *On Hunting*. Translated by Bowersock, G. W. 1925. London.

*Modern sources*

*Dictionaries and Lexicons, Biblical and Talmudic research*

ASTM Standard Terminology Relating to Flax and Linen (D 6789-02) <http://ldg.kupoo.com/public/upload/media/ASTM%20D6798-02.pdf>

Ayali, M. (1984) A Nomenclature of Workers and Artisans in the Talmudic and Midrashic Literature (in Hebrew). Tel Aviv.

Catane, M. (1996) *Recueil des Gloses*. Jerusalem.

Demsky, A. (1966) *The Houses of Achzib: A Critical*

- Note on Micah 1:14b, *Israel Exploration Journal* 16, 211-215.
- Denton, M. J. & P. N. Daniels (eds.) (2002) *Textile Terms and Definitions*. Manchester.
- Dickson, P. (2006) *Dictionary of Middle Egyptian*. <http://www.pyramidtextsonline.com/documents/DicksonDictionary.pdf>
- Gesenius, W. (1987) *Hebräisches und Aramäisches Handwörterbuch über das Alte Testament*. Rütterswörden U., Meyer R. & Donner H., revisers. Berlin.
- Hilman, Y. (2016) Gentilic: Biblical Hebrew. In G. Khan (ed.), *Encyclopedia of Hebrew Language and Linguistics*. [http://referenceworks.brillonline.com/entries/encyclopedia-of-hebrew-language-and-linguistics/gentilic-biblical-hebrew-EHLL\\_COM\\_00000376](http://referenceworks.brillonline.com/entries/encyclopedia-of-hebrew-language-and-linguistics/gentilic-biblical-hebrew-EHLL_COM_00000376)
- Hurvitz, A. (2014) *A Concise Lexicon of Late Biblical Hebrew*. Leiden.
- Jastrow, M. (1903) *A Dictionary of the Targumim, the Talmud Babli and Yerushalmi, and the Midrashic literature: with an Index of Scriptural Quotations*. London.
- Kadari, M. Z. (2006) *Dictionary of Biblical Hebrew*. Ramat Gan. (in Hebrew)
- Koehler, L. & W. Baumgartner (1994) *The Hebrew and Aramaic Lexicon of the Old Testament*. Leiden. [HALOT]
- Kohut, A. (1878) *‘Arukh HaShalem*. New York. (Reprint 1955) (in Hebrew)
- Liddell, H. G. & R. Scott (1996) *A Greek-English Lexicon*. Oxford.
- Lieberman, S. (1967) *Tosefta Ki-Pshuṭah – A comprehensive commentary on the Tosefta*. Part IV – Order Nashim. New York. (in Hebrew)
- Liebermann, S. (1939) *Tosefet Rishonim*. Jerusalem.
- Melamed, E. Z. (1992) *Hebrew Aramaic Dictionary*. Jerusalem. (in Hebrew)
- Melamed, E. Z. (1973) *An Introduction to Talmudic Literature*. Jerusalem. (in Hebrew)
- Murtonen, A. (1990) *Hebrew in its Western Semitic Setting*. Leiden.
- Online Etymology Dictionary <http://www.etymonline.com>
- Oxford Bible Studies Online <http://www.oxfordbiblical-studies.com>
- Sokoloff, M. (2009) *A Syriac Lexicon. A Translation from the Latin, Correction, Expansion, and Update of C. Brockelmann's Lexicon Syriacum*. Winona Lake-Piscataway.
- Sokoloff, M. (2002a) *A Dictionary of Jewish Babylonian Aramaic*. Ramat Gan-Baltimore.
- Sokoloff, M. (2002b) *A Dictionary of Jewish Palestinian Aramaic*. Ramat Gan-Baltimore.
- Textile history and technology*
- Alfaro Giner, C. (1984) *Tejido y cestería en la península ibérica*. Madrid.
- Allgrove-McDowell, J. (2003) Ancient Egypt 5000-332 BC. In D. Jenkins (ed.) *The Cambridge History of Western Textiles*, Vol. I. Cambridge.
- Barber, E. J. W. (1991) *Prehistoric Textiles*. Princeton.
- Bradbury, F. (1920) *Flax Culture and Preparation*. London.
- Carter, H. R. (1920) *Flax and its Products*. London.
- Carter, H. R. (1919) *The Spinning and Twisting of Long Vegetable Fibres*. London.
- Cleland, L., Davies, G. & L. Llewellyn-Jones (2008) *Greek and Roman Dress from A to Z*. London.
- Córdoba De La Llave, R. (1990) *La industria medieval de Córdoba*. Córdoba.
- Cruickshank, P. (2011), Flax in Croatia, *Textile History* 42 (2), 239-260.
- Curchin, L. (1985) Men of the Cloth: Reflexions on the Roman linen trade, based on a new document from Bordeaux, *Liverpool Classical Monthly*. Vol. 10, no. 1. 34-35.
- DeWilde, B. (1999) *Flax in Flanders Throughout the Centuries*. Tiel.
- Davidson, J. (2012) *Nets Through Time*. Rockland.
- Dalman, G. (1937) *Arbeit und Sitte in Palästina. Band V: Webstoff, Spinnen Weben Kleidung*. Hildesheim. (Reprint 1964).
- Flohr, M. (2013) *The World of the Fullo*. Oxford.
- Freckmann, K. et al. (1979) *Flachs im Rheinland: Anbau und Verarbeitung*. Köln.
- Georgacas, D. J. (1959) Greek Terms for “Flax”, “Linen”, and Their Derivatives; And the Problem of Native Egyptian Phonological Influence on the Greek of Egypt, *Dumbarton Oaks Papers*, Vol. 13, 253-269. Washington.
- Granger-Taylor, H. (1987) The Emperor’s Clothes: The Fold Lines, *The Bulletin of the Cleveland Museum of Art*. Vol. 74, no. 3, 114-123.
- Hall, A. J. (1957) *A Handbook of Textile Finishing*. London.
- Hann, M. (2005) Innovation in Linen Manufacture. *Textile Progress*, Vol. 37 No. 3. Cambridge.
- Hellinger, E. (1951) A comparative Study of certain Clostridia from Flax-retting Liquors in Israel, *Bulletin of the Research Council of Israel*, Vol. 1, nos. 1-2, March 1951. Jerusalem.
- Jerrard, M. (2000) *Organisation of the Roman clothing and textile industry: skill, occupation, and the*



- gender-segmented workforce*. Caulfield East, Vic. Monash University.
- Kempa, E. & K. Bartoszewski (1992) Treatment and use of retting effluent. In S. Sharma & C. F. Van Sumere (eds.), *The Biology and Processing of Flax*. Belfast.
- Kernaghan, K. & P. Kiekens (1992) Bleaching and Dyeing of Linen. In S. Sharma & C. F. Van Sumere (eds.), *The Biology and Processing of Flax*, Belfast.
- Kozłowski, R. M., Mackiewicz-Talarczyk, M. & A. M. Al-lam (2012) Bast fibres: flax. In R. M. Kozłowski (ed.), *Handbook of Natural Fibres*. Cambridge.
- Kozłowski, R. (1992) Retting of Flax in Poland. In S. Sharma & C. F. Van Sumere (eds.), *The Biology and Processing of Flax*. Belfast.
- Leibner, U. (2009) *Settlement and History in Hellenistic Roman and Byzantine Galilee*. Tübingen.
- Marzuq, M. (1955) *History of Textile Industry in Alexandria 331 B.C. – 1517 A.D.* Alexandria, Egypt.
- Moore, A. (1922) *Linen*. London.
- Meek, K. (2000) *Reflections from a Flaxen Past*. Alpena.
- Rahman, A. (1963) *A Study of the Flax-Retting Members of the Genus Clostridium* (PhD thesis). Leeds. University of Leeds.
- Shatzmiller, M. (1994) *Labour in the Medieval Islamic World*. Leiden.
- Sperber, D. (2014) On the Press (Māḳbeš), *Sidra* 29, 149-159. (In Hebrew)
- Veiga de Oliveira, E., Galhano, F., & B. Pereira (1978) *O Linho: Tecnologia Tradicional Portuguesa*. Lisboa.
- Vogelsang-Eastwood, G. (1992) *The Production of Linen in Pharaonic Egypt*. Leiden.
- Warden, A. J. (1864) *The Linen Trade*. London. (Reprint 1967)
- Weindling, L. (1947) *Long Vegetable Fibers*. New York.
- Wild, J. P. (2003) The Hellenistic World 323-31 BC. In D. Jenkins (ed.), *The Cambridge History of Western Textiles*, Vol. I. Cambridge.
- Wild, J. P. (1969) The *Tarsikarios*, a Roman Linen-Weaver in Egypt. In J. [Bibauw \(ed.\)](#), *Homages à Marcel Renard II*, 810-891. Bruxelles.
- Wild, J. P. (1968) The Roman Flax Hackle ('aena'), *Museum Helveticum* 25, 139-142.
- Wild, J. P. (1967) The Gynaecium at Venta and its Context, *Latomis*. T. 26, Fas. 3. July-September 1967, 648-676.
- Wipszycka, E. (1965) *L'Industrie Textile dans L'Egypte Romaine*. Wrocław. Zakładu Narodowego im. Ossolińskich.
- Woodhouse, T. (1928) *The Finishing of Jute and Linen Fabrics*. London.
- Linguistics*
- Bendavid, A. (1971) *Lashon Miqra and Lashon Hakhamim*. Tel Aviv. (in Hebrew).
- Ben-Ḥayim, Z. (1972) Samaritan Linguistic Tradition and its Relation to that of the Dead Sea Scrolls and the Sages. In M. Bar-Asher (ed.), *Qovetz Ma'amarim Bilshon Hazal*. Jerusalem. (in Hebrew)
- Epstein, J. N. (1987) *Studies in Talmudic Literature and Semitic Languages*, Vol. I. Magnes. Jerusalem. (in Hebrew)
- Gluska, I. (1987) *The Influences of Aramaic on Mishnaic Hebrew* (PhD thesis). Ramat Gan. Bar Ilan University. (in Hebrew)
- Grintz, Y. (1975) Ancient Terms in Torat Kohanim, *Lěšonenu* 39, 5-20. (in Hebrew)
- Gross, B. Z. (1994) *HaMishqalim Pa'alon and Pa'alan baMiqra u'vLashon Hakhamim*. Jerusalem. (in Hebrew)
- Kautsch, E. & A. E. Cowley (1966) *Gesenius' Hebrew Grammar*. Oxford.
- Kutscher, Y. (1961) *Words and their History*. Jerusalem. (in Hebrew)
- Lambdin, T. O. (1953) Egyptian Loan Words in the Old Testament, *Journal of the American Oriental Society*, Vol. 73, No. 3. 145-155.
- Morag, S. (1995) *Studies in Biblical Language*. Jerusalem. (in Hebrew)
- Historiography – general*
- Amar, Z. (2000) *Agricultural Produce in the Land of Israel in the Middle Ages*. Jerusalem. (in Hebrew).
- Amar, Z. (2012) *Flora of the Bible*. Jerusalem. (in Hebrew).
- Beer, M. (1974) *The Babylonian Amoraim: Aspects of Economic Life*. Ramat Gan. (In Hebrew)
- Blackwell, B. (1974) The Cloth Industry Under the Roman Empire. In Jones, A. H. M. *The Roman Economy*, Ch. 18. Oxford.
- Borowski, O. (2002) *Agriculture in Iron Age Israel*. Boston.
- Ertuğ, F. (2000) Linseed oil and oil mills in central Turkey. Flax/*Linum* and *Eruca*, important oil plants of Anatolia, *Anatolian Studies* Vol. 50, 171-185.
- Feliks, Y. (1968) *Plant World of the Bible*. Ramat Gan.
- Feliks, Y. (1963) *Agriculture in Palestine in the Period of the Mishna and the Talmud*. Jerusalem. (in Hebrew)
- Forbes, R. J. (1956) *Studies in Ancient Technology*, Vol. IV. Leiden.
- Gil'ad, H. (1976) The Gezer Calendar in Light of Agricultural Realia, *Bet Miqra* 21, 543-550. (in Hebrew)

- Grossmark, T. (2008) And He Instituted Impurity for Glass Utensils, *Katedra* 127, Nisan 5768, 33-44. (in Hebrew)
- Herszberg, A. S. (1924) *Cultural Life in Israel – During the Mishnaic and Talmudic Periods*. Warszawa. (in Hebrew).
- Krauss, S. (1945) *Qadmoniot HaTalmud (Talmudic Antiquities)*. Vol. 2, Part 2. Tel Aviv. (in Hebrew)
- Kasher, A. (1985) *The Jews in Hellenistic and Roman Egypt*. Tubingen.
- Kasher, A. (1979) *The Jews of Hellenist and Roman Egypt and their struggle for Rights*. Tel Aviv. (in Hebrew)
- Macquet, C. (1990) Les lissoirs de verre, approche technique et bibliographique, *Archéologie médiévale*, 20, 319-334.
- Noss, A. (1976) *Før strykejernet: slikkejake og mangle-tre*. Oslo.
- Retzleff, A. & A. M. Mjely (2004) Seat Inscriptions in the Odeum at Gerasa (Jerash), *Bulletin of the American Schools of Oriental Research* 336, 37-41.
- Rosenfeld, B. Z. & J. Menirav (1999) The Ancient Synagogue as an Economic Center, *Journal of Near Eastern Studies*, Vol. 58 no. 4, 259-276.
- Safrai, Z. (1995) *The Jewish community in the Land of Israel during the Mishnaic and Talmudic Periods*. Jerusalem. (in Hebrew)
- Safrai, Z. (1994) *The Economy of Roman Palestine*. London.
- Safrai, Z. & M. Lin (1988) The Economic Structure of Geva. In B. Mazar (ed.). *Geva*. Tel Aviv. (in Hebrew)
- Scott, J. G. (1953-55) A Glass Linen Smoother of Viking Type from Kirkcudbright. In *Proceedings of the Society of Antiquaries of Scotland*. Vol. 88, 226-227.
- Sperber, D. (1976) Objects of Trade Between Palestine and Egypt in Roman Times, *Journal of the Economic and Social History of the Orient*, Vol. XIX, 113-147.
- Steppuhn, P. (1998) *Die Glasfunde von Haithabu. Berichte über die Ausgrabungen in Haithabu*. Neumünster.
- Talmon, S. (1968) The Gezer Calendar: The Cycle of Seasons in Ancient Canaan, *Bet Miqra* 12, 1. (in Hebrew)

## Legend

### Symbols

- Singular form > plural form
- Derived from <
- Indefinite noun ~ definite noun
- X ► Y ► Z – Stages of linguistic evolution
- Sub-distinctions, provided within the text
- ↑ See above entry X
- ↓ See below entry X
- ↘ Weakening of gutturals: <sup>ʿ</sup> [Ayin] ↘ <sup>ʔ</sup> [Alep], <sup>ʔ</sup> [Alep] ↘ [no consonant], “h” ↘ “h”
- ↘ Weakening of emphatic consonants: “q” ↘ “k”, “š” ↘ “s”, “ṭ” ↘ “t”,
- = Parallel Hebrew/Aramaic terms
- ≈ Alternate wordings/spellings (in printed editions and/or codices)
- ± Synonyms (in parallel texts)
- { } Required production stages
- { } Optional production stages
- [ ] Alternate production stages

### Diacritics

- (Scientific transliteration will be employed in quotations from Hebrew and Aramaic texts, albeit not necessarily in the names of the texts themselves or their authors.)
- <sup>ʔ</sup> – Alep (א) – glottal stop.
- <sup>ʿ</sup> – Ayin (ע) – voiced pharyngeal approximant.
- ā – As in **father**, **bother** (Long and short vowels will not be differentiated in this paper.)
- ◌◌ – “Mobile shwa”, ultra-short vowel
- ħ – Voiceless pharyngeal fricative. Pronunciation is similar to the “j” of Juan in Spanish.
- ī – As in **beat**, **nosebleed**
- ō – As in **bone**, **know**
- q – Emphatic “k” – “qop”
- š – Emphatic “s” – “šadi”
- ś – Hebrew “sin”, also used in Ancient Egyptian
- š – Pronounced as “sh” – “šīn”
- ṭ – Emphatic “t” – “ṭet”
- ū – As in **rule**, **youth**

*Fricative (soft) consonants*

b̥ – (bh, v)

g̥ – (/ɣ/gh, voiced velar fricative. Arabic ġ).

d̥ – (/ð/ dh, voiced th, as in “**those**”, “**feather**”)

k̥ – (kh, as in J. S. Bach)

p̥ – (ph, f)

t̥ – (/θ/voiceless th, as in “**thin**”, “**tooth**”)**Abbreviations**

Ar = Aramaic (The various Aramaic dialects, *e.g.* Jewish Babylonian, Jewish Palestinian, Jewish Literary, Targumic, Late Jewish Literary, etc. will not be indicated in the present paper.)

ASL = A Syriac Lexicon

BASOR = Bulletin of the American Schools of Oriental Research

BR = Bereshit Raba

BT = Babylonian Talmud

CAD = Chicago Assyrian Dictionary

DJBA = Dictionary of Jewish Babylonian Aramaic

DJPA<sup>3</sup> = Dictionary of Jewish Palestinian Aramaic (2017)

DJPA = Dictionary of Jewish Palestinian Aramaic (2002)

Hb = Hebrew

HB = Hebrew Bible

JPS = Jewish Publication Society translation of HB

JT = Jerusalem Talmud (aka: Talmud of the Land of Israel, Palestinian Talmud)

JNES = Journal of Near Eastern Studies

KJV = King James Version

LBH = Late Biblical Hebrew

LUT = Luther Bible

LXX = Septuagint

M = Mishna

NIV = New International Version

NT = New Testament

PS = Targum Peshitta to the HB (in Syriac)

RH = Rabbinic Hebrew

RVR = Reina-Valera Bible

SBH = Standard Biblical Hebrew

T = Tosefta

TO = Targum Onkelos (to the Pentateuch)

TP = Targum Proverbs

TY = Targum Yonatan (to the Prophets)

VUL = Vulgate



# Jewish Terminologies for Fabrics and Garments in Late Antiquity: A Linguistic Survey Based on the Mishnah and the Talmuds<sup>1</sup>

Christina Katsikadeli

The main texts of the Rabbinic literature, the Mishnah and the Talmuds encompass a wide range of textile and clothing terms embedded in everyday situations as well as in ritual contexts. A great deal of intertextuality shared both by the Mishnah and the Talmuds as well as by other exegetic works like the Tosefta and the early Midrash – not to mention the Bible – makes these texts a valuable source for the investigation of cultural history and language change and contact, even in micro-contexts, in adherence to the traditions and heuristics of historical comparative linguistics, concerning etymology, language change and contact linguistics. The first attempt for a systematic presentation of the terminology according to the semantic fields of clothing, textile production and other relevant topics pertaining to fashion goes back to Rosenzweig's study from the year 1905. The progress in history, archaeology, comparative philology, linguistics and lexicography provides us with a comprehensive overview of the material.<sup>2</sup>

## **Brief introduction to the major texts of the Rabbinic literature and their language**

The Mishnah represents the earliest Rabbinic text, the *Oral Tora*, as opposed to the *Written Tora*, the Hebrew Bible, compiled in the early 3rd century (a generally accepted date is 200 AD). It consists of 63 tractates on a variety of topics grouped together into six divisions. Each division, a *sefer*, discusses a different topic, and deals with oral laws, everyday life and traditional wisdom. The language of the Mishnah is a form of Post-Biblical Hebrew (PBH), also called *Mishnaic Hebrew*, and it is also the language of related writings such as the *Tosefta*.<sup>3</sup> It was the language used at Qumran and also during the Bar Kokhba revolt (132-136 AD). In the current state of research, we have considerably more knowledge about the vocabulary of the Mishnah than about any other Rabbinic Hebrew composition. The Mishnah contains many elements from the Bible – mainly in quotes or pseudo-quotes from the Bible, while Biblical phrases occur

1. I would like to express my warmest thanks to Susanne Plietzsch, Orit Shamir, Nahum ben Jehuda and Ioannis Fykias for their friendly advice, for sharing their expertise with me and providing me with important material.

2. Onomasiology or “the study of designations” is a branch of semantics. The goal in onomasiology is to identify the linguistic forms, or the words, that can stand for a given concept/idea/object. The establishment of semantic fields contributes to the systematization of the designations and to a clearer understanding of gradual meaning changes.

3. ‘supplement, addition’ (of the *Mishnah*).

in the Mishnah more frequently than Biblical *simplicia*.<sup>4</sup> As expected, beside words that are common to both Biblical and Rabbinic Hebrew we also find novel vocabulary.

The Palestinian Talmud, also known as the Jerusalem Talmud or the *Yerushalmi*, is usually dated between the late 4th century and the first half of the 5th century. The *Yerushalmi* is organized in accordance to the tractates of the Mishnah. After citing each Mishnah tractate a series of interpretations, called the *gemara*, follows. The language of the Aramaic *gemara* of the Palestinian Talmud is Palestinian Aramaic (JPA), which is also used in the Palestinian *Targumim* ('translations' in Aramaic). The central corpus in Rabbinic Judaism is the Babylonian Talmud, completed at the beginning of the 7th century. It is also known as the *Bavli*. It is based on similar Palestinian traditions like those of the *Yerushalmi*,<sup>5</sup> but it introduces much of its own exegesis. The *Bavli* is also organised according to the Mishnah, consecutively alternating between the Mishnah and the interpretation of the *gemara*. Like the Jerusalem Talmud, the Babylonian Talmud deals only with some of the Mishnah's divisions. It is composed in Hebrew in the first place, but contains a significant number of passages in Aramaic—more than the *Yerushalmi*. The Aramaic used is an eastern dialect known as Jewish Babylonian Aramaic (JBA). It is a commonplace that the Babylonian Talmud reflects Jewish life in Babylonia, rather than in Palestine. The last of these major texts, the Babylonian Talmud, in turn became the most influential religious text for Medieval Judaism.

## Continuity and innovation

### *Continuity of older (mainly Biblical) terminology*

The importance and high esteem of clothing and textile production is evident in Jewish culture and religion through time, as exemplified by the well-known *sha'atnez* 'the prohibition of wearing wool and linen fabrics in one garment',<sup>6</sup> *tallit* 'prayer shawl', *tzitzit* 'tassels of the prayer shawl', but also proverbs involving clothing as a central concept throughout the Rabbinic tradition are frequently attested. Of course, within the Jewish tradition, we have to deal with fine grained semantics of most important lexemes in the field, pertaining to textiles, like *byssos*, *sakkos* or *sadin*.<sup>7</sup> Other words, although rarely attested, still live on in the Jewish tradition, e.g. *karpas*, a Biblical *hapax legomenon*, which is attested in the Book of Esther, meaning 'cotton (or wool)' *hūr karpās u- tākēlet*<sup>8</sup> 'white, wool (or cotton), and blue' (Est. 1:6). The Septuagint (*LXX*) translates with *καπάσινοϛ*, "made of *κάρπασοϛ*, exact fibre type of which is uncertain, probably a kind of fine flax, cotton",<sup>9</sup> Lat. *carbasinus*.<sup>10</sup> The Greek and Latin connections of the word have led to an interpretation as a Mediterranean term, while other scholars see a connection with Sanskrit *karpāsa* 'cotton shrub, cotton'.<sup>11</sup> Within the Jewish tradition the same term is mentioned again in the Medieval *Passover Haggada*, in connection with the benediction over vegetables.<sup>12</sup>

4. Bar-Asher 2009, 302-305.

5. The redaction and connection between the two *Talmudim* has been a central issue of the study of the Rabbinic literature, where scholars have been unable to reach a consensus. For further discussion, see the summaries in Stemberger 2011, 221.

6. See also Shamir's paper in the present volume.

7. The lexical (and not always semantic!) correspondences for *byssus* in Hebrew is *būš* 'fine white valuable web'; Akkadian *saddimu* 'tunic (of linen)' ~ Hebrew *sādīn* 'undercloth, wrapper' (~ Gr. *sindōn* 'very fine cloth/fabric'); Akkadian *saqqu* 'sack (cloth)', 'cloth of goat-hair, sack', Hebrew *saq* 'sack (cloth)', Aramaic *š-q*. (~ Gr. *sákkos* 'cloth of goat-hair, sack'). See also F. Maeder's paper in the present volume.

8. The transcription follows the common scholarly transcription rules for Biblical Hebrew, PBH and Aramaic. In several cases, where the reading is dubious the lexemes remain unvocalised, in order to avoid biased interpretations. For the same reason, transliterations by other authors are cited as such (in general).

9. Cf. Beekes 2009 s.v.

10. Also, occurs as *carbasus lina*, as a mixture of linen and cotton, Pliny, *NH* 19.6.23.

11. Cf. EWAia s.v.

12. Cf. Eisenberg 2004, 278 and Krupp 2006, 14-15.

### *Innovations in Terminology*

#### *Innovations involving language change from Biblical to Post Biblical Hebrew or from Hebrew to Aramaic*

All languages are dynamic systems that are constantly in the process of changing. Thus, it is not a rare phenomenon that the redactors of the Mishnah changed a Biblical lexeme into a PBH or Aramaic corresponding term, and in that way they managed to actualise the content and “update” it, where necessary, e.g. Aramaic *gunka* in the *Targ. 2 Kings* 8:15 is replacing the expression of the Hebrew text: *makbēr/makbār* ‘something woven, cover or mat’.<sup>13</sup> The Aramaic word *gunka* ‘thick cloth’, of Iranian origin, is well attested as a loanword in many languages and dialects of the Mediterranean.<sup>14</sup> Its Hebrew correspondence must have been somewhat opaque already during the period of the translation of the Septuagint (ca. 250 BC-100 AD), since in the Greek text it is rendered as *μαχμα*, which is actually a transliteration of the Hebrew word, lacking further attestations in the history of Greek. The term might have been familiar among the Greek speaking Jews of that time, but it seems that it became marginal in the subsequent centuries.

#### *Innovations and differences concerning dialectal or geographic distribution*

The monumental multi-volume work by Samuel Krauss, *Talmudische Archäologie* 1910-12, can still serve as the basis for the investigation of this subject,

although it is a commonplace that Krauss’ studies suffer from methodological deficits, which are, however, due to the stage of research at his time: the historical-critical paradigm of investigating Rabbinic sources had not yet been established, and archaeology in Israel has since then made immense contributions to the growth of our knowledge. Krauss does mention many types of clothing, referred to in both Palestinian and Babylonian, early and late Rabbinic sources, but he does not provide a comprehensive analysis and discussion of the material.<sup>15</sup> Several studies since Krauss’ time have focused on the Jewish clothing and textile production traditions, but the study of possible differences due to regional factors has been played down by generalizing conclusions, stating that Jewish people would more or less share the same ‘basics’ with other inhabitants of the Roman Empire, based on the fact that many Graeco-Roman garment names occur in the texts.<sup>16</sup>

Let us have a closer look at a representative example from the Rabbinic narrative about clothing vocabulary, namely the passage concerning the 18 garments, which may be carried out of a burning house on the Shabbat.<sup>17</sup> Here, we have a special situation, where the Mishnah just mentions 18 garments without explicitly referring to the items involved:

#### (1) *mShab*16:4

“Thither a man may take out all his utensils, and he may put on him all the clothes that he can put on and wrap himself with whatsoever he can wrap himself. *R. Jose* says: [*He may put on only*] *eighteen things*, but he may return and put on others

13. Koehler & Baumgartner 2001 s.v.; *makbār* is attested in Ex. 27,4 with the meaning ‘grid’, the LXX translates with *εσχαρα* ‘grating’.

14. According to Schmitt 1971, 102-105, *\*gaunaka-* ‘hairy; coloured’ is derived from Iran. *\*gauna-*, ‘hair, colour’ - following patterns common to Iranian -, and is deeply rooted in the whole Iranian area: Avest. *gaona-* ‘hair’; Middle Persian *gōnak*, Armenian (loanword from Parthian) *goyn*, Soghd. *ywn-*, Modern Persian *gūn*, all denoting ‘colour’; the Greek form *γαυνάκης, καννάκης*, attested since Aristophanes, *Wasps*, 11, 37; 49, as *καννάκη* explicitly refers to ‘a woollen Persian mantle’, and is also found in the Egyptian Papyri (in derivations and compounds); Lat. *gaunaca* since Varro; Babylonian and Aramaic (also Syriac *gaunīcā*) have also moved eastwards to (Middle IndoIranian) Pāli and to Chinese: Pāli *gonaka* ‘woollen blanket’; Chinese *hu-na* (?).

15. Shlezinger-Katsman 2010, 362-365 summarizes the state of the art since Krauss’ works: despite the important works that have been published since then, almost every author mentions -like Krauss- many of the terms used for clothes in Rabbinic writings, but the lacking distinction between Jews who lived in Babylonia and those in the Roman Empire is evident. At this point, we should take into consideration that very remarkable lexicographical work has been accomplished by Sokoloff (1992, 2002) in the Dictionaries on the Palestinian and Babylonian Aramaic respectively, enabling us to differentiate between the two Talmudic traditions.

16. Cf. a.o. Roussin 1994, reaches the following conclusion pertaining to “... the basic items of clothing worn by Jews: they did not differ significantly from those worn by other inhabitants of the Graeco-Roman world. Indeed, almost all of the Hebrew words for the clothing mentioned here are transliterations of Greek and Latin words” (Roussin 1994, 183).

17. Also discussed by Roussin 1994.

and take them out, and he may return and put on others and take them out, and he may say to others, ‘Come and help me to save them’.” (translation: Danby 1933)

(2a) *bTShab* 120a

R. Jose said: [Only] eighteen garments. And these are the eighteen garments: *a cloak, undertunic, hollow belt, linen [sleeveless] tunic, shirt, felt cap, apron, a pair of trousers, a pair of shoes, a pair of socks, a pair of breeches, the girdle round his loins, the hat on his head and the scarf round his neck.* (translation: Epstein 1952)

(2b) *jT Shabbat* 16:5, 15d(22), “Rebbi Yose says, 18 garments. And these are: *The burnus, arm cover,*

*and money belt, and felt cap, and a kafia, and a linen tunic, and a woollen shirt, and two felt stockings, two garters, and two breeches, two shoes, and the hat on his head, and the belt on his hips, and shawls on his arms.*” (translation: Guggenheimer 2012)

Both Talmuds, in (2a) and (2b), offer a list of the garments, but as a matter of fact they employ only 14 terms; the number of 18 pieces can be reached by counting pairs as two single items each. Let us compare the same passage as an interlinear version of the *Bavli* followed by the *Yerushalmi* in the second line.<sup>18</sup> The order varies between the two *Talmudim*; here, the primary numeration follows the listing of *Bavli*:

(3) <i>bT</i> <sup>19</sup>	<mqorn> 1. a cloak (~ <i>amictorium</i> ),	<wnqli> 2. an undertunic ( <i>anákōlos</i> ??)	3. (and) a money belt ( <i>funda</i> ),	<qlbum> shel pishtan 4. linen tunic ( <i>colobium</i> )
<i>jT</i> <sup>20</sup>	<mqorn> 1. burnus	<niqli>(angálē?) 2. armcover	3. money belt	6. felt cap
(4) <i>bT</i>	5. (and a) shirt ( <i>haluq</i> )	6. a felt cap ( <i>pilion</i> )	7. <i>ma'aforet</i> (and) an apron/ cloak (~ <i>pallium</i> ),	<sprqin> 8. a pair [lit. two] of trousers ( <i>braccae</i> ?)
<i>jT</i>	7. <i>ma'aforet</i> kafia	4. <i>kolbin shel-pishtan</i> linen tunic	5. <i>haluk shel-zemer</i> woollen shirt	10. two felt stockings ( <i>empilia</i> )
(5) <i>bT</i>	9. (and) a pair of shoes	10. (and) a pair of felt slippers ( <i>impilia</i> )	11. <prgd> (and) a pair of breeches	12. (and) the girdle ( <i>gur</i> ) round his loins,
<i>jT</i>	8. two garters <sbriqin> (~Gr. <i>sybrikion</i> ?)	11. two breeches <abriqin>	9. two shoes ( <i>min'alín</i> )	13. the hat ( <i>kov'a</i> ) on his head
(6) <i>bT</i>	13. (and) the hat on his head,	14. and the scarf ( <i>sudarium</i> ) around his neck		
<i>jT</i>	12. the belt on his hips	14. and shawl on his arms		

18. The phonology of loanwords in Mishnaic Hebrew is very problematic: Unlike the Biblical transmission, Rabbinic literature never obtained a canonical form, and each manuscript reveals different versions. Neither the spelling of the loanwords, nor their vocalisation (where occurring), are consistent, so that many equivalents are possible.

19. The translation of the terms additionally follows –apart from Epstein– the translation by Goldschmidt (according to the Venice edition from 1520-23): „Die achtzehn Stücke sind die folgenden: *Obermantel* [1], *Hemd* [2], *Hohlgürtel* [3], *Wams aus Leinen* [4], *Kamisol aus Wolle* [5], *Filz* [6], *Kopfhülle* [7], *zwei Handschuhe* [8], *zwei Schuhe* [9], *zwei Strümpfe* [10], *zwei Hosen* [11], *ein Gürtel* [12], *eine Mütze* [13] und *ein Halssudarium* [14]“ (translation: Goldtschmidt 2002)

20. *jT* (ms Leiden), translated by Guggenheimer 2012; cf. also the German translation by Hüttenmeister in Hengel *et al.* 2004: „Rabbi Yose sagt: Achtzehn Kleidungsstücke. Und das sind folgende: *Mantel* [1], *Unterhemd* [2], *Geldgürtel* [3], *Mütze* [4], *Umhang* [5], *Leinentunica* [6], *Wollhemd* [7], *ein Paar Hausschuhe* [8], *ein Paar Savriqin* [9], *ein Paar Kniehosen* [10, <abriqin>], *ein Paar Schuhe* [11], *ein Hut auf dem Kopf* [12], *ein Gürtel um die Hüften* [13] und *ein Tuch an den Armen* [14]“.

While some terms such as the 3. *punda*, 4. *colobium*, 5. *haluk*, 6. *pilion*, 10. *e/impilia* ‘stockings’ or ‘slippers’, 14. *sudarium*, have a widely accepted interpretation, others are translated differently. The pair of *spriqin* under 8. has been interpreted as a term which corresponds to a lexeme *sybrikion* (lat. *subricula*) ‘outer veil, cloak’, but since it occurs as a pair, an interpretation as ‘trousers’ or ‘garters’ seems more plausible. Of special interest are the following expressions: the Babylonian Talmud features <prgd> *pargod*,<sup>21</sup> occurring as a pair, a word of Iranian origin, where the Jerusalem Talmud attests *abriqin*, most probably the *braccae* (cf. nr. 11 under (5) in the table above). In this case, the Talmuds seem to employ rather regional terms to designate ‘trousers’, an Oriental garment, not popular among Greeks and Romans. The shift of the etymology to a Greek or Latin counterpart does not make things easier. Some of these words are difficult to interpret in the other languages as well. In both cases we find <mqtorn> /*miqtoren*/ at the top of our list, the interpretation of which as *amicorium* seems to be a plausible phonetic/phonological solution. The word formation and the semantics of a Lat. word *amicorium* are considered transparent: as a derivation from *amicus* ‘thrown (upon)’, it can plausibly be interpreted as ‘mantle’ or ‘veil’. The interesting fact in this case is that *amicorium* is rarely attested in the late antiquity, actually only as ‘a loose outer garment’ (worn by women) (Code of Theodosius 8.5.48.).<sup>22</sup> The *amicorium* replaces *amicus* in Medieval times. So in this case, the *Talmudim* preserve

less popular garment names than the *sudarium* and the *pilion*.

The terms *unkli/nikli*, which follow the *amicorium*, are also problematic: Krauss interprets as Gr. *anákolos* ‘undertunic’,<sup>23</sup> other scholars as Gr. *angálē* (?) As in the case of the *amicorium*, Gr. *ἀνάκωλος*, -ov, is attested in an adjectival usage meaning ‘short, curtailed’ (Diod. 2, 55) and as an attributive adjective to a garment in Plutarch 2, 261 F, describing a *χιτωνίσκος* (of young women), a term which refers to a short tunic.<sup>24</sup> Gr. *angálē* ‘bent arm, arm pit’ is also a possible phonological interpretation, which has been followed by other scholars, and would lead to a meaning ‘arm cover’ (cf. the translation in Guggenheimer under (2b)). While the etymology and the semantics of this word are sufficiently motivated, it is noteworthy, that a metonymic use of Gr. *angálē* as a garment in the Greek literature – from the Classical up to the Byzantine period – has not been ensured by now, a fact that allows us to assume that in this case we do not deal with a garment name that had been popular throughout the Roman Empire. If the suggested interpretations are correct, then we should keep in mind that they belong to the earliest attestations of these terms or they indicate dialectal usage.

#### *Examples of semantic change and cognitive universals connected with textiles: the colour terms*

The number of Hebrew colour words has increased with the passage of time, following the order of increasing number of colour terms as arranged by the non random sequence proposed by Berlin and Kay

21. Cf. Schmitt 1971, 107-110: Against older proposals, which explained the word as a loanword from the Targumic Aramaic without consideration of the chronological details, Schmitt convincingly argues for an Old Persian *\*pari-gauda-*, a compound with the prefix *pariy-* ‘around’ + Old Persian root *gaud-* = avest. *gaoz-* (= Old Indian *guh-*) ‘to hide, cover’, Parthian <brywd> = /barayôd/ ‘curtain, veil’ borrowed into Greek in the regular, expected form *παραγαύδης*, Ioan. Laurentius Lydus (6th c. AD); also attested as *παραγαῦδιον*, ‘a garment with purple border’, *Edict Diocl.* (19,29), on an inscription from Dura-Europos and in the Byzantine *Chronicon Paschale*; *παραγαῦδιον* (*POxy.*, 1026,12, 5th c. AD; Ioan. Malalas, 6th c. AD und Konst. Porphy., 10. c. AD); probably in Hesychius: *παραγῶδας* (Codex: -γῶγας): *χιτών παρά Πάρθοις*; Gr. *παραγαῦδης* ~ Lat. *paragauda*. Syr. *pargaudin*, Armenian *paregawt* ‘χιτών’ (in Bible translations), Coptic *paraka[u]dion*. We have to keep in mind that the core meaning of the Iranian word ‘wrapped around, covering’ had been subjected to various semantic narrowings and specialised usages in different languages. We find *pargod* as a rendering for the *paroket* ‘(sacred) screen, veil’ in the Jewish Aramaic tradition (*Targ. Yer. to Ex. 26:31, 33, 35*) as well.
22. Cod. Theod. 48.5.48. IDEM AAA. CYNEGIO P(RAEFECTO) P(RAETOR)O. Lineae vel *amicoria*, quibus hactenus onerari raeadae solebant, nec ulterius raedis, sed angariis vel navibus dirigantur et si alicubi repertae fuerint huiusmodi species, thensauris eius urbis, in qua deprehensae fuerint, deputentur, per angarias, ubi facultas fuerit, destinandae; reliquae vero delicatae vestes, sed et linteamen *amicorium* nostrorum usibus necessarium raedis sub mille librarum ponderatione mittantur.
23. Krauss 1899, 23, 363; Krauss 1911, 165.
24. It is noteworthy that ancient lexicographers use this term to explain the <zeirai>, <zirai> ‘tunics worn by the Thracians’, cf. Phostius, Z. 52.1-3, Hesychius Z. 162.1.



(1969) for the languages of the world.<sup>25</sup> The colour terms for red show the widest differentiation in BH, with 'āḏōm 'red, blood coloured, reddish(-brown)' being the archilexeme in this group.<sup>26</sup> The red-coloured fabrics are denoted by the words šānī 'crimson', 'crimson thread' (Gen. 38:28,30), tōlā 'crimson; Kermes worm' (Isa.1:18), and 'argāmān 'purple' (Song 7:6; Ex. 25:4; 26:1),<sup>27</sup> karmīl 'crimson' (2 Chron. 2:7,14; 3:14), LXX: κόκκινος 'scarlet, crimson'; ḥāmūš 'crimson dyed' (Isa. 63.1), which very likely originate from metonymical uses of the dyed fabric or the organic elements involved in their dyeing procedure, būš wə- 'argāmān "fine linen and purple" (Est. 1.6); təkēlet wə-argāmān "blue and purple" (Ez. 27:7; LXX: βακινθον και πορφυρα),<sup>28</sup> and might also represent various hues or different grades of brightness.

A number of new colour words appear in the Rabbinic period, as for instance kaḥol/koḥal 'blue' connected with 'stibium, powder used for painting the eyelids', *bTShab* 8:3 (78b) and a novel term milan 'black' (cf. Gr. mélas, melanós) that denotes the 'black pigment', the 'ink'. The Biblical word šāḥōr 'black' occurs in PBH in connection with tar, olives, grapes and pots, while in other cases it has been replaced by novel Aramaic terms, e.g. the Mishnah in *Bava Qamma* 9:6, where the restitution in case of wrong dyeing of the wool is discussed:

(6) *jTBQ* 9:6:

[If someone told the dyer]

"to dye it red ('āḏōm) and he dyed it black (šāḥōr), black and he dyed it red, Rabbi Meir says, he gives him the value of his wool". Rabbi Jehudah says, if the increased value is more than the expenses, he gives him his expenses; if the expenses

are more than the increased value he gives him the increased value"

(7) *Gemara*:

"What means 'if the increased value is more than the expenses, he gives him his expenses'? A person gave to another five lots of wool, five portions of dye, and ten minas for his wages. He told him, if you had dyed it red (*sumaq*), but the other had dyed it black (*ukam*). He told him, if you had dyed it red, it would have been worth 25 minas, now that you dyed it black it is worth only 20 ..." (Guggenheimer 2008)

The Mishnah in (6) employs the Hebrew words 'āḏōm 'red' and šāḥōr 'black'. The Jerusalem Talmud in the *gemara* of this Mishnah introduces the Palestinian Aramaic words *ukam* 'black' and *sumaq* for 'red'. So we learn from the text that these two Aramaic colour names correspond to the "archaic" BH terms in the context of dyeing.

While the two terms from the Mishnah *BQ* must have been semantically transparent for the Rabbis, there are other cases, where the *gemara* tries to disambiguate older, rarely attested colour terms, which had become obsolete, like in the case of the Biblical *taḥaš* in Exodus 25:4-5. Before we come to the Rabbinic exegesis of the term, let us have a closer look at the passage from the book of Exodus, as it appears in the LXX, together with the corresponding BH words in brackets:

(9) LXX

Ex 25:4-5 και βακινθον ('blue', ~ təkēlet) και πορφυραν ('purple' ~ 'argāmān) και κοκκινον διπλου ('double crimson or

25. Hartley 2011, offers an up-to-date investigation on the Biblical colour lexemes. Biggam 2012, 124 employs a detailed meta-language for explaining the historical colour designations in the languages of the world: "hue (red, yellow, green, brown etc.); saturation (vivid, mid, dull); tone (achromatic): white black, pale grey, mid grey, dark grey, tone (chromatic) pale medium, dark; brightness light emission; brightness reflectivity; brightness surface illumination (well-lit, purely lit; brightness space illumination (brilliant, dim, unlit); transparency (transparent, translucent)". BH šāḥōr 'black', and lāḥān 'white' are two possible candidates, which in many cases denote achromatic tone or a type of brightness rather than hue.

26. 'āḏōm 'red' refers to animals, cf. the "red heifer" (*Num.* 19.2) and the "red horses" (*Zech.* 1:8; 6.2), 'āḏamdām "dark red or reddish" (*Lev.* 13:19, 14:37); 'aḏmōnī "ruddy" (*Gen.* 25:25).

27. Also as 'argāwān "purple" (*2 Chron.* 2.6).

28. In the book of *Ezekiel*, we find several examples of colour terms in the context of fabrics and gemstones, see *Ezek.* 27:24: "... in gorgeous fabrics (*bə-maklūlīm bi-ḡlōmē*), in wrappings of blue and richly woven work (*təkēlet wə-riqmā*), and in chests of rich apparel, bound with cords (*ḥāḇūšīm*) and cedar-lined"; also *Ezek.* 27:7 šēš-bə-riqmā "linen with embroidery".

scarlet' ~ *šānī*) και βυσσον κεκλωσμενην ('spun *byssos*' ~ *šēš*) και τριχας αιγειας (goats hair) και δερματα κριων (rams' skins) ηρυθροδανωμενα (dyed red ~ '*ādōm*') και δερματα υακινθινα ('blue' ~ *təhāš*) και ξυλα ασηπτα (incorruptible wood)

The colours listed in (9) constitute strong evidence for the occurrence of the 'reds', 'blues' and 'violets' in BH (and Koine Greek), implying an affinity, or even a "lexical solidarity" between the terms for the dyes and the skins. The problematic expression *taḥaš* refers to skins and has been translated in Greek with *υακινθινα*. In the same context, the Jerusalem Talmud in *Shabbat* 2:4d uses the term *ianthinon* 'violet-blue' for *taḥaš*, as opposed to *glaukinon* 'bluish-gray':

(8) *jTShab* 2:4

"Rebbi Eleazar asked, may one make the Tent of leather from an impure animal? But is it not written, *and taḥaš skins*. Rebbi Jehudah, Rebbi Nehemiah and the Rabbis. Rebbi Jehudah says, violet[-blue] (*ianthinon*); it was called thus because of its color. Rebbi Nehemiah said, blue [bluish-grey] (*glaukinon*)."<sup>29</sup> (translation: Guggenheimer 2012)

The violet-blue colours are designated in PBH not only by *ianthinon* (Gk. *ion* 'violet') but also by the term *iakinthinon* (Gr. *hyacinthos*, the same as in LXX, Ex. 25:4-5 above), and later also by <*altinon*>, in the Midrash *Kohelet Rabba* 1:9,<sup>29</sup> which corresponds to Gr. ἀληθινόν 'true (purple)', cf. also *Edict. Diocl.* 2.4.6. So we are in a position to trace potential

parallels between the alternation of the dyeing techniques and the corresponding linguistic change.<sup>30</sup>

*The loanwords:*

Approximately two thousand Greek and Latin loanwords in Hebrew and Jewish Aramaic can be attributed to language contact. In many cases, the Latin items must have entered Hebrew via Greek, since Greek served as a *lingua franca* in both the Roman and Byzantine periods<sup>31</sup>. The borrowing process is not restricted to single nouns, but also encompasses adjectives and verbs *i.e.* word classes that are usually less easily borrowed: an example is the Hebrew denominative verb *sap̄ag* 'absorb' (cf. *u-bilbad šello yispog* "as long as it does not absorb", *Mishnah Shabbat* 22:1), *nistappag* 'to be dried' (*wa-'ala we-nistappag* "(and he) ascended and dried himself", *Mishnah Yoma* 3,4) is of Greek origin, from the Gr. noun σπόγγος, in the form *seḫog* 'sponge', cf. *Mishnah Kelim* 9,4 "a sponge that absorbed liquids" and from which the verbal forms were then derived.<sup>32</sup> The vast majority of them pertain to material rather than spiritual culture.<sup>33</sup> Words from all stages of Persian and other Iranian languages have been borrowed into all layers of Hebrew pertaining to clothing, textiles, and jewellery, testifying to the luxurious Oriental lifestyle (cf. below and notes 14, 21).

***Novel terminology due to new onomasiological needs: new materials, techniques, and trading routes***

*The weaver's shuttle*<sup>34</sup>

In Biblical Hebrew, there are attested terms for weaver's equipment, as for instance 'ereg 'weaver's

29. 6<sup>th</sup> or 7<sup>th</sup> c. AD?, cf. Stemberger 2011, 352.

30. Cf. Sukenik *et al.* 2013, about the prestigious textiles from the Roman period dyed with *murex* shellfish, which were found in the Judaeen Desert and the different dyeing techniques according to ancient literary sources, esp. p. 50-51).

31. The phonology of the loanwords often indicate the donor language and, in some cases, the dating of the borrowing, e.g. PBH <*vilon*> 'curtain' (from Gr. βῆλον <Lat. *velum* 'sail; sheet, cloth' (Naev.+)) show postclassical pronunciation, where /e:/ <η> was raised to /i:/ in Koine Gr; also Middle Greek as 'curtain' (Pseudo-Sphr. 33018) or a 'piece of cloth', (Ierakos. 3502), cf. Kriaras 2001 s.v. βῆλον; Modern Gr. βέλο, το [vélo] < Ital. *velo* < Lat. *velum*>).

32. Bar-Asher 2014.

33. The number of Greek loanwords increases dramatically in the Rabbinic literature of the Roman and Byzantine periods. The standard Dictionary of Greek loanwords in Rabbinic Hebrew is still the one by Krauss from the year 1899, despite its many shortcomings. The phonology and morphology of Greek loanwords were dealt by Krauss in the first volume of his *Lehnwörter* (1898); it should be pointed out, however, that the phonological part contains many unacceptable identifications, and should be used with utmost care. More recent studies include Sperber (1984; 2012) and Heijmans (2013).

34. See discussion of this term in Flemestad *et al.* in the present volume.

bobbin', cf. Job 7,6: "My days are swifter than a weaver's bobbin,<sup>35</sup> and are spent without hope" and *dallâh* (Is. 38,12) a 'warp', properly something *dangling*, that is, a "loose thread or hair; figuratively *indigent*: hair, pining sickness, poor (-est sort)".<sup>36</sup> In the Rabbinic literature we find more frequent attestations of the weaver's shuttle than in the Bible, and even loanwords are employed, e.g. *krkd* (*mShab* 8:6; *bTShab*. 8b; *jTShab*. 10b) ~ Gr. κερκίς, -ίδος 'weaver's shuttle; peg; pin; measuring rod' (Hom.+).

### *The silk production*

As expected, one of the most obvious innovations and differentiations in terminology concerns the emerging silk production in the late antiquity. The *Mishnah Kilaim* 9:2 adds silk to the older rule of the distinction between wool and linen of the Deuteronomy 22:11 (also in Lev 13:19; and Ex 39:27-29) using the terms *shirii* and *kalakh* for two different kinds of silk:

(10a) *mKil* 9:2

"Silk (*shirii*) and *kalakh*-silk do not come under the law of Diverse Kinds, but they are forbidden for appearance sake"<sup>37</sup>

The term *kalakh* has been associated with the Gr. word κάλχη<sup>38</sup> denoting 'murex; purple flower, *Chrysanthemum coronarium*' (Alcm., Nic., Str.).<sup>39</sup>

The Palestinian Aramaic *gemara* of the tractate *Kilaim* introduces *metakhsa* as an explanation for *shiriin* and at the same time it gives us information about the usage of the term *kalakh*, as *kalka*:

(10b) "Raw silk (*shiriin*) and silk noil (*kalakh*).

Raw silk is *metakhsa*. *Kalakh*-silk is imperial 'gbyn. Rabban Simeon ben Gamliel said, I went around among all sea-faring men and they told me that it was called *kalka*." (translation: Guggenheimer 2001)

While the *Yerushalmi* seems to connect *kalakh* with 'imperial purple'<sup>40</sup> and informs us about 'pure silk tissues', the <*oloserika*> *jTShab*10:8b, which correspond to Gr. τό όλοσηρικόν (*Edict. Diocl.* 22:14), the Babylonian Aramaic *gemara*, although it attests the word *metakhsa*, for example in the tractates *Ke-tubboth* and *Shabath*,<sup>41</sup> it actually uses another term to explain the *metakhsa*-silk in the *gemara* of *Shab* 20b(31) and differentiates it from the *sirah* (or *shirah*) silk, namely by the term *pranda*-silk (also in *Shab* 20b(33) *Soṭ* 48b(44), which leads us to the Middle Persian *parand*, also known from the Pahlavi *Šāyast-nē-šāyast* (4:1). In *Targ. 2 Esth.* 5:1; 6:10 we find another silk of Iranian provenience, the *p'rangan* (*pranigan*) silk, probably connected with a geographical term.<sup>42</sup>

### *Terminological innovations due to religious and social factors*

The *Bavli* addresses the issue of how and when clothes can reveal the origin and social status of the person who wears them, and indicates that Jews who traveled from Palestine to Babylonia were recognised as foreigners by their clothes:

(11) *bTShab*145b-

"Why are the scholars of Babylonia distinguished [in dress]? Because they are not in their [original] homes, as People say, In my own town my name [is sufficient]; away from home, my dress." (translation: Epstein 1952)

High quality and luxury items, like *puzmaq* PBH 'gaiter, fine shoe' and trousers as an Oriental garment, like *sarbal* 'cloak, trousers' are mainly Persian/Iranian lexemes in PBH, mostly via Aramaic mediation.<sup>43</sup> Like the majority of loans, they belong to a very high literary register of language. On the contrary, there is no evidence for a distinctive slave attire: "ordinary slaves seem to have been wearing the

35. Koehler & Baumgartner 2001 s.v.

36. Koehler & Baumgartner 2001 s.v.

37. Since raw silk looks like flax and *kalakh*-silk like wool, cf. Guggenheimer 2001, 290, n. 29 on the passage. Danby 1933 translates *kalakh* with 'bast-silk', Krupp 2002 translates in German: „Feine (*shiriim*) und grobe Seide (*kalakh*)“.

38. Guggenheimer 2001, 290, n. 33 on the passage.

39. Beekes 2009 s.v.

40. Guggenheimer 2012, 291. "The *Bavli* agrees that it is some silk worn by exalted personalities", cf. *ib.* 89.

41. The *Bavli* does not include a *gemara* for the *Mishnah Kilaim*.

42. Sokoloff 1992 s.v.

43. MP *šalwār* 'trousers' reached PBH through Aramaic also as *šarvul* 'leather sleeve', Gindin 2013, cf. also Schmeja 1978.

simple and ragged clothes characteristic of members of the lower strata of society. Others who had higher positions within the servile hierarchy will have resembled wealthier free persons in their outward appearance<sup>44</sup>. An example for upcoming distinctions in late antiquity pertains to the differences between the monks and the Rabbis<sup>45</sup>. Furthermore, a case of ideological differentiation in attire can be traced in the clothing of the inhabitants of Qumran, who must have deliberately abstained from the use of wool as a raw material and the ‘luxury’ dyed garments (Shamir & Sukenik 2011). Head covering also offers a representative example for regional customs in combination with religious and social ‘dictates’. Although the strict rule of head cover for women in Biblical and post Biblical times has been a matter of discussion, the kind of veil or head cover could vary and be replaced according to different periods and geographical regions, *e.g.* there is evidence for local differentiations, cf. *mShab* 6:6:

- (12) “One goes out with a tetradrachma on a arthritic foot. Girls go out with threads and even chips in their ears. Arab women go out veiled and Median women pinned,<sup>46</sup> and also everybody, but the Sages spoke about what is.”<sup>47</sup>

The term employed here is a participle passive in the fem. pl.: *ra’ulot* ‘veiled’, a verbal root derived from a noun *ra’alah*, also Arabic *ra’ul* ‘veil’, which can be interpreted as ‘veiled (in Arabian fashion)’.

Apart from ‘veils’, also hairnets are mentioned in the *Mishnah*, cf. *Kelim* 24:16:<sup>48</sup>

- (13) “There are three kinds of hairnet (*svacha*): that of a girl, which is susceptible to uncleanness; that of the old woman, which is susceptible to corpse uncleanness; and that of a harlot, which is not susceptible to any uncleanness”

As in the case of the Arabian fashion, we benefit from other passages about garments not traditionally worn by Jewish people. A more ‘exotic’ term can be found in the Babylonian Talmud, in the *Be-rachot* (20a): *karbalta* means a type of a hat, of a certain woman who was wearing a head covering in the street;<sup>49</sup>

- (14) “There was the case of R. Adda b. Ahaba who saw a heathen woman wearing a red head-dress (*karbalta*) in the street, and thinking that she was an Israelite woman, he rose and tore it from her. It turned out that she was a heathen woman, and they fined him four hundred zuz” (translation: Epstein 1952)

The word is also attested as ‘cock’s crest’, probably continuing an Akkadian form *karballatu* ‘for a piece of linen headgear for soldiers’.<sup>50</sup> In addition to the *head dress* and the *trousers*, which were unpopular or even unacceptable garment pieces for the Graeco-Roman style,<sup>51</sup> another feature of Oriental fashion gradually enters the Rabbinic lexicon, namely the ‘long-sleeved tunic/coat, *tunica manicata*’, as the term <*krdot*> (*Targ. 1 Sam* 2:28) ~ Gr. χειριδωτός, suggests.<sup>52</sup>

44. Cf. Hezser 2005, 88.

45. Monks, who were strict, took only one tunic (*chiton*). In the Judaeen Desert, monks received “a cloak (*pallium, himation*), a cowl (*koukoulion, cuculla*), sandals and a sleeveless (or very short-sleeved) tunic (*kolobion, colobium*) and often a number of regular tunics (*chiton*). A belt (*cingulo, zone*) also seemed to be common”, Schwartz 2004, 124.

46. “To make sure that the veil stays in place they tie weights, such as pebbles or walnuts, into both ends of the veil and wear them on their backs”, Guggenheimer 2012.

47. “The rules are generally valid but are formulated for Arab and Persian women who by local custom are completely covered up.”, Guggenheimer 2012.

48. Parts of braided hairnets were found in the Judaeen Desert and at Masada, and perhaps in Wadi Murabba’at, Shlezinger-Katsman 2010, 373-374.

49. „Wie zum Beispiel R. Ada b. Ahaba: er sah einst eine Nichtjüdin auf der Strasse einen Turban tragen, da er glaubte sie sei eine Jisraëlitin. So machte er sich auf und riss ihn ihr ab.“ (translation: Goldschmidt 1871-1950)

50. Cf. Sokoloff 2002 s.v. and CAD K 215.

51. Emperor Honorius imposed in 397 AD severe penalties for those who wore *braccae* in Rome.

52. Cf. Herodotus 7,61; Strabo 4,4,3; Aullus Gellius 6,12,2.

## Conclusion and prospects

On the one hand, the study of language change can be very useful – as supporting evidence to the archaeological findings – for the purpose of reconstructing cultural and technical innovations concerning clothing and textile production. Next to their religious importance, the Rabbinic texts are an invaluable source for the investigation of linguistic and cultural transitions throughout many centuries, pertaining not only to Judaism and Palestine, but to the greater area of the Eastern Mediterranean. On the other hand, the writing system, the transmission of the texts and the various manuscript editions pose numerous problems for the identification and interpretation of specialised vocabulary in the Rabbinic literature, especially of loanwords. Scholars working on Greek loanwords in the Rabbinic literature suggested principles and criteria which can be useful for revising out-of-date etymologies and offering new etymological solutions.<sup>53</sup>

Linguistic analyses on the level of the clothing and textile vocabulary of the Rabbinic literature produce parallel results to the findings of archaeology and ancient history. Further, the linguistic evidence allows us to assume a moderate case of language contact: where the secure terms from the Graeco-Roman world become lesser, the vocabulary from other areas of the Near East increases, revealing new dimensions for our cultural understanding. It is also important, that the differences between the attestations of the Palestinian and Babylonian traditions, respectively, and the vocabulary of Josephus and the Diaspora should not be neglected, in order to highlight the particular linguistic varieties of the texts, which enable us to reconstruct regional and sociolinguistic characteristics of the textile terminologies.<sup>54</sup>

## Abbreviations

bT = Babylonian Talmud  
 BH = Biblical Hebrew  
 CAD = *The Assyrian Dictionary*

EWAia = *Etymologisches Wörterbuch des Altindoarischen*  
 Gr. = Greek  
 jT = Jerusalem Talmud  
 Lat. = Latin  
 LXX = Septuagint  
 PBH = Post Biblical Hebrew

## Bibliography

- Bar-Asher, M. (2009) *Studies in Mishnaic Hebrew. Vol. I: Introduction and linguistic investigations*. Jerusalem.
- Bar-Asher, M. (2014) *Lexicon: Rabbinic Hebrew. Encyclopedia of Hebrew Language and Linguistics*. Edited by Geoffrey Khan. Brill Online.
- Beekes, R. (2009) *Etymological dictionary of Greek*. Vol. 1-2. Leiden.
- Berlin, B. & P. Kay (1969) *Basic color terms: Their universality and evolution*. Berkeley, California.
- Biggam, C.P. (2012) *The semantics of colour. A historical approach*. Cambridge.
- CAD K = *The Assyrian Dictionary*, ed. by M. Civil, I.G. Gelb, A.L. Oppenheim, E. Reiner, Vol. 8 K 42008, Chicago.
- Correns, D. (2005) (1924) *Die Mischna : das grundlegende enzyklopädische Regelwerk rabbinischer Tradition*, ins Dt. übertr., mit einer Einl. u. Anmerkungen von Dietrich Correns. Wiesbaden.
- Dalman, G. (1905) [1989]. *Grammatik des jüdisch-palästinischen Aramäisch*. Darmstadt.
- Edwards, D. R. (1994) *The Social, Religious, and Political Aspects of Costume in Josephus*. In J.L. Sebaste & L. Bonfante (eds.) *The World of Roman Costume*, 153-159. Madison.
- Eisenberg, R. (2004) *The JPS guide to Jewish Traditions*. Philadelphia.
- Epstein, I. (ed.) (1952) (21961) *The Babylonian Talmud*. London.
- EWAia = Mayrhofer, M. 1992–1996–2001. *Etymologisches Wörterbuch des Altindoarischen*. 1., 2. und 3. Band. Heidelberg.
- Gindin, T. E. (2014) *Persian Loanwords, Encyclopedia of Hebrew Language and Linguistics*. Edited by: Geoffrey Khan. Brill Online.

53. Krivoruchko 2010.

54. Edwards 1994.

- Goldschmidt, L. (1871-1950) *Der babylonische Talmud*, Nachdr. 2002. Bde. 1-12. Frankfurt am Main.
- Guggenheimer H.-W. (2001) *The Jerusalem Talmud. First Order. Zeraim. Tractates Kilaim and Ševiit*. Studia Judaica Bd. 20. Berlin-Boston.
- Guggenheimer, H.-W. (2008) *The Jerusalem Talmud. Fourth Order. Nesiqin. Tractates Baba Qamma, Bava Meši'a, Bava Batra*. Edition, Translation, and Commentary. Studia Judaica Bd. 45. Berlin-Boston.
- Guggenheimer, H.-W. (2012) *The Jerusalem Talmud. Second Order: Mo'ed. Tractates Šabbat and 'Eruvin*. Edition, Translation, and Commentary. Studia Judaica Bd. 68. Berlin-Boston.
- Hartley, J. (2011) *The semantics of Ancient Hebrew colour lexemes*. Wilsele, Leuven.
- Heijmans, Sh. (2013) *Greek and Latin Loanwords in Mishnaic Hebrew. Lexicon and phonology* [in Heb.]. Tel Aviv University PhD thesis.
- Hengel, M., P. Schäfer, F. Avemarie, H.-J. Becker & F. G. Hüttenmeister (2004) *Übersetzung des Talmud Yerushalmi. II. Seder Moed. Traktat 1 : Šabbat*. Hrsg. v. Übers. v. Frowald G. Hüttenmeister. Tübingen.
- Hezser, C. (2005) *Jewish Slavery in Antiquity*. Oxford.
- Jastrow, M. (1903) *A dictionary of the Targumim, the Talmud Babli and Yerushalmi, and the Midrashic literature*. London – New York.
- Klein, E. D. (1987) *A comprehensive etymological dictionary of the Hebrew language for readers of English*. Jerusalem.
- Koehler, L. & W. Baumgartner (2002) *The Hebrew and Aramaic Lexicon of the Old Testament. 2 vols. English translation by M.E.J. Richardson*. Leiden-Boston-Köln.
- Krauss, S. (1898-1899) *Griechische und lateinische Lehnwörter im Talmud, Midrasch und Targum*, 2vols. Berlin.
- Krauss, S. (1910, 1911, 1912) *Talmudische Archäologie*. Drei Bände. Leipzig.
- Kriaras, E. (2001) *Dictionary of Medieval Vulgar Greek Literature (1100-1669), from A - παραθήκη*. Thessaloniki.
- Krivoruchko, J. (2012) Greek loanwords in rabbinic literature. Reflections on current research methodology. In *Greek Scripture and the Rabbis*, ed. by T. M. Law and A. Salvesen, 193-216. Leuven – Paris – Walpole, MA.
- Krupp M. (ed.) (2002–) *Die Mischna. Textkritische Ausgabe mit deutscher Übersetzung und Kommentar*. Jerusalem.
- Krupp, M. (2006) *Die Pessach Haggada*. Jerusalem.
- Rosenzweig, A. (1905) *Kleidung und Schmuck im biblischen und talmudischen Schrifttum*. Berlin.
- Roussin, L.A. (1994) Costume in Roman Palestine: Archaeological Remains and the Evidence of the Mishna. In J.L. Sebaste & L. Bonfante (eds.) *The World of Roman Costume*, 182-190. Madison.
- Schmeja, H. (1978) Die persischen Hosen, *Zeitschrift für vergleichende Sprachforschung* 92. Bd., 1./2. H., 69-73.
- Schmitt, R. (1971) „Méconnaissance“ altiranischen Sprachgutes im Griechischen. *Glotta* 49. Bd., 1./2. H. (1971), 95-110.
- Schwartz, J. (2004) Material culture in the land of Israel: Monks and Rabbis on clothing and Dress in the Byzantine Period. In M. Poorthuis & J. Schwartz (eds.), *Saints and Role Models in Judaism and Christianity*, 121-137. Leiden, Boston.
- Shamir, O. & N. Sukenik (2011) Qumran Textiles and the Garments of Qumran's Inhabitants, *Dead Sea Discoveries* 18, 206–225.
- Shlezinger-Katsman, D. (2010) Clothing. In Hezser, C. 2010 (ed.), *The Oxford Handbook of Jewish Daily Life in Roman Palestine*, 362-281. Oxford.
- Shtainzalts, A. (2010) *Talmud Bavli*. Jerusalem.
- Sokoloff, M. (2002) *A Dictionary of Jewish Babylonian Aramaic of the Talmudic and the Geonic periods*. Ramat-Gan.
- Sokoloff, M. (1992) *A Dictionary of Jewish Palestinian Aramaic of the Byzantine Period*. Ramat-Gan.
- Sperber, D. (1977–1979) Greek and Latin words in rabbinic literature: Prolegomena to a new dictionary of classical words in rabbinic literature. *Annual of Bar-Ilan University Studies in Judaica and the Humanities* 14–15:9–60; 16–17:9–30.
- Sperber, D. (1982) *Essays on Greek and Latin in the Mishna, Talmud and Midrashic literature*. Jerusalem.
- Stemberger, G. (2011) *Einleitung in Talmud und Midrasch*. 9. Auflage. München.
- Sukenik, N., D. Iluz, O. Shamir, A. Varvak & Z. Amar (2013) Purple-Dyed Textiles From Wadi Murabba'at. Historical, Archaeological and Chemical Aspects, *ATR* 55, 46-54.
- Trapp, Er. et al. (2001) *Lexikon zur Byzantinischen Gräzität besonders des 9.-12. Jahrhunderts*. 1. Band A-K. Wien.

# 8

## *Sha'atnez* – The Biblical Prohibition Against Wearing Mixed Wool and Linen Together and the Observance and Enforcement of the Command in the Orthodox Jewish Communities Today

Orit Shamir

Jewish law forbids *Sha'atnez* – wearing mixed wool and linen together was forbidden for the Jewish population. The article will first explain the meaning and acronym of *sha'atnez*, and then review the *sha'atnez* textiles which were found in the Land of Israel. The possible reasons for the prohibition of *sha'atnez* will be presented and remarks on observance and enforcement of the law in Orthodox Jewish communities today will be made according to ethnographic investigation.<sup>2</sup>

### The concept of *sha'atnez*

Jewish law forbids *sha'atnez* – wearing garments of mixed wool and linen. This is mentioned twice in the Hebrew Bible: It is written in *Leviticus* 19:19, where it is stated that “you shall not put on cloth from a mixture of two kinds of material”. The prohibition of “the mixture of diverse kinds” of material is mentioned

in additional contexts such as interbreeding different species of animals together, working different species of animals under the same yoke, and planting different species of seeds together in a single field. *Sha'atnez* garments are mentioned but the specific materials are not listed. In *Deuteronomy* 22:11, however, it is added that “You shall not wear cloth combining wool and linen”.

*Sha'atnez* applies only to sheep's wool and linen. Any other combination of plant and animal fibres does not create *sha'atnez*, such as the combinations of cotton, silk, camel hair, mohair, hemp or nettle. The wool and linen may not be spun, woven, sewn, tied, knotted, or knitted together for garment use. Even one linen thread found in a large garment of wool renders the entire garment *sha'atnez*.<sup>3</sup> Men and women are equally obligated in all the prohibitions of *sha'atnez* and it is also forbidden to clothe a child in *sha'atnez* garments.<sup>4</sup>

1. I would like to thank Rabbi Nahum Ben-Yehuda for his comments.

2. The Ancient Textiles Study Collection in Israel includes a wealth of textiles, basketry, cordage wood and leather artifacts, fruits and seeds – dating from 8000 BCE until 1800 CE. They can be seen on the on-line web site project of “Selected Artefacts from the Collections of the National Treasures”. In 2017 the collection will move to the National Campus for the Archaeology of Israel instead of the storeroom that is used today and will be called “The Nash Family Center for Ancient Textiles and Organic Materials”. Some of the textiles presented in this paper are stored in this collection. [http://www.antiquities.org.il/t/default\\_en.aspx](http://www.antiquities.org.il/t/default_en.aspx)

3. Brauner 2006, 1; Mishnah tractate Kil'ayim 9:9; Sifrah Qedoshim 2:4; Sifrah Qedoshim 2:4; Sifrah Devarim 235.

4. Brauner 2006, 2.

Site	No. of textiles	No. of <i>Sha'atnez</i> textiles
<i>Wadi ed-Dâliyeh</i> (Fig. 2)	58	3
<i>Masada</i> , sewing threads <i>Masada</i> , textiles (Fig. 3)	Thousands, only 122 were published	7 2
<i>Cave of Letters</i> sewing threads	346	1
<i>'En Tamar</i> (Fig. 4)	c. 200	c. 4
<i>Kuntillat 'Ajrud</i> (Fig. 5)	120	3

Table 1. Sites that yielded *Sha'atnez* textiles

This law is strictly observed by the Jewish Orthodox community today and many people bring clothing to special experts who are employed to detect the presence of *sha'atnez* by microscopes<sup>5</sup> and other means.

#### Etymology of the word *sha'atnez* (שַׁעֲטָנִי) להוסיף מדורית

The word is not of Hebrew origin, and its etymology is obscure. Some like Albright<sup>6</sup> quoted also by Lambdin and Milgrom<sup>7</sup> suggest that it is of Egyptian origin:

s'd 'to cut' and ng 'thread' or *sht* means weave and *n'dz* means false; the compound *sha'at-nez* therefore signifies a 'false weave' or false textile.<sup>8</sup>

The Mishnah, Judaism's first major canonical document following the Bible, explains the word *sha'atnez* as an acronym of three words in Hebrew: *shua* = 'combed', refers to the combing of the raw fiber; *tavey* = 'spun', the process of spinning fibers into a thread; *nuz* = 'twisted together into threads'. They represent three different stages in the processing

of the wool and linen fibers.

The Modern Hebrew word *sha'atnez* means mixture, and this may be a semantic change as a result of the word's use in Biblical law.<sup>9</sup> We use this word very often, for example, "the food in Israel is *sha'atnez* of cultures".

#### *Sha'atnez* textiles preserved in the archaeological record

Although thousands of textiles in Israel have been examined by the author,<sup>10</sup> not one piece of *sha'atnez* has been recovered from any Roman period Jewish site. This stands in contrast to Roman sites in neighboring areas, as for example in Syria at sites such as Dura Europos and Palmyra,<sup>11</sup> and in Coptic Egypt, which have yielded great quantities of textiles made of mixed linen and wool.<sup>12</sup>

Yet a few pre-Roman and Roman sites have yielded *Sha'atnez* textiles (Table 1, fig. 1) and they are discussed in my previous article about this topic.<sup>13</sup>

5. <http://shatnez.n3.net/>

6. Albright 1943, 32, note 27.

7. Lambdin 1953, 155; Milgrom 2000, 1659.

8. Brown, Driver & Briggs 2012, no. 3610.

9. Liebenberg 2014

10. Shamir 2007.

11. Pfister & Bellinger 1945, 25, No. 256; Pfister 1934, 13; 1937, Pls. 2:C, 4:F

12. Baginski & Tidhar 1980.

13. Shamir 2014.



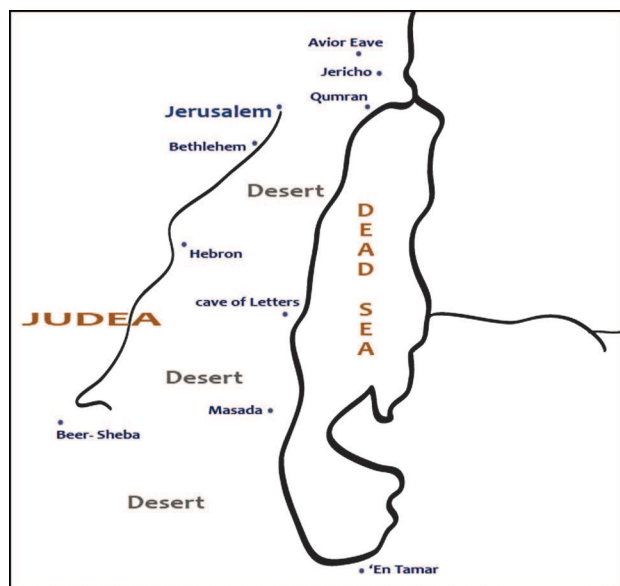


Figure 1. Judea Desert map (Credit: Shamir S.).

### Explanations for the Biblical prohibition

The Hebrew Bible does not explain why it is forbidden to mix the two fibers – wool and linen – other than being God’s command, but ancient (like the sages) and modern interpreters have suggested different explanations in order to make the rule of *sha’atnez* understandable. I will present a few reasons that could explain *sha’atnez*.

- a.) One explanation is connected with the priests’ garments: only priests were allowed to wear *sha’atnez*. Why was it necessary that the High Priest dressed in clothes made of mixed wool and linen while serving in the temple?

Perhaps this was to distinguish between the worship carried out by the priests and that carried out by the Jewish commoners. Therefore, *sha’atnez* was forbidden for the commoners. This explanation is also corroborated by Josephus Flavius (Joseph ben Matityahu, 37-100 CE), who wrote in his

book *Antiquities of the Jews* that wearing *sha’atnez* was prohibited and reserved for the priests of Israel.<sup>14</sup> I will here discuss only one aspect of the priests’ clothes and this is the *sha’atnez*. Although the garments of the High Priest were different from the garments of the ordinary priests, most scholars agree that all of them wore *sha’atnez*. Ordinary priests wore *sha’atnez* only in their girdle<sup>15</sup> and the High Priest in additional garments. The Bible describes the priests’ girdle in the following way: “And the sash of fine twisted linen, and blue and purple and scarlet material, the work of the weaver, just as the Lord had commanded Moses.”<sup>16</sup> Rabbinic Judaism maintains that *sha’atnez* was permitted in the case of the priest’s girdle, in which linen was woven with purple, blue, and scarlet yarn. According to the Rabbis (Judaic studies teacher, religious authority in Judaism), the purple, blue, and scarlet was made from wool:

As Boertien states, the use of special fabrics or liturgical garments was, and still is, a common phenomenon worldwide. In Egypt a special kind of Egyptian linen, the ‘royal linen’, was intended for priestly vestments.<sup>17</sup> In Mesopotamia, where the dominant fiber was wool, the priests were also dressed in linen.<sup>18</sup>

The eight garments worn by the High Priest are as follows: The breastplate, ephod, robe, tunic, turban, belt, crown and pants.<sup>19</sup> Three of these garments were *sha’atnez* woven with plied linen threads and blue, scarlet and purple wool threads,<sup>20</sup> considered the most expensive dyes and produced from Hexaplex trunculus (*tekhelet*), *Murex Brandaris* or *Thais Haemastoma*—(*argaman*) shellfish—and the kermes (*tola’at shani*) insect.

The Bible instructs that the High Priest’s vestment should be decorated and colored, for honor and for beauty: “Make sacral vestments for your

14. Josephus III, 7, 1.

15. [https://www.templeinstitute.org/priestly\\_garments.htm](https://www.templeinstitute.org/priestly_garments.htm) (accessed 01/02/2016).

16. Exodus 28:6.

17. Boertien 2014, 152; Hall 1986, 18.

18. Quillien 2014; Sheffer & Tidhar 2012, 310.

19. Exodus 28:4.

20. Exodus 28:6, 15.

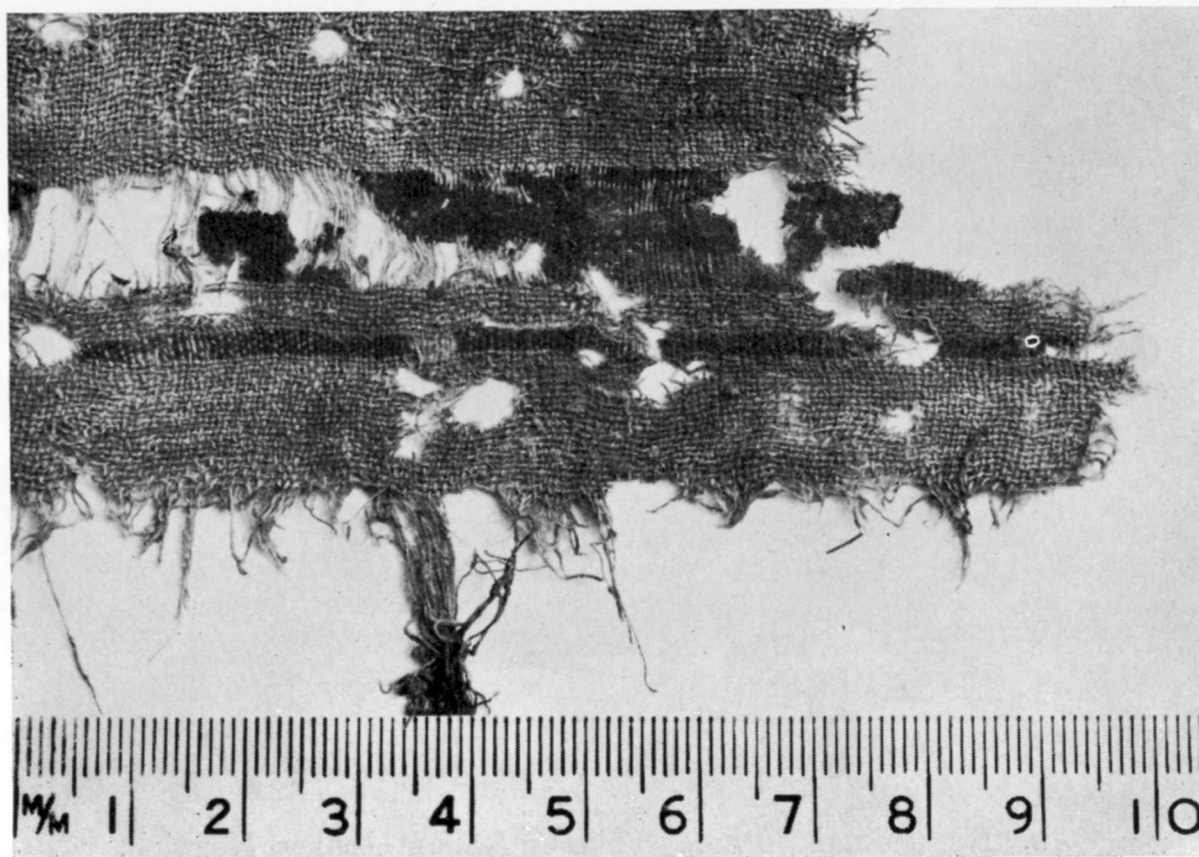


Figure 2. Wadi ed-Dâliyeh *sha'atnez* (Crowfoot 1974, Pl. 83b).



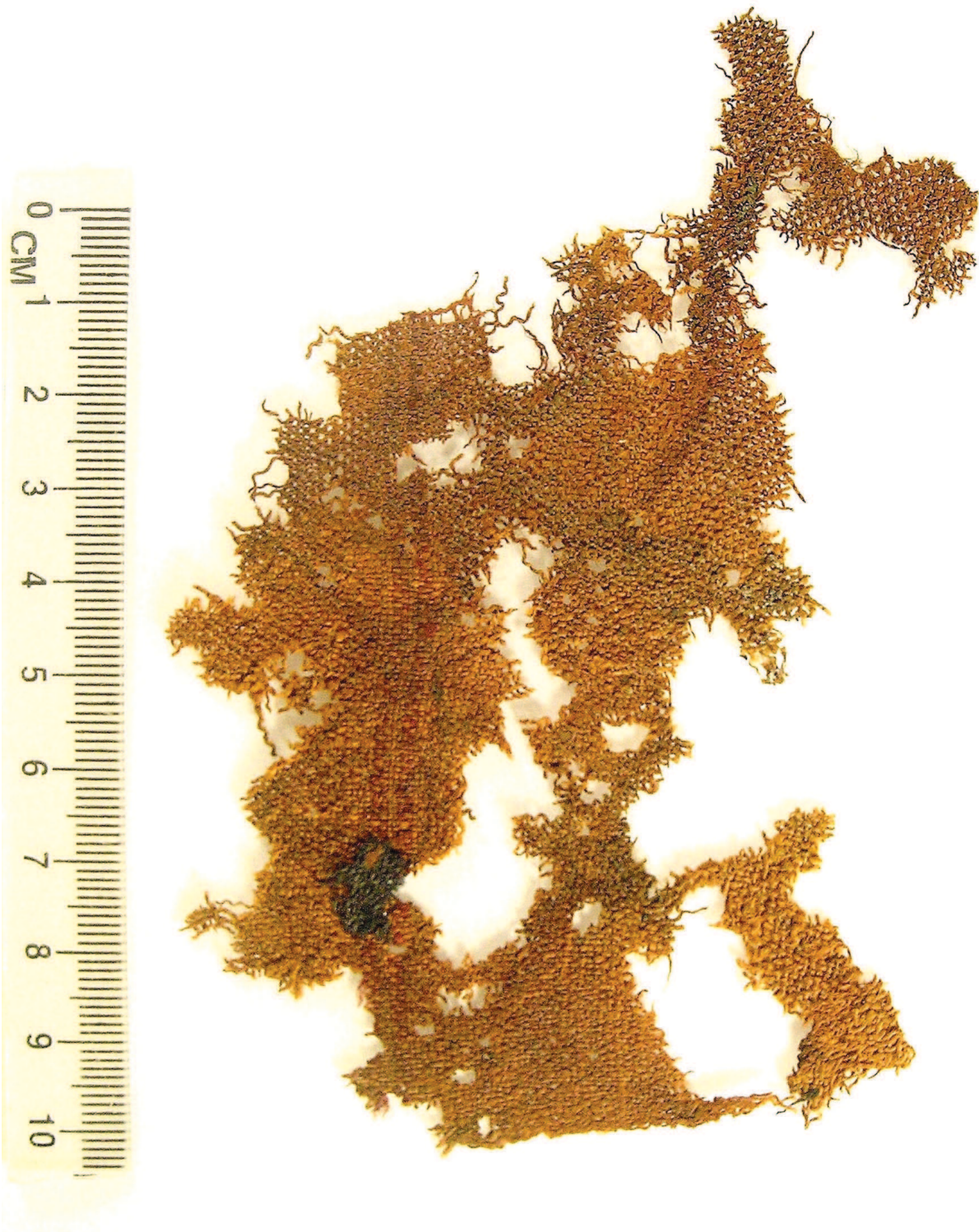
Figure 3. Masada *sha'atnez* (Israel Antiquities Authority No. 1995-9026. Courtesy of the Israel Antiquities Authority. Photo by Clara Amit).

brother Aaron, for dignity and adornment.”<sup>21</sup> Indeed, the Talmud<sup>22</sup> informs us that when the Persian king Ahasuerus made a feast for his advisors and officers and sought to impress them with

his greatness (as recorded in the scroll of Esther, which tells the story of Purim), he put off his own royal vestments and donned the uniform of the High Priest, which was more precious than his

21. Exodus 28:2.

22. Babylon Talmud Megillah 10, 2.



**Figure 4.** 'En Tamar. Linen textile decorated with wool bands (Israel Antiquities Authority No. 2003-9038. Courtesy of the Israel Antiquities Authority. Photo by Clara Amit).



**Figure 5.** Kuntillat ‘Ajrud. Linen textile decorated with wool bands. Sheffer & Tidhar 2012, 301.

own. These priestly garments were in his possession since the First Temple had been destroyed by the Babylonians. Another aspect of “honor and beauty” means that the uniform must fit each perfectly. Thus, it was forbidden for the pants, for example, to be too long or too short. The garments were made on order for each priest, tailored to fit his measurements exactly.<sup>23</sup>

One of the interpreters is R. Shimshon Refael Hirsch. In his work on the philosophy of Jewish Laws and Observances he states: “Only the priest had wool and flax mixed in his clothing, for he represents the community as a unity, and in his personality bridges all dissimilarities.” Rather than thinking of *sha’atnez* as something negative, in fact it represents a higher level of existence to which only certain individuals involved in certain activities can aspire!<sup>24</sup>

**b.)** Another explanation is given by the Talmud:<sup>25</sup> here, it is suggested that the prohibition of *sha’atnez* is related to Cain and Abel, the first naturally born human beings. They brought

offerings to God: “Now it came to pass at the end of days, that Cain brought of the fruit of the soil, interpreted as flax, an offering to the Lord. And Abel he too brought of the first born of his flocks and of their fattest, and the Lord turned to Abel and to his offering.”<sup>26</sup> This mixture ended up being lethal and Abel lost his life.

**c.)** Another reason is that linen is a product of a riverine agricultural economy, such as that of the Nile Valley, while wool is a product of a desert, pastoral economy, such as that of the Hebrew tribes. Maimonides, a medieval Jewish philosopher,<sup>27</sup> argued that the prohibition was a case of the general law against imitating Canaanite customs<sup>28</sup> – “And you shall not walk in the manner of the nations...”<sup>29</sup> The rules about forbidden mixtures serve to remind the Israelites how their past experiences with Canaanites and Egyptians threatened their national identity.

23. Leviticus 6:3; [https://www.templeinstitute.org/priestly\\_garments.htm](https://www.templeinstitute.org/priestly_garments.htm)

24. Hirsch 1981.

25. Midrash-Genesis Rabbah 5.

26. Genesis 4:1-17.

27. Medieval Jewish philosopher.

28. Liebenberg 2014, 7.

29. Leviticus 20:23, 18:3.

### Observance and Enforcement of the Command in the Orthodox Jewish Communities Today

Observant Jews in current times also follow the laws of *sha'atnez*. With the widespread use of synthetic fabrics, the issue of *sha'atnez* is more complicated and especially since many garments are manufactured in various parts of the world by non Jews. In some cases, parts of a garment are being manufactured in one country and other parts in another. The result is that it is difficult for consumers to know the type of fibers that is in that garment.

Considering these developments, the *sha'atnez* testers of North America and their contacts in other countries have an informal network by which alert notices are sent out as new developments are discovered. This is all part of a support system that has been developed around this ancient and mysterious prohibition.<sup>30</sup> For example, I found in one of the websites dealing with *sha'atnez* this message: "We are therefore alerting the public that some jackets of the following brands were found to contain *sha'atnez* this past winter: Austin Reed, Brooks Brothers, J. Crew and Zara Man."<sup>31</sup>

Most *sha'atnez* that is found today is located in the collar stiffeners of men's suits especially in the more expensive suits. Most suits today are made of wool or wool blends. To retain the shape of the collar area, a canvas stiffener is generally sewn into the collar and linen is the fabric considered by the clothing industry as being the best material for this purpose.

Since clothing labels cannot be relied upon, there must be another way in which to determine whether or not an article of clothing contains *sha'atnez*. *Sha'atnez* laboratories had been established with the approval of prominent Rabbinic Authorities – in Israel, the U.S., England and elsewhere. The laboratories are staffed by specially trained experts who know where wool and linen may have been used in clothing and other articles, e.g., a suit may contain *sha'atnez* in any over sixty places. They also know how to identify wool and linen scientifically by means of microscopic analysis and chemical testing.

Newly purchased garments are checked to ensure that there are no forbidden mixtures. The sample takers are trained to take appropriate samples from a garment without damaging it.

Even suits that are 100% synthetic may contain *sha'atnez*. American law allows some leeway in labeling. A label that states that a garment is 100% wool may contain as much as 2% of other materials. In addition, the label refers only to the fabric, not to additional sewing threads or material in the padding and ornamentation.

It is permitted to try on a garment in a clothing store without knowing whether it has *sha'atnez* or not. If the label clearly states that the garment includes both wool and linen, then it is prohibited. However, there are different opinions about this case.

Sometimes labels can be misleading, especially in foreign languages, for example: "Laine" in French is wool, while "lin" in French means linen.<sup>32</sup>

### Removing the *Sha'atnez*

Once the *sha'atnez* in the garment has been located, either the wool or the linen must be removed completely. If the tailor or the store has already removed it, it still must be submitted to verification in a *sha'atnez* laboratory.

Sometimes the sections containing linen are removed from wool clothing or wool from linen clothing. If linen is found in a collar canvas, it is removed and replaced by a non-linen textile.

### Training to become a *sha'atnez* checker (fig. 6)

"If you are looking for a job, there is a great need, particularly in smaller Jewish communities, to recruit qualified *sha'atnez* checkers. For those communities or individuals serious about undergoing a training programme, we recommend that you contact Rabbi Joel Shochett, head of The National Committee of *sha'atnez* Testers and Researchers, New Jersey."<sup>33</sup>

30. [http://www.chabad.org/library/article\\_cdo/aid/381831/jewish/The-Mysteries-of-Shaatnez.htm](http://www.chabad.org/library/article_cdo/aid/381831/jewish/The-Mysteries-of-Shaatnez.htm)

31. <http://www.jerusalemkoshernews.com/2011/01/shatnez-alert-%E2%80%93-men%E2%80%99s-suits/> (accessed on 30/01/2016)

32. <http://shatnez.n3.net> (accessed on 15/12/2015).

33. <http://www.star-k.org/articles/articles/1227/the-mitzvah-of-shatnez/> (accessed on 30/01/2016).



Figure 6. Brussels School Learns *sha'atnez*. [http://www.collive.com/show\\_news.rtx?id=10219](http://www.collive.com/show_news.rtx?id=10219) (accessed 31/01/16).

## Conclusions

The concern to avoid *sha'atnez* during the Roman period, despite the hardship of war against the Roman army and the certain temptation to buy these textiles from non-Jews at the markets, is impressive and caused technical weaving problems.

Stitching wool textiles with linen threads or *vice versa* is also forbidden in *sha'atnez*. The presence of linen in the sewing threads of the Cave of the Letters and Masada can be explained by the harsh siege conditions of the Roman army.

Another important fact is the almost complete absence of mixed wool and linen (*sha'atnez*) textiles at non-Jewish sites, except in a few cases in the Roman period in a Nabatean burial at 'En Tamar.<sup>34</sup> It is striking that most of the textiles in Israel during the Roman period were produced by Jews and purchased by the non-Jewish population. There is a great resemblance between the Nabatean and Jewish textiles (1st-2th centuries CE), including weaving techniques, colors, decorations such as shaded bands and the number of threads per cm.

This long tradition of keeping the rules of *sha'atnez* exists at least since 3000 years and continues till today.

34. Shamir 2016.

## Bibliography

- Albright, W. F. (1943) An Archaic Hebrew Proverb in an Amarna Letter from Central Palestine. *Bulletin of the American Schools of Oriental Research* 89, 29-32.
- Baginski, A. & Tidhar, A. (1980) *Textiles from Egypt 4th-13th Centuries CE*. Jerusalem.
- Boertien, J. H. (2014) Public or Domestic? Temple, Text and Textile Production at Khirbet al-Mudayna in Moab. Exploring the Narrative. Jerusalem and Jordan in the Bronze and Iron Ages. In J. Van der Steen, J. Boertien & N. Mulder-Hymans (eds.), *The Library of Hebrew Bible*, 133-158. Old Testament Studies 583. London.
- Brauner, R. (2006) *A Simple Guideline to Sha'atnez*.
- Brown F., Driver S. R. and Briggs C.A. (2012) *The Brown-Driver-Briggs-Gesenius Hebrew and English Lexicon (BDB)*. Massachusetts.
- Crowfoot E. (1974) Textiles. In P.W Lapp, and N.L. Lapp. *Discoveries in the Wâdi ed-Dâliyeh* (Annual of the American Schools of Oriental Research. 41), 60-77.
- Hall, R. (1986) *Egyptian Textiles*. London.
- Hirsch, S. R. (1981) *Horeb: A Philosophy of Jewish Laws and Observances*. London. (Eng. trans., Dayan Dr. I. Grunfeld)
- Josephus, *Jewish Antiquities*, ed. H. St.J. Thackeray. London 1956-1957.
- Lambdin T.O. (1953) Egyptian Loan Words in the Old Testament. *Journal of the American Oriental Society* 73, 145-155.
- Liebenberg, W. A. (2014) Why does God forbid using Wool and Linen together? <https://ancienttruthshidden.files.wordpress.com/2014/02/wool-and-linen.pdf> (accessed 31/01/2016).
- Pfister, R. & Bellinger, L. (1945) *Excavations at Dura Europos IV, 2. The Textiles*. New Haven.
- Milgrom, J. (2000) *Leviticus 17-22*, The Anchor Bible, Doubleday NY.
- Quillien, L. (2014) Flax and Linen in the First Millennium Babylonia BCE: Origins, Craft Industry and Uses of a Remarkable Textile. In M. Harlow, C. Michel & M.-L. Nosch (eds.), *Prehistoric, Ancient Near East and Aegean Textiles and Dress. An Interdisciplinary Anthology*, 277-302. Ancient Textiles Series 18. Oxford.
- Shamir, O. (2007) *Textiles in the Land of Israel from the Roman Period till the Early Islamic Period in the Light of the Archaeological Finds*. Institute of Archaeology, The Hebrew University. PhD dissertation.

- Shamir, O. (2014) Two Special Traditions in Jewish Garments and the Rarity of Mixed Wool and Linen Threads at the Same Textile in the Land of Israel. In M. Harlow, C. Michel & M.-L. Nosch (eds.), *Prehistoric, Ancient Near Eastern and Aegean Textiles and Dress: An Interdisciplinary Anthology*, 298-308. Ancient Textiles Series 18. Oxford.
- Shamir O. (2016) Mixed Wool and Linen Textiles (Sha'atnez in Hebrew) from a Nabatean Burial Cave at 'En Tamar. In J. Patrich, O. Peleg-Barkat and E. Ben-Yosef (eds.) *Arise, Walk through the Land. Studies in the Archaeology and History of the Land of Israel in Memory of Yizhar Hirschfeld on the Tenth Anniversary of his Demise*. Jerusalem, 53-60.
- Sheffer, A. & Tidhar, A. (2012) Textiles and Basketry at Kuntillat 'Ajrud. In Z. Meshel (ed.), *Kuntillet 'Ajrud. An Iron Age II Religious Site on the Judeah-Sinai Border*, 289-312. (after 1991 *'Atiqot* 20;1-26 with comment by the editor).

# Armenian *karmir*, Sogdian *karmīr* ‘red’, Hebrew *karmīl* and the Armenian Scale Insect Dye in Antiquity

Agnes Korn & Georg Warning

*For our friend Uwe Bläsing*

This paper looks at three terms denoting the colour ‘red’, viz. Armenian *karmir*, the obviously corresponding Sogdian word *karmīr*, and *karmīl* ‘scarlet’ found in the Hebrew Bible. It will first briefly discuss the etymology of these words (summarising an argument made elsewhere) and argue that the words in question represent a technical term for a red dye from Armenia produced by scale insects. We will then attempt to show that historical data and chemical analysis of extant historical textiles confirm the Armenian red as the relevant dye.<sup>1</sup>

## Etymologies

### *Hebrew karmīl*

As a starting point, it is worthwhile to consider the status of colour terms in Hebrew (and other premodern cultures) in general. Jacquesson notes:

“En français, il y a très peu de choses dont on ne puisse pas dire ‘c’est rouge’ ou ‘c’est noir’ – mais en hébreu ancien il y a très peu de choses dont on puisse le dire. En hébreu biblique (...), chaque couleur a un domaine d’application restreint, à certains types d’objets. (...) Il semble qu’elles [= les couleurs] soient souvent comme des textures, des sortes de matière – et l’importance des teintures confirme cette impression.”<sup>2</sup>

Essentially, then, ancient colours are not abstract features, but bound to the objects of which they are a quality, rendering colour terms almost material features.

This applies to the shades of an animal’s coat, which still nowadays are described much like a quality of the animal (as in English *dun*, German *Falbe*

1. Sincere thanks are due to the persons and institutions specified below for their permission to publish their photos. We are also very grateful to Johnny Cheung (Paris) and Erika Korn (Konstanz) for providing copies and references of works not readily available to us, and to Sidsel Frisch (Copenhagen) and Emmanuel Giraudet (Paris) for help with the images. Transcriptions of the Hebrew passages were kindly provided by Annelies Kuyt (Frankfurt a.M.); translations are from *The Holy Bible, containing the Old and New Testaments, Authorized King James Version* (...). Nashville: Broadman & Holman 1979. The underlinings in the passages quoted below are our additions. New Persian is transcribed in the classical pronunciation insofar as literary quotes (and poets’ names) are concerned, but in contemporary Farsi pronunciation where the reference is to modern works (including titles of books and articles.) For more details on etymological and philological matters, see Korn 2016.

2. Jacquesson 2012, 68f.





**Fig. 1:** Dyeing with indigo, workshop of Dr Ismail Khatri (Gujarat, India). Photo: Heike Boudalfa

‘(horse of) pale colour’ or *brown bear* as name of a species) as well as to colours of textiles, which may literally refer to the substances with which they are dyed. Thus, Sanskrit *nīla-vant-* (RV+) is actually not ‘dark, blue’, but ‘rich in indigo, i.e. dyed with large quantities of indigo’. In looking for an etymology for the terms under discussion, the question thus is about the dyeing substance it refers to.

Late Biblical Hebrew *karmīl* occurs only three times. All three attestations are found in the book 2 Chronicles, and refer to the construction of the temple, as in the passage 2 Chron. 3.14:

וַיַּעַשׂ אֶת־הַפְּרָכֶת תְּכֵלֶת וְאַרְגָּמָן וְכַרְמִיל  
וּבְרִיץ וַיַּעַל עָלָיו כְּרוּבִים:

► wayya ‘as’ *et-happāroket tākēlet*  
*wə’argāmān wəkarmīl ūbūš wayya ‘al*  
*‘ālāyw kərūbīm*

“And he [= Solomon] made the veil [of the temple] of blue, and purple and crimson, and fine linen, and wrought cherubims thereon.”

In the remaining parts of the Old Testament, the series of blue, purple and crimson or scarlet reoccurs



**Fig. 2:** *Porphyrphora hamelii* (original length max. 1 cm). Photo: Paul Starosta

repeatedly, but instead of *karmīl* there is the expression *tōla* ‘at *sānī* תּוֹלַעַת שָׁנִי, containing the words תּוֹלַעַת / תּוֹלַעָה *tōle’a / tōla* ‘worm, maggot’ and שָׁנִי *sānī* ‘crimson, scarlet’.<sup>3</sup> This expression is reminiscent of French *vermeil* ‘scarlet’, which is derived from *ver* ‘worm’. Hebrew *karmīl* is thus likely *a priori* to be not a colour, but a technical term for a dye, made from certain scale insects or cochineals such as the one in Fig. 2.

In fact, this has been suggested since long ago; and it has also generally been assumed that Hebrew *karmīl* is a loanword from an Indo-European language and ultimately derives from Proto-Indo-European *\*k<sup>u</sup>ṛmi-* ‘worm, maggot’ (the protoform of, for instance, Lithuanian *kirmis*, Sanskrit *kṛmi-*, etc.).<sup>4</sup> Slavic words for ‘red’ such as Old Church Slavonic *črŭmŭnŭ* show the same line of derivation.

More precisely, as established already by Delitzsch,<sup>5</sup> the source of *karmīl* must be an Iranian word related to Persian *kirm* ‘worm’ and its derivative *qirmiz* ‘red’. *karmīl* would then be a member of the group of Iranian words that entered Hebrew via Aramaic, and which are comparatively frequent in the book 2 Chronicles.<sup>6</sup>

The Iranian source form, specified as unattested

3. The series of these three colours always refers to textiles of liturgical importance, used in the temple and for priest’s garments (see Brenner 1982, 143-146; Hartley 2010, 185-210; and Clines s.v. for the attestations).

4. Cf. e.g. Mayrhofer 1956, 261.

5. Delitzsch 1898, 757f.

6. We are indebted to Holger Gzella for this information. Cf. Sáenz-Badillos 1993, 115-120; Wagner 1967, 67.

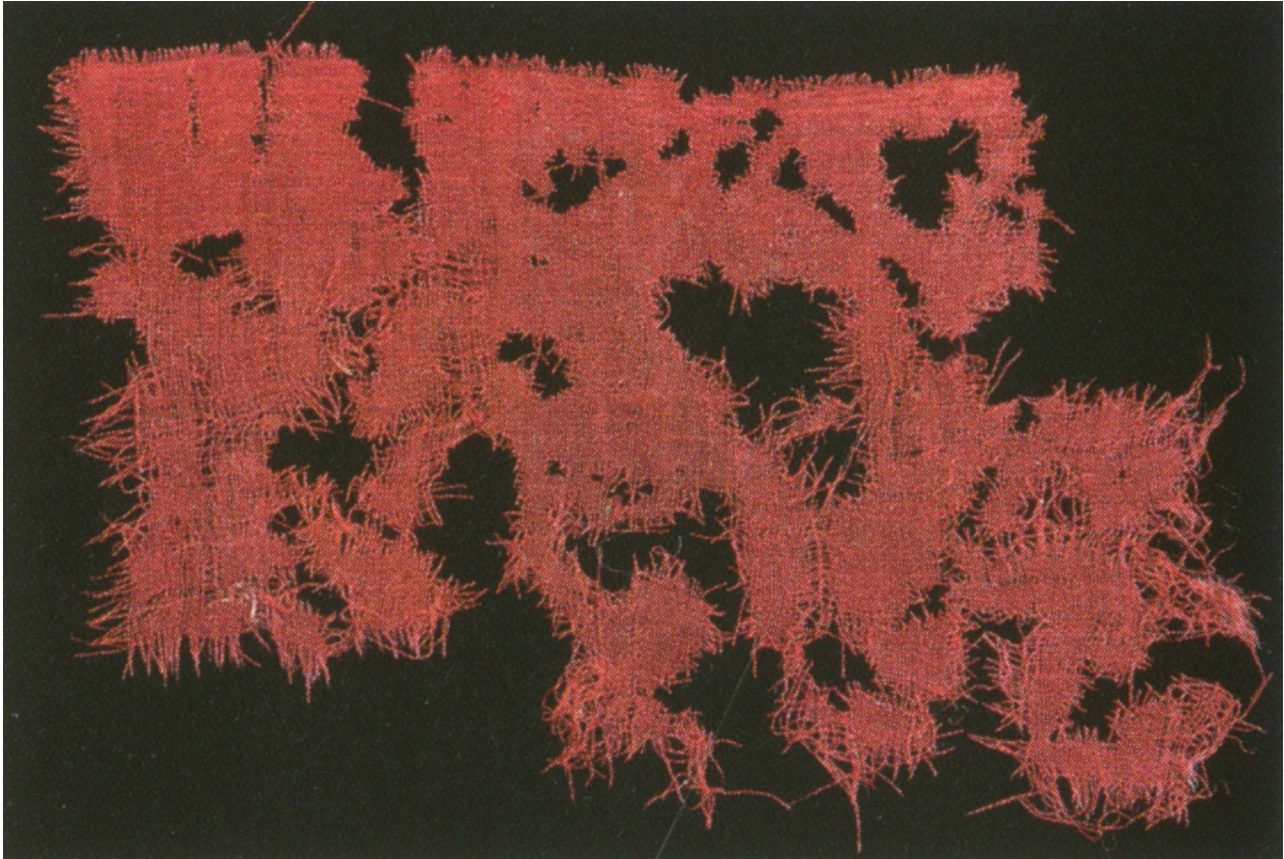


Fig. 3: Cashmere fragment. Red dye: *Porphyrophora*. Photo: © Mission archéologique franco-chinoise au Xinjiang

by Delitzsch, might be taken to be present in a word found in the meantime in Sogdian, an Eastern Iranian language from the Middle Iranian period, as Meillet (1912, 247) announced: “Le mot [arménien] *karmir* « rouge », dont le caractère iranien est encore mis en doute par Hübschmann [1897], *Arm. Gramm.*, p. 167, se retrouve maintenant en sogdien sous la forme *krm`yr`*”.<sup>7</sup> That this Sogdian word, probably to be read /karmīr/<sup>8</sup> should be the source of Armenian *karmir* has then also be advocated by Olsen<sup>9</sup> and others.

However, there is a considerable geographical distance between Armenian and Sogdian, and also a chronological problem, since the word would need to have migrated early enough from Central Asian

Sogdiana into Palestine to feature in the Old Testament. The assumption of Sogdian loanwords in Armenian has also been weakened on linguistic grounds by recent research, which has shown that a Western Iranian language is more likely to be the source.<sup>10</sup>

Obviously, Armenian *karmir* needs to come from an Iranian dialect that shows the required output of PIE *\*k<sup>u</sup>ṛmi-*, particularly *ar* as product of PIE *\*r*. Such a dialect needs to be assumed anyway to account for Iranian loanwords in Armenian such as *marg* ‘bird’ (cf. Sanskrit *mṛga-*).<sup>11</sup> Parthian and Persian, the chief sources of Iranian loanwords in Armenian, are excluded because their result of *\*r* is *ir* in this context (cf. New Persian *kirm* ‘worm’). An

7. Meillet 1912, 247.

8. Gauthiot 1914, 143 etc.

9. Olsen 2005, 478.

10. Cf. Korn 2013. Note that the absence from Western Iranian was the only reason to assume an origin from an Eastern Iranian language for that specific group of loanwords in Armenian (the words in question do not have any specifically Eastern Iranian features).

Iranian language that shows the required output of \*ʔ (/kard/ ‘did’, /barz/ ‘high’, /varg/ ‘wolf’), and indeed /karm/ for ‘worm’, is Zazaki, a contemporary Western Iranian language spoken in Eastern Anatolia, overlapping with regions where Armenian was also spoken.

### Persian *qirmiz*

Persian قرمز *qirmiz*, nowadays the usual word for ‘red’, is surprisingly absent from earlier New Persian (where ‘red’ is *surx*). There is no attestation of *qirmiz* (nor \**kirmiz*) in the *Shāhnāme*, and none, for instance, in Omar Khayyām’s *Rubā’iyāt* (where the red wine is described as *lāl* or *argawān*), nor in the classical Persian texts contained in the TITUS database.<sup>12</sup> Also, the Persian encyclopaedic dictionary by Dehrodā, who regularly quotes passages from classical poetry for each entry, has no literary example for *qirmiz*.

Hasanī 2010, studying the Persian word *surx* ‘red’, finds the oldest attestations of *qirmiz* to be verses by Nizāmī (12<sup>th</sup> century) and by Nāṣir Khusrau (11<sup>th</sup> century).<sup>13</sup>

\* \* \* همچنین دانم نخواهد ماند برگشت زمان \ /  
موی جعدت عنبری و روی خوبت قرمزی

► *hamčīnīn dānam naxwāhad mānd bar  
gašt-i zamān /  
mū-yi ja’d-at ‘anbarī va rū-yi xūb-at  
qirmizī.*

“And I also know that over the course  
of time your curled hair will not remain  
amber-scenting nor your good face red  
(*qirmizī*).”

(Nāṣir Xusrau, *Dīvān*, Qaṣīda 223, line 7)

The other poet, Nizāmī, was from Ganja, a town in the Republic of Azerbaijan, some 70 km from the Armenian border of today. It is known as an old centre of carpet production in wool and silk, illustrated here by the Ganja carpet in Fig. 4 (admittedly not ancient, but in the style termed “Old Ganja”). Indeed, one of Nizāmī’s verses containing *qirmiz*, describing a banquet prepared for Alexander by the Chinese emperor, appears to use *qirmiz* in material-like sense:<sup>14</sup>

\* \* \* نشاط می قرمزی ساختند \ /  
بساطی هم از قرمز انداختند

► *našāt-i mai qirmizī sāxtand /  
bisāt-ē ham az qirmiz andāxtand*

“They made the wine’s joy red (*qirmizī*)  
/ [and] also spread out a carpet from red  
(*qirmiz*) [material].”

(Nizāmī Ganjawi, *Šarafnāma*, episode  
*Mihmānī-kardan-e xāqān-i Čīn  
Iskandar-rā*)<sup>15</sup>

Ancient and also later Arabic dictionaries define *qirmiz* as referring to the Armenian scale insect dye. One of these, the *Aqrab al-mawārid* (ca. 1900), is also the reference given by Dehrodā:<sup>16</sup>

\* \* \* صبغ ارمنی احمر يقال انه من عصارة دود  
يكون في أجسامهم و يقال انه تصبغ به الثياب  
فلا يكاد ينضل لونه

*šabgun armaniyun aḥmaru yuqālu  
annahu min ‘ašārati dūdīn yakūnu fī  
ājāmihim wa yuqālu annahu tušbaḡu bihi  
at-tiyyābu fa-lā yakādu yundālu lawnuhu*

11. A third Western Iranian language in addition to Parthian and Persian as source for Iranian items in Armenian needs to be assumed also for other reasons (cf. Korn & Olsen 2012).

12. These are: *Vīs u Rāmīn* (Gurgānī); *Sindbad-Nāme* (Zahīrī Samarqandī); *Ġazals* (Qabūlī).

13. Nāṣir Xusrau (1995, 562); it is Qaṣīda no. 253 in other editions. Nāṣir Xusrau was born in Qabodiyon (Khorasan, today Tajikistan).

14. Nizāmī 1956, 410 l. 4. This verse is also the attestation of *qirmizī* quoted in the Tajiki dictionary by Šukurov et al. 1969/II, 691: *Нашоти маи қирмизӣ сохтанд / Бисоте ҳам аз қирмиз андохтанд.*

15. Wilberforce Clarke translates (Nizāmī 1881, 651): “Exhibited the joyousness of the crimson wine; / Cast also a carpet of crimson silk.” while Bürgel’s German prose translation has “The red wine, which was drunk on red carpets, raised the spirits” (Nizāmī 1991, 296). The Persian text edition comments “They spread out a red (*qirmizī*) carpet and tablecloth in the gathering place and, as they served red wine on the red carpet, they started to celebrate the red wine (all with *surx*)” (Nizāmī 1956, 410).

16. Dehrodā (XXXVIII, 230 s.v. قرمز). Cf. also the quotes in Lane (VII, 2519), and note that the dictionary of classical Persian by Steingass (1891, 966) qualifies *qirmiz* as coming from Arabic.

**Fig. 4:** Carpet style *Kedim Ganja* ('Ancient Ganja') from Ganja (Azerbaijan) dated 1895, with dedication in Armenian. Photo: Marco Frangi.<sup>17</sup>



17. For further details see Azadi *et al.* 2001, 410.

“A red Armenian dye of which it is said that it is from the juice of a worm living in their swamps, and of which it is said that clothes are dyed with it, and its dye is hardly surpassed.”<sup>18</sup>

Thus, the word must have been borrowed from Persian into Arabic, perhaps already with the meaning of the Armenian red; in Arabic, the initial *k-* was changed into *qāf* to yield *qirmiz*; later on it was borrowed back into Persian.<sup>19</sup> This also implies that Persian cannot be the source of Hebrew *karmīl* (in spite of opinions to the contrary voiced by some authors), and the ultimate source of the word must rather be an Iranian language such as *Zazaki*.

Also, historical sources report that scarlet dye needed to be imported into Iran,<sup>20</sup> and it is known that textile workshops found it difficult to afford the high prices for the Armenian red dye.<sup>21</sup> It is also known that the Sasanian kings were wearing red coats, and that king Hormisd I sent such a red coat to the Roman emperor Aurelian (270-275),<sup>22</sup> maybe of similar style as the Sasanian caftan in Fig. 5.

### Textual evidence

Indeed, classical sources and Armenian historical texts (as well as testimonies from later times)<sup>23</sup> combine to show that the red dye produced in Armenia was famous for its quality already in antiquity. The clearest description is in the *Geography* (short version, chapter V, xv) attributed to Anania Širakac‘i (610-685):

\*\*\* Եւ ունի Արարատ լերինս, և դաշսս՝  
և զաւր՝ պարարտութիւն (...) Եւ որդն

սիզաբերեալ յարմատոյ, առ ՚ի գարդ  
կարմրութիւն զունոյ.

• *Ew owni Ararat lerins, ew dašts, ew zamenayn parartowt‘iwn (...). Ew ordn sizabereal yarmatoy, ar ‘i zard karmrowt‘ean gownoy.*

“La province d’Ararad a des montagnes, des plaines avec toute sorte de productions (...) : on y trouve aussi un ver qui naît de la racine d’une plante et qui fournit la couleur rouge”.<sup>24</sup>

Even earlier is the pharmaceutical work *Materia medica* by Dioskurides (1<sup>st</sup> century AD), who says about the scale insect dye (IV: 48):

\* \* \* ἀρίστη δὲ ἐστὶν ἡ Γαλατικὴ καὶ Ἀρμενιακὴ, ἔπειτα ἡ Ἀσιανὴ καὶ Κιλικίος, ἐσχάτη δὲ πασῶν ἡ Σπάνη.

“The best is from Galatia and Armenia, then that from Asia and that from Cilicia, and last of all that from Spain.”<sup>25</sup>

### Textiles and cochineals

#### Scale insects used for dyeing<sup>26</sup>

The next step for the present argument is to demonstrate that the evidence of etymological reasoning and of textual resources has a counterpart in reality, i.e. that an Armenian dye was used widely enough to render the assumption plausible that it is referred to by Hebrew *karmīl*: the Armenian scale insect is by far not the only species from which cochineal dyes have been produced. The best known type is the Mexican

18. The print edition has *tusyaġu* ‘made’ (one additional dot) for the semantically more fitting *tusbaġu* ‘dyed’ that figures in the online version (<http://www.loghatnaameh.org/dekhodaworddetail-b3e3d7b1273048f0ae52be830cd0ae1b-fa.html>).

19. In Turkic, the words for ‘red’ mirror the influence of Persian: *qırmızı* is ‘red’ in those Turkic languages closer to Persian influence (Turkish, Azeri) while others (Kazakh, Kirgiz, Tatar, Uzbek) use the inherited word *qızıl*.

20. Born 1936, 223, referring to Pfister.

21. Cf. Kurdian 1941, 106.

22. Born 1936, 223; Pfister 1935, 35.

23. For which see Kurdian 1941; Donkin 1977, 849-853; and Cardon 2014, 627f.

24. My transcription; edition and translation Saint-Martin 1819, 367, who notes p. 390: “Il s’agit ici d’une sorte de cochenille.”

25. Edition Wellmann (II, 205); translation Osbaldeston & Wood 2000, 588f.

26. For details, see Cardon 2014, 585-642; 2007, 607-666 and Łagowska & Golan 2011.



**Fig. 5:** Cashmere caftan (6<sup>th</sup>/7<sup>th</sup> c.) found in Antinoë (Egypt). Red dye: *Porphyrophora hamelii*. Photo: © Lyon, MTMAD – Pierre Verrier



**Fig. 6:** *Dactylopius coccus* on cactus. Photo: Ana Roquero

scale insect, *Dactylopius coccus* (Fig. 6), which was widely used before synthetic colours were invented, but it cannot play a role here because it came from Latin America too late to be of relevance.

The Indian scale insect, *Kerria lacca* (Fig. 7), forms encrustations on branches; one breaks the twigs with the encrustation into pieces (and puts them into water to use the dye). This substance is called *lākṣā* in the Sanskrit literature and described much like a mineral, probably because the crusts are not seen as being composed of individual insects. The word *kṛmi*- ‘worm’, on the other hand, is not used for the scale insect. Assumptions that Armenian *karmir*, or



**Fig. 7:** *Kerria lacca* crust on twig. Photo: Barbara Bigler



**Fig. 8:** *Kermes vermilio* on Mediterranean oak. Photo: Dominique Cardon

Persian *qirmiz*, might be of Indian origin, are thus rather unlikely.<sup>27</sup>

Then there is the Mediterranean scale insect *Kermes vermilio* (Fig. 8), which predominantly lives on Mediterranean oak trees. In the passage quoted above, Dioskurides refers to this species, obviously assuming that the regions he mentions all use the same cochineal. However, *kermes* was not seen as an insect in antiquity, but rather perceived as a kind of fruit or berry of the tree (indeed the females are immobile).

The European scale insects, *Porphyrophora*, comprise several species. The ones potentially relevant here are the Armenian one, *Porphyrophora hamelii* (Fig. 2), and the European one, *Porphyrophora polonica* (Fig. 9).

27. For more discussion of the Indic scale insect, see Korn 2016, 5f.



**Fig. 9:** *Porphyrophora polonica* on grass root. Photo: Dominique Cardon

### *Chemical analysis*

In a series of articles and books from the 1930s, Rodolphe Pfister published and examined a number of textile specimens from regions in contact with the Iranian cultural sphere, which in a number of instances show Iranian motifs or Iranian style. The red colorants of these pieces include, besides madder (*Rubia tinctorum*), a scale insect dye other than *Kermes*.<sup>28</sup> One such piece is the tapestry fragment (Fig. 10), about which Pfister says: “Quant au style, nous trouvons de nombreux souvenirs sassanides”, and applies this also to details of the weaving technique.<sup>29</sup> The textiles Pfister analysed were found in Egypt (dating from the 3<sup>rd</sup>-7<sup>th</sup> centuries AD) and in Dura-Europos (Fig. 13) and Palmyra in Syria (2<sup>nd</sup>-3<sup>rd</sup> centuries AD) on the border between the Roman and the Iranian empires.<sup>30</sup>

Pfister identified the red of this tapestry as well as a number of other textiles<sup>31</sup> as being dyed with



**Fig. 10:** Tapestry fragment found in Egypt (Antinoë). Red dye: *Porphyrophora*. Photo: Pfister 1936, 80<sup>a</sup>.

28. This particularly applies to textiles from Antinoë (Egypt), about which Pfister 1935, 46 says that they “correspondaient toujours à une origine persane” (similarly 1934a, 83 n. 21). Pfister 1928, 242 also notes that cochineal dyes start to appear in Egypt as part of the Iranian influence.

29. Pfister 1936, 82. See also Pfister 1932b, 134-139 for some Oriental stylistic features of this group of textiles.

30. Pfister 1935, 36f.; Pfister 1934a, 85: “Palmyre étant alors le principal intermédiaire pour le commerce partho-romain et plus généralement pour les échanges d’Orient à Occident, Doura a profité de cette situation en devenant ville caravanière.”

31. These are the following items:

Pfister 1932a (textiles from Antinoë in the Louvre): Pl. 13 bottom left, Pl. 14 bottom left, Pl. 14 top (= Pfister 1932b, Pl. XLI), all described as having their red by indigo over madder (*Rubia tinctorum*), but recognised as *Porphyrophora* in 1936, 9 n. 1;

Pfister 1934a (no photos): woollen trousers (apparently several pieces, details not given) “dyed with a cochineal colorant that is similar, but not identical to *Kermes*”, thus from a hitherto unknown cochineal reacting similar to the Mexican scale insect (p. 83);



a *Porphyrophora* scale insect. He suggests that it is *Porphyrophora polonica*, and proceeds to develop an argument how this species might have ended up in Iranian lands, and in fact in Syria and Egypt. This logic sounds somewhat far-fetched, and suggests a closer look at the method<sup>32</sup> by which Pfister arrives at his conclusion.

To determine the dyestuffs used, Pfister produced test samples of white wool dyed with various substances; his scale insect dyes were “Lac dye” (*Kerria lacca*), “Kermes” (*Kermes vermilio*) and “Cochineal” (*Dactylopius coccus*). He then compared the chemical reactions of these against each other, and to threads taken from historical textiles. His method was to extract the colorants with various acids etc. and then to treat the solutions with further substances. At each stage, he looked at the colour obtained.<sup>33</sup> Pfister found that the three scale insect dyes react differently in his experiments (particularly when the extraction is done by chlorhydric acid),<sup>34</sup> and there was evidence for all of them in one or the other historical textile sample. Now, the question was which dye was present in the samples where Pfister obtained reactions similar to that of the Mexican scale insect (rather than to the other scale insect dyes or to madder or other red dyes derived from plants). Not knowing at first which scale

insect could be involved here, Pfister preliminarily called it “Persian cochineal”,<sup>35</sup> until he got hold of the Polish scale insect and announced that the reactions obtained are like those of the Mexican scale insect:

“Nous avons finalement trouvé le colorant du Vieux-Monde qui donne des réactions identiques avec celles de la cochenille [mexicaine], c’est *Margarodes polonicus* [= *Porphyrophora polonica*], coccidé vivant à la naissance des racines de certaines plantes des steppes”.<sup>36</sup>

Indeed, Pfister’s observation is right insofar as the similarity of the Mexican and the *Porphyrophora* reds is concerned, but we argue that his method of merely looking at colours obtained in his experiments (rather than carrying out a chromatography) is insufficient to determine which *Porphyrophora* species is present in the textiles in question:

“des travaux plus récents sur le rouge d’insectes (...) ont montré que la similitude de composition et la variabilité des proportions des composants, tant majoritaires que mineurs, sont telles chez les *Dactylopius* et *Porphyrophora* spp.,

Pfister 1935 (no photos): two monochrome items from Antinoë (Musée Guimet, p. 39), one monochrome item from Dura-Europos (Louvre, p. 43); several pieces from Palmyra of which the weft is dyed with scale insect (p. 44, in some cases combined with purple);

Pfister 1936: E1 Pl. XXXI (= Fig. 10), E2 Pl. XXXII (Musée de Cluny), description of both p. 81f. (apparently found in Egypt, as Pfister p. 83 writes that their details suggest “non-Egyptian origin”); p. 9 n. 1 mentions the items from the Louvre published in 1932a and one additional item (unpublished?);

Pfister 1934b / 1937 / 1940 (textiles from Palmyra): 1934b: T1, T18, T19, S15 (doubtful), L1, L7, L21; 1937: L 60, L 61 (with black-and-white photo), L31, L52, L53, L62; another part of L62 is 1940, 26 recognised as cochineal with lac-dye, which is also the red dye of four items in 1940 (L 121 with black-and-white photo; L 124 with colour photo; L 123); 1937, 12 also mentions a woolen medallion in a Gothenburg museum and 1940, 69 three items dyed with “Polish cochineal” from Xinjiang (cf. n. 42) in the Victoria and Albert Museum London (Ch. 00230, Stein 1921/II, 982 with photos in vol. IV; Ch 0028, Ch 00248);

Pfister / Bellinger 1945 (textiles from Dura-Europos): nos. 7, 33-2 (no photos), 132 (black and white photo), 133 (Fig. 13).

It is not quite clear whether any of the pieces published in Pfister 1928 (textiles from Antinoë, with black-and-white photos) contain the scale insect dye in question (and if any are identical to some he republished later). Pfister 1934a, 83, adds that those textiles from Egypt that show the *Porphyrophora* dye all seem of Persian origin.

32. Description see Pfister 1935, 25-31, 33-35, 46f.

33. For details, cf. Pfister 1935, 24f, who writes that some tricky cases were checked with black light (a certain type of UV light, wave length 375 nm) which produces fluorescence in some substances, but does not specify which ones.

34. Pfister 1935, 33f. Previously Pfister 1928, 229, had thought (following other authors) that the Mediterranean insect would react similarly to the Mexican scale insect and thus assumed that *Kermes* is present in the specimens that he then found to contain two different cochineal dyes (cf. Pfister 1935, 46).

35. Thus in Pfister 1934b.

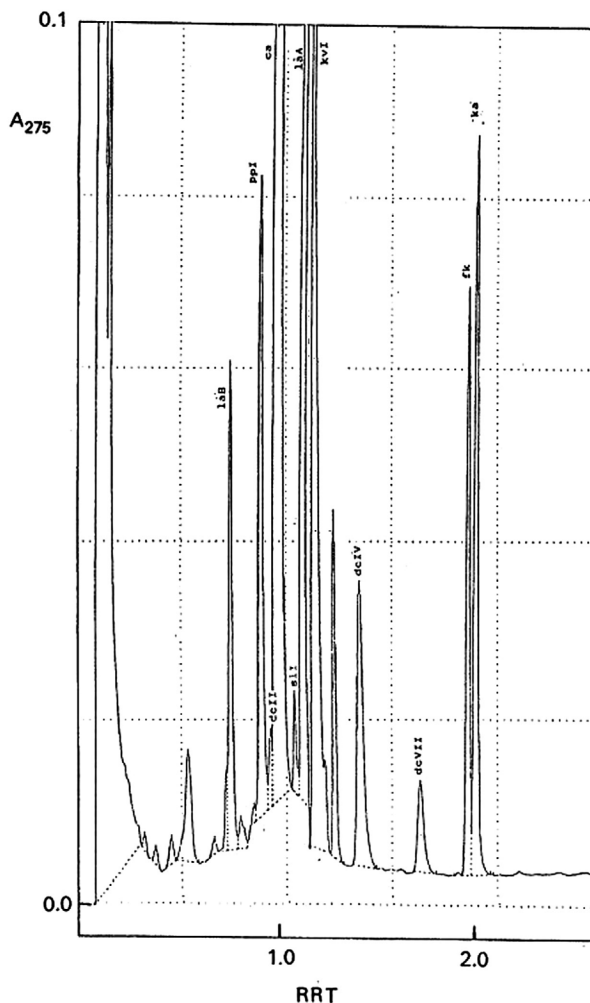
36. Pfister 1935, 35.

que la distinction entre espèces et leur identification dans un textile ancien sont particulièrement complexes et qu'elles nécessitent le recours à de nouvelles méthodes d'extraction et d'analyses.<sup>37</sup>

Also, Pfister obviously did not think of the Armenian scale insect, nor did he have some at hand to compare his results to.

Modern methods qualified as necessary by Cardon to determine the exact scale insect species include chromatography by HPLC (high performance [formerly: high pressure] liquid chromatography). The liquid to be analysed is pressed through a tube (with a solvent such as acetonitrile or a mixture of methanol/water) that contains an adsorbent material (such as synthetic resin or calcium carbonate), with which the components of the solution will interact in different ways, producing differing speeds for the components on their way through the tube. The components thus pass a certain fixed point of the tube at different moments, where one sends light of an appropriate wave length through the tube (often UV light) to measure the percentage of light that is absorbed by the solution; one can also determine the start, maximum and end of their passage at the fixed point. Solvent, adsorbent material and wave length of light need to be chosen depending on the substances one wishes to analyse. The chromatogram then shows the light absorption rate in relation to the time within which the solution passes the tube (cf. Fig. 11). The characteristic time points of the various components can be identified with the behaviour of the pure substances which one submits to the same analysis. The chromatogram also allows calculating the quantity of the various components in the solution (by integrating the area below the curve).

Studies employing the method just outlined include the one by Wouters & Verhecken 1989. In order to submit dyed textiles to chromatography, one extracts and dissolves the colorant and separates it from the mordant, for instance by a liquid containing an acid, to yield a solution which is then analysed. Wouters & Verhecken first produced test samples of dyed wool with various scale insects to determine



**Figure 1** A combined display of high performance liquid chromatograms of scale insect dyes. The identification of each product in an unknown sample results from its retention time relative to that of carminic acid (RRT) and from UV-VIS spectral analysis [14]. The analytical wavelength was 275nm.

**Fig. 11:** Graph by Wouters & Verhecken (1989, 190) showing an analysis by chromatography of a combination of scale insect dyes; the acids are measured in relation to carminic acid (whose “relative retention time” is set as the reference point 1.0)

their dyeing substances. These turn out to be acids such as carminic acid, kermesic acid, etc. It emerges that the various species of scale insects contain substances which are closely related chemically, but in very different quantities.<sup>38</sup> Wouters & Verhecken then

37. Cardon 2014, 626.

38. As the test samples also showed, these quantities also depend on the mordant employed (as well as on the details of the extraction of the colorant from the insect and the dyeing process).

proceeded to compare the results to test those of historical textiles.<sup>39</sup>

Fig. 12 presents the concluding table by Wouters & Verhecken 1989 summarising their analysis (adapted for the present purposes, and with the results for the Armenian scale insect *Porphyrophora hamelii* highlighted). It shows the relative quantities of selected dyeing acids in test samples and in historical textiles from various regions and centuries. Clearly the main difference is that between *Dactylopius* and *Porphyrophora* on the one hand and *Kermes* and *Kerria lacca* on the other. But within the first group, the chemical composition of *Dactylopius* is by far closer to *Porphyrophora hamelii* than to *Porphyrophora polonica*.

As mentioned above, Pfister found the results for his supposed *Porphyrophora polonica* “identical” to those of *Dactylopius coccus*. Since the composition of the dyeing substances of *Porphyrophora hamelii* is much closer to *Dactylopius coccus* than

that of *Porphyrophora polonica* (cf. the numbers in bold in Fig. 12), this suggests two possibilities: Either Pfister’s method would yield the same results for *Porphyrophora hamelii* and *Porphyrophora polonica*, which would mean that the method is not fine-grained enough to permit a decision between the two species, or else Pfister’s observation is mistaken (the results are actually not “identical”), and *Porphyrophora hamelii* would have behaved even more similarly to *Dactylopius* had Pfister had the opportunity to carry out experiments with this species. We thus argue that Pfister’s approach is not sufficient to permit a decision in favour of *Porphyrophora polonica*. It seems at least as likely (and historically much more so) that the textiles in question are dyed with the Armenian red.

Historical textiles which were submitted to modern chemical analysis that has shown their red dye to be the Armenian scale insect *Porphyrophora hamelii* include the Sasanian caftan mentioned above (Fig. 5). As this caftan was found in Antinoë in Egypt, it

<b>dyeing acids →</b>	laccaic acid B	“dc II” <sup>40</sup>	carminic acid	laccaic acid A	flavokermesic acid (+) kermesic acid
<b>↓ scale insects</b>					
<i>Dactylopius coccus</i> (Fig. 6)	0	<b>1.4-3.8</b>	<b>94-98</b>	0	<b>0.4-2.2</b>
<i>Porphyrophora hamelii</i> (Fig. 2)	0	<b>0.1-1.2</b>	<b>95-99</b>	0	<b>1.0-4.2</b>
<i>Porphyrophora polonica</i> (Fig. 9)	0	+	<b>62-88</b>	0	<b>12-38</b>
<i>Kermes vermilio</i> (Fig. 8)	0	0	0	0	0-25; 75-100
<i>Kerria lacca</i> (Fig. 7)	0-20	0	0	71-96	3.6-9.0

**Fig. 12:** Composition of dyeing acids in various scale insects (adapted from Wouters & Verhecken 1989, 198.<sup>41</sup>)

39. The procedure of producing test samples of wool dyed with various substances and comparing their behaviour to threads taken from historical textiles, and to extract the dye by an acid and analyse the solution is not unlike Pfister’s approach, but the methods of analysis are quite different. Analysing solutions obtained from dyed wool (rather than analysing the dyes themselves) intends to produce conditions close to those of the historical textiles. It needs to be kept in mind that the mordants have an important effect on how the dyes will attach to the fibres (thence quite differing colours depending on the mordant employed).

40. “[d[actylopius] c[occus] II” is a yellow dyeing substance which is present in several scale insect dyes (Wouters & Verhecken 1989, 191). In the meantime, it has been recognised as a glucoside of flavokermesic acid (Cardon 2014, 696). The chemical structures of flavokermesic and kermesic acid are very similar (cf. Fig. 4 in Cardon 2014, 695).

41. “All figures represent relative abundances, calculated from integration at 275 nm” (Wouters & Verhecken, *ibid.*).

seems highly likely that other textiles from the same excavation (such as Fig. 10) contain the same *Porphyrophora* species, and a similar logic would extend to *Porphyrophora* dyes of Iranian style from other parts, such as the pieces from Dura-Europos (among these Fig. 13) and Palmyra.

One might then suggest that further historical textiles from the Iranian sphere which have been shown to be dyed with a *Porphyrophora* species might likewise contain *Porphyrophora hamelii*. This applies to the cashmere fragment from Xinjiang (Fig. 3), and at this point we are reminded of the Sogdian word *karmīr* and of the fact that the Sogdians were traders along the Silk Road, and very much present in what is now Xinjiang,<sup>42</sup> and red pieces of cloth are among the commodities mentioned in Sogdian texts.

Other historical textiles submitted to HPLC yielding *Porphyrophora hamelii* as red dye include a pair of a bishop's knitted silk gloves from France (15<sup>th</sup>/16<sup>th</sup> centuries) and a hat offered by King Henry VIII to the town of Waterford, Ireland (16<sup>th</sup> century),<sup>43</sup> demonstrating how appreciated the Armenian red proved throughout centuries and cultural spheres.

If, then, the Armenian red was so widely spread that it found its way into Iranian textile remains preserved in Syria and Egypt, it seems quite probable that *karmīl* in the Ancient Testament, which since Delitzsch 1898 has been assumed to be of Iranian origin, refers to exactly this red dye.

## Conclusion

As mentioned above, *karmīl* in 2 Chronicles replaces Hebrew *tōla* 'at *šānī* used in the other books of the Old Testament. The Chronicle books retell events described in older sources, with characteristic adaptations. 2 Chronicles 2-5, within which the only three attestations of *karmīl* are found, re-describes the construction of the Temple found in 1 Kings 6-7, but adds a curtain (while no textiles are mentioned in 1 Kings). The term 'veil' as well as the actual formulation clearly is a reference to "the design and



Fig. 13: Wool fabric fragment from Dura Europos. Red dye: *Porphyrophora*. Photo: Pfister 1945: Pl. I.

construction of the tabernacle"<sup>44</sup> made by Moses in the desert (Exodus 25-27). Particularly parallel to the passage quoted in the beginning is Ex. 26:31:

וְעָשִׂיתָ פָּרֹכֶת תְּכֵלֶת וְאַרְגָּמָן וְחוּלְעֵת שָׁנִי וְשֵׁשׁ \*  
מִשְׁוֹר מְעֻשָׂה חָשֵׁב יַעֲשֶׂה אֹתָהּ כְּרֻבִים

► *wə* 'āsūtā *pāroket təkēlet wə* 'argāmān  
*wətōla* 'at *šānī* *wəšēš mošzār mā* 'āšēh  
*hošēb* ya 'āseh 'otāh *kərubīm*

“And thou shalt make a veil of blue, and purple, and scarlet, and fine twined linen of cunning work: with cherubims shall it be made.”

One might wonder whether perhaps the motivation for the substitution of *karmīl* for *tōla* 'at *šānī* in the quasi-quote in 2 Chronicles lies in a substitution of

42. In fact, Pfister 1934a, 88, 92, mentions textiles found by Sir Aurel Stein in Xinjiang which seem to be of “Syro-Iranian character” and Pfister 1940, 69, describes some of Stein's pieces from the Thousand Buddha Caves as dyed with “Polish cochineal” (cf. n. 31).

43. Photos in Cardon 2014, 627, 629.

44. Williamson 1982, 209.

scale insect dyes in this period. The commonly used *tōla* 'at *šānī* is likely to refer to *Kermes*, which was in use in Antiquity and up into modern times all around the Mediterranean.<sup>45</sup> In 2 Chronicles, reflecting Aramaic influence, and Iranian via Aramaic, it seems possible in view of the discussion above that the reference of *karmīl* is to the Armenian dye.<sup>46</sup>

If so, this would imply that the term for the colour, or rather for the dye, came with the colorant it referred to, just as so many commodities of trade have brought their names with them. This would confirm the statement quoted at the beginning that Hebrew colour terms, and in fact probably any ancient colour terms, are a feature of the object they come with, underlining once again the importance of studying etymology together with the realities that the speakers employ the words for.

## Bibliography

- Azadi, S., L. Kerimov & W. Zollinger (2001) *Azerbaidjanisch-kaukasische Teppiche: Sammlung Ulmke aus der Schweiz*. Hamburg.
- Born, W. (1936) Scharlach. *Ciba-Rundschau* 1/7, 218-240.
- Brenner, A. (1982) *Colour Terms in the Old Testament*. Sheffield.
- Cardon, D. (2007) *Natural Dyes. Sources, Traditions, Technology and Science*. London.
- Cardon, D. (2014) *Le monde des teintures naturelles*. Paris
- Clines, D. et al. (1993-2011) *The Dictionary of Classical Hebrew*. Sheffield, 8 vol.
- Dehxodā, 'Alī Akbar (1959-1971) *Loġat-nāme-ye Dehxodā*. Tehran, 50 vol.; online version at <http://www.loghatnaameh.org>.
- Delitzsch, F. (1898) Farben in der Bibel. In *Realencyclopädie für protestantische Theologie und Kirche* V. Leipzig, 755-762.
- Donkin, R.A. (1977) The Insect Dyes of Western and West-Central Asia. *Anthropos* 72:5/6, 847-880.
- Gauthiot, R. (1914) *Essai de grammaire sogdienne I: Phonétique*. Paris.
- Hartley, J. E. (2010) *The Semantics of Ancient Hebrew Colour Lexemes*. Louvain etc.
- Hasanī, M. M. (2010) *Kankāš-e adabī (Mišra 'e rangīn) I: Rang-e sorx dar adab-e fārsī*. <http://hassani.ir/post/262> = <http://hassani.ir/post-262.aspx> ≈ <http://shsb.blogfa.com/post/14> (accessed 16 Dec. 2014).
- Hübschmann, H. (1897) *Armenische Grammatik*. Leipzig (repr. Hildesheim etc. 1992).
- Jacquesson, F. (2012) Les mots de la couleur en hébreu ancien. In P. Dollfus, F. Jacquesson & M. Pastoureau (eds.), *Histoire et géographie de la couleur*. Paris, 67-130.
- Korn, A. (2013) Final troubles: Armenian stem classes and the word-end in Late Old Persian. P. Lur'e & S. Tokhtas'jev (eds.), *Commentationes Iranicae, Vladimiro f. Aaron Livschits nonagenario donum natalicium. Sbornik statej k 90-letiju Vladmira Aronoviča Livšitsa*. St Petersburg, 74-91.
- Korn, A. (2016) Arménien *karmir*, sogdien *krm'yr* et hébreu *karmīl* « rouge ». *Bulletin of the School of African and Oriental Studies* 79, 1-22.
- Korn, A. & B. Olsen (2012) On Armenian *-agin*: additional evidence for a third West Middle Iranian dialect? *Münchener Studien zur Sprachwissenschaft* 66/2, 201-220.
- Kurdian, H. (1941) *Kirmiz*. *Journal of the American Oriental Society* 61, 105-107.
- Łagowska, B. & K. Golan (2011) Scale insects /Hemiptera, Coccoidea/ as a source of natural dye and other useful substances. *Aphids and other hemipterous insects* 15, 151-167.
- Lane, E. (1863-1893) *Arabic-English Lexicon*. London etc., 8 vol.
- Mayrhofer, M. (1956) *Kurzgefaßtes etymologisches Wörterbuch des Altindischen I*. Heidelberg.
- Meillet, Antoine (1912) Sur les mots iraniens empruntés par l'arménien. In *Mémoires de la société de linguistique de Paris* 17, 242-250.
- Nāšir Xusrāu (1995) *Dīvān-e aš'ār-e Ḥakīm Nāšer Xosrou Qobādiyānī « Hojġat »*. *Qašidehā, qeṭ'ehā-ye parākande [...] be tašhīh-e Karāmat Tofangdār*. Tehran 1374 h.š.
- Nizāmī Ganġawī (1881) *The Sikandar nāma, e barā or Book of Alexander the Great (...)*. Translated for the first time out of the Persian (...) by Captain H. Wilberforce Clarke. London.
- Nizāmī Ganġawī (1956) *Šarafnāme*. Tehran: Ebn-Sīnā, 2<sup>nd</sup> ed.
- Nizāmī Ganġawī (1991) *Das Alexanderbuch = Iskandarname*. Übertr. aus dem Pers., Nachw. und Anm. von J. Christoph Bürgel. Zürich.

45. According to Cardon (2014, 595), the *Kermes* species referred to by *tōla* 'at *šānī* is *Kermes echinatus*, which is not identical, but very similar, to *Kermes vermilio*.

46. Cf. Singer (1954, 246): "The best variety [of cochineal red] is said in the Old Testament to have come from the mountains—that is, the Armenian region."

- Olsen, B. A. (2005) On Iranian Dialectal Diversity in Armenian. In O. Hackstein & G. Meiser (eds.), *Sprachkontakt und Sprachwandel. Akten der XI. Fachtagung der Indogermanischen Gesellschaft, 17.-23. September 2000, Halle an der Saale*. Wiesbaden, 473-481.
- Osbaldeston, T. A. & R.P.A. Wood (2000) *De materia medica: being an herbal with many other medicinal materials (...). A new indexed version in modern English*. Johannesburg.
- Pfister, R. (1928) La décoration des étoffes d'Antinoë. *Revue des arts asiatiques* 5, 215-243.
- Pfister, R. (1932a) *Tissus coptes du Musée du Louvre*. Paris.
- Pfister, R. (1932b) Nil, Nilomètres et l'orientalisation du paysage hellénistique. *Revue des arts asiatiques* 7, 121-140.
- Pfister, R. (1934a) Études textiles. *Revue des arts asiatiques* 8, 77-92.
- Pfister, R. (1934b) *Textiles de Palmyre, découverts par le Service des Antiquités du Haut-Commissariat de la République Française dans la Nécropole de Palmyre*. Paris.
- Pfister, R. (1935) Teinture et alchimie dans l'orient hellénistique. *Seminarium Kondakovianum: Recueil d'études. Archéologie, histoire de l'art, études byzantines* 7, 1-59.
- Pfister, R. (1936) Matériaux pour servir au classement des Textiles Égyptiens postérieurs à la Conquête Arabe. *Revue des arts asiatiques* 10/1, 1-16, 73-85.
- Pfister, R. (1937) *Nouveaux textiles de Palmyre, découverts par le Service des Antiquités du Haut-Commissariat de la République Française dans la Nécropole de Palmyre*. Paris.
- Pfister, R. (1940) *Textiles de Palmyre, découverts par le Service des Antiquités du Haut-Commissariat de la République Française dans la Nécropole de Palmyre III*. Paris.
- Pfister, R. & L. Bellinger (1945) *The Excavations at Dura-Europos. Final Report IV. 2: The Textiles*. New Haven etc.
- Sáenz-Badillos, A. (1993) *A History of the Hebrew Language*. Cambridge etc.
- Saint-Martin, J. (1819) *Mémoires historiques et géographiques sur l'Arménie II*. Paris.
- Singer, C. J. et al. (1954) *A History of Technology I: From early times to fall of ancient empires*. Oxford.
- Stein, A. (1921) *Serindia: Detailed report of explorations in Central Asia and westernmost China*. London & Oxford, 5 vols.
- Steingass, F. (1892) *A Comprehensive Persian-English Dictionary*. London.
- Šukurov, M.Š. et al. (1969) *Slovar' tadžikskogo jazyka. Farhang-i zabon-i tojikī*. Moscow, 2 vol.
- Wagner, M. (1967) *Die lexikalischen und grammatikalischen Aramaismen im alttestamentlichen Hebräisch*. Berlin.
- Wellmann, M. (1906-1907) *Pedanii Dioskuridis anazarbei de materia medica libri quinque*. Berlin.
- Williamson, H. (1982) *1 and 2 Chronicles [The New Century Bible Commentary]*. London.
- Wouters, J. & A. Verhecken (1989) The Coccid Insect Dyes: HPLC and Computerized Diode-Array Analysis of Dyed Yarns. *Studies in Conservation* 34/4, 189-200.

## Armenian Textile Terminology

Birgit Anette Olsen

The part of the Armenian vocabulary that is inherited from the Indo-European protolanguage is notoriously limited, variously estimated to include between 450 and 700 stems. Otherwise, the lexicon is dominated by etymologically obscure elements and an impressive amount of Middle Iranian loanwords, reflecting the centuries of Iranian political dominance. In particular the Parthian loans, introduced during the Arsacid dynasty (247 BC-224 AD), have left their mark on the Classical Armenian language, attested from the early 5<sup>th</sup> century, to a similar extent as Old French on English or Low German on Danish, so that linguists until the late 19<sup>th</sup> century still considered Armenian an aberrant Iranian dialect rather than an independent branch of the Indo-European family. The other main sources of loanwords, Syriac and Greek, are intimately connected with the introduction of Christianity around 300 and hence mainly restricted to the specific word fields of religion and philosophy.<sup>1</sup>

Obviously, this state of affairs also affects the textile vocabulary where the impact of Iranian language and culture can hardly be overestimated.<sup>2</sup> Thus, it is

quite natural that the Iranian superstrate dominates the lexicon pertaining to advanced textile production, clothing, fashion and ornaments, while on the other hand the core of inherited terms refers to basic products and techniques such as fleece and wool, spinning and weaving. The basis of the present lexical study is the classical language, mainly as attested in the oldest text, the Bible translation from around 410.<sup>3</sup>

### The terminology of wool

Any discussion of Indo-European culture in general and the dating and geographical position of the Indo-European homeland in particular must include a reflection on the word for ‘wool’, since the occurrence of wool sheep and the technology of wool production is a significant cultural feature of all the ancient Indo-European civilizations. There can be no doubt that the protolanguage had a feminine noun with the precise meaning wool in the daughter languages and a protoform *\*h<sub>2</sub>ul̥h<sub>1</sub>-nah<sub>2</sub>* which is continued in most branches of the family: Vedic *úrṇā-*, Avestan *varəṇā-*, Latin *lāna*, Welsh *gwlan*, Gothic *wulla*, Lithuanian

1. According to Solta (1990, 13), 5572 of the words included in Ačāryan’s etymological dictionary (1928-35) are registered as being of unknown origin, 4014 are loanwords, mainly Iranian, and only 713 are considered inherited.

2. Cf. e.g. Hübschmann 1897, 91-259; Bolognesi 1960; Schmitt 1983; Olsen 1999, 857-920.

3. The treatment by Olsen 1999 includes details concerning the inventory and historical analysis of nouns and adjectives.

*vilna*, Old Church Slavic *vlъna*. Other cognates are the Greek neuter *s*-stem *λῆνος* for expected feminine *\*lēnē* where the aberrant gender and inflectional type may have been triggered by the two other words for ‘wool’, *εἶρος* and *πόκος*, and Hittite *hulana-*, also ‘wool’, whose exact protoform, *\*h<sub>2</sub>ul<sub>1</sub>-nah<sub>2</sub>* or *\*h<sub>2</sub>ulh<sub>1</sub>-ṇnah<sub>2</sub>* may be debated. Irrespective of the details, the very existence of this stem in Hittite at least takes us back to the period before Anatolian, as the first branch, separated from the rest of the Indo-European family. However, one thing is the existence of a common word; another is its precise original meaning and derivational background.

As summed up by Anthony (2007, 59):

“Sheep with long woolly coats are genetic mutants bred for just that trait. If Proto-Indo-European contained words referring unequivocally to woven wool textiles, then those words have to have entered Proto-Indo-European after the date when wool sheep were developed. But if we are to use the wool vocabulary as a dating tool, we need to know both the exact meaning of the reconstructed roots and the date when wool sheep first appeared. As the dating of this mutation is perhaps around 4000-3500 BC., one would then assume that the separation of the Indo-European family took place as late as the 4<sup>th</sup> millennium”.

This is a fair assumption, but taking on the role of the Devil’s Advocate, one could object that even if every single Indo-European language had a concordant word for ‘wool’, the meaning in the proto-language need not necessarily be ‘wool’ in our sense. Instead, it might e.g. have denoted the rough annual shedding of early domesticated sheep which could not be spun, but only used for the production of felt. In that case the semantic development to ‘wool’ would have taken place at a later stage, independently in the separate branches.

A scenario of this sort is not very likely, but we need exact linguistic evidence to definitely refute the faint possibility. If it can be proved that the meaning of the basic root of the word for ‘wool’, i.e. *\*h<sub>2</sub>uelh<sub>1</sub>-*, was ‘pluck, tear out’, the semantics of *\*h<sub>2</sub>ulh<sub>1</sub>-nah<sub>2</sub>* > Latin *lāna* etc. ‘what is plucked (off)’ only makes sense in connection with the fleece of wool sheep. Incidentally this does seem to be the case, as substantiated by Latin *vellō* ‘to pluck (hairs, feathers etc.)’ and *vellus* ‘fleece’.<sup>4</sup> Thus, we can be fairly confident that our Indo-European ancestors, perhaps five or six thousand years ago, did in fact possess domesticated wool sheep, initially plucking rather than shearing their wool to use it for spinning and weaving.

The exact match of *lāna* etc. happens to be unattested in Armenian. What we do have, however, is a precious isolated archaism in the form of the primary *men*-stem *gelmn* ‘fleece’ (Olsen 1999, 504; Martirosyan 2010, 204) from which *\*h<sub>2</sub>ulh<sub>1</sub>-nāh<sub>2</sub>* constitutes a secondary derivative: where *\*h<sub>2</sub>uel<sub>1</sub>-mṇ* > *gelmn* is the fleece, *\*h<sub>2</sub>ulh<sub>1</sub>-mnāh<sub>2</sub>* > *\*h<sub>2</sub>ulh<sub>1</sub>-nāh<sub>2</sub>* (> *lāna* etc.) is a substantivized feminine/collective ‘that which pertains to the fleece’, i.e. ‘wool’.

In the meaning of ‘wool’ we find another inherited term, *asr*, cf. e.g. Psalms 147.16: *dnē z-jiw n orpēs z-asr* ‘he giveth snow like wool’, or Rev.1.14: *ew glux nora ew herk<sup>c</sup> ibrew z-asr spitak ew orpēs z-jiw n* ‘and his head and hair was white like wool and like snow’. Traditionally, *asr* is considered a contamination between *\*pokos* as in Greek *πόκος* ‘fleece’, Old Norse *fær* ‘sheep’ on the one hand, and the neuter *u*-stem *\*péku* > Vedic *pásu*, Avestan *pasu*, Latin *pecū*, Gothic *faihu* ‘livestock, cattle’ and Modern English *fee* on the other.<sup>5</sup> While the meaning ‘fleece’ matches that of *πόκος* (but not that of *fær*!), the *u*-stem inflection<sup>6</sup> is more in accordance with Vedic *pásu* etc.<sup>7</sup>

The root of at least *πόκος* and its cognates has been identified with that of Greek *πέκω* ‘(pluck >) comb, card’,<sup>8</sup> Lith. *pešù* ‘pluck’, so that *πόκος*, rarely also neut. *s*-stem *πέκος* with regular *e*-grade, would be ‘plucking’ or ‘that which is plucked’, i.e. ‘sheep’s

4. For further discussion of the linguistic details, in particular the reconstruction of the basic root, cf. Olsen forthcoming.

5. Cf. also the sumerogram UDU-*uš* ‘sheep’ in Hittite, where the phonetic complement indicates a *u*-stem.

6. Only attested in the later language, but secured by the adjectives *asui* and *asueay* ‘woollen’.

7. Cf. Olsen 1999, 202 and Martirosyan 2010, 122-124 with references for a discussion of the phonological details (especially the origin of the initial *a*-).



wool, fleece', and we would have exactly the same semantic development as in *\*h<sub>2</sub>u<sub>1</sub>h<sub>1</sub>-nah<sub>2</sub>* 'wool' from *\*h<sub>2</sub>uelh<sub>1</sub>* 'pluck'. An etymological identity between the roots of *πέκω*, *pešù* 'pluck' and *\*péku* 'livestock', on the other hand, is not quite certain. While it is traditionally assumed that *\*péku* would have had a hypothetical basic meaning '(wool) sheep' or 'small cattle' with a secondary extension to 'livestock' in general, this development cannot be philologically verified, so that the connection is sometimes questioned, cf. e.g. Mallory & Adams (1997, 23). Still, the formal similarity and the apparent mutual semantic influence between *\*péku* and (*\*péke/o-* ⇒) *\*pékos/pokos* would seem to suggest an old connection, thus in particular the *u*-inflection of *asr* 'wool' and the perfect formal identity between the Greek *s*-stem *πέκος* 'fleece' and Latin *pecus*, *-oris* 'cattle, small cattle'.

Another derivative of the root *\*pek-* possibly survives in the otherwise etymologically unclear *ostayn* (*i*-st.) 'web, textile' with the compound *sardiostayn* 'cobweb' (cf. *sard* 'spider'). At least a protoform *\*pok-ti-*, already posited for Old Swedish *fæt*, Old English *feh* 'fleece', Old Frisian *feh* 'wool, fleece', would probably yield Armenian *ost-* by regular sound change.<sup>9</sup> As for the end segment *-ayn*, one may tentatively suggest a compound *\*pokti-titi-* or the like,<sup>10</sup> derived from the root *\*ten-* 'stretch; spin', cf. e.g. Vedic *tanti-* 'cord, line, string', *tántu-* 'thread, cord, string, line, wire, warp (of a web)', *tántra-* 'warp', Persian *tan-* 'spin, twist', so that the

original meaning would have been something like 'wool-web'.

Another potentially inherited term is the *o*-stem *burd* 'wool' with the denominative verb *brdem* 'shear, cut (wool)', which does not have a generally accepted etymology. However, in his monumental, but not so easily accessible dictionary, Ačaryan,<sup>11</sup> with reference to Patrubány,<sup>12</sup> mentions a possible connection with Sanskrit *bardhaka-* 'cutting' and Latin *forfex* 'tongs, pincers; shears, scissors'. Semantically the suggestion is quite attractive. Like Latin *lāna* etc. on the one hand, Armenian *asr* and Greek *πόκος* on the other, we must assume that the verbal root *\*b<sup>h</sup>erd<sup>h</sup>-* 'gather, harvest' → 'pluck (wool)' derives from a time when wool was plucked rather than shorn, and that the derivatives only later, in the individual branches and following the technological development, were lexicalized with the specific meaning of 'shearing'.<sup>13</sup> The root vocalism of *burd* which would at first sight appear to point to a lengthened *o*-grade *\*b<sup>h</sup>ōrd<sup>h</sup>o-*, is somewhat surprising; on the other hand, we have two apparent parallels in *durn* 'potter's wheel'<sup>14</sup> and *burn* 'tower'.<sup>15</sup> The word *burd* is quite rare in classical literature beside the more usual *asr*.<sup>16</sup> Another word for 'fleece (of wool)' is the Semitic loan *gzat*, Syriac *gezzathā*, which is only attested four times in the same passage of the Book of Judges, 6.37-40, as a translation of Greek *πόκος*.

While Armenian may thus have preserved as many as three inherited words for 'fleece' and

8. Also, with secondary semantic transfer, 'shear', e.g. Theocr.28.13: *πόκοις πέζασθαι* 'have their wool shorn'.

9. Cf. *dustr* 'daughter' < *\*d<sup>h</sup>ug<sub>2</sub>tér* with loss of the laryngeal *\*ə<sub>2</sub>*, regular palatalization *\*g* > *\*ġ* after *u* and voicing assimilation *\*ġt* > *\*kt* > *st*. The numeral *ur* 'eight' most likely goes back to *\*optō* as a substitution for *\*oktō* after *\*septm* (> *ew<sup>n</sup>*) 'seven' (cf. Martirosyan 2010, 631).

10. Regular loss of *\*-i-* in unaccented syllable, *\*-nt-* > *-an-* and *i*-epenthesis *\*-ani-* > *-ayn*.

11. Ačaryan, 1971: 488-489.

12. Patrubány, 1902: 59.

13. Cf. Flemestad & Olsen, this volume, for further details and references.

14. Root *\*d<sup>h</sup>erġ<sup>h</sup>-* 'turn'.

15. Root *\*b<sup>h</sup>erġ<sup>h</sup>-* '(be) high'. A lengthened *o*-grade is rather a morphological monstrosity except in *vṛddhi* formations, and apart from this peculiarity, the root-final *-g-* of both *burn* and *durn* is at variance with the regular development of the palatal *\*-ġ<sup>h</sup>-* > *-j-* in the clearly inherited *barjr* 'high' < *\*b<sup>h</sup>ġ<sup>h</sup>u-* and aor. *darjay* 'turned' < *\*d<sup>h</sup>ġ<sup>h</sup>-* from the very same roots. On this background it seems possible, as suggested in Olsen 1999, 951, that we are dealing with loans from another Indo-European language with different sound laws where *-ur-* might represent either a zero grade *\*-ġ-* or an *o*-grade *\*-or-*. Now *burd* might be added to the evidence, and at least it is noteworthy that from a semantic point of view *burn*, *durn* and *burd* are all likely candidates for cultural loans/*Wanderwörter*.

16. Cf., however, Hebr. 9.19: *brdov karmrov*, Greek *ἐρίου κόκκινου*, 'scarlet wool' and the adjective *brdeay* 'woollen' (Łazar P<sup>o</sup>arpec<sup>i</sup>, 5th century).

‘wool’, *gelmn*, *asr* and perhaps *burd*, the origin of the common term for ‘flax, linen’, *ktaw* (o-st.), is unknown, and its rare synonym *xcuc* in Judg. 15.14 seems to have a Caucasian source.<sup>17</sup> The *Wanderwort* *behez/behēz* ‘fine linen’,<sup>18</sup> as also Greek βύσσος which is transmitted through Semitic, ultimately goes back to Egyptian,<sup>19</sup> but the immediate source is unknown;<sup>20</sup> another pedigree of the same stem is *vuš* ‘fibre of flax’.<sup>21</sup> *Xorg* (o-st.) ‘sackcloth’ is either transmitted through Syriac *xurgā* or borrowed directly from Middle Iranian *\*xwarg-*. Finally, *stew* ‘camel’s hair’ is traditionally compared with Vedic *stūkā-* ‘knot or tuft of hair or wool’ and *stupā-* ‘knot, tuft of hair’ though the exact protoform is open for discussion.<sup>22</sup>

### Terminology of spinning and weaving

Most of the verbs pertaining to basic textile technology of spinning and weaving are more or less direct continuations of inherited stems though the lexicalized meaning has sometimes undergone changes in the course of time. While the common Indo-European root for ‘weave’, *\*uebh-*, known from e.g. Greek *ὑφαίνω* and German *weben*,<sup>23</sup> has left no apparent traces, the usual Armenian verb is *ankanem*. Synchronically this looks like the active counterpart of *ankanim*, aor. *ankaw*, ‘fall down, come down, hang down’ from the root *\*seng<sup>w</sup>-* as in Gothic *sigquan* ‘sink, go down’, English *sink*, and the causative *sagqjan* ‘lower, let down’ which would also be the expected meaning of *ankanem*. If we are indeed dealing

with the same root from a historical point of view, the peculiar semantic development may perhaps be seen in connection with weaving on vertical looms where the warp is held down by the loom-weights, cf. also *ankuac* ‘weaving, texture’ with the literal meaning ‘what has been made fall, go down’.<sup>24</sup> A compound with the same stem is found in the designation of the ‘weaver’, *ostaynank*, lit. ‘who makes the web come down’, i.e. ‘web-weaver’, cf. e.g. 1.Chron.11.23: *ni-zak ibrew z-stori ostaynankac* “a spear like a weaver’s beam”, whence also the derivative *ostaynankut<sup>i</sup>wn* ‘weaver’s work’.

A root from the terminology of spinning is Indo-European *\*(s)penh<sub>1</sub>-*,<sup>25</sup> with or without the “mobile s-” in Gothic *spinnan* ‘spin’, Lithuanian *pinù* ‘plait’, Old Church Slavic *pъnъ* ‘stretch’ and, with secondary metaphorical meaning, Greek *πένομαι* and *πονέομαι* ‘exert oneself, make an effort’. An Armenian continuation of this verb is allegedly found in *henum* ‘weave, sew together’ with the variant *hanum* where the vocalism is assumed to be analogically extended from the original aorist stem.<sup>26</sup> However, it is remarkable that *henum* and *hanum* hardly occur in classical literature, losing ground to *niwt<sup>e</sup>em* in the basic meaning of ‘spinning’ from the earliest records, but still sporadically attested in later sources.<sup>27</sup>

The commonly used verb for ‘spin’ is the denominative *niwt<sup>e</sup>em*, derived from the generic term *niwt<sup>e</sup>* ‘stuff, material’ which is mainly used about textiles, e.g. Ex.39.27: *i niwt<sup>e</sup>oy behezoj* “of linen material”. Beside its literal meaning ‘spin’, e.g. Matth.6.28 = Luke 12.27: *oč<sup>c</sup> janay ew oč<sup>c</sup> niwt<sup>e</sup>ē* “they toil not,

17. Ačařyan II, 375.

18. O-st.; -h- apparently hiatus breaker.

19. Cf. Spiegelberg 1907, 128-29.

20. Ačařyan I, 437-438.

21. Ačařyan IV, 348.

22. IEW 1055; Mallory & Adams 1997, 139; Jahukyan 1987, 195; Olsen 1999, 425.

23. LIV 658.

24. The imaginary may also work with cobwebs where the spider falls down with the first thread of the web, cf. e.g. Is. 59.5: *z-ostayn sardic<sup>c</sup> ankanen*, Greek *ιστὸν ἀράχνης ὑφαίνουσιν*, “they weave the spider’s web”.

25. LIV 578-579.

26. Klingenschmitt 1982, 235.

27. In their reverse dictionary of Classical Armenian, covering all of the most important early sources, Jungmann and Weitenberg (1993) do not register a single occurrence of *henum* or *hanum*, and just one attestation of the variant *hinum* from the comparatively late writer Movsēs Xorenac<sup>i</sup> (9th century).

neither do they spin”, the verb *niwt<sup>c</sup>em* is frequently used metaphorically in the sense of ‘spinning a yarn, telling a tall story, scheming’, cf. e.g. Ps.49.19: *Be-ran k<sup>c</sup>o yačaxer z-č<sup>c</sup>arut<sup>c</sup>iwn, ew lezu k<sup>c</sup>o niwt<sup>c</sup>er nengut<sup>c</sup>iwn* “Thou givest thy mouth to evil, and thy tongue frameth deceit”, or Prov.3.29: *Mi niwt<sup>c</sup>er barekami k<sup>c</sup>um č<sup>c</sup>aris* “Devise not evil against thy neighbour”. If the basic root is *\*sneh<sub>1</sub>(i)-* ‘spin’,<sup>28</sup> as continued in e.g. Latin *neō*, Greek *νή* ‘spins’, Old Irish *níid* ‘twists, binds’ and Old High German *nāen* ‘sow’, the underlying noun may be analysed as either a *tu*-stem *\*sneh<sub>1</sub>-tu-*<sup>29</sup> as opposed to the *\*-ti*-stem of Greek *νήσις* ‘spinning’, Old High German *nāt* ‘seam’ or a “proterodynamic” *\*-ti*-stem *\*sneh<sub>1</sub>-tōi-*, in both cases with *u*-epenthesis and analogical *o*-stem inflection.

Another verb which is usually treated in the same context is *t<sup>c</sup>ek<sup>c</sup>em*, traditionally translated ‘twist’ or the like in historical-comparative literature<sup>30</sup> and interpreted as a primary thematic verb from *\*tek-* ‘twist, weave’,<sup>31</sup> otherwise attested in with an apparent *s*-extension, e.g. Latin *texō* ‘weave, plait’. However, as registered in the normative dictionaries and affirmed by the textual evidence,<sup>32</sup> the original meaning of the Armenian verb is not ‘twist’, but rather ‘forge’, in particular ‘whet’, metaphorically also ‘educate’, and even the later meaning ‘incline, tilt, bow, bend’ is quite general and not specifically used in contexts where textiles are involved. This is primarily a

technical term used about the smith rather than the textile worker.<sup>33</sup>

We now have to consider the meaning of the root(s) *\*tek-* and/or *\*teġ-* and its/their potential relation to textile terminology, including the extended or reduplicated forms “*\*teks-/teġs-*” and “*\*te-tġ-*” > “*teġp-*”. Pokorny<sup>34</sup> registers the homonymous roots *\*tek-* “zeugen, gebären” and *\*tek-* “weben, flechten”, while LIV<sup>35</sup> reconstructs the former with a root-final velar *\*tek-*, the latter with a palatal *\*teġ-*. Now, if the Armenian verb *t<sup>c</sup>ek<sup>c</sup>em* is excluded for semantic reasons, there is no specific reason to reconstruct a velar rather than a palatal.<sup>36</sup> Thus it is sufficient to posit a single root *\*teġ-* ‘make, produce’, perhaps continued in its simple form in Greek *τέκνον* ‘child’ with the reduplicated present *τίκτω* ‘beget, produce’.<sup>37</sup> An apparent *s*-extension is found in Hittite *takkešzi*, 3.pl. *takšanzi* ‘fit together, unite’,<sup>38</sup> Latin *texō* ‘weave, plait; join, fix together, build’ and Middle High German *dehsen* ‘break flax’, and finally an old reduplicated stem *\*te-tġ-* > *\*teġp-* is traditionally seen in Vedic *tāṣṭi* ‘builds, fashions, makes’, Avestan *tāšt* ‘made’, Old Church Slavic *tesati*, Lithuanian *tašyti* ‘hew’. This stem also appears to be the base of the noun continued in Vedic *tákṣan-*, Greek *τέκτων* ‘carpenter’ (Mycenaean *te-to-ko-n-*) and Avestan *tašan-* ‘creator’, famously featuring in the poetic language of Indo-Iranian and Greek where ‘carpenter of words’ is used as a kenning for the poet.<sup>39</sup> However, the precise

28. LIV 571-572.

29. Klingenschmitt 1982, 180.

30. Solta 1960, 378: “drehen, flechten, erzeugen”; IEW 1068: “drehe, flechte, wickle”, repeated in LIV 619.

31. LIV 1.c.

32. E.g. 1.Sam.13.20; Is.44.12.

33. Ačařyan II, 178: *křanelov kokel, řinel, srel* “by hammering to smoothe, fashion, whet”; Nor bařgirk<sup>c</sup> I, 810: “*Χαλκεύω*, Fabrico, tundo, cudo. *θήγω*, acuo, ew [and] *παιδεύω*, erudio”. Ciackiak (I, 578) agrees on the primary meanings ‘aguzzarie, affilare, arrotare, appuntare’, ‘esercitare, istruire, informare’, including the metaphorical use of *t<sup>c</sup>ek<sup>c</sup>el lezu* ‘Rinforzar le parole; rin vigorire il discorso’, and finally adding ‘piegare, torcere, flettere’ [fold, twist, bend] which is the meaning that survives into the modern language. The suggestion of an etymological connection between *t<sup>c</sup>ek<sup>c</sup>em* and Lat. *texō* etc. seems to go back to Meillet (1894, 289) who, in accordance with the earliest documentation, translates “‘fabriquer’ et en particulier ‘aiguiseur’”.

34. IEW 1057-1058.

35. LIV 618-619.

36. The Ossetic verb *taxun*, mentioned in IEW with the translation ‘weben’, rather means ‘equip, dress up’ and thus does not belong here (Cheung 2007, 374).

37. Cf. Beekes 2010, 1484.

38. For the exact meaning of the Hittite verb, cf. Melchert, forthcoming.

39. Cf. Schmitt 1967, 297.

formal distinction between *\*teks-* and *\*tetk-* is somewhat unclear, and it is even possible that Greek *τέκτων* is rebuilt from *\*teksōn* on the model of the agent noun *\*teks-tor-* = Latin *textor* ‘weaver’.<sup>40</sup> At any rate there seems to be a lexical connection between simply ‘fitting together’, as in the Hittite verb, and the two more specialized craftsman’s terms ‘building’ or ‘doing carpentry’ on the one hand, ‘weaving’ on the other. Presumably, the connecting link is the use of wattling in the construction of houses.<sup>41</sup>

This brings us to the curious formal identity of the roots of Armenian *hiws* ‘plait (of hair)’, *hiwsel* ‘to plait’ and *hiwsn* (pl. *hiwsunk* < *\*-ones*) ‘carpenter’ where it is tempting, but formally problematic to venture an equation with *tákšan-* and *τέκτων*. The equation was already assumed by Ačaryan,<sup>42</sup> and later elaborated by Winter<sup>43</sup> who, apart from dealing with the doubtful internal cluster, had to postulate a dialectal development *\*t- > h-* rather than the regular *t̥-*. Klingenschmitt’s alternative derivation from a reduplicated *\*pi-pk̂-* from the root *\*pek̂-* ‘pluck; comb’<sup>44</sup> is phonologically impeccable, but morphologically ad hoc. Moreover, the semantic development is far from obvious, as is also the case of the alternative derivation from *\*peuk̂-*. Perhaps the most promising suggestion is Martirosyan’s tentative comparison with Lithuanian *sukti* ‘turn’, Old Russian *сѣкати* ‘twist, twine’, Russian *sukat* ‘twist, spin’<sup>45</sup> which is at least semantically satisfactory for *hiws*, *hiwsel*, while the stem

formation of *hiwsn* may have been influenced by the pre-Armenian match of *tákšan-*, *τέκτων*.<sup>46</sup>

The inherited textile vocabulary includes not only the word for the ‘web’ as such, but apparently also the more specialized terms for ‘warp’ and ‘woof’. The word for the ‘warp’ is either *arēj̄*, lit. ‘that which goes down’<sup>47</sup> or *azbn*, while the ‘woof’ is *t̥ezan*, cf. e.g. Levit. 13.52: *Ew ayresc̄ē z-jorjn et̄ē arēj̄ ic̄ē et̄ē t̄ezan y-asveac̄ kam i ktaweac̄* ‘‘And he shall burn that garment, whether the warp (*στήμωνα*) or woof (*κρόκην*) in woollen or in linen’’.

In Armenian historical linguistics it is all too often the case that a proposed etymology depends on a sound law that is founded on one or two stray examples, as is also the case of *azbn*. Two nouns in Classical Armenian end in *-zbn*, *skizbn* ‘beginning’ and *azbn* ‘warp, chain in weaving’ (cf. Olsen 1999, 369-370). While an indigenous suffix *-mn/-man* is well attested, we have no comparative evidence whatsoever for a similar suffix with *\*-b<sup>h</sup>- (> -b-)* instead of *\*-m-*. Consequently, *skizbn* and *azbn* either belong to some undefined substratum in which case we can stop worrying about them from an Indo-European comparative point of view, or they are inherited after all if *-bn* for *-mn* is due to some sophisticated conditioned sound law. Already in the early 19<sup>th</sup> century, Holger Pedersen<sup>48</sup> suggested a regular development *-zmn-* to *-zbn-* to account for these words, and since both of the basic roots stand a good chance of being inherited, it does seem sensible to look for a

40. In that case *\*tetk-* might be dispensed with since Vedic *takšan-*, Avestan *tašan-* etc. are ambiguous. Cf. Mayrhofer p. 156 in Cowgill & Mayrhofer 1986, and EWAia I, 612-614, and see also the thorough discussion in Lipp 2009, II, 217-235.

41. Mallory & Adams 1997, 139.

42. Ačaryan III, 201.

43. Winter 1962, 262 and 1983.

44. Klingenschmitt 1982, 133-134 and 217.

45. Martirosyan 2010, 410-412. Root *\*seuk-*; *\*-k-* regularly palatalized after *\*-u-*.

46. A lengthened grade *\*-ēu-* which regularly yields *-iw-* would be morphologically peculiar, so the value of the comparison depends on the expected outcome of the diphthong *\*-eu-*. Usually *\*-eu-* and *\*-ou-* are assumed to merge with the end result *-oy-*, but as argued by de Lamberterie (1982, 81-82), there are no incontestable examples of *\*-eu- > -oy-*, so it is possible that *\*-eu- > -iw-* is regular. Besides *hiws* (*hiwsel*, *hiwsn*) de Lamberterie points to *hiwcanim*, aor. *hiwcay* ‘pine away’: Goth. *siuks* ‘ill’ < *\*seuǵ-/ \*seuǵ-* (cf. also IEW 915). Another potential example would be *t̄iw* (o-st.) ‘number’ < *\*teuhos* (cf. Ved. *tavás-* ‘strong’, Av. *tauuah* ‘power, strength’) where we could avoid an inconvenient case of v̄iddhi. As for the apparent exceptions *k̄oyr* ‘sister’ < *\*k̄<sup>h</sup>eur* < *\*suesōr* and the suffix *-oyr* (i-st.) = Greek. *-ευσις* < *\*-eh<sub>1</sub>uti-*, the hiatus between *-e-* and *-u-* may have remained until the development *\*-eu- > -iw-* (followed by the later merger of *\*-eu-* and *\*-ou-*) was completed.

47. Cf. Greek *στήμων* ‘that which stands up’.

48. Pedersen 1905, 217.

historical explanation for the suffixal elements as well.<sup>49</sup> Between *azbn* and Greek ἄσµα ‘warp’ (usually δίασµα) there exists a both very precise and very specific semantic correspondence, which can hardly be accidental. Thus Judg. 16.13: *Et ē ankc̄es z-ewf̄anasin gitaks glxoy imoy and azbin* translates Greek Ἐὰν ὑφάνῃς τὰς ἑπτὰ σειρὰς τῆς κεφαλῆς μου μετὰ τοῦ δίασµατος “If thou weavest the seven locks of my head with the web”. The corresponding Greek verb ἄττοµαι < \*ἄτ-jo-µαι ‘set the warp in the loom’, i.e. ‘start the web’, has been convincingly connected with Hittite *hatt-* ‘pierce, prick’ by van Beek (apud Beekes 2010, 167).<sup>50</sup> From a formal point of view the Greek form is an exact match of the Hittite *j*-present *ha-az-zi-zi*, to be read /ht̪étsi/ < \**h<sub>2</sub>t-jé-ti*,<sup>51</sup> but the semantic specialization pertaining to textile terminology must have taken place at a time after the separation of the Anatolian branch from the Indo-European family, i.e. not earlier than “Core Indo-European” and perhaps as late as the predecessor of the Greek-Armenian(-Albanian-Phrygian) subbranch.

*ʔezan* ‘woof’ has no generally accepted etymology. A connection with the root “(s)teg<sup>h</sup>- ‘stechen’”, as in Old Icelandic *stinga* ‘sting, stitch, stab’, Old Church Slavic *o-stegnŏti* ‘tie, knot, chain’, Russian *stegat* ‘quilt’<sup>52</sup> has been rejected because the Slavic forms would point to a velar \*-g<sup>h</sup>-, while Armenian -z- must represent the lenition product of an intervocalic palatal \*-ǵ<sup>h</sup>-. However, the semantic correspondence is remarkable, cf. also Shetland *sting* ‘sew, stich together’, Danish *sting* ‘a stitch’, and the formal problem would be solved by a Slavic borrowing from Germanic.

Even the word for the beam of a loom, *stori*, may be based on an inherited lexeme, \**storh<sub>1</sub>jo-*, from the same root as Middle High German *star* ‘stiff’ and in particular Old High German *storro* ‘wooden block’.<sup>53</sup>

Textile terms based on inherited roots further include *k<sup>c</sup>ul* ‘thread’, reconstructed by Jāhukyan as \**kōlo-* and compared with Latin *colus* ‘distaff’.<sup>54</sup> The reconstruction may be adjusted to \**k<sup>w</sup>ōlh<sub>1</sub>o-* from \**k<sup>w</sup>elh<sub>1</sub>-* ‘turn’ as a vřddhi derivative ‘pertaining to the spindle’ (?),<sup>55</sup> but there may be other possibilities such as a zero-grade formation \**k<sup>w</sup>lh<sub>1</sub>o-* with rounding of the sonant after labiovelars. The semantically related *astani* ‘thread, ribbon’ is internally derived from *asetn* ‘needle’, based on the root \**h<sub>2</sub>ak-* ‘(be) sharp’ and belonging to the same subset as *aletn* ‘bow’ and *rit<sup>c</sup>etn* ‘blade’. The derivational details are not quite clear, but at least we seem to be dealing with a close cognate of Old High German *ahil* ‘awn’, Middle English *eile* ‘awn, prickle’.<sup>56</sup>

### Terminology of garments

The inventory of inherited words for garments is quite scarce. The generic term *z-gest* (*u-st.*) ‘garment, clothing’ is a compositional *tu*-stem, including the prefix *z-* which, at least functionally, corresponds to Ved. *abhi-* < \**h<sub>2</sub>mb<sup>h</sup>i-*<sup>57</sup> and the *tu*-stem \**-gest* < *-u<sup>st</sup>tu-* as opposed to the Latin *ti*-stem *vestis*.<sup>58</sup> A similar formation is *z-ard* ‘ornament, finery’, also an original *tu*-stem \**-h<sub>2</sub>ar-tu-* or \**-h<sub>2</sub>r-tu-*; however, the cognates, Vedic *ṛtú-* ‘the right time; rule, order’, Hes.

49. Cf. Klingenschmitt (1982, 224) for a discussion of *skizbn* and the related verb *sksanim* ‘begin’. The origin of the crucial cluster is not exactly identical in the two cases: (\*-k̂nn? >) \*-smn > \*-zmn in *skizbn*, \*-tmn > \*-smn > \*-zmn in *azbn*.

50. Van Beek apud Beekes 2010, 167.

51. Cf. Kloekhorst 2008, 331. The verb is also continued in Lycian *xttadi/xttaiti* ‘wounds’ (LIV 274 with references).

52. LIV 687. Cf. also Olsen 1999, 300, and Martirosyan 2010, 283 with reference to Saradževa 1986.

53. Ačařyan IV, 278. Cf. also Martirosyan 2010, 300 for a thorough discussion of the enigmatic *il, ilik* ‘distaff, spindle’.

54. Jāhukyan 1987, 83.

55. Olsen 1999, 195-196.

56. The Germanic protoform is usually reconstructed as \**ahila-*/\**agila-*, but instead we might be dealing with an instrument noun \**h<sub>2</sub>ak<sup>c</sup>etlo-* of the type Old Norse *lykill* ‘key’ < \**luk-ila-z* < \**-etto-* ‘instrument for closing’ according to Rasmussen’s analysis (1999, 651-651). The exact phonetic basis of the Armenian derivative is somewhat uncertain.

57. Cf. also the verb *z-genum* ‘dress’: Vedic *abhi-vas-* ‘dress’. The stem formation of the corresponding Greek verb ἔννυμι < \**ues-nu-* is identical with the Armenian (LIV 693 and Klingenschmitt 1982, 248). On the etymological relationship between *z-* and *abhi-* etc., cf. Manaster Ramer ms. apud Olsen 2002.

58. The *u*-stem inflection may well be an archaism since *tu-* rather than *ti-* stems in Vedic are habitually found after prefixes, cf. Wackernagel-Debrunner 1954, 651.

ἀρτύς ἰσόνταξις, Latin *artus* ‘limb’ are not associated with clothing.<sup>59</sup>

More specific terms include *awjik* ‘collar’, presumably a derivative of a stem *\*(h)ang<sup>whi-</sup>* or *\*(h)ng<sup>whi-</sup>*, related to Greek ἀύχην, Aeolic ἄμωην ‘neck’,<sup>60</sup> and perhaps *p<sup>c</sup>elk* ‘rough mantle’ (also ‘curtain’) which has been connected with Greek πέλας, Lat. *pellis* ‘skin’ and the semantic close match of Old Prussian *pelkis* ‘mantle’, allegedly from the same root as Gothic *filhan* ‘envelop’ → ‘bury, conceal’.<sup>61</sup> The root final *\*-k/g-* (*\*-g-* > Arm. *-k-*) may be dealt with as an indication of “laryngeal hardening” which would point to an original root noun *\*pelh-s*, whence the Gothic denominative verb.<sup>62</sup> Another indigenous term for a garment may be *ter* ‘thin veil (for covering the head)’ if Ačařyan’s derivation from the root *\*der-* ‘skin’ is correct.<sup>63</sup> In that case we would be dealing with a narrowing of an older meaning ‘hide, covering’ and have an exact match in Greek δέρις ‘hide, skin’, but also ‘screen (used in a siege)’ < *\*dersi-*.<sup>64</sup> A ‘cover’ or ‘garment’ may also be described as a *verarku*, lit. ‘thrown over’, a loan translation from Greek περιβολαίον.<sup>65</sup> Finally, a few words for ornaments are based on inherited roots: the *a*-stem *gind* ‘earring’ from the root *\*μend<sup>h-</sup>* ‘turn, twist, weave’ as in Gothic *windan* etc., and *matani* ‘ring’, internally derived from *matn* ‘finger’ with cognates in Old Welsh *maut*, Middle Breton *meut* ‘thumb’.

Otherwise, the general picture is dominated by Iranian loanwords, thus the generic terms *patmowčan* ‘garment’, Pahlavi *ptmwcn*’, and *handerj* ‘clothes, clothing’ from an Iranian protoform *\*han-dard<sup>i-</sup>*, cf. Pahlavi *drc* ‘seam’.<sup>66</sup> The underlying Iranian root

*darz-*, also reflected in Middle Parthian *drz-* ‘tie on, load (pack-animals)’,<sup>67</sup> is probably Indo-European *\*d<sup>h</sup>erǵ<sup>h-</sup>* ‘turn’ with a semantic development to ‘twist, spin’ as also in Albanian *dreth* ‘turn; spin’.<sup>68</sup> The inherited Armenian verb *dar<sup>h</sup>nam*, aor. *darjay* < *\*d<sup>h</sup>ǵ<sup>h-</sup>* has preserved the original meaning ‘turn’, but one may consider if the otherwise etymologically unclear *jorj* (*o*-st.) ‘garment, coat, cloth, veil’, pl. ‘clothes’ could not be an inherited *b<sup>h</sup>óros*-derivative *\*d<sup>h</sup>órǵ<sup>h</sup>os* with distant assimilation *\*dorj* > *jorj*, i.e. [d<sup>z</sup>ord<sup>z</sup>]. If so, the joint evidence of Iranian, Armenian and Albanian would point to an extension of meaning ‘turn’ → ‘spin’ as common heritage.

The number of nouns of Iranian origin for specific garments and other specialized textiles is quite impressive, thus:

- *šapik* ‘shirt’, cf. Middle Parthian *špyk* ‘undershirt’, originally ‘nightshirt’, a substantivized derivative of the word for ‘night’, Avestan *xšap-*, Vedic *kšáp-*.
- *varšamak* ‘napkin, apron’, cf. Sogdian *w’ša’m*, Chwarezmian *w’š’m* ‘veil for the head’.<sup>69</sup>
- *t<sup>c</sup>aškinak* ‘handkerchief, sudarium’, corresponding to Pahlavi *tšknk* ‘undershirt’, from an Iranian protoform *\*taršikainaka-* or the like, cf. Avestan *taršu-* ‘dry’ with *t-* > *t<sup>c</sup>-* as in e.g. *t<sup>c</sup>ag* ‘crown’ < Iranian *tāg-*.
- *vtavak* ‘shift, shirt, robe’, used about the ephod or priestly robe, possibly a derivative of the stem continued in Pahlavi *wyt’b-* [witāβ] ‘shine’ in which case the original meaning would be a shining or simply white garment.
- *lenjak* ‘towel’ via an intermediary Iranian source

59. Cf., again with the prefix *\*h<sub>2</sub>mb<sup>h</sup>i-*, Avestan *aiβi-* + *ar-* ‘figure’ (Olsen 1999, 107-108).

60. Cf. also Clackson 1994, 107-109 with discussion.

61. Feist 1939, 151.

62. Olsen 1999, 93-94.

63. HAB IV, 442; cf. also Martirosyan 2010, 610.

64. There is no particular reason why δέρις would go back to a *\*-ti*-stem *\*der-ti-* (which would have yielded Armenian *\*terd*) as assumed by Clackson (1994, 54). Cf. de Lamberterie 1997, 74-76 for a common Greco-Armenian formation and Praust 2000 for further discussion of the root.

65. Olsen 1999, 542.

66. From the same root also Armenian *derjak* ‘tailor’, Pahlavi *dlcyk*’.

67. Boyce 1977, 26.

68. IEW 258.

69. Cf. Benveniste 1958, 70 and Périkhanian 1968, 25.

ultimately from Latin *lintheum* ‘anything made of linen, towel etc.’.<sup>70</sup>

- *vižakk<sup>c</sup>* ‘covering’, used in the Exodus about the Ark of the Covenant, has been compared with Khotanese *pvīys-* ‘cover’ < \**pati-vaiz-* by Bailey.<sup>71</sup>
- *gawti* ‘girdle, belt’, perhaps < Iranian \**gaftia-* from \**g<sup>h</sup>ab<sup>h</sup>-* ‘hold’;<sup>72</sup> cf. also *paregawt* below.
- *kamar* ‘girdle’, cf. Avestan *kamāra-*, Pahlavi *kml* ‘waist; belt, girdle’.
- *zankapan* ‘stocking’ or the like, cf. Pahlavi *zng* ‘ankle, shank’ + the Iranian stem *-pāna-* ‘protecting, protector’. A similar formation is the semi-calque *sīnapank<sup>c</sup>* ‘greaves’ whose first member is the inherited *srownk<sup>c</sup>* ‘shank’ (cf. Latin *crūs* etc.), similar to Gathic Avestan \**rānapānō* ‘qui protège la jambe, la jambière’.<sup>73</sup>
- *grapan* ‘seam at the neck’ (lit. ‘neck-protector’), cf. Modern Persian *girīban* ‘neck-guard, gorget’, a formation parallel to *zankapan*. For the initial member of the compound, cf. Pahlavi *glyw’* ‘neck, throat’, Avestan *grīuuā-*.
- *paregawt* ‘tunic, coat’, like Greek *παραγαύδης, παραγαύδιον* ‘garment with a purple border’ of Iranian origin, cf. *gawti*.
- *vartik<sup>c</sup>* ‘breeches’ with the compound *andravartik<sup>c</sup>*, presumably from a stem \**vartia-* based on the root *var-* ‘cover’; this Iranian loan is matched by Arabic *andarvart, andarvardiyya*.<sup>74</sup>
- *patrowak* ‘veil, covering’, almost certainly of Iranian origin though the exact source is unknown.
- *drawšak* ‘hem, corner (of clothes)’, a derivative

of *drawš* ‘banner’, Pahlavi *dlwš* ‘mark’ etc.

- *žapawēn* ‘hem, border of a garment, undoubtedly Iranian, cf. *apawēn* ‘refuge, protection’.<sup>75</sup>
- *kawšik* ‘shoe’, corresponding to Pahlavi *kpš, kpšk* ‘id.’.
- *k<sup>c</sup>urj* ‘sack, garment of sackcloth’, a *Wanderwort* borrowed from Iranian into Armenian as well as Arabic *kurz*.<sup>76</sup>

On the other hand, the Greek contributions to the old Armenian textile vocabulary are relatively modest: *lōdik* ‘cloak’ from Greek *λῶδιξ, λωδίκιον*; *k<sup>c</sup>lamid* ‘robe, cloak’ from *χλαμός, -όδος*; and *p<sup>c</sup>ilon* ‘cloak’<sup>77</sup> from *φελόνης, φαιλόνης*. Not only Greek itself, but also the Hebrew elements in the Septuaginta has left sporadic traces in the Armenian Bible, e.g. *badēn* ‘linen garment’,<sup>78</sup> a rendering of the Hebrew loanword in Greek *βαδδίν*, apparently with secondary influence from the suffix *-ēn* characteristic of adjectives of material. Similarly, the Syriac element is restricted to a few words: *amlan* ‘gown’;<sup>79</sup> *xlay* ‘coat’;<sup>80</sup> and possibly *xanjarowr* ‘swaddling band’, pl. ‘swaddling clothes’.<sup>81</sup> The etymological background of *k<sup>c</sup>awl* or *k<sup>c</sup>ol* ‘veil’,<sup>82</sup> and *bačkon* ‘cloak’, translating Greek *ἱμάτιον*,<sup>83</sup> is unclear.

As is natural, the Iranian military domination also affects the terminology of military outfit as seen from the following examples:

- *pateank<sup>c</sup>* ‘armour’ from Iranian \**patayāna-*, \**patiyāna-* or the like, containing the stem of the verb *patem* ‘surround, enclose’ (cf. e.g. also *arcat<sup>c</sup>apat* ‘covered with silver’) which probably

70. Ĵahukyan 1987, 631-631.

71. Bailey 1979, 258.

72. Olsen 1999, 874 and for the root IEW 407-408.

73. Kellens 1974, 330-332.

74. Ĵahukyan 1987, 547.

75. Cf. Benveniste 1964, 6.

76. Hübschmann 1897, 258; Ačāryan IV, 595-596.

77. 2.Tim.4.13.

78. Dan.12.6-7.

79. Josh.7.21; Syriac *āmellā*.

80. Syriac \**xil’ā*; Ačāryan II, 372.

81. Hübschmann 1897, 317.

82. Ačāryan IV, 585-586.

83. Ačāryan I, 400.

reflects an Iranian version of the root *\*peth<sub>2</sub>-* ‘spread out embrace’.<sup>84</sup>

- *varapanak* ‘(military) cloak’, lit. ‘breast-protector’, cf. Avestan *varah-* ‘breast’ and *-pan-* as in *zankapan* ‘stocking’, *sṛnapank<sup>c</sup>* ‘greaves’. The original source of *zrahk<sup>c</sup>* ‘armour’<sup>85</sup> with the reflex *-h-* of Iranian *-δ-*, cf. Avestan *zrāda-* ‘armour’, is apparently neither Middle Parthian nor Middle Persian from which we expect *-r-* and *-y-* respectively, but rather a third branch of Middle Iranian, though the word may have been transmitted through one of the two main dialects.
- *kštapanak* ‘armlet for the right arm’ with the literal meaning ‘side guardian’, cf. *kowšt* (side) → ‘belly’, Pahlavi *kwst* ‘side, direction’ (but Modern Persian *kušt* ‘belly’) and the same final element as in *varapanak*.
- *salawart* ‘helmet’ from a formation similar to Avestan *sārauuāra-* ‘helmet’,<sup>86</sup> lit. ‘head-concealer’ though the stem formation of the final member in the Armenian version is not an *a*-stem, as in Iranian, but either an extended root noun (Indo-European *\*-ur-t-*) or a *-ti*-stem (*\*-ur-ti-*).

*Taratok* ‘(soldier’s) cloak’ is etymologically obscure, cf. Martirosyan 2010, 602 with references.

Similarly, the vocabulary of ornaments, jewelry and royal attire is heavily influenced by Middle Iranian:

- a prominent example is *t<sup>c</sup>ag* ‘crown’, cf. Manichaean Middle Persian *t’g* [tāg] ‘arch’ and the Modern Persian palatalized version *tāj* ‘crown’. Bolognesi derived Arm. *t<sup>c</sup>ag* and Persian *tāj*

independently from the same root as Greek *στέφος* < *\*(s)teg<sup>wh</sup>-* on account of the initial *t<sup>c</sup>-* which he considered incompatible with an Iranian loan.<sup>87</sup> However, there are other examples of such a development, e.g. *t<sup>c</sup>akoyk* ‘vessel, goblet’ vs. Middle Persian *tkwk* ‘drinking vessel’, and moreover, Benveniste’s ingenious derivation of *t<sup>c</sup>agowhi* ‘queen’ from *\*tāga-br̥θyā-* ‘crown-bearer’ (f) strongly suggests an Iranian origin of both compositional members.<sup>88</sup> The relation between *tāg/tāj* and *στέφος* may still be maintained: *tāg* from a “tomós”-type *\*tog<sup>wh</sup>ós* and *tāj* a hybrid formation between *tāg* with Brugmannian lengthening and a competing *s*-stem *\*teg<sup>wh</sup>es-*, like *στέφος*, with *e*-grade and palatalization.

- *psak* ‘crown, garland’, cf. Pahlavi *pwsg* ‘garland’, Avestan *pusā-* ‘tiara’.<sup>89</sup>
- *xoyr* ‘mitre, diadem, bonnet’, cf. Avestan *-xaoda-* ‘helmet’; hence also *artaxowrag* ‘covering, tiara’.
- for the compound *mehewand* ‘necklace’, whose final member *-awand* clearly reflects Iranian *\*-banda-* ‘band’,<sup>90</sup> Bailey suggested a first member *\*m<sup>r</sup>jū-*, whence Avestan *mərəzu-* ‘neck’ or ‘vertebra’;<sup>91</sup> this was later improved by Gippert to *\*m<sup>r</sup>jūiia-band-* which would explain the connecting *-e-*.<sup>92</sup> However, the phonetic development *\*-rjū- > -h-* has no recognized parallels, so as an alternative explanation Olsen has suggested a protoform *\*miθriya-βanda-* from a stem related to (Iranian →) Greek *μίτρη* ‘headband’ etc.<sup>93</sup>
- *aparanjan* ‘bracelet’, cf. Modern Persian *abranjan*.
- *čelanak* ‘sort of head ornament’, probably ‘hair

84. LIV 478-479; cf. further Avestan *paθana-* ‘wide, broad’. From the same root we also have *patan* ‘bandage’, *diapatik* ‘embalmer’, a compound with the probably inherited *dī* ‘dead body’, and *patand* in the phrase *arnowl i patand* ‘take hostage’ (lit. ‘into enclosure’). In view of the missing sound shift, the verb cannot be indigenous in Armenian.

85. Bolognesi 1960, 42; Schmitt 1983, 84 and 90.

86. Benveniste 1958, 69.

87. Bolognesi 1948, 14.

88. Benveniste 1945 [1946], 74.

89. Cf. also the Tocharian A loanword *pässäk* (Isebaert 1980, 158 and 200).

90. Cf. Middle Parthian *bnd*, Avestan *banda-*.

91. Bailey 1989, 1-2.

92. Gippert 1993, 140.

93. Olsen 1999, 895. Cf. for the phonetics *mehean* ‘temple’ from Iranian *\*miθriyāna-* ‘Mithra-sanctuary’.



pin', is a diminutive of the Middle Iranian word for 'dagger', Pahlavi *cyl'n*.<sup>94</sup>

- *sndus*, translating Gk. *τρίχαπτον* 'fine veil of hair' in Ezek.16.10, cf. Modern Persian *sundus* 'species panni serici tenuis'.
- *pačoyč* and *pačučank*<sup>c</sup> 'attire, toilette, ornament', cf. Meillet 1922.
- *čamuk* 'decoration, ornament', apparently also of Iranian origin though the details are unclear, cf. Ačāryan III, 180.
- *p<sup>c</sup>ološuk* 'hair-clasp' looks like a derivative of the etymologically unclear *p<sup>c</sup>ološ* 'moray', the clasp perhaps compared with the jaws of the fish.

The ultimate origin of *maneak* 'necklace', Greek *μανιάκης*, is also likely to be Iranian, while the background of *k<sup>c</sup>ayr* 'necklace' is unknown.

### Textile techniques, dyes and decorations

As we have seen, the words pertaining to basic textile production such as spinning and weaving mainly have an indigenous background, but when it comes to more advanced techniques and the production of luxuries, the Iranian influence has left its unmistakable mark. An interesting example is the agent noun *nkarakert* 'embroiderer'.<sup>95</sup> While the first member of this compound is clearly *nkar* 'picture; variegated',<sup>96</sup> the final stem differs semantically from other formations in *-(a)kert* < \**-kṛta-* '-made' with the expected passive meaning of the participle. This is what we find in the semi-calques *jeṛakert* 'hand-made', *p<sup>c</sup>aytakert* 'made of wood' or the complete loanword *ašakert* 'disciple', Manichaean Middle Persian *hš'gyrd* 'disciple, pupil', according to Benveniste's brilliant analysis a South

West Iranian loan whose first member corresponds to Old Persian *hašiya-* (Avestan *haiθiia-*) 'true', so that the original meaning would be 'qui est rendu authentique, accompli'.<sup>97</sup> The discrepancy of verbal voice in *nkarakert* is not readily explained, and for this reason it seems worth considering if we could not be dealing with a different root. An obvious candidate is Indo-Iranian \**kart-* 'spin; stretch a tread'. Incidentally such a root is attested in RV *út kṛṇatti*, and from Iranian probably Chwarezmian *kncṣ-* 'twist'.<sup>98</sup> In that case a *nkarakert* would simply be a 'picture-weaver' or 'picture-embroiderer' and thus be etymologically distinct from Pahlavi *ng'rgr* (*-kar*) which would be a 'picture-maker', *i.e.* a painter. From the same semantic field and with the same first member we also find *nkarakerp* 'variegated, embroidered' where the final member is *kerp* 'form', cf. Manichaean Middle Persian *qyrb* 'form, shape' < Indo-European \**-k<sup>w</sup>ṛp-*, etymologically related to Latin *corpus* etc.

Words for precious materials borrowed from Iranian may be exemplified by *dipak* 'brocade', Pahlavi *dyp'g'*, and *zarnawowxt* 'silken', originally 'interwoven with gold', *i.e.* \**zarna-vufta-*, cf. Sogdian *zyrnywfc* with the same final participle, 'woven', as *čačanawowxt* 'variegated, multi-coloured'. However, one designation for a luxury article, the word for scarlet, *ordan*, is indigenous, derived from *ordn* 'worm',<sup>99</sup> and thus semantically comparable with Old Church Slavonic *čr̃mьbnь* 'red' which is related to *črbьnь* 'worm'.<sup>100</sup> This is hardly surprising, considering the fact that Armenia is the homeland of the Armenian or Ararat cochineal, a scale insect of which a precious crimson dye has been produced from ancient times. It is thus not unthinkable that for once the Iranian word which

94. Cf. Ačāryan III, 195; MacKenzie 1971, 22.

95. Olsen 265-266.

96. Cf. Manichaean Middle Persian *ng'r* 'image, picture', Modern Persian *nigār* 'painting, picture'.

97. Benveniste 1945, 69-70.

98. Cf. EWAia I, 316. Thus \**kert-* (LIV 356), besides \**spen(h)-* and \**sneh<sub>1</sub>(i)-*, would be another inherited root with the meaning 'spin'. Eichner (1974, 98; cf. also Kloekhorst 2008, 459-460) has adduced a possible cognate in the Hittite noun *karza-/karzan-* 'spool' or 'bobbin'.

99. While *ordn* has no recognized etymology, a remodelling or contamination between the protoforms of Latin *vermen* and Sanskrit *kṛmi-* 'worm' is hardly out of the question, cf. Olsen 1999, 127.

100. This belongs with the widespread word family also represented by Sanskrit *kṛmi-* 'worm; spider; shield-louse', Lithuanian *kirmis* 'worm' etc. French *cramoisin*, English *crimson*, Dutch *karmozijn* etc. derive from Medieval Latin *carmesinus*, a derivative of a borrowing from Arabic *qirmiz* whose ultimate source is Persian *qirmiz*.

is the source of the European words for crimson (cf. note 100) is a calque from Armenian.

Another red dye is scarlet, Armenian *janjaxarit<sup>c</sup>*, produced from the insect *Kermes vermilio*,<sup>101</sup> mainly feeding on a species of oak trees, *quercus coccifera*, in the Mediterranean region. The only early Armenian attestation is from Isaiah 1.18 where we have a parallel of the red scarlet and crimson as opposed to the white snow and wool: *Ew et<sup>c</sup>ē ic<sup>c</sup>en melk<sup>c</sup> jer ibrew z-janjaxarit<sup>c</sup>, ibrew z-jiwn spitak araric<sup>c</sup>, ew et<sup>c</sup>ē ic<sup>c</sup>en ibrew z-ordan karmir, ibrew z-asr sowr araric<sup>c</sup>* “‘Though your sins be as *scarlet* (Greek “ὡς φοινικῶν”), they shall be white as snow; though they be like *red crimson*, they shall be as pure wool”. According to Ačařyan,<sup>102</sup> we are dealing with a Semitic loanword, cf. Syriac *zəxōrīṯā* ‘cocum, red worm’. Apparently the stem *janjir-* (*janjir arnel* ‘tire, annoy’) has played a supplementary folk-etymological role, cf. the alternative spelling *janraxarit<sup>c</sup>* and the later meaning of *janjaxarit<sup>c</sup>*, ‘dark, dull red’.

The semantically related *cirani* ‘purple; of purple, purple coloured’, most likely has an Iranian origin. Obviously the stem is connected with *ciran* ‘apricot’, and with a basic meaning ‘golden’ we may compare with the family of Avestan *zaraniia-*, Sogdian *zyrn*, Vedic *hīranya-* ‘gold’, i.e. Indo-European \*ǵ<sub>3</sub>h<sub>3</sub>(e)n- via a dialectal Iranian protoform \*d<sup>̄</sup>iran- under the assumption that the loan precedes the stage of mediae > tenues of the Armenian soundshift. Such very early loans are rare, but apparently not quite exceptional,<sup>103</sup> cf. the notable example of *partēz* ‘garden’ with \*-d- > -t- (Avestan *pairi-daēza-*), and probably also *arcat<sup>c</sup>* ‘silver’ from IE \*(h<sub>2</sub>)rǵnto- (Avestan

*arəzata-*, Latin *argentum*), again from a dialectal Iranian protoform with affricate from original palatal, i.e. \*ard<sup>̄</sup>ata- > *arcat<sup>c</sup>-*.<sup>104</sup>

In connection with the discussion of garments and materials it may be worthwhile to have a brief look at the colour terms, though of course these are also used in other contexts. For the essential concept of ‘colour’ the Armenian noun *goyn* (o-st.) is of Iranian origin, cf. Avestan *gaona-*, Pahlavi *gwn’*.<sup>105</sup> The stem is also widely attested in composition, and in the reduplicated *gownak gownak* in Jud.15.15: *psaks gownaks gownaks*, probably ‘multicoloured wreaths’. A more specialized term is *erang* ‘colour, dye’, cf. Pahlavi *lng*, Sanskrit *raṅga-*, while ‘dye’ or ‘coloured, embroidered material’ is expressed by the loanword *narawt* which has been compared with Khotanese *nar-* by Bailey.<sup>106</sup> Likewise, most of the specific colour terms have an Iranian background, thus:

- *pisak* ‘spotted, speckled’,<sup>107</sup> a derivative of \**paisa-*, Avestan *paēsa-* ‘ornament’.
- *spitak* ‘white’ with the North West Iranian development of \**k̑u-* > *sp-*, cf. Pahlavi *spytk’*, Sanskrit *śveta-*.
- *seaw* ‘black’, cf. Middle Parthian *sy’w*, Avestan *siiāuuu-*.
- *karmir* ‘red’, cf. Sogdian *krm’yr*.
- *kapoyt* ‘dark blue’ and *kapowtak* ‘bluish’ where the original meaning would have been ‘dove-coloured’, cf. Pahlavi *kpwt’* ‘grey-blue; pigeon’, Old Persian *kapautaka-*, probably ‘blue’, Vedic *kapōta-* ‘pigeon’.

101. The Latin name is taken from the above-mentioned word for ‘crimson’.

102. Ačařyan III, 145-146.

103. Cf. the discussion in Olsen 2005.

104. De Lamberterie 1978, 245-251.

105. This noun has had a tremendous success in Armenian, first in compounds as complete loanwords, e.g. *vardagoyn* ‘rose-coloured’ (Sogdian *wrōywn*), *karmiragoyn* ‘reddish’ (Sogdian *krm’yr ywn’k* ‘of red colour’) or semi-calques such as *oskegoyn* (*oski* ‘gold’) beside Sogdian *zyrnywn(ē)* ‘gold-coloured’, then from the nucleus of colour adjectives to a general adjective suffix describing appearance or manner, e.g. *mardasiragoyn* ‘in a gentle manner’, and finally we find full grammaticalization in the usual comparative/relative suffix. In modern Armenian, *-goyn* is used to express the superlative.

106. Bailey 1989, 174.

107. Originally only used about animals such as horses and goats. On the whole, the vocabulary pertaining to horses is strongly influenced by Iranian on account of their military importance.

108. Ačařyan II, 510-511.

The historical background of *kanač* 'green'<sup>108</sup> and *gorš* 'grey'<sup>109</sup> is unknown, and of the basic colour terms only *delin* 'yellow' has a plausible Indo-European etymology.<sup>110</sup>

This selection of textile terms from Classical Armenian testifies to a rich and varied vocabulary, historically shared between a foundation of inherited lexical material and an influx of cultural loans from the politically and culturally dominant Iranians. Our sources do not permit us to go beyond the stage of the reconstructed Indo-European protolanguage, but we do know for certain that the area now inhabited by Armenians has a long tradition of advanced textile technology. In a cave in Vayoc<sup>c</sup> Jor in the southern part of Armenia, archaeologists have excavated a beautifully sown moccasin, "the world's oldest shoe", dated to about 3500 BC.<sup>111</sup> What language its wearer spoke and what words he or she would have used to describe it, its material, colour and fabrication, we shall never know.

### Abbreviations

Ciakciak = P.W. Ciakciak: *Barğirk<sup>c</sup> barbar hay ew italkan* I-II. Venetik 1837.

EWAia = Manfred Mayrhofer: *Etymologisches Wörterbuch des Altindoarischen*. Heidelberg 1986-2001. Heidelberg.

IEW = Julius Pokorny: *Indogermanisches etymologisches Wörterbuch*. Bern, 1959.

LIV = *Lexikon der indogermanischen Verben. Die Wurzeln und ihre Primärstammbildungen*. Unter Leitung von Helmut Rix und der Mitarbeit vieler anderer bearbeitet von Martin Kümmel, Thomas Zehnder, Reiner Lipp, Brigitte Schirmer. Zweite, erweiterte und verbesserte Auflage bearbeitet von Martin Kümmel und Helmut Rix. Wiesbaden, 2001.

Nor Barğirk<sup>c</sup> = *Nor Barğirk<sup>c</sup> haykazean lezowi* I-II. Venice. Reprint Erevan 1979-81.

### Bibliography

- Ačařyan, Hr. (1971-79) *Hayeren Armatakan Bařaran*, I-IV, Erevan (1. ed. 1926-35).
- Anthony, D. (2007) *The horse, the wheel and language*. Oxford.
- Bailey, H. W. (1979) *Dictionary of Khotan Saka*. Cambridge.
- Bailey, H. W. (1989) Two Armeno-Iranian Etymologies. *Annual of Armenian Linguistics* 10, 1-4.
- Beekes, R. (2010) *Etymological Dictionary of Greek*, 1-2. Leiden – Boston.
- Benveniste, É. (1945) Études Iraniennes III. Emprunts iraniens en arménien. *Transactions of the Philological Society* 1945 [1946], 68-78.
- Benveniste, É. (1958) Mots d'emprunt iraniens en arménien. *Bulletin de la Société de Linguistique de Paris* 53, 5-71.
- Benveniste, É. (1964) Eléments parthes en arménien. *Revue des Études Arméniennes* NS 1, 1-39.
- Bolognesi, G. (1948) Pers. *tāj*, Arm. *řag*. *Atti del Sodalizio Glottologico Milanese* I, 1, 14-15.
- Bolognesi, G. (1960) *Le fonti dialettali degli imprestiti iranici in armeno*. Milano.
- Boyce, M. (1977) *A Word-List of Manichaeic Middle Persian and Parthian with a reverse index by Ronald Zwanziger*. Teheran – Liège – Leiden.
- Cheung, J. (2007) *Etymological Dictionary of the Iranian Verb*. Leiden – Boston.
- Clackson, J. (1994) *The Linguistic Relationship between Armenian and Greek*. Publications of the Philological Society 30. Oxford – Cambridge.
- Cowgill, W. & M. Mayrhofer (1986) *Indogermanische Grammatik*, Band I – 1/2. Heidelberg.
- de Lamberterie, Ch. (1978) Armeniaca I-VIII: Études Lexicales. *Bulletin de la Société de Linguistique de Paris* 73, 243-283.
- de Lamberterie, Ch. (1982) Revue de R. Schmitt, Grammatik des Klassisch-Armenischen (1981). *Bulletin de la Société de Linguistique de Paris* 77.2, 80-84.
- de Lamberterie, Ch. (1997) Review of James Clackson, *The Linguistic Relationship between Armenian and Greek* (1994). *Kratylos* 42, 71-78.
- Eichner, H. (1974) *Untersuchungen zur hethitischen Deklination*. Erlangen (Dissertation).

109. Ačařyan I, 584.

110. Apparently a derivative of *del* 'herb' (cf. also *delj* 'peach', *deljan* 'blond', *dalukn* 'jaundice') which would match Latin *helus* > *holus* 'herb' < \**ǵ<sup>h</sup>élh<sub>3</sub>os* except for the initial \**ǵ<sup>h</sup>*-, regularly yielding *j*-, i.e. [d<sup>h</sup>]. Perhaps the stem was contaminated with the semantically related *dalar* 'fresh and green' = Greek *θαλερός*.

111. Cf. Pinhasi *et al.* 2010.

- Feist, S. (1939) *Vergleichendes Wörterbuch der gotischen Sprache mit Einschluss des Krimgotischen und sonstiger zerstreuter Überreste des Gotischen*. Dritte neubearbeitete und vermehrte Auflage. Leiden.
- Gippert, J. (1993) *Iranica Armeno-Iberica. Studien zu den Iranischen Lehnwörtern im Armenischen und Georgischen*. Wien.
- Hübschmann, H. (1897) *Armenische Grammatik, Erster Teil, Armenische Etymologie*. Leipzig (3. imp., Hildesheim – New York, 1972).
- Isebaert, L. (1980) *De indo-iraanse bestanddelen in de tocharische woordenschat*. Leuven.
- Ĵahukyan, G. B. (1987) *Hayoc' lezvi patmowt'yown*. Erevan.
- Jungmann, P. & J. J. S. Weitenberg (1993) *A Reverse Analytical Dictionary of Classical Armenian*. Berlin – New York.
- Kellens, J. (1974) *Les noms-racines de l'Avesta*. Wiesbaden.
- Klingenschmitt, G. (1982) *Das altarmenische Verbum*. Wiesbaden.
- Kloekhorst, A. (2008) *Etymological Dictionary of the Hittite Inherited Lexicon*. Leiden – Boston.
- Lipp, R. (2009) *Die indogermanischen und einzelsprachlichen Palatale im Indo-Iranischen*, I-II. Heidelberg.
- MacKenzie, D. N. (1971) *A Concise Pahlavi Dictionary*. London.
- Mallory, J. P. & D. Q. Adams (eds.) (1997) *Encyclopedia of Indo-European Culture*. London – Chicago.
- Manaster R., A.. ms. Armenian -z- < \*-b<sup>h</sup>y-, -c<sup>ç</sup> < \*-zk<sup>ç</sup>.
- Martirosyan, H. K. (2010) *Etymological Dictionary of the Armenian Inherited Lexicon*. Leiden – Boston.
- Meillet, A. (1894) De quelques difficultés de la théorie des gutturales indo-européennes. *Mémoires de la Société de Linguistique de Paris* 8, 277-304.
- Meillet, A. (1922) De quelques mots parthes en arménien. *Revue des Études Arméniennes* II, 1-6.
- Melchert, H.C. Forthcoming. Semantics and Etymology of Hittite *takš-*. Forthcoming in Festschrift for Alexander Lubotsky.
- Olsen, B. A. (1999) *The Noun in Biblical Armenian, Origin and Word-Formation – with special emphasis on the Indo-European heritage*. Trends in Linguistics, Studies and Monographs 119. Berlin – New York.
- Olsen, B. A. (2002) A Note on Armenian Preverbs and Prepositions. In F. Cavoto (ed.), *The linguist's linguist: a collection of papers in honour of Alexis Manaster Ramer*. München, 309-316.
- Olsen, B. A. (2005) On Iranian dialectal diversity in Armenian. In G. Meiser & O. Hackstein (eds.), *Sprachkontakt und Sprachwandel: Akten der XI. Fachtagung der Indogermanischen Gesellschaft, 17.-23. September 2000, Halle an der Saale*, 473-481. Wiesbaden.
- Olsen, B. A. Forthcoming. The Indo-European vocabulary of sheep, wool and textile production. To appear in: R. Iversen & G. Kroonen (eds.), *Archaeology and Language – and the future of archaeo-linguistic studies*. Oxford.
- Patrubány, L. v. (1902) Zur armenischen Wortforschung. *Indogermanische Forschungen* 14, 54-59.
- Pedersen, H. (1905) Zur armenischen Sprachgeschichte. *Zeitschrift für vergleichende Sprachwissenschaft* 38, 194-240.
- Périkhanian, A. (1968) Notes sur le lexique iranien en arménien. *Revue des Études Arméniennes* 5, 9-30.
- Pinhasi, R. et al. (2010) First Direct Evidence of Chalcolithic Footwear from the Near Eastern Highlands. *PLoS ONE*, 9 June 2010.
- Praust, K. (2000) Altindisch *dr̥-/d̥r̥-*: *seṭ* oder *aniṭ*? In B. Forssman & R. Plath (eds.), *Indoarisch, Iranisch und die Indogermanistik. Arbeitstagung der Indogermanischen Gesellschaft vom 2. bis 5. Oktober 1997 in Erlangen*, 445-441. Wiesbaden.
- Rasmussen, J. E. (1999) Miscellaneous problems in IE languages VII. 52. Germanic instrument nouns in \*-la-. *Selected Papers on Indo-European Linguistics. With a Section on Eskimo Linguistics*, 1-2, 651-653. Copenhagen.
- Saradževa, L. A. (1986) *Armjano-slavjanskije leksiko-semantičeskie paraleli: sravitel'no-istoričeskoe issledovanie genetičeski obščej leksiki*. Yerevan.
- Schmitt, R. (1967) *Dichtung und Dichtersprache in indogermanischer Zeit*. Wiesbaden.
- Schmitt, R. (1983) Iranisches Lehngut im Armenischen. *Revue des Études Arméniennes* 17, 73-112.
- Solta, G. R. (1960) *Die Stellung des Armenischen im Kreise der indogermanischen Sprachen*. Wien.
- Solta, G. R. (1990) Die Stellung des Armenischen im Kreise der indogermanischen Sprachen. Ein Überblick. In E. M. Ruprechtsberger (ed.), *Armenien, Beiträge zur Sprache, Geschichte und Archäologie*, Linz, 7-17.
- Spiegelberg, W. (1907) Ägyptische Lehnwörter in der älteren griechischen Sprache. *Zeitschrift für vergleichende Sprachforschung* 41, 127-132.
- Wackernagel, J. (1954) *Altindische Grammatik*. Band II, 2 “Die Nominalsuffixe” von Albert Debrunner. Göttingen.
- Winter, W. (1962) Problems of Armenian phonology II. *Language* 38, 254-262.
- Winter, W. (1983) Nochmals arm. *hiwsn* ‘Zimmermann’. *Die Sprache* 29, 177-181.

## Remarks on the Interpretation of Some Ambiguous Greek Textile Terms<sup>1</sup>

Stella Spantidaki

The study of written sources of the Classical period (5<sup>th</sup> and 4<sup>th</sup> centuries BC) reveals the existence of a very rich vocabulary related to textile production. There are terms referring to materials, tools, manufacture and decoration techniques, colours, people and places related to textile manufacture. Many terms are quite clearly defined, while others present major difficulties in their interpretation. Usually these concern terms for tools, such as *κερκίς* (pin beater or shuttle) and *ήλακάτη* (distaff or spindle) or terms describing fabrics with some kind of decoration. Among the decorative terms, some refer to specific decorative techniques, such as *κατάστικτος* (embroidered) while others refer to aesthetic results, such as *ποικίλος* (with elaborate and colourful decoration).<sup>2</sup>

I believe it is quite important at this point to underline a significant characteristic of the ancient Greek language. Although languages are not simply univocal codes and their meaning is the most important dimension, ancient Greek has what may be called an *indivisible* polysemy of words (and grammatical cases). Its semantic richness cannot be compared to modern European languages, such as English.<sup>3</sup> In this

context, one and the same ancient Greek term can include more than one meaning simultaneously (*e.g.*, *ώρα* = time, season, youth, perfect moment), in which case the translator *does not* have to choose between the different meanings, because they are all included – or the same term can have different meanings depending on the context (*e.g.*, *όργή* = anger, wrath, but also drive, impulse, temperament, outburst), in which case the translator has to choose the right meaning. This could lead to difficulties in the lexical field of textiles and textile production.

Very often a single term creates semantic harmonics, which produce in the mind of the listener a series of mental associations through its resonances, consonances and connotations. In order to understand a term, one has to clarify its entire semantic potential. Furthermore, each term must be interpreted in relation to its context as opposed to adopting an univocal or unambiguous meaning. This kind of ambiguity certainly does not apply to every single term. For example, terms for weaving tools must have been clearly defined in Antiquity, although they often seem ambiguous to us today.

1. I would like to thank Marie-Louise Nosch and Cécile Michel for giving me the opportunity to participate in the conference.

2. Spantidaki 2016, 97-105.

3. Cf. modern poetry such as the great Shakespeare or Proust and the using of the *developed metaphor* in Castoriadis 1999, 35-61.

In this chapter I am going to discuss the term *μίτος*,<sup>4</sup> core term of a family of words with many composita, such as *εὔμιτος*, *λεπτόμιτος*, *τρίμιτος*, *πολύμιτος* and derivatives, such as *μιτώδης*, *μίτινος* and *τριμίτινος*. The term *μίτος* is without known etymology as per all recent etymological dictionaries and accordingly without convincing explanation about its original meaning.<sup>5</sup> In time it came to refer to the thread in general, *ἀγαθὴς μί(λ)τον*,<sup>6</sup> ‘ball of thread’. The term seems to change meaning depending on the compositum (in the case of *λεπτόμιτος* we are certain that this term refers to a fabric created with fine threads, but in the case of *τρίμιτος* for example, we are not sure of the meaning of the term *μίτος*). From all these related terms, I have chosen to examine the terms *μίτος* => *τρίμιτος* / *τριμίτινος* => *πολύμιτος*. These terms contain the term *μίτος* and, moreover, they refer to multiples of *μίτος*. I think it is important to try to elucidate both the meaning of the core term, and that of its composita.

References of these terms in ancient written sources are scarce. The first reference of the term *μίτος* is found in the *Iliad*,<sup>7</sup> and there are three more in texts of the Classical period. *Τρίμιτος* and *τριμίτινος* are mentioned four times in Classical literature.<sup>8</sup> Concerning the last term of the family, *πολύμιτος*, only two references can be found in texts of the same period.<sup>9</sup> The first one refers probably to dense fabrics and the other is a fragmentary text, where the term is mentioned without a context. The term *πολύμιτος*

then disappears from Greek literature for five centuries to appear again in the 1st century AD,<sup>10</sup> where it has been translated as ‘figured linens’.<sup>11</sup> Later, Hesychius, in the 5<sup>th</sup> century AD, mentions the term *δίμιτος*,<sup>12</sup> which seems to fit perfectly in the family. During the Byzantine period one more related term appears, *ἔζάμιτος*, referring to weft faced compound twill fabrics.<sup>13</sup>

So it appears that *μίτος*, apart from always referring to a simple thread, could also denote a specific type of thread, depending on the context. There are several theories on the meaning of this family of terms, still under discussion.

### Theories on the definition of *Μίτος*

#### *Μίτος* = warp thread

In the first theory, the term is defined as the warp threads of the loom. This is mainly based on the Homeric passage, where the term *μίτος* has been translated by several scholars as warp.<sup>14</sup> Additionally, a passage from the *Anthologia Graeca* seems to refer to threads divided by the pin beater, the *κερκίς*, thus pointing to the warp threads.<sup>15</sup>

#### *Μίτος* = single thread

According to the second theory, if *μίτος* signifies thread, the terms *τρίμιτος* and *τριμίτινος* could refer to three-ply yarns, in contrast to single threads. Three-stranded cords have been discovered in Akrotiri,

4. E. Fr. 369.1 (Nauck 1964); Pherecr. Fr. 156 (146).7 (PCG VII); Lyc. *Alexandra* 584 (Budé 2008).

5. Frisk, Chantraine, Beekes, s.u.

6. Pherecyd. Fr. 106a.5 (Müller 1975).

7. Hom. *Il.* 23.762 (Monro 1963).

8. For *τρίμιτος* see: Lysipp. Fr. 3 (3) (PCG V 1986); A. Fr. 44A 713a.1, 44A 713b.1 (Mette 1959). For *τριμίτινος* see: A. Fr. 44A 713b.1, 44A 713a.3, Fr. 365.1 (Mette 1959); Crates Com. Fr. 41 (34) (PCG IV 1983).

9. A. *Suppl.* 432 (Page 1972); Cratin. Fr. 481 (436) (PCG IV 1983).

10. *Periplus Maris Erythraei* 39.7 (Casson 1989).

11. Schoff 1912, 37.

12. Hesychius, *Lexicon* D1480.1 (Latte 1996).

13. *Typica Monastica* 33.1733 (Gautier 1984); *Acta Monasterii Lavrae* 17 (Guillou *et al.* 1979); *Acta Monasterii Xeropotami* 2.29 (Bompaire 1964); *Acta Monasterii Iviron* 179.37 (Kravari 1990); Joannes Apocaucus, *Epistulae et acta* 21.14 (Pétridès 1909); Nicetas Choniates *Reign. ManI*, part 2, p.98, line of page 23 (Dieten van 1975); *Bellum Troianum* 6521 (Jeffreys 1996); *Achilleis Byzantina*, line 409 (Agapitos 1999); Nicolaus Artabasdos Rhabdas, *Epistula* 35.2 (Tannery 1920).

14. Schröder 1884, 171; Blümner 1912, 141, 149.

15. A. G. VI 174.6 (Beckby 1965).



**Fig. 1.** Woman possibly plying threads into a cord. *Lekythos* in the Museum of Syracuse. After Lang 1908, 51, fig. 20.

Thera, dated back to the 17<sup>th</sup> century BC, more than a thousand years before the Classical period.<sup>16</sup>

In the context of this theory, the more recent term *δίμιτος*<sup>17</sup> would refer to two-ply yarns. The term *πολύμιτος* would refer to multiple plying, threads or ropes created by more than three different yarns. Fragments of rope dated to the Classical period have been recently discovered in Piraeus, but they have not yet been studied. There is, however, a Classical iconographic scene, which could perhaps be associated to the process of plying and the term *πολύμιτος* (Fig. 1). Margarete Lang agrees with Eugen Petersen that the

scene depicts a woman twisting together a large number of threads, creating a thick thread or rope forming a large ball.<sup>18</sup> Petersen remarks that small weights are attached to the threads in order to keep them taut during the plying, although this cannot be seen on the drawing.<sup>19</sup> Lang comments that in sail-making the number three was important and remarks that the second of the finer threads seems to be a three-ply one.<sup>20</sup>

The two Classical terms, *τρίμιτος* and *τριμίτινος* may also refer to fabrics created with three-ply yarns, and the later term *δίμιτος* to fabrics created with two-ply yarns. Fabrics with two-ply yarns have been discovered in Greece, but all belong to earlier periods, as for example in Akrotiri, Thera (17<sup>th</sup> century BC),<sup>21</sup> Mycenae (13<sup>th</sup> century BC),<sup>22</sup> Aghia Kyriaki on Salamina (Mycenaean cemetery),<sup>23</sup> Lefkandi (around 1000 BC)<sup>24</sup> and Corfu (7-6<sup>th</sup> century BC)<sup>25</sup> (Fig. 2).

The *Tractate Sheqalim*<sup>26</sup> of the Jerusalem Talmud refers to priestly vestments and the veils and curtains of the Tabernacle with their respective textile requirements. Among them, it mentions six-ply and multiple-ply (32 and 48-ply) threads, which could correspond to the Greek terms *ἑξάμιτος* (six-ply) and *πολύμιτος* (32 and 48-ply). Although the elaboration of the Jerusalem Talmud was finished in the mid-5<sup>th</sup> century AD, this passage could reflect techniques of much earlier periods.

Preserved fabrics from the Classical period are always created with single yarns. However, it is clear that the technology of plying yarns existed in Greece during the Classical period. After all, the city of Athens alone needed huge amounts of roping for its numerous ships<sup>27</sup> and surely for countless other

16. Unpublished study, ARTEX.

17. Hesychius, *Lexicon* D1480.1 (Latte 1996).

18. Lang 1908, 53.

19. Petersen 1892, 182.

20. Lang 1908, 53.

21. Spantidaki & Moulhéat 2012, 187, 188, fig. 7.1, 7.2.

22. Spantidaki & Moulhéat 2012, 192, fig. 7.4-7.6.

23. Moulhéat & Spantidaki 2009, 16, fig. 3.

24. Moulhéat & Spantidaki in press.

25. Metallinou *et. al.* 2009, 42, fig. 41a and b.

26. Jerusalem Talmud, *Tractate Sheqalim*, Ch. 8, p. 51. I am grateful to Nahum Ben-Yehuda for kindly providing me this information.

27. The Naval Inventories of Piraeus of the 4<sup>th</sup> century BC, which mention the parts of the ships stored in ship sheds make reference to different kinds of rope, *ἑξδάκτυλον* (6-finger) and *ὀκτωδάκτυλον* (8-finger) (*e.g.*, IG II<sup>2</sup> 1627.471). The term *δάκτυλος* is an Attic unit of length measuring ca. 2 cm. These different size ropes would have been produced with different numbers of finer cords, but the numbers in their description do not necessarily correspond to the number of the smaller cords, but only to their thickness.



Fig. 2. Detail of the weave and the two-ply threads of the fabric of Aghia Kyriaki on Salamis. Photo ARTEX.

purposes. The question is whether we can connect the technique of plying with the family of the term *μίτος*.

#### *Μίτος = heddle*

According to the third interpretation theory, the term *μίτος* refers to the heddles of the loom that is the group of threads connecting the heddle bar to the threads of the warp.<sup>28</sup> In a passage of the *Partitiones* of Aelius Herodianus (2<sup>nd</sup> century AD), the term *μίτος* is explained as *μιάριον*, the term that gave the Modern Greek term for heddle, *μιάρι*.<sup>29</sup> It would be plausible to assume that in the 2<sup>nd</sup> century AD the term

had at least the meaning of heddle. Several references from later periods point to an interpretation of the term *μίτος* as heddle.<sup>30</sup>

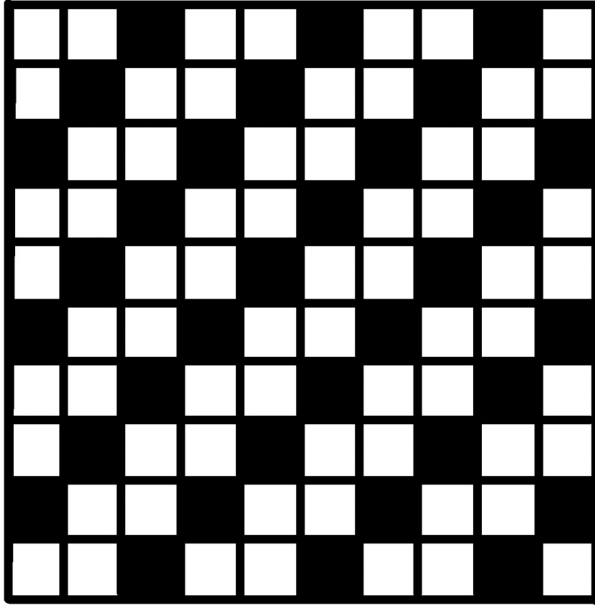
The warp-weighted loom has a natural shed formed by a shed bar at its bottom, so the Greeks could create a plain weave using only one heddle bar. The Modern Greek term *δίμιτος* is an Ancient Greek term that has survived in Modern Greek and refers to every type of twill. In Ancient Greek, *δίμιτος* could refer to a weave using two heddle bars, the twill 2:1 (Fig. 3). Unfortunately, there is no written evidence to this term until the 5<sup>th</sup> century AD. The Classical terms *τρίμιτος* and

28. Barber 1991, 267, 268.

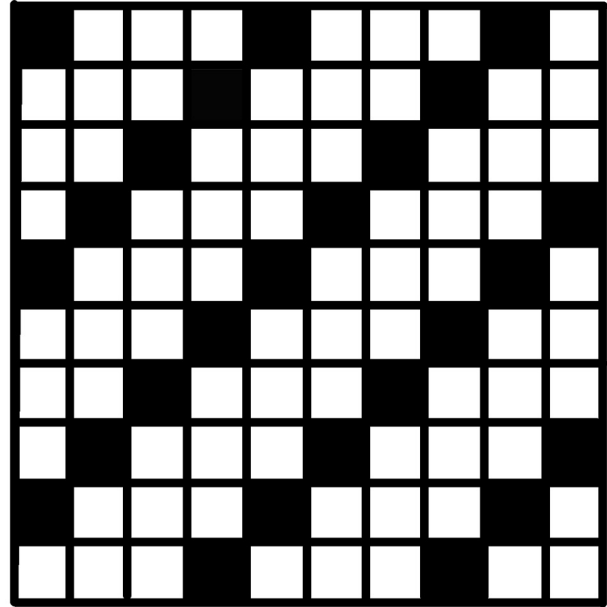
29. Ael. Herod., *Partitiones* 84.4 (Boissonade 1963).

30. Nonnus, *Dionysiaca* 24.257 (Keydell 1959); Hesychius, *Lexicon* K681.1 (Latte 1996); Eustathius 1.265.19 (Stallbaum 1970).

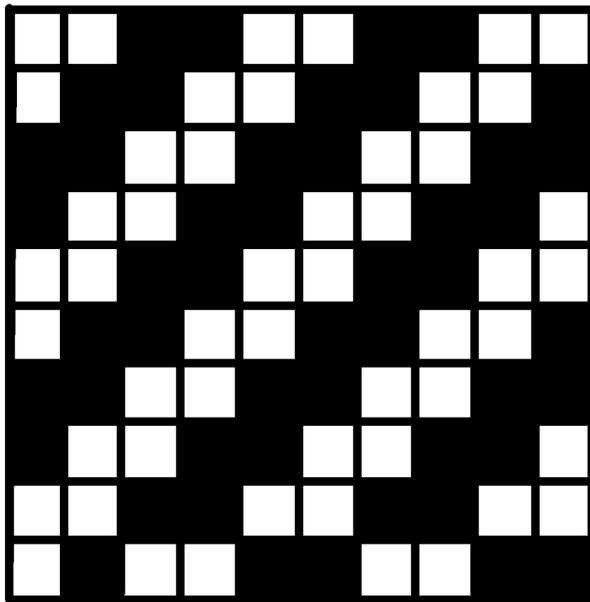




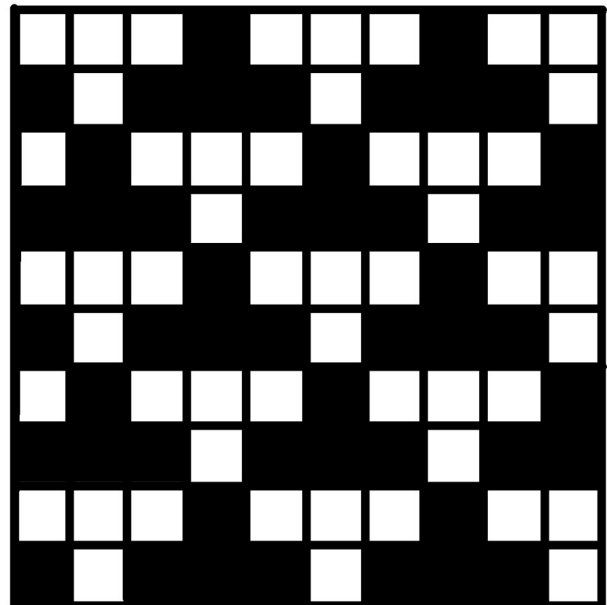
**Fig. 3.** Drawing of 2:1 twill, z, weft-faced. Drawing S. Spantidaki, after CIETA, 1997.



**Fig. 5.** Drawing of 3:1 twill, z, weft-faced. Drawing S. Spantidaki, after CIETA, 1997.



**Fig. 4.** Drawing of 2:2 twill, z. Drawing S. Spantidaki, after CIETA, 1997.



**Fig. 6.** Drawing of weft-faced compound twill. Drawing S. Spantidaki, after CIETA, 1997.

*τριμίτινος*, could refer to a weave using three heddle bars, the twill 2:2, or 3:1 (Fig. 4 and 5). The medieval term *έξάμιτον* refers to samite - weft faced compound twill (Fig. 6).

A brief remark on the term *έξάμιτος*. The weaving

unit of weft faced compound twill is 6:1; so it appears that this weaving term has been named after its number of floating warp threads, which in this case, are six. We could assume that the meanings of the terms *δίμιτος* and *τρίμιτος* and *τριμίτινος* are in the same



**Fig. 7.** Bed covering, or mattress, depicting a diamond twill pattern with a white dot in the centre. Crater of the Laodamia painter, British Museum, Museum no. 1870,0710.2. © The Trustees of the British Museum.

direction. In this hypothesis, the term *δίμιτος* could refer to twill 2:1, while the terms *τρίμιτος* and *τριμίτινος* to twill 3:1. In this case, the term *μιτος* refers to floating threads, not the heddles of the loom.

Finally, I can only associate the ancient Greek term *πολύμιτος* with complex weaves using several heddle bars, such as ‘taqueté’ (weft faced compound tabby).<sup>31</sup>

There is no material evidence of twill textiles in Greece: none of the discovered fragments of Greek archaeological textiles is woven in twill. Furthermore, depictions of weaving looms in Greek iconography do not show traces of mechanical shedding; at best, one can recognize one heddle bar, *κανών*, which was necessary for weaving a tabby.

Classical depictions of clothing on vases and sculptures usually show plain fabrics with stripes or small-scale geometric patterns, or fabrics decorated with complex designs. Diagonal lines that possibly

represent twill variations are rare and they seem to be more common on depictions of furniture (Fig. 7). In contrast to this, Archaic iconography (6<sup>th</sup> century BC) depicts more often garments decorated with patterns that may refer to twill.<sup>32</sup> If these depictions can actually be connected to twill, they indicate that twill was known in the ancient Greek world.

What does this linguistic information mean for the use of twill in Classical Greece? All surviving textiles from Greece derive from funeral contexts, consequently, their corpus is not characteristic of the textile production in this period. We are not familiar with the real variety of garments and utilitarian textiles used, only with those chosen to accompany the dead in the grave. Yet, the absence of terms connected to twill garments in Classical literature and in catalogues of dedications of textiles, such as the Brauron Clothing Catalogues, may indicate that

31. Barber 1991, 268, n. 7; Pl. *N. H.* 8.196; Wild & Dross-Krüpe 2017.

32. As an example, see Archaic attic vases in the British Museum, Museum numbers: 1843,1103.77; 1843,1103.100.x; 1867,0508.949; 1868,0610.3.

twill was not commonly used in Greece during this period.

### *Mitos = relation to felt?*

Lastly, in Classical literature there seems to be a connection between the terms *τρίμιτος* and *τριμίτινος* and felt. Two in four known mentions of *τρίμιτος* and one in three references of *τριμίτινος* are indeed related to felt products, hats or shoes.

ἀλλὰ τρίμιτος ἔστι πῖλος<sup>33</sup> - *trimitos* felt

ὕμεῖς δ' ἐὰν ἰπίσκον ἢ τρίμιτον ἔχητε<sup>34</sup>  
(πῖλον;) - if you have a head ornament or  
a *trimitos* felt

καὶ δὴ ποδεῖα τριμίτινα<sup>35</sup> - *trimitina* felt  
shoes indeed

A *τρίμιτος πῖλος* (felt) would have been a sort of felt created either with three *μίτοι* or with a *τρίμιτος* / *τριμίτινος* fabric. In view of that, according to the third theory the terms *τρίμιτος* / *τριμίτινος* refer to twill fabrics, a *τρίμιτος* / *τριμίτινος πῖλος* would refer to a felt created from a twill fabric.<sup>36</sup> According to Elizabeth Barber, this felt could also have three (perhaps decorative) loops on it.<sup>37</sup> According to a third interpretation, it could be a sort of felt created with three different layers, either by different coloured felts or by different fabrics. Additionally, the term *δίμιτος* also seems to be related to a felt hat.<sup>38</sup>

### Conclusion

The above hypotheses show that the various meanings of the term *μίτος*, both synchronically and diachronically, reflect the characteristic polysemy of Greek. They also underline the fact that semantics and production techniques evolve and change through time. So each term of the *μίτος* family could, during the same period, have more than one meaning simultaneously. Yet at the same time, a meaning could replace

another, as the semantics changed. In other words, the interpretation theories could coincide in certain periods, with the term *μίτος* having more than one meaning at the same time. But they could also replace one another, as the meaning changed through time. Hopefully, new finds will narrow down the semantic field and help elucidate the meanings of this family of terms.

### Ancient Sources

- Agapitos P. A., Hult K. & Smith O. L. (1999) *The Byzantine Achilleid. The Naples Version*. Wiener Byzantinistische Studien 21. Vienna.
- Beckby H. (1965) *Anthologia Graeca, vol. 1*. Munich.
- Boissonade J. F. (1963) *Herodiani partitiones*. Amsterdam.
- Bompaire J. (1964) *Actes de Xéropotamos*. Archives de l' Athos III. Paris.
- Casson L. (1989) *The Periplus Maris Erythraei*. Princeton.
- Dieten van J. (1975) *Nicetae Choniatae historia*, pars prior, Corpus Fontium Historiae Byzantinae. Series Berolinensis 11.1. Berlin.
- Gautier P. (1984) Le typikon du sébaste Grégoire Pakourianos, *Revue des études byzantines* 42, 5-145.
- Guillou A., Lemerle P., Papachryssanthou D. & Svoronos N. (1979) *Actes de Lavra. III. De 1329 à 1500*. Archives de l' Athos VIII. Paris.
- Jeffreys E. & Papathomopoulos M. (1996) *Ὁ πόλεμος τῆς Τρωάδος*. Βυζαντινὴ καὶ Νεοελληνικὴ Βιβλιοθήκη 7. Athens.
- Keydell R. (1959) *Nonni Panopolitani Dionysiaca, 2 vols*. Berlin.
- Kassel R. & Austin C. (eds.) (1983) *Poetae Comici Graeci (PCG), Vol. IV, Aristophon – Crobylus*. Berlin-New York.
- Kassel R. & Austin C. (eds.) (1986) *Poetae Comici Graeci (PCG), Vol. V, Damoxenus – Magnes*. Berlin-New York.
- Kassel R. & Austin C. (eds.) (1989) *Poetae Comici Graeci (PCG), Vol. VII, Menecrates – Xenophon*. Berlin-New York.

33. Lyssipp. *Fr.* 3 (3) (PCG V 1986).

34. Cratinus *Fr.* 5.1 (Kock 1888).

35. Crates *Fr.* 41 (34) (PCG IV 1983).

36. Barber 1991, 197.

37. For discussion see Barber 1991, 268, note 7.

38. Barber 1991; LSJ, s.u.

- Kock T. (1888) *Comicorum Atticorum fragmenta*, vol. 3. Leipzig.
- Kravari V., Lefort J., Métrévéli H., Oikonomidès N. & Papachryssanthou D. (1990) *Actes d'Iviron II. Du milieu du XI<sup>e</sup> siècle à 1204*. Archives de l'Athos XVI. Paris.
- Latte K. (1996) *Hesychii Alexandrini Lexicon*, vol. 1-2. Copenhagen.
- Lycophron (2008) *Alexandra*. Texte établi et traduit par A. Hurst en collaboration avec A. Kolde. Paris.
- Mette H. J. (1959) *Die Fragmente des Tragödien des Aischylos*. Berlin.
- Monro D. B. & Allen T. W. (1963) *Homer, vol. 1-2, Ilias Books I-XXIV*. Oxford.
- Müller C. (1975) *Fragmenta historicorum Graecorum*, 4 vol. Frankfurt.
- Nauck A. (1964) *Tragicorum Graecorum fragmenta*. Hildesheim.
- Page D. L. (1972) *Aeschylus Septem Quae Supersunt Tragoedias*. Oxford.
- Pétridès S. (1909) Jean Apokaukos, Lettres et autres documents inédits, *Izvestija Russkago Archeologiceskago Instituta v Konstantinopole* 14, 69-100.
- Pliny (1956) *Natural History, vol. III. Libri VIII-XI*. T. E. Page et al. (eds.), H. Rackham (transl.), London.
- Schoff W. H. (tr. & ed.) (1912) *The Periplus of the Erythraean Sea: Travel and Trade in the Indian Ocean by a Merchant of the First Century*. London-Bombay-Calcutta.
- Stallbaum G. (1970) *Eustathii archiepiscopi Thessalonicensis commentarii ad Homeri Odysseam*. Hildesheim.
- Tannery P. (1920) *Sciences exactes chez les Byzantins*. Mémoires scientifiques 4. Paris.

## Bibliography

- Barber E. J. W. (1991) *Prehistoric Textiles: the development of cloth in the Neolithic and Bronze Age with special reference to the Aegean*. Princeton .
- Blümner H. (1912) *Technologie und Terminologie der Gewerbe und Künste bei den Griechen und Römern*. Hildesheim.
- Castoriadis C. (1999) *Figures du pensable*. Paris.
- CIETA (1997) *Tracés techniques*. Lyon.
- Lang M. (1908) *Die Bestimmung des Onos oder Epinetron*. Berlin.
- Metallinou G., Moulh erat C. & Spantidaki Y. (2009) Archaeological textiles from Kerkyra, *Arachne* 3, 30-51.
- Moulh erat C. & Spantidaki Y. (2009) Archaeological textiles from Salamis: a preliminary presentation, *Arachne* 3, 16-29.
- Moulh erat C. & Spantidaki Y. (in press) Textile Remains. In I. Lemos (ed.), *Lefkandi IV*.
- Petersen E. (1892) Funde, *R omische Mitteilungen* 7, 174-196.
- Schr oder O. (1884) Zu den Webst uhlen der Alten, *Arch ologische Zeitung* 42, 169-180.
- Spantidaki S. (2016) *Textile Production in Classical Athens*. Ancient Textiles Series 27. Oxford.
- Spantidaki Y. & Moulh erat C. (2012) Greece. In M. Gleba & U. Mannering (eds.), *Textiles and Textile Production in Europe: From Prehistory to AD 400*, 185-200. Ancient Textiles Series 11. Oxford.
- Wild J. P. & Dross-Kr upe K. (2017), *Ars polymita, ars plumarum: the Weaving Terminology of taquet e and tapistry*. In S. Gaspa, C. Michel & M.-L. Nosch (eds.), *Textile Terminologies from the Orient to the Mediterranean and Europe, 1000 BC to 1000 AD*, 301-320. Lincoln, Nebraska.

## Sabellic Textile Terminology

Peder Flemestad and Birgit Anette Olsen

**D**espite numerous recent studies of Italic textiles and textile production etc., no systematic study has so far been attempted regarding the textile terminology of Italic languages besides Latin. The present study seeks to remedy this, making a first step into the textile terminology of Sabellic languages, predominantly Oscan and Umbrian.<sup>1</sup>

There are two types of sources for Sabellic textile terminology: inscriptions and glosses in Greek and Latin literature. Both are, however, fraught with uncertainties. The glosses, as for example seen in the case of Etruscan, may have been misunderstood or misinterpreted and should be treated with due caution, and there is considerable debate on many of the epigraphically attested terms and significant doubt about their precise interpretation. Glosses are especially

problematic, since they have been transmitted to us through a succession of manuscripts. As noted by Clackson, it is only through epigraphy that we can access the texts, and therefore the terms themselves, directly.<sup>2</sup> Sometimes, however, the glosses are indeed correct, making their investigation important.

The extant Sabellic corpus, although minuscule compared to Latin, is nevertheless linguistically invaluable and offers complementary evidence of the Indo-European and Italic textile lexicon, although many aspects of the various Sabellic languages are notoriously difficult to interpret and remain a matter of debate. The present contribution does not claim to endorse the interpretation of the most doubtful cases, but includes them in order to provide an overview of Sabellic terms that have been suggested by scholars as belonging to the domain of textiles.<sup>3</sup>

1. References to Sabellic inscriptions follow Untermann 2000. In the case of Umbrian, references, e.g. “VIIa 24”, are to the Iguvine tables. Translations of the Iguvine Tables are, unless otherwise noted, adapted from Poultney 1959. Bold font, following scholarly convention, indicates terms attested in the “native” alphabets, while italics indicate those attested in the Latin alphabet. Translations of Greek and Latin texts are, unless otherwise noted, adapted from the Loeb editions when available. For the term Sabellic, cf. Rix 2002, 2: “Der Terminus entspricht den oben genannten Forderungen: er ist einfach und gut motiviert. *Sabellī* (\**Saβello-*) ist der einheimische Name, mit dem die Römer die Samniten, manchmal auch undifferenziert alle zentralappenninischen Bergstämme genannt haben; er ist das Individuativum zu \**Saβno-* (\**Saβno-lo-* > \**Saβnlo-* > \**Saβenlo-* > \**Saβello-*; Typ *Graeculus*, *Poenulus*), das vielleicht der ursprüngliche Name der ganzen Sprachgruppe war [...]. Von \**Saβno-* ist der Name \**Saβniom* abgeleitet, der für das Stammland der oskischen Gruppe bekannt ist (osk. *Safnim*, lat. *Samnium*, griech. Σάυνιον), und von diesem wiederum das Ethnikon *Saβīno-* (dissimiliert aus \**Saβnīno-*), das als *Safinūs* die Sprecher des Südpikenischen und als *Sabīnī* Roms nördliche Nachbarn bezeichnet (ein Teil der \**Saβīnōs* wäre dann später *Umbri* genannt worden).”

2. Clackson 2014, 700.

3. Of Sabellic terms that are not “Sabine”, Oscan or Umbrian, the only item of interest is South-Picene **tokam**, which, while formally

### The textile terms

#### Oscan:

There are exiguously few terms attested in the Oscan group of Italic dialects, but there are occasional references in Greek and Latin sources to Samnite dress,<sup>4</sup> and there have been studies of the iconographical material.<sup>5</sup> Presumably, only one epigraphically attested Oscan term belongs to the domain of costume:<sup>6</sup>

O. **plavtad**:<sup>7</sup> A feminine *-ā*-stem noun, designating the sole of a shoe or a foot, a substantivization of Proto-Italic *\*plauto-* ‘flattened, with flat feet’, apparently derived from the Italic root *\*plau-* (‘to hit/step with the palm of the hand or foot’) from *\*plh<sub>2</sub>-u-* (‘palm of the hand, sole of the foot’), with the suffix *-to-/-tā-* (cf. Latin *plautus* ‘flat-footed’<sup>8</sup> and *plaudere* ‘to clap, strike, beat (with the palm

of the hand)’; Umbrian *preplotatu, preplohottatu* ‘must crush, stamp down’, *semiplotia* (Festus) ‘shoe-soles divided into halves’). According to Franchi de Bellis it is a cognate of Greek βλαύτη and means ‘sandal’.<sup>9</sup>

**hn. sattiéis. deffri  
seganatted. plavtad**<sup>10</sup>

“Deffri of Herens Sattiis left her mark  
with her sole.”

The bilingual inscription is found on a large terracotta tile (94x66cm) and is dated to *c.* 100 BC. The verb states that it was marked/signed with the ‘sole’, and the imprints are also preserved. The interpretation of the term therefore depends on the imprints on the terracotta itself, and these clearly indicate footwear, not feet.<sup>11</sup> The imprints are moreover similar in shape and size to extant Etruscan wooden/bronze sandals.<sup>12</sup>

---

corresponding to Latin *toga*, means ‘grave’. As argued by Marinetti (1985, 144, n.93) and followed by Adiego (1995, 136), the grave is understood as that which covers, from the same root as Latin *toga*: *\*(s)teg-/ (s)tog-* ‘to cover’. It is, however, interesting to note that according to Juvenal (3.172, cf. Watkins 1969: 238 and Olsen 2016, note 31), the use of a toga was closely linked to burials: *pars magna Italiae est ... in qua nemo togam sumit nisi mortuus* ‘there is a large part of Italy ... where nobody puts on a toga unless he is dead’; this provides a clear connection between toga and grave, and although speculative does not exclude the possibility of another type of semantic extension. Outside Sabellic (and Latin) the only attested Italic textile term is Tusculan *struppum* (corresponding to *stroppus/στρόφος*) and the Faliscan feast *Struppearia*, Festus 410, 6-7 (cf. Pliny *NH* 21,3), see Biville 1990, 176-178; Adams 2007, 177.

4. Strabo 6.1.2; Livy has two mentions of Samnite dress: 9.40, 10.39.11-12.

5. Weege 1909, especially 158-162; Schneider-Hermann 1996, especially 4-39, 95-106.

6. Cf. below under Umbrian fibre sources for Oscan *καποροιννα*[ι].

7. Abl.sg. (Pocc.21/ Sa 35, Pietrabbondante); Untermann 2000, 563.

8. Festus 274 (Lindsay): *<Plotos appellant> Umbri pedibus planis <natos. Hinc soleas dimidiatas, qui>bus utuntur in venando, <quo planius pedem ponant, vo>cant semiplotia et . . . <Macci>us poeta, quia Umber Sarsinas erat, a pedum planitia initio Plotus, postea Plautus coeptus est dici* ‘The Umbrians called those born with flat feet *ploti*. Thence they term *semiplotia* the soles that are divided into halves which are used in hunting to put the foot more flatly ... The poet Maccius, who was an Umbrian from Sarsina, was initially called Plotus, later Plautus, from the flatness of his feet’; P. ex F. 275 (Lindsay): *Ploti appellantur, qui sunt planis pedibus. Unde et poeta Accius, quia Umber Sarsinas erat, a pedum planitie initio Plotus, postea Plautus est dictus. Soleas quoque dimidiatas, quibus utebantur in venando, quo planius pedem ponerent, semiplotia appellabant* ‘Those who have flat feet are called *ploti*. Wherefrom also the poet Accius, who was an Umbrian from Sarsina, was called initially Plotus, later Plautus, from the flatness of his feet. They also call the soles that are divided into halves, which are used in hunting because they set the foot more flatly, *semiplotia*’.

9. See Franchi de Bellis 1992, 14. There is no need to follow Schwyzler (1968, I. 61) who places it in the ‘ägäisches Substrat’, nor Beekes (2010, 219), who classifies it as ‘Pre-Greek’ on account of the variation τ ~ δ (*i.e.* in βλαῦδες, Hsch.); it is an Italic loanword, cf. below.

10. Tr. Clackson 2014, 715, modified. The Latin inscription reads *Herenneis Amica | signavit q(u)ando | ponebamus tegila* ‘Amica of Herens left her mark when we were making tiles’.

11. Cf. Franchi de Bellis 1992, 14: ‘indubbiamente il senso di ‘sandalo’/‘suola’/‘calzare’; Clackson 2014, 715: ‘two sets of prints made by women’s shoes’. There are also clearly visible imprints of the nails of the shoes.

12. See *e.g.* Bonfante (2003) 203, pl. 140; the sandals have a maximum length of *c.* 25cm, corresponding rather well to the approximately 21-22cm of the imprints in the inscription.

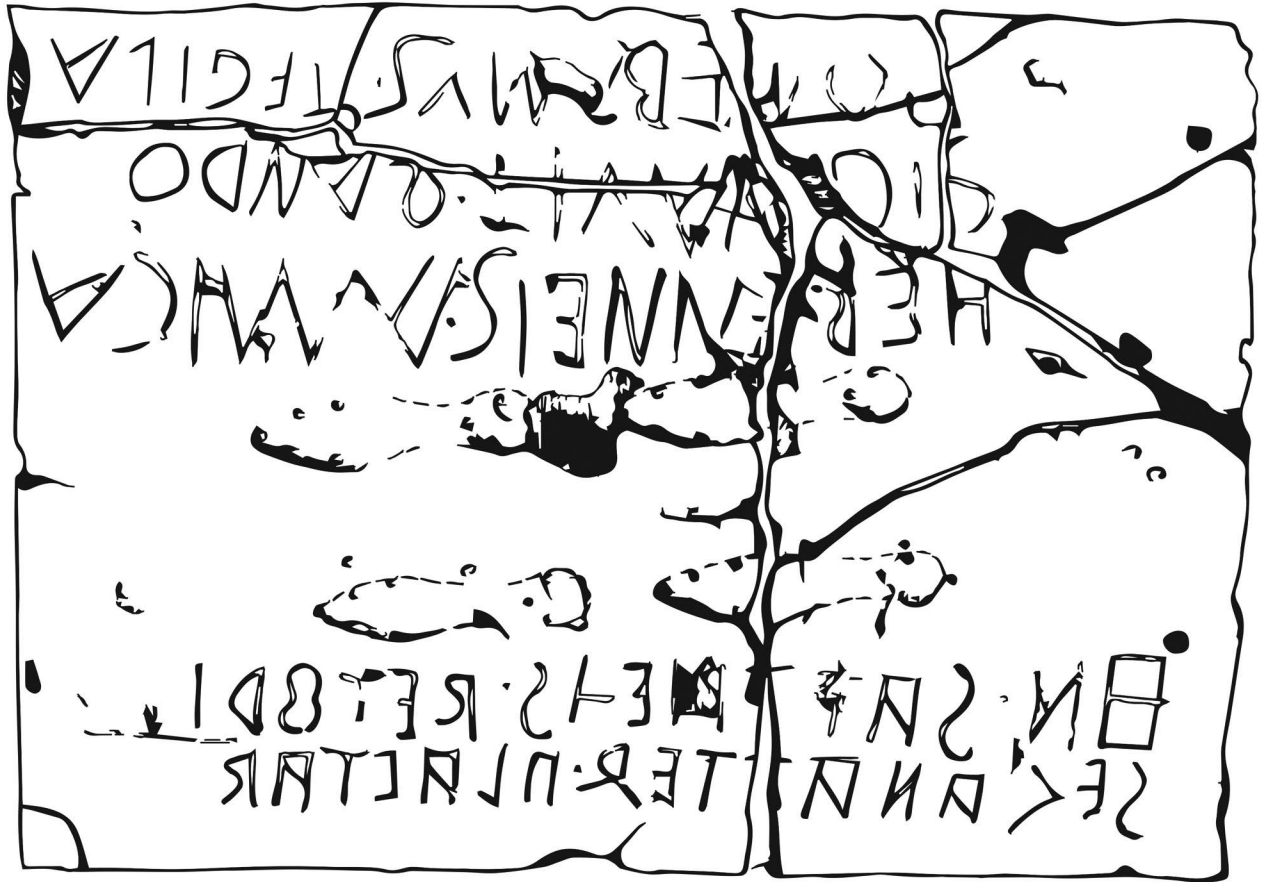


Fig. 1. Pocc.21/Sa 35, Pietrabbondante, adapted from La Regina, Lejeune & Prodocimi 1976, 285.

Sandals were common footwear also in Greece, and Greek βλαύτη, while also denoting footwear of fine quality,<sup>13</sup> specifically refers to a distinct type of sandal (σανδαλίου τι εἶδος).<sup>14</sup> For phonological reasons βλαύτη cannot be an inherited word in Greek, and Italian *piota* ‘sole of the foot’ suggests that *plauta* meant ‘sole’ in Vulgar Latin dialects, with the further semantic development to ‘sole of a shoe or sandal’ in Oscan.<sup>15</sup> It is interesting that in 5th century Athens the so-called Etruscan sandals were considered luxury

articles that were either imported from Etruria or imitated Etruscan models.<sup>16</sup>

While thick soles were “extremely common throughout the Greek world”,<sup>17</sup> this was also a feature of the Etruscan sandal, characterised by Pollux as wooden, with gilded straps.<sup>18</sup> In addition, Etruscan sandals were characterized by a hinged sole, consisting of two separate wooden pieces framed by a bronze or iron frame and these movable parts followed the movement of the foot, making it easier to

13. Attested from the fifth century onwards, e.g. Plato *Symp.* 174a. Cf. Athen. 12.548c.

14. Pollux 7.87.

15. Ernout (1909, 216) posits two forms: one dialectal (with monophthongization of the diphthong *au* to *ō*, regular in Umbrian), the second is the one preserved in the Romance languages (e.g. Italian *piota*).

16. Bonfante 2003, 59.

17. Bonfante 2003, 59.

18. Pollux 7.92-93.

walk on the thick wooden soles.<sup>19</sup> These two halves conform to the *semiplochia* (*soleas dimidiatas*) in the Festus passage quoted above. Greek βλαύτη is apparently a *Wanderwort*, either from Greece to Italy, or *vice versa*, but it cannot be an inherited word in Greek, since *b > p* is unattested in Greek loanwords, while *p > b* is well documented.<sup>20</sup> In particular, the use of β for π is attested in both the Greek of Magna Graecia<sup>21</sup> (Taras, modern Taranto) and Sicily.<sup>22</sup> For Taras this feature has been explained as due to the influence of Illyrian and Messapic languages spoken by people from the Balkans.<sup>23</sup> Greek βλαύτη is therefore presumably a loanword from Italic,<sup>24</sup> and Oscan **plauta-** is accordingly an indigenous Italic word, which in Southern Italy (possibly through the influence of Messapic/Illyrian) provided the Greek word.

There are also two Oscan glosses that concern textiles, both attested in Varro:<sup>25</sup>

O. *asta*:

Varro *DLL* 7.54: in *Men*<a>*echmis*: “*inter ancillas sedere iubeas, lanam carere.*” *idem hoc est verbum in Cemetria* *N*<a>*evii. carere a carendo, quod eam tum purgant ac deducunt, ut careat spurcitia; ex quo carminari dicitur tum lana, cum ex ea carunt quod in ea h*<a>*eret neque*

*est lana, quae in Romulo N*<a>*evius appellat asta ab Oscis.*

“In *The Menaechmi* (*Men.* 797): “Why, you’d bid me sit among the maids at work and card the wool.” This same word *carere* ‘to comb/card’ is known from the *Cemetria* of Naevius: “*Carere* is from *carere* ‘to lack’, because then they cleanse the wool and spin it into thread, that it may *carere* ‘be free’ from dirt: from which the wool is said *carminari* ‘to be combed/carded’; then when they *carunt* ‘comb/card’ out of it that which sticks in it and is not wool, those things which in the *Romulus* Naevius calls *asta*, from the Oscans.”

Unfortunately, the term *asta* is not treated by Untermann, since it is a gloss. Varro’s etymology is of course incorrect and *carere* is corrected by modern editors to *carrere* (from Proto-Italic *\*kars-e-* from the PIE root *\*(s)ker-s-*). The verb means ‘to card/comb (wool)’ and this poses problems in the interpretation of the Oscan gloss. It is translated by Conway as “wool-cardings, *sordes*” and is assigned by him to the glosses “whose form is less certain, and which, though assigned to Oscan, show no specifically Oscan characteristics”.<sup>26</sup> Fay suggested the following etymology: “Oscan *asta* (= ‘pile, nap’): With *asta* (n.

19. Bonfante 2003, 60.

20. E.g. πυρρός vs *burrus*; πύξος vs *buxus*.

21. Hsch. s.v.: “βυτινή λαγυνος ἢ ἀμῖς, Ταραντινοί” (corresponding to Attic πυτινή); according to Beekes, the interchange π/β proves Pre-Greek origin, the variation voiced/voiceless being extremely frequent in such words. Vulgar Latin *butina* is, according to Santoro (1975, 68-69), borrowed from the Tarentine dialect (according to Beekes, simply from “the Greek”).

22. Hsch. s.v.: “<βατάνια>· τὰ λοπάδια. ἢ δὲ λέξις Σικελική”; Hsch. s.v. “<πατάνια>· τὰ ἐκπέταλα λοπάδια, καὶ τὰ ἐκπέταλα καὶ φιαλοειδῆ ποτήρια, ἃ <πέδαχνα> καλοῦσι. τινὲς δὲ διὰ τοῦ <β> <βατάνια> λέγουσιν”. While we are told by Plutarch that the Delphians pronounced β for π, this is not attested in the epigraphical material other than vacillation in the name and *ethnikon* of the Boiotian *polis* Λεβάδεια and of Ἀμβράκια in Epirus; see Rüschi 1914, 187-188. Cf. Plut. *Mor.* 292E: ὁ δὲ βύσιος μῆν, ὡς μὲν οἱ πολλοὶ νομίζουσι, φύσιός ἐστιν· ἕαρος γὰρ ἄρχει καὶ τὰ πολλὰ φύεται τηνικαῦτα καὶ διαβλαστάνει. τὸ δ’ ἀληθὲς οὐκ ἔχει οὕτως· οὐ γὰρ ἀντὶ τοῦ φ τῷ β χρωῖνται Δελφοί, καθάπερ Μακεδόνες ‘Βίλιππον’ καὶ ‘βαλακρόν’ καὶ ‘Βερονίκην’ λέγοντες, ἀλλ’ ἀντὶ τοῦ π· καὶ γὰρ τὸ πατεῖν ‘βατεῖν’ καὶ τὸ πικρόν ‘βικρόν’ ἐπεικῶς καλοῦσιν.

23. Cf. Santoro 1975, 68-70. This is also evident in the names of Metapontum (Μεταπόντιον) which was earlier Μέταβον, interpreted as Messapic by Kretschmer 1925, 92-93, and followed by Biville 1990, 239-240 (cf. Antiochos *apud* Strabo 6.1.15: τὴν πόλιν Μεταπόντιον εἰρησθαι πρότερον Μέταβον, παρωνομάσθαι δ’ ὕστερον; Steph. Byz. *Ethn.* s.v. Μεταπόντιον: τὸν γὰρ Μεταπόντιον οἱ βάρβαροι Μέταβον).

24. Cf. the discussion in Franchi de Bellis 1992, 12-14.

25. One could add one from the domain of jewelry: *ungulus* ‘ring’ in Festus 375 (Müller): *ungulus Oscorum lingua anululus*, and Plin. 33, 1,4,10: (*anulum*) *apud nos prisci ungulum vocabant*; see Adams 2007, 180.

26. Conway 1897, 231.



plur.) cf. its Greek synonym ἔξαστις. The startform may have been adstho-/adsthis ‘adstans’ (cf. ad ‘up’ in ad-surgit?); or an(a)stho- etc. cf. Osc. a(n)stintu.”<sup>27</sup>

While *asta* in either interpretation is not a clear synonym of ἔξαστις, its potential connection with ἔξαστις is, however, interesting: Beekes (*s.v.*) suggests it may simply mean “what sticks out” and refers to a new etymology proposed by Van Beek,<sup>28</sup> who proposes a connection between ἄττομαι and Hittite *hatt-*<sup>(ri)</sup> ‘to pierce, prick’, reconstructing *\*h<sub>2</sub>et-ie/o*.<sup>29</sup> A card or comb of course consists of piercing/pricking points, so Oscan *asta* would be a neuter plural perfect participle passive “that which has been carded, ‘pricked out’, *vel sim.*”, conforming to the statement of the gloss that the wool is carded to remove that which sticks in it and is not wool.

O. *supparus*:

Varro *DLL* 5.131: *Indutui alterum quod subtus, a quo subucula; alterum quod supra, a quo supparus, nisi id quod item dicunt Osce.*

“One kind of put-on goes *subtus* ‘below’, from which it is called *subucula* ‘undershirt’; a second kind goes *supra* ‘above’, from which it is called *supparus*, unless this is so called because they say it in the same way in Oscan.”

Contrary to Varro’s definition, the *supparus* or *supparum* was not a garment worn “above”, but rather an undertunic that appears to have been worn by or associated with the costume of the young girl.<sup>30</sup> According to Conway, the doubling of *p* before *r* and the anaptyctic vowel both indicate a genuine Oscan word, but he adds that “the *-a-* is only intelligible if

the final syllable contained *-a-* *i.e.* if the word was an *-a-* stem”.<sup>31</sup> The Oscan connection is further elaborated in Walde: “ist entweder osk. Vermittlung anzunehmen, oder Entlehnung des gr. Wortes in das Lat. und Osk”,<sup>32</sup> and Ernout: “*Supparus* est emprunté du gr. σίπαρος, σίφαρος, comme l’a reconnu Varron, par un intermédiaire osque dans lequel le groupe *-ar-* en syllabe intérieure ne subissait pas l’apophonie. Si σίφαρος avait été emprunté directement par le latin, il aurait abouti à *\*supperus*, comme σίσαρον à *siser*; *u* de *supparus* est dû à un faux rapprochement avec *supra*. On trouve aussi dans les auteurs *siparum*, *sipharum*, *sipharus*, *siparium* qui sont de simples transcriptions littéraires du grec”.<sup>33</sup> However, as pointed out by Housmann, the treatment of *supparus*, *supparum* and *siparum* etc. as a single term is misleading, though the ultimate source must be the same: “Facts tell another tale. These are two words, distinct both in form and in significance and one of them makes its appearance more than two centuries earlier than the other.”<sup>34</sup>

*Supparum*, *supparus*, attested since Plautus, is originally a garment, while *sip(h)arum* denotes a kind of sail, and it was only at a later stage that the distinction between the two was lost. Most likely, both terms have been borrowed from Greek, *siparum* as a late, transparent rendering of Gk. σίφαρος/σίπαρος ‘sail’, and *supparus*, *supparum* transmitted through Oscan as seen from the vocalism: *-a-* without the Latin weakening to *-e-* in unaccented syllables, and *-u-* probably triggered by the following labial as in other examples from Sabellic, *e.g.* Oscan *amprufid* ‘wrongfully’, *pertumum* ‘prevent’, Umbrian **prehubia** ‘provide’. The term *supparus* is therefore clear evidence of Oscan influence on Latin textile terminology, and it is itself a loanword from Greek, *i.e.* through the colonies in Magna Graecia.

27. Fay 1914, 256.

28. *Apud* Beekes (2010: 167) *s.v.* ἄττομαι.

29. Greek ἄσμα ‘warp’, moreover, apparently has an exact parallel in Armenian *azbn*, see Olsen, this volume, 193.

30. Olson 2003, 202-203; Olson 2008, 143.

31. Conway 1897, 220.

32. Walde-Hofmann II: 633.

33. Ernout 1909, 235.

34. Housmann 1919, 149. It should, however, also be noted that the connection between web and sail is readily apparent in Greek terminology; see Nosch 2015.

*Hernican:*

Hernican is part of the Oscan group.<sup>35</sup> Virgil briefly describes the military dress of the Hernici in the *Aeneid*,<sup>36</sup> but the only attested dress term is found in Fronto, *Ad M. Caesarem et Invicem* 4.4.1:

O. *samentum*:

*Deinde id 'oppidum anticum' vidimus, minutulum quidem, sed multas res in se antiquas habet, aedes sanctasque caerimonia<s> supra modum. Nullus angulus fuit, ubi delubrum aut fanum aut templum non sit. Praeterea multi libri lintei, quod ad sacra adtinet. Deinde in porta, cum eximus, ibi scriptum erat bifariam sic: "Flamen sume samentum". Rogavi aliquem ex popularibus quid illud verbum esset. Ait lingua Hernica pelliculam de hostia, quam in apicem suum flamen cum in urbem introeat inponit.*

"Then we inspected that ancient township, a tiny place, indeed, but containing many antiquities and buildings, and religious ceremonies beyond number. There was not a corner without its chapel or shrine or temple. Many books too, written on linen, and this has religious significance. Then on the gate, as we came out, we found an inscription twice over to this effect: "Priest,

don the fell". I asked one of the townsmen what the last word meant. He said it was Hernican for the pelt of the victim, which the priest draws over his peaked cap on entering the city." [Tr. van den Hout]

The term *samentum* 'fell' is occasionally mentioned in recent literature; given that the rest of the inscription is in Latin, it is presumably a technical term, preserved due to conservatism in religious language.<sup>37</sup> Apart from a slight modification of the protoform to "*sacsmentum*" (cf. *lūmen* 'light' < \**le/ouksm̥n*), the explanation of Bücheler<sup>38</sup> has been accepted by Walde-Hofmann and, with hesitation, also by Ernout & Meillet.<sup>39</sup> The underlying root is probably that of Latin *sacer*, Umbrian **sacru** etc. 'holy', with extra-Italic cognates in Germanic, cf. Old Norse *sátt* 'treaty', and Hittite *šāklāi-/šākli-* 'custom, rule, law; rite, ceremony'.<sup>40</sup>

*Umbrian:**Umbrian clothing terms:*

There are a number of passages including more or less secure textile and clothing terms in the Iguvine Tables:<sup>41</sup>

Vlb 49-51: *ape angla combifianśiust perca arsmatiam anouihimu. Cringatro hatu destrame scapla anouihimu. Pir endendu. Pone | esonome ferar [aes esonomffrar],*

35. Cf. Rix 2002, 6.

36. Verg. *Aen.* 7.681-690 also describes the hernican military dress as being made of skin.

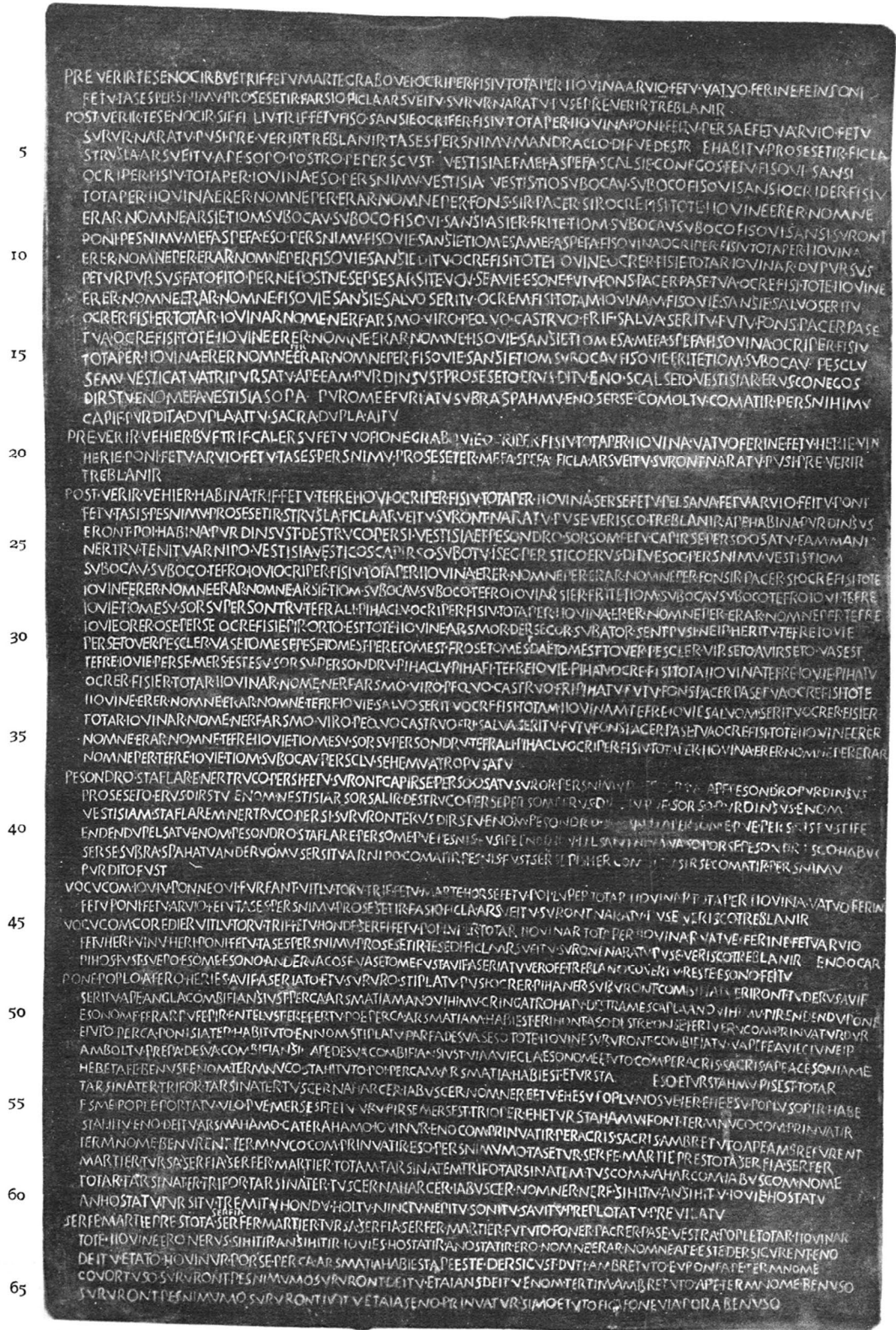
37. Adams 2007: 178-79. See also van den Hout 1999: 164-65.

38. Bücheler 1882, 516-17: "Für die Erklärung des Wortes verweisen unsere Lexikographen und jüngst Weise 'die griech. Wörter im Lat.' S. 510 (wo die Bedeutung falsch angegeben ist) auf griech. σῆμα σῆμα: eine ganz äusserliche, dem Namen- und Begriffssystem italischer Religion nicht angemessene Herleitung. Ich denke es leuchtet allen ein, dass *samentum* nur andere, ächt lateinische Form für *sagmen* ist, wie *segmen segmentum, fragmen fragmentum* u.s.w.; der Guttural, ursprünglich *c*, in *sagmen* zu *g* erweicht, konnte schwinden wie in *lama (lacus) lumen, examen (agmen) flemina (φλεγμαονή)* u.s.w., der *a*-Vocal wird mit Recht als lang angesetzt. Das Wort gehört zu der in meinen lexicon Italicum p. XXIV unter sak- κερῶσαι aufgeführten Sippe, die sehr specificirte Bedeutung des Wortes zu Anagnia erklärt sich aus dem generellen Sinn: Mittel göttlicher Bestätigung, Zeichen der Weihe. Freilich lehrte man uns unlängst, *sagmen* sei desselben Stammes wie *sagina*, sei das Stopfende, Nährende, darum Gras oder Kraut: dagegen der alte dichter bei Festus (trag. inc. 219 R.) *Iovis sacratum ius iurandum sagmine*. Gleichsam legitimirt zum heiligen Dienst wurden in Rom die Fetialen durch Kräuter der Burg, in Anagnia der Opferer durch ein Stück Opferhaut: solche Legitimation hiess *sagmen, samentum*".

39. Walde-Hofmann II: 474; Ernout-Meillet 592.

40. Kloekhorst 2008: 700f.

41. For Umbrian *semplotia*, see above under Oscan **plautad**.



VI b

Fig. 2. Tab. Ig. VIb, which contains many of the textile terms, from Devoto 1937, plate following p. 44.

*pufe pir entelust, ere fertu poe perca arsmatiam habiast. Erihont aso destre onse fertu. Erucom prinuatur dur | etuto, perca ponisiater habituto.*

“When he has announced the auspices he shall put on a (‘striped’) ritual garment, take a band, and place it over his right shoulder. He shall place fire (in the fire-carrier). When that in which he has placed the fire is brought to the sacrifice, he who has the (‘striped’) ritual [?] garment shall carry it; the same shall carry the *aso*<sup>42</sup> on his right shoulder. With him shall go two officials (*prinuati*), they shall have the (‘striped’) garments of the purple-dressed (official).”

U. *anouihimu*<sup>43</sup> ‘to put on (clothing)’, from \**owē-* with the preverb *an-*, derives from Proto-Italic \**ow-e/o-*. The verb is cognate with Latin *-uō* (as in *induere*), and may be denominative to a verbal noun whose formation corresponds to Latin *induviae*, *exuviae*, etc. The PIE root is probably \**h<sub>2</sub>euH-* ‘to put on (especially footwear)’, with cognates in Armenian *aganim* ‘to put on’, Lithuanian *aūti*, Old Church Slavonic *obuti* ‘to put on shoes’ (< \**obuti* < \**(-)outei*), Avestan *aōθra-* ‘shoes’.<sup>44</sup>

U. *cringatro*:<sup>45</sup> The meaning of this word has not been conclusively determined. It is, however, an object worn by sacrificial priest over the shoulder; plausibly interpreted by Buck as a “sort of band worn about the shoulder as a token of office”.<sup>46</sup> Etymologically it derives from \**kring/k-ā-* with the instrument noun suffix *-tro-*, based on a denominative verbal stem and presumably cognate with Old English and Old High German *hring* ‘ring’, as well as Old Church Slavonic *krogъ* ‘circle’.

U. *percam*:<sup>47</sup> in general, this term is interpreted either as a ceremonial staff or a garment. It has possible cognates in Oscan **perēk** (and its abbreviated form **per**), a unit of length, and Latin *pertica* ‘a rod, wand’, from \**pertkā-* < \**pertikā-*.

The term *percam* is the object of the verb *anouihimu* ‘to put on (a garment)’ (cf. above). The semantic extension needed for the “staff” interpretation (“to take up, equip oneself with”) is in itself unproblematic, but Jones argues convincingly based on contextual analysis, especially of V1b 49, where the sequence of actions becomes impractical for the priest if it were a staff, but natural in the case of a garment.<sup>48</sup> Importantly, the interpretations as “staff” or “garment” are not mutually exclusive, since the semantic extension from rod > stripe > stripe on a garment > garment is equally unproblematic and has numerous parallels in ancient languages, e.g. the Sabine *trabea* (cf. below).<sup>49</sup> On this background, we must

42. The term *aso* is so far unexplained, but cf. Untermann 2000, 130: “Auch die Bez. eines Kleidungsstückes oder einer Insignie ist nicht auszuschliessen”, with reference to Meiser 1986, 249: “aso könnte einen sonst nie erwähnten Teil der priesterlichen Tracht bezeichnen”.

43. 3.sg.Imp.II.Passive (V1b 49, twice). Untermann 2000, 112-13.

44. Cf. LIV 275. Hittite *unu-zi* ‘to adorn, decorate, lay (the table)’ is possibly better kept apart. Cf. Kloekhorst 2008: 918-20 on the alternative reconstruction of a root \**h<sub>3</sub>eu-*.

45. Acc.sg. **krenkatrum** (Ib 11), **krikatru** (Ib 27, 29), *cringatro* (V1b 49). Untermann 2000, 404.

46. Buck 1928, 331. Poultney (1959, 271) notes that editors are almost unanimous in translating it “*cingtum*” or “*cingulum*” but that an appropriate English translation for a liturgical garment worn over the shoulder is “stole”. Sabine warriors are said to have worn a golden band around their left arm: Dion. Hal. AR 2.40.

47. Acc.sing. *percam* (V1b 53), *perca* (V1a 19, V1b 49, 50, 63); acc.pl **perkaf** (Ib 15) and *perca* (V1b 51). Untermann 2000, 536.

48. Jones 1964, 271.

49. Cf. Jones 1964, 269, who mentions Virgil *Aen.* 8. 660: *virgatis ... sagulis* “striped ... cloaks”. One may add Silius Italicus, *Punica*, 4,155: *virgatae vestes*; Ovid *Ars Am.*, 3,269: *purpureis ... virgis*. Similarly, Greek *ράβδος* ‘rod’ is used of stripes/borders in clothing, cf. Pollux 7.53: *αἱ μέντοι ἐν τοῖς χιτῶσι πορφυραὶ ράβδοι παρυφαὶ καλοῦνται*. Also of interest is Servius’ commentary to Virgil’s *Aeneid* 8.660, which points to a similar kind of term also in Gaulish. There is of course also the case of *clāvis* ‘nail, peg’ (cf. also *clāva* ‘staff’) > ‘stripe on the tunic’ > ‘tunic’. See Bender Jørgensen 2011 for an attempt to define the *clavi* on Roman textiles.

conclude that the most likely meaning of *perca* ... *anouhimu* must be “he shall put on a (striped) toga/ritual garment”.

- U. *ponisiater*:<sup>50</sup> the term is presumably a substantivized adjective denoting a priestly individual: “the one dressed in the purple striped dress”. It is an attribute of the *perca*, perhaps in the same way as Latin *praetextātus*, “dressed in a purple garment” (cf. also *tunicātus*, *togātus*, *trabeātus*<sup>51</sup>). The morphological analysis thus suggests an adjective in *-āto-* from *\*poinik-jo-* ‘purple’, itself an adjective in *-jo-* derived from *poinik-* ‘Phoenician’. Formations in *-āto-* derived from colour terms are well attested in Latin, e.g. *purpurātus*, *albātus*, *candidātus*, *atrātus*. The *perca ponisiater* should therefore be understood as ‘the (striped) garment of the purple-clad (official)’.<sup>52</sup>

Vib 3-5: *Poni feitu, persae fetu, aruio fetu.*  
| *Surur naratu pusi pre uerir Treblanir.*  
*Tases persnimu. Mandraclo difue destre*  
*habitu. Proseterificla, | struśla arsueitu.*

“He shall sacrifice with mead, perform (the sacrifice) upon the ground, offer grain, recite the same formulas as before the Trebulan Gate, pray silently, have a hand-towel folded double upon his right hand, and add to the parts cut off a *ficla* cake and a *struśla* cake”.

- U. **mantrahklu**:<sup>53</sup> A neuter *-o-*stem denoting an object held by the priest, mostly interpreted like

Latin *mantēlum* ‘hand-towel, napkin’, presumably from *\*man- t<sub>h</sub> tlo-* > *\*man-trā-tlo-*, composed of *\*man-* ‘hand’ and an instrument noun based on the zero grade of the root *\*terh<sub>1</sub>-* ‘to rub’.<sup>54</sup>

Vib 61-63: *“fututo foner pacrer pase ves- tra pople totar Iiouinar, | tote Iiouine, ero nerus sihitir anśihitir, iouies hostatir anostatir, ero nomne, erar nomne”. Ape este dersicurent, eno | deitu “etato Iiouinur”, porse perca arsmatia habiest.*

““Be favourable and propitious with your peace to the people of the state of Iguvium, to their chief citizens in office and not in office (i.e. girded and ungirded), to their young men under arms and not under arms, to their name, to the name of the state”. When they have said this, then he that has the (‘striped’) ritual garment shall say: “Go, men of Iguvium!””.

- U. *śihitu anśihitu*:<sup>55</sup> An *-o-/-ā-*stem adjective whose precise meaning and etymology are uncertain, but is generally presumed to be cognate with Latin *cingere* ‘to surround, gird’, i.e. from *\*kīnk-to-* from a possible Proto-Italic root *\*keng-*, thus referring to girded and ungirded officials. ‘Girded’ presumably refers to the belt or girdle as an emblem of office, symbolically representing the class or status of the official. The following *hostatir anostatir* suggests that these are not soldiers or part of the army.<sup>56</sup> They were presumably

50. Gen.sg.m. *ponisiater* (Vib 51) and **puniçate** (Ib 15). Untermann 2000, 607-608.

51. The *trabea* was also Sabellic, cf. below.

52. Cf. Ancilotti & Cerri 1996, 398.

53. Acc.sing. **mantrahklu** (IIa 19), **mantraklu** (IIb 16) and *mandraclo* (Vib 4). Untermann 2000, 451.

54. LIV 632 and Meiser 1986, 141. Expected full grade neuter *\*ter<sub>h</sub> tlo-* > *\*teraklo-* beside zero grade feminine/collective *\*tr<sub>h</sub> tlo-* > *\*trāklo-*. De Vaan’s hesitant derivation (2008, 614) from the same root as Latin *tergere* ‘to rub clean, polish’ by means of a composite verb in *-ā-*, otherwise only known in connection with preverbs, is formally problematic.

55. Acc.pl masc. *śihitu anśihitu* (Vib 59) and *sihitu ansihitu* (VIIa 48); D.pl masc. *śihitir anśihitir* (VIIa 14, 28, 50), *sihitir anśihitir* (Vib 62) and *śitir anśihitir* (VIIa 13). Untermann 2000, 396-97. Cf. also Meiser 1986, 55.

56. Roman parallels include Festus 251, 19-21 (Lindsay). Cf. Hoss 2011, 29: “Legally, the wearing of arms – especially a sword – at all times in public defined the soldier as such. By extension, the belt to which the sword was fastened became a distinguishing feature of soldierly dress”; Hoss 2011, 30: “The military belt of the Roman soldier can therefore be defined as a symbolic object, both an article of clothing and a piece of military equipment, setting the soldier apart from civilian men and making him a *miles*”. In Late Latin the *cingulum militare* denotes the sword belt or *balteus*, cf. Isid. 19.33.2. There were, however, other types of cincture in Rome, for example the Roman bride was also characterized by a special type of *cingulum*, cf. Festus 55 (Lindsay); public slaves were also defined by a special kind of *cinctus*, cf. Isid. 19.33.4.

rather some kind of religious or political individuals,<sup>57</sup> and there may be a parallel to the *cinctus Gabinus*.<sup>58</sup>

### III 14: *kletre tuplak prumum antentu*

“On the *kletra*<sup>59</sup> first put on the two-fold (cloth)” [Tr. Weiss]

U. **tuplak**:<sup>60</sup> composed of a form of the word for two and a zero-grade derivative of the root *\*pel-* “fold”, interpreted either as a neuter *-ak-* stem from Umbrian *duplo-*, or the accusative singular feminine of the adjective *duplo-* with the clitic particle *-k*.<sup>61</sup> Several interpretations have been suggested of this term, but Weiss argues cogently for the interpretation of Peruzzi, who suggested that the **tuplak-** is a “two-fold cloth”.<sup>62</sup> As stated by Weiss, Greek δῖπλαξ (‘mantle’) almost always has this meaning when substantivized and many *duplex* garments are attested in Latin, notably the *laena*, which is explained by Suetonius as a *toga duplex qua infibulati flamines sacrificiant* “two-fold toga in which adorned with a pin the priests sacrifice”.<sup>63</sup> It should be noted that a protoform *\*d̥ui-plak-* and, with analogical *\*du-* for *\*d̥ui-* in Italic *\*du-plak-*, would regularly yield Greek δῖπλαξ, Latin *duplex*

and Umbrian **tuplak** alike. Thus the Latin form is most likely derived from *\*pel-* rather than the synonymous root *\*plek-*.<sup>64</sup> The use of the term thereby attests to a common ritual use of textiles in Latin, Sabellic, and Greek cult.

### *Umbrian textile production:*

For the aspect of textile production, we also find a few relevant terms in the Umbrian corpus:

VIb 43: *Uocucom Iouio, ponne oui furfant, uitlu toru trif fetu*

“At the Grove of Jupiter, while they are shearing(?) (= at the time of the shearing?) the sheep, he shall sacrifice three bull-calves.”

U. *furfant*:<sup>65</sup> De Vaan assigns Umbrian **furfaθ**, *furfant*, and *efurfatu* as cognates of Latin *forfex* ‘tongs, pincers; shears, scissors’, from Proto-Italic *\*forþo-* ‘shearing’ and *\*forþāje/o-* ‘to shear’, the verb denoting a “certain action with ‘sheep’ as direct object, ‘to shear’?”. Following Janda,<sup>66</sup> he suggests that the verb is denominal to a PIE adjectival *\*bʰrdʰ-o-* “capturing, harvesting, shearing”, originally *\*bʰer-dʰh<sub>1</sub>o-* ‘making booty’, cognate with Greek πέρω ‘to capture, take in, sack, loot’

57. Religious cincture is also highly important in Indo-Iranian: in Zoroastrianism, the wearing of the so-called sacred girdle is obligatory for the faithful (along with the sacred shirt) and highly symbolic; failure to do so made one an unbeliever and a non-Iranian. Cf. Andrés Toledo 2013, 26: “The initiation of the sacred girdle has an Indian parallel and possibly stems from Indo-Iranian times [...]. Among many other parallels between the Zoroastrian and the Hindu sacred girdle, the terminology related to it is noteworthy [...]. Not only the same concept, but also the same Indo-Iranian root (*-ja-* in Sanskrit *dvi-já-* ‘twice-born’, *-zad* in Persian *nōg-zad* ‘newly born’) in the same context is shared by both.” Cf. also Mallory & Adams (1997: 223-224) on the symbolic significance of the girdle in Indo-European culture.

58. Blumenthal 1931, 66. According to Cleland et al. 2007, 35, the *cinctus Gabinus* consisted in throwing an end of the toga over the shoulder or head and the excess knotted around the waist by forming part of the toga itself into a girdle (Isid. 19,24,7). It was originally used in battle, giving rise to its later use during sacrifices (Livy, 5.46.2; 10.7; Lucan 1.596) and religious rituals associated with war (Virgil. *Aen.* 611-15). Cf. also Servius *ad A.* 7.612. See Dubourdiou 1986 for a study.

59. A transportable chair for sacred emblems.

60. Neuter cons. stem noun in the acc.sg. (III 14). Untermann 2000, 775.

61. Weiss 2010, 115.

62. Weiss 2010, 118 (cf. also the discussion pp. 115-118).

63. Suet. fr. 167, translation Weiss. It should be kept in mind that the Iguvine Tables themselves describe priestly rituals.

64. De Vaan (2008, 473), presumably in an attempt to avoid the suffix *\*-ak-*, reconstructs *\*-plk-* for the Greek form and Italic *\*-plek-* for the Latin, stating that the “appurtenance of the U. form *-plak*, the meaning of which is unknown, is difficult from a root *\*plk-*”.

65. 3.plur.present **furfaθ** (Ib 1) and *furfant* (VIb 43), 3.sg.imp.II *efurfatu* (with the preverb *e-*, VIb 17 and VIIa 38. Untermann 2000, 302-303).

66. Janda 2000, 230-240.

and *πολίπορθος* ‘capturing cities’ (and *πορθέω* ‘to pillage’). Umbrian *furfa-* is indeed often translated as “to shear”.<sup>67</sup>

One could, however, argue that shears are an Iron Age invention linked to the metal,<sup>68</sup> and, although an argument *e silentio*, that shears are so far unattested archaeologically in earlier times,<sup>69</sup> which speaks against an interpretation of a Proto-Italic or PIE sense as “shearing”; the sense is rather one of “capturing, harvesting”. We are dealing with the plucking of wool, the original way of obtaining it.<sup>70</sup> The Armenian term *burd* ‘wool’ with the denominative *brdem* ‘cut wool’ may reflect the same root, whether regularly from *\*b<sup>h</sup>ōrd<sup>h</sup>o-* or, considering the somewhat surprising root vocalism, perhaps *\*b<sup>h</sup>rd<sup>h</sup>o-* or *\*b<sup>h</sup>ord<sup>h</sup>o-* borrowed from a slightly different dialect.<sup>71</sup> With the Italic evidence, this suggests a PIE origin and a meaning as “harvesting wool”. As for Latin *forfex* ‘shears’, the immediate protoform cannot be

*\*b<sup>h</sup>Vrd<sup>h</sup>-*, which would have given *\*forbex*, suggesting a dialectal borrowing from Sabellic.<sup>72</sup> For the semantic connection between ‘plunder, rob’ as in the Greek derivatives and ‘pluck (wool)’ as in Italic and Armenian, one may also compare the English verb *fleece* in the meaning ‘rob of money’.

#### IV 4: **stručla petenata isek aŗveitu**

“Likewise offer “combed” **stručla** cakes”  
(Tr. Weiss)

U. **petenata**:<sup>73</sup> presumably an *-o/-ā-* stem adjective derived from Proto-Italic *\*petke/o-* ‘to comb’ (*\*petken-* ‘comb’) from PIE *\*p(e)tk-* < *\*pe-pk-* [v.], *\*p(e)tken-* [m.] (cf. Greek *πέκω* ‘to comb, shear’, Lithuanian *pėšti* ‘to pluck’, Greek *πέκτω* ‘to comb, shear’, Old High German *fehtan* ‘to fight’; Greek *κτείς* ‘comb’ < *\*πκτεν-*<sup>74</sup>); interpreted

67. As by Meiser 1986: 101. In a recent article dedicated to this particular stem, Meiser (2013) proposes an alternative theory, deriving the basic root *\*b<sup>h</sup>erd<sup>h</sup>-* from *\*b<sup>h</sup>erH-d<sup>h</sup>h<sub>1</sub>-* ‘make cutting’. We consider this interpretation less likely as it would isolate the joint Italic evidence from the otherwise semantically striking Greek and Armenian cognates.

68. Forbes 1964, 7: “Plucking was the typical Bronze Age operation for the production of wool, shears appeared only in the Iron Age about 1000 BC when the suitable metal tool consisting of two knives joined by a spring could be manufactured from Iron, a metal more elastic than bronze.” One can of, course, also ‘shear’ with a knife, and, although bronze would be more impractical, this does not exclude the possibility of its use. Cf. also the, admittedly late, statement of Joannes Laurentius Lydus *De mensibus* 1.35. Ὅτι ἐπὶ τοῦ Νουμᾶ καὶ πρὸ τούτου οἱ πάλαι ἱερεῖς χαλκαῖς ψαλίσιον, ἀλλ’ οὐ σιδηραῖς ἀπεκείροντο “at the time of Numa, even before him, the priests of old used to have their hair cut with bronze but not iron scissors” (tr. Bandy 2013).

69. For shearing in ancient Italy, cf. Gleba 2012, 234-5: “More developed sheep breeds present at the time did not moult and their fleece had to be cut off, a process accomplished with the help of shears or a knife. Shears appeared during the Iron Age and all of the known examples are iron. In fact, their invention is tied to the use of iron, which is more springy than bronze [...]. All ancient shears found in Italy are of the same design [...]. The vast majority of the archaeological examples derive from the burial contexts in north Italy. It has been suggested that the practice of the deposition of shears in male burials in north Italy, populated at the time by Celtic tribes, may express the wool-based wealth of the Celts, who appeared there by the 4th century BC [...].” Cf. Varro *R.R.* 2.11.9: *quam demptam ac conglobatam alii vellera, alii vellimna appellant: ex quo[rum] vocabulo animadverti licet prius <in> lana vulsuram quam tonsuram inventam; Pliny NH 8.191: oves non ubique tondentur; durat quibusdam in locis vellendi mos.*

70. Cf. Wild (2012, 453) for the difference between shearing and plucking: “The apparently primitive practice of plucking sheep probably continued in Roman Britain alongside shearing with sprung iron shears. Plucking has the advantage of harvesting the finer short-stapled underwool in the fleece rather than the coarser longer outer hair: the result tends to be a generalised medium wool yarn rather than a hairy medium yarn, both typical of Roman Britain. Shearing, however, recovers the whole fleece, and the appearance of flat iron wool combs in the province by the 3rd century AD indicates the need to separate long from short fibres for the spinning of different types of yarn”. The Lithuanian cognate *pėšti* ‘pluck’ (see below) presumably reflects the original meaning of the process.

71. Cf. Olsen this volume 190.

72. Cf. Ernout 1909, 171: “*Forfex* est apparenté, comme on l’a déjà vu depuis longtemps, à skr. *bardhakah* “coupant, taillant; charpentier”, gr. *πέρθω* de *\*φέρθω* “détruire”, et dérivé d’une racine *i.e.* *\*bherdh-*, dont le représentant latin devrait être *\*forbex* puis *\*borbex* (comme *barba* représentant un ancien *\*bhardha-*, devenu *\*farfa* puis *\*farba* [...]); *forfex* est dialectal par le maintien du second *f* après *r* (le traitement latin est *b* cf. *uerbum*, got. *ward* “mot” de *\*werdh-*.)”

73. Acc. sing. feminine (IV 4). Untermann 2000, 549.

74. de Vaan 2008, 453.

by Buck as *pectinatam* ‘comb-shaped’.<sup>75</sup> While the comb-shaped objects in question are sacrificial cakes, the term does, nevertheless, thus reflect the concept of a comb, cf. also Latin *pectunculus* ‘small scallop’.

*Umbrian fibre sources:*

A number of terms for ovicaprids are attested in the Umbrian language:<sup>76</sup>

Ovids:

U. **erietu**:<sup>77</sup> A sacrificial animal, presumably ‘ram’, cognate with Latin *aries* (*-etis*) from Proto-Italic *\*a/eriēt-s* (nom., *\*a/eriet-* obl.) from PIE *\*h<sub>2</sub>r̥-i-(e)t-* ‘certain domestic animal’ (cf. Old Irish *heirp*, *erb* (f.) ‘she-goat, doe, roe’ (< Proto-Celtic *\*erbā-*), Greek ἔριφος ‘kid’, perhaps Armenian *oroj* ‘lamb’ (< *\*er-oj*) and *erinj* ‘young cow’<sup>78</sup>).

U. **unu**:<sup>79</sup> The meaning and etymology of the word are uncertain, but it is generally interpreted as belonging to the domain of sheep.<sup>80</sup> It occurs once with **erietu** (IIa 6) and once alone (IIa 8). It has been interpreted as “young sheep”, and if so it may derive from Italic *\*ouno-* < *\*ouñ-no-* < *\*ouñ-* (cf. below).

U. **habina**:<sup>81</sup> A sacrificial animal, believed to be of the *genus ovinum*, perhaps “lamb”; if so it may be derived from *\*ag<sup>h</sup>īnā*, a substantivization of an adjective *\*ag<sup>h</sup>īno/-ā* from Italic *\*ag<sup>h</sup>nīno/-ā* with dissimilatory loss of the first *n* after the addition of the suffix *-īno-* (cf. Latin *agnus*, Greek ἄμνός, both meaning ‘lamb’<sup>82</sup>). The *h-* must then be due to the influence of another word, e.g. equivalent to Latin *haedus* ‘kid’ (< *\*g<sup>h</sup>aido*).<sup>83</sup>

U. **uvm**:<sup>84</sup> The term for ‘sheep’, like Latin *ovis*. Etymologically from Proto-Italic *\*owi-* < PIE *\*h<sub>2</sub>ou-i-* or *\*h<sub>3</sub>ou-i-* (cf. Old Irish *óí*, Cuneiform Luwian *hā<sub>3</sub>ui-*, Lycian *χawa-* ‘sheep’; Sanskrit *ávi-* [m./f.] ‘sheep, ram’; Greek ὄις, ὄφις ‘sheep’; Armenian *hoviw* ‘shepherd’; Lithuanian *avìs*, Latvian *avs* ‘sheep’; Tocharian B *awi* [nom.pl.f.] ‘ewe’<sup>85</sup>).

Caprids:

U. **cabriner**:<sup>86</sup> An *-o/-ā-* stem adjective ‘of the goat’ (with *pelmner* ‘meat’) from Proto-Italic *\*kaprīno-* (cf. Latin *caprīnus* and below).

U. **kaprum**:<sup>87</sup> The term for ‘he-goat, buck’ from Proto-Italic *\*kapro-* with IE cognates in Welsh *caer-iwrch* ‘roebuck’, Irish *cáera* ‘sheep’ < *\*kapero-*; Greek κάπρος ‘(wild) boar’, Old Icelandic

75. Buck 1928, 189.

76. Cf. also the general Umbrian *pequo* (acc.pl.) ‘livestock’, corresponding to Latin *pecua* (VIa 30- VIIb 30, 11 times). Etymologically from *\*pekuā*, a collective plural to PIE *\*peku-* ‘cattle’, perhaps originally ‘small cattle, especially sheep’. Moreover, Umbrian *staflarem* and *staffi* may attest to animal husbandry of sheep, cf. Buck 1928, 305: “*staflare* (VIb 37) refers to some animal kept in a stall, probably a sheep”; but both sense and etymology are disputed, see Untermann 2000, 693-95.

77. Acc.sg. (IIa 6). Untermann 2000, 229.

78. de Vaan 2008: 54.

79. IIa 6 and 8. Untermann 2000, 799. Cf. the example above under **erietu**.

80. E.g. Borgeaud 1982, 151: “agneau bélier” (**unu erietu**).

81. Feminine *-ā-* stem noun; acc.pl. **habina** (Ia 27), **hapinaf** (Ia 24), *habina* (VIb 22-24) and gen.pl. **hapinaru** (Ia 33). Untermann 2000, 314.

82. de Vaan 2008, 30.

83. Cf. Untermann 2000, 314; Varro states that the “Sabines” termed the kid *fedus*, see the section on Sabine terms.

84. Masculine *-i-* stem noun: acc.sg. **uvm** (III 8, 10, 12, 26, 31) and **uve** (IIa 10); abl.sg. **uvikum** (with postp. *-com*, III 28); acc.pl. **uvmf** (Ib 1) and *oui* (VIb 43). Untermann 2000, 818.

85. de Vaan 2008, 437f; Wodtko, Irslinger & Schneider 2008: 335-339.

86. Gen.sg. masc. or neutr. (Vb 12, 17). Untermann 2000, 359.

87. Masculine *-o-* stem noun; acc.sg. **kaprum** (IIb 1), **kapru** (IIb 10), **kabru** (IIb 17) and gen.sg. **kapres** (IIb 12). Untermann 2000, 368-69.



*hafr* ‘he-goat’; cf. also Oscan  $\kappa\alpha\pi\omicron\rho\omicron\iota\nu\nu\alpha[\iota]$ .<sup>88</sup> According to de Vaan,<sup>89</sup> the *a*-vocalism makes it a likely candidate for a loanword, but at least the word is common to Italic and Germanic, and Celtic has a synonym in Old Irish *gabor*, Welsh *gafr* with an aberrant initial *g*- which may, however, have been influenced by the semantically related \**g<sup>h</sup>aǵdos* ‘goat’ (Latin *haedus*, Old Norse *geitr*).

*Umbrian colour terminology:*

Colour terms are an important part of textile terminology and the following Umbrian terms (all *-o/-ā*-stem adjectives) are attested:

- U. *adro*:<sup>90</sup> ‘black’ from \**ādro-*, like Latin *āter*. Interpreted by Cerri<sup>91</sup> as opaque black, vs **peiu** bright black (cf. below).
- U. **alfu**:<sup>92</sup> ‘white’ from Proto-Italic \**alfo-* from \**h<sub>2</sub>alb<sup>h</sup>-o-*, like Latin *albus* (cf. Greek (Hes.) ἀλφούς (acc.pl.)). See also Sabine *alpus*.
- U. **kaleřuf**:<sup>93</sup> of uncertain meaning, but perhaps white, cf. Latin *cal(l)idus* ‘with a white star’ (of horses).<sup>94</sup> Interpreted by Cerri<sup>95</sup> as bright white, vs **alfu** opaque white (cf. above).
- U. **peiu**:<sup>97</sup> the adjective denotes the colour of sacrificial animals,<sup>98</sup> probably a dark colour, maybe black (cf. above). No precise etymology or meaning has yet been established, but the term is generally interpreted as \**pik-jo-* corresponding to Latin *piceus* ‘pitch-black’, cf. Latin *pix* ‘pitch’.<sup>99</sup>
- U. *ponisiater*:<sup>100</sup> The term *ponisiater*, presumably from \**poīni kīāto-*, attests to the term for the colour purple \**poīnikejo-*, like Latin *pūniceus* a loan from Greek φοινίκεος ‘red, purple’ (“Phoenician”).
- U. **rufu**:<sup>101</sup> and *rofu*:<sup>102</sup> two related adjectives for red, like in Latin, both from the root \**h<sub>1</sub>reud<sup>h</sup>-*; **rufu** from Italic \**rudh-ro-* (like Latin *ruber*, cf. Greek ἐρυθρός and Old Indian *rudhirá-*), *rofu* from \**roudh-o-* (like Latin *rūfus*, cf. Gothic *raups*, Old Irish *riúad*, Lithuanian *raūdas*, Old Church Slavonic *rudъ*). Ancilloti & Cerri suggest that **rufu** may be opaque red, while *rofu* is bright red.<sup>103</sup>

88. O.  $\kappa\alpha\pi\omicron\rho\omicron\iota\nu\nu\alpha[\iota]$  (Dat.sg.f., a *-jo/-iā*-stem adjective (Pocc.129/Lu 32, Rossano). Untermann 2000, 369), an epithet of the goddess Mefitis, presumably from \**kaprōñā* and derived from \**kapro-* ‘buck’ (with anaptyxis and *-oinna* from *-ōñiā*). The precise meaning of the epithet is unclear, maybe the ‘buck goddess’ with the suffix of domination *-ōn-* and the feminine marker *-iā*. As a textile term it should mean something along the lines of ‘goatskin’, but one would then expect the suffix *-inV-* instead. Poccetti states that the reading  $\kappa\alpha\pi\omicron\rho\omicron\iota\nu\nu\alpha[\iota]$  is also possible, providing a link to Juno Caprotina (cf. Poccetti 1979, 121: “L’evidenza grafica, tuttavia, non lascia escludere del tutto la precedente lettura [...] $\kappa\alpha\pi\omicron\rho\omicron\iota\nu\nu\alpha[\iota]$ , anche per un possibile rapporto con il lat. *Caprotina*, noto come attributo di *Iuno*”). Either way the epithet attests to the Oscan term for goat.

89. de Vaan 2008, 89.

90. Acc.pl.n. **atru** (Ib 29), *adro* (VIIa 25) and abl.pl.n. *adrir* (VIIa 9, 10, 21), *adrer* (VIIa 18). Untermann 2000, 54-55.

91. Ancilloti & Cerri 1996, 94.

92. Acc.pl.n. **alfu** (Ib 29) and abl.pl.n. *alfir* (VIIa 25, 26) and *alfer* (VIIa 32, 34). Untermann 2000, 79-80.

93. Acc.pl.m. attested as **kaleřuf** (Ia 20) and *calersu* (VIb 19). Untermann 2000, 365.

94. Cf. Untermann 2000, 80.

95. Ancilloti & Cerri 1996, 94.

96. Cf. Isidorus 12,52: (*equi*) *qui frontem albam (habent) calidi (appellantur)*.

97. Acc.pl.f. **peiu** (Ib 24), *peiu* (VIIa 3) and acc.pl.f. **peia** (Ib 27), *peia* (VIIa 6). Untermann 2000, 526-27.

98. Cf. the *piceae oves* in Val. Flaccus 3,439.

99. See Untermann 2000, 527, for references.

100. Gen.sg.m. *ponisiater* (VIb 51) and **puniçate** (Ib 15). Untermann 2000, 607-608.

101. Acc.pl.m. **rufu** (Ib 24), Acc.pl.f. **rufra** (Ib 27) and gen.sg.m. *rufrer* (VIa 14). Untermann 2000, 637-38. South-Picene **rufra** (CH 1, Crecchio) is a possible parallel, but its meaning and etymology are unknown, cf. Untermann 2000, 636.

102. Acc.pl.m. *rofu* (VIIa 3) and acc.pl.f. *rofa* (VIIa 6). Untermann 2000, 638.

103. Ancilloti & Cerri 1996, 94.

**Sabine:**

As mentioned above, glosses must be treated with the utmost caution, as they are not only often mistaken, but are also second hand evidence and may be marred by textual tradition. Sabine was one of the Sabellic languages spoken in central Italy in the hill districts lying east and southeast of Rome.<sup>104</sup> The Sabine language is attested in the form of glosses, although some early inscriptions from Sabine or nearby territory use an alphabet “that may for convenience be called Sabine”.<sup>105</sup>

- Sabine *alpus* ‘white’:

P. ex. F. 4 Lindsay: *Album, quod nos dicimus, a Graeco, quod est ἀλφόν, est appellatum. Sabini tamen alpum dixerunt. Unde credi potest, nomen Alpium a candore nivium vocitatum.*

“What we name *albus* is thus termed from the Greek ἀλφόν, which the Sabines called *alpus*. Thence it may be surmised that the name of the Alps stems from the lustre of its snowy peaks”.

Conway states that the word is clearly borrowed from Greek or Celtic, because the genuine Italic reflex would be \**alfo-*, cf. on U. **alfu**.<sup>106</sup>

- Sabine *hircus* and *fedus*:

Varr. *L.L.* 5, § 97 <h>*ircus, quod Sabini fircus; quod illic f[a]jedus, in Latio rure hedus: qui in urbe ut in multis A addito <h>aedus.*

“*Hircus* ‘buck’, which the Sabines call *fircus*; and what there is *fedus*, in Latium is *hedus* ‘kid’ in the country, and in the city

it is *haedus*, with an added *A*, as is the case with many words.”

Conway conjectures that the true Sabine form was \**felo-* and that either Varro’s text or more probably his knowledge is at fault.<sup>107</sup>

- Another term which is only defined as “Sabine” was discussed by Favorinus:

*Nux terentina dicitur quae ita mollis est ut vix attractata frangatur. De qua in libro Favorini sic reperitur: “item quod quidam Tarentinas oves vel nuces dicunt, quae sunt terentinae a ‘tereno’, quod est Sabinorum lingua molle, unde Terentios quoque dictos putat Varro ad Libonem primo.” Quam in culpam etiam Horatius potest videri incidere, qui ait et ‘molle Tarentum’.*<sup>108</sup>

“The nut that’s so soft it breaks when you’ve scarcely touched it is called ‘terentine’. About this nut one finds the following in a book by Favorinus: “Similarly, there’s the fact that some people call sheep and nuts ‘Tarentine’ when they are properly ‘terentine’, from *terenus*, the Sabine term for ‘soft’; Varro, in his first book *To Libo*, expresses the view that the Terentii are so called from the same term.” Horace could seem to fall into the mistake noted by Favorinus when he speaks of “soft Tarentum”, too.”

It is the term “tarantine”, which is usually deemed to be a toponymical reference to the city of Taras (modern Taranto) in Magna Graecia which was famed for its wool in antiquity.<sup>109</sup> The link with the toponym of Taras is highly dubious and clearly a conflation, but the Sabine term for soft *terenus* conforms to the

104. Wallace 2008, 96. Varro states that Sabine derives from Oscan: *L.L.* 7.28: *secundo eius origo [i.e. the word cascus] Sabina, quae usque radices in Oscam linguam egit*, “secondly, it has its origin from the Sabine language, which ran its roots back into Oscan”.

105. Crawford *et al.* 2011, I, 2.

106. Conway 1897, 352 (referring to Gallic ἄλπεις). Untermann 2000, 80.

107. Conway 1897, 354.

108. Macrobius *Saturnalia* 3.18.13.

109. Columella 7.2.3; Pliny *NH* 8.189-190.

reconstruction of Latin *tener* ‘soft, delicate’, which presumably derives from *\*tenVro-* < *\*terVno-* by consonant metathesis. Both Indo-Iranian and Greek have adjectives in *\*teru-*, *\*ter-n-* and *\*teru-n-* (cf. Sanskrit *tárūṇa-* ‘young, tender, fresh’, Avestan *tauruna-* ‘young’, Ossetic *tærɣn*, *tyryn/tærna* ‘boy’, Greek τέρυ ‘soft, weak’ and τέρην ‘soft, delicate’).<sup>110</sup>

- *trabea*:

“Ὅτι ὁ Νουμᾶς τὴν βασιλικὴν ἐσθῆτα εἰς τιμὴν Ἡλίου καὶ Ἀφροδίτης ἐκ πορφύρας καὶ κόκκου κατασκευάζεσθαι διετύπωσεν (...) καλέσας αὐτὴν τὴν στολὴν πατρίως τραβαίαν, ἣν λέγεται πρῶτος ὁ Ἄγαθοκλῆς ὁ Σικελιώτης εὐρεῖν. τραβαία δὲ εἴρηται ὡσανεὶ τρίβαφος· ἐκ τριῶν γὰρ ἀποτελεῖται χρωμάτων, πορφύρας, κόκκου καὶ ἰσατίδος βοτάνης.<sup>111</sup>

“Numa prescribed that the royal dress be made of purple and scarlet in honour of Helios and Aphrodite (...) and named the garment itself *trabea* in his native language. Agathokles the Sicilian is said to have been the first to make it. It has been termed *trabaia*, “dyed three times”, for it is made of three colours: purple, scarlet, and woad”.

The *trābēa*, presumably the only certain textile related Sabine term, was a ceremonial garment of priests, kings,<sup>112</sup> consuls,<sup>113</sup> and knights,<sup>114</sup> in Rome from the beginnings to late Antiquity.<sup>115</sup> According to Suetonius, there were three kinds of *trabea*: one

sacred to the gods (entirely of purple), the second was royal (made of purple and some white), the third was a dress of augurs (of purple and scarlet).<sup>116</sup> Isidorus follows Joannes Laur. Lydus and states that the one of purple and scarlet was regal.<sup>117</sup> The fanciful etymologies of Joannes L. Lydus (“τρίβαφος”) and Isidorus (“*quod ... transbearet*”) are nothing more than that. The term *trabea* was assigned to the Sabine language by Mommsen and Vetter.<sup>118</sup> Interpreted by Ernout & Meillet as a form of toga of Sabine origin, they suggest a link with *trabs* ‘beam’, presumably because the *trabea* was “faite toute entière d’étoffe de pourpre, ou ornée de bandes horizontales de cette couleur”.<sup>119</sup> According to Ernout it is confirmed by Virgil *Aen.* 7.612:<sup>120</sup> *ipse Quirinali trabea cinctuque Gabino*, “arrayed in Quirinal robe and Sabine cincture”, where “l’alliance de *Quirinalis* avec *trabea* indique que Virgile considérait le mot comme sabin”.<sup>121</sup>

### Concluding remarks

Although the attested Sabellic terminology of textiles is, as is to be expected from the sources at our disposal, rather meager, the preceding contribution has nevertheless confirmed numerous Sabellic terms in the domain of dress and textiles.

Several of the Sabellic textile terms contribute to the loanwords connected to textiles. Oscan **plauta-** was transmitted to Italic from Greek (through Magna Graecia); the *supparus* made its way from Greek to Oscan and thence to Latin; the Umbrian word *ponisater* was, like the Latin *pūniceus*, a loan from Greek φοινίκεος; the Sabine term *trabea* was adopted in

110. de Vaan 2008, 613, s.v. *tener*. Also accepted as Sabine by Beekes 2010, 1468, s.v. τέρην.

111. Joannes Laurentius Lydus Hist., *De mensibus* 1.21 (tr. adapted from Bandy 2013).

112. Plin. *NH* 8. 195, 9.136; Virg. *Aen.* 7.188, 9.334, 11, 334; Ovid. *Fast.* 2.503.

113. Virg. *Aen.* 7.612.

114. Tac. *Ann.* 3, 2; Suet. *Dom.* 14; Val. Max. 2, 2, 9; Martial, 5.41.5.

115. See Dewar 2008.

116. *Apud* Servius *ad Verg. Aen.* 7.612. Cf. Servius *ad Verg. Aen.* 7.188.

117. Isid. 19.24.8.

118. Vetter 1953, 377: “Dies bezieht Mommsen [...] mit Recht auf die sabinische Sprache”. Cf. Mommsen 1850, 355.

119. Ernout-Meillet 698.

120. Cf. also Virg. *Aen.* 7. 187-188.

121. Ernout 1909, 238; Ovid *Fasti* 1,37; 6, 375 and 796; *Metamorph.* 14, 828.

Latin. For phonological reasons, the Latin term *for-fex* ‘shears’ moreover suggests a dialectal borrowing from Sabellic to Latin tool terminology. The use of the term **tuplak** attests to a common ritual use of textiles in Latin, Sabellic, and Greek cult.

The terminological characteristic which is most striking is that also Sabellic terminology conforms to other ancient languages in characterizing clothing by designation of the garment by reference to borders, stripes or bands: Umbrian *perca* and Sabine *trabea* conform to e.g. the Latin *claves*, *virgatae vestes* and the Greek *ράβδοι*.

There are also aspects worth noting regarding costume vs status and function. Bonfante argues that decoration on Etruscan and Greek clothing was purely ornamental, but that it was symbolic in Roman clothing.<sup>122</sup> The formalization of dress details found among the Romans as symbols of rank (e.g. the *clavi*), seems to have a parallel in the Sabellic *perca* and *trabea*, the latter adopted as such by the Romans.

Moreover, dress marked the social class of its wearer in both Etruria and Rome. Etruscan priest(esse)s and divinities were donned in specific clothing, like the *perca arsmatiam/ponisiater* in Umbrian ritual (and priestly attire at Rome). The custom at Rome of distinguishing senators, consuls, and knights by their clothing appears to have a parallel in Umbrian *šihitir/anšihitir*, but of course also in the Sabine *trabea*, which had precisely this function at Rome.

The Sabellic terminology thus not only provides valuable comparanda for the archaeological study of Italic textiles and the ritual use of textiles in ancient Italy, but also complements our knowledge of this crucial and important domain of Indo-European culture and life.<sup>123</sup>

### Abbreviations

<i>Ernout-Meillet</i>	Ernout, A. & Meillet, A. (2001) <i>Dictionnaire étymologique de la langue latine. Histoire des mots</i> . Paris.
<i>LIV</i>	<i>Lexikon der indogermanischen Verben. Die Wurzeln und ihre</i>

*Primärstambbildungen. Unter Leitung von Helmut Rix und der Mitarbeit vieler anderer bearbeitet von Martin Kümmel, Thomas Zehnder, Reiner Lipp, Brigitte Schirmer. Zweite, erweiterte und verbesserte Auflage bearbeitet von Martin Kümmel und Helmut Rix. Wiesbaden, 2001.*

Walde-Hofmann = A. Walde, *Lateinisches etymologisches Wörterbuch*. 3., neubearbeitete Auflage von J.B. Hofmann, I-II. Heidelberg, 1938-54.

### Bibliography

- Adams, J. N. (2007) *The Regional Diversification of Latin 200 BC – AD 600*. Cambridge.
- Adiego, I.-J. (1995) Sudpiceno vespes, *La parola del passato* 50, 135-139.
- Ancillotti, A. & Cerri, R. (1996) *Le tavole di Gubbio e la civiltà degli Umbri*. Perugia.
- Andrés Toledo, M. Á. (2013) Textiles in Zoroastrianism, in Alfaro Giner, C., Ortiz García, J. & M. J. Martínez García (eds.) *Luxury and Dress. Political Power and Appearance in the Roman Empire and its Provinces*, 23-30. Valencia.
- Bandy, A. C. (2013) *Ioannes Lydus. On the Months (De mensibus)*. Lewiston-Queenston-Lampeter.
- Beekes, R.S.P. (2010) *Etymological Dictionary of Greek*. Leiden-Boston.
- Bender Jørgensen, L. (2011) Clavi and Non-Clavi: Definitions of Various Bands on Roman Textiles, in Alfaro, C., Brun, J.-P., Borgard, Ph. & Pierobon Benoit, R. (eds.) *PURPUREAE VESTES III. Textiles y Tintes en la ciudad antigua. Actas del III Symposium Internacional sobre Textiles y Tintes del Mediterráneo en el mundo antiguo (Nápoles, 13 al 15 de noviembre, 2008)*, 75-81. Valencia.
- Biville, Fr. (1990) *Les emprunts du latin au grec. Approche phonétique. I. Introduction et consonantisme*. Louvain-Paris.
- Blumenthal, A. von (1931) *Die iguvinischen Tafeln*. Stuttgart.
- Bonfante, L. (2003) *Etruscan Dress. Updated Edition*. Baltimore-London.

122. Bonfante 2003, 92.

123. See Olsen forthcoming.

- Borgeaud, W. A. (1982) *Fasti Vmbrici. Études sur le vocabulaire et le rituel des Tables eugubines*. Ottawa.
- Bücheler, F. (1882) Altes Latein, *Rheinisches Museum für Philologie* 37, 516-530.
- Buck, C. D. (1928) *A Grammar of Oscan and Umbrian*. Boston.
- Clackson, J. (2014) Local Languages in Italy and the West, in Bruun, C. & Edmondson, J. (eds.) *The Oxford Handbook of Roman Epigraphy*, 699-720. Oxford.
- Cleland, L., G. Davis & L. Llewellyn-Jones (2007) *Greek and Roman Dress from A to Z*, London-New York.
- Conway, R. S. (1897) *The Italic Dialects. Edited with a Grammar and Glossary*. Volume 1. Cambridge.
- Crawford, M. H. et al. (2011). *Imagines Italicae. A Corpus of Italic Inscriptions. Edited by M. H. Crawford with W. M. Broadhead, J. P. T. Clackson, F. Santangelo, S. Thompson, M. Watmough & Computing by E. Bissa & G. Bodard*. Bulletin of the Institute of Classical Studies 110.
- de Vaan, M. (2008) *Etymological Dictionary of Latin and the other Italic Languages*. Leiden-Boston.
- Devoto, I. (1937) *Tabulae Igvvinae*. Rome.
- Dewar, M. (2008) Spinning the *Trabea*: Consular Robes and Propaganda in the Panegyrics of Claudian. In Edmondson, J. & Keith, A. (eds.) *Roman Dress and the Fabrics of Roman Culture*, 217-237. Toronto.
- Dubourdieu, A. (1986) Cinctus Gabinus, *Latomus* 45, 3-20.
- Ernout, A. (1909) *Les éléments dialectaux du vocabulaire latin*. Paris.
- Fay, E. W. (1914) Varronianiana: De Lingua Latina: Part II, *American Journal of Philology* 35, 245-267.
- Forbes, R. J. (1964) *Studies in Ancient Technology. Volume IV*. 2nd. revised edition. Leiden.
- Franchi de Bellis, A. (1992) Latino *plautus* ed osco **plavta-**, *Quaderni dell'Istituto di Linguistica dell'Università di Urbino* 7, 3-31.
- Gleba, M. (2012) Italy: Iron Age. In Gleba, M. & Manering, U. (eds.) *Textiles and Textile Production in Europe. From Prehistory to AD 400*. Ancient Textiles Series 11, 215-241. Oxford.
- Hoss, S. (2011) The Roman Military Belt. In Nosch, M.-L. (ed.) *Wearing the Cloak: Dressing the Soldier in Roman Times*, 29-44. Oxford.
- Housmann, A. E. (1919) Siparvm and Svpparvs, *Classical Quarterly* 13, 149-152.
- Janda, M. (2000) *Eleusis. Das indogermanische Erbe der Mysterien*. Innsbruck.
- Jones, D. M. (1964) Umbrian *perca*, *Glotta* 42, 268-272.
- Kloekhorst, A. (2008) *Etymological Dictionary of the Hittite Inherited Lexicon*. Leiden-Boston.
- Kretschmer, P. (1925) Das -nt- Suffix, *Glotta* 14, 84-106.
- Mallory, J. P. & Adams, D. Q. (eds.) (1997) *Encyclopedia of Indo-European Culture*. London-Chicago.
- Marinetti, A. (1985) *Le iscrizioni sudpicene*. Firenze.
- Meiser, G. (1986) *Lautgeschichte der Umbrischen Sprache*. Innsbruck.
- Meiser, G. (2013) Umbrisch *furfant* und *efurfatu*, *Linguarum Varietas* 2, 157-163.
- Mommsen, T. (1850) *Die unteritalischen Dialekte*. Leipzig.
- Nosch, M.-L. B. (2015) The Loom and the Ship in Ancient Greece. Shared knowledge, shared terminology, cross-crafts, or cognitive maritime-textile archaeology? In Harich-Schwartzbauer, H. (ed.) *Weben und Gewebe in der Antike. Materialität – Repräsentation – Episteme – Metapoetik*, Ancient Textiles Series 23, 109-132. Oxford.
- Olsen, B. A. (2016) Latin *vespillō* ‘undertaker’ – Calvert Watkins in memoriam. *Journal of Indo-European Studies* 44, 1-2, 92-110.
- Olsen, B. A. (2017) Armenian Textile Terminology. In S. Gaspa, C. Michel & M.-L. Nosch (eds.), *Textile Terminologies from the Orient to the Mediterranean and Europe, 1000 BC to 1000 AD*, 188-201. Lincoln, Nebraska.
- Olsen, B. A. (forthcoming) The Indo-European vocabulary of sheep, wool and textile production. In Iversen, R. & G. Kroonen (eds.) *Archaeology and language – and the future of archaeo-linguistic studies*. Oxford.
- Olson, K. (2003) Roman Underwear Revisited, *Classical World* 96, 201-210.
- Olson, K. (2008) The Appearance of the Young Roman Girl. In Edmondson, J. & Keith, A. (eds.) *Roman Dress and the Fabrics of Roman Culture*, 139-157. Toronto.
- Pocchetti, P. (1979) *Nuovi documenti italici: A complemento del Manuale di E. Vetter*. Pisa.
- Poultney, J.W. (1959) *The Bronze Tables of Iguvium*. Baltimore.
- Rix, H. (2002) *Sabellische Texte. Die Texte des Oskischen, Umbrischen und Südpikenischen*. Heidelberg.
- Rüsch, E. (1914) *Grammatik der delphischen Inschriften. I. Band – Lautlehre*. Berlin.
- Santoro, C. (1975) *Osservazioni fonetiche e lessicali sul dialetto greco di Taranto*. Bari.
- Schneider-Hermann, G. (1996) *The Samnites of the Fourth Century BC as depicted on Campanian Vases and in*

- the other Sources*. Institute of Classical Studies Bulletin Suppl. 61, London.
- Schwyzler, E. (1968) *Griechische Grammatik*. München.
- Untermann, J. (2000) *Wörterbuch des Oskisch-Umbri-schen*. Heidelberg.
- van den Hout, M. P. J. (1999) *A Commentary on the Letters of M. Cornelius Fronto*. Mnemosyne Supplements 190. Leiden-Boston-Köln.
- Vetter, E. (1953) *Handbuch der italischen Dialekte, I. Band*. Heidelberg.
- Wallace, R. (2008) Sabellian languages. In Woodard, R. D. (ed.), *The Ancient Languages of Europe*, 96-123. Cambridge.
- Watkins, C. (1969) A Latin-Hittite Etymology. *Language* 45, 235-47.
- Weege, F. (1909) Bewaffnung und Tracht der Osker, *Jahrbuch des deutschen archäologischen Instituts* 24, 141-162 (with plates 7-12).
- Weiss, M. (2010) *Ritual and Language in Sabellian Italy*. Leiden-Boston.
- Wild, J. P. (2012) England: Roman Period. In Gleba, M. & Mannering, U. (eds.) *Textiles and Textile Production in Europe. From Prehistory to AD 400*. Ancient Textiles Series 11, 451-456. Oxford.
- Wodtko, D., B. Irslinger & C. Schneider (2008) *Nomina im Indogermanischen Lexikon*. Heidelberg.

## Beschaffung und Handel mit Farbstoffen

Peter Herz

**F**arbstoffe sind alles andere als ein leicht zu behandelndes Thema, denn von wenigen Ausnahmen abgesehen, die die mineralischen Farben betreffen, geht die archäologische Nachweisbarkeit in der Regel fast gegen Null, was gerade für die Textilfarben sehr bedauerlich ist.

Die frühesten Nachweise auf einen internationalen Handel mit Farbstoffen stammen aus dem Ägypten der 4. Dynastie. In vielen Gräbern dieser Epoche finden wir Wandgemälde aus einem ganz speziellen Blau, dem sogenannten Ägyptischen Blau.<sup>1</sup> Einer der Grundstoffe war Lapislazuli oder Blaustein, ein Mineral, das noch heute in den östlichen Teilen von Afghanistan abgebaut wird. Von dort aus wurde das Rohprodukt mit Eselskarawanen bis zum Mittelmeer transportiert, wo wahrscheinlich der Hafen von Ugarit als Umschlagplatz diente.<sup>2</sup> Von dort aus konnte es dann auf dem Seeweg im gesamten östlichen Mittelmeergebiet verteilt werden.

Eine Studie aus dem Jahr 2009 hat gesichert, daß die Parthenon-Skulpturen zumindest teilweise mit dem ägyptischen Blau bemalt waren.<sup>3</sup> Wenn wir die Zeit betrachten, in der dieser Teil des Parthenon

beendet wurde, dann scheinen selbst die meist angespannten Beziehungen zwischen Athen und dem Reich der Achaemeniden den Handel mit diesem Farbstoff nicht grundsätzlich beeinträchtigt zu haben.

Ausgangspunkt meiner eigenen Überlegungen war eine neugefundene Inschrift aus dem Hafen von Andriake in Lykien, die 2007 von Burak Takmer erstmals vorläufig vorgestellt wurde.<sup>4</sup> Die angekündigte und dann auch kommentierte Gesamtedition der Inschrift liegt m.W. noch nicht vor. Die Inschrift behandelt die in Verantwortung des lykischen Bundes erhobenen Steuern und dabei auch die fiskalische Behandlung des Safran. Die für uns relevante Passage lautet

- (41) ---- ό] ἐν μεσογεία  
 (42) [ώ]νούμενος κρόκον ἀπογραφέσθω  
 ἐπὶ τοῦ ἔνγι[στα π]αραφύ[λακος].  
 ἔ[ὰν δὲ οὗτ]ός μὴ παρῆ  
 (43) ἐπ' ἄρχοντος τὸ πλῆθος, ὃ συ-  
 νεώνηται, καὶ ὅπου αὐτὸ μέλλει  
 τ[ε]λ[ω]ν[εῖσθ]αι. αἰ ἀ[π]ογραφαὶ  
 πάντων

1. Berke 2010; 2006.

2. McGeough 2007.

3. Verri 2009, 1011-1021.

4. Takmer 2007, 165-188, bes. 176.

- (44) [ἐν] τελ[ω]γείω ἐν ἐνι τόμῳ  
 γεινέσθ[σ]αν πρὸς τὴν κοινὴν  
 τοῦ δημοσιώ[ν]ου [κ]αὶ τοῦ  
 (45) ἀπογραφομένου ἀσφάλειαν.

„Wer im Binnenland Safran aufkauft, soll die gekaufte Menge und den Aufbewahrungsort, wo sie bis zur Entrichtung der Zollgebühr bleibt, beim nächsten Paraphylax angeben. Wenn dieser nicht in seinem Amtssitz ist, soll er es beim Archon tun. Die Einträge sollen der gemeinsamen Sicherheit sowohl des Zöllners als auch des deklarierenden wegen im Zollgebäude als einzelne Rolle aufbewahrt werden.“

Bei dem hier angesprochenen Produkt handelt es sich um die getrockneten Blütenfäden des Safran oder *Crocus sativus*, die einen gelbfärbenden Farbstoff namens Crocotin liefern. Der wahrscheinlich ursprünglich nur in Griechenland und dem Vorderen Orient heimische *Crocus sativus* gehört zu den wichtigsten Farblieferanten der antiken Textilwirtschaft, der sich im Laufe der Geschichte nachweislich von seinem Ursprungsgebiet über das übrige Mittelmeergebiet verbreitete.<sup>5</sup>

Der *Crocus sativus* blühte im Herbst für zwei Wochen und mußte in diesem sehr engen Zeitraum geerntet werden, wobei unter wirtschaftlichen Aspekten lediglich die Blütenfäden von Interesse waren. Sie wurden während der Ernte aus der Blüte herausgezupft und anschließend getrocknet, was eine typische Arbeit für Frauen und Kinder ist. Ein verkaufsfähiges Kilogramm Safran mußte aus den getrockneten Stempelfäden von 150- bis 200000 Blüten gewonnen werden, für die man eine Anbaufläche von 1000 m<sup>2</sup> benötigten. Dabei hat sich die Technik, mit der man die Blütenfäden gewinnt, bis heute nicht geändert, d.h. es ist ein enormer Arbeitseinsatz notwendig. Die Bedeutung solcher Tätigkeiten für den ländlichen Arbeitsmarkt ausgewählter Regionen ist noch nicht erforscht.

Wie ist das technische Procedere zu bewerten, da sich hier abzeichnet? Der Aufkäufer wurde von den einzelnen Bauern und Hirten mit dem handelsfähigen Safran beliefert. Da der Käufer wahrscheinlich die Absicht hatte, die so erworbene Ware aus dem Gebiet des lykischen *koinon* auszuführen, unterlag sie damit auch der Verpflichtung zu einer Verzollung an der Außengrenze Lykiens, wobei wir leider nicht sagen können, wie hoch der geforderte Zoll war. Da aber die Zollinschrift am Rande des Hafengeländes von Andriake und dort wohl in situ gefunden wurde, dürfte es sich hier um die Erhebung der Exportabgabe handeln. Ob es daneben auch noch Rechtsvorschriften für einen internen Handel innerhalb von Lykien gab, läßt sich auf unserer dürftigen Quellenbasis nicht mehr entscheiden.<sup>6</sup>

Die Zwischenlagerung in einem Lager, möglicherweise auch die anschließende Verzollung, erfolgte auf der Ebene der Gemeinde, d.h. die administrative Verantwortung für die Verwahrung lag in der Gewalt der jeweiligen Gemeinde. Diese spezielle Regelung dürfte durch die Natur des handelsfähigen Safrans zu erklären sein. Offensichtlich wurde diese Ware auch in sehr kleinen Mengen (d.h. wohl im Unzen- und Pfundbereich) gehandelt, so daß die Möglichkeit, die Ware unbemerkt an der Zollkontrolle vorbeizuschaffen, durchaus gegeben war.

Aus den wenigen uns vorliegenden Quellen kann nicht eindeutig ermittelt werden, ob man damals den Safran aus der wildwachsenden Form gewann oder ob es sich bereits um planmäßig angelegte Felder handelte.

Vgl. etwa Strab. 14.5.5 [671] zum kilikischen Krokus = Safran.

„Nach dem Kalykadnos kommt der sogenannte Bunte Felsen, mit einer eingehauenen Treppe, die nach Seleukeia führt. Dann Anemurion, ein mit dem vorigen gleichnamiges Kap, und die Insel Krambusa und Kap Korykos, über dem, zwanzig

5. Schweppe 1993, 172-174.

6. Unsere Kenntnisse zur lykischen Textilwirtschaft sind zu limitiert, um hier zu einer Entscheidung kommen zu können. Lykien war wohl eher ein Lieferant von Rohstoffen.



Stadien entfernt, die Korykische Grotte liegt, in der der beste Safran wächst (... ἀρίστη κρόκον φύεται). Es ist eine große kreisförmige Vertiefung, die an allen Seiten von einem ziemlich hohen felsigen Rand umgeben ist; steigt man sie herunter, dann trifft man auf einen kleinen unebenen und größtenteils felsigen, aber mit immergrünen und gezüchteten Gesträuch bedeckten Boden, zwischendurch verstreut sind die Böden, die den Safran tragen.“ (Radt)

Ähnlich unergiebig ist auch Strab. 6.2.7 [273] zum Safranbau von Sizilien. Hier ist die Information zum Safran in die Nachricht eingebunden, daß Sizilien bei all den zuvor genannten Dingen einen Überschuß produziert.

... σίτω δὲ καὶ μέλει καὶ κρόκω καὶ ἄλλοις τισὶ κἄν ἀμείνω τις φαίη.

„Für Getreide, Honig, Safran und einiges andere könnte man es [scil. Sizilien] sogar über Italien stellen ....“.

Wir können demnach eine Aufgliederung der für Textilien einsetzbaren Farbstoffe nach verschiedenen Kategorien erstellen, die sich durch die Art ihrer Gewinnung ergibt.

***Farbstoffe, die man aus wildwachsenden Pflanzen gewinnen konnte bzw. die durch Tiere produziert wurden***

Diese Farbstoffe konnte man nur lokal gewinnen, wobei man im Fall der Pflanzen keinen gezielten Anbau vermuten kann. Diese Prämisse gilt möglicherweise für Farbstoffe wie den Safran, aber auch die verschiedenen Arten des Kermes, wobei man die Tiere, aus denen man den Farbstoff gewinnen konnte, lediglich einsammeln mußte. Hier gewinnen wir einen

ersten und sehr interessanten Einblick in eine m.W. bisher kaum berücksichtigte Einnahmequelle der ländlichen Bevölkerung.

Wie dieses Beschaffungssystem in der Realität arbeiten konnte, erfahren wir eher beiläufig in einer kurzen Nachricht aus der aramäischen Vita des Symeon Stylites des Älteren. Von ihm wird berichtet, er habe als Hirtenjunge in den Bergen des Taurus Storax gesammelt, also ein sehr aromatisches Baumharz<sup>7</sup> Dieses sich hier andeutende Beschaffungsmodell kann man ohne Bedenken auf die Gewinnung des Kermes übertragen.

Kermes wurde aus den getrockneten Körpern des weiblichen Kermesschildläuse (*Kermes vermilio*) gewonnen. Dieses Insekt lebte üblicherweise auf einer mediterranen Eichenart (*Quercus coccifera*) und starb nach der Ablage seiner Eier, konnte dann also eingesammelt werden.<sup>8</sup> Ergänzt wurde dieser spezielle Kermes etwa durch den armenischen Cochenille oder Ararat-Kermes, wobei die farb liefernden Insekten (*Porphyrophora hameli*) auf Gräsern lebten, wo man sie ebenfalls relativ leicht aufsammeln konnte.<sup>9</sup> Ähnlich sieht es im Fall des sogenannten polnischen Kermes aus, der von der polnischen Kermeslaus (*Porphyrophora polonica*) produziert wurde, die in Mitteleuropa durchaus gut verbreitet war.<sup>10</sup> So verzeichnet das Urbar des Regensburger Stiftes St. Emmeram aus dem Jahre 1031 eine Reihe von zinspflichtigen Dörfern im Großraum von Regensburg, die getrocknete Kermesläuse an das Stift abliefern mußten.<sup>11</sup>

***Farbstoffe, die als Neben- oder Abfallprodukt anfielen. Beispielhaft seien aus dieser Gruppe genannt***

*Juglans regia* = Schalen der Walnuß

*Punica granatum* = Fruchtschale des Granatapfels

Dieses gilt auch für die verschiedenen färbenden Baumrinden, da ich bei ihnen davon ausgehe, daß

7. The Lives of Simeon Stylites, translated with an introduction by R. Doran, Kalamazoo/Mich., Spencer/Mass. 1992 (Cistercian Publications), 103.

8. Schweppe 1993, 254-259.

9. Schweppe 1993, 254.

10. Schweppe 1993, 254-259.

11. Vgl. die Verbreitungskarte bei Bartel & Codreanu-Windauer 1995, 251-272, bes. 270 nach Heimpele 1926, 33-35.

hier die Gewinnung des Stammholzes im Vordergrund stand.

**Farbliefernde Pflanzen, die gezielt mit dem Ziel einer Gewinnung von Farbstoffen angebaut wurden.**

Sicherlich ackerbaumäßig angebaut wurden die folgenden Farbpflanzen, für die wir in der Spätantike sogar eine staatliche Monopolbildung nachweisen können: Waid, Krapp und Saflor.<sup>12</sup>

D. Hagedorn, der in den 70er Jahren die ihm damals bekannten Belege zumindest in Ägypten zusammenstellte, machte dabei deutlich, daß der römische Staat zumindest in Ägypten den Anbau von ἰσάτις, also *Isatis tinctoria* oder Waid, und von ὄχομένιον und κνήκος kontrollierte. Hagedorn interpretierte seinerzeit ‚ochomenion‘ mit einer gewissen Reserve als Synonym oder Variante für den Saflor oder die Färberdistel (*Carthamus tinctorius*), der üblicherweise als κνήκος bezeichnet wurde.<sup>13</sup> Es mag dabei von Bedeutung sein, daß später der arabische Autor Ibn al-Awwam ebenfalls zwei Sorten von *Carthamus* in Ägypten unterscheidet.<sup>14</sup>

Verbesserte Edition von SB X 10264  
(nach Hagedorn, ZPE 17, 1975, 95)

„Aurelius Kastor, der Sohn des Nephervas, und Aurelius Plutarchos, der Sohn des ....., beide Komarchen des Dorfes ....., grüßen Aurelia ....., die Tochter des Schreibers Ammonios.

Wir haben von dir für die 6. und 7. Indiktion als Zahlung für Waid (‘Υπ(ἐρ) τιμῆς ἰσάτεως), der an das officium rei privatae abzuführen ist, auf deinen Namen für neun Aruren und auf den Namen des Patermuthios und seiner Frau ... für eine weitere Arure, für die insgesamt 10 Aruren,

für die genannten zwei Jahre, dreitausend Silberdrachmen, in Zahlen 3000 Dr., erhalten. Im 5. Konsulat des Constantinus Augustus und dem 1. Des Licinius Caesar, am 18. (?) Phaophi ...

(2. Hd.) Wir, Aurelius Kastor und Aurelius Plutarchos, haben als Zahlung für Waid für die beiden genannten Jahre die dreitausend Silberdrachmen wie oben steht erhalten. Ich, Aurelius Ammon, habe für sie geschrieben, da sie schreibunkundig sind.

(3. Hd.) Sie haben auch für die 4. und 5. Indiktion durch Ammon ... erhalten.“

Nimmt man die Angaben aus der Ablieferungsliste P.Oxy. VII 1052 Zeile 19 f. ἰσάτεως. [Σ]ερόφωος δ(ὀ)κεντ(ηναρία) η λί(τραι) λε = „An Waid / Aus dem Dorf Seryphis 8 centenaria 25 litrai (= 264 kg)“ hinzu, dann spricht dies dafür, daß hier an eine Ablieferung des Farbstoffs in Pulverform gedacht ist. Also erst nach dem arbeitsintensiven Bearbeitungsprozeß, den der römische Staat auf die Steuerpflichtigen abwälzte und durch den das ursprüngliche Blattgewicht auf 5 % Trockenmasse bzw. verwendungsfähiges Farbpulver reduziert wurde.<sup>15</sup> Um das hier genannte Gewicht von 264 kg Farbstoff zu erreichen, mußte man immerhin rund 5.28 t Waidblätter abernten und verarbeiten.<sup>16</sup>

Aus diesen Zeugnissen läßt sich demnach erschließen, daß im spätantiken Ägypten der Anbau der wichtigsten pflanzlichen Farblieferanten für die Farben Blau [ἰσάτις] und Gelb [ὄχομένιον, κνήκος] vom römischen Staat kontrolliert wurde. Obwohl m.W. dafür bisher eine ausdrückliche Bestätigung noch aussteht, darf man daraus mit einer gewissen Zuversicht die Vermutung entwickeln, daß auch andere farbliefernde Pflanzen wie die rotfärbende *Rubia tinctorum* oder Krapp ebenfalls einer staatlichen Kontrolle und Ablieferungspflicht unterworfen waren und daher auch gezielt angebaut wurden.

12. Hagedorn 1975b, 91-95.

13. Hagedorn 1975a, 85-90. Schweppe 1993, 185-187 nennt zwei unterschiedliche Farbstoffe, das Carthamin = Saflorkarmin und Saflor, die man beide aus dem Saflor (*Carthamus tinctorius*) gewinnen konnte.

14. Lombard 1978, 128-129.

15. Der Herstellungsprozeß wird bei Fischer 1997, 14-17 beschrieben.

16. Die Berechnung wurde nach Schilbach 1970, 160 vorgenommen. Demnach entsprechen 1 litra (λογαρικῆ λίτρα) ca. 324 g und 1

Für eine solche Vermutung könnte auch eine Novelle Kaiser Valentinians sprechen, die sich Nordafrika widmet.<sup>17</sup> Die Motivlage des römischen Staates darf als weitgehend eindeutig gelten, d.h. es sind sowohl fiskalische Motive als auch die Versorgung der staatlich kontrollierten Textilproduktion mit wichtigen Rohstoffen zu bedenken.<sup>18</sup>

Krapp (*Rubia tinctorum*) wurde bereits relativ früh gezielt angebaut, was Plinius bestätigt.<sup>19</sup>

Plin. NH 19.47: Sunt etiamnum duo genera non nisi sordido nota volgo, cum quaestu multum polleant, in primis rubia, tinguendis lanis et coriis necessaria, lautissima Italica et maxime suburbana, et omnes paene provinciae scatent ea. Sponte provenit seriturque ...

“Es gibt auch zwei Arten (von Pflanzen), die nur dem gemeinen Volk bekannt sind, aber doch viel einbringen: zuerst der Krapp (*rubia*), der zum Färben der Wolle und von Häuten notwendig ist. Den besten liefert Italien und vor allem die Umgebung der Stadt (also Rom), aber auch fast alle Provinzen sind überreich daran. Er wächst wild und wird auch angebaut....“

Ein problematischer Fall ist der Saflor (*Carthamus tinctorius*).<sup>20</sup> Die spätantiken Belege (s.o.) sichern für diese Zeit ein wahrscheinlich monopolmäßige Bewirtschaftung dieser farbliefernden Pflanze, doch wir müssen hier von einer doppelten wirtschaftlichen Bedeutung dieser Pflanze ausgehen. So wird der Anbau von Saflor oder *knekos* bereits in den ptolemäischen ‚Revenue Laws‘ aus dem 3. Jh. v. Chr. geregelt. Damals interessierte man sich aber für den Saflor vor

allem unter dem Gesichtspunkt des Ölmonopols und nicht als möglichen Lieferanten eines Farbstoffs.<sup>21</sup> Was sich an den wirtschaftlichen Rahmenbedingungen zwischen der Zeit der Ptolemäer und der Spätantike geändert hat, entzieht sich meiner Kenntnis.

***Farbstoffe, die nicht im Bereich des Imperium Romanum vorkamen und daher importiert werden mußten.***

Für den grenzüberschreitenden Handel haben wir ein wichtiges, aber auch wegen des komplizierten Inhaltes nicht unproblematisches Zeugnis. Es handelt sich um ein großes Fragment aus dem Werk ‚De delatoribus‘ des Juristen Marcianus. Die Nachricht ist gut datiert, da es sich um ein kaiserliches rescriptum aus der gemeinsamen Regierungszeit der Kaiser Marcus Aurelius und Lucius Verus (161-169) handelt.<sup>22</sup>

Unter dem Gesichtspunkt ‚Farbe‘ sind zunächst die folgenden vier Warengruppen bemerkenswert, obwohl sie keinen Farbstoff im eigentlichen Sinne nennen, sondern gefärbte Vorprodukte. Das wären zunächst die ‚pelles Babylonicae‘ und die ‚pelles Parthicae‘, also gefärbte Lederhäute von Zickeln und Lämmern, die man zur Weiterverarbeitung ins Imperium Romanum importierte. Was allerdings den Unterschied zwischen babylonischen und parthischen Häuten ausmachte, ist unbekannt. Man kann also wie bei den dabei verwendeten Farbstoffen nur spekulieren.<sup>23</sup> Dies gilt auch für die ‚vela tincta‘, hinter denen man gefärbte Wandbehänge und Teppiche vermuten kann. Eindeutig hinsichtlich des Farbstoffs sind wohl die ‚purpura‘, unter denen ich mit Purpur, möglicherweise auch mit Purpurersatz, gefärbte Gewebe verstehe. Auch mit Purpur gefärbte Rohwolle oder Garne wären denkbar.

centenarium (κεντενάριον) 32 kg. Dies entspricht dem Gesamteindruck der Ablieferungsliste, wo lediglich die verwendungsfähigen Produkte eingefordert wurden.

17. Nov. Valent 13 (21. Juni 445).

18. Die Materialversorgung der staatlich dirigierte Textilproduktionen ist noch weitgehend ungeklärt. Vgl. einstweilen immer noch Jones 1960, 183-192. Hierbei handelt es sich um eine Vorarbeit für die spätere Behandlung in Jones 1964, 836-837.

19. Plin. NH 19.47 und 24.95.

20. Sandy 1989.

21. Bingen 1952.

22. Dig. 39.4.16.6-7.

23. Herz 1985, 89-106.

Allerdings gibt es einen Eintrag in dieser Liste, der Anlaß zum gründlichen Nachdenken liefert. Denn es wird auch fucus genannt, was man üblicherweise als Hinweis auf Orseille oder die Färberflechte (*Rocella tinctoria*) versteht, also eine Pflanze, die einen roten Farbstoff liefert. Hier darf man sich allerdings mit Recht die Frage stellen, warum mußte man gegen hohe Kosten (man zahlte immerhin 25 % Außenhandelszoll) den Farbstoff einer Pflanze importieren, die sowieso überall im eigentlichen Mittelmeergebiet vorhanden war.

Ich kann daher nicht völlig ausschließen, daß sich hinter ‚fucus‘ das Produkt einer völlig anderen farbliefernden Pflanze verbirgt oder daß ‚fucus‘ sogar stellvertretend für eine ganze Gruppe von vergleichbaren Farblieferanten steht. Dabei kann man hier möglicherweise auch den echten blaufärbende Indigo anschließen, der damals ebenfalls ins Mittelmeergebiet importiert werden mußte.

Leider wird in dieser Liste nicht das rotfärbende Brasilholz aufgeführt, das in islamischer Zeit (Zeugnis der Geniza von Kairo) eine sehr große Bedeutung hatte.<sup>24</sup> Das rotfärbende Brasilholz stammte ursprünglich aus Ostasien, wo die entsprechenden Bäume etwa auf der Insel Java vorkamen.<sup>25</sup> Da aber in der Liste des Macrianus das Aloeholz (alche) als gesonderter Artikel erwähnt wird, könnte auch das Brasilholz bereits in römischer Zeit importiert worden sein.

Wenn es um die Frage geht, in welcher Form diese Farbstoffe in den Handel kamen und transportiert wurden, dann kann man m.E. ohne besondere Bedenken auf die mittelalterlichen Belege zurückgreifen, denn ich gehe davon aus, daß sich in diesem Bereich relativ wenig geändert hat. Demnach kann man folgendes vermuten:

- Krapp in getrockneter Form als Krappwurzeln
- Waid in fermentierter Form als Waidkugeln
- Saflor in getrockneter und dann wahrscheinlich gemahlener Form
- Safran in Form der gezupften und getrockneten Blütenblätter

Als Verpackungsformen darf man an Säcke oder Packen denken, die man sowohl auf Tragtiere laden als auch leicht als Sonderlast auf Schiffen verstauen konnte. Wenn man etwa die 264 kg Waid aus P.Oxy. VII 1052 als Beispiel nimmt, dann war dies eine Last, die man ohne weiteres auf zwei, höchstens drei Esel packen konnte.

Gerade die teureren Farbstoffe dürften kaum in größeren Mengen in den Handel gekommen sein. So denke ich z.B. beim Safran an einen eher kleinteiligen Handel mit Mengen, die sich im Pfund-, möglicherweise sogar im Unzenbereich bewegten.

Ich habe hier Hinweise zusammengestellt, die mir eher zufällig aufgefallen sind. Doch selbst diese Auswahl dürfte deutlich gemacht haben, daß wir hier ein sehr wichtiges Teilgebiet der antiken Technik- und Wirtschaftsgeschichte vor uns haben, das eine intensivere Untersuchung lohnen dürfte.

## Bibliographie

- Bartel, A. & Codreanu-Windauer, S. (1995) Spindel, Wirtel, Topf. Ein besonderer Beigabenkomplex aus Pfakofen, Lkr. Regensburg, *Bayerische Vorgeschichtsblätter* 60, 251-272.
- Berke, H. (2010) *Chemie im Altertum. Die Erfindung von blauen und purpurnen Farbpigmenten im Altertum*, Abhandlungen der Nordrhein-Westfälischen Akademie der Wissenschaften. Naturwissenschaften und Medizin Vorträge 475, Paderborn, Wien, Zürich.
- Berke, H. (2006) *Chemie im Altertum. Die Erfindung von blauen und purpurnen Farbpigmenten im Altertum*, Konstanz.
- Bingen, J. (1952) *Papyrus Revenue Laws*, nouvelle édition du texte, Sammelbuch Beiheft 1, Göttingen.
- Fischer, F. (1997) *Waid. Das blaue Wunder, Wiederentdeckung einer alten Nutz- und Kulturpflanze*, Köln.
- Goitein, S.D. (1967) *A Mediterranean society. The Jewish communities of the world as portrayed in the documents of the Cairo Geniza I. Economic foundations*, Berkeley, London.
- Hagedorn, D. (1975a) Zum Anbauverbot für ἰσάτις, ὀχομένιον und κνήκος, *ZPE* 17, 85-90.
- Hagedorn, D. (1975b) Waid für die res privata. Eine Neuedition von SB X 10264, *ZPE* 17, 91-95.

24. Goitein 1967, 45-46.

25. Schweppe 1993, 414-419.

- Heimpel, H. (1926) *Das Gewerbe der Stadt Regensburg im Mittelalter*, Stuttgart.
- Herz, P. (1985) Parthiciarius und Babyloniarus. Produktion und Handel feiner orientalischer Lederwaren, *Münstersche Beiträge zur antiken Handelsgeschichte* 4 II, 89-106.
- Jones, A.H.M. (1960) The cloth industry under the Roman Empire, *Economic History Review* 13, 183-192 (= *The Roman economy*, ed. by P.A. Brunt, Oxford 1974, 350-354)
- Jones, A.H.M. (1964) *The Later Roman Empire. A social, economic and administrative survey*, Oxford (2nd ed. Oxford 1973).
- Lombard, M. (1978) *Les textiles dans le monde musulman VIIe – XIIIe siècle*, Paris, La Haye, Civilisations et Sociétés 61, New York.
- McGeough, K.M. (2007) *Exchange relationships at Ugarit*, Leuven, Paris, Ancient Near Eastern Studies Supplement 26, Dudley/MA.
- Sandy, D.B. (1989) *The production and use of vegetable oils in Ptolemaic Egypt*, BASP Supplements 6, Atlanta/Georgia.
- Schilbach, E. (1970) *Byzantinische Metrologie*, München.
- Schweppe, H. (1993) *Handbuch der Naturfarbstoffe. Vorkommen – Verwendung – Nachweis*, Hamburg.
- Takmer, B. (2007) Lex portorii provinciae Lyciae. Ein Vorbericht über die Zollinschrift aus Andriake aus neronischer Zeit, *Gephyra* 4, 165-188.
- Verri, G. (2009) The spatially resolved characterization of Egyptian Blue, Han blue and Han purple by photo-induced luminescence digital imaging, *Anal. Bioanal. Chem.* 394, 1011-1021.

## Purple and its Various Kinds in Documentary Papyri

Ines Bogensperger

“Not all purples were equal, and not all purple was purple.”<sup>1</sup>

The colour purple evokes an inestimable, priceless luxury in our understanding. It almost belongs in a legendary world along with other exquisite goods. Purple is seen as example *par excellence* for a symbol of social status, a token of prestige. A significant study on the importance of purple has brought to light the persistent desire for this colour throughout the Greek and Roman world.<sup>2</sup>

Literary sources from Roman times provide us quite comprehensive information on the colour and its sources. The most often quoted author is doubtlessly Caius Plinius Secundus, known as Pliny the Elder, who compiled specialist knowledge in 37 books on various topics. In the chapter on sea animals of his *Naturalis Historia* Pliny covers shellfish, amongst them the purple snails (Plin. NH 9.124–141). At this point Pliny gives a description of the purple dyestuff obtained from the animal and describes the dyeing process (Plin. NH 9.133–135). His excursus is the most detailed ancient description of the dyeing method with mollusc-purple upon which modern experiments in dyeing are based.<sup>3</sup> However, the actual reason, why Pliny describes purple dyeing, is

not that he is interested in dyeing fabrics in the first place. He describes maritime creatures, in particular the sea snails, and as such he pays some tribute to its characteristic feature: the colourfast dyestuff purple.

The Roman author Vitruvius and his work *De architectura* provides further information. Unlike Pliny, Vitruvius focuses on colours used as pigments for painting (*decorae picturae*, as in Vitr. De arch. 7.13–14). Already in his description diverse terms for ‘purple’ are used and it shows quite obviously, that different kinds of purple were produced, even from various species of molluscs. For a quick and convenient reference for the reader, the Latin text with an English translation of chapter 13 is presented in the following:<sup>4</sup>

*1. Incipiam nunc de ostro dicere, quod et carissimam et excellentissimam habet praeter hos colores aspectus suavitatem. Id autem excipitur e conchylio marino, e quo purpura efficitur, cuius non minores sunt quam ceterarum <rerum> naturae considerantibus admirationes, quod habet*

1. Cleland *et al.* 2009, 155 s. v. purple.

2. Reinhold 1970.

3. *E.g.* Koren 2005, Boesken Kanold 2005 and 2011, Meiers 2013.

4. Text and translation: Granger 1970, 126-127.

*non in omnibus locis, quibus nascitur, unius generis colorem, sed solis cursu naturaliter temperatur. 2. Itaque quod lexitur Ponto et Gallia, quod hae regiones sunt proximae ad septentrionem, est atrum; progredientibus inter septentrionem et occidentem invenitur lividum; quod autem legitur ad aequinoctialem orientem et occidentem, invenitur violacio colore; quod vero meridianis regionibus excipitur, rubra procreatur potestate, et ideo hoc Rhodo etiam insula creatur ceterisque eiusmodi regionibus, quae proximae sunt solis cursui. 3. Ea chonchylia, cum sunt lecta, feramentis circa scinduntur, e quibus plagis purpurea sanies, uti lacrima profluens, excussa in mortariis terendo comparatur. Et quod ex concharum marinarum testis eximitur, ideo ostrum est vocitatum. Id autem propter salsuginem cito fit siticulosum, nisi mel habeat circa fustum.*

1. We now turn to purple, which of all is most prized and has a most delightful colour excellent above all these. It is obtained from sea shells which yield the purple dye, and inspires in students of nature as much wonder as any other material. For it does not yield the same colour everywhere, but is modified naturally by the course of the sun. 2. What is collected in Pontus and Gaul is black because these regions are nearest to the north. As we proceed between the north and west it becomes a leaden blue. What is gathered in the equinoctial regions, east and west is of a violet

colour. But in the southern regions it has a red character; for example, in Rhodes and other similar regions which are nearest the sun's course. 3. When the shells have been collected, they are broken up with iron tools. Owing to these beatings a purple ooze like a liquid teardrop is collected by bruising in a mortar. And because it is gathered from the fragments of sea shells it is called *ostrum* [*Gk. ostreon = oyster*]. On account of its saltness it soon dries unless it is mixed with honey.

Literature and in particular poetry use the effects and ambiance created by colours. The richness and the outstanding importance of the red colours, especially purple, has long been recognized.<sup>5</sup>

Apart from literary sources, epigraphical and papyrological documents reveal additional evidence on an era, where purple played a significant role. Papyrus texts from Egypt reflect the daily life and therefore represent valuable and unique evidence for our understanding. However, the main reason of writing these documents was not to record information on dyestuffs or dyeing-methods, but often a different one, which takes effort to evaluate the information contained and occasionally leaves the modern reader in the dark.

In a specific papyrological study Greek papyri were examined in terms of the meaning of *πορφύρα* and its related forms.<sup>7</sup> The aim was to determine, whether the documents refer to purple wool or to purple dye. By comparing the indicated weight small amounts of weight were contributed to purple dyestuff rather than purple-dyed wool. A conclusion, which was later on questioned.<sup>8</sup>

5. E.g., Blümner 1892, 184-199.

6. Monica Guilimi, personal communication by e-mail (27.08.2014), based on non-invasive analysis of the textile (FORS) supervised by Maurizio Aceto; these tests confirmed previous VIS-spectroscopy results of Robert Fuchs and Doris Oltrogge in September 2012. Analyses using UHPLC are planned for 2017.

7. Worp 1997.

8. Experiments based on ancient archaeological textiles found in the Eastern Desert of Egypt aimed to question, if one stater of wool is sufficient to spin the weft yarn needed for the ornaments (Cardon *et al.* 2011). Considering the fineness of the yarns used, the possible length of yarn was calculated based on 1 stater (c. 13.5 g.) of spun wool. The result is surprisingly quite clear and contradicts the previously mentioned study. "Indeed, 1 stater of purple-dyed wool may often have been enough to decorate one set of garments (*synthesis*) consisting of a tunic with thin purple *clavi* plus a matching mantle with purple *gammas* of average size [...]" (Cardon *et al.* 2011, 212).



**Fig. 1.** P. Vindob. Stoff 284; © Austrian National Library, Vienna. According to non-invasive analyses the purple coloured wool of the decoration was obtained from mollusc-dyestuffs.<sup>6</sup>

One additional observation of this study were the various kinds and varieties of purple attested in the Greek papyri throughout the times. That various kinds of purple were available on the market may be best seen in chapter 24 of the *Edictum Diocletiani de pretiis rerum venalium* (AD 301).<sup>9</sup> The heading *περὶ πορφύρας* implies that all items listed were generally seen as ‘purple’ in ancient times. A study was able to demonstrate, that different dyestuffs and different dyeing methods were employed in order to produce ‘purple’.<sup>10</sup>

This is an attempt to compile various kinds of purple attested in Greek documentary papyri and to amplify the previous mentioned study. The Greek term *πορφύρα* and its related forms are attested over 200 times between the 3<sup>rd</sup> century BC and 7<sup>th</sup> century AD in papyrological databases. Firstly, various compositions with *πορφύρα*, *πορφύρεος* respectively *πορφυροῦς* denoting different purples were collected. Secondly, other terms with the meaning of purple were identified. Thirdly, the content of the texts was carefully examined and compared in order to gain a better understanding.

### True and false purple

Today we tend to speak of ‘true’ purple whenever referring to mollusc-dyestuff. This might be connected with the well-known and often quoted literary sources on dyeing with purple-snails as previously mentioned. So far, remains of three snail species have been found by archaeologists in deposits within the Mediterranean region:<sup>11</sup> *Hexaplex trunculus* L. (also known as *Murex trunculus* L.), *Bilonus brandaris* L. (often quoted as *Murex brandaris* L.) and *Stramonita haemastoma* L. (or known as *Thais haemostoma* L. and actually a rockshell).<sup>12</sup>

9. Lauffer 1971, 167-168; Steigerwald 1990.

10. Steigerwald 1990, but also Steigerwald 1986 and K. Droß-Krüpe & C. Brøns, forthcoming.

11. Reese 2010; Steigerwald 1986, 5.

12. Koren 2005, 137; Cardon 2007, 566-586.



The question arises, if there was something like a *terminus technicus* for the use of true, mollusc-purple in ancient times. Indeed, one could see such a distinctive meaning in SB XII 11075.11 (1<sup>st</sup> half of 4<sup>th</sup> or 5<sup>th</sup> century AD; Oxyrhynchos). Unfortunately, the letters, which would have contained the exact type of garment mentioned, are lost. The unknown garment is described as [...] *πλουμαρικὸν ἀληθινοπόρφυρον*, which for the sake of convenience we shall simply translate as “decorated with true purple”.<sup>13</sup>

In the same document we read of a ἄλλ[λο δε] λμ[ατ]ικομαφόρι[ο]ν Μωτωνήσιον [ἀλ]ηθινῆς μικτῆς πορφύρας (l. 8), a garment called ‘Dematikomaphorion’ made of mixed true purple, that is carefully distinguished from the before mentioned garment (l. 7: ἄλλο δελματικομαφόριον ὀνύχινον ἀχαοπόρφυρον).

Within documentary papyri the adjective ἀληθινοπόρφυρος has already been attested in earlier times. This can be seen in the letter P.Oxy. I 114 = Sel.Pap. I 131 (2<sup>nd</sup>–3<sup>rd</sup> century AD; Oxyrhynchos), in which the sender called Eunoia deals with pawned goods. Amongst them we find a χιτῶν καὶ μαφόρτιν λευκὸν ἀληθινοπόρφυρον (l. 7), “a tunic and a white hooded cape with true purple border”.<sup>14</sup> Similar to previously mentioned SB XII 11075, the writer lists another garment described as λινούδιον ἐμπόρφυρον (l. 8), “a linen shirt inclining to purple” (according to LSJ).<sup>15</sup>

It might be possible to amend SPP XX 245. 9, an account on clothes from the 6<sup>th</sup> century AD, mentioning ἀλ[η]θινῆς — with a *lacuna* right before — once more to “true purple” similar to SB XII 11075.<sup>16</sup>

In Diocletian’s Edict a kind of purple is also designated by πορφύρα [...] ἀληθινή. The adjective specifies a purple from Miletus, of which two grades are recorded in total (§ 24.6-7).<sup>17</sup> The difference between

these two grades possibly was the use of true mollusc-purple in the dyeing process.

The dyestuffs, the combination, the mixture as well as other ingredients, necessary in order to dye fabrics, have been compiled in dyeing recipes. Fortunately for Late Antiquity, at least two papyri were preserved containing unique information on the ancient knowledge of dyeing and other handicrafts: the Papyrus Leidensis X (P.Leid. X) and Papyrus Graecus Holmiensis (P.Holm.).<sup>18</sup> In the beginning scholars saw the texts as material for forgers, but thanks to further experiments they are nowadays understood as sources for the enhanced knowledge and technology of ancient craftsmanship.<sup>19</sup> Several dyeing recipes concern the production of purple from vegetable dyestuffs. Amongst them we find one text, where the preparation and dyeing of true purple, is literally captured as Πορφύρας ἀληθινῆς στῦψις καὶ βαφή (P.Holm. 100).<sup>20</sup> However, in this recipe no mollusc dyestuff is used at all. We might wonder, if the meaning of true purple necessarily implied the use of sea snails, was colourfast or if the result just looked like real purple.

The existence of the term ‘true purple’ raises the question, if there is something on the contrary, *i.e.*, ‘false purple’. The corresponding antonym is most likely found in ψευδοπόρφυρος, “false” or even “fake purple”, in P.Oxy. VII 1051.15 (3<sup>rd</sup> century AD; Oxyrhynchos). In this inventory of a woman’s property “one women’s shirt of false purple” is listed among other textiles and textile-related items.

A similar kind of false purple may be identified in P.Oxy. XLII 3080.5 (2<sup>nd</sup> century AD; Oxyrhynchos): this is an order, an ἐντολή, for ten staters of counterfeit purple (παράτυπος).<sup>21</sup> In this document, stater functions as a unit of weight (c. 13.5 g), so unfortunately we cannot deduce any information on the price

13. Regarding the meaning of *πλουμαρικὸς et varia* see J. P. Wild in this volume, or Prunetti 1998.

14. Translated by Bagnall & Cribiore 2006, 295.

15. The translation of this item as “a garment of purple linen” does not seem correct (Bagnall & Cribiore 2006, 295).

16. P.Leid.Inst.13, note to l. 29 (= BL IX, 349). Moreover, we find ‘true purple’ in the 2<sup>nd</sup> century papyrus P.Strasb. IV 222.14 from Oxyrhynchos.

17. Steigerwald 1990, 258-261.

18. Halleux 1981 with a french translation.

19. *E.g.*, Martínez García 2013; Kreuzner 2013.

20. Halleux 1981, 135-136.

21. Worp 1997, 57, 59.

of fake purple. We only learn that ca. 135 g of such dyed material were needed.

In inventories, the colours of the textiles were meticulously registered as distinguishing features. A circumstance that might be useful for our further considerations. In P.Oxy. VII 1051, before the term fake purple, we read of πορφύρας ῥιζίου (l. 13–14), which is translated in the *editio princeps* as “vegetable purple” and probably refers to madder as dyestuff (ῥιζίου: little root).<sup>22</sup> It is noteworthy that in this inventory madder-purple differs from false purple. Scholars sometimes describe madder-purple as imitation of ‘true purple’, a point of view that is not far away from seeing madder-purple as counterfeit. In light of the clear terminology in P.Oxy. VII 1051, more caution is perhaps needed in our modern view. Often, we encounter a lack of evidence. Another, yet unsolvable question is what dyestuff was used for producing ‘false purple’.

### Sea-purple

Less ambiguity may be seen in the term ‘purple from the sea’ which is attested in a letter of Tetos to her father: BGU VI 1300 = C.Ptol.Sklav. II 237 (4<sup>th</sup> May 210 BC or alternatively 29<sup>th</sup> April 193 BC; unknown provenance). A most appropriate modern title was chosen for the English translation: A shopping list of luxuries.<sup>23</sup>

Tetos to her father greetings. If you are well and things are otherwise according to your wish, it would be as we wish. I myself am well, and so are my mother and everyone in our household. When you sail upriver, please bring ...and 2 shuttles, 2

medium-sized boxes and 3 smaller ones, 2 caskets, a case for alabaster ornaments, 2 tubes, 2 probes, an unguent box with a ring base and a Sikyonian goblet, 5 stater’s weight of myrrh, 3 of nard oil, myrrh oil, oil for the girl for the head...of purple and 2 rings, a golden mirrorbox, medium-white linen cloths with purple; and with respect to the slave girl, who was on the other side at Oxyrhyncha, take care that you manage matters concerning her securely and that nothing thus gets in your way. And bring up also 2 combs, 2 hairnets, 2 scarlet ones, 2 hair clasps, earrings (?) for the girl, a stater of sea-purple dye. Farewell, Year 12, Phamenoth 22.

In her letter Tetos explicitly asks her father — apart from many other requests for luxury items — for one stater of πορφύρα θαλάσσια, *i.e.*, sea-purple. The term ‘sea’ most probably indicates the provenance of the purple rather than any specific hue resembling the sea.<sup>24</sup>

The fact that Tetos knew exactly, what she wanted, can be seen in her clear use of colour-terms: Besides πορφύρα (l. 18) an alternative expression is used for purple, ὀστρίνος (l. 16), which also refers to shellfish-purple and shall be discussed later. Moreover, Tetos requests two κόκκινα hairnets (l. 24). The adjective κόκκινος is translated as scarlet (LSJ), and literally implies the use of the scale insect kermes *coccus* (*Kermes vermilio* P.), *i.e.*, the Polish cochineal or the Armenian cochineal, another high-quality dyestuff used.<sup>25</sup> The dyestuff of the scale insect is as well considered by Pliny (Plin. NH 21.45–46) or even by Dioskurides (Mat. med. 4.48).

22. On Dyer’s and wild madder see: Cardon 2007, 107-124.

23. Bagnall & Cribiore 2006, 106.

24. Cardon 2006, 56.

25. Hofmann-de Keijzer *et al.* 2007, 214; Cardon 2007, 609-619; Froschauer 2007, 704. Regarding the terminology of insect dyes, two doctrines can be seen amongst scholarship at present: one that denotes all insects from the ancient Old World as ‘kermes’, in other words follows a historic approach; the other doctrine distinguishes coccid insects according to the ratio of their major or minor components, *i.e.* kermesic acid or carminic acid. As carminic acid is the main component detected in the New World Mexican cochineal, but is also found in other kinds of scale insects from Europe and the Mediterranean, the terminology Polish and Armenian ‘cochineal’ is used in analogy. As this paper aims to discuss dyestuffs, I decided to follow the terminology based on chemical composition according to analytical UHPLC-analyses. For further reading see Serrano *et al.* 2015.

It cannot be determined if indeed purple-dye was meant in BGU VI 1300 = C.Ptol.Sklav. II 237, as it was suggested in the English translation. In experiments based on the evidence from archaeological textiles, one stater (c. 13.5 g.) of purple-dyed wool proved to be enough to weave the ornaments of a tunic and a mantle.<sup>26</sup> Hence the question, whether one stater of purple dyestuff or purple-dyed wool was requested by Tetos, has to be left unanswered for the time being.

As equivalent to θαλασσοπόρφυρος, the adjective ἀλιπόρφυρος is listed in Kretschmer & Locher's *Rückläufiges Wörterbuch*, "of sea-purple, of true purple dye".<sup>27</sup> It derives from ἀλουργά which is attested in the Byzantine encyclopaedia Suda and is a synonym.<sup>28</sup> A related expression may possibly be seen in SPP XX 85.1 by restoring ἀ[λικ]ή.<sup>29</sup>

### Common purple

The colour purple includes various hues and shades depending on the dyestuffs and dyeing recipes used. The colour spectrum reaches from reddish to a bluish purple. Such diversity is pictured in different terms, as we have seen already. Sometimes we encounter a specific kind of purple, but it is impossible to visualize the actual colour hue. This is the case for a garment of common purple (κοινοπόρφυρος<sup>30</sup>), which is mentioned in the marriage contract SPP XX 31.17 = CPR I 21.17 (AD 13<sup>th</sup> of August 230; Ptolemais Euergetis).

### Rose-coloured and splendid bright purple

A kind of purple, of which we get at least an impression of its hue, may be described as ῥοδινοπόρφυρος,

rose-coloured purple.<sup>31</sup> The term is well known from Roman literature: in the famous *carmen* 64 on the marriage of Peleus and Thetis, Catullus describes the purple coverlet on the marriage couch (Catullus c. 64.47–49):

*Pulvinar vero divae geniale locatur  
sedibus in mediis, Indo quod dente  
politum tinctorum tegit roseo chonchylis  
purpura fuco.*<sup>32</sup>

Catullus uses colours and their striking characteristics for creating his unique dramatic effects, especially in this ekphrasis being very important for the plot.<sup>33</sup> With *roseus fucus* (φῦκος) a reference to the plant orchil, a species of lichen, may be given.<sup>34</sup>

In documentary papyri, a kind of purple designated as rose-coloured is attested and clearly distinguished from other colours, especially other reds. The γνῶσις ἱματίων SPP XX 245, an account of clothes from the 6<sup>th</sup> century of unknown provenance, lists various clothes (Fig. 2). Many are ticked off, which can be seen by the 'x' on the left serving as a checkmark.<sup>35</sup> One rose-coloured purple shirt, καμῖσ(ιον) ῥοδινοπόρφ(υρον), is registered (l. 11). This account, yet difficult to decipher and to understand due to its preservation, names particularly outstanding garments and textiles. Even three καμῖσια βλάττια were registered, shirts made of a high quality purple, which will be discussed below. Yet, Catullus and our papyrus are separated by six centuries in chronology. Assuming that orchil lichen as dyestuff was implied by this kind of purple, it seems plausible to distinguish it from other purple coloured textiles, particularly in an account.

26. See n. 8.

27. Kretschmer & Locker 1944, 480.

28. Sud. s. v. ἀλουργά alpha 1357 Adler (see also: The Suda on Line: <http://www.stoa.org/sol-entries/alpha/1357>; accessed 12.01.2015).

29. As suggested by Worp 1997, 58, n. 3.

30. Following Johannes Diethart all composita end as -πόρφυρος, see Diethart 1991, 234, No. 46.

31. Regarding the form of the adjective see Diethart 1991, 234, no. 46.

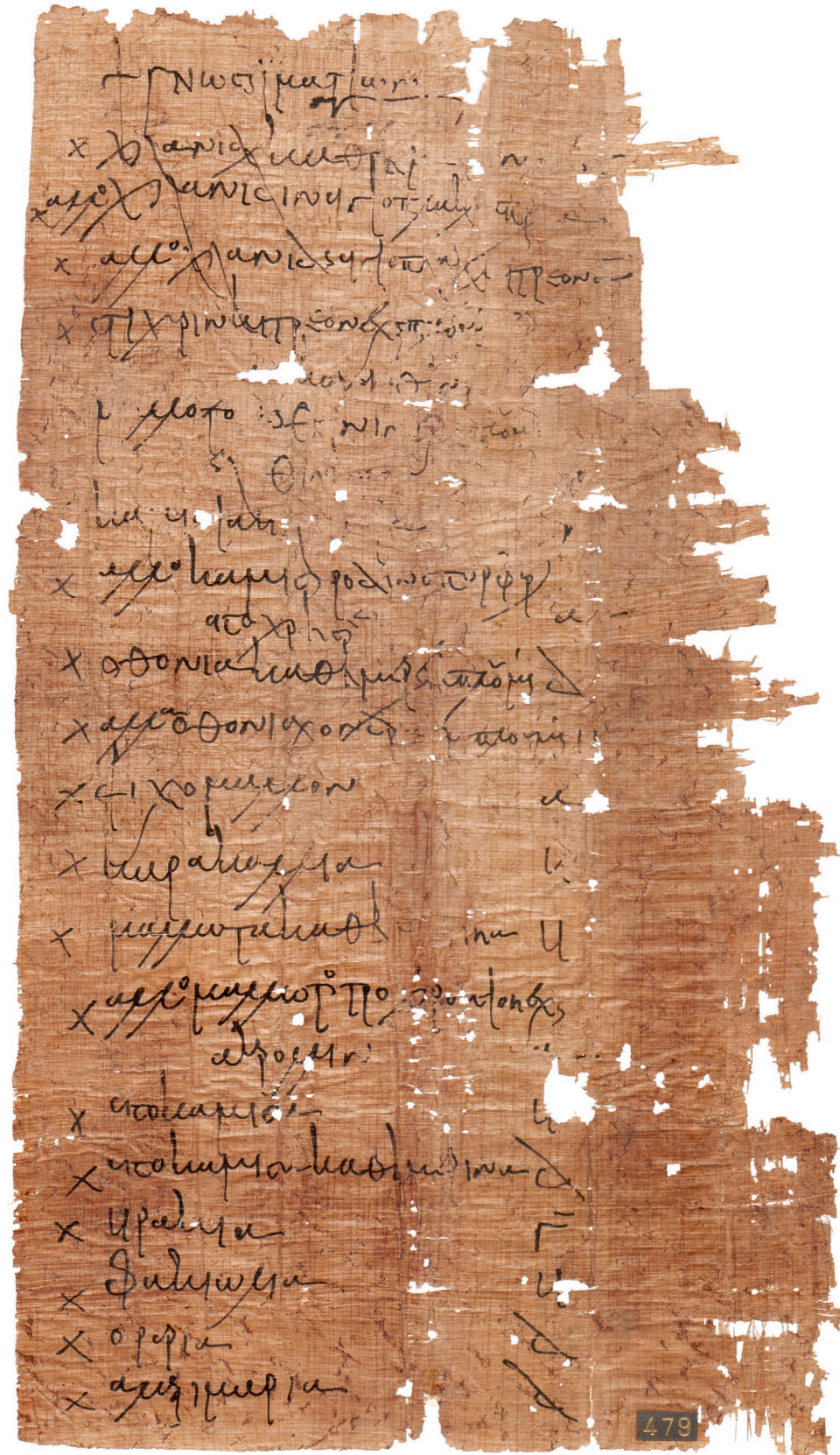
32. "But see, the royal marriage bed is being set for the goddess in the midst of the palace, smoothly fashioned of Indian tusk, covered with purple of the shell tinged with rosy stain" (text and translation: Cornish 1988, 101).

33. Clarke 2004.

34. This was not implied by Blümner 1892, 203. Cf. Plin. NH 26.10; on orchil lichens see Cardon 2007, 495-503: It seems likely, that several species of *Rocella* were used in ancient times, as there are different qualities attested as well.

35. Diethart 1992, 226 (= BL X, 273).

**Fig. 2.** SPP XX 245  
(6<sup>th</sup> century; unknown  
provenance).  
© Austrian National  
Library.



On an ostrakon, a list of dyes is preserved: O.Ashm. Shelt 197 = SB I 2251 (4<sup>th</sup> century AD; Oxyrhynchos). The amount of πορφυροῦ ῥοδίνου λαμπροῦ, a bright rose coloured purple (ll. 7–8), is clearly differentiated from of previous colour, κοκκίνου (l. 6). The latter implies a red obtained from kermes scale insects, which would have been distinguished from any other dyestuff.

The adjective ὀξυπόρφυρος might refer to a special bright variety of purple, a splendid bright purple.<sup>36</sup> In P.Laur. III 82 (late 3<sup>rd</sup> century AD; unknown provenance), which is the account of Isidor, λόγ(ος) Ἴσι(δώρου), ὀξυπόρφυρος is listed amongst κόγ'κίνα (l. κόκκινα), ῥόδινα, σαντύκινα, ποιζίνα and other textile related goods. The *editio princeps* explains it as “di color porpora brillante, splendente”. But is ὀξυπόρφυρος a mere hue or is it even a specific type of purple?

In order to find an answer, we need to crosscheck the term with other relevant sources. In Diocletian's Edict the 4<sup>th</sup> kind of purple is called ὀξυτυρία, a Greek term which is only attested there. According to Gerhard Steigerwald, ὀξυτυρία is the equivalent to the Latin *oxyblatta*, a term used in the legislation of the 4<sup>th</sup> century and obtained by a combination of different purple dyestuffs.<sup>37</sup> This can be clearly seen in the Edict, as the purple ὀξυτυρία is followed by ἀπλῖος πόρφυρος, different types of single-dyed purple.

It seems likely that the term ὀξυπόρφυρος in the documentary papyri dating from Late Antiquity,<sup>38</sup> implies an explicit kind of purple, which is further attested in the contemporary Imperial legislation.

### Purple from specific origin and local purple

In some cases, the colour purple is specified by toponyms. Well known is the Tyrian purple, *color Tyrius*, on which Pliny the Elder and other authors provides

us valuable information (Plin. NH 9.135-137; e.g., Strabo 16.2.22-23). In addition, Pliny links different kinds to their manufacturing centres and lists them according their qualities: “The best Asiatic purple is at Tyre, the best African at Meninx and on the Gaetulian coast of the ocean, the best European in the district of Sparta” (Plin. NH 9.127).<sup>39</sup>

In his Natural history Pliny the Elder relies on other sources, one is king Juba II, who discovered the almost legendary Gaetulian islands, where he installed dye workshops producing the so-called Gaetulian purple (Plin. NH 6.201). The location of these purple-islands remains unclear: some assume that they lay off the Moroccan coast at Essaouira, c. 350 km southwest of Casablanca.<sup>40</sup>

In the documentary papyri from Egypt there might be an attestation of ‘Tyrianthine’ purple in P.Hamb. I 10.23 (2<sup>nd</sup> century AD; Theadelphia, Arsinoites;). It is a submission on stolen goods, amongst which clothes are listed. The adjective used is τυριαντίνην (l. τυριάνθινον).

Apart from Tyre, we find a shipment of two ounces of purple from Berenice, διόνκιον (l. διούγκιον) πορφύρας Βερενγ'κησίας, in a private letter P.Oxy. XX 2273.10 of the end of the 3<sup>rd</sup> century AD (Hermopolites?). The translation of the papyrus according its *editio princeps* is:

To my lady mother Theonis and to my lord brother Ascle ... greetings. Before all things I pray to the gods with whom I am sojourning, that you are well ... I sent to you a cruse of oil, which I had bought for six hundred drachmae, for I have heard that oil is dear with you, also some ..., I also have dried figs; and you will give 150 of them to my brother Cornelianus — and two ounces of purple wool<sup>41</sup> from Berenice in order that you thus make, please,

36. According to Johannes Diethart it is again an adjective: Diethart 1991, 234, No. 47 (= BL X, 93).

37. Cod. Just. 10.21.3 (law of the emperors Gratian, Valentinian II and Theodosius I; promulgated between 383 and 392); Steigerwald 1990, 241-253.

38. Additional attestations of ὀξυπόρφυρος can be found in SB XXVI 16511.7 (6<sup>th</sup> century AD; Hermopolis).

39. Trans. by Rackham 1956, 249; Steigerwald 1986, 22-24.

40. Roller 2003, 115-116.

41. According to Worp 1997, 59 (= BL XI, 160) two ounces (c. 55 g.) would be rather purple-dye than purple-wool, as translated by the editor. However, we might use some caution in this matter, as already pointed out before (cf. n. 8).

**Table 1.** Summary of prices declared by a cooperation of goldsmiths: P.Oxy. LIV 3765 (AD 327; Oxyrhynchos)

Νικαϊνή[ς] (νικαϊνή[ς] papyrus)	λί(τρας) α τάλ(αντα) π	Nicaean (purple)	1 lb. tal. 80
ρίζιν[η]ς (l. ρίζινης)	λί(τρας) α τάλ(αντα) γ	Root (purple)	1 lb. tal. 3
πορφύρα[ς] ἐ]ντοπ(ίου)	λί(τρας) α τάλ(αντα) β	Local (purple)	1 lb. tal. 2
κοκκίνου α	λί(τρας) α τάλ(αντα) η	Scarlet, 1 <sup>st</sup> grade	1 lb. tal. 8
β κοκκίνου	λί(τρας) α τάλ(αντα) β	2 <sup>nd</sup> grade scarlet	1 lb. tal. 2

the frocks and two veils... Be pleased to send me my raven-black veil and my shawl and shake my other dress without fail to prevent it spoiling. I will send you some money if you send back to me the linen cloths which you have made. Let me know what you have received from Dioscorion, Isidorus, and Castor also called Polydeuces, who has once ..., in order that I may know. Receive everything that I send to you ....

The editor of P.Oxy. XX 2273 was unsure, which Berenice was actually meant. Indeed, in the *Lexicon of the Greek and Roman Cities and Place Names in Antiquity* we find Berenice nine times recorded, four of them are located in Egypt alone.<sup>42</sup>

Another kind of purple designated by its origin name is mentioned in a summary of prices declared by a cooperation of goldsmiths: P.Oxy. LIV 3765 (AD 327; Oxyrhynchos). In the 3<sup>rd</sup> column (ll. 16-20) the items listed in Table 1 are shown.

Nicaean purple is also attested in the marriage contract P.Strab. III 131.7 = SB V 8013.7 (AD 363; Arsinoites). Unfortunately, the respective textile is lost, which is designated as being ἀπό νικαινής πορφύρας.

Besides the papyrological evidence, there is a parallel in Diocletian's Edict, more than 60 years earlier: the eighth item is determined as Νεικανή κοκκηρά (§ 24.8).<sup>43</sup> Κοκκηρά from κόκκος means literally the berry from the kermes oak (*Quercus coccifera* L.), but obviously refers to the kermes scale insect, from which a scarlet, crimson red colour was obtained. Therefore, Gerhard Steigerwald interprets the

Nicaean κοκκηρά as purple achieved by the kermes insects as dyestuff.

This interpretation of the Imperial Edict, however, does not apply one-to-one to the previous papyrus text of P.Oxy. LIV 3765, as in ll. 19-20 two qualities of kermes-dye are recorded. It does not seem plausible, that two kinds of kermes-dye are subsequently registered by the name κόκκος, if Nicaean purple was (merely) obtained from kermes insects. Considering all the evidence, we might wonder, if there is another possible explanation for the term Nicaean purple.

The third column of this declaration is even more interesting for our purpose, as – following the Nicaean purple – the price for so called local purple, πορφύρα ἐντόπιος, is recorded. This kind is attested even from earlier times, *i.e.* in P.Oxy. VIII 1153 (1<sup>st</sup> century AD; Oxyrhynchos). This papyrus is a private letter from the father Apollonius to his son Apollonius, who was — according to the address on the verso — staying at Alexandria at that particular time. With the letter he attaches some purple as sample for a garment and in the last sentence, he remarks that “We are going to use local purple” (ll. 26–27: ἐντοπία δὲ πορφύρα | χρήσασθ(αι) μέλλομεν).

The price for local purple is once more given in the declaration P.Harr. I 73.40 = SB XVI 12626.40 (AD 329-331; Oxyrhynchos). In the same column, following local purple, two grades of kermes-dye are recorded, as previously in P.Oxy. LIV 3765. As mere suggestion, respectively idea, based on dye-analyses of preserved Roman textiles, local and Nicaean purple may not be dyes derived from kermes insects alone, but it could refer to a mixture of dyestuffs.<sup>44</sup> Such

42. Zahariade & Bounegru 2013, 1692-1705 s. v. Berenike.

43. Steigerwald 1990, 262–264.

44. The combination of mollusc-purple dyestuff with kermes has been proofed in archaeological textiles from small Roman fortresses, *praesidia*, in the Eastern Desert of Egypt; cf. Cardon 2006, 55-56. Further Zvi Koren demonstrated the clever use of double dyeing with red and blue dyes or even spinning together separately dyed red and blue fibres in Roman textiles from 'En Rahel. As dyestuffs the combination of madder with indigo, or kermes with indigo has been detected: Koren 1999.

combination would also be applicable for Νεικανή κοκκηρά in Diocletian's Edict.

In brief, the toponyms in connection with purple may indicate the origin of the colour and the place where it was manufactured. It also specifies the quality of the colour, as seen in Pliny's text.

### Further terms with the meaning 'purple'

Besides πορφύρα other terms are clearly connected with the highly esteemed colour purple. Some of them attested in documentary papyri are listed in the following:

#### *Blatta-purple*

The Greek βλάττα is a loanword from Latin *blatta*, purple, which is linked with the shellfish-dyestuff. *Blatta* for purple is used in Diocletian's Edict for the first three kinds of purple as μεταξάβλαττα, βλάττα, and ὑποβλάττα (§24.1–3), which are the top qualities and the far most expensive dyes.

Μεταξάβλαττα is composed of *metaxa* and *blatta*. As *metaxa* in Latin refers from the 2<sup>nd</sup> century AD onwards to raw silk,<sup>45</sup> it means the purple-dyed raw silk.

Βλάττα is distinguished from μεταξάβλαττα by the material used, *i.e.* wool. The term *blatta* and its meaning have led to some confusion in academic understanding.<sup>46</sup> *Blatta* is seen as purple-dyed, unspun wool, similar to metaxablatta.<sup>47</sup>

Gerhard Steigerwald demonstrated that originally *blatta* was used as a term for insects.<sup>48</sup> But from Late Antiquity onwards, *blatta* meaning a kind of purple is

associated with the image of clotted blood as can be found in glossaries. Of course, it is not blood, which is obtained from the sea snails, but the hypobranchial gland, from which the dyestuff is obtained.<sup>49</sup> He identifies *blatta* with the *color Tyrius* and the *dibapha Tyria* of Pliny's *Naturalis historia* (Plin. NH 9.135). The ancient city of Tyros is generally seen as point of origin for shellfish-purple.<sup>50</sup> This does not exclude the use of mollusc-dyestuff elsewhere, and the term Tyrian purple could also refer to the specific quality of the dye.

Considering *blatta* as equivalent for Tyrian purple we might get a description of the hue from Pliny the Elder: *Laus ei summa in colore sanguinis concreti, nigricans aspectu idemque suspectu refulgens* (Plin. NH 9.135).<sup>51</sup>

In his study, Gerhard Steigerwald particularly draws attention to Cassiodorus' second letter of Theoderic to Theon, a *vir sublimis*, in his *Variae* (537/538 AD), where the matter of the purple-production from molluscs is discussed (Cassiod. Var. 1.2).<sup>52</sup> There, clearly the production of *blatta*-purple is the issue, which is obtained from sea snails (“[...] *adorandi muricis pretiosissimam qualitatem. [...] conchyliam [...]*”). The purple hue is described as *obscuritas rubens*, blushing obscurity, and *nigrendo sanguinea*, an ensanguined blackness, a description which meets Pliny's precisely.

In the Edict, the third quality of *blatta*-purple is ὑποβλάττα, which is specified by its prefix ὑπό. In terms of colours the Greek prefix ὑπό as well as the Latin *sub* is used for lighter hues.<sup>53</sup> This seems plausible as the various kinds of purple are sorted according to their qualities.

45. Steigerwald 1990, 223–224: μεταξάβλαττη “purple silk”; cf. Aelius Marcianus, Dig. 39.4.16 §7 (c. AD 200); Cod. Theod. 10.20.13 (AD 406); Cod. Theod. 10.20.18 (AD 436).

46. W. A. Schmidt describes it as double-dyed (Schmidt 1842, 128), whereas K. Schneider interprets it as single-dyed purple: RE 23 (1959) 2000–2020, esp. 2013 s. v. purpura (K. Schneider). W. A. Schmidt has written an elaborate commentary on purple dyeing: Schmidt 1842, 96–212.

47. Steigerwald 1990, 232.

48. Steigerwald 1990, 224–237 as βλάττη “purple”.

49. Gerhard Steigerwald refers to the passage in Sidonius Apollinaris' *epistulae* (Sid. Apoll. Epist. 9.13.14–19), which shows that purple was obtained from murex and not insects: Steigerwald 1990, 228.

50. Cf., e.g., Sid. Apoll. Carm. 5.48: *Tyros blattam fert*; but also Plin. NH 9.135 or Strabo 16.2.22–23.

51. “Its highest glory consists in the colour of congealed blood, blackish at first glance but gleaming when held up to the light” (Text and translation: Rackham 1956, 255–256).

52. Steigerwald 1990, 230–231.

53. Steigerwald 1990, 237–241 as ὑποβλάττη.

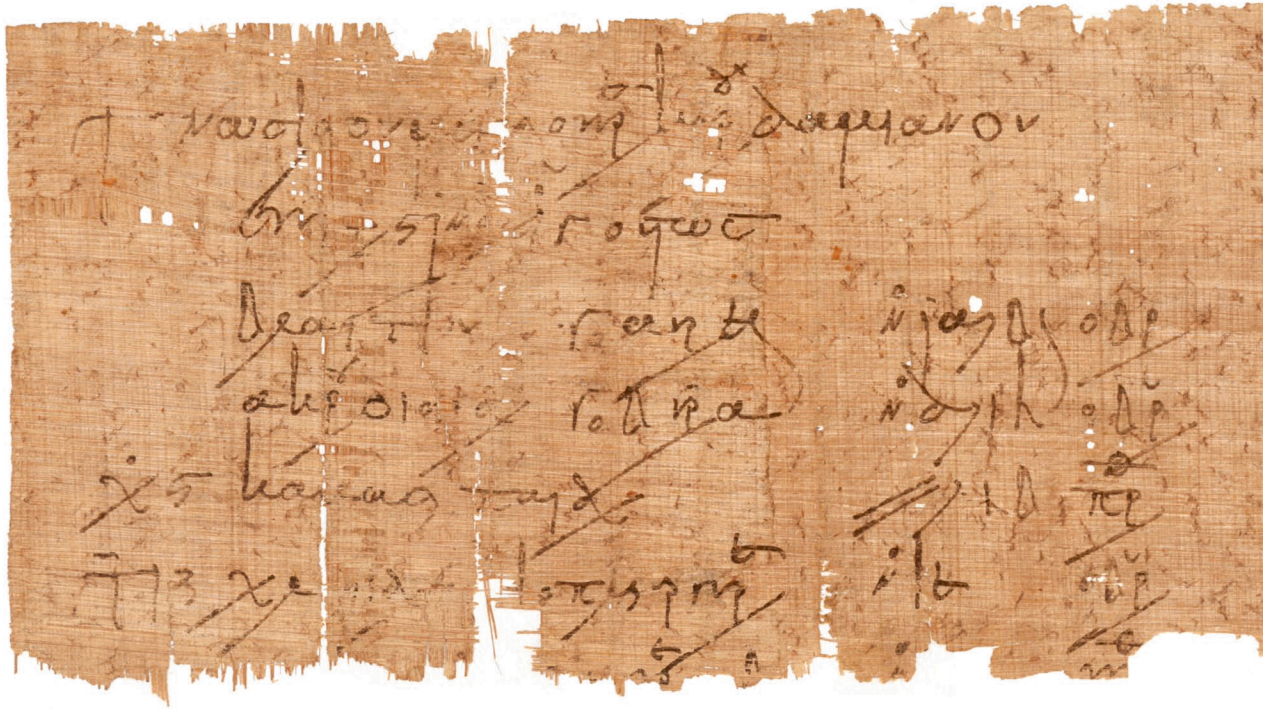


Fig. 3: Detail (left column): account of Damianos (SB XXII 15248); © Austrian National Library

Besides Diocletian's Edict, the term *blatta* is not that often attested in written sources. Much later we find the term *blatta* in documentary papyri from Egypt. In SB XXII 15248.3 (7<sup>th</sup> century; unknown provenance<sup>54</sup>), the account of the most magnificent lord Damianos (γνώσις τοῦ μεγαλοπρε(πεστάτου) κυρ(ί)ου Δαμιανοῦ), lists 1 ounce 5 ½ grammata of *blatta*-purple (Fig. 3). In this case the diminutive of *blatta*, *blattion* (βλαττίον) is used. The account SPP XX 245.10 (6<sup>th</sup> century; unknown provenance) for the already mentioned γνώσις ἱματίων specifies καμίσια βλάττια γ, three shirts with purple decoration<sup>55</sup> besides other cloths.

A possible third attestation for *blatta*-purple in papyri was suggested for P.Leid.Instr. 13.19 (7<sup>th</sup>-8<sup>th</sup> century; unknown provenance), where σκέπασμ(α)

ὀθώνι(νον) (l. ὀθόνι(νον)) λευκοβ(?)λάττι(ον) or even λευκὸν (καὶ) βλάττι(ον) can be read.<sup>56</sup>

So far the papyri confirm clearly the use of the purple kind *blatta* in late antique Egypt, however, they do not yield any specific information on the dyeing-process or on the hue of the colour. All three papyrological documents are much later than Diocletian's Edict, where the term *blatta* marks high quality-dyes. It has to be noted, that SPP XX 245 and P.Leid.Instr. 13 were only possible to decipher because of the clear attestation of *blattion* in SB XXII 15248. This has been achieved by Johannes Diethart, who showed special interest in atthesaurista and rarely attested Greek terms.<sup>57</sup> Therefore a repeated examination of papyri in light of textile production may yield further results.

54. Johannes Diethart suggests as provenance either Arsinoites or Herakleopolites based on a handwritten account of Carl Wessely in the Viennese Collection of Papyri (Diethart 1993, 70).

55. Actually it says three purple-coloured shirts, but as we have seen that *blatta* is a high quality purple obtained by molluscs, I tend to translate it rather as purple-decorated. An idea, how cloths were decorated with purple, might be seen in Fig. 1.

56. Diethart 1993, 73.

57. Diethart 1989, 113-114; Diethart 1993.



*ostrum resp. ὄστρεον and conchylia*

Besides *blatta* other terms used suggest the use of mollusc-purple as dyestuff. In Vitruvius *De Architectura* we hear of *ostrum*, as seen in the Latin text above. In Greek it is ὄστρεον and its adjective ὄστρεϊνος which is used for describing mollusc-purple. This is the case in an inventory P.Oxy. I 109 (end of 3<sup>rd</sup> or early 4<sup>th</sup> century AD; Oxyrhynchos), where one purple κολόβιον is registered amongst other textiles and household goods (l. 5).

This term and its related forms were in use for much longer, as it can be seen in the private letter from Ptolemaic times (BGU VI 1300 = C.Ptol. Sklav. II 237). Besides πορφύρα and sea-purple, Totos used the term ὄστρεϊνος in her shopping list of luxury items.

Obviously terms deriving from κόγχη, mussel, indicates the use of mollusc-purple as dyestuff. In the papyri the colour appears in the list PSI Congr. XVII 18 (4<sup>th</sup> century AD; Oxyrhynchites?) where three oz. of κογχυλίον (FrB I. 26) are recorded.<sup>58</sup> A remarkable and outstanding contract regarding the work of three κογχισταί, purple-dyers, is preserved as P.Grenf. II 87 = Sel. Pap I 23 (AD 23<sup>rd</sup> May 602; Hermopolis). The contract regulates the work of the dyers, the κογχιστική | τέχνη (ll. 14-15, 19-20), which was carried out in the contractor's workshop. Such an explicit designation as purple-dyers indicates their specialisation on this colour, *i.e.*, mollusc-dyestuff. This seems plausible, as the supply on dyestuffs and its various uses become larger, as we also may see from the papyrological evidence so far.

*Hysginum and madder: purple from plant dyestuffs*

As already seen above, the colour purple was obtained from other dyestuffs than molluscs in Antiquity. In ancient literature this is described: *Fiunt etiam purpurei colores infecta creta rubiae radice et hysgino, non minus et ex floribus alii colores* (Vitr. De arch. 7.14.1).<sup>59</sup>

*Hysginum* (ὑσγίνον) is regarded as equivalent with the biblical *tekhelet*, a bluish violet obtained mainly by the species *Hexaplex resp. Murex trunculus*.<sup>60</sup> But also the mixture of murex-purple with kermes, two most precious dyestuffs, is identified with the ancient term *hysginum*.<sup>61</sup> These two statements show a conflict in the hue of *hysginum*, which could be either a bluish, violet or reddish purple.

Considering written documents, we may not get clear evidence either: in a letter of the caring father Cornelius to his son, P.Oxy. III 531 = W.Chr. 482 = C.Pap. Hengstl 83 (2<sup>nd</sup> century AD; Oxyrhynchos), one topic concerns clothing. Cornelius writes to his son that he will send τὸ ἄλλο ζεῦγος τῶν ὑσγείνων (l. ὑσγίνων), “the other pair of scarlet clothes” (l. 17). LSJ seems quite misleading by suggesting a vegetable dye, perhaps kermes, which is apparently contradictory.<sup>62</sup> If we check our other written sources, we find in Pliny's *Naturalis historia* a helpful remark (Plin. NH 9.140): *quin et terrena miscere coccoque tinctum Tyrio tinquere ut fieret hysginum*.<sup>63</sup> There we find a combination of *coccus* with *Tyrius*, *i.e.*, kermes scale insects with mollusc-dye.

However, the addition of kermes scale insects seems less meaningful for the four ισγίνη-purple listed in Diocletian's Edict (§24.9-12). For these items Gerhard Steigerwald suggests the use of plant dyestuffs, such as sea orchils, as basis for the dyeing.<sup>64</sup>

58. The dyeing recipe P.Leid. X 94 also refers to the production of the κογχυλίον colour as purple (Halleux 1981, 106).

59. “Purple colours are also made by dyeing chalk with madder and hysginum. Other colours also are obtained from flowers.” (text and translation: Granger 1970, 127-128).

60. Ziderman 2004.

61. Cardon 2006, 56.

62. LSJ 1904, s. v. ὑσγίνον.

63. “[...] and also a method to blend minerals, and dye with Tyrian a fabric already dyed with scarlet, to produce hysginue colour” (text and translation: Rackham 1956, 258-259).

64. Steigerwald 1990, 264-274. According to Dominique Cardon, lichens growing by the sea were used in Antiquity; only since the Middle Ages the dyeing “industry” turned more to sea orchils (Cardon 2007, 495).

Despite these contradictory views, we may at least sum up that the term *hysginum* designates a combination of various dyes, in order to obtain purple colour. Whether kermes or plants were used, may come to light in future research.

Madder, as mentioned by Vitruvius as *radix rubiae*, gives another highly esteemed red colour. The plant either refers to the cultivated madder (*Rubia tinctorum* L.) or the wild madder (*Rubia peregrina* L.), both species were used in ancient textiles.<sup>65</sup> We already came across the term in the inventory list of P.Oxy. VII 1051 in connection with ‘false purple’.

### Conclusion

Purple is generally perceived as luxury item, as status token and as prerogative of royalty. The Greek term πορφύρα designates several varieties and qualities of purple. Also the colour purple encompasses various hues ranging from bluish to reddish violet.

As written source papyrological documents reveal further information. Throughout the centuries we find several kinds of purple in use: true and false purple, sea-purple, common purple, rose coloured and splendid bright purple, purple from specific origins including local purple etc. Besides πορφύρα other Greek terms were used for purple, which is not only seen in literary sources, but also in the documentary papyrus texts from Egypt.

Papyrus texts, especially documentary papyri, record the daily life of Egypt and sometimes allow us insights into private communication viz. relations. We learn of a widespread use of the colour purple, regardless of gender and even among private persons. At all times purple was constantly and highly esteemed. Papyrological documents, in particular inventories, show the clear use of Greek terms for colours. The manifold attestations of purple can also be seen in the preserved textiles from Egypt. In other words: the various terms attest the great variety of actual dyed textiles in ancient times. By comparing

the papyrological evidence with other written sources, and by considering preserved textiles from Egypt, we encounter a more sophisticated branch in textile production: the dyeing workshops.

In a few cases we may be able to identify the dyestuff(s) used, but in many cases we still remain unsure and can only make suggestions. This applies further for the dyeing methods used.<sup>66</sup>

Future research may be able to pursue these issues and thereby demonstrate the skilled labour, the profound knowledge as well the highly developed technology of ancient dyers.

### Abbreviations

Papyri and ostraca are cited according the Checklist of Editions of Greek, Latin, Demotic and Coptic Papyri, Ostraca and Tablets, Oates, J. F. *et al.* (2001) *Checklist of Editions of Greek Papyri and Ostraca*. BASP Suppl. no. 9, of which the latest edition is found online: [http://library.duke.edu/rubenstein/scriptorium/papyrus/texts/clist\\_papyri.html](http://library.duke.edu/rubenstein/scriptorium/papyrus/texts/clist_papyri.html) (12.01.2015)

Other abbreviations used are:

<i>APapyrol</i>	Analecta papyrologica.
<i>ByzF</i>	<i>Byzantinische Forschungen: internationale Zeitschrift für Byzantinistik.</i>
<i>BASP</i>	<i>The Bulletin of the American Society of Papyrologists: American Society of Papyrologists.</i>
LSJ	Liddell, H. G., Scott, R. & Jones, H. S. (1996) <i>A Greek-English Lexicon</i> . With a revised supplement. Oxford.
<i>MBAH</i>	<i>Münstersche Beiträge zur antiken Handelsgeschichte.</i>
RE	Pauly, A., Wissowa, G. & Kroll, W. (1893-) <i>Real-Encyclopädie der klassischen Altertumswissenschaft.</i>
<i>ZPE</i>	<i>Zeitschrift für Papyrologie und Epigraphik.</i>

65. Cardon 2007, 107-124.

66. See the term πενταβάφος, five times dyed, which appears in connection with πορφύρα: P.Coll. Youtie II 85 (6<sup>th</sup>-7<sup>th</sup> century AD; unknown provenance).

## Bibliography

- Bagnall, R. & Criboire, R. (2006) *Women's letters from ancient Egypt. 300 BC – AD 800*. Ann Arbor.
- Boesken Kanold, I. (2005) The Purple Fermentation Vat: Dyeing or Painting Parchment with Murex trunculus, *Dyes in History and Archaeology* 20, 150-154.
- Boesken Kanold, I. (2011) Purpurissum: Techniques of production inspired by Pliny the Elder. In C. Alfaro et al. (eds.), *Textiles y tintes en la ciudad antigua. Actas del III Symposium Internacional sobre Textiles y Tintes del Mediterráneo en el mundo antiguo. Nápoles, 13 al 15 de noviembre, 2008*, 243-246. Purpureae Vestes III: Archéologie de l'artisanat antique 4. Valencia.
- Blümner, H. (1892) *Die Farbbezeichnungen bei den römischen Dichtern*. Berliner Studien für Classische Philologie und Archäologie 13,3. Berlin.
- Cardon, D. (2006) Haillons précieux. Développement du tissage et de la teinture en Égypte romaine d'après de récentes découvertes de textiles archéologiques. In B. Mathieu et al. (eds.), *L'apport de l'Égypte à l'histoire des techniques. Méthodes, chronologie et comparaisons*, 45-56. Institut Français d'Archéologie Orientale 142. Cairo.
- Cardon, D. (2007) *Natural Dyes. Sources, Tradition, Technology and Science*. London.
- Cardon, D., Nowik, W., Granger-Taylor, H., Marcinowska, M., Kusyk, K. & Trojanowicz, M. (2011) Who could wear true purple in Roman Egypt? Technical and Social Considerations on some new Identifications of Purple from Marine Molluscs in Archaeological Textiles. In C. Alfaro et al. (eds.), *Textiles y tintes en la ciudad antigua. Actas del III Symposium Internacional sobre Textiles y Tintes del Mediterráneo en el mundo antiguo. Nápoles, 13 al 15 de noviembre, 2008*, 197-214. Purpureae Vestes III: Archéologie de l'artisanat antique 4. Valencia.
- Clarke, J. (2004) Colour Sequences in Catullus 'Long Poems'. In L. Cleland & K. Stears (eds.), *Colour in the Ancient Mediterranean World*, 122-125. BAR International Series 1267. Oxford.
- Cleland, L., Davies, G. & Llewellyn-Jones, L. (2009) *Greek and Roman dress from A to Z*. London.
- Cornish, F. W. (1988) *Catullus: Carmina*, revised by G. P. Godd. The Loeb Classical Library. Cambridge.
- Diethart, J. (1989) *Corrigenda und Addenda zu Wiener Papyri*, *ZPE* 76, 107-114.
- Diethart, J. (1991) *Bemerkungen zu Papyri IV. <Korr. Tyche>*, *Tyche* 6, No. 43-51, 233-236.
- Diethart, J. (1992) *Bemerkungen zu Papyri V. <Korr. Tyche >*, *Tyche* 7, No. 63-69f, No. 75, 225-228, 230.
- Diethart, J. (1993) *Dokumentarische Texte aus dem 5.-7. Jahrhundert aus der Wiener Papyrussammlung*, *APapyrol* 5, 69-113.
- Froschauer, H. (2007) Farben und Farbbezeichnungen in Papyri und Textilien. In N. Bosson & A. Boud'hors (eds.), *Actes du huitième congrès international d'études coptes. Paris, 28 juin-3 juillet 2004*, 697-710. Orientalia Lovaniensia Analecta 163. Leuven.
- Granger, F. (1970) *Vitruvius on Architecture*. The Loeb Classical Library. Vol. 2. Cambridge.
- Halleux, R. (1981) *Papyrus de Leyde. Papyrus de Stockholm. Fragments de Recettes*. Les Alchimistes Grecs. Vol. I. Paris.
- Hofmann-de Keijzer, R., Van Bommel, M. & De Keijzer, M. (2007) Coptic Textiles: Dyes, Dyeing techniques and dyestuff analysis of two Textile Fragments of the MAK Vienna. In A. De Moor & C. Fluck (eds.), *Methods of Dating Ancient Textiles of the 1st Millennium AD from Egypt and Neighbouring Countries. Proceedings of the 4th Meeting of the Study Group "Textiles of the Nile Valley" Antwerp, 16-17 April 2005*, 214-228. Tiel.
- Kretschmer, P. & Locker, E. (1944) *Rückläufiges Wörterbuch der griechischen Sprache*. Göttingen.
- Koren, Z. C. (1999) Microscopic and Chromatographic Analyses of Decorative Band Colors on Nabatean "En Raḥel Textiles — Kermes and Shades Bands", *'Atiqot* 38, 129-136.
- Koren, Z. C. (2005) The First Optimal All-Murex All-Natural Purple Dyeing in the Eastern Mediterranean in a Millennium and a Half, *Dyes in History and Archaeology* 20 136-149.
- Kreuzner, C. (2013) Alkanna Tinctoria (L.) Tausch as Purple Dye in the Recipes of Papyrus Holmiensis and Papyrus Leidensis X, *E-Preservation Science* 10, 123-130. (online: <http://www.morana-rtd.com/e-preservation-science/2013/Kreuzner-16-01-2013.pdf>).
- Lauffer, S. (1971) *Diokletians Preisedikt*. Berlin.
- Martínez García, M. J. (2013) Cheapening the Luxury: Some curious recipes with vegetal dyes. In C. Alfaro Giner et al. (eds.), *Luxury and Dress. Political Power and Appearance in the Roman Empire and its Provinces*, 151-168. Valencia.
- Meiers, F. (2013) Ars Purpuraria: Neue methodische Ansätze bei der Anwendung von Küpenverfahren in der Purpurfärberei, *Experimentelle Archäologie in Europa. Bilanz 2013, Heft 12*, 43-58.

- P. Prunetti, P. (1998) Da *plumarius* a πλουμάριος: la testimonianza dei papiri. In L. Del Francia Barocas (ed.), *Antinoe cent'anni dopo: catalogo della mostra. Firenze Palazzo Medici Riccardi, 10 luglio-1° novembre 1998*, 145-148. Florence.
- Rackham, H. (1956) *Pliny: Natural history*. The Loeb Classical Library. Vol. 3. London.
- Reese, D. S. (2010) Shells from Sarepta (Lebanon) and East Mediterranean Purple-Dye Production, *Mediterranean Archaeology and Archaeometry* 10/1, 113-141.
- Reinhold, M. (1970) *History of Purple as a Status Symbol in Antiquity*. Brussels.
- Roller, D. W. (2003) *The world of Juba II and Kleopatra Selene: Royal Scholarship on Rome's African Frontier*. New York.
- Schmidt, W. A. (1842) *Die griechischen Papyrusurkunden der Königlichen Bibliothek zu Berlin*. Berlin.
- Serrano, A., Van den Doel, A., Van Bommel, M., Hallett, J., Joosten, I. & Van den Berg, K. J. (2015) Investigation of crimson-dyed fibres for a new approach on the characterization of cochineal and kermes dyes in historical textiles. *Analytica Chimica Acta* 897, 116-127.
- Steigerwald, G. (1986) *Die Antike Purpurfärberei nach dem Bericht Plinius' des Älteren in seiner 'Naturalis Historia'*, *Traditio* 42, 1-57.
- Steigerwald, G. (1990) *Die Purpursorten im Preisedikt Diokletians vom Jahre 301*, *ByzF* 15, 219-276.
- Worp, K. A. (1997) On the meaning of ΠΟΡΦΥΡΑ/ ΠΟΡΦΥΡΙΟΝ in Greek documentary papyri, *MBAH* 16, 57-66.
- Zahariade, M. & Bounegru, O. (2013), *Lexicon of the Greek and Roman Cities and Place Names in Antiquity. Ca 1500 B.C.-Ca A.D. 500*. Fasc. 12: Beneventum-Bovianum. Amsterdam.
- Ziderman, I. I. (2004) Purple Dyeing in the Mediterranean World: Characterisation of Biblical Tekhelet. In L. Cleland & K. Stears (eds.), *Colour in the Ancient Mediterranean World*. 40-45. BAR International Series 1267. Oxford.

## Zur Textilterminologie auf römischen Bleitäfelchen: Probleme der Lesung und Interpretation

Herbert Graßl

Die Vorlage und das Studium römischer Bleitesserae, das in den letzten Jahren einen beachtlichen Aufschwung erlebt hat,<sup>1</sup> lieferte gerade für die kaiserzeitliche römische Textilwirtschaft viele neue Einsichten. Dazu zählen neben dem in diesem Wirtschaftszweig tätigen Personenkreis vor allem die Herstellung, Verarbeitung und Vermarktung von Textilien, ihre Bezeichnungen und auch Preise in verschiedenen Provinzen des Imperiums. Trotz aller neuer Erkenntnisse bleibt auf diesem Feld aber noch viel zu tun: die Lesung der Texte ist häufig nicht gesichert, die inhaltliche Deutung auch wegen der häufigen Verwendung von Abkürzungen schwierig, dazu kommt noch die verstreute und oft nur schwer erreichbare Publikationsform. Dass sich trotz dieser Umstände immer wieder neue Erkenntnisse gewinnen lassen, soll in folgendem Beitrag sichtbar werden.

Eine bislang nicht verstandene Abkürzung, die aber in vielen Täfelchen, so aus Flavia Solva,<sup>2</sup> Kalsdorf,<sup>3</sup> Virunum,<sup>4</sup> Iuvavum,<sup>5</sup> Aelium Cetium<sup>6</sup> in der Provinz Noricum, aus Carnuntum<sup>7</sup> in Pannonien oder Nemetacum<sup>8</sup> (heute Arras in Frankreich) in der Belgica immer in gleicher Form begegnet, beginnt mit den Buchstaben PAS. Eine bisherige Deutung verstand dies als Abkürzung von *p(aenul)as*,<sup>9</sup> Akkusativ Plural von *paenula*, ein Kapuzenmantel. Diese Auflösung ist aber sprachlich völlig ausgeschlossen, wie schon öfter moniert wurde.<sup>10</sup> Lateinische Abkürzungen mit einem Anfangsbuchstaben und folgender Endung (Kontraktionsabkürzungen) begegnen zuerst in christlichen Texten des Mittelalters, vornehmlich bei Heiligennamen.<sup>11</sup> Eine alternative, sprachlich und inhaltlich befriedigende Deutung liegt bislang nicht vor. Ich möchte an dieser Stelle eine solche vorschlagen.

1. Ein Forschungsüberblick über diese Denkmäler und ihren Bezug zur Textilwirtschaft bei Frei-Stolba 2011, 331-344.

2. Martijnse 1993, 30; 374-375.

3. Römer-Martijnse 1990, 217-218; 224.

4. Martijnse 1993, 157; 168-169; 173.

5. Wedenig 2012a, 131-132; Wedenig 2012b, 52-53.

6. Römer-Martijnse 1991a, 93.

7. Martijnse 1993, 362.

8. Jacques & Hoët-van Cauwenberghe 2010, 314-315.

9. Römer-Martijnse 1990, 217-218; Martijnse 1993, 362.

10. Wedenig 2012a, 132.

11. Frenz 2010, 35-41; 93-98.

Den entscheidenden Schlüssel dazu liefert ein literarischer Text aus dem späteren 4. Jh. n. Chr., der in Oberitalien oder Südgallien entstanden ist, die sogenannte *Cena Cypriani*.<sup>12</sup> In dieser Bibelparodie oder besser Parodie der Bibelauslegung werden in Anlehnung an die Hochzeit zu Kana die Gäste des Königs, Personen aus dem Alten und Neuen Testament, für diesen Anlass neu eingekleidet. Katalogartig werden 37 speziell gefärbte, aus diversen Rohstoffen hergestellte, besonders zugerichtete oder für eine bestimmte Verwendung vorgesehene Kleider aufgelistet. Da dieser spätantike Text bislang von der Textilforschung, insbesondere der Textilfarbenkunde, erstaunlicherweise nicht ausgewertet wurde, soll er in seiner vollen Länge vorgestellt werden (*Cena* 44-66):

- Tunc rex respiciens invitatos suos sic ait:*  
 45 »*Quisque vestrum voluerit, veniat in vestiarium meum et dabo singulis singulas cenatorias vestes.*«  
*Tunc aliqui ierunt et acceperunt.*  
*Primus itaque omnium accepit Zacharias albam,*  
*Abraham passerinam, Loth sulphurinam,*  
 50 *Lazarus lineam, Ionas ceruleam,*  
*Tecla flammeam, Danihel leoninam,*  
*Iohannes trichinam, Adam pelliceam,*  
*Iudas argyrinam, Raab coccineam,*  
*Herodes cardinam, Pharao marinam,*  
 55 *Enoch celinam, Achar variam,*  
*David nervinam, Helias aerinam,*  
*Eva arborinam, Iob biplagiam,*  
*Ysaias mesotropam, Maria stolam,*  
*Susanna castalinam, Moyses conchilinam,*  
 60 *Abel purpuream, Levi spartacinam,*  
*Thamar colorinam, Azarias carbasinam,*  
*Aron myrrinam, Iudit iacintinam,*  
*Cain ferrugineam, Abiron nigram,*  
*Anna persinam, Isaac nativam,*  
 65 *Paulus candidam, Petrus operariam,*  
*Iacob pseudoaletinam, Iesus columbinam.*

Da blickte der König zu seinen Gästen und sprach:

- 45 »Jeder von Euch, der will, möge in meine Kleiderkammer kommen, und ich werde euch einzeln ein Speisekleid geben.«  
 Da gingen manche hin und erhielten ein Kleid. Und so empfing als erster von allen Zacharias ein weißes Kleid, sodann Abraham ein sperlingsgraues, Lot ein schwefelgelbes,  
 50 Lazarus ein Leinenkleid, Jona ein meerblaues, Thekla ein feuerrotes, Daniel ein löwenfarbenes,  
 Johannes ein Kamelhaarkleid, Adam ein fellenes,  
 Judas ein silberfarbenes, Rahab ein scharlachrotes,  
 Herodes ein rotes, Pharao ein meerfarbenes,  
 55 Henoch ein himmelblaues, Achar ein buntes, David ein saitenes, Elija ein luftiges,  
 Eva ein baumfarbenes, Ijob ein zweifach umgeschlagenes,  
 Jesaia ein in die Mitte gewendetes, Maria ein langes Frauenkleid,  
 Susanna ein züchtiges, Moses ein purpurfarbenes,  
 60 Abel ein blutrotes, Levi ein rötliches, Tamar ein farbiges, Asarja ein Battistkleid,  
 Aaron ein gelbbraunes, Judit ein hyazinthfarbenes,  
 Kain ein rostbraunes, Abiram ein schwarzes, Hanna ein dunkelblaues, Isaak ein ungefärbtes,  
 65 Paulus ein strahlend helles, Petrus ein Arbeitsgewand,  
 Jakob ein rötlich schimmerndes, Jesus ein taubengraues.

(Übersetzung nach Modesto)

In unserem Zusammenhang sei auf Zeile 49 hingewiesen, wo Abraham eine (*vestis*) *passerina* erhielt, ein sperlingsgraues Kleid (von *passer*, der Sperling, Spatz). Zu dieser Kleiderfarbe ist meines Erachtens auch die Abkürzung PAS auf den Bleitesserae zu ergänzen. Auch andere in der *Cena* erwähnte Kleiderfarben finden sich auf den Tesserae wieder: *candidus*

12. Modesto 1992; Gleis 1993, 153-176; Livini 2011, 279-295.

(Zeile 65) in Siscia,<sup>13</sup> *ceruleus* (Zeile 50) in Siscia<sup>14</sup> und Feltre,<sup>15</sup> *coccineus* (Zeile 53) in Siscia,<sup>16</sup> am Magdalensberg,<sup>17</sup> und in Moosham/Lungau,<sup>18</sup> *conchilinus* (Zeile 59) in Carnuntum,<sup>19</sup> *ferrugineus* (Zeile 63) in Siscia,<sup>20</sup> *purpureus* (Zeile 60) in Siscia,<sup>21</sup> Flavia Solva,<sup>22</sup> Kalsdorf,<sup>23</sup> Carnuntum,<sup>24</sup> Zillingdorf,<sup>25</sup> *sulphurinus* (Zeile 49) in Siscia,<sup>26</sup> Kalsdorf,<sup>27</sup> Flavia Solva<sup>28</sup> und Štrbinci (wohl Certissia in Pannonia Inferior).<sup>29</sup> Schon diese Liste zeigt, dass der literarische Text aus der Spätantike und die inschriftlichen Gebrauchstexte aus dem 1. bis 3. Jh. n. Chr. sich weitgehend entsprechen. Wie die Cena Cypriani zeigt, gehören die abgekürzten Farbbezeichnungen auf den Bleitesserae zum gebräuchlichen sprachlichen Repertoire der Textilterminologie,<sup>30</sup> die Fachsprache hat somit Eingang in die Literatursprache gefunden. Auf

die Bezeichnung (*vestis*) *myrrina* (Zeile 63) sei noch speziell hingewiesen.<sup>31</sup> In den Bleitesserae finden wir die Abkürzungen MVR in Siscia,<sup>32</sup> MOR in Aelium Cetium,<sup>33</sup> Flavia Solva<sup>34</sup> und Kalsdorf,<sup>35</sup> MORINVM in Virunum<sup>36</sup> und MVRIN in Zillingdorf.<sup>37</sup> In Concordia (Oberitalien) begegnet der Ausdruck MYR(R)INI mit Gewichtsangaben.<sup>38</sup> Zur Deutung wurde eine Verbindung zu *morus*, der schwarze Maulbeerbaum, hergestellt,<sup>39</sup> dessen abgekochte Blätter in der Antike als Ausgangsstoff für ein Färbemittel, allerdings ausschließlich für die Haare dienten. Doch dieser Baum wächst in rauerer Klimazonen nicht und auch sprachlich sind keine davon abgeleiteten Farbbezeichnungen bekannt. Die Farbe *murinus* (von *mus*, die Maus), also mausgrau, wurde nur bei Tieren (Pferden, Eseln oder Mauleseln) verwendet.<sup>40</sup> Als

13. Radman-Livaja 2014, 70.

14. Radman-Livaja 2014, 68.

15. Buchi 2005, 43-44.

16. Radman-Livaja 2014, 70.

17. Martijnse 1993, 291-292.

18. Martijnse 1993, 369.

19. Römer-Martijnse 1992, 113; Martijnse 1993, 368.

20. Radman-Livaja 2014, 72.

21. Radman-Livaja 2014, 75.

22. Martijnse 1993, 365.

23. Römer-Martijnse, 1990, 223.

24. Martijnse 1993, 365.

25. Martijnse 1993, 365.

26. Radman-Livaja 2014, 89.

27. Römer-Martijnse 1990, 36.

28. Martijnse 1993, 368.

29. Radman-Livaja 2013, 167-168.

30. Zu Farbbezeichnungen für Wolle und Kleidung: Pley 1911; Bradley 2009, 178-187; Cleland *et al.* 2007, 37-39. Der römische Grammatiker Nonius Marcellus, de comp. 17,30 hat eine Liste *de colore vestimentorum* zusammengestellt. Davon sind die Farben *luteus*, *ferrugineus* und *pullus* auch in Beiltäfelchen dokumentiert.

31. Einzelne Handschriften bieten die Varianten *mirrinam* oder *murrinam*.

32. Radman-Livaja 2014, 73.

33. Römer-Martijnse 1991b, 94-95.

34. Martijnse 1993, 365.

35. Römer-Martijnse 1990, 224.

36. Martijnse 1993, 159, 365.

37. Römer-Martijnse 1991a, 149. Die Lesung LOD MVRRIN auf einem Täfelchen aus Iuvavum, die Wedenig 2012c, 105-108 und 2012b, 53 vorgeschlagen hat, ist wohl zu LOD MVRT(e)VS zu verbessern; vgl. dazu Radman-Livaja 2014, 73.

38. Solin 1977, 155-159; Cresci Marrone & Pettenò 2010, 65-68; Pettenò 2012, 437.

39. Martijnse 1993, 365; Gostenčnik 2014, 97.

40. André 1949, 73-74.

bessere Interpretation, auch angesichts der Wortwahl der Cena Cypriani, bietet sich ein Zusammenhang mit *murr(h)a* (*myrrha*), der Myrrhe, an; die lautlichen Varianten mit U, Y oder O in den verschiedenen Textsorten und Zeiten stellen kein linguistisches Problem dar.<sup>41</sup> Als *murreus*, myrrhenfarbig oder honiggelb werden in literarischen Texten Haare oder Edelsteine angesprochen.<sup>42</sup> Neben einer Farbbezeichnung könnte man aber auch an den Duft der Myrrhe denken. Der antike Botaniker Dioscurides (1,24) informiert uns darüber, dass die Ägypter Häuser und Kleider mit Myrrhe geräuchert haben. Diese Praxis war auch im alten Israel bekannt (Exod. 30, 23,30), wo Kleider von Myrrhe, Aloe und Cassia dufteten (Psalm 45/9). Die Parfümierung von Kleidungsstücken war auch in der griechisch-römischen Antike weit verbreitet. Schon in homerischer Zeit gehörten wohlriechende Kleider zum gehobenen Lebensstandard (Hom. Od. 5, 264). Die Göttin Aphrodite zeichnete sich durch ihre parfümierten Kleider aus (Cypria fr. 4,3-8 Allen = fr. 5 West = Athen. 682 d-f). Theophrast berichtet, dass Bettzeug und Kleidung mit trockenen Riechstoffen behandelt wurden.<sup>43</sup> Auch die Kleidung Alexanders des Großen war mit Aromastoffen erfüllt.<sup>44</sup> In der Kaiserzeit parfümierten Frauen ihre Kleidung, ein Luxus, der einem moralisierenden Christen wie Clemens von Alexandrien zutiefst zuwider war (Clem. Alex. paedag II 8,64,5; 109,1). Der Chronist der Dakerkriege Kaiser Trajans und Leibarzt der Kaiserin Plotina, Kriton, hat sich speziell

mit Parfümierungstechniken von Kleidern beschäftigt und darüber auch geschrieben, was sein berühmter Berufskollege Galen für ein Thema hielt, das nicht Gegenstand medizinischer Erörterungen sein sollte (Gal. XII 447; 449). Die *vestis odorata* gehörte in der gesamten Kaiserzeit bis in die Spätantike zum häufig zitierten Lebensaufwand.<sup>45</sup> Das Parfüm schützte auch vor Schädlingen und verlieh den Trägern Ansehen und Glanz. Mit den erwähnten Abkürzungen könnte also auch die Parfümierung von Kleidungsstücken ausgedrückt worden sein. Diese Leistung wurde wie auch die Reinigung vom *fullo* angeboten, auch Färber konnten dies bewerkstelligen. Eine solche Deutung kann auch die hohen Gewichte (z.T. über acht kg!) erklären, wie sie in den Bleitesserae von Concordia begegnen.<sup>46</sup> In ähnlichem Sinn wird auch die in einigen Texten auftretende Abkürzung NAR, NARDIN, NARDINV (von *nardinus*, mit Narde behandelt) zu verstehen sein, die auf die wohlriechende Narde zurückgeht.<sup>47</sup> Diese Pflanze, im keltischen Alpenraum als *saliunca* bekannt,<sup>48</sup> wurde nach Ausweis antiker Quellen zur Parfümierung von Kleidung verwendet und hat sich als Alternative zur importierten Myrrhe angeboten. Plinius überliefert uns auch Preise, die je nach Herkunftsregion unterschiedlich hoch waren.<sup>49</sup>

Auch die Abkürzung AMAR, z.B. in Kalsdorf,<sup>50</sup> dürfte mit dieser Praxis zu tun haben; eine Ergänzung zu *amaracinus* (mit Majoran behandelt) gilt als wahrscheinlich. Für die Abkürzung MVR wurde auch die

41. Zum Wechsel der Vokale o, u und y Mihăescu 1978, 177-184, zur Verwendung von Myrrhe, Dalby 2000, 117-120.

42. Ov. met. 15, 399; Prop. 4,8,22; André 1949, 160; André 1956, 215; Vons 1999, 837.

43. Theophr. de odor. 58; 69; vgl. Alexis F63K. zum Besprenkeln der Kleidung mit Salböl.

44. Plut. symp. 1, 6.

45. Claud. In Eutropium 335; Mart. 8,3,10 mit Kommentar von Schöffel 2002, 107-108. Zur Parfümierung antiker Kleidung: Reuthner 2013, 46; Bodiou & Mehl 2008, 26; Wagner-Hasel 2006, 20-25.

46. Bisherige Ergänzungen zu *myrrhini (olei)* können daher nicht befriedigen. Auch die von allen bisherigen Editoren (zuletzt Pettenò 2012, 439) vertretene Deutung des Personennamens MENANDRI ALLICIVM auf ein sonst sprachlich nirgends bezeugtes Derivat von *allec* (Fischauc) kann nicht überzeugen, zumal auf der Rückseite von abgewogenen Wollballen die Rede ist. Ich sehe in ALLICIVM einen weiblichen (griechischen) Sklavennamen auf -ium, abgeleitet vom Verbum *allicere* (anlocken, verführen). Zu dergleichen stadtrömischen Sklavennamen Solin 1996, 650 und die Frauennamen der römischen Komödie.

47. Auch hier fallen hohe Gewichte von über vier bis acht kg auf; vgl. dazu Marengo 1989, 44-46; Radman-Livaja 2010, 96; Weiß 1991, 215-217; Pettenò 2012, 438. Hier wird diese Angabe als Gewürz gedeutet.

48. Plin. NH 21,43; zur *saliunca* Guillaud 1909, 246-252; 364-365; Guillaud 1910, 183-185.

49. Plin. NH 12,43; 12,45; vgl. Diosc. 1,7-8.

50. Römer-Martijnse 1990, 216; 218-219; 224; Zur Verwendung dieses Duftstoffes Theophr. de odor. 28; 31;33; 38; 42; 55; Lucr. 2,847; Edict. Diocl. 78; dazu Reger 2005, 255; 275; Parfums 2008, 296; Squillace 2012, 236.



Ergänzung zu *murteus* oder *myrteus* vorgeschlagen,<sup>51</sup> da myrtenfarbige, grünliche Kleider in der antiken Literatur mehrfach bezeugt sind.<sup>52</sup> Da aber diese Bedeutung nur bei einer differenzierenden Ausdrucksweise verständlich war, finden sich in Siscia dafür die Abkürzungen MVRT, MVRTIO oder MVRTEO-LUM.<sup>53</sup> In Nemausus (Nîmes) findet sich die Angabe MVRTA.<sup>54</sup>

Abschließend sei noch die Abkürzung GRV angesprochen, so z.B. in Kalsdorf.<sup>55</sup> Da der Lautwandel von o zu u in provinziellen Texten sehr häufig ist, kann man darin die Abkürzung für den Terminus *grossus* in der Bedeutung von dick sehen. Diese Eigenschaft von Kleidungsstücken ist in der Literatur häufig bezeugt.<sup>56</sup> Die vorgestellten Abkürzungen und ihr Verständnis vertiefen unsere Informationen zur Farbe, den Geruch und die Qualität antiker Kleidung. Nur ein Zusammenführen von epigraphischer und literarischer Dokumentation kann auf diesem Feld der antiken Stextilforschung zu neuen Ergebnissen führen.

## Bibliographie

- André, J. (1949) *Étude sur le termes de couleur dans la langue latine*. Paris.
- André, J. (1956) *Lexique des termes de botanique en latin*. Paris.
- Buchi, E. (2005) Le etichette plumbee rinvenute a Feltre: aspetti onomastici, lessicali, economici e tecnici. In G. Ciurletti & N. Pisu (eds.), *Leben an der Via Claudia Augusta: Archäologische Beiträge*, 43-44. Trento.
- Bradley, M. (2009) *Colour and Meaning in ancient Rome*. Cambridge.
- Bodiou, L. & Mehl, V. (2008) De Myrrhinè à Marilyn: se vêtir, se parfumer, se montrer ou le parfum comme parure. *Mètis* N. S. 6, 13-40.
- Cleland, L., Davies, G., Llewellyn-Jones, L. (2007) *Greek and Roman dress from A to Z*. London – New York.

- Cresci Marrone, G. & Pettenò, E. (2010) *Supellex ex plumbo. Lamine Concordienses. Le laminette commerciali da Iulia Concordia*. Atti del istituto Veneto di scienze, lettere et arti 168, 43-110.
- Dalby, A. (2000) *Dangerous Tastes: the story of spices*. London.
- Feugère, M. (1993) Une étiquette inscrite en plomb. *Bulletin de l'Ecole Antique de Nîmes*, Suppl. 1, 301-305.
- Feugère, M. et al. (2004) Les instruments de l'écriture. *Gallia* 61, 1-192.
- Frei-Stolba, R. (2011) Les étiquettes en plomb: des documents de l'écriture au quotidien. In M. Corbier & J.-P. Guilhembet (eds.), *L'écriture dans la maison romaine*, 331-344. Paris.
- Frenz, Th. (2010) *Abkürzungen. Die Abbrüviaturen der Lateinischen Schrift von der Antike bis zur Gegenwart*. Stuttgart.
- Glei, R. F. (1993) Ridebat de facto Sarra. Bemerkungen zur Cena Cypriani. In W. Ax & R. F. Glei (eds.), *Literaturparodie in Antike und Mittelalter*, 153-176. Trier.
- Gostenčnik, K. (2014) Textilproduktion in der Austria Romana. In K. Grömer, *Römische Textilien in Noricum und Westpannonien im Kontext der Archäologischen Gewebefunde 2000 v. Chr. – 500 n. Chr. in Österreich*, 57-108. Graz.
- Guillaud, J.-A. (1909) Le nom de plante "Saliunca". *Revue des Etudes Anciennes* 11, 246-252; 364-365.
- Guillaud, J.-A. (1910) La "Saliunca" dans Plinie le naturaliste et dans Marcel de Bordeaux. *Revue des Etudes Anciennes* 12, 183-185.
- Jacques, A. & Hoët-van Cauwenberghe, Ch. (2010) Artisanat et commerce: les étiquettes de plomb inscrites découvertes à Arras (Nemetacum). *Revue des Etudes Anciennes* 112, 295-317.
- Livini, A. (2011) Il caso della Cena Cypriani: riflessioni sulla circolazione altomedievale di un libello tardo-antico. *Wiener Studien* 124, 279-295.
- Marengo, S. M. (1989) Etichette plumbee ed altro instrumentum iscritto su metallo da varie località del Maceratese. *Picus* IX, 35-55.
- Martijnse, E. (1993) *Beschriftete Bleietiketten der Römerzeit in Österreich*, Diss. Wien.

51. Radman-Livaja 2014, 73.

52. Ov. ars 3, 181; Petron. 21,2; vgl. Colum. 10, 238; dazu André 1949, 190-191.

53. Radman-Livaja 2014, 73.

54. Vgl. Feugère 1993, 301-302; Feugère et al. 2004, 27.

55. Römer-Martijnse 1990, 216; 219; 224.

56. ThLL VI/2 2337 s.v. *grossus*.

- Mihăescu, H. (1978) *La langue latine dans le sud-est de l'Europe*. Bukarest – Paris.
- Modesto, Ch. (1992) *Studien zur Cena Cypriani und zu deren Rezeption*. Tübingen.
- Parfums (2008) *Parfums de l'antiquité. La rose et l'encens en Méditerranée*. Mariemont.
- Pettenò, E. (2012) Laminette plumbee da Iulia Concordia: Alcune riflessioni sui commerci e sulla lana. In M. Stella Busana & P. Basso (eds.), *La lana nella cisalpina Romana. Economia e società*. 435-439. Padova.
- Pley, J. (1911) *De lanæ in antiquorum ritibus usu*. Gießen.
- Radman-Livaja, I. (2014) *Tesseræ Sisciensia. Les plombs inscrits de Siscia*. Zagreb.
- Radman-Livaja, I. (2013) Two Lead Tags from Štrbinci (Certissia?). *Arheol. rad. raspr.* 17, 165-180.
- Reger, G. (2005) The manufacture and distribution of perfume. In Z. H. Archibald, J. K. Davies, V. Gabrielsen (eds.), *Making, moving and managing. The new world of ancient economies, 323-31 BC*, 253-297. Oxford.
- Reuthner, R. (2013) *Platons Schwestern. Lebenswelten antiker Griechinnen*. Köln – Weimar – Wien.
- Römer-Martijnse, E. (1990) *Römerzeitliche Bleietiketten aus Kalsdorf, Steiermark*. Wien.
- Römer-Martijnse, E. (1991a) In *Instrumenta inscripta latina. Das römische Leben im Spiegel der Kleininschriften*. Pécs.
- Römer-Martijnse, E. (1991b) Auf den Spuren des Textilgewerbes im römischen St. Pölten. In P. Scherrer (ed.), *Landeshauptstadt St. Pölten. Archäologische Bausteine*, 91-96. Wien.
- Römer-Martijnse, E. (1992) Fullones ululamque cano ....(CIL V 9131). *Specimina Nova VII*, 111-114. Pécs.
- Schöffel, Ch. (2002) *Martial, Buch 8*. Stuttgart.
- Solin, H. (1977) Tabelle plumbee di Concordia. *Aquileia Nostra* 48, 145-164.
- Solin, H. (1996) *Die Stadtrömischen Sklavennamen. Ein Namenbuch*. Stuttgart.
- Squillace, G. (2012) Nella bottega del profumiere. Segreti e trucchi di mestiere nel de odoribus di Teofrasto. In D. Frère & L. Hugot (eds.), *Les huiles parfumées en Méditerranée occidentale et en Gaule VIII<sup>e</sup> s.av.–VIII<sup>e</sup>s. apr.J-C.*, 231-239. Rennes.
- Vons, J. (1999) „Il est des parfums sauvages comme l'odeur du désert“. Étude du vocabulaire des parfums chez Pline l'Ancien. *Latomus* 58, 820-838.
- Wagner-Hasel, B. (2006) Duftende Kleider & Gesalbte Körper. In A. Dierichs & A. Viola Siebert (eds.), *Duftnoten. Was Griechen und Römern in die Nase stieg*, 20-25. Hannover.
- Wedenig, R. (2012a) Kleininschriften zum Wirtschaftsleben im nördlichen Noricum. In F. Lang, St. Traxler, W. Wohlmayr (eds.), *Stadt, Land, Fluss/Weg, Aspekte zur römischen Wirtschaft im nördlichen Noricum*. 127-132. Salzburg.
- Wedenig, R. (2012b) Kleininschriften auf Keramik- und Bleifunden vom Makartplatz. In P. Höglinger (ed.) *Salzburg, Makartplatz 6, Römisches Gewerbe – Stadtpalais – Bankhaus Spängler*, 50-53. Horn.
- Wedenig, R. (2012c) Wirtschaftsnotizen auf Instrumentum domesticum aus Noricum. In *Sylloge Epigraphica Barcinonensis X*, 101-108.
- Weiß, P. (1991) Bleietiketten mit Warenangaben aus dem Umfeld von Rom. *Tyche* 6, 211-220.

## Observations on the Terminology of Textile Tools in the *Edictum Diocletiani* on Maximum Prices

Peder Flemestad, Mary Harlow, Berit Hildebrandt, Marie-Louise Nosch

### **The *Edictum Diocletiani et collegarum***

The so-called Edict of Maximum Prices was issued in AD 301 as part of a comprehensive administrative and financial reform released in the reign of the Roman emperor Diocletian.<sup>1</sup> Diocletian came to power in AD 284 after a period in Roman history traditionally understood as a time of ‘crisis’, produced by a series of inter-related factors:<sup>2</sup> a frequent turnover of emperors; problems with the economy in terms of production and coinage; incursions by various tribes

on the edges of the empire; internal unrest; the rise of Christianity and periodic persecutions. Diocletian’s actions were arguably pragmatic responses to the situation he found the empire in on his accession. The Edict should be seen alongside a number of reforms during his reign and is regarded by some scholars as the most important inscription of late antiquity.<sup>3</sup> Several editions and translations have been published thus far. In addition to the continuous publication of new finds of the text itself, commentaries on different aspects of the Edict abound.<sup>4</sup>

1. Noethlich 2010, *s. v. Edictum Diocletiani*. The term ‘Edict’ is generally thought to have been coined by Theodor Mommsen, who referred to *dicunt* in the preface of the text; however, it should be noted that W. M. Leake had already used the term in 1826 (Leake 1826). In the text itself *lex* (law) and *statutum* are used, demonstrating that we are dealing with a law that was supposedly valid and, at least according to its own standard, enforced throughout the empire, in the East as well as the West (*Lex*: Ed. Diocl. *praef.* 15; *statutum*: Ed. Diocl. *praef.* 15, 18, 19, 20). In the case of any violation (including super elevated prices, illegal negotiations between sellers and buyers as well as the hoarding of goods), transgressors were threatened with capital punishment. The Edict was produced in the names of the two Emperors C. Aurelius Valerius Diocletianus and M. Aurelius Valerius Maximianus and their intended successors Flavius Valerius Constantius and Galerius Valerius Maximianus, but is traditionally named after Diocletian alone. The 18th *tribunicia potestas* of Diocletian mentioned in the text suggests that the Edict was issued between 21 November and 31 December AD 301, according to Corcoran 1996, 206, or between 20 November to 9 December, according to Speidel 2009, 497, note 43. Translations of literary passages are adapted from the relevant Loeb volumes.
2. Recent scholarship questions notions of crisis, recognising that not all of these factors affected all of the empire, all of the time: see *e.g.* Potter 2013; Hekster 2008.
3. Brandt 2004, 47.
4. Cf. *e.g.* the bibliography in Kuhoff 2001, 515-564; von Reden 2002.

The main purpose of the Edict, at least according to its own preface, was to fix maximum prices for a wide range of services and products that had constantly been jeopardized by the avarice of some merchants and traders who were known to ask for prices up to 8 times the usual amount.<sup>5</sup> According to the text itself, the main beneficiaries of the Edict were the soldiers of the Roman army with a fixed salary that would not have allowed them to purchase the

above-mentioned products and services at such excessive prices.<sup>6</sup> The prices mentioned regard transportation, food, wages for craftsmen as well as special goods such as marble and numerous clothing items and textiles. All in all, around 1300 items, wages, and services are mentioned.<sup>7</sup> In detail, studies on specific materials mentioned in the Edict, like glass and marble, are well covered as are those on the different areas of production, services, and costs

5. *Ed. Diocl. praef.* 97. The purpose of the Edict and the question of whether the law and its price regulations was ever understood as binding by the population or whether it should rather be considered a more symbolic demonstration of imperial power, remain a matter of scholarly dispute. It is, however, indisputable that the Edict was accompanied by a fundamental reorganization of the tax system and two further edicts regulating coinage. One of the major problems faced by the emperors of the late principate was the dramatic rise in inflation. The second Coin Edict was probably issued on the 1st of September in AD 301, a few months before the Price Edict (Erim 1971). The consequences of this might have been a general increase in prices that demanded quick counteraction. Burkhard Meißner has suggested that there may have been additional factors that made the Edict of Maximum Prices a necessary initiative, in particular the military reforms also undertaken by Diocletian (Meißner 2000, esp. 79-84). As the number of recruits steadily increased and the frontiers of the empire were more intensely fortified, local demand on markets could increase enormously and cause prices to soar. Meißner therefore suggests that the Edict was intended as an *ad hoc* measure aimed at stabilizing prices, especially in the most militarised regions of the empire (Meißner has been contradicted by Brandt 2004, see below). That the Edict could also be perceived as a measure taken for the welfare of all (as frequently stressed in the *praefatio*) is confirmed by an inscription commenting on the purpose of the Edict found in the province of Caria and Phrygia (Meißner 2000, esp. 91-94). There, the provincial commander, Fulvius Asticus, added an explanation that the Edict was meant to establish adequate prices. He does not explicitly single out the military, as does the *praefatio*, but claims instead that the Edict was issued for the welfare of the whole provincial population. Meißner has taken this addition as an indication of the different areas of concern of the provincial governors. He still assumes, however, that the province of Caria and Phrygia was affected by inflation caused by the presence of the military. Hartwin Brandt contradicts this by pointing to inscriptions that give proof of soldiers plundering the houses of civilians, especially in Lydia and Caria and Phrygia. In Brandt's opinion, an edict aimed to maintain the purchasing power of soldiers with a fixed salary could not have satisfied the people that had been their victims, but, quite the contrary, would have aroused resistance and anger (Brandt 2004, 50-51). Michael Speidel offered yet another interpretation: he assumed that the Edict was motivated by the Emperors' concerns regarding their solvency, especially towards the soldiers, and their interest in keeping the soldiers content and supportive of their power (Speidel 2009).

6. Noethlichs 2010 argues that soldiers were especially affected by this because they had to spend a considerable amount of their salary on food, clothing and related items. Some researchers deny the impact of Diocletian's Edict altogether (Meißner 2000, esp. 79-82). They refer to the contemporary of Diocletian, Lactantius, who states that the Edict had to be abrogated (Lactantius, *De mort. pers.* 7,6f.). Lactantius claims that the Edict did not succeed and that after a short time goods were said to have disappeared from the market as a direct reaction to it, so that it had to be annulled (Lact. *De mort. pers.* 7,7). The hypothesis that Diocletian did not succeed is, however, not confirmed by recent scholarship: the Edict appears to have succeeded in slowing down inflation (Noethlichs 2010). In 1989 Alexander Demandt argued that the maximum prices of the Edict were sometimes well above the market price, as shown by comparisons with prices in papyri and other inscriptions (Demandt 1989, 56-57, cit. by Brandt 2004, 47; for a discussion of the papyri see Mickwitz 1932). Therefore, he concluded that the main intention of the Edict was to stabilize prices, because the margin was not always exhausted. Both Bagnall and Corcoran note that transactions would occasionally adhere to prices stipulated of the Edict, even after the Edict itself had been annulled; this is best documented in connection with military clothing (Corcoran 1996, 233; Bagnall 1985, 69, esp. on the three identical sets of prices in 302, 314 and 323).

7. Arnaud 2007.

for transport.<sup>8</sup> Some aspects of ancient textile technology and clothing have been treated in greater detail, such as the different types of purple mentioned, wool, clothing and cloth, as well as specific terminological questions related to clothes.<sup>9</sup> Despite this interest in the range and types of clothing, scholarship has not yet focussed on the textile tools mentioned in the Edict. This contribution proposes to fill part of this gap.

### *Greek or Latin original*

The Edict is written in Greek and Latin, and the question of the original language of the Edict is seemingly straightforward. As a law promulgated by an emperor of the Western part of the empire, it was undoubtedly Latin. The elaborate preface of the inscription is so far only known from Latin versions of the Edict, not in the Greek versions. The Greek text(s) that survived cannot be traced back to a single official master document. As Giacchero suggested, local authorities seem to have been rather at liberty to translate the Latin text according to need.<sup>10</sup> This seems to be corroborated by the observations of E. G. Turner. He argues, based on papyri from the reign of Diocletian, that Diocletian did not pursue an active language policy to enforce the use of Latin in Egypt, and that he only imposed very narrow measures to limit the use of Greek through the introduction of “a quasi-Roman municipal and taxation system, Roman coinage, and Roman dating by consuls and by indiction” in order to promote the gradual increase in the use of Latin language and terminology.<sup>11</sup> While an interest in political and administrative terminology is understandable, it is, however, unlikely that one would have stipulated any precise terminology for (items of) trade,

except in very general terms. This has to be kept in mind when dealing with questions of tool terminology which might have been influenced by, for instance, misunderstandings by the copyist, misspellings and other factors.

### **Textile tools in the Edict**

#### *Textile tools as a case study*

This investigation of textile tools provides some insights into the use and production of textiles and their producers and consumers and thus allows glimpses at economic implications and the practical application of the Edict in everyday life. It also highlights key aspects of ancient technology invisible in literary sources. Indeed, since the relevant chapters concerning textile tools are preserved in both Greek and Latin, we are offered, in addition, an invaluable bilingual source for textile terminologies for both more common as well as more specialised tools.

#### *The fragments of the Edict related to textile tools*

The preserved fragments of the Edict testify to several textile tools. Some tools are directly attested by name, others only indirectly through craft terminology and occupational designations. Among the tools explicitly mentioned are needles, pins, spindles, whorls, combs and looms. In this contribution, we focus on the items that are mainly attested in two parts of the Edict so far: chapters 13 and 16. Their translation and interpretation varies widely in philological literature and thus merits a reassessment. The chapters are preserved in both Latin and Greek fragments (Fig. 1). Not all fragments have their bilingual counterpart nor are fully

8. Glass: Whitehouse 2004; 2005; marble: Corcoran & Delaine 1994; production: Giacchero 1983; services: Polichetti 2001; transport: Arnaud 2007.

9. Purple: Steigerwald 1990; Leadbetter 2003; wool: Reynolds 1981; clothing and cloth: Erim 1970, 132: Note on “clothing and cloth” by J.P. Wild; clothes: Wild 1964; wool: Wild 2014-2015.

10. Giacchero 1974, 98: “La versione in greco della tariffa non sembra sia stata redatta in un testo unico e ufficiale. Infatti le notevoli varianti lessicali riscontrabili nei frammenti greci inducono a ritenere che la traduzione dell’elenco di merci e servizi sia stata compiuta in maniera autonoma da autorità locali.” Giacchero here follows Mommsen & Blümmner 1958, 57 and Bingen 1953, 648.

11. Turner 1961, 168.

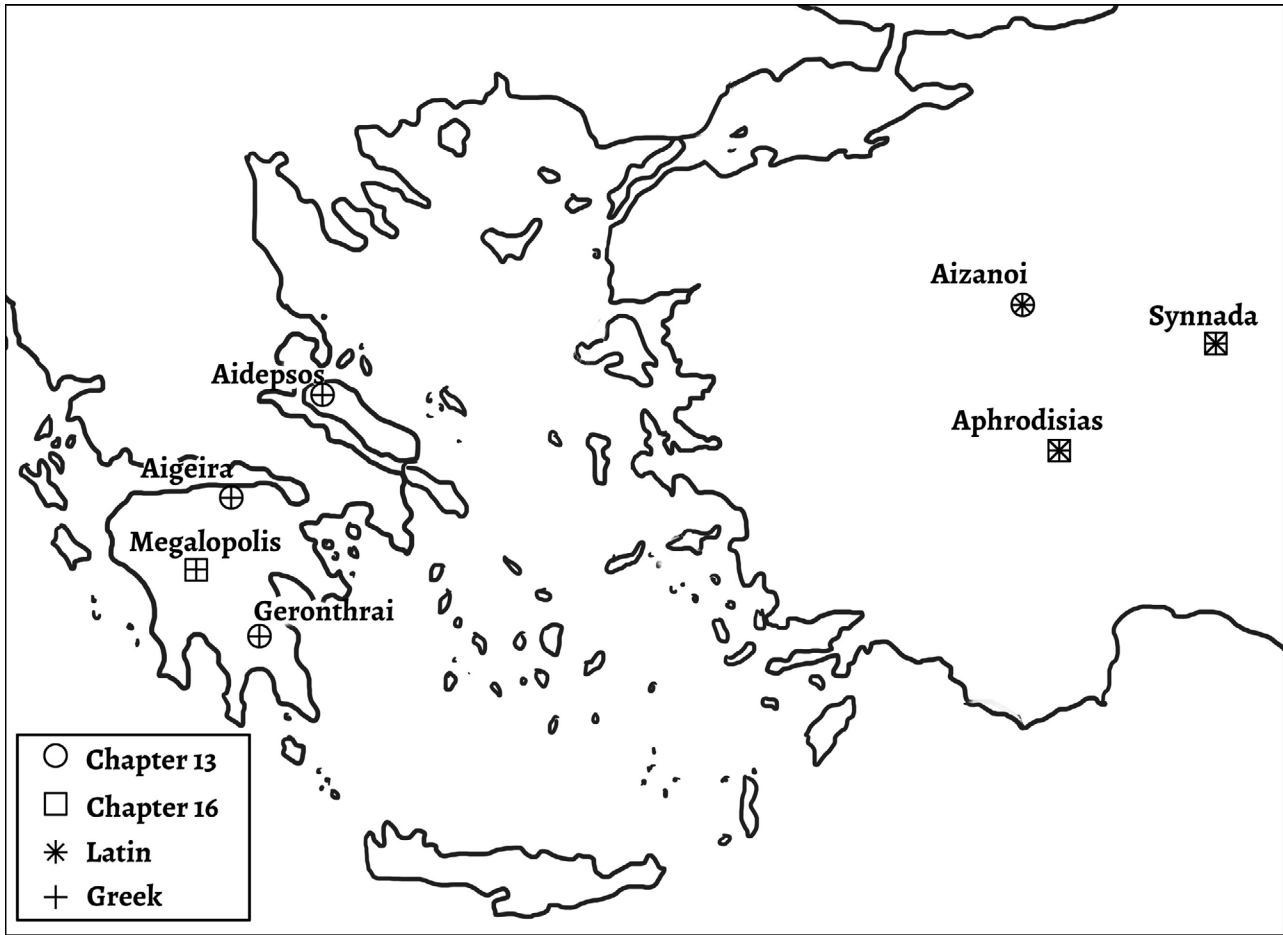


Fig. 1. Map of findspots of fragments related to textile tools, adapted from Giacchero 1974.

attested in even one language. Some lines are attested only once/in one fragment in each language, others more than once in several fragments, others again are missing in both languages, while others are missing only in one language and can sometimes be reconstructed by using their Latin or Greek counterpart.

Of the Latin version we have one fragment of chapter 13 (ll. 1-10) and two fragments of chapter 16 (ll. 12-14). Of the Greek version three fragments have been found of chapter 13 and one fragment of chapter 16. We therefore have 4 fragments of chapter 13

(of which one is in Latin and three are in Greek) and three of chapter 16 (of which two are Latin and one is Greek: see Fig. 2 for an example). Two of these fragments (*Aezan. IV* and *Aphr. XXIX*) postdate the edition of Siegfried Lauffer<sup>12</sup> that is still fundamental for studies of the Edict, but *i.a.* change the line numbering of the chapters that are treated in this contribution. We therefore in general follow the edition of Marta Giacchero,<sup>13</sup> who was able to include the new finds, and have modified our analysis with reference to later scholarship.<sup>14</sup>

12. Lauffer 1971.

13. Giacchero 1974. Additional information in German and Italian in the following footnotes is taken from Lauffer and Giacchero.

14. *E.g.* Crawford & Reynolds 1977; see also Barańscy *et al.* 2007; Roueché 1989, 281.



Fig. 2. The Synnada fragment of chapter 16, adapted from Macpherson 1952, Plate X.1.

### *The attested textile tools in chapters 16 and 13*

#### *Chapter 16:*

16,12 <sup>15</sup>	[De] <i>Acu</i>	
12a	<i>Acus sartoria sive subfisclatoria subtilissima</i>	X IV
13	<i>Formae secundae</i>	X II
14	<i>Acus ciliciari sive sagmaria</i>	X II
16,12	[περι βελον]ῶ[v]	
12a	[βελόνη] ραφική ισχυοτάτη	X δ'
13	[δευτέρ]ας φόρμ(ης) βελόνη α'	X β'
14	[βελό]νη σα<κ>κοράφη ἤτοι σαγμα[τ]ική	X β'

The brief chapter 16 is headed *De acu* and does not mention any other tools than *acus* in the preserved fragments. The Greek title is badly damaged, but the restoration [περι βελον]ῶ[v] is unproblematic since in the following lines only the term βελόνη is mentioned<sup>16</sup> which corresponds to the Latin *acus*. Both terms are commonly translated as ‘needle’, which seems to match the meaning of the chapter very well.

The chapter starts with an *acus sartoria*. The literary translation as a sewing needle is unproblematic.<sup>17</sup> Immediately after the mention of this sewing needle both the fragment from Synnada and the (slightly more damaged) one from Aphrodisias give the information *sive (acus) subfisclatoria subtilissima*, “or a very fine *subfisclatoria*-type needle”.<sup>18</sup> Both cost the same, 4 *denarii* each. However, the meaning of *subfisclatoria* is unclear. It could, analogous to *sartoria*,

15. = 16, 8-10 Lauffer.

16. Loring (1890, 320) notes that the restoration [περι βελον]ῶ[v] is conjectural, but fairly probable, because “headings are pretty abundant in this part of the inscription”.

17. *Sartorius*, ραφικός ‘für den Schneider’, cf. 7, 48.

18. *Suptilis* = *subtilis*, ισχυός ‘dünn, fein’, cf. 7, 48. *Corpus Glossariorum Latinorum* III 181, 5 ισχυός *stuptilis*.

indicate the use of this needle, but it could also indicate the material of the object. For the interpretation, one has referred to the noun *fistula*, which would refer to a needle in the shape of or (originally) made of a tube or stalk.<sup>19</sup> The term *acus* thus presumably distinguishes here either two different uses of the same needle or two distinct needles, distinguished by use and/or material that were sold for the same price. The Greek text is fragmentary but gives *ῥαφική* for *sartoria* and *ισχυοτάτη* that matches the Latin *suptilissima*, but there is no Greek term corresponding to *subfisclatoria*. The question remains open as to whether these needles were similar enough to be grouped together for reasons other than their identical price.

A clue to their interpretation may be found in the next line where the needle is termed *formae secundae* in Latin, *δευτέρας φόρμης* in Greek, *i.e.* of ‘second-grade quality’. This type of needle only costs half the price of the *subfisclatoria*-type needles, *2 denarii*. Needles of the second quality are therefore presumably contrasted with those of the *subfisclatoria*-type that seem to be of ‘first-grade’ quality (*forma prima*), being finer (*suptilissima/ισχυοτάτη*).

In the last line, we meet a similar phrasing as the first line, an *acus ciliciari sive sagmaria* which costs *2 denarii*, like the second-grade quality needles in the previous line. This probably denotes a single type of needle that is used for two distinct purposes: first, for

rougher textile qualities, the Latin adjective *cilicioris* pointing to so-called ‘Cilician’ fabrics that were originally made of goat hair;<sup>20</sup> and the corresponding Greek word *σακκοράφη* pointing to bags made of a rough fabric. Second, *sagmaria* for saddle-cloths, confirmed by the Greek *σαγματική*, with *sagma-*, according to one editor,<sup>21</sup> referring to a pack-saddle, but which is probably a saddle-cloth.<sup>22</sup> With regard to *σα<κ>κοράφη*, Loring notes that the stone clearly reads *σαρκοράφη*, but that this is a mistake; he adds that since it was a large needle, and used for sacking, it was probably a packing-needle.<sup>23</sup>

These kinds of *acus* may be interpreted as needles in the modern sense of the word, as sharp and pointed objects made of metal (or another hard material that could be formed into a very thin needle), with an eye at one end. They might have been used to stitch fabric together or to apply decorative objects (including pearls, metal ornaments and thread) on fabrics. This interpretation seems to be corroborated by finds of metal needle hoards in different regions of the Roman world. One set of 17 “badly rusted” needles comes from Dura Europos in modern-day Syria, dating probably to the middle of the 3rd century AD, very close in time to the Price Edict (Fig. 3). According to the publication, they were made of iron and tucked into a fragment of undyed wool cloth. Their length varied from 5.2 to 6.0 cm, and the average diameter is 0.15 cm.<sup>24</sup>

19. Lauffer: *sufisclatorius* = *suffisclatorius* ‘rohrförmig’ (*fistula*, ‘Rohr, Halm, Hohladel’), cf. Plin. *NH* 17,100: *sutoriae simili fistula*; *Corpus Glossariorum Latinorum* III 10,48 *σοριστής fisclator*. V 248, 14 *tenui havena fistula vulgo fiscla dicitur*. *CIL* VI 4444,4 *fisclatori*. Perhaps we are dealing with a situation similar to English ‘weaver’s reed’. Macpherson (1952, 73), discussing the Synnada fragment, notes that *sufisclatoria* could be derived from the form *fisculus* or from *fistula*; he furthermore adduces *Corpus Glossariorum Latinorum* II, 580 for the form *fisclator*, and Plin. *NH* 17,100 for the word *fistula*, referring to a shoemaker’s tool (*sutoriae simili fistula*); and Festus (308-309 Müller) for *suffiscus*.

20. Lauffer: *cilicioris* ‘für Decken aus kilikischem Ziegenhaar’ or ‘grobes kilikisches Tuch’ (*cilicium*), cf. Mart. 7,95,13. *Corpus Glossariorum Latinorum* III 574,22 *coactile genus cilicii*. P. Lond. III 1164h 10 p. 164 κλικίφ. σα(κ)κοράφος ‘zum Sacknähen’, cf. *Etym. Magn.* 46,31 ἀκέστρα ἢ βελόνη ἢ μείζων, ἦν νῦν σακκοράφιον καλοῦσιν. Cf. also Blümner 1912, 204.

21. Loring (1890, 320) understands the *σαγμα[τ]ική* in line 14 as another large needle, perhaps a saddler’s needle, *σάγμα* being a ‘pack-saddle’.

22. *Sagmarius*, *σαγματικός* ‘zum Sattelnähen’, cf. 11,4-6. *Corpus Glossariorum Latinorum* II 429,28 *σαγματοποιός sagmarius*.

23. Loring 1890, 320.

24. Pfister & Bellinger 1945, 60, cat.no. 293.



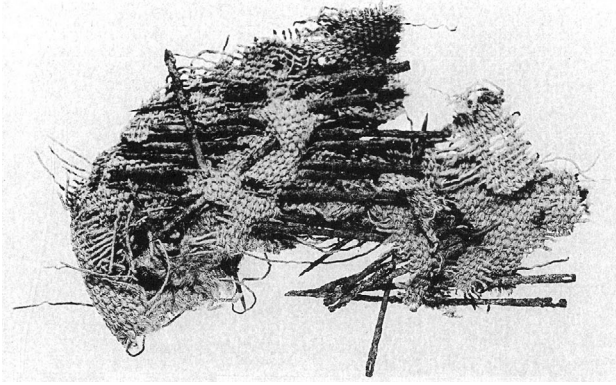


Fig. 3. Needles from Dura Europos, from Pfister & Bellinger 1945, Plate XXXI, 293.

Another set of needles was found in Magdalensberg in Austria, ‘Old Virunum’, and might have been produced for trade (Fig. 4). The settlement flourished in the period 50 BC to 50 AD. The ruler in the photo of the publication shows that some of the needles were actually 14 cm long and probably meant for heavy duty sewing. However, we have to keep in mind that finer needles are presumably less likely to be preserved than thicker ones, which might have distorted the statistics of the hoard finds.

While chapter 16 is relatively straightforward, chapter 13 poses several terminological problems. These regard both its internal structure that seemingly does not match the headline; the interpretation of the



Fig. 4. Needles from Magdalensberg, from Gostenčnik 2010, 83, fig. 13b.

Chapter 13: *On pin-beaters*<sup>25</sup>

13, 1	<i>De radiis textoribus</i>	
1a	<i>Radium buxum numero vac. I</i>	[X XIII]
2	<i>Radia promisquae materiae vac. N I[I]</i>	[X XXX]
3	<i>Pectinem textorium buxum</i>	[X XII]
4	<i>Pectinem textorium promisquae materiae</i>	[X XIII]
5	<i>Fusum buxum cum verticillo</i>	[X XII]
6	<i>Fusum cum verticillo alterius materiae</i>	[X XV]
7	<i>Pectinem muliebrem buxum</i>	[X XIII]
8	<i>Acus osseas muliebres N III</i>	[X XII]
9	<i>Acus testudines I</i>	[X III]
10	<i>Acus sucinea I</i>	[X ?]
13,1	περὶ κερκίδων	
1a	κερκὶς πυξίνη α'	X ιδ'
2	κερκίδες β' ἐκ διαφ(όρων) ξύλ(ων)	X λ'
3	κτένα πύξινον	X ιβ'
4	κτένα ἐκ διαφόρων ξύλων ἰς πῆν(ην)	X ιδ'
5	ἄτρακτος πύξιμος μετὰ σφονδύλου	X ιβ'
6	ἄτρακτος μετὰ σφονδύλου ἐξ ἐτέρων ξύλων	X ιε'
7	κτένιον γυναικεῖον πύξινον	X ιδ'
8	κνηστρον ὀστάιν[ον γ]υναικεῖον	X ιβ'
9	κνηστρον χελών[ινον]	X δ'
10	κνηστρον σούκινον	X [—]

different items mentioned; and finally the translation of the terms from Latin to Greek and *vice versa*. The Latin text is only attested in one fragment that was found in Aizanoi, while the Greek version (containing the lines corresponding to *acus*) is preserved in two fragments from Geronthrai in Laconia and Aid-epsos on Euboa.<sup>26</sup>

Chapter 13 is headed with *De radiis textoribus*/περὶ κερκίδων. The terms κερκὶς and *radius* are consistently translated in both literature and dictionaries as “(weaver’s) shuttle”. However, research since in the

1930s, has at regular intervals noted and stressed that this is a highly problematic and anachronistic translation. The term *textoribus* suggests that we are dealing with weaving tools but the chapter does not limit itself to its own headline (this is not unusual in the Edict).<sup>27</sup> Instead, after listing several *radia*/κερκίδες specified according to material, it goes on to list combs; spindles with whorls; items specified as “women’s items” – among which are another small comb and also a different kind of needle or pin or tool that has been interpreted as “scraper”, but which is probably better

25. Cf. Crawford & Reynolds 1977.

26. *Aizanoi* IV. This fragment was published by F. Naumann, after Lauffer’s edition, but, as noted by Crawford & Reynolds (1977, 125), the *ed.pr.*, published with admirable speed, was susceptible to improvement in some places, we therefore follow the readings of Crawford & Reynolds. Both Greek fragments of the chapter (*Aedeps.* and *Ger. II*) are unfortunately badly preserved. Different interpretations, depending on editorial choices of the texts, have not, however, been the subject of sufficient scholarly discussion.

27. See Doyle 1976, 91: “as often in the Edict, covers only one of the items listed”, although he assumes that “the shuttles, spindles, combs, and scrapers, (are) all doubtless made traditionally in the same shop”.

translated as “scratcher” if the function is to be emphasised. Prior to the discovery of the Aizanoi fragment, Chapter 13 was only known in Greek.

As already mentioned the headline is usually translated as concerning “shuttles”. According to John Peter Wild, an early advocate against this common interpretation, the shuttle was unknown to the Romans;<sup>28</sup> and Elizabeth Barber hypothesises that the shuttle only came to the Mediterranean area around the 10th century AD.<sup>29</sup> Since the instrument is specified as a weavers’ instrument (*textoribus*), the solution may be to term it “(weaving) pin”, *i.e.* a pointed instrument, not necessarily with an eye/hole, that was multi-functional and could serve as: a “weft-carrier/spool” to pass the weft through the warp threads, and as a weft-beater (and even as a hairpin – see below). This interpretation also has the advantage that a pin – in contrast to a shuttle – could be used on different kinds of looms, *e.g.* warp-weighted, ground, and two-beam looms,<sup>30</sup> which might have been useful in an inscription that was supposed to regulate the prices of tools in a vast empire with different weaving traditions.

It is interesting to note that the Latin headline specifies *de radiis textoribus* “on pin-beaters for weavers”, while the Greek headline merely states

περὶ κερκίδων “on pin-beaters”, perhaps because the tool’s use for weaving was the predominant sense of the Greek word.<sup>31</sup> Crawford and Reynolds note that the form of the adjective *textoribus* for *textoriis* is “curious”,<sup>32</sup> referring to *textorium* in lines 13,3 and 13,4. Naumann even assumes that *textoribus* is an error for *textoriis*,<sup>33</sup> but there is no fundamental problem in reading *textoribus*, *i.e.* “*radia* for weavers”, instead of “weaving *radia*”. It should be noted that<sup>34</sup> that *radium* (13,1a) and *radia* (13,2) are the uncommon<sup>35</sup> neuter form<sup>36</sup> of the word. While they may be in the nominative, the accusative case is of course equally possible, which would conform to lines 3-7 that are in the accusative, making all items listed in lines from 13.1a-7 accusative.

After the heading, the chapter starts with a pin-beater of boxwood, which was the cheapest material for textile tools (*buxum*, πύξιμος),<sup>37</sup> presumably due to its prolific and widespread availability. One pin-beater costs 14 *denarii*. Boxwood textile tools are consistently indicated *apiece*, perhaps as a point of reference or default category; conversely it could be due to the fact that boxwood is singularly useful for textile tools: it is smooth and light, and good for working with raw material such as wool, because it does

28. Wild 1970, 65; cf. Barber 1991, 85, 273-274; Edmunds 2012. Crawford & Reynolds (1977, 149-151) are rare in translating the term *radius* as pin-beater (once, *ad* line 13.2, ‘pin-beaters or spools’). At the end of their article they acknowledge the assistance of John Peter Wild. Lauffer translates as ‘Weberschiffchen’, while Giaccherio translates as ‘spola’. Wild 1967, 154-155.

29. Barber 1991, 85 n.3.

30. Looms: Ciszuk 2000; Wild 2008 (*contra* Wild 1970) on the horizontal loom; Thompson & Granger-Taylor 1995-1996 on the zilu loom.

31. Cf. Crawford & Reynolds 1977, 149: “That the *radii* listed here were for weaving was regarded as self-evident by the Greek copyists who use κερκίς unqualified.”

32. Crawford & Reynolds 1977, 150.

33. Naumann 1973, 46, n. 25: “*textoribus* falsch für *textoriis*”.

34. Crawford & Reynolds (1977, 150) merely note that its gender is “another grammatical mistake”.

35. The *Thesaurus Linguae Latinae* is, to our knowledge, the only dictionary to mention the neuter form *radium*. That the neuter was also in use is, however, clear from the premonition of the grammarian Flavius Caper (*GL* VII, 102,1): “*hic radius, non hoc radium*”. Moreover, Charisius (*GL* 1.71) includes the word in the words that are masculine in Latin, but feminine in Greek. Outside this passage it is attested *e.g.* in *Corpus Glossariorum Latinorum* III 195, 53, where it translates *certides* (= *cercides*), and in the Vindolanda tablets (II 309,7), where its meaning is ‘spokes’.

36. Of course *radium* may also be interpreted as a masculine accusative singular, but *radia* in the subsequent line makes this improbable.

37. For πύξιμος cf. 13,1a.3 13,3; *forma*, φῶρμα cf. 8,1a.

not splinter.<sup>38</sup> In the following line the pin-beaters are made of other kinds of wood, a category subsumed by the generic expressions *promisquae* or *alterius materiae* and διαφόρων or ἑτέρων ζύλων. The number of *radia* in the Latin text is partly restored, but the Greek equivalent (that also gives the plural: κερκίδες) specifies two that cost 15 *denarii* each. That all wood other than boxwood could be lumped into one category confirms the hypothesis that boxwood was a kind of “default material” for this type of textile tool.

This pattern is repeated in the next two lines that list weavers’ combs (thus deviating from the pin-beaters in the headline and first two lines). First one made of boxwood for 12 *denarii* is listed, then one made of any other wood than boxwood at 14 *denarii* each. We do not know what these combs looked like, but, with reference to these lines (13,3-4), Reynolds and Crawford note that “[t]he Roman weaving comb had a wide head and very small teeth (Wild 1970, 67)”. They observe that in this light, it is curious that it has the same price as the above-mentioned *radius* (or a *fusus*, spindle, see below), as it requires more skill to make it, and it would presumably be larger.<sup>39</sup> They further note that in line 13,4 the Greek fragment from Geronthrai adds ἰς πῆνην, ‘for weft’, *i.e.* for beating up the weft – perhaps a paraphrase of the Latin *textorius*. It should be noted that ‘combs for raising the nap on woollen cloth’ are mentioned elsewhere in the Edict:<sup>40</sup>

*peçtines lanari*[i..c. 21.. X *se*]ptingentos  
quinquagint[a]  
[*pectin*]em? m[... c.28..] X *quadraginta* vacat

In Chapter 13, the following two lines (13,5-6) conform to the pattern of the list that was established for the previous items: They list spindles, first one made of boxwood with a whorl, for the price of 12

*denarii*, then one made of other wood than boxwood, also with a whorl, for the price of 15 *denarii*. While spindles were made of wood, spindle whorls could be made of many types of material: wood, bone, clay, stone, lead.<sup>41</sup> Even if the price for the spindle also covers the cost of the whorl, whose material is not indicated, the prices of 12 and 14 *denarii* seem extravagant, given the cheap materials presumably employed. All the tools from chapter 16 mentioned so far conform to one pattern, *i.e.* were made of boxwood *vs.* other woods: pin-beater, comb, and spindle (with whorl). It is curious that pin-beaters of wood other than boxwood are counted in pairs. Otherwise, all are textile tools, and even if they do not fit closely under the headline of ‘pin-beaters’ as a whole, one can comprehend them being listed in this category since they are wooden tools belonging to the textile profession.

The evidence becomes much more idiosyncratic with the following lines. It is rather intriguing that after the weavers’ combs in line 13.3 and 13.4 (both *textorium*), there are two lines which mention spindles, but line 13.7 again mentions a comb. However, this time it is specified as *pectinem muliebrem buxum*. Crawford and Reynolds translate it as ‘woman’s comb of boxwood’, noting that “double-sided boxwood combs were relatively common in the Roman world”.<sup>42</sup> Both Greek passages confirm this reading with κτένιον γυναικεῖον πύζινον. This comb seems to be distinct from the one mentioned in line 13,3 since it is explicitly characterized as a ‘woman’s’, and termed by the diminutive κτένιον in the Greek text, not κτένα like the weaving combs. It is not, however, differentiated as being smaller in the Latin text. It should also be noted that although both one sort of ‘weaving comb’ and the ‘woman’s comb’ are made of (relatively cheap) boxwood, the latter is two *denarii* more expensive than the boxwood weaving comb

38. Ida Demant, pers. comm.

39. Crawford & Reynolds 1977, 150.

40. Aphrodisias: *Aphr.* XXIX Col.III, 8-9 (=15.78-9): the editors (Erim & Reynolds 1973, 107) note that: “*Pectines lanarii* used for raising the nap on woollen cloth were characteristically made of iron, cf. Juvenal vii, 224 *qui docet obliquo lanam deducere ferro*”.

41. Crawford and Reynolds 1977, 150. See Gostenčnik 2010, 76, figure 14.5, for an example of a spindle from Magdalenberg (1<sup>st</sup> century BC to 1<sup>st</sup> century AD).

42. Crawford and Reynolds 1977, 150.

(or as expensive as a weaving comb made of ‘other’ wood). This suggests that, although it was perhaps a smaller item, it may have been more elaborately worked (e.g. with two rows of teeth) or have an altogether different function. Still, we are left without an explanation as to why the composer of the list should have found it necessary to mention a ‘woman’s comb’ under the headline ‘pin-beaters for weavers’.

The text goes on with another item that is qualified as *muliebris* or γυναικεῖον (‘for women’ or ‘women’s’): an *acus* in line 8. At first glance, *acus* leads us to believe that we are dealing with a term that has the same meaning as the *acus* that we have already encountered in chapter 16: needles in the modern sense of pointed, sharp objects, presumably with an eye for a thread. The adjective would not affect this interpretation, since one could imagine a needle that was, for example, used to execute delicate work that was associated with or carried out by women. On closer examination, this explanation does not stand up to scrutiny. One of the reasons is the Greek translation for the term *acus*. *Acus* is never translated in the Edict by ῥαφίς; however, in contrast to chapter 16 where *acus* is consistently translated as βελόνη,<sup>43</sup> in chapter 13 it is translated as κνηστρον.<sup>44</sup> The root κνη- signifies to scrape, scratch, grate or itch, therefore the most plausible translation would be a “scratcher” rather than a needle (see below). The term has thus caused some confusion. The passage could be seen as inconsistent, or the text as flawed, and perhaps the κνηστρα as unrelated to the other textile items, but at closer look at the etymology and inner structure of the chapter provides some clues.

The other reason why a straightforward translation as ‘women’s needles (sc. for textile work)’ is difficult, is that textile implements made of these materials (bone, tortoise shell, and amber) are not as frequently attested as one may expect in the archaeological record. Bone tools are attested where the soil conditions

allow it, but other materials are much more rare than the Edict would suggest. A crucial discrepancy between chapter 16 and chapter 13 is that the latter emphasises the material of the objects rather than their function, while chapter 16 specified their function and use and never mentioned their material. We now turn to the question of how to translate κνηστρον, then discuss the different materials mentioned, and finally consider how these items may fit under the headline of the chapter.

*The text regarding acus/κνηστρον in 13,8-10*

The Latin text as preserved on the fragment from Aizanoi initially lists 4 *acus osseas*, i.e. made of bone, that were used by women (*muliebres*); the price is unfortunately lost. The next line gives *acus testudines*, i.e. made of tortoise shell, and lists a price for one piece, but again the price is lost. The final line gives *acus sucinea*, i.e. made of amber, and again indicates one piece and a price that is not preserved. The Greek term for amber, σούκινος, is a Latin loanword.<sup>45</sup>

The exact reading of the Greek texts regarding lines 13,8-9 is, however, problematic. Both Greek fragments of the chapter (*Aedeps.* and *Ger. II*) are unfortunately badly preserved, but from what can be read and conjectured, the Greek texts differ slightly from the Latin. For line 13.8 in the *Aidepsos* fragment, Doyle reads<sup>46</sup> κνηστρον ὀστᾶϊν[ον, for ὀστᾶϊνον(?), tentatively translating it as “a scraper made of bone or with a bone handle?”. Line 13.10 mentions a κνηστρον σούκινον, but the price is lost. Doyle translates this line as “an amber scraper or a scraper with amber handle?”. It is noteworthy that the diminutive form κνηστρίον published by Lauffer only appears in the last line related to amber, and has no equivalent in the Latin text that only speaks of *acus*, not *acucula*.<sup>47</sup>

The diminutive form κνηστρίον is, however, found in both lines 13,9 and 13,10 in Geronthrai fragment. A

43. Chapter 16. 12; 12a; 13; 14.

44. Chapter 13. 8; 9; 10. Note that Lauffer has the diminutive κνηστρίον in 13.10.

45. σούκινος “aus Bernstein“ (*sucinum*), cf. Plin. 22,99 *sucinis novaculis*; Mart. 4,59,2; 6,15,2. Marcell. Emp. 26,17. *Geopon.* 15,1,29 ὁ ἠλεκτρῖνος λίθος ἦτοι σουχῖνος. *Sud.* IV.399 σούκινοι καὶ ἐλεφάντινοι δακτύλιοι γυναιξίν εἰσι σύμφοροι.

46. Doyle 1976, 91.

47. Cf. *CGL* II 351, 31: κνηστρίον *acucula scalprum* (*κνηστρίον acucla scalpum*).

further problem is also posed by the adjectives in this fragment. Line 8 is badly preserved and the first edition was erroneous. As it turned out, the suggestion of Doyle proved to be right (later confirmed by Lauffer (*app. crit.*)): ‘κνήστρον ὀστέϊνον[ον, for ὀστέϊνον(?)’, since it does in fact read -]ὀστέ...[ινον, followed by γυναικεῖον so it matches the *muliebres* in the Latin text, and gives a price of 12 *denarii*, again like the Latin text, but does not provide the information that the price is for 4 pieces. Lines 9 and 10 pose another major problem: they have been read as ‘κνήστριον ἰχθύων’, translated as fish scraper, and as ‘κνήστριον σκυτῶν’, translated as leather scraper.<sup>48</sup> These interpretations were questioned by Bingen who read the respective terms as χ...ελώνινον and σούκινον.<sup>49</sup> It is, however, noteworthy that both tools are specified as smaller than the bone item in the Geronthrai fragment, but until this is re-edited, no detailed discussion of terms can rely on it. Our argument will thus focus on the fragments from Aidespos and Aizanoi.

#### *κνήστρον and its variants*

We now proceed to the question of how to interpret the Greek name for the tool that matches the Latin *acus*: the κνήστρον that is attested in both Greek fragments of chapter 13 and thus cannot be dismissed as a simple mistake of either a modern reading of the fragments, or an individual misunderstanding on the part of the translator or engraver. As stated above, the root κνη- signifies to scrape, scratch, grate or itch. The mention of these ‘scratchers’ in chapter 13 rather than under the ‘needles’ in chapter 16 also suggests that they should be understood as distinct from the

βελόναι. Modern scholarship seems still unaware of this issue, for example, Giacchero translates *acus* with ‘ago’ (needle) and does not discuss the problems of the Greek term. Crawford and Reynolds, on the other hand, consistently translate *acus* in lines 13,8-10 as pins (bone-pins for women/tortoise-shell pins/amber-pins). They state that: “the nature of the materials quoted suggest that the *acus* were ladies’ hair-pins, not another type of weaving implement. They may have been made of a single piece of bone, tortoise-shell or amber; alternatively, they may have had wooden or bone shafts with ornamental heads (...).”<sup>50</sup> As noted above, Doyle suggested that they may have been handles.<sup>51</sup> Still, the question of how the Latin and the Greek term can be matched terminologically remains unanswered. There are two main hypotheses in trying to determine the potential meaning of the Greek word and the tool that it designated:

1. to assume that it is closely related to textiles since it is listed under the heading of “pin-beaters for weavers” and the other items mentioned in this chapter are also textile-related<sup>52</sup>
2. to assume that it is part of the female sphere since it is characterized as such and follows the item “comb for women”, and that the Latin *acus* might give an idea about its shape which was, presumably, a sort of pin

Let us begin by considering the first hypothesis. Beekes<sup>53</sup> (following Chantraine) connects κνήστρον to κνήσων (translated by Beekes as ‘scratcher’) which is found in an inscription from Delos, also in a textile context;<sup>54</sup> there is also the Latin loanword

48. Graser 1940, 359.

49. Cf. also Bingen 1965, 176, n.5: “De même, dans le texte, où aux articles 13 9 et 10 (l. 14 et 15 de la 1<sup>re</sup> colonne), il ne peut être question de lire ni κνήστριον [ἰ]χθύων[ν], ni κνήστριον σκυτῶν, qui ont reçu les honneurs suprêmes du Liddell-Scott-Jones. Je proposerais sous toute réserve d’après ma copie sur place et mon estampage : κνήστριον χ...ελώ[νινον] et κνήστριον σούκ...ιν...ον..., *grattoir d’écaille* et *grattoir d’ambre*. Ce qui me ferait suggérer que le OCT du mystérieux article 13 8 appartient sans doute à un κν...ήσ...τ...ρ...ιον Λ .Λ ὀστ[έϊνον].”

50. Crawford & Reynolds 1977, 151.

51. Doyle 1976, 91.

52. We cannot *a priori* assume that *acus* and κνήστρον (*vel sim.*) can be regarded as textile tools (but neither can we exclude it) since their characterization as *muliebris/γυναικεῖον* might be their main distinguishing element.

53. Beekes 2010, 720-721.

54. *ID* 1444Aa37: “ἐν τῷ κιβωτίῳ κνησῶνας? τρεῖς”. Cf. also an inscription from Attica, mentioning a silver κνηστρίς in a temple inventory, interpreted by the editors as a variant of κνηστρίον *IG* II<sup>2</sup> 4511, 9: .]κνηστρίον ἀργυροῦ[ν --- ] (= *IG* II/III<sup>2</sup> 4511).

*cnāsō* ‘aiguille pour gratter’ in Paul. ex Fest (*cnasonas* (acc.pl.): *acus, quibus mulieres caput scalpunt*<sup>55</sup>). Chantraine translates κνηστρίον as ‘instrument qui sert à racler’,<sup>56</sup> while *LSJ* translates it as ‘scraper’. Another thought is that it might have pointed to a certain type of tool material, since κνέωρος / κνήστωρ<sup>57</sup> (both words derive from the same root) designate a kind of wood, the so-called “stinging plant”, which was in fact also termed κνήστρον by some. This should, however, be dismissed since the κνήστρον is already qualified by adjectives denoting their material: bone, tortoise shell, and amber. If their main component had been “other wood than boxwood”, this would probably have been indicated, as with other items.

#### *κνηστρίον as hair-pin*

Joseph Maurer treated pins and needles in an article in 1951, where he argued that pins and needles were one and the same to the Greeks and Romans, and that the nouns βελόνη, ῥαφίς, *acus, aculea, acula* signified a needle, when the object had an eye for a thread, and a pin when it had a knob, small globe, or other ornamental termination.<sup>58</sup> We would argue the contrary, that Greek could distinguish between the

senses of Latin *acus* by the use of two terms.

In 2008, Janet Stephens, a professional hairdresser and researcher into the hairstyles of the Greeks and Romans, reconsidered the nature of Roman hairpins and arrived at some differing functions for hairpins and needles that have implications for interpreting the Edict.<sup>59</sup> She argues that commentators on the techniques of Roman hairdressing demonstrate modern biases that lead to anachronistic speculation, based on a faulty understanding of the technical possibilities of the tools available to Roman hairdressers. According to Stephens, the so-called single prong hair-pin (which she terms ‘hair bodkin’) cannot have been used in many contexts and she proposes that Roman women used sewing-needles (with eyes) to stitch together the elements of a hair-style (e.g. rows of plaits) when they were no longer using *vittae*<sup>60</sup> – linen or woollen ribbons used to tie the hair together when arranging it – perhaps around 50 BC.<sup>61</sup> Stephens carefully defines the terms of ancient Roman (and modern) hairdressing, noting correctly that the Latin *acus* is often used to define – in her opinion – three similarly-shaped but distinctly different hairdressing tools: namely the ‘hair bodkin’,<sup>62</sup> the ‘needle-and-thread’,<sup>63</sup> and the

55. Paul. ex Fest. p. 52, 17 Müller.

56. Chantraine 2009, 525 (*κνηστρίον* as read by Lauffer).

57. Cf. Plin. *NH* 13.114.

58. Maurer 1951, 161.

59. Stephens 2008.

60. She adduces Isid. *Etym.* 19.30.4; Ov. *Am.* 3.6.56, *Ars. Am.* 1.31, *Met.* 1.477, *Pont.* 3.351, *Rem. Am.* 386; Pl. *Mil.* 792; Prop. 4.11.34; Tib. 1.6.67; Val. Max. 5.2.1; Verg. *Aen.* 7. 403. According to Stephens (2008, 111, n.5) the *vittae* can be seen in both Etruscan sculpture and the Hellenistic art of Southern Italy and the *nodus* hairstyle epitomised by Livia was presumably the most influential in promoting hair-sewing, after which the *vittae* became associated primarily with ceremonial (i.e. bridal) and hieratic (i.e. Vestal) hairstyle.

61. Stephens 2008, 111.

62. Stephens 2008, 112; their basic design being similar to modern knitting needles and made in various lengths; they are mentioned in ancient sources as made of gold and silver and decorated with precious stones (cf. Ulpian. *Dig.* 34.2.25.10: *acus cum margarita, quam mulieres habere solent* “*acus* set with pearls which women are accustomed to have”), but most surviving Roman hair bodkins are made from bone. Also termed *discerniculum*, cf. Varro *LL* 5.29.129.

63. Needle-and-thread: Stephens defines a ‘needle’ as a rod-shaped object “pointed on one or both ends and drilled through with one or more small, circular or elongated holes (eyes)”, designed to carry the thread. Furthermore, a needle must, by Stephens’ definition, “have a hole meant to carry thread, and it cannot have an enlarged head meant to inhibit its passage through the material to be sewn”. This does not accord with current archaeological evidence, where bone sewing needles with enlarged heads have been found (E. Andersson Strand, pers. comm.).

‘curling iron’.<sup>64</sup> According to Stephens, the definition in Festus, *acus dicitur, qua sarcinatrix vel etiam ornatrix utitur* “*acus* refers to the tool used by the cloth-mender as well as the hairdresser”,<sup>65</sup> indicates that ‘sewing needle’ is the “default definition of the unmodified noun *acus*.”<sup>66</sup> Thus, this is another example of textile technology used in a non-textile craft. In both textile craft and hairdressing, a needle with an eye is used for the same function (sewing).

The hair bodkin can have an enlarged (and decorative) head in order to maintain adequate isometric tension in the hairstyle.<sup>67</sup> They could also add glamour to finished hairstyles, if they were made of precious metals, gems, ivory, or bone; and the tortoise shell and amber mentioned in the Edict could very well denote decorative heads on such hair bodkins.

To return to the problem of κνήστρον: Stephens makes the pertinent and rarely (never?) observed comment that the hair bodkin would probably also have been used as a “genteel head-scratcher, which could reach deep into elaborate styles where fingers could not reach”, conforming to the statement of Festus: *cnasonas acus quibus mulieres caput scalpunt*.<sup>68</sup> As stated above, the *cnasonas* of Festus reflect the same root as κνήστρον. We also have evidence that the root \**kna-*/\**kne-* could also be related to a pin-shaped object that was driven into something and that was called a κνηστής.<sup>69</sup> The *acus* of the Edict translated by κνήστρον makes perfect sense in comparison to the κνηστής mentioned in a passage of Plutarch and to a gloss in Hesychius:

Plutarch (Plut. *Ant.* 86.4): τὸ δὲ ἀληθὲς οὐδεὶς οἶδεν: ἐπεὶ καὶ φάρμακον αὐτὴν ἐλέχθη φορεῖν ἐν κνηστήδι κοίλῃ, τὴν δὲ κνηστίδα κρύπτειν τῇ κόμῃ.

“But the truth of the matter no one knows; for it was also said that she carried about poison in a hollow hairpin (κνηστής) and kept the hairpin hidden in her hair”.

Hesychius (*s.v.*): κναστήριον· ἐνήλατο<ν>. Λάκωνες

“The Laconians term “something driven in” κναστήριον.”

Both texts confirm that a κνηστής or κναστήριον is an object that was ‘driven into something’, in case of Plutarch’s text, into the hair. It is noteworthy that Hesychius speaks of a Laconian word, and that the inscription from Geronthrai is also from Laconia, while Aidespos is situated on Euboea where one could perhaps rather expect an Ionian term. Regardless of any potential Laconian basis for the term, it seems safe to claim that ‘pin’ would be an appropriate translation both for Plutarch and Hesychius, and that the κνήστρον in the Edict are etymologically related and might refer to pins, which can also be used as scratchers.

If we accept that one of the functions of the κνήστρον/κνηστήριον in Chapter 13 could be as a hair pin (bodkin) which could also act as a scratcher, then we need also to add this to the functionality of the Latin *acus*. Even if in chapter 16 the use of *acus* and its translation as “needle” (matching Greek βελόνη) in the modern sense seems to be justified, we have to be aware that there can be also other possibilities of translation and use of the word. The *Thesaurus Linguae Latinae* (*s.v.*) proposes the following distinctions in the term *acus* (noting that it is equivalent to Greek ῥαφίς<sup>70</sup> and βελόνη):<sup>71</sup>

64. Also termed *calamistrum*, cf. Varro *LL* 5.29.129, and *discriminalia*, cf. Isid. *Etym.* 19.31.8. Isidorus uses the word *acus* to describe the shape of the *calamistrum*, Isid. *Etym.* 20.13.4.

65. Festus, *Glossaria Latina*, *s.v. acus*.

66. Stephens 2008, 113.

67. Stephens 2008, 116.

68. Stephens 2008, 117, Festus 52.17 (Müller).

69. The term κνήστις (note the accent) denotes a cheese-grater.

70. ῥαφίς does not occur in the Edict, but so does the adjective ῥαφική in 16.12a, qualifying βελόνη, and translating *sartoria*, cf. below. The root is also attested in ῥάπτῃς/ὑποραφή/ὑπόραφίς (7.48-51).

71. Cf. Blümner 1912, 213-215 for sewing.



*Pungendi figendique instrumentum*  
*Crinium comendorum instrumentum*  
*Crinium retinendorum ornandorumve*  
*instrumentum*  
*Suendi instrumentum*  
*Varii usus instrumenta*

These all have in common that they are ‘sharp’ or pointed instruments. *Acus* are also used for putting up and ornamenting the hair. The problem of understanding the semantic field is perhaps influenced by/connected to the modern sense of the term ‘needle’ which indicates a very sharp and pointed pin-like metal object.

### ***Materiality of the acus and archaeological finds***

That our “pins” in chapter 13 are of a different quality than the “needles” in chapter 16 might also be confirmed by the materials they are made of. With the exception of tortoise-shell objects (which might be preserved) we have archaeological finds of pin-shaped objects made of bone and of amber.

#### *Evidence of bone pins*

The “bone pins for women” in chapter 13 might find a match in the archaeological evidence. A set of bone pins comes from the Roman settlement at Magdalensberg in Austria.<sup>72</sup> The objects have rounded and/or decorated heads and are interpreted as spindles and distaffs and show, according to the excavators, signs of use. These objects are sometimes elaborately decorated. One could well assume that they might have been multifunctional: perhaps used by women as a decorative item, *e.g.* as hair pins, and pins that held garments together.

Finally, a bone pin might also have been good for working with soft threads and tapestry weaving since the smooth surface does not damage the thread. As Eva Andersson Strand points out, bone needles do not leave a hole in certain types of woven woollen fabrics when used.<sup>73</sup> Thus the “bone pins for women” might indeed refer both to pins used by women in textile work, (spindles, distaffs, spools and pin beaters) or decorative items like hairpins, or pins that held clothing in place. In the so-called Tomb of the Embroideress, dating to late 5<sup>th</sup>-7<sup>th</sup> century, a wonderful array of textile tools was found. These include weaver’s combs, spindles with whorls and spun thread attached and a series of spools with linen thread still wound round them, and some similar shaped ‘pins’ which are identified as wooden and ivory rods tentatively identified as weaving implements, but also perhaps as *styloi*.<sup>74</sup>

#### *Amber*

Archaeological evidence may also attest to the *acus sucinea*, amber pin. We know amber distaffs (or rather distaffs that were made of metal and had amber elements) from Etruscan tombs in Verrucchio. Amber spindle whorls were found in Magdalensberg,<sup>75</sup> and Pliny notes the use of such whorls in Syria.<sup>76</sup>

While there are examples of amber tools, they are dated much earlier than the Edict;<sup>77</sup> however, they do attest to the fact that there were pin-shaped textile tools made of amber. Whether the amber pins were merely status symbols that were put into the graves, or whether they were used in life, remains a matter of dispute. Their practical use would depend on the task since amber is a very soft material (that would on the other hand also be very gentle with fine textile fibres). This might actually match the characterization of the amber *acus* as “small” (or: more delicate)

72. Gostenčik 2010, 76. See also Trinkl 2007, 81-86, for a discussion of textile tools from Roman Imperial times in Ephesus, including bone needles (fig. 13.4) and finely decorated bone distaffs (fig. 13.7).

73. Eva Andersson Strand, pers. comm.

74. Van Raemdonck *et al.* 2011, 223-224 (inv. nrs. E 1036 and 1037).

75. Gostenčik 2010, 73.

76. Plin. *NH* 37, 11, 37.

77. See the Etruscan amber spindle or distaff from Grave 43, Verucchio, in Ræder Knudsen 2007, 110, Fig. 17.14.

in both of the Greek fragments, since a small amber pin for e.g. tapestry weaving might have worked well, but a longer tool fully made of amber might have been too soft and fragile for heavier work like sewing or spinning (not to mention the price for such a piece – unfortunately none of the fragments of the Edict have preserved any numbers regarding amber so far).

#### *Tortoise shell*

Unfortunately we do not know of any archaeologically attested pin-like items made of tortoise shell, but as already stated, this may also be due to the preservation conditions in the Mediterranean areas where fragments of the Edict were found. The use of the tortoise shell pins might have resembled that for amber (also because these *acus* are mentioned in the diminutive in the Greek texts), since the material seems equally unsuitable for the heavier tasks of textile production. But they might have worked as smaller decorative items like hairpins that might as well have been a specifically female form of adornment.

#### *Gold*

Precious metals are not listed among the materials in the Edict, but it should be mentioned that according to literature golden *acus* were used as adornment for the hair.<sup>78</sup> Thus a certain extravagance in hair pins like amber or tortoise shell ones (or elaborate bone pins) fits well into the historical context.

#### *Wood*

The chapters discussed here refer to at least two types of wood: boxwood that seems to have been a kind of standard material for textile tools and that was used both for pin-beaters and other textile tools,

and other types of wood.<sup>79</sup> As with pin-beaters, spindles are subdivided into those of boxwood and those of other kinds of wood, that of boxwood being three *denarii* cheaper, i.e. 12 *den*.<sup>80</sup>

The same varieties in wood are repeated regarding combs, where we have two items that are explicitly qualified as weaving combs in Latin (*pectinem textorium*; only the second one is so termed in Greek: κτένα ἰς πήνην). The last variety is a comb, made of boxwood, which is termed *muliebrem*. We cannot be sure whether this last item is in fact a textile tool. It may also simply be the first item in a list of female accessories, which brings us to another interpretation of lines 7-10 in chapter 13 of the Edict.

#### *‘muliebris’*

Concerning the group specified by the adjective *muliebris* that is used for *pecten* and *acus* made of bone (*osseas*), it is doubtful whether they were used as textile tools. The subsequent *acus* made of tortoise shell and of amber are not specified as *muliebris*, but they could well fit into the category anyway, since the Edict often lists items of the same kind or different qualities in subsequent lines.<sup>81</sup> An amber or tortoise shell *acus* could presumably well be conceived of as a hairpin (especially since, like a bone pin, it could be worked very smoothly and thus would not hurt the scalp), and the material might also have been specifically connected with female adornment like in the case of amber, and thus accrue the qualification γυναικεῖα.<sup>82</sup>

#### *The prices of textile tools*

The price of the textile tools from the most expensive to the cheapest are shown in Table 1.

The pricing of the different items in the Edict is not easy to follow. This is to a large degree due to problems with the preservation of the inscriptions.

78. Martial 14.24.1-2.

79. See Stauffer 2008, 12, fig. 4, for late antique wooden *acus* with yarn still wound around them.

80. Whorls are in both cases sold with the spindle (13. 5; 6).

81. Wild 1964, 264; Reynolds 1981, 283.

82. The qualification γυναικεῖος recurs in three further sections of the Edict *I.e.* 7,54; 9,21; 13,8. γυναικεῖος cf. 13,7.

**Table 1.** Prices of textile tools from the *Edictum Diocletiani*

Price	Tool	Material <sup>83</sup>	Specification	Line
<b>Chapter 13</b>				
15 den. each	Pin-beater	Other wood	-	13,2
15 den.	Spindle	Other wood	Including whorl	13,6
14 den.	Pin-beater	Boxwood	-	13,1a
14 den.	Comb	Other wood	For weaving	13,4
14 den.	Comb	Boxwood	Women's	13,7
12 den.	Comb	Boxwood	For weaving	13,3
12 den.	Spindle	Boxwood	Incl. whorl	13,5
4 den.	Pin?	Tortoise shell	Small, (maybe also women's item)	13,9
3 den. each <sup>84</sup>	Pin?	Bone	Women's item	13,8
No price	Pin?	Amber	Small, (maybe also women's item)	13,10
<b>Chapter 16</b>				
4 den.	Needle	-	<i>sartoria sive subfiscclatoria</i> <i>suptilissima</i> /ραφική ισχνοτάτη	16,12a
2 den.	Needle	-	Second grade	16,13
2 den.	Needle	-	<i>ciliciaria sive sagmaria</i> /σακκοράφη ήτοι σαγματική	16,14

As Crawford and Reynolds note: “The formula numero I, II etc. (lines 2, 8, 7<sup>85</sup>, 10 [in the Latin version of chapter 13]) is reproduced in the Greek as simple α’ and β’ in lines 1a and 2, but is missed out elsewhere.” Crawford and Reynolds’ statement that “the pricing policy is hard to interpret” also stems from the fact that they assume certain qualities of material to be better than others, without the text corroborating it. This is the case, for example, for boxwood. Crawford and Reynolds state: “The best sort of *radius*, in boxwood, cost 14 *denarii* each; but in ordinary wood they cost 30 *denarii* for 2, or 15 *denarii* each! Similarly, a weaver’s comb of boxwood was cheaper than a comb of ordinary wood (lines 3 and

4) and a boxwood spindle was cheaper than its ordinary wood counterpart (lines 5 and 6).” To explain the price differences of the supposedly cheaper “other wood”, they come to the conclusion: “It may be that the boxwood tools were smaller than those for everyday use.” They do not take into consideration that boxwood might have been the cheaper material as opposed, for example, to walnut wood, which is mentioned for beds in the Edict.<sup>86</sup>

Crawford and Reynold’s criticisms of the Greek version of the prices for pins in chapter 13, however, are justified. In the Latin fragment the numbers of pins that cost a certain price (that is unfortunately lost) are indicated (4 bone pins, and 1 tortoise shell

83. The materials of the needles in chapter 16 are left unspecified, the only possible exception being *sufiscclatoria* in line 12a which may denote reed. However, it seems cogent, judging from the uses specified in the text itself, to strictly relate them to sewing, which might, of course, also have implications for the material they were made from.

84. *I.e.* 4 for 12 den.

85. *I.e.* 9.

86. Chapter 12.29a. What is the distinction between *promisquae (materiae)* and *alterius (materiae)*? It is noteworthy that not only is this distinguished in the Latin fragment, but also both Greek fragments that attest these lines (Aidepsos and Geronthrai) are uniform in using ἐκ διαφόρων ξύλων (of different types of wood) in lines 13,2 and 13,4, but ἐξ ἑτέρων ξύλων (of other types of wood) in line 13,6.

and amber pin respectively). The Greek texts do not mention the numbers of items, only the price: 12 *denarii* for 4 bone pins, *i.e.* 3 *denarii* for each, and 4 *denarii* for one tortoise pin.<sup>87</sup> But, as Reynolds and Crawford observe: “one would expect a tortoise-shell *acus* to cost more, not less, than one of bone [NB: that was actually cheaper, but only when one knows that the bone pins came as a set of 4]!”<sup>88</sup>

With regard to the prices listed in chapter 13 in the fragment from Aidepsos, Doyle notes that the price listed in 13.2, for two κερκίδες, is α...´ (1) in this fragment, but that the price λ´ (30) of the Geronthrai fragment makes better sense; the price in line 13.4 for combs of wood other than boxwood is η´ (8) in Aidepsos, but ιδ´ (14) in Geronthrai; in 13.6, referring to spindles with spools made of wood other than boxwood, he states that again the Aidepsos price, α´ (1), makes no sense, referring to Geronthrai, which has ιε´ (15); in 13.7 the Aidepsos price for a small comb for women made of boxwood is β´ (2), while Geronthrai has ιδ´ (14); in 13.9, referring to the tortoise shell pin, Doyle states that the price δ´ (4) is too low to be credible (also noting that Mommsen-Blümner reads κνήστρον ιχθύων [*i.e.* in the very same Geronthrai fragment]).<sup>89</sup>

It should, moreover, be noted that if we leave aside the amber and tortoise shell *acus* whose price cannot be established with any certainty, at least the bone *acus* are approximately equal in price to the needles mentioned in chapter 16. As already stated, the bone *acus* cost 3 *denarii* each and they are sold in sets of 4. This suggests that they are either used in larger numbers or that they are more likely to wear and get disposed of or be lost, a point which is corroborated by the archaeological evidence of bone pins with traces of use. They might have been used, for example, for tapestry weaving, or spinning. The needles in chapter 16 range from 4 *denarii* for a very fine sewing needle (16.8a) to 2 *denarii* apiece for so-called second grade needles (16.13),<sup>90</sup> and 2 *denarii* apiece for needles for

the sewing of coarser items such as sacks and pack-saddles (16.14), necessitating a much stronger needle. Their material is not mentioned, but archaeological finds seem to indicate that they were most likely made of metal.

The most expensive items are pin-beaters, spindles and combs, which might have been related due to their size. The (probably also smaller) bone, amber and tortoise-shell pins come at the end of the list. We have to take into consideration that certain kinds of wood may have been much more precious than commonly assumed in an Empire that spanned desert regions where wood was extremely scarce, but needed for tools of indispensable everyday tasks like textile production.

### Conclusion and further perspectives

A survey of the textile tools in chapters 16 and 13 of the Edict has yielded the following with regard to terminology. Headlines do not always mirror the entirety of items listed below them, as already noted by Doyle. While chapter 16 exclusively deals with needles, as it states in its headline, chapter 13 does not only comprise the pin-beaters of the headline, but goes on to other textile tools and even, in lines 7-10, to items that may be only vaguely related to the above-mentioned tools, because they were made in the same or similar workshops. The texts mention different kinds of textile tools, of which the term *acus* posed the biggest challenge because it was translated differently in the two chapters treated here. In chapter 16 of the Edict where Latin *acus* is translated into Greek as βελόνη, these tools are:

- qualified by function and by quality
- presumably monofunctional
- presumably referring to a pointed (metal?) object with an eye that would fit the definition of a modern “needle”

87. It is a problem that the prices here are all supplemented from the Greek; there are no prices attested in the Latin fragment.

88. Crawford & Reynolds 1977, 150.

89. Doyle 1976, 91.

90. They are presumably still fine needles, as they follow immediately after line 13.8a.

In chapter 13 of the Edict where Latin *acus* is translated into Greek as κνήστρον (*vel. sim.*), these tools are:

- qualified by material that varies considerably, even in textile tools
- presumably multifunctional (not merely pin-beaters or hairpins etc.)
- presumably pointed objects without an eye.
- not to be interpreted as scrapers, but rather as scratchers

The term *acus* in the Edict thus denotes two distinct objects:

- when it corresponds to Greek as βελόνη, it can be interpreted as a "needle" in the modern sense, *i.e.* as a pointed pin-like tool made of metal, maybe even with an eye
- when it is translated into Greek as κνήστρον (*vel. sim.*), it can be interpreted as a "pin" that might have served different functions depending on its actual use, ranging from female hair adornment, to spindles, distaffs and maybe even tapestry spools

Looking into texts on the uses of needles, we can state that an *acus* in the sense of Greek βελόνη was used for **a**) sewing and stitching (even repair), and as a needle for a tailor, as indicated by the adjectives in chapter 16 itself; **b**) decorating, probably tapestry, taquéte and maybe even embroidery, though the latter technique was much scarcer in antiquity than the first two mentioned.<sup>91</sup> There is one passage in the Edict (7,53) where the use of an *acus*/βελόνη is attested to ornate garments, in this case a *centuclum*, a blanket. The Latin text reads: [C]entuclum primum ornatum ab acu ponderis supra script[i], the Greek text: κέντουκλον πρωτεῖον κεκοσμημένον ἀπὸ βελόνης λ(ιτρῶν) γ'. The crucial terms are *ornatus ab acu*/κεκοσμημένον ἀπὸ βελόνης. If the Greek term βελόνη is related to a sharper, needle-like tool as in chapter 16, the technique referred to here might very well have

been embroidery and not tapestry weaving. Of course, this assumption rests on a consistent use of βελόνη.

The *acus* in the sense of a pin was probably, if used as a textile tool, rather a spool both for tapestry and taquéte weaves (*in lieu* of a "shuttle").<sup>92</sup> Famous passages for tapestry weaving use the terms *acu pingere*,<sup>93</sup> *e.g.* Ovid in his *Metamorphoses* where he tells the story of the famous weaver Arachne, who dared to enter into a weaving contest with the goddess Minerva and was turned into a spider:

*Nec factas solum vestes, spectare iuvabat  
/ tum quoque cum fierent (tantus decor ad-  
fuit arti), / sive rudem primos lanam glom-  
erabat in orbes, / seu digitis subigebat  
opus repetitaque longo / vellera mollibat  
nebulas aequantia tractu, / sive levi tere-  
tem versabat pollice fusum, / seu pingebat  
acu: scires a Pallade doctam. (Met.  
6, 17-23)*

"And it was a pleasure not alone to see her finished work, but to watch her as she worked; so graceful and deft was she. Whether she was winding the rough yarn into a new ball, or shaping the stuff with her fingers, reaching back to the distaff for more wool, fleecy as a cloud, to draw into long soft threads, or giving a twist with practised thumb to the graceful spindle, or to paint with her *acus*: you could know that Pallas had taught her."

Another technique is that of the work of the *plumarii*, interpreted as tapestry weavers by Wild and Droß-Krüpe.<sup>94</sup> Lucan describes Cleopatra's splendid palace furnishings as a backdrop to the seduction of Caesar, but does not mention which tools were used to create the stunning effects in the fabric:

*strata micant, Tyrio cuius pars maxima  
fusco / Coctadiu virus non uno duxit aeno, /*

91. See also Droß-Krüpe & Paetz gen. Schieck 2014 on terms for and the rare examples of embroidery in antiquity.

92. See Wild & Droß-Krüpe this volume.

93. See also Droß-Krüpe & Paetz gen. Schieck 2014.

94. Wild & Droß-Krüpe 2017.

*pars auro plumata nitet, pars ignea cocco / ut mos est Phariis miscendi licia telis (Bellum civile 10, 123-126)*

“The coverlets were shining bright, most had long been steeped in Tyrian dye and took their hue from repeated soakings, while others were decorated in the “feather-technique” with bright gold(-thread), and others blazed with scarlet, as the Egyptian manner is of mingling weft-threads in the web.”

The question arises as to why the Latin text used only a single seemingly indistinct term like *acus*. Future studies may reveal whether we can determine a chronological development in the terminology of *acus*, and whether we are dealing with a development that was confined to certain areas and only spread because the term was used in an imperial inscription.

Finally, the question of regional linguistic and functional variations of terms in the Edict arises. The Latin texts seemed quite standardized, at least in the fragments discussed, and can with a good degree of probability be traced back to a single document issued by a central imperial authority. The Greek versions, however, might have been subjected to several iterations and deviations, depending on the ability of copyists(?) and engravers who might have misread and misinterpreted the template. Last, but not least, it would be interesting to look further into the question of how language and terminology correspond to the multifunctionality of textile tools in different regions and epochs.

## Bibliography

- Arnaud, P. (2007) Diocletian's prices edict: the prices of seaborne transport and the average duration of maritime travel. *JRA* 20, 321-336.
- Bagnall, R. S. (1985) *Currency and Inflation in Fourth Century Egypt*. Bulletin of the American Society of Papyrologists Supplements 5. New York.
- Barańscy, A., Barańscy, P. & Janiszewski, P. (2007) *Edictum Diocletiani de Pretiis Rerum Venalium*. Poznań.
- Barber, E. J. W. (1991) *Prehistoric Textiles: The Development of Cloth in the Neolithic and Bronze Ages with Special Reference to the Aegean*. Princeton.
- Beekes, R. S. P. (2009) *Etymological Dictionary of Greek*. Leiden – Boston.
- Bingen, J. (1953) Fragment argien de l'Édit du maximum. *BCH* 77, 647-659.
- Bingen, J. (1965) Le fragment de l'Édit du Maximum *IG V 1, 1359 B. BCH* 89, 173-179.
- Blümner, H. (1912) *Technologie und Terminologie der Gewerbe und Künste bei Griechen und Römern*. Leipzig – Berlin.
- Brandt, H. (2004) Erneute Überlegungen zum Preisedikt Diokletians. In A. Demandt, A. Goltz & H. Schlange-Schöningen (eds.), *Diokletian und die Tetrarchie. Aspekte einer Zeitenwende*, 47-55. Millennium-Studien 1. Berlin – New York.
- Chaniotis, A. & Preuss, G. (1990) Neue Fragmente des Preisedikts von Diokletian und weitere lateinische Inschriften aus Kreta. *ZPE* 80, 189-193.
- Chantraine, P. (2009) *Dictionnaire étymologique de la langue grecque. Histoire des mots*. Achevé par J. Taillardat, O. Masson et J.-L. Perpillou. Paris.
- Cizuk, M. (2000) Taquetés from Mons Claudianus: Analysis and Reconstruction. In Cardon, D. & M. Feugère (eds.), *Archéologie des textiles des origines au V<sup>e</sup> siècle*, 265-290. Montagnac.
- Corcoran, S. (1996) *The Empire of the Tetrarchs. Imperial Pronouncements and Government A.D. 284-324*. Oxford.
- Corcoran, S. (2008) The Heading of Diocletian's Price Edict at Stratonicea. *ZPE* 166, 295-302.
- Corcoran, S. & Delaine, J. (1994) The Unit Measurement of Marble in Diocletian's Price Edict. *JRA* 7, 263-273.
- Crawford, M. H. & Reynolds, J. (1977) The Aezani Copy of the Prices Edict. *ZPE* 26, 125-151.
- Demandt, A. (1989) *Die Spätantike. Römische Geschichte von Diocletian bis Justinian 284-565 n. Chr.* München.
- Doyle, E. J. (1976) Two New Fragments of the Edict of Diocletian on Maximum Prices. *Hesperia* 45, 77-97.
- Droß-Krüpe, K. & A. Paetz gen. Schieck (2014) Unraveling the tangled threads of ancient embroidery: a compilation of written sources and archaeologically preserved textiles. In M. Harlow & M.-L. Nosch (eds), *Greek and Roman Textiles and Dress. An Interdisciplinary Anthology*, 207-235. Ancient Textiles Series 19. Oxford.
- Edmunds, S. T. (2012) Picturing Homeric Weaving. In: *Donum Natalicium Digitaliter Confectum Gregorio Nagy*

- Septuagenario a Discipulis Collegis Familiaribus Oblatum*. Harvard, <http://chs.harvard.edu/CHS/article/display/4365> (accessed 19/10-2015).
- Erim, K. T. & Reynolds, J. (1973) The Aphrodisias Copy of Diocletian's Edict on Maximum Prices. *JRS* 63, 99-110.
- Erim, K. T., Reynolds, J., & Crawford, M. H. (1971) Diocletian's Currency Reform. A New Inscription. *JRS* 61, 171-177.
- Erim, K. T., Reynolds, J., Wild, J. P. & Balance, M. H. (1970) The Copy of Diocletian's Edict on Maximum Prices from Aphrodisias in Caria. *JRS* 60, 120-141.
- Giacchero, M. (1974) *Edictum Diocletiani et Collegarum de pretiis rerum venalium, in integrum fere restitutum e Latinis Graecisque fragmentis. Vol. 1: Edictum. Vol. 2: Imagines*. Genova.
- Giacchero, M. (1983) Commerci e produzioni delle aree fenicia e punica nell'edictum de pretiis diocleziano. In *Atti del I Congresso internazionale di studi fenici e punici. Roma, 5-10 Novembre 1979*, 879-883. Rome.
- Gleba, M. (2008) *Textile Production in Pre-Roman Italy*, Ancient Textiles Series 4. Oxford.
- Gostenčnik, K. (2010) The Magdalensberg Textile Tools: a Preliminary Assessment. In Andersson Strand, E., Gleba, M., Mannering, U., Munkholt, C. & Ringgaard, M. (eds.) *North European Symposium for Archaeological Textiles X*, 73-90. Oxford & Oakville.
- Graser, E. R. (1940) The Edict of Diocletian on Maximum Prices. In T. Frank (ed.), *An Economic Survey of Ancient Rome vol. V: Rome and Italy of the Empire*, 305-321. Baltimore.
- Hekster, O. (2008) *Rome and its Empire, AD 193-284*. Edinburgh.
- Kuhoff, W. (2001) *Diokletian und die Epoche der Tetrarchie. Das römische Reich zwischen Krisenbewältigung und Neuaufbau (284-313 n. Chr.)*. Frankfurt a. M. et al.
- Lauffer, S. (1971) *Diokletians Preisedikt*. Berlin.
- Leadbetter, B. (2003) Diocletian and the purple mile of Aperlae. *EA* 36, 127-136.
- Leake, W. M. (1826) *An Edict of Diocletian Fixing A Maximum of Prices Throughout the Roman Empire. A.D. 303*. London.
- Loring, W. (1890) A New Portion of the Edict of Diocletian from Megalopolis. *JHS* 11, 299-342.
- Macpherson, I. W. (1952) A Synnadic Copy of the Edict of Diocletian. *JRS* 42, 72-75.
- Maurer, J. A. (1951) On Pins and Needles. *The Classical Weekly* 44.11, 161-165.
- Meißner, B. (2000) Über Zweck und Anlaß von Diokletians Preisedikt. *Historia* 49, 79-100.
- Mickwitz, G. (1932) *Geld und Wirtschaft im römischen Reich des vierten Jahrhunderts n. Chr.*. Helsingfors.
- Mommsen, T. & Blümner, H. (1958) *Der Maximaltarif des Diokletian*, 2. ed., Berlin.
- Naumann, F. (1973) Das Edikt des Diokletian in Aezani. In Naumann, R. & Naumann, F., *Der Rundbau in Aezani*, 28-67. Tübingen.
- Noethlichs, K. L. (2010) Edictum. In *Brill's New Pauly. Antiquity volumes edited by H. Cancik & H. Schneider*, Brill Online, <http://www.brillonline.nl> (accessed 06 December 2010).
- Pfister, R. & Bellinger, L. (1945) *The Excavations at Dura-Europos conducted by Yale University and the French Academy of Inscriptions and Letters. Final Report IV. Part II: The Textiles*. New Haven et al.
- Polichetti, A. (2001) *Figure sociali, merci e scambi nell'edictum Diocletiani et Collegarum de pretiis rerum venalium*. Naples.
- Potter, D. S. (2013) *The Roman Empire at Bay*, 2. ed. London.
- von Reden, S. (2002) Money in the Ancient Economy: A Survey of Recent Research. *Klio* 84, 141-174.
- Reynolds, J. (1981) Diocletian's Edict on Maximum Prices: The Chapter on Wool. *ZPE* 42, 283-284.
- Roueché, C. with contributions by J. M. Reynolds (1989) *Aphrodisias in Late Antiquity*. *JRS Monographs* 5. London.
- Ræder Knudsen, L. (2007) 'Translating' Archaeological Textiles. In Gillis, C. & Nosch, M.-L.B. (eds.), *Ancient Textiles. Production, Craft and Society*, 103-111. Oxford.
- Speidel, M. (2009) Wirtschaft und Moral im Urteil Diokletians. Zu den kaiserlichen Argumenten für Höchstpreise. *Historia* 58/4, 486-505.
- Stauffer, A. (2008) *Antike Musterblätter. Wirkkartons aus dem spätantiken und frühbyzantinischen Ägypten*. Wiesbaden.
- Steigerwald, G. (1990) Die Purpursorten im Preisedikt Diokletians vom Jahre 301. *ByzF* 15, 219-276.
- Stephens, J. (2008) Ancient Roman hairdressing: on (hair) pins and needles. *JRA* 21, 110-132.
- Thompson, J. & Granger-Taylor, H. (1995-1996) The Persian Zilu Loom of Meybod. *CIETA Bulletin* 73, 27-53.
- Trinkl, E. (2007) Artifacts Related to Preparation of Wool and Textile Processing Found Inside the Terrace Houses

- of Ephesus, Turkey. In Gillis, C. & Nosch, M.-L.B. (eds.), *Ancient Textiles. Production, Craft and Society*, 81-86. Oxford.
- Turner, E.G. (1961) Latin versus Greek as a Universal Language: the Attitude of Diocletian. In *Language and Society. Essays presented to Arthur M. Jensen on his Seventieth Birthday*, 165-168. Copenhagen.
- Van Raemdonck, M., C. Verhecken-Lammens & D. De Jonge (2011) The mummy of the embroideress and the contents of her grave. In A. De Moor & C. Fluck (eds.) *Dress Accessories of the 1<sup>st</sup> Millennium AD from Egypt*, 236-258. Tiel.
- Whitehouse, D. (2004) Glass in the Price Edict of Diocletian. *Journal of Glass Studies* 46, 189-190.
- Whitehouse, D. (2005) Alexandrian and Judaean Glass in the Price Edict. *Journal of Glass Studies* 47, 184-186.
- Wild, J. P. (1964) The Textile Term *Scutulatus*. *CQ New Series* 14, 263-266.
- Wild, J. P. (1967) Two technical terms used by Roman tapestry-weavers. *Philologus* 111, 151-55.
- Wild, J. P. (1970) *Textile Manufacture in the Northern Roman Provinces*, Cambridge.
- Wild, J. P. (2008) Textile production. In J. P. Oleson (ed.), *The Oxford Handbook of Engineering and Technology in the Classical World*, 465-482. Oxford.
- Wild, J. P. (2014-2015) The Edict of Diocletian, Aria and Cashmere, *Saitabi. Revista de la facultat de Geografia i Història* 64-65, 11-23.
- Wild, J. P. & Droß-Krüpe, K. (2017) *Ars polymita, ars plumaria*: The weaving terminology of *taqueté* and tapestry. In S. Gaspa, C. Michel & M.-L. Nosch (eds.), *Textile Terminologies from the Orient to the Mediterranean and Europe, 1000 BC to 1000 AD*, 301-320. Lincoln, Nebraska.



## Listening for *licia*: A Reconsideration of Latin *licia* as Heddle-Leashes

Magdalena Öhrman

The semantic field of Latin *licium* and its plural form *licia* is undoubtedly wide,<sup>1</sup> with the term applied to thread both generally and in specific legal, medical and magical usage as well as in relation to weaving,<sup>2</sup> and this paper does not aim to survey Latin usage of this term comprehensively. Rather, it focuses on one of the uses of *licia* in Latin literary sources, namely those where *licia* appears to denote heddle-leashes.<sup>3</sup> Two much-discussed passages occur in Augustan poetry where *licia* may be used in this sense: Vergil's *Georgics* 1.285 and Tibullus elegy 1.6.79. Both passages have been subject to considerable discussion in the past, and in both cases, ambiguity still remains. In the case of sources from late Antiquity, such as the fifth appendix to Claudian's *Carmina minora* and Isidorus' *Origines* 19.29.7,

there is wider agreement that *licia* is indeed used to describe heddle-leashes, but scholars have hesitated to allow such late evidence influence the interpretation of earlier, poetic passages.<sup>4</sup>

The readings proposed below credit Latin authors with greater technical understanding of weaving than has sometimes been assumed, suggesting that their tacit knowledge of textile production has influenced the artistic presentation of their descriptions of such work in ways hitherto little considered.<sup>5</sup> My readings are heavily influenced by observation of weaving experiments conducted at the Centre for Historical-Archaeological Research and Communication at Lejre by staff from the Centre for Textile Research in Copenhagen and at the Department of Aegean Archaeology in Warsaw, marrying results gained in

1. The work on this paper was made possible by support from the Welsh Strategic Insight Programme (SIP) and the Pasold Research Fund. I am grateful to colleagues at the University of Wales Trinity Saint David (Lampeter) and the Centre for Textile Research (Copenhagen), who have generously offered feedback on earlier drafts, and to colleagues who have enabled me to observe and make sound recordings during ongoing weaving experiments: my thanks especially to Eva Andersson Strand, Ida Demant, Marie-Louise Nosch, Anna Rosa Tricomi, and Agata Ulanowska. I am also much indebted to Gerassimos Bissas for the drawings illustrating technical details.

2. *OLD* s.v. *licium*; *ThLL* s.v. *licium*.

3. This has implicit connections with the interpretation of other passages, where *licium* or related words potentially refer to types of cloth woven with multiple heddle-rods, e.g., Luc. 10.26; Plin. *NH* 8.196. Cf. Walbank 1940, 101-104.

4. Walbank 1940, 97; Wild 1967, 151.

5. The notion of correlation between work processes of textile production, particularly weaving, and literary expression and form has received more attention in relation to Greek texts. Key investigations touching on sound-play, metre and weaving are Nosch 2014; Tuck 2006; Tuck 2009.

experimental archaeology to philological analysis. I will show that analysis of the rhythm and sound-play of the relevant passages suggests that even relatively short passages in literary sources carefully and knowledgeably reflect (parts of) historical working processes; this is, as I will indicate, true of early and late sources alike.

Tibullus' elegies make a particularly obvious starting point for exploring the usefulness of such a methodology, as Tibullus himself explicitly mentions the sounds created by weaving in Tib. 2.1.65-66. There, clay loom weights<sup>6</sup> are said to sing as they clink and clatter during weaving:

*hinc et femineus labor est, hinc pensa  
colusque,  
fusus et adposito pollice uersat opus:  
atque aliqua adsiduae textrix operata  
minervae  
cantat, et a pulso tela sonat latere.*

“Hence [from the countryside] also comes the woman's work, hence the daily allotment of wool and the distaff, and hence the weaver singing as she busies herself with constant craft, and hence it is that the loom sings as the loom weights are struck [together].”

The assumption that Tibullus would seek to mimic such sounds in his own descriptions of weaving is readily made. If we also assume that there is a level of accuracy in such literary mimicking of sounds occurring while weaving, we gain another tool to assist us in determining the passage-specific meaning of a multi-purpose textile term such as *licium*. It is

the purpose of this paper to test the usefulness of this methodological approach. As we might expect literary and stylistic artifice of this type to occur more frequently and in a more pronounced way in poetic texts, my discussion focuses on three passages: the fifth appendix to Claudian's *Carmina Minora*, Vergil's *Georgics*, and Tibullus' elegy 1.6.

### *Heddling and its soundscape*

Interpretations of Verg. *Georg.* 1.285-286 and Tib. 1.6.79 have centred on two different elements of setting up a weave on a warp-weighted loom: affixing warp-threads to the loom frame and heddling, that is, organising already-suspended warp-threads in alternating sequences so that the weaver can change between a natural and at least one artificial shed.<sup>7</sup> A brief consideration of what these work elements involve, and their relative complexity, is necessary before investigating whether one or the other better corresponds to the context and sound-play present in the selected texts.

On the warp-weighted loom (such as explicitly mentioned in Tibullus but likely the type of loom referred to in all three passages under consideration),<sup>8</sup> warp-threads were affixed to the loom frame by means of being interwoven into a starting border (from which the warp-threads emerge), which is sewn onto the cloth-beam of the loom frame.<sup>9</sup> While the preparation of the starting border itself is a multi-step operation requiring both technical skill and experience in calculating how much warp will be required for the desired weave and what density of warp-threads is required,<sup>10</sup> the task of fastening the starting border to the cloth-beam is relatively uncomplicated.

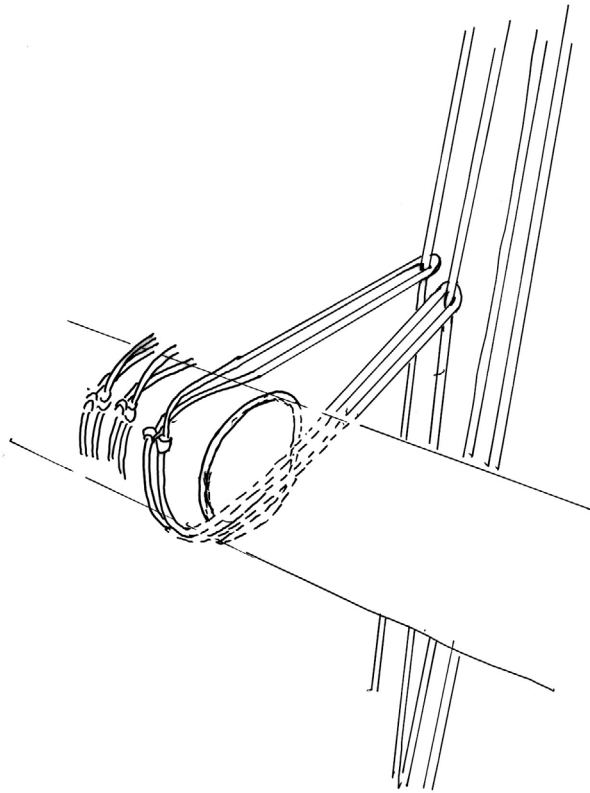
6. On the poetic use of the singular form for plural, cf. Maltby 1999, 246. Maltby also provides a discussion of the use of *later* for 'loom weight'.

7. Walbank 1940; Maltby 1999; Maltby 2002, 278-279.

8. While the use of the two-beam loom is often presumed to spread from the 1st century AD onwards (cf. Ciszuk and Hammarlund 2008, 125; Wild 2009, 471-472, there is archaeological evidence for the continued, parallel use of the warp-weighted loom. On specific locations, e.g., Trinkl 2007; Gostencnik 2014; Gostencnik 2012; Möller-Wiering and Subbert 2012, 168; more generally, cf. Wild 1987, 460-461; Wild 2002, 10-12. Wernsdorff 1785, 494 in effect argues for a two-beam loom in the case of Claud. *Carm. Min. App.* 5, but his description of the role of the *licia* as heddles is equally applicable to the warp-weighted loom, cf. Ciszuk and Hammarlund 2008, 124-125.

9. Ciszuk and Hammarlund 2008, 122; Wild 2009, 471.

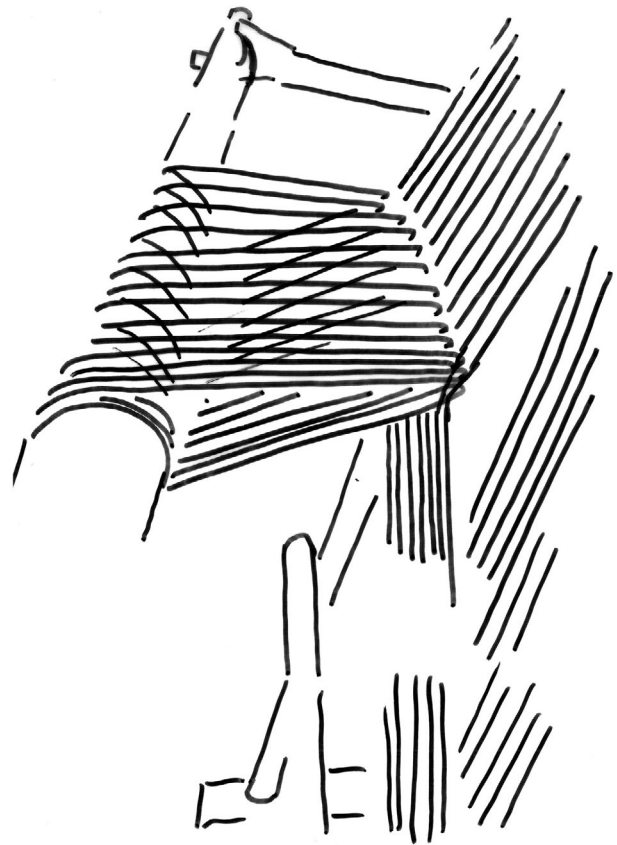
10. On the complexity of preparing the warp and the relation of this element to the selection of suitable loom weights, cf. Mårtensson, Nosch, and Strand 2009, 377-378.



**Figure 1.** Detail of the heddling process: Heddle leashes are looped around individual warp-threads and attached to the heddle-rod. Drawing by Gerassimos Bissas.

Loom weights would, in most cases, be attached to the warp-threads only in a subsequent step, once the starting border was fastened and the warp-threads hanging vertically.

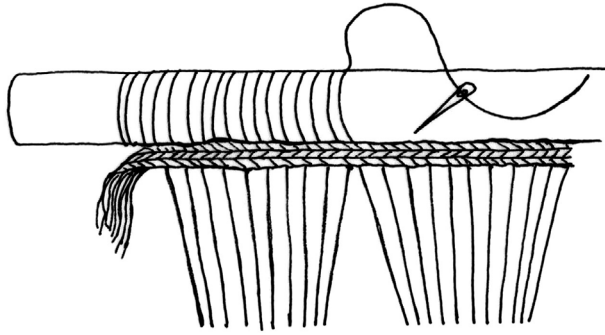
Whether done on a warp-weighted loom or on a vertical two-beam loom, heddling is one of the most difficult elements of preparing a weave. On the warp-weighted loom, it is done with the warp suspended from the cloth-beam and loom weights attached to its bottom end. In a tabby, the warp is divided into two parts, hung either in front of or behind a low-set bar (shed-rod) crossing the loom frame. The opening thus created between front and back layer of warp-threads is the natural shed. A detachable and higher-set heddle-rod is used to create one or more artificial sheds as loops or leashes are made to connect the



**Figure 2.** Detail of weaving on the warp-weighted loom in progress: Heddles attached to the heddle-rod pull warp-threads forward towards the weaver to create the artificial shed opening. Drawing by Gerassimos Bissas.

warp-threads suspended behind the shed-rod, so that these can be pulled forward through the front-most part of the warp, thus creating a new opening between the two parts of the warp. Interestingly, this is the element of preparing and setting up the warp that has the most influence on what type or pattern of weave will be created; more complex weaves, such as diamond twill, require detailed planning and considerable attention in order to achieve the correct sequencing of warp-threads. Even for a tabby weave, some care is needed when separating warp threads and selecting which ones need to be tied to the heddle-rod; any mistakes or imprecisions will be visible as irregularities in the woven cloth.<sup>11</sup>

11. Hoffmann 1964, 163. Cf. Wild 1970, 64. For the impact of the arrangement of heddles in relation to the width of the warp, cf. Mårtensson, Nosch, and Strand 2009, 386.



**Figure 3.** Above, detail of the starting border for a weave on the warp-weighted loom, showing the border sewn onto the cloth beam. Drawing by Annika Jepson. Copy-right CTR.

Two differences relevant to my discussion of individual text passages below emerge: firstly, I argue that heddling is by far the more complex operation and more likely to be experienced as a demanding work element with a risk of errors. Secondly, we may assume a distinct difference in the sound created by these processes: clattering of loom weights would be a regular feature of the heddling process, but only when the starting border is sewn onto the loom..

***Claud. Carm. Min. App. 5.45 (also known as Epithalamium Laurentii)***

The *Epithalamium Laurentii* contains an eight-line long description of the bride's female virtues illustrated through her knowledge of textile work: fibre preparation and spinning (5.41-43) and weaving (5.44-48).<sup>12</sup> The passage is complex both syntactically and through its use of specialised terminology. Much

more could be said about this passage and its use of textile terminology; I will limit myself to comments on 5.45.<sup>13</sup> There is reasonable scholarly consensus that *licium* is used to denote heddle-leashes.<sup>14</sup> Other sources from the same period provide good parallels for this usage.<sup>15</sup>

*compositas tenui suspendis stamine telas,  
quas cum multiplici frenarint licia gressu  
traxeris et digitis cum mollia fila gemellis  
serica Arachneo densentur pectine texta  
subtilisque seges radio stridente resultat.*

“You suspend with fine thread the prepared warp, and when, as the leashes hold it in multiple course, you have pulled the fine thread [through it] with twin fingers, then the silken weave is pressed together with a wool-comb like Arachne's and subtle fruit arises from the whistling rod.”

The use of *freno* (lit. ‘bridle’) to describe the function of the *licia* is highly appropriate given how heddle leashes are looped around individual warp-threads and direct them to move forward or fall back when the heddle-rod is moved. This is similar to how a rider may control the movement of a horse by means of bit, bridle, and reins. The equestrian metaphor is integral to the line: *multiplici gressu*, here describing alternations of the weaving shed and the shift between natural and artificial shed(s), is used elsewhere for types of gait, step or tread.<sup>16</sup> Once the new shed has been opened, the weaver pulls the weft-thread through the warp (*traxeris mollia fila*, 46). This passage,

12. The *Epithalamium Laurentii* is transmitted with Claudian's *Carmina minora* but in all likelihood written by a different author. Dating suggestions range from the 4th to the 6th century AD; the poem appears to have been known and cited in the 7th century AD. Cf. Horstmann 2004, 251-289 with extensive bibliography.

13. Previously, *suspendis compositas telas* has been taken as reference to the fixing of the warp to the cloth-beam (Walbank 1940, 98 n. 1, but cf. also Horstmann 2004, 266 with the rather peculiar translation of “hängst du die entworfenen Gewebe an den zarten Grundfäden (des Webstuhls) [i.e. *stamine tenui*] auf”). I suspect *suspendis compositas telas* could, perhaps, also be seen as referring to the fixing of the heddle leashes to the heddle-rod, as this involves a lifting movement and results in the warp-thread being suspended between their natural position and the heddle-rod, but there is no need to press this interpretation here. Similarly, the distinction between *pecten* and *radius* in 5.46-47 would merit further discussion.

14. Walbank 1940, 97.

15. Serv. *Andr.* 911; Isid. *Orig.* 19.29.7 5. In Ennod. *Carm.* 2.2.8, *licia* is used in a transferred sense which presupposes that the word can be used to describe heddle-leashes.

16. Verg. *Georg.* 3.117; Plin. *NH* 18.298.

therefore, differs from Verg. *Georg.* 1.285-286 and Tib. 1.6.79 (discussed in detail below) in that it does not only describe the setting up of the weave but also includes the weaving itself.

The sound-play of the line I am concerned with here corresponds well to sounds produced when changing the shed.<sup>17</sup> The lifting and replacing of the heddle-rod against the loom frame makes a distinct clattering noise. The movement of the warp generates a clattering of the loom weights, which may be repeated if the weaver needs to touch the warp-threads either by hand or by means of a tool in order to adjust the new opening of the shed. This is mirrored in 5.45 (describing this element of work) by a series of harsh, consonant sounds clustered in two groups, falling in either half of the line: *quās cūm mūltīplīcī frēnārīnt līcīā grēssū* (which, when the leashes hold it in multiple course...). The initial spondee (*quas cum*) illustrates the deliberate clunking noise of the heddle-rod being moved, whereas the dactylic *multiplic(i)* resembles the smaller, clattering sounds of individual loom-weights both in terms of rhythm and in terms of sound. The weaver's pause to test the shed by hand is mirrored in the two spondees taking up the middle of the line (*-īfrēnārīnt*). It is tempting to assume that the r-sounds clustered in this part of the line mimic minute sounds of warp-fibres being pulled apart, with the final dactyl and k-sound of *licia* mirroring the sounds made as the loom weights fall into their proper place.<sup>18</sup>

I argue that in this passage, sound-play, metre, and metaphors contribute to the artistic-literary representation of weaving, adding a perhaps surprising level of accuracy. If one accepts that the author of the epithalamium incorporates the soundscape of weaving into his poetic description, one must also assume that

he had some familiarity with weaving, having seen and heard weavers at work in some setting, whether domestic or commercial. This makes his use of a technical term such as *licium* for 'heddle-leash' all the more plausible.

### *Vergil Georg. 1.285-286*

At the centre of the discussion on whether *licium* denotes heddle leashes in earlier Latin stands Vergil's mention of the setting up of a loom in the first book of the *Georgics* (Verg. *Georg.* 1.285). Just like Hesiod, Vergil mentions the start of a weaving project in the context of a list of days favourable for different activities:

*septima post decimam felix et ponere uitam  
et prensos domitare boues et licia telae  
addere. [...]*

"The seventeenth day is lucky both for setting a vine,  
roping and breaking steers, and for fixing  
the heddle-leashes on a loom."

The three activities mentioned here (planting a vine, breaking in steers, and – as I hope to show – heddling) all represent the start of long-term tasks important to the agricultural economy. Interestingly, the line, which first mentions *licia*, involves an increased emphasis on the challenges associated with the very start of such work: the oxen need to be reined in (*prensos*) before they can be broken in (*domitare*) and subsequently trained to perform their task. It is worth noting that *prensos* derives from *prenso*, the *intensivum* of the more commonly used *prehendo* (seize, take hold of).<sup>19</sup> The choice of an *intensivum* stresses the

17. Though a late and difficult to date text, the use of quantitative verse and high degree of syntactic complexity indicates that the *Epithalamium* has a generally conservative linguistic preference, which may well extend to pronunciation. I therefore tentatively assume a pronunciation of *licium* without palatalization, i.e., with a k- rather than a ts-sound for "ci", although the latter is otherwise frequently attested in (often non-literary) contexts from the 5th century AD onwards, Clackson and Horrocks 2007, 274. Cf. Adams 2011, 273-274 and Clackson and Horrocks 2007, 294-295 on texts continuing to aspire to standardised Latin when writing highly literary texts.

18. Even assuming a pronunciation where palatalization has taken place, the harsher, clunking sounds of *quas* and *cum* remain in the first half of the line, mirrored in the second half by the g- of *gressu*, and correspond to the sound of the movement of heddle-rod and loom-weights subsequently falling back into place. The potential ts-sounds in *multiplici* and *licia* may then be taken, like *frēnarīnt*, to mimic the minute sounds arising when the weaver adjusts warp-threads by hand.

19. *ThLL* s.v. *prenso*.

difficulty of even this initial element. I will explore below whether the phrase *licia telae / addere* may be thought to increase this emphasis, thus creating a climactic tricolon.

In a widely influential article, Walbank argues that Vergil is using *licia* as meaning ‘warp’ in this passage.<sup>20</sup> Walbank’s argument is based on a perceived need to understand *tela* as ‘warp’ in order to accommodate the specific meaning of *licia* as ‘heddle leashes.’ Finding only few parallels for such a use of *tela*, Walbank instead prefers to take *telae* in *Georg.* 1.285 as referring to the loom itself and *licia* as warp-threads.<sup>21</sup> He proposes the following translation of the phrase *licia telae / addere*: “to attach the warp-threads to the loom”.<sup>22</sup>

While I agree that *tela* may refer to the loom rather than the warp, I find Walbank’s reading of *licia* as ‘warp-threads’ problematic for two reasons: first, because there is no absolute need to understand *tela* as warp in order to be able to translate *licia* with ‘heddle-leashes’ here.<sup>23</sup> The well-paralleled use of *tela* as ‘loom’ fits equally well. As I have indicated above, heddle-leashes are looped around the warp-threads but fixed to the heddle-rod before weaving begins. To the weaver, the heddle-rod is an integral – if detachable – part of the loom, without which mechanised weaving is not possible.<sup>24</sup> Furthermore, the heddle-rod may be perceived as an integral part of the loom also because it does not need to be changed or altered as a different weave is mounted, whereas the heddle leashes are tied specifically for each, individual set-up.<sup>25</sup>

The second reason for rejecting the reading suggested by Walbank is that it does not fully take into account the importance of heddlng as an initial,

complex element of setting up a weave. Instead, Walbank’s reading places an unwarranted emphasis of the relatively straight-forward procedure of fastening the warp-threads to the cloth-beam.<sup>26</sup> Here, Walbank appears to overlook that an ancient weaver would use a starting-border to organise the warp on the cloth-beam.<sup>27</sup> This becomes clear as he states that the technical term “*exordiri* (or *ordiri*) signifies to fasten the warp-threads to the loom, that is to attach to the beam at the top of the loom *the separate threads* of the warp [...]” [My italics].<sup>28</sup> Admittedly, handling individual warp-threads in this manner would make the fixing of warp to the loom a more painstaking task (and more suitable to be singled out in literary representation), but it does not correlate with what we do know of ancient weaving practice as far as the warp-weighted loom is concerned.

Such a reading also overlooks the fact that mistakes in the heddlng will have effects throughout the weave. This impact of heddlng on the appearance of the finished piece of cloth makes it all the more likely that one would consider undertaking this task on a beneficial day of the month, in the way that Vergil recommends.

If one accepts that *licia telae / addere* in Verg. *Georg.* 1.285-286 does indeed refer to the preparation of heddle-leashes, it remains to be seen whether sound-play or metre can be used to support such an interpretation in a way similar to what I have argued for in the case of the *Epithalamium Laurentii* (Claud. *Carm. Min. App.* 5.45). Vergil’s reference to weaving is admittedly considerably shorter than the other passages I discuss in this paper and thus leaves less room for such poetic artistry to come to the fore. However,

20. Wild 1967; Mynors 1969; Maltby 1999; Maltby 2002 all build on Walbank’s interpretations.

21. Walbank 1940, 95-96.

22. Walbank 1940, 101.

23. Thomson 1988, 117 does suggest the translation “to put loops on the warp”.

24. The use of the general ‘loom’ (*telae*) would be easily understood as a synecdoche, referring to the whole of the loom instead of specifically to the heddle-rod.

25. Cf. Ciszuk and Hammarlund 2008, 122.

26. Maltby 1999, 243 on Tib. 1.6.79 also appears to overlook the element of heddlng in preparing a weave, stating that “[attaching the warp-threads to the cloth-beam] was the first task of the weaver before beginning the actual weaving process by passing the horizontal weft-threads through them by means of the shuttle.”

27. Cf. e.g., Wild 2009, 471-472.

28. For *exorior* and *exordium* as referring to a starting-border, cf. *ThLL* s.v. *exordium* IA1 and (e.g.) Paul. Fest. p. 185 and Non. p. 30.32.

two points merit attention: first, this passage, too, is rich in consonant sounds: c, t, and d. Secondly, the description of heddling is divided into two parts, taking up the two final, metrical feet of 1.285 and the initial foot of 1.286. *Enjambment*, i.e. the division of a syntactical unit over two or more verses, is by no means uncommon in Vergil, but here, it matches and vocalises the content of the lines concerned in an interesting way. The k-sound of *licia* and the initial t of *tela* in 1.285 might resemble the tinkling of loom weights as the leashes are fastened. As the hexameter line ends, a pause ensues. Then follows the dull thunk created through the d- and r-sounds in *ad-dere*, stressed through the word's initial position. It is tempting to consider this as an auditory representation of the weaver's first shed-change as weaving begins.

### *Tib. 1.6.79*

The final passage to consider is Tib. 1.6.79 and its snap-shot portrait of an elderly, female textile worker. The interpretation of this passage has been significantly influenced by Walbank's analysis of Verg. *Georg.* 1.285f and by his comments on Tibullus' use of *licium* in the sense of warp' in the same article.<sup>29</sup> Having previously rejected the use of *tela* for 'warp',<sup>30</sup> Walbank argues that Tibullus, too, uses it in reference to the loom itself.<sup>31</sup> As in the case of Vergil's passage, however, this does not preclude the use of *licia* for 'heddle-leashes' as these are in fact tied to the loom, albeit to the heddle-rod, one of the loom's detachable parts. I will propose a simpler reading, where *licia* is taken as 'heddle-leashes'.<sup>32</sup> Once more, I draw on analysis of metre and sound-play in the text to support this reading.

In order to deter the narrator's beloved from infidelity, Tib 1.6.77-80 describes the hard work to which a – now penniless and elderly – faithless woman must recourse to support herself. Commentators have viewed the passage as reflecting three steps of cloth production: first, spinning (78), second, weaving (79), and finally, scouring of wool (80).<sup>33</sup>

*at quae fida fuit nulli, post uicta senecta  
ducit inops tremula stamina torta manu  
firmaque conductis adnectit licia telis  
tractaque de niueo uellere ducta putat.*

"But she who was faithful to none, once overcome with age and destitute, draws out the twisted threads with trembling hand, and ties firm leashes to a rented loom, and she scours the teased wool pulled from snow-white fleeces."

In the final line of the warning *exemplum* of the destitute old woman and her weaving, Tibullus keeps two different readings in play. One possible interpretation takes the reader – and the internal addressee, the narrator's beloved – back to viewing the old woman as a warning against infidelity. This reading draws on the non-technological meaning of *puto*, i.e. the far more mainstream 'believe'. By this reading, the line leaves the weaver's expertise behind and focusses on how she believes (*putat*) that the wool that she is working with is drawn and spun from white fleece (*de uellere niueo*). Given that the earlier emphasis on the weaver's old age, the implication is that the old woman's eyesight is failing to such a degree that she can no longer distinguish the colour of the wool she prepares,

29. Walbank 1940, 97-98 and 101. Walbank's reasoning has been followed by Maltby both in his recent commentary on Tibullus (cf. Maltby 2002, 278) and in an earlier article dealing specifically with technical language in Tibullus, Maltby 1999. The *ThLL* also follows Walbank's classification of Verg. *Georg.* 1.285f and Tib. 1.6.79.

30. Walbank 1940, 101 rejects the use of *tela* for warp and *licia* for heddle-leashes in Tib. 1.6.79 specifically.

31. Walbank 1940, 97-98 furthermore understands the participle construction *conductis telis* (Tib. 1.6.79) as a reference to the loom having been assembled and thus ready for the warp to be attached to the cloth-beam. To my mind, it is preferable to understand the phrase as referring to a rented loom (cf. Flower Smith 1964, 322; Maltby 2002, 278, thus connecting to the motif of poverty-stricken old age).

32. This parallels the translation given by Postgate in the 1912 Loeb edition, Cornish, Postgate, and Mackail 1912. Cf. also Thomson 1988, 117.

33. Maltby 2002, 243-244; Flower Smith 1964, 322; Murgatroyd 1980.

thinking it far whiter than it is.<sup>34</sup> At the same time, the text holds out another possible understanding of the final line, drawing on Tibullus' specific use of technical terminology in the previous part of this warning example, which I will now examine in detail.

Throughout, the sound-play of the passage enhances the depiction of craft processes. We are invited to dwell on the trembling grip (*tremula manu*) of the old woman on the spindle by the placement of the ablative *tremulā* just before the *diarexis* in the pentameter line (78). The pause created by the *diarexis* furthermore corresponds to the careful pulling-out of wool from globule or distaff prior to the twisting of the spindle mentioned in the second half of the line. Despite the mention of her hands trembling, the organisation of the second half of the line nonetheless betrays the woman's skill at her work with a pair of quick dactyls (*stāminā tōrtā mānu*). Thus, Tibullus successfully marries the typical design of the pentameter line, which, like here, normally has a dactyl in the penultimate foot, with the working rhythm of the spinner described in this line.<sup>35</sup>

Similarly, it is the skill of the old woman as a weaver that comes to the fore in the following line. On her rented loom, she fastens *licia firma*, i.e., heddle-leashes that are consistent and strong, and will therefore allow her to produce an even weave. Syntactically, *firma* most likely describes the *licia* used, but its initial placement, in parallel to the two previous lines, both opening with their focus on the old woman as the sentence's subject, also allows its connotations to be attached to the woman herself.

The clattering of the loom weights, occurring as the warp-threads distending them are pulled back and forth to be bound by leashes to the heddle-rod, is represented series of k- and kt-sounds spread across the

whole line: *firmaque conductis adnectit licia telis*. The metrical pattern of the line, too, mirrors the working rhythm of someone heddling: a quick reach into the warp for the correct thread is represented by an initial dactyl (*firmaque*), the slower work element of looping the thread used to create leashes around the heddle-rod and the selected warp-thread is described in three spondees filling the middle section of the line (*conductis adnectit*). When the leash is finished and the warp-thread, now held in sequence by the leash, is allowed to fall back and rest in its place, this is illustrated by a dactyl (*licia*) followed by a final spondee (*telis*) at the end of the line.

*fīrmāque conductis | adnectit licīā telis*

As highlighted above, the most specific element of the process, the tying of the leash, is emphasised due to its position immediately following the penthemimeral *caesura*.

In a return to the initial stages of preparing wool for spinning and weaving, the following line deals with scouring wool. Maltby explains this by suggesting that the woman is involved only with preparatory tasks, rather than with completing the weave, in order to show clearly her status as hired help rather than a mistress of her own house.<sup>36</sup> Here, the distribution of content across the line is perhaps more illustrative of working processes than the sound-play used. A key element of cleaning wool would be to pull it gently apart in order to attempt to shake out dirt and plant matter stuck in the fleece, either by hand or by combing.<sup>37</sup> The light-handedness necessary for this procedure may have an expression in the fast pace of the line, which contains the maximum number of dactyls permissible in the pentameter. The text hints at such

34. For the old woman as able to "exert control only over the loom", cf. Lee-Stecum 1998, 202. Throughout the passage, Tibullus taps into elegiac descriptions of old women as hags or witches, horror images of what the elegiac mistress herself might become in old age, when she can no longer rely on her beauty to support her desired lifestyle. The implied loss of eyesight affecting the old weaver is particularly relevant as the elegists frequently connect the *puella*'s ability to attract and manipulate her lover(s) with her eyes and gaze. The importance of eyesight and the gaze as a means of communication between lovers in elegy – or indeed a means for the elegiac beloved to exert control – is programmatically stated in Propertius' first poem: *Cynthia prima suis miserum me cepit ocellis* (Prop. 1.1.1), e.g. Fredrick 2014. Cf. on old women in elegy, James 2003, 53-65, also Richlin 2014, 73-74.

35. The placement of the reference to the twisting of the spindle and thread in the second and fastest half of the pentameter line is paralleled in Tib. 2.1.64. Cf. Maltby 1999, 243.

36. Maltby 1999, 244.

37. Varro *Rust.* 2.2.18 distinguishes between washing of the wool (*lavare*) and cleaning it by hand (*putare*). Cf. also Col. 12.3.6.



a pulling motion by placing the word used for wool (*tracta*) at the opening of the line and the participle agreeing with it in the penultimate position (*ducta*). Through this hyperbaton, the wool is literally pulled apart over the length of the line. Finally, *putat* (she scours) stands at the end of the line, illustrating the completion of the work element.

### Conclusion

Based on the textual interpretations presented above, I argue for taking *licium* in Verg. *Georg.* 1.285 and Tib. 1.6.79 as referring to heddle-leashes used on the warp-weighted loom. I hope to have shown that an understanding of the reconstruction of ancient textile production processes, such as heddling, may contribute to an improved interpretation of Latin textile terminology used as well as a more firmly contextualised appreciation of the passages themselves.

Drawing on results from experimental archaeology, I also argue that the use of sound-play and rhythm may be fully integrated in the stylistic expression of poetic descriptions of textile work.<sup>38</sup> Examination of such features is of course subject to some limitations: our appreciation of the niceties of quantitative poetry is likely to be less finely honed than that of the ancient audience, and, as noted in the discussion of the *Epithalamium Laurentii* above, Latin pronunciation changes substantially over time, at a pace and in a fashion not always easy to pinpoint conclusively.

Given the tendency of Latin towards multi-purpose technical terms, however, I would suggest that such readings may prove fruitful. It appears that, at least in some cases, analysis of such sound-play, in combination with more traditional philological methodologies, can help determine specific usages of multi-purpose textile terms such as *licium*.

### Bibliography

- Adams, J. N. (2011) Late Latin. In J. Clackson (ed.), *A Companion to the Latin Language*, 257-283. Malden.
- Ciszuk, M. & L. Hammarlund (2008) Roman Looms - A Study of Craftmanship and Technology in the Mons Claudianus Project. In C. Alfaro & L. Karali (eds.), *Vestidos, textiles y tintes. Estudios sobre la producción de bienes de consumo en la Antigüedad. Actas del II Symposium Internacional sobre Textiles y Tintes del Mediterráneo en el mundo antiguo (Atenas, 24 al 26 de noviembre, 2005)*, 119-134. *Purpureae vestes 2: Textiles and Dyes in Antiquity*. Valencia.
- Clackson, J. & G. Horrocks (2007) *The Blackwell History of the Latin Language*. Malden.
- Cornish, F. W., J. P. Postgate & J. W. Mackail (eds.) (1912) *Catullus, Tibullus, and Pervigilium Veneris. The Loeb Classical Library*. London.
- Flower Smith, K. (ed.) (1964) *The Elegies of Albius Tibullus*. Darmstadt.
- Fredrick, D. (2014) The Gaze and the Elegiac Imaginary. In B. K. Gold (ed.), *The Blackwell Companion to Roman Love Elegy*, 426-439. Oxford.
- Gostencnik, K. (2012) Austria: Roman Period. In U. Manering & M. Gleba (eds.), *Textiles and Textile Production in Europe. From Prehistory to AD 400*, 65-88. *Ancient Textiles Series 11*. Oxford.
- Gostencnik, K. (2014) Textile production and trade in Roman Noricum. In M. Gleba & J. Pásztoái-Szeőke (eds.), *Making Textiles in pre-Roman and Roman Times: People, Places, Identities*, 60-86. *Ancient Textiles Series 13*. Oxford.
- Hoffmann, M. (1964) *The Warp-Weighted Loom. Studies in the History and Technology of an Ancient Implement*. *Studia Norvegica 14*. Oslo.
- Horstmann, S. (2004) *Das Epithalamium in der lateinischen Literatur der Spätantike*. München.
- James, S. L. (2003) *Learned Girls and Male Persuasion. Gender and Reading in Roman Love Elegy*. Berkley.
- Lee-Stecum, P. (1998) *Powerplay in Tibullus. Reading Elegies Book One*. Cambridge.
- Murgatroyd, P. (ed.) (1980) *Tibullus I. A Commentary on the First Book of the Elegies of Albius Tibullus*. Pietermaritzburg.

38. Interestingly, such artistic integration of sound-mimicking of textile work processes in poetry suggests a surprising tacit understanding of at least some aspects of textile production on the part of Latin poets, something which in turn may contribute to our understanding of the spread and localisation of textile production in Roman society.

- Maltby, R. (1999) Technical Language in Tibullus, *Emerita. Revista de lingüística y filología clásica* 67, 231-249.
- Maltby, R. (ed.) (2002) *Tibullus: Elegies. Text, Introduction and Commentary*. Cambridge.
- Mårtensson, L., M.-L. Nosch & E. Andersson Strand (2009) Shape of Things: Understanding a Loom Weight, *Oxford Journal of Archaeology* 28, 373-398.
- Möller-Wiering, S. & J. Subbert (2012) Germany: Roman Iron Age. In M. Gleba & U. Mannerling, (eds.) *Textiles and Textile Production in Europe: From Prehistory to AD 400*, 153-181. Ancient Textiles Series 11. Oxford.
- Mynors, R. A. B., (ed.), (1969) *Virgil Georgics. Edited with a Commentary by R.A.B. Mynors*. Oxford.
- Nosch, M.-L. (2014) Voicing the Loom: Women, Weaving, and Plotting. In D. Nakassis, J. Gulizio & S. A. James (eds.), *KE-RA-ME-JA. Studies presented to Cynthia W. Shelmerdine*, 91-102. Prehistory monographs 46. Philadelphia.
- Richlin, A. (2014) *Arguments with Silence. Writing the History of Roman Women*. Michigan.
- Thomson, R. (ed.) (1988) *Virgil: Georgics. Volume I: Books I-II. Cambridge Greek and Latin Classics*. Cambridge.
- Trinkl, E. (2007) Artifacts Related to Preparation of Wool and Textile Processing Found Inside the Terrace Houses of Ephesus, Turkey. In C. Gillis & M.-L. Nosch (eds.), *Ancient Textiles: Production, Craft and Society*, 81-86. Ancient Textiles Series 1. Oxford.
- Tuck, A. (2006) Singing the Rug: Patterned Textiles and the Origins of Indo-European Metrical Poetry, *American Journal of Archaeology* 110, 539-550.
- Tuck, A. (2009) Stories at the Loom: Patterned Textiles and the Recitation of Myth in Euripides, *Arethusa* 42, 151-159.
- Walbank, F. W. (1940) *Licia Telae Addere* (Virgil, Georg. 1.284-6), *Classical Quarterly* 34, 93-104.
- Wernsdorff, C. (ed.) (1785) *Poetae Latini Minores*. Altenburg.
- Wild, J. P. (1967) Two technical terms used by Roman tapestry-weavers, *Philologus* 111, 151-155.
- Wild, J. P. (1970) *Textile Manufacture in the Northern Roman Provinces*. Cambridge Classical Studies. Cambridge.
- Wild, J. P. (1987) The Roman Horizontal Loom, *American Journal of Archaeology* 91, 459-471.
- Wild, J. P. (2002) The Textile Industries of Roman Britain, *Britannia* 33, 1-42.
- Wild, J. P. (2009) Textile Production. In J. P. Oleson (ed.), *Oxford Handbook of Engineering and Technology in the Classical World*, 465-482. Oxford.

## Textile Terminology in Old High German between Inherited and Loan Words

Roland Schuhmann

A particular language consists of course not only of words inherited from its respective parent language but contains also a certain amount of loan words (this amount differs of course depending on the respective language). This universal principle then also holds true for the speakers of the Germanic languages. The vocabulary of the Germanic languages includes not only the lexicon inherited from Proto-Indo-European but a range of languages later on heavily influenced it. In the times before the documentation of the Germanic languages, the two most important sources that influenced the Germanic lexicon were Celtic and (prolonged) Latin.<sup>1</sup> Influence in the lexicon is found in nearly every part of the daily life vocabulary, ranging from words for food and beverages via commercial products to Christian

terminology. These borrowings of words in the most cases took place together with the objects or concepts themselves.<sup>2</sup> The research paradigm that investigates these kinds of correlations between words and the underlying objects or concepts is best summarized under the term ‘Wörter und Sachen’.<sup>3</sup>

One of the fields, where (due to *e.g.* new techniques, materials, temporary fashions) a priori a high amount of borrowings of objects (and concepts) is to be expected, is the lexical field of textiles and the terminology used for textile production. A detailed analysis of the vocabulary used for textiles and the technique in the older Germanic languages is largely missing.<sup>4</sup> In the following, a survey of the vocabulary that denotes textiles in the Old High German language will be carried out in order to answer the following questions:

1. It is not the place here to discuss if there was also an influence on the Germanic lexicon by one (or more) unknown substrate language as often is suggested. According to the advocates, about one third of the Germanic lexicon is of non-Indo-European origin and therefore stems from one or more substrate languages (cp. the examples given in Vennemann 2003, 1-7).
2. Exceptions are words like Old High German *koufo* ‘merchant, trader’, Old English *cȳpa*, *cēpa* ‘merchant’, Old Icelandic *kaupi* ‘buyer, customer’, Runic Swedish (personal name) *Kaubi*, Old Swedish (personal name) *Køpe* borrowed from Latin *caupō* ‘publican’ (cp. *EWA* 5, 727). Of course, merchants were known in the Germanic world.
3. Cp. Heller 1998.
4. An exception is the outdated volume three of Heyne 1899-1908. Recently Hofmann 2013 published a study on the Old Frisian textile vocabulary.

- What is the proportion between inherited and borrowed terms for clothes and fabric in Old High German and in which areas are the respective groups mostly concentrated?
- In what time can the highest influence be found and from which origin is this influence?
- In what lexical fields are the loanwords found?
- Can the integration of different loanwords in Old High German be determined?
- Are there examples of several inherited and borrowed words for the same concepts and how do they compete?

### Working steps

In order to answer the aforementioned questions, it was necessary to go through the Old High German dictionaries<sup>5</sup> because specialised lists that comprise the terms denoting textiles (both the underlying material and the final products) do not exist. Since a sufficiently large word group was needed for this investigation, a fairly wide textile concept was applied, including the materials and all objects that could have been made out of them. However, some types of words were not included: Neither verbal expressions for the material production or fabrication were taken in (like *nāen* ‘to sew’), nor were adjectives derived from attested nouns (like *filzīn* ‘felt...’ to *filz* ‘felt’); in contrast, a word like *bissīn* ‘linen’ was integrated in the list because no underlying noun is present. This resulted in a list of in total 511 words denoting textile material and their potential products. Included in this list were thus also products that could have been made out of textile material although that is not in every case clear (like *bīgurtil* ‘purse’ or *būtil* ‘bag, purse’ – they could of course also have been made out of leather or another material). They were taken in because in most cases a deepgoing semantic analysis is not possible for the simple fact that many words are transmitted in glosses, thus without any further Old High German context. To state it clearly, the very detailed semantic analyses found in, e.g., *Althochdeutsches Wörterbuch*

are in fact based less on the information that can be extracted from the Old High German words and their context. Rather they rely more on the analyses of the underlying Latin words they translate. Their inclusion into the list of textile words was even more unproblematic, because in the end they did not seem to change the overall picture.

This unstructured, merely alphabetical list was afterwards sorted according to different aspects that were relevant for this study: inherited versus loanwords, first occurrence of the single words, semantic fields and derivational affiliations.

### Difficulties in determining borrowed words

In this list of 511 words, 154 potential loanwords can be detected, which would result in a proportion of 30.1% of loanwords in the textile terminology of Old High German. However, the exact determination of what is a loanword is not exactly easy. Obviously words like *humerāle* ‘humeral veil’, *kussi* ‘cushion, pillow’, *purpura* ‘purple (robe)’ or *tunihha* ‘tunic, garment’ can without any further problems be classified as loanwords but there are more difficult cases, cp. e.g. the following three examples:

- Old High German *kozso* ‘blanket, dress, skirt, coat, cowl’ has its only counterpart in Old Saxon *kott* (also Latin-Old Saxon *cottus*, *cottis*), seemingly continuing a Proto-Germanic *\*kutta(n)-*. Old French *cot(t)e*, Old Provençal *cota* ‘small garment with sleeves’ are often thought to be borrowed from an unattested Old Dutch *\*kotto* that is assumed to be also the basis of Middle Latin *cottus* ‘cloak, coat’. However, it cannot be ruled out that the Germanic words are borrowed from Middle Latin *cottus* as was also proposed.<sup>6</sup>
- Old High German *līn* ‘linen garment, wick’ has counterparts in all Germanic languages, cp. Runic **lina-**, Gothic *lein*, Old Saxon, Old English *līn*, Old Dutch, Old Frisian *līn-*, Old Icelandic *lín*, continuing Proto-Germanic *\*līna-* ‘wick’. From Germanic the word was apparently already quite

5. For that purpose the following dictionaries were used: Schützeichel 2012; Köbler 1993; Splett 1993.

6. Cp. *EWA* 5, 731-732.

early borrowed into the Finnic languages as *liina*. A comparable form is found in Latin *linum* and Old Irish *lín* ‘flax, wick’. Besides these forms with a long stem vowel also words with a short stem vowel are found having the same meaning: Greek Mycenaean *ri-no-* /*lino-*/, Greek *λίνον*, Old Church Slavonic *\*lǫnъ* (deduced from the adjective *lǫnĕnъ*), Lithuanian *linaĩ*, Latvian *lini* and Old Prussian *lynno*. These words reflect the ablauting forms Proto-Indo-European *\*leyno-* and *\*lino-*. It is sure that the Albanian word *lí* was borrowed from Latin. However, it is unclear whether the Celtic and the Germanic words also represent borrowings from Latin, as it is often assumed based on general historico-cultural reasons. From a purely linguistic point of view, this matter must rest undecided, even more because the cultivation of flax reaches back into the Neolithic.<sup>7</sup>

- c. Old High German *rok* ‘garment, cowl’ has correspondences in Middle Low German, Old Dutch *rok*, Old English *rocc* and Old Frisian *rock* (Old Icelandic *rokkr* was borrowed either from Old English or Middle Low German), all continuing Proto-Germanic *\*rukka-*. Besides this there is an apparently related, however unexplained form Proto-Germanic *\*χrukka-* ‘garment’ that is continued in Old High German *hrok*, Old Saxon *hroc* and Old Frisian *hrock*; this was borrowed into Middle Latin (pl.) *hrocci* that developed into Old French *froc* ‘monk’s habit’. It is generally compared with Old Irish *rucht* ‘tunica’ from Proto-Celtic *\*ructu-* and Middle Welsh *rhuch(en)* ‘coat’ from Proto-Celtic *\*rowkkā*. These could point to a common ancestor Late Proto-Indo-European *\*ruk(k)-*, *\*rowk(k)-*. However, it is often argued that because of the differences *\*r-* and *\*χr-* these are all rather loanwords from an unknown (substrate) source.<sup>8</sup>

If these three examples would turn out to be inherited words and not loanwords, the overall numbers would be decreasing dramatically because of the

derivations of these three words. In this case there would be a total number of one hundred and twenty-one loanwords, so a percentage of 23.7%.

### Inherited vs. borrowed words

This uncertainty in determining what is a loanword and what can be a loanword should be kept in mind when answering the question of the distribution of loanwords through time. For this analysis, the Old High German period was divided into the respective centuries. It should be noted that only the first attestation of a word was taken into account as being relevant. That means that when a word has two or more attestations, only the first one is counted. The others are neglected. This is done for each word, regardless if it is inherited or borrowed. However, every lexicon entry is listed. So, when for example *mantal* occurs for the first time in the 11<sup>th</sup> century and the compound *fēhmantel* ‘coat’ in the 13<sup>th</sup> century, of course both are listed separately.

It is perhaps important to say something about the later centuries mentioned here. It is true that according to the standard view – which is not doubted here – Middle High German displaces Old High German somewhat in the midst of the 11<sup>th</sup> century.<sup>9</sup> Therefore, in fact it would be necessary to stop at that time. However, there is a lot of Old High German or better Old High German like material from later times, namely material consisting out of copies from older material or manuscripts that are assumed to stand in an Old High German tradition.<sup>10</sup> Of course, this means that a part of the later material is overlapping with words also found in Middle High German.

The results of this analysis are displayed in Table 1. Of course, the percentage in the last line must be taken with a pinch of salt. Nevertheless, an increase through the centuries can definitely be detected. This tendency is also confirmed by what is known from Middle High German; here quite an enormous influence from Old and Middle French can be seen.<sup>11</sup>

7. Cp. *EWA* 5, 1299-1302.

8. Cp. Sijts 2010 s.v. *rok* (kledingstuk); <http://www.dwds.de/?view=1&qu=Rock>.

9. Cp. Braune & Reiffenstein 2004, 1.

10. Cp. Stricker 2009.

Table 1.

century	total number of words	(presumably) number of loanwords	percentage of loanwords
< 8th	2	0	0.0%
8th	66	16	24.2%
9th	137	38	27.7%
10th	80	21	27.5%
11th	101	30	29.7%
12th	100	35	35.0%
13th	23	12	52.2%
14th	2	1	50.0%

### Donor language(s) of the loanwords

The question of the donor language or languages on the Old High German textile terminology can be answered quite easily. Only two can be identified: on the one hand Latin (ranging from Classical Latin via Vulgar to Middle Latin), and on the other hand Old French. In the vocabulary for textiles and their products, no Slavonic words can be detected, differing for example from the lexical field of animal skin processing. In this field Old High German *kursin(na)*, *krusina* ‘coat made of pelt’ is found from the end of the 10<sup>th</sup> century (cp. also Old Saxon *kursina*, Middle Low German *körsen[e]*, Middle Dutch *corsene*, Old Frisian *kersne*, Old English *crūs[e]ne*). It was borrowed from Proto-Slavic \**къръно* ‘coat made of pelt’ (continued e.g. in Old Russian *къръно*).<sup>12</sup>

From Classical Latin comes for example the words *līn* ‘linen garment, wick’ (if it is really borrowed from Latin *līnum*), *pfuluwi* ‘pillow’ from *pulvīnus* ‘little cushion, small pillow’ or *pfūmāri* ‘weaver of damask’ from *plūmārius* ‘id.’. From Vulgar Latin words like *oral* ‘cloth’ and *orare* ‘veil’ were derived. The Middle Latin influence is the strongest during the Old High German period. One example may suffice here: the word Old High German *kugulla* ‘hood, cowl’ was borrowed from Middle Latin *cuculla* ‘id.’ In Middle Latin the feminine form nearly completely replaced the older, Classical Latin, masculine form *cucullus*

‘id.’. This replacement can be seen in the Romance languages too, where the masculine form *cucullus* is only continued in Italian *cocollo*, Sardinian *cucudhu*, *cugudhu*<sup>13</sup> and Rumanian *cucuiu*, whereas continuants of the feminine *cuculla* are far more widespread, cp. Italian *cocollo*, French *coule*, Provençal *cogolla*, Spanish *cogulla* and Portuguese *cogula*. The Middle Latin feminine form is also underlying the loans in the other Germanic languages, cp. Old Saxon *kugula*, Middle Dutch *kogele* and Old English *cugele*.<sup>14</sup> The Old French influence on Old High German starts in the 11<sup>th</sup> century and is found in only three loanwords, namely in *bōnit* ‘tiara, diadem’ from Old French *bon(n)et* ‘material for headgears’, in *kussīn* ‘cushion’ borrowed from Old French *co(i)ssin* ‘id.’ and in *zindāl* ‘silk’ coming from Old French *cedal* ‘id.’.

So apparently textile terminology entered the Old High German language area only from the West and perhaps South.

### Semantic fields of the loanwords

The semantic fields of the Old High German loanwords concerning textile terminologies are in some parts well defined:

1. A first group represents specific materials and the products made out of them. It comprises words like *bambas* ‘cotton dress’, *bissīn* ‘linen’, *bokkerat* ‘rough linen’, *bōnit* ‘tiara, diadem’, *?līn* ‘linen garment, wick’, *pfelli* and *pfellōl* ‘garment made of silk’, *pfūmlīh* ‘brocaded’, *polomid* ‘colourful garment made of damask’, *purpura* ‘purple (robe)’, *saban*, *sabano* and *sabo* ‘cloth, linen, linen-cloth’, *serih* ‘silk’, *sīda* ‘silk’, *zindāl* ‘silk’.
2. A second group comes from the special clothes worn by clerics. In this category fall amongst others: *alba* ‘alb, cassock, headband’, *fezitraga* ‘altar-cloth’, *finkūn* ‘monk’s shoes’, *humerāl* and *humerāle* ‘humeral veil’, *kasul* ‘chasuble’, *rāginna* and *rezina* ‘garment of a monk’, *stōla* ‘priestly stole’, *umbrāl* ‘humeral veil’, *zistella* ‘pilgrim’s bag’.

11. Cp. Suolahti 1929.

12. Cp. *EWA* 5, 923-924.

13. The Sardinian words were kindly pointed out to me by Dr. Salvatore Gaspa.

14. Cp. *EWA* 5, 852-853.

3. A third group covers the semantic field of cushions. This group comprises in fact only two words, namely *kussīn* and *pfuluwi*. These two will be treated into more detail below.
4. A last disperse group contains words for all kind sof garments. Cp. e.g. *fāska* and *fāski* ‘wrap’, *kappa/kappa* ‘cap, hat, hood, cloak’, *kelisa* ‘boot, shoe’, *kemis* ‘dress’, *kozza* and *kozso* ‘blanket, dress, skirt, coat, cowl’, *kugula* ‘hood, cowl’, *mantal* ‘coat, wrap’, *menihha* ‘sleeve’, *pfait* ‘jacket’, *rok* ‘garment, cowl’, *rosa* ‘rough coat’, *sok* ‘shoe’, *suftelari* ‘winged shoe’, *tunihha* ‘tunic, garment’, *witta* ‘band’, *zicklāt* ‘round skirt for ladies’.

Finally, some words remain that do not fall into a homogenous category.

### Integration of the loanwords

The question how well loanwords in the lexical field of textiles were integrated in Old High German cannot be answered on the basis of which words prolonged in Middle or even New High German because this procedure would lead to wrong results. Cp. e.g. a case like Old High German *armilo* ‘sleeve, fetter’ that was not a productive word but survived into German.<sup>15</sup> In the following, the adopted approach will rather rely on the productivity in Old High German itself. In other words, the answer to the question of how ‘alive’ loanwords in the language were, is based on derivational patterns and the possibility to be chosen as parts of compounds.

For comparison the group around inherited Old High German *wāt* ‘garment’ can be taken. From *wāt* two derivations do exist, namele *giwāti* and the as a simplex unattested *\*wāti*. Whereas *wāt* itself is only attested as a simplex, the derivation *\*wāti* is attested in three compounds: *bettiwāti*, *dingwāti* and *līnwāti*. The attested simplex *giwāti* is even attested in eight compounds: *beingiwāti*, *bettigiwāti*, *dinggiwāti*, *ingiwāti*, *mūzgiwāti*, *sīdgiwāti*, *wantalgiwāti* and *wībgiwāti*. So all in all, the wordgroup around Old High German *wāt* seems to be quite productive.

Under the loanwords for textiles there are of course several that under this definition were not

integrated at all because they do not take part in derivations and compounding. Examples for them are *alba* ‘alb, cassock, headband’, *amit* ‘shawl’, *balz* ‘belt, baldric’ or *polomid* ‘colourful garment made of damask’.

However, also the complete opposite is found. The two words for ‘cushion, pillow’ can serve as an example for that. In Old High German the words *pfuluwi* ‘pillow’ borrowed from Classical Latin *pulvīnus* ‘little cushion, small pillow’ and *kussīn* ‘cushion’ borrowed from Old French *co(i)ssin* ‘id.’ exist. As is shown by the donor language the time of the borrowing lies far apart from each other.

The word *pfuluwi* is attested in the 8<sup>th</sup> century and shows in Old High German three different derivations: *pfuluwīn* attested in the 9<sup>th</sup> century, *pfuluwīlīn* in the 10<sup>th</sup> century and *pfuluwo* in the 12<sup>th</sup> century (all three with the meaning ‘pillow’). So during the whole Old High German period it is possible to create new derivations to *pfuluwi*. The word *pfuluwi* is also found in the compound *houbitpfuluwi* ‘pillow’ in the 9<sup>th</sup> century. The later derivation *pfuluwīn* is present in the compounds *houbitpfuluwīn* ‘pillow’ in the 10<sup>th</sup> century and *stuolpfuluwīn* ‘stool pillow’ in the 11<sup>th</sup> century.

Therefore, it is clear that the word group around *pfuluwi* was quite well integrated in the Old High German language. The rate of productivity is not that high but it is in fact constant.

Even if *pfuluwi* seems to have been quite well integrated in Old High German this is even more the case with the later borrowed *kussīn* ‘cushion’. The word was adopted on the turn of 10<sup>th</sup> to the 11<sup>th</sup> century and is first attested in the compound *wangkussīn* ‘pillow’. In the 11<sup>th</sup> century it becomes very productive. There are two derivations: *kussi* ‘cushion’ and the diminutive *kussilī/kussilīn* ‘small cushion’. The word appears also in two further compounds, *houbitkussīn* and *wangkussilīn* ‘pillow’. In the 12<sup>th</sup> century two further compounds are found, namely *ōrkussilīn* ‘little pillow’ and *ōrkussīn* ‘pillow’ showing that the derivation was still in use.

So the integratedness of *kussīn* ‘cushion’ seems to have passed off much more quickly than it was the case with *pfuluwi* ‘cushion’. This may have

15. Cp. *EWA* 1, 338.

been the reason why the latter one was replaced by *kussīn* ‘cushion’ later on in the history of the German language.

### Inherited and borrowed words denoting the same concept

To round up this short overview on textile terminologies a look may be taken at some cases where in Old High German both inherited and borrowed words are transmitted for the same concept:

- a. ‘belt’: There are some inherited words denoting belts: *bruohhah*, *fazilo*, *gurt* (together with the derivations *gurtil*, *gurtila* and *gurtilīn*; also widespread in compounds), *umbisweif* and *windica*. In the 10<sup>th</sup> century the word *balz* ‘belt, baldric’ appears that is borrowed from Latin *balteus* ‘belt, girdle’.<sup>16</sup> This word is not attested in derivations or compounds, was in other words not integrated in Old High German. It disappeared in the further history of German where the already in Old High German most widespread word *gurtil* asserted itself.<sup>17</sup> The situation is opposite to the one in English, where *belt* is nowadays the most common word while *girdle* was driven back.
- b. ‘coat’: The semantic field of ‘coat’ is already in Old High German beginning to be dominated by borrowed words. Inherited words are *hulla*, *lahhan*, *ludilo*, *skekko* and *trembil*. Of these, *hulla* is used for every kind of wrap, *lahhan* is used to denote every kind of floating garment and *ludilo* refers in fact to the material the coat is made of, so only *skekko* and *trembil* truly denote coats. Only *lahhan* is productive in the sense mentioned above. The borrowed words are *kozza/kozso*, *mantal*, *rok* and *rosa*. Of these four, the first three are very productive in Old High German, both in derivations and compounds. It does in fact not astonish that of these nine words only the productive ones are continued in later

language stages. However, *lahhan* stopped to be used as a word that could designate coats, which is not astonishing because more apt words were available. *Kozza/kozso*, *mantal* and *rok* continued to be existent in later language stages. Of these, only *mantal* is the word for ‘coat’ in the standard language, whereas *kozza/kozso* and *rok* are used dialectally.

- c. ‘sleeve’: In Old High German there is one inherited word for the sleeve, namely *armilo* that has no productivity whatsoever. There are also two borrowed words, *menihha* and *menihhilo* that come from Latin *manica* and probably *manicula* ‘sleeve’. The unproductive *armilo* could only hold up well because the connection with the derivational basis *arm* ‘arm’ was at no time lost. Against this connection the loanwords stood no chance.
- d. ‘hair-lace’: One of the most surprising semantic wordgroups in Old High German is that for the hair-lace. There are quite many inherited words to denote this object: Besides the simplex *rīsil*, that is more commonly used in the meaning ‘veil’, compounds are found, which have as first member either *fahs* or *hār* ‘hair’: With *fahs* the compounds *fahsreidī*, *fahsreita*, *fahsreitī*, *fahssnuor*, *fahswalko* and *fahswinta* are found, with *hār* the words *hārskeida* and *hārsnuor*. There is also one compound found that has a borrowed element in it, namely *fahswitta* with *witta* ‘band’ from Latin *vitta* ‘band, ribbon’. The borrowed word did not stand a chance – perhaps not so much, because *-witta* did not make it, but rather because *fahs* got out of use.<sup>18</sup> For ‘hair’ only Old High German *hār* was continued<sup>19</sup> but also these compounds came into disuse (German *\*Haarschnur* would perhaps still be understandable). German *Haarband* replaced these words, although interestingly no corresponding compound with *-band* is found in Old High German.

16. Cp. *EWA* 1, 447-449.

17. Cp. *EWA* 4, 705-706.

18. Cp. *EWA* 3, 15-17.

19. Cp. *EWA* 4, 826-828.



## Conclusion

This short overview of textile terminologies showed that quite a large amount of the Old High German words in this lexical field is borrowed. The borrowings only come from the West (or South) into Old High German, so from Latin and its continuant Old French. Between the 8<sup>th</sup> and 12<sup>th</sup> century there is a gradually rising amount of loanwords. Three semantic fields can clearly be distinguished, namely special, unknown materials and their products, garments for clerics and cushions. The integration of the loanwords reaches from 'not at all' to 'very good'. Although integration is an important element for the continuing use of borrowed words, it is definitively not the only reason.

It is obvious that this study here is only a first small step towards a detailed analysis of the textile terminology in Old High German. The latter must not only deepen the type of analysis presented here but also include a semantic study of the words used as well as the verbs and all derivations. In a second step, the historical and archaeological evidence should be subjoined.

## Abbreviations

*Althochdeutsches Wörterbuch* = Karg-Gasterstädt, E. & Th. Frings *et al.* (eds.) (1959ff.), *Althochdeutsches Wörterbuch*, Bd. 1 ff. Berlin.  
*EWA* = Lloyd, A., O. Springer & R. Lühr (eds.) (1988ff.), *Etymologisches Wörterbuch des Althochdeutschen*, Bd. 1 ff. Göttingen.

## Bibliography

*Althochdeutsches Wörterbuch* = *Althochdeutsches Wörterbuch* (1959ff.). Karg-Gasterstädt, E. & Th. Frings *et al.* (eds.). Bd. 1 ff. Berlin.

- Braune, W. & Reiffenstein, I. (2004) *Althochdeutsche Grammatik I. Laut- und Formenlehre*. 15. Aufl. Tübingen.
- Heller, D. (1998) *Wörter und Sachen. Grundlagen einer Historiographie der Fachsprachenforschung*. Tübingen.
- Hofmann, G. (2013) Herstellung und Gebrauch von Kleidung und anderen Textilien im alten Friesland, *Us Wurk* 62, 87-160.
- Heyne, M. (1899-1908) *Fünf Bücher deutscher Hausaltertümer von den ältesten geschichtlichen Zeiten bis zum 16. Jahrhundert. Ein Lehrbuch*. 1. Bd.: *Wohnung*. 2. Bd.: *Das deutsche Nahrungswesen von den ältesten geschichtlichen Zeiten bis zum 16. Jahrhundert*. 3. Bd.: *Körperpflege und Kleidung*. 4. Bd.: *Das altdeutsche Handwerk*. Aus dem Nachlaß. Leipzig (Nachdruck: 1985. Meerbusch bei Düsseldorf).
- Köbler, G. (1993) *Wörterbuch des althochdeutschen Sprachschatzes*. Paderborn [u.a.].
- Schützeichel, R. (2012) *Althochdeutsches Wörterbuch*. 7., durchges. und verb. Aufl. Berlin [u.a.].
- Sijs, N. van der (samensteller) (2010), Etymologiebank, op <http://etymologiebank.nl/>.
- Splett, J. (1993) *Althochdeutsches Wörterbuch. Analyse der Wortfamilienstrukturen des Althochdeutschen, zugleich Grundlegung einer zukünftigen Strukturgeschichte des deutschen Wortschatzes*. Bd. 1 und 2. Berlin.
- Stricker, St. (2009) Die Abgrenzungsproblematik Althochdeutsch – Mittelhochdeutsch. In Bergmann, R. & St. Stricker (eds.), *Die althochdeutsche und altsächsische Glossographie. Ein Handbuch*, Bd. 2, 1574-1600. Berlin.
- Suolahti, H. (1929) *Der französische Einfluss auf die deutsche Sprache im dreizehnten Jahrhundert*. Helsingfors [u.a.].
- Vennemann gen. Nierfeld, Th. (2003) *Europa Vasconica – Europa Semitica*. Aziz Hanna, P. N. (ed.), *Trends in Linguistics. Studies and Monographs* 138. Berlin-New York.

## Χιτών – δαλματική – μαφόρτης – σύνθεσις: Common and Uncommon Garment Terms in Dowry Arrangements from Roman Egypt

Kerstin Droß-Krüpe

With regard to ancient textile terms, dictionaries could potentially generate a false sense of security. Their formal accuracy might let us think that we are, without doubt, provided with the term that corresponds perfectly with a particular expression from an ancient Greek and/or Latin document. However, translations in dictionaries are almost exclusively based on reading and interpreting ancient literary sources and tend to neglect documentary evidence. But documentary sources, such as papyri, are a valuable and unique resource for research, referring to manifold aspects of social and economic history. Above all, they offer an insight into the minutiae of individual lives, an aspect of ancient history that is rarely available to current research. These kinds of sources significantly deepen the understanding of the ancient world – compared to information retrieved only from literary sources.

The present contribution derives from a research project made possible by the Pasold Research Fund.<sup>1</sup> It focuses on ancient marriage documents from the province of Egypt with its abundance of papyrological evidence as a case study on the terminology of everyday dress in Roman Imperial times.

### **Source material: Dowry contracts from Roman Egypt**

Before paper and parchment were common writing materials, people used wooden tablets, papyri or potsherds (ostraca) for private correspondence as well as for official documents. Especially the abundance of papyri and ostraca broadens our perspective on antiquity from literary sources. Mainly originating from Egypt, these documents provide a direct and unfiltered view of real life circumstances for

1. ‘Everyday dress in Graeco-Roman Egypt (1st-6th century AD) according to papyri – an analysis of dowry contracts’ (carried out with Yvonne Wagner/Salzburg). I am very grateful to the Pasold Research Fund for enabling our research. I also wish to thank the conference organisers, Marie-Louise Nosch, Cécile Michel and Salvatore Gaspa, for their invitation, and the participants for providing a very stimulating climate of debate. I am indebted to Andrea Jördens/Heidelberg and Deborah Weisselberg-Cassuto/Ramat Gan for valuable comments on linguistic details of this paper and to Virginia Geisel/Marburg and Jane Parsons-Sauer/Kassel for correcting my English. All papyrological editions as well as corresponding literature for papyri, ostraca and tablets are listed in the ‘Checklist of Editions’ (5th edition) which is available online: [http://library.duke.edu/rubenstein/scriptorium/papyrus/texts/clist\\_papyri.html](http://library.duke.edu/rubenstein/scriptorium/papyrus/texts/clist_papyri.html) (last accessed December 2014).

all classes of population in this region.<sup>2</sup> After Alexander III ('the Great') had conquered Egypt and introduced the Greek language in this part of the Mediterranean in 332 BC, it was used for official documents. Until the Arab invasion in 640-642 AD, the Greek language also played an important role in private correspondence. Thus most papyri and ostraca were written in Greek. The majority of Greek papyri and ostraca date back to the first three centuries AD, when Egypt was a province of the Roman Empire. They consist of a variety of documents – works of literature, letters, horoscopes, accounts, receipts, tax registers, declarations, contracts, and more. Making the individual tangible, they let us explore an 'individual micro-history' and bring administrative trading records to life. Their evidence provides an unfiltered view of real-life circumstances of all population classes. With regard to the economic procedures of Roman textile production, they allow for a more detailed analysis.

Marriage and dowry arrangements are of particular value for research on female dress of the Roman period. "One of the main purposes for the composition of a marriage document was to record the delivery of a dowry, its value and contents, and to regulate its position both in the course of the marriage and after its dissolution."<sup>3</sup> The detailed description of every item of the dowry was very important because, in case of divorce, it enabled the woman to enforce her right of regaining this dowry within a short time. However, some contracts record the overall value of the dowry rather than its original components. In these cases, which mostly date back to Augustean times, the husband could possibly dispose of dowry components without any special restraints as long as he was still capable of returning the total value.

However, in later marriage documents the components are usually listed in great detail. A typical

dowry from the first three centuries AD in Roman Egypt usually includes clothing, along with cash instalments, jewellery and household implements. The typically high level of detail offers a unique chance to learn about women's garments which were actually worn in everyday life in this part of the Roman Empire. We can discover details about the terminology of female garments, their colours and sometimes even the value of an actual garment.

It is necessary to keep in mind that marriage was important and common in ancient times. Analysing census declarations, Roger Bagnall and Bruce Frier could prove that in Roman Egypt at least 93% of the women aged between 26 and 35 years were married, already divorced, or widowed.<sup>4</sup> Thus marriage was a very common phenomenon in Imperial Egypt. Nevertheless it must be borne in mind that, although dowries were common, dowry contracts were not obligatory. Especially in earlier times, this written form of arrangement was often composed without any official supervision by a public organ. The contract served to create security for bride and groom in the – not unlikely – case of a later divorce and to secure the women's financial resources, but for a valid marriage arrangement, the dowry contract was not by all means necessary.<sup>5</sup>

Because the contracts come from varied socio-economic backgrounds, the overall value of documented dowries varies a lot – which is not surprising, considering the high percentage of married women. The type and number of items often indicate the socio-economic status of the bride's family. By analysing the garments these women possessed and wore in everyday life we are able to explore the links between clothing and wealth, fashion and status – not just of upper class women but of brides from very different social strata of the multicultural society in the Roman province of Egypt.

2. Challenging the paradigm of Egypt as a special region of the Roman Empire, which circumstances are contrary to all other regions, consequently encourages the study of the available documents of this province. This backdrop moves the significance of papyri into the focus of ancient economic history research.

3. Yiftach-Firanko 2003, 105.

4. Bagnall & Frier 1994, 117.

5. For a general introduction in this source material see Yiftach-Firanko 2003.

### Textiles in Roman dowries

Of the approx. 100 surviving (and edited) dowries dating back to Roman Imperial Times, 46 mention textiles.<sup>6</sup> This shows the importance of textiles as part of a woman's belongings and highlights the connection between garments, gender, and social status. In contrast to mummy portraits, painted shrouds, statues, reliefs or archaeological textiles obtained from graves, the dowries represent a portrait of actual life. It rather depicts the way a woman was seen on the street than how she wanted to be remembered after her death. Idealisation is insignificant for this kind of source material: we are not facing the ideal concept of a local elite, but everyday dress of women from very different social strata.

This is of particular importance for analysing the terminology used for the garments in dowries. The documented name for an individual garment was the name which was actually given to this very garment by its female wearer, the adjectives used to describe its colour correspond with the woman's own colour impressions. The combination of name and colour enabled her to identify that very garment in case of divorce. This explains quite well why we are rarely facing general terms like "female garments" (ἱμάτια / ἱμάτια γυναικεῖα) but usually detailed descriptions.

### Common garments

A closer inspection of dowries and their garment terms suggests that women in Graeco-Roman Egypt did not possess a very broad range of garments. 11 different types of garments appear in the entirety of all dowries from Imperial times. A χιτών (or tunic) is listed in a vast number of dowries. Its colours are manifold and range from purple, mulberry red,

sandalwood red, chrysanth yellow, sulphur yellow, safflower yellow to milk white and white, but interestingly never any shades of blue or green. Another very common garment, the πάλλιον is most often said to be χρωματισμός, colourful, without giving any details about individual colours. These mantles could have had several colours, probably in patterns. Striped and checked textiles are indeed documented in the archaeological records.<sup>7</sup> Although we often cannot reconstruct the design of a certain garment, these textile fragments may represent mantles. In summary: χιτών and πάλλιον are to be considered the most common female dresses to be found in almost each and every wardrobe in all parts of Egypt during the entire Imperial period. Obviously, these terms were part of a widespread 'standard dress terminology' of that time.

Besides these two very common and clearly defined garments we are presented with others, for example the στολή: This type of garment appears exclusively in dowries dating to the 1st and 2nd century AD and seems to be uncommon during later times.<sup>8</sup> The σουβρικοπάλλιον is very likely a typo for σουρικοπάλλιον, a Syrian πάλλιον.<sup>9</sup> It does not appear in the early marriage documents, but from the 2nd century onwards. We also learn about garments called δαλματική and μαφόρτης / μαφόριον. These two terms are particularly interesting as they are listed individually and combined, most likely meaning an entire female costume. They only appear in dowries dating from the late 2nd and the 3rd century AD.

### δαλματική and μαφόρτης / μαφόριον

Handbooks and dictionaries offer descriptions and definitions for garments. Whereas the most common dictionary of ancient Greek, Liddell-Scott-Jones, calls the δαλματική just a "robe" without any further

6. Droß-Krüpe & Wagner 2014, 163-166.

7. E.g. Grömer 2010, 166-168, cf. Diod. 5,30,1; Droß-Krüpe 2015.

8. P. Mich. 2/121r, 42 AD, Tebtynis; P.Mich 5/343, before 54 AD, Tebtynis; P.Ryl. 2/154, 66 AD, Bakchias; P.Oxy. 2/265, 81-96 AD, Oxyrhynchos; Pap. Choix. 10, 162 AD, Tebtynis; P.Strasb. 4/225, 2nd half 2nd cent. AD, place unknown; P. Tebt. 2/514, 2nd cent. AD, Tebtynis.

9. CPR 1/27, 158 AD, place unknown; P.Oxy. 6/905, 170 AD, Oxyrhynchos; SPP 20/41v, 2nd cent. AD, Hermopolite nome?; CPR 1/21, 230 AD, Ptolemais Euergetis; P. Tebt. 2/405, 3rd cent. AD, Tebtynis.

specification,<sup>10</sup> we are informed elsewhere that a *dalmatic* / δαλματική is “[a] T-shaped tunic with wrist-length tight sleeves cut separately from the main part of the tunic and sewn on, popular in the later Roman Empire, especially the 3rd and 4th centuries AD. Originating in the Illyrian provinces or further east, it was worn by men and women: men’s versions could have coloured and patterned bands and roundels – especially on the shoulders; women’s – shown on many female figures in catacomb paintings – were longer (just above the ankles), worn unbelted and often had contrasting stripes and borders.”<sup>11</sup> A deeper insight into the source material for this precise assumption shows that the most detailed description can be found in an etymological encyclopaedia compiled by the Christian bishop Isidore of Seville in the 7th century AD. It says that a δαλματική / *dalmatic* is a bright white tunic for priests with a purple border (*clavus*).<sup>12</sup> According to the *Liber Pontificalis*, the dalmatic was introduced as a priest’s garment by Pope Silvester in the 4th century AD.<sup>13</sup> We also learn that its use attracted attention, for example when worn by Roman Emperors such as Commodus and Heliogabalus during the high Empire.<sup>14</sup> However this information derives from the *Historia Augusta*, is a late Roman collection of biographies of Roman Emperors – a source in which fictional or inaccurate information is deliberately combined with historical material and which is therefore considered unreliable. The same *Historia Augusta* characterises the above-named emperors, allegedly wearing a dalmatic, as effeminate, extravagant

and generally inappropriate rulers. Every other detail regarding this type of garment is either assumed from considerably later Christian sources or is based on the iconographic record. The question remains: If the appearance of the garment named δαλματική has not changed at all over the centuries – are we really in a position to identify a visual representation of a dalmatic or δαλματική, if the only definite information we have is the one mentioned by Isidore and the *Historia Augusta*? This is highly questionable.

In the dowries, this type of garment is mentioned five times in three arrangements, all dating from Dura Europos in Syria or the Arsinoite nome in the 3rd century AD.<sup>15</sup> When specified, its colour is κόκκινος (scarlett), λευκός (white) or σαπιρίνη (l. σαπφείρινος [sapphire]).

As a second example a *mafortium* / μαφόρτης is presented in the dictionaries to be a “veil, head-dress of women and priests”.<sup>16</sup> Elsewhere it is described as “[a] short palla, worn by women, found in later Latin sources”.<sup>17</sup> Again, it is interesting to note the discrepancies in the definitions that indicate a semantic change of the term.<sup>18</sup> It is of semitic origin, most likely deriving from the Hebrew תרופעה (*ma’aforet*), meaning *vestis lintea* or *mantum*. It is mentioned as both a female garment<sup>19</sup> and an element of a male priest’s dress<sup>20</sup>. Considering this, we ought to admit that we do not know what these garments actually looked like. We maintain an illusion of knowledge without questioning these persistent and self-amplifying definitions.

10. LSJ, s.v., 368.

11. Cleland *et al.* 2007, 46. Cf. also Schrenk 2012, 197-200. See also Mossakowska in this volume.

12. Isid. *orig.* 19,22,9: *Dalmatica vestis primum in Dalmatia, provincia Graeciae, texta est, tunica sacerdotalis candida cum clavis ex purpura.*

13. *Lib. Pont.* 34,7: [*Silvester*] *constituit ut diacones dalmaticas in ecclesia uterentur et pallae linostema leva eorum tenerentur.* Until today the dalmatic is the outer liturgical vestment of the deacon.

14. *HA Comm.* 8; *HA Pertinax* 8 (again referring to Commodus’ garments); *HA Heliog.* 26.

15. CPR 1/21 [= SPP 20/31], 230 AD, Ptolemais Euergetis; P.Dura 30, 232 AD, Dura Europos; P.Tebt. 2/405, 3rd cent. AD, Tebtynis.

16. LSJ, s.v., 1085.

17. Cleland *et al.* 2007, 119.

18. Its etymology is discussed in detail in Mossakowska 1996, 27-28.

19. Isid. *orig.* 19,25,4 and *Non.* p. 542,1.

20. Cassianus, *de institutis coenobiorum* 1,7.

This type of female dress appears in four imperial dowry contracts – one of them mentions two garments of that kind.<sup>21</sup> Its colour is usually described as πορφύρεος (purple; twice), σαπιρίνη (l. σαπφείρινος [sapphire]) and κόκκινος (scarlet).<sup>22</sup>

Three of the dowries containing a δαλματική also list a μαφόρτης. According to P.Dura 30, originating from the vicinity of Dura Europos in Syria and dating to the 3rd century AD, Aurelia Marcellina's dowry contained a combination of a δελματικὴν κ[οκκινὸν] and a μ[α]φόριν πορφυροῦν, thus a scarlet *dalmatic* and a purple *mafortium*. We can clearly detect that both garments were considered as an ensemble, as they are connected by the use of the word καί (and) and share a common value. P.Tebt. 2/405 lists a purple and a scarlet μαφόρτης as well as a sapphire δαλματική. Other dowries, such as P.Oxy. 10/1273 from the 3rd century AD, even join both terms into a new phrase which represents the ensemble: δελματικομαφόρτης. This dowry also contains, among other items, a silver δελματικομαφόρτης (besides, the most valuable garment documented in all marriage contracts [260 drachmai]), a turquoise δελματικομαφόρτης as well as a white and a purple δελματικομαφόρτης.

The fact that μαφόρτης and δαλματική form a compound word suggests that these garments were usually two parts of an entire female costume. The term also appears in the Price Edict of Emperor Diocletian, dating from the early 4th century AD.<sup>23</sup> This type of costume is most likely of eastern origin, as the Price

Edict only lists production sites in the Eastern provinces of the Roman Empire, a fact which is supported by its appearance in Egyptian and Syrian papyri.

The fact that the term σύνθεσις appears in several dowries,<sup>24</sup> but never concurrently with μαφόρτης or δαλματική, might lead to the assumption that it represents the very same ensemble of garments.<sup>25</sup> According to LSJ, σύνθεσις means “putting together, combination; combination of parts so as to form a whole; set (e.g. collection of clothes)”.<sup>26</sup> Other textile dictionaries define a σύνθεσις as a dinner robe for men and a religious dress for (male) priests,<sup>27</sup> a concept which derives from Roman literary sources like Suetonius and Martial. A closer look into these sources reveals that a σύνθεσις was apparently worn during dinner (which does not define it as a dinner dress per se) and was not regarded as appropriate for a Roman emperor in public<sup>28</sup> (possibly because the garment, or rather combination of garments, could also be worn by women.<sup>29</sup>). On the other hand, according to Martial, the σύνθεσις seemed to be an attribute of Roman elites such as senators and knights (*equites*)<sup>30</sup> as well as priests<sup>31</sup>. Here the σύνθεσις is described as a decent and probably rather luxurious garment.

Overall, based on these contradictory statements from sources with little reliability, we cannot get a clear picture as to how a certain dress actually looked like. The question is: Was there a common understanding for a certain type of garment at all, or were some literary sources simply not interested in precisely specifying the textile terms? In any case,

21. CPR 1/21 [= SPP 20/31], 230 AD, Ptolemais Euergetis; P.Hamb. 3/220, 223/4 AD, Ptolemais Euergetis?; P.Dura 30, 232 AD, Dura Europos; P. Tebt. 2/405, 3rd cent. AD, Tebtynis.

22. For further evidence of this term cf. Mossakowska 1996, 27-37.

23. *Ed. Diocl.* 19.

24. P.Oxy. 3/496, 127 AD, Oxyrhynchos; PSI 10/1117, after 138 AD, Tebtynis; SB 5/7535, 198/9 AD, Ptolemais Euergetis; SB 6/9372, 2nd half 2nd cent. AD, Oxyrhynchos; SPP 20/41, 2nd cent. AD, Hermopolite nome?.

25. P.Oxy. 3/496, 127 AD, Oxyrhynchos; PSI 10/1117, after 138 AD, Tebtynis; SB 5/7535, 198/9 AD, Ptolemais Euergetis; SB 6/9372, 2nd half 2nd cent. AD, Oxyrhynchos; SPP 20/41, 2nd cent. AD, Hermopolite nome?.

26. LSJ, s.v., 1716.

27. Cleland *et al.* 2007, 185.

28. Suet. *Nero* 51.

29. *Dig.* 34,2,38,1.

30. *Mart.* 14,1.

31. *Mart.* 5,79.

although documentary sources provide valuable details like names, colours and value of individual garments, acquiring an impression of their common design still proves to be difficult.

### Conclusion

Roman marriage documents from Imperial Egypt provide a unique possibility to detect the characteristics of clothes within social reality — as they were actually worn. They enable us to learn about textile tastes and visualize the wardrobes of women in their time. They provide detailed descriptions as to design and colours and give insights into the everyday life of women. Thus, these documentary sources significantly broaden the perspective presented by literary sources or the iconographic record. Combined with the values of textiles which is often additionally provided, we get a better understanding of the taste of Roman women — at least in the parts of the Roman Empire that provide us with papyrological evidence. Their analysis gives insight into the commonness of garments and their owner's taste in colour. The dominance of reddish and yellowish shades is overwhelming. A garment which is described as 'colourful' (especially in the case of tunics) might be interpreted as 'patterned' — or maybe in some cases being at taqueté decoration or tapestry weave.<sup>32</sup> δαλματική and μαφόρτης appear independently from one another or together, are connected with καί, or form a joint term which describes a complete female costume. It is conceivable that the term σύνθεσις which — at least in the dowries — occurs rarely, but never together with either δαλματική or μαφόρτης, was probably used as a synonym for this costume.

### List of abbreviations

LSJ = Liddel, H. G. & Scott, R. (1940), *A Greek-English Lexicon*. Revised and augmented throughout by Sir H.S. Jones. Oxford.

### Bibliography

- Bagnall, R. S. & Frier, B. W. (1994) *The Demography of Roman Egypt*, Cambridge.
- Cleland, L. et al. (2007) *Greek and Roman Dress from A to Z*, London.
- Droß-Krüpe, K. (2015) Textile Tools in Papyri From Imperial Egypt. In C. Fluck & A. de Moor & P. Linscheid (eds.), *Textiles, Tools and Techniques of the 1st Millennium AD from Egypt and Neighbouring Countries. Proceedings of the 8th Textiles from the Nile Valley Conference, Antwerp, October 2013*. 147-149. Tiel.
- Droß-Krüpe, K. & Wagner, Y. (2014) Kleidung als Mitgift im kaiserzeitlichen Ägypten. Eine Bestandsaufnahme, *Marburger Beiträge zu antiken Wirtschafts-, Handels- und Sozialgeschichte (MBAH)* 31, 153-173.
- Grömer, K. (2010) *Prähistorische Textilkunst in Mitteleuropa. Geschichte des Handwerkes und der Kleidung vor den Römern*, Wien.
- Mossakowska, M. (1996) ΜΑΦΟΡΙΟΝ dans l'habit monastique en Égypte. In *Aspects de l'artisanat du textile dans le Monde Méditerranéen (Égypte, Grèce, monde Romain)*. 27-37. Lyon.
- Schrenk, S. (2012) Die Dalmatika zwischen funärer Selbstdarstellung und kirchlichem Ornat. In S. Schrenk et al. (eds.), *Kleidung und Identität in religiösen Kontexten der römischen Kaiserzeit*, 196-218. Mannheimer Geschichtsblätter Sonderveröffentlichung 4. Regensburg.
- Yiftach-Firanko, U. (2003) *Marriage and Marital Arrangements. A History of the Greek Marriage Document in Egypt. 4th century BCE-4th century CE*. Münchener Beiträge zur Papyrusforschung und antiken Rechtsgeschichte, 93. München.

32. Cf. Wild & Droß-Krüpe in this volume.

## Ars polymita, ars plumaria: The Weaving Terminology of Taqueté and Tapestry

John Peter Wild and Kerstin Droß-Krüpe

In Roman Egypt papyrologists and archaeologists sometimes seem to inhabit two different, if parallel, worlds, each apparently unaware of the treasures to be found in the other.<sup>1</sup> This paper, however, is a co-operative venture between an ancient historian with papyrological interests – Kerstin Droß-Krüpe – and an archaeologist – John Peter Wild. In the research field of textiles we overlap, and we want to offer you insights from each of our worlds.

At some point in the later 2nd century AD an unnamed magnate in the territory of the Lingones in central Gaul dictated a will in which he stipulated that a number of his prized possessions should be cremated with him on his funeral pyre.<sup>2</sup> Among those listed are *vestes polymitae et plumariae*.<sup>3</sup> What do these two textile terms mean? And what did the textiles themselves look like? The images in Figures 1 and 2 are our provisional suggestions. The two items shown here are of wool – they are actually from Roman Egypt – and at first glance they look in decorative

terms rather similar to one another;<sup>4</sup> but the textile in Figure 1 is in *taqueté* — *vestis polymita*, we argue — mechanically woven — while the piece in Figure 2 is in tapestry weave, *vestis plumaria*, and hand-woven.

The structures of the two weaves can be characterised as follows:

Tapestry weave, made famous by the Gobelin workshops in Paris, is essentially a mosaic in coloured wool yarns, constructed free-hand, and concealing the underlying warp.<sup>5</sup> The weaver has available on individual spools a selection of dyed yarns which he or she interlaces with the warp threads according to the requirements of the pattern. A distinctive feature of tapestry is the oblique lines or even vertical slits where weft yarns in different colours meet one another and turn back (Fig. 3). Across an area, an accomplished weaver can achieve the subtle, gradual, changes in colour visible in the highest-quality floor and wall-mosaics and in wall painting.

1. For a welcome recent exception see Palme & Zdiarsky 2012.

2. *CIL* XIII, 5708; Le Bohec 1991, 46 for dating; Le Bohec 2003. The inscription is only recorded in a 10th-century manuscript now in Basel.

3. The relevant part of the text as established by P. Sage *ap.* Le Bohec 2003, 354 reads: *volo autem omne instrumentum ... mecum cremari ... et vestis polymit(ae) et plumari[ae] ?] ... quidquid reliquero.*

4. Fig.0.1: Wild & Wild 1998, 223, Fig. 10-1; Fig.0.2: Schrenk 2004, 447; compare Trilling 1982, 98 no. 108, Pl. 8 (*taqueté*) with *ibid.* 31 no.1, Pl. 1 (tapestry).

5. Seiler-Baldinger 1973, 44-48.

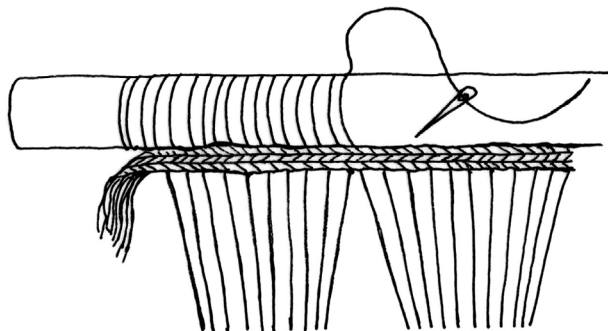




**Fig. 1.** Detail of a Late Roman wool textile in *taqueté* from the Roman port of Berenike on the Red Sea coast of Egypt (BE96 0227). On-site photo: J.P. Wild.

**Fig. 2.** Detail of a wool textile in tapestry weave from Egypt, now in the collection of the Abegg-Stiftung, Bern, showing a bunch of lotus flowers (Inv. Nr. 5345). Photo by courtesy of the Abegg-Stiftung, CH-3132 Riggisberg.



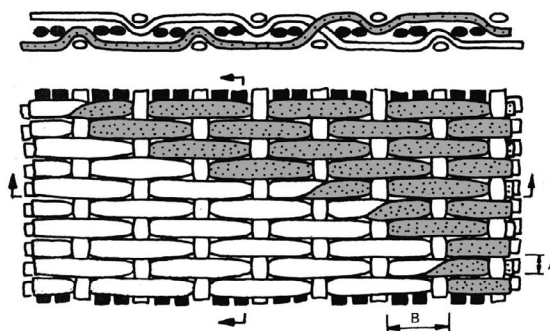


**Fig. 3.** Diagram of the meeting and reversal of weft yarns in tapestry weave. After Seagroatt (1979), 14.

*Taqueté*, also known as ‘weft-faced compound tabby’ and in German *Leinwandschusskompositbildung*, aims for a similar decorative effect, but rarely in more than two colours. It is created mechanically by means of a complex planned sequence of different sheds on the loom, which the weaver memorises.<sup>6</sup> The overall decorative scheme is constructed by repeating a single pattern unit, sometime in mirror image. The weave structure can be recognised by the fact that a weft thread in one colour disappears to the reverse side of the cloth behind an adjacent thread in a different colour as the pattern changes, only to re-appear on the obverse again later when it is required (Fig. 4).

A variety of ancient sources can be deployed to inform discussion and argument about textile structure and terminology.

Roman inscriptions and papyri in Greek and Latin are crucial documents, but tend to be laconic: both the writer and the reader knew exactly what was meant by a given technical expression, but we are left in the dark. Authors of classical literature write at greater length, and at first sight more helpfully; but their reliability is variable and often difficult to check. Poets, for example, treat of technical matters with artistic licence, especially when the vocabulary does not fit the metre. Scholars who consult another much-quoted



**Fig. 4.** Diagram of the structure of *taqueté*. Drawing by courtesy of D. De Jonghe.

source, the late Roman and early medieval encyclopaedists and glossators like Hesychius and Isidore, are well advised to exercise caution: for such compilers may simply be guessing.

Ancient art, particularly funerary art, is a rich source of textile images, but, taken alone, the latter usually lack the necessary detail for precise technical identification. Surviving archaeological textiles are a relatively new and growing resource, and one might expect to find examples of *vestis polymita* and *plumaria* somewhere in the extant textile corpus. Both techniques are described explicitly as woven-in, and not decoration added afterwards, so that narrows the range of possibilities.<sup>7</sup>

### *Vestis polymita*

I (JPW) need to start by revisiting, and recanting, what I wrote in 1967 about the *ars polymita*.<sup>8</sup> I argued then that it meant ‘tapestry weaving’; but I now accept that it refers to weaving *taqueté*, weft-faced compound tabby, as Grace Crowfoot, Donald King and others suggested long ago.<sup>9</sup>

Commentators often begin with the passage in Pliny’s *Natural History* where he claims that Alexandria invented the weaving of *polymita*, with *plurimalicia*, ‘multiple threads’.<sup>10</sup> The Greek *mitos* and the

6. Ciszuk 2000; Verhecken-Lammens 2007.

7. *polymita*: Martial, *Epigrammata* XIV, 50; *plumaria*: Lucan, *Bellum Civile* X, 125-126; Jerome, *Epistulae* 29, 6 (ed. Labourt 1953).

8. Wild 1967; partial recantation; Wild 1991.

9. Crowfoot & Griffiths 1939, 47; King 1981.

10. *Naturalis Historia* VIII, 196 (c.AD 77-79).

Latin *licium*, however, are generic terms, and their specific sense depends on the context in which they are used. They could refer to warp or weft threads, for instance, or to the heddle cords for opening sheds on the loom.<sup>11</sup>

In 1967 I was misled, I now think, by a key passage in a letter (of about AD 395-397) from Jerome to Fabiola in which he is describing the sash of the High Priest in Jewish ceremonial.<sup>12</sup> He says that it was woven in the form of a tube, 4 digits (*c.* 7.4 cm) wide, like a cast-off snake-skin. It had scarlet, purple and blue weft, but linen (or at any rate plant-fibre) warp, with flowers and gem motifs ‘woven in the *ars polymita* that you would think were not woven by a craftsman’s hand but added’, *i.e.* embroidered. Linen warp with polychrome patterned weft in a tubular format sounded to me in 1967 much more likely to be tapestry weave than mechanically woven *taqueté*, and I opted for tapestry, noting some flat-woven tapestry sashes in the archaeological record.<sup>13</sup>

So far, however, no direct archaeological evidence has been found for either *taqueté* or tapestry in tubular form; but Dominique Cardon has published from Maximianon and Krokodilō in the Eastern Desert of Egypt a group of early Roman tubular textiles in 2/1 herringbone twill weave with multi-coloured plied

warp.<sup>14</sup> The existence of a tubular form of *taqueté* therefore cannot be ruled out. On the other hand Jerome’s phraseology echoes the Latin of his translation of the Hebrew text of the Book of Exodus; he may have been unaware (or chose to ignore) that *taqueté* was not known in Old Testament times. It would probably be unwise to place too much weight on his words.<sup>15</sup>

Petronius,<sup>16</sup> Pliny<sup>17</sup> and Martial<sup>18</sup> mention *polymita* in the 1st century AD. A dearth of archaeological finds of *taquetés* at that early date, which seemed to me an obstacle in the 1960s, has recently been alleviated by finds of early Roman *taquetés* at Berenike (Fig. 5),<sup>19</sup> Mons Claudianus,<sup>20</sup> Maximianon and Krokodilō<sup>21</sup> and Masada.<sup>22</sup> There are today several hundred Late Roman wool *taquetés* from Egypt.<sup>23</sup>

*Polymita* was used for covering beds, couches and pillows according to both Martial and documentary papyri.<sup>24</sup> In Roman Egypt there are several finds of feathers still adhering to *taqueté* upholstery covers,<sup>25</sup> and we have noted at Berenike that wool textiles in *taqueté* have had only one side exposed to strong daylight.

Another recent development is the recognition and recording of the *zilu* loom still in use today in parts of Iran for weaving *taqueté*.<sup>26</sup> It is vertical and

11. LSJ 1968 *s.v.* μίτος; TLC *s.v.* μίτος; Beekes 2010, 958 *s.v.* μίτος. *Multicia* in Latin is not necessarily a synonym for *polymita*: SHA, *Aurelian* 12; Juvenal, II, 66, 76; Tertullian, *de Pallio* IV, 4.

12. Jerome, *Epistulae* 64, 12 (ed. Labourt 1953).

13. For a flat-woven sash from Nubia see Mayer Thurman & Williams 1979, 62 no.16 (B213, 4) (colour plate p.15); 64 no.21 (B251, 2); narrow ‘pyjama cords’ from Quseir: Eastwood 1982, 286, 302 nos. 26-28. The πολύμια ζῶνα of the *Periplus Maris Erythraei* 49 is probably a copyist’s error for πολυμίτα ζῶνα, two separate items, not one. We are grateful to Eleanor Dickey for advice on this point.

14. Cardon 2003, 631, 645 (Z.25008-2), Fig. 326,b; Fig. 343; Pl. IV, 1 (lower centre).

15. In the Vulgate *Exodus* 29, 39 (39, 29) Jerome translates or paraphrases the Hebrew description of a similar sash as *opus plumarii*.

16. *Cena Trimalchionis* 40, 5 (*c.* AD 40-50).

17. *Naturalis Historia* VIII, 196.

18. *Epigrammata* XIV, 150.

19. Wild & Wild 2000, 256, Fig.11-12, Pl.11-13.

20. Ciszuk 2000.

21. Cardon 2003, 635.

22. Sheffer & Granger-Taylor 1994, 212-215.

23. Vogelsang-Eastwood 1988a.

24. Martial, *Epigrammata* XIV, 150; SB III, 7033, 37 (AD 481); P.Ital.I,8,II,6 (AD 564).

25. Schrenk 2004, 139-140 Nr. 47; Vogelsang-Eastwood 1988a, Vol. III, 592-596.

26. Vogelsang-Eastwood 1988b; Thompson & Granger-Taylor 1995; Ciszuk 2000; Thompson 2003, 207-209. A very wide, wide-sleeved, one-piece silk tunic in the Abegg-Stiftung’s collection at Riggisberg (the “Erotentunika”) (Schrenk 2004, 180-184 Nr.61),

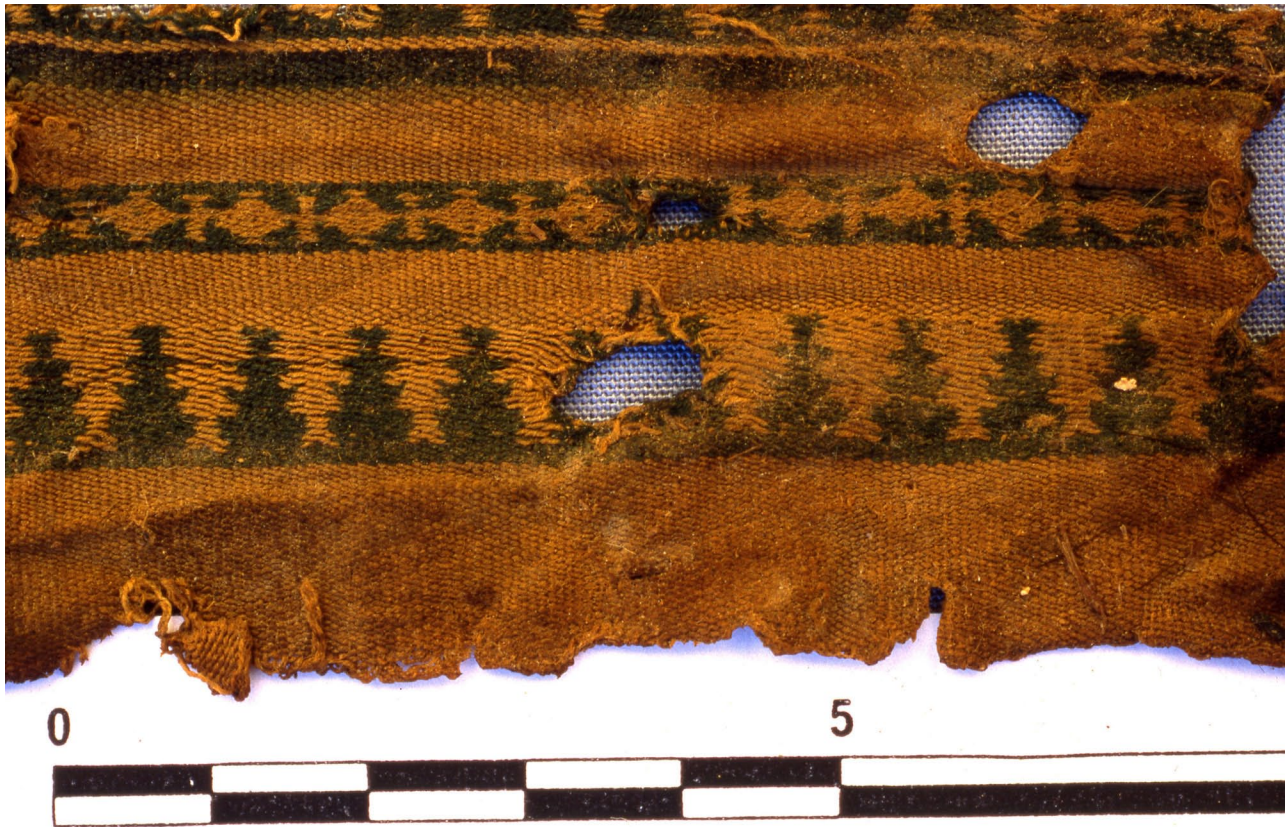


Fig. 5. An Early Roman wool *taqueté* from Berenike (BE97 0118) (compare Fig. 1). On-site photo: J.P.Wild.

very large, and features two types of shed: the one is opened in plain tabby weave with heddle rods, the other type, the pattern-making sheds, is opened by draw-cords in various hierarchies – pulled out horizontally. These cords are good candidates to be the *mitoi* of *polymita*. Pliny could well be right about invention in Alexandria: the shedding mechanism of the ancient ancestor of the *zilu* loom could, like the water mill, be another brainwave emanating from the circle attached to the Museum in Ptolemaic Alexandria.<sup>27</sup>

So, if *vestis polymita* is *taqueté*, what is *vestis plumaria*?

### *Vestis plumaria*

The lexica are almost unanimous in translating *vestis plumaria* as ‘embroidered textile’ and they have been followed faithfully by most editors of papyri.<sup>28</sup> Indeed, at first reading, ‘embroidery’ seems to fit in all 95 instances of the use in Latin and Greek of terms based on the root *plum-*. But on closer inspection there are some broader issues.

Kerstin Droß-Krüpe has pointed out elsewhere that most classical references relating unambiguously to embroidery and using phrases like *acu pingere*, ‘decorate with a needle’, refer to foreign exotica

dated iconographically to the first half of the 4th century AD, is identical in outline to the earlier one-piece cruciform wool tunics woven on the standard Roman wide vertical loom; but it was woven in weft-faced compound twill, more advanced than *taqueté*. It may point to a link between the *zilu* loom and an ancient vertical prototype.

27. Wilson 2002, 8, 10; Wilson 2008, 355; Greene 2008, 804-809.

28. LS 1955 *s.v.* *plumarius*; OLD *s.v.* *plumarius* (“brocaded with a feather pattern”); LSJ 1968 *s.v.* *πλουμαρικός*; Lampe 1961 *s.v.* *πλουμαρικός*; Pruneti 1988-1999, *passim*.

**Table 1.** The Latin text of Chapter XX of the Edict of Diocletian.

XX 1	[De mercedi]bus plumariorum et sericarioru[m]		
1a	[plumari]o in strictoria subserica		
	pro uncia [una	x ducentos]	
2	in strictoria holoserica		
	per singulas unc[ias x trecen]tos		
3	in chlamyde Mutinensi		
	in uncia una	x viginti quinque	
4	in chlamyde Ladicena ut s(upra)		
	in uncia una	x vigi[n]ti quinque	
5	barbaricario ex a[u]ro facient<i>		
	operis primi in uncia una	x mille	
6	operis secundi	x septingentos	
		quingenta	
7	barbaricari[o i]n holos[er]ica		
	in uncia una	x quingentos	
8	operis secundi in uncia una	x quadringentos	
9	sericario in subserica pasto diurnos	x viginti quinque	
10	in holoserica pura pasto diurnos	x viginti quinque	
11	in holoserica scutlata	x quadraginta	
12	gerdiae pastae in tunica pexa		
	indictionali	x duodecim	
13	in tunicis Mutinensibus vel ceteris		
	pastae	x sedecim	

rather than Mediterranean fashion.<sup>29</sup> But there *was* a Mediterranean tradition of embroidery of considerable sophistication, exemplified by a well-known panel from Achmîm where chain stitch and couched wool thread has been deployed to represent the personification of Autumn (Fig. 6), one of an original quartet.<sup>30</sup> Nonetheless the corpus of surviving embroideries from the Roman world discussed recently by Annette Schieck is relatively small and – one has to admit – not very inspiring.<sup>31</sup>

I argued very briefly in 1999 that the *ars plumaria* was not embroidery, but tapestry weaving,<sup>32</sup> and Kerstin Droß-Krüpe came to the same conclusion in her study just mentioned.<sup>33</sup> What is the evidence?

In AD 301 the Emperor Diocletian made a forlorn attempt to control rising prices for consumer goods

and services by promulgating an Edict on Maximum Prices, intended to be applied across the Empire, and probably respected particularly in the eastern provinces which he ruled directly. The archetype was in Latin, but Greek translations were posted in the East. The compilers took an empire-wide view of the most significant merchandise to be included, along with its prices in notional *denarii*. There has been argument about the artificiality of the pricing structure, but for us it is the relative costs that reveal the relative qualities of the goods that matter most.<sup>34</sup>

In Edict Chapter XX on pay in the textile industry the *plumarius* is paid per ounce of yarn for working on long-sleeved silk tunics (*strictoriae*), half-silk tunics and two of the most expensive half-moon cloaks (*chlamydes*) in wool (Table 1).<sup>35</sup> His lowest rate of

29. Droß-Krüpe & Paetz gen. Schieck 2014, 211. For specifically Greek terminology see Patera 2012.

30. Pritchard 2006, 30-31, Fig.3.3.

31. Droß-Krüpe & Paetz gen. Schieck 2014, 214-227.

32. Wild 2000, 210.

33. Droß-Krüpe & Paetz gen. Schieck 2014, 212; Rea (1996, 191) suspected a connection with “tapestry work”.

34. For text and commentary see Lauffer 1971; for text incorporating later finds: Giacchero 1974; Reynolds 1989; for the wider context: Corcoran 1996, 205-233; Meissner 2000; for the Edict’s nominal empire-wide validity: Kuhoff 2001, 544-550; for actual limited observance: Crawford 2002; for pricing structure: Meissner 2000, 99; Böhnke 1994, 482; Demandt 2008, 29. A new edition of the Edict is in preparation by M.H.Crawford.

35. EdD XX, 1-4.



**Fig. 6.** Late Roman embroidered panel in wool on a linen ground from Egypt, now in the Whitworth Art Gallery, Manchester (inv. no.T.1968.252). It shows the personification of a season, probably Autumn. Photo by courtesy of the Whitworth Art Gallery, Manchester.

pay, 25 *denarii* per ounce, is twice what a specialist (female) wool weaver could earn for a day's work.<sup>36</sup>

In Chapter XIX on wool textiles reference is constantly made to the value of the purple wool embodied in the decorative features. In the entries for two sorts of expensive bed covering (*rachana* and *stragula*),<sup>37</sup> for high-quality long-sleeved tunics in wool (*strictoriae*)<sup>38</sup> and probably for the higher class of *chlamys* on which the *plumarius* worked,<sup>39</sup> it is prescribed that the textiles should be sold according to the weight of *plumatura* (πλουμάρισις in the Greek texts); but no upper price limit is set. For the less valuable and elaborate items, the jargon used in Chapter XIX is 'clavans purpurae libras x', 'with *clavus* bands containing x pounds of purple yarn'.<sup>40</sup>

The compilers had no need to clarify their terminology. A glance through the catalogues of some of the principal collections of so-called 'Coptic' textiles in European museums – effectively the clothing of the well-to-do of Late Roman Egypt, often salvaged from their burial grounds with minimal or no archaeological record – leaves no doubt that tapestry weave is the dominant, almost exclusive, mode of Roman textile decoration.<sup>41</sup> Egypt, thanks to local climatic conditions ideal for the preservation of organic materials, offers a snapshot of a phenomenon which is reflected in contemporary iconography across the whole Roman Empire,<sup>42</sup> and among

its neighbours, such as the Palmyrenes and Sasanians, further East.<sup>43</sup>

If the dominant decorative form according to the Edict is *plumatura*, and the dominant technique in the archaeological record is tapestry weave, it is hard not to identify the one with the other. This is juxtaposition of evidence, however, not proof. But at present it has to be the basis of our hypothesis.

Some supporting amplification is to be found in comparing the range of textile goods for which the use of tapestry weave for decoration is archaeologically attested with the textile spectrum of which the written sources give us a glimpse.

Only a handful of types of textile were created entirely in tapestry weave, notably couch furnishings, curtains and wall-hangings.<sup>44</sup> More commonly, individual tapestry-woven inserts are found in garments of wool, linen and silk which are otherwise undecorated. On (long-sleeved) tunics (Fig. 7) the technique was employed for weaving figured and plain bands (*clavi*) down front and back, roundels and panels at the shoulder, pairs of short bands at the wrist, and sometimes halters at the neck and horizontal bands at knee level.<sup>45</sup> Cloaks are embellished with roundels and panels and other simpler motifs, placed in the corners, depending on garment shape.<sup>46</sup> Furnishing fabrics also feature corner decoration, and bands marking the start and finish of the web.<sup>47</sup>

36. EdD XX, 12-13 for wages of a *gerdia*, 'female weaver'.

37. EdD XIX, 6; XX, 36.

38. EdD XIX, 20: this is a lacunose entry and there is some doubt about the items listed.

39. EdD XIX, 22.

40. EdD XIX, 8-13, 15-16, 18-19, 21, 23-24, 27.

41. For example Trilling 1982; Lorquin 1992; Schrenk 2004; Pritchard 2006.

42. For example in the mosaics of the Late Roman villa near Piazza Armerina in Sicily (Carandini *et al.* 1982, *passim*; Wilson 1983) and mosaics in the North African provinces (Dunbabin 1978). The Late Roman mosaics at Noheda (Spain) depict a riot of exuberantly decorated costumes, many theatrical, but others more everyday (Tévar 2013).

43. Schmidt-Colinet 1995.

44. Trilling 1982, Pls. 1, 2; Schrenk 2004, 26-45; Willers & Niekamp 2015; von Falck & Lichtwark 1996, 344-345 Nr. 394. Theocritus (*Epigrammata* XV, 78-83) refers to large (tapestry-woven?) hangings in Ptolemaic Alexandria (3rd century BC) and an epigram in the *Anthologia Graeca* (IX, 778) was originally attached to a tapestry map of the world.

45. Long-sleeved tunics: von Falck & Lichtwark 1996, 272-273, Nr. 312; Schrenk 2004, 152-164; wide-sleeved tunics: Pritchard 2006, 52-59.

46. Maciej Szymaszek is currently preparing a corpus of all Roman-period textiles, mostly cloaks, carrying decoration of tapestry-woven gamma-motifs.

47. Cushions: Paetz gen. Schieck 2009; curtain: Gervers 1977; spreads with loops: von Falck & Lichtwark 1996, 301-302 Nr. 341a-b; Verheeken-Lammens 2009, 132 Fig. 6; *sabana* (?): Carroll 1988, 94 no. 9.



**Fig. 7.** Long-sleeved tunic in linen from Panopolis (Achmim), Egypt, now in the Museum Kunstpalast, Düsseldorf (Inv. Nr. 12746). Photo by courtesy of the Stiftung Museum Kunstpalast, Düsseldorf (Artothek).

References to long-sleeved shirts (*strictoriae*, στριχάρια) with *plumatura* abound in the papyri,<sup>48</sup> and Diocletian's Edict adds the wide-fitting *dalmaticae* to the list, together with half-moon cloaks (*chlamydes*) and rectangular cloaks (*fibulatoria*).<sup>49</sup> Papyri mention veils and head-coverings with tapestry decoration (described as πλουμαρικὰ).<sup>50</sup> Household furnishings had

more modest tapestry decoration. Under this heading we find a (wool) blanket,<sup>51</sup> 'spread' (*rachana*, *stragula*),<sup>52</sup> and cushion cover.<sup>53</sup> Most items, however, were anonymous linen sheets and towels with a touch of colour:<sup>54</sup> Late Roman church inventories mention altar cloths and curtains.<sup>55</sup>

48. P.Oxy. XIV, 1741, 16; P.Fouad 74, 6; SB XVI, 12940, 12; SPP XX, 245, 6; SPP XX, 275, 3-4; P.L.Bat. 25, 28; compare EdD XIX, 18, 20, 40; XXVII, 8-10 (ed. Giaccherio 1974).

49. EdD XIX, 9; XXVII, 12-22 (ed. Giaccherio 1974); XIX, 21, 24.

50. PSI IX, 1082, 14-15; compare EdD XXVII, 29-33 (ed. Giaccherio 1974).

51. P.Cair.Masp. I, 6 v. 85, 88.

52. EdD XIX, 6, 36.

53. P.Berol. 25405, 7-8.

54. *faciale*, 'face cloth': SB III, 7033, 45; EdD XXVII, 23-28 (ed. Giaccherio 1974); *sabanum*, 'hand towel': P.Oxy. XVI, 2054, 8; 'linens': SPP III, 83, 4; SB XVIII, 13965; SB XX, 14202, 5, 6; Diethart 1983, 13, doc. 3, 10; P.Ant. I, 44, 8-9, 13; SPP XX, 245, 13, 14.

55. P.L.Bat. 25, 13, 20, 27-29, 31.



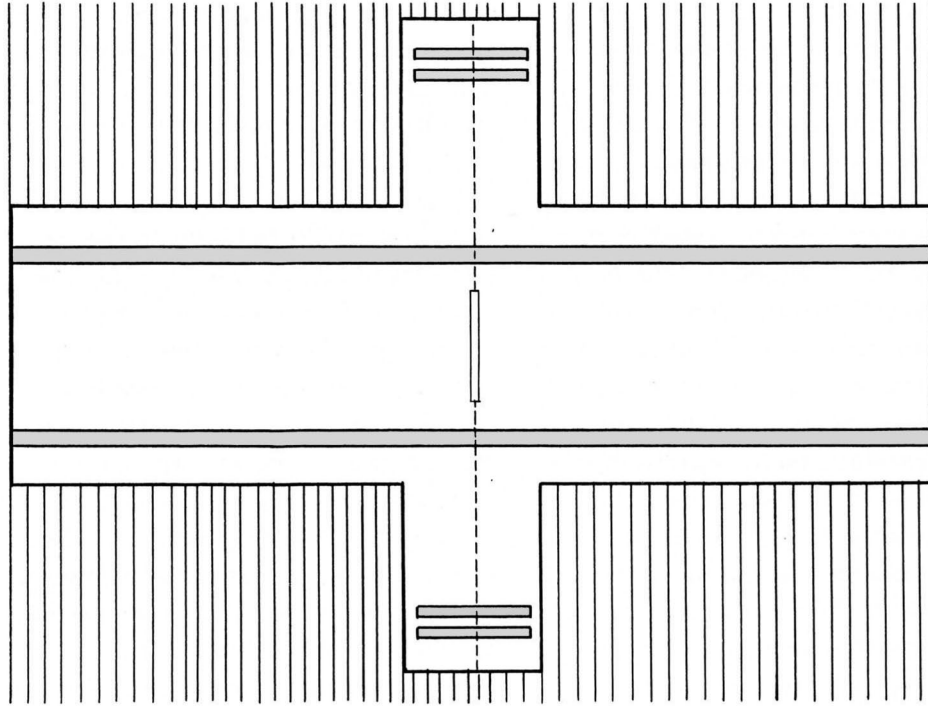


Fig. 8. Outline drawing of a sleeved tunic as woven in one piece on the loom. After Carroll (1988), 38.

### The craft of the *plumarius*

Some 40 *plumarii* (and two *plumariae*<sup>56</sup>) are known to us from a span of seven centuries (see Appendix 1). Vitruvius in Augustus' reign and the compilers of Diocletian's Edict 300 years later both make special provision for the work of the *plumarius*.<sup>57</sup> A late Roman contract of apprenticeship provides for a girl, Evangeleia, to be trained as a *πλουμαρίσσα* by 'experienced *πλουμαρίοι*'.<sup>58</sup> But what did *plumarii* actually do?

Garments of wool and most linen textiles in antiquity were woven to shape on the loom as a single web of cloth (Fig. 8): they required little subsequent tailoring.<sup>59</sup> Tapestry-woven decoration in panels, roundels

and *clavus*-bands was integrated into the weaving on the loom as the appropriate stages were reached, and this is when the *plumarius* would be called upon to exercise his skills. But it was no simple matter.

To intensify the effect of the areas of dyed weft, the warp within the chosen ornament – band, panel or roundel – was often grouped and crossed (so-called *croisage*) (Figs. 9, 10), so that the weft yarn could be beaten up tighter.<sup>60</sup> The precise configuration of the warp crossing varied greatly.<sup>61</sup> Common to all, however, was that the warp re-arrangement started and ended within the flanking ground weave, a diagnostic feature most clearly seen along the edges of tapestry-woven bands. This means that the weaver, before and after inserting the coloured weft yarn, passed a few

56. For *plumariae*: P.Oxy. LIX, 4001, 19-20; P.Aberd. I, 59. (In P.Coll.Youtie II, 95, 6 A. Delattre reads *πλου[μ]αρισσ(η)ς* in preference to the original editor's *τα<ρ>σι[κ]αρισσης*; but the sense of the context militates against this reading.) For a general survey of specialists see Ruffing 2008, 722, *plumarii*.

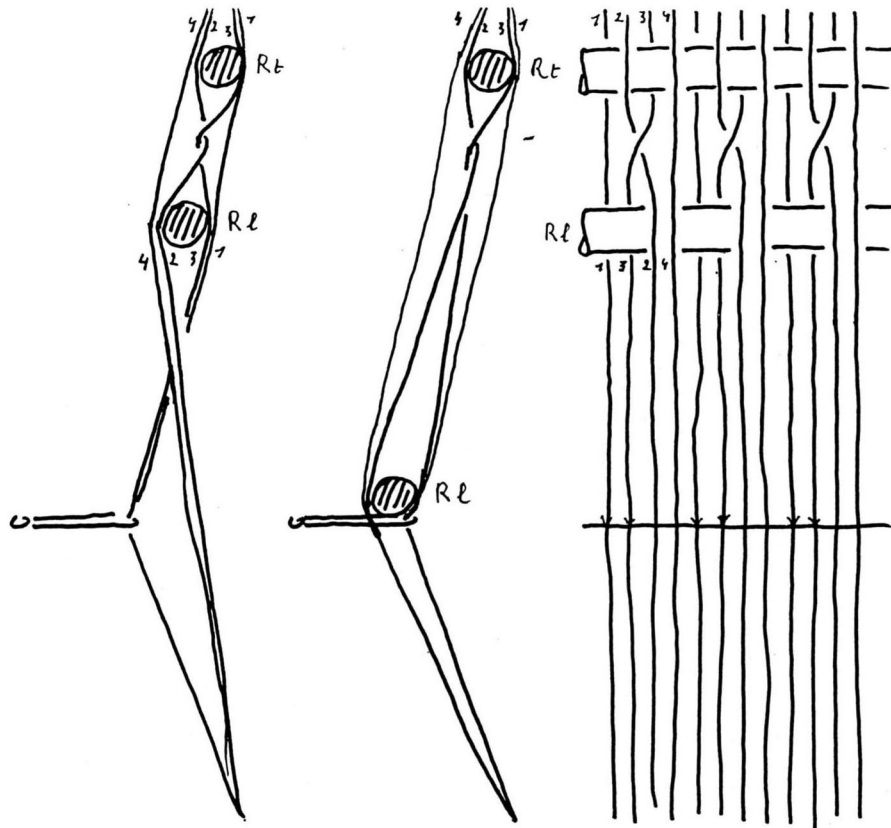
57. Vitruvius, *de Architectura* VI, 4, 2; EdD XIX, XX *passim*.

58. P.Aberd. I, 59.

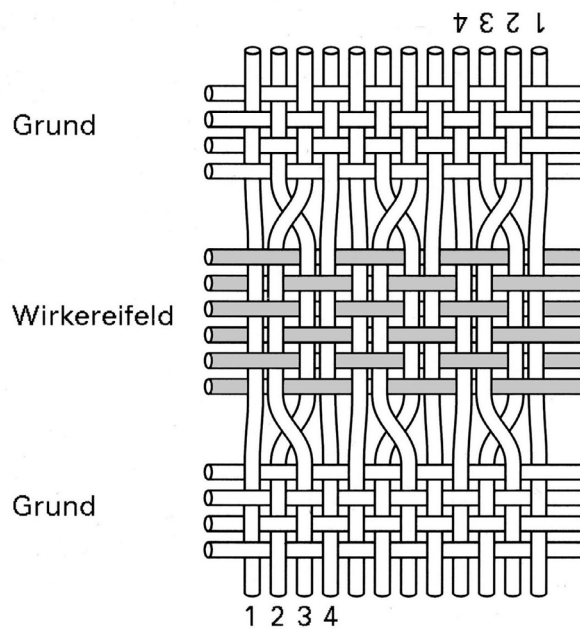
59. Burnham 1973, 2-5; Granger-Taylor 1982; for an example see Pritchard 2006, Figs. 4.4a, 4.4b.

60. De Jonghe & Tavernier 1983; Granger-Taylor 1992.

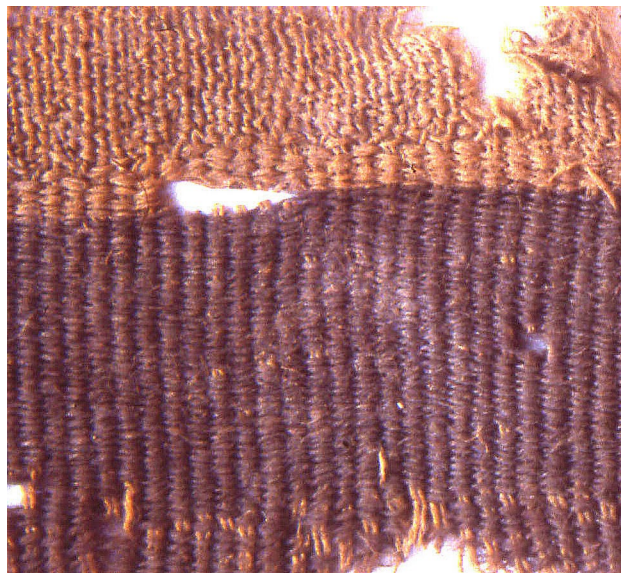
61. Schrenk 2004, 489-491.



**Fig. 9.** Drawing showing the grouping of warp yarns on the loom for *croisage* (warp crossing). Drawing by courtesy of D. De Jonghe.



**Fig. 10.** Diagram of a typical example of the structure of *croisage*. After Schrenk (2004), 489, with permission.



**Fig. 11.** The shadow effect of *croisage* on the ground weave adjacent to a tapestry-woven band on an Early Roman wool textile from Mons Claudianus in the Eastern Desert of Egypt. Photo: J.P. Wild.

yarns of ground weft through the new shed, and thus created a shadow effect (Fig. 11). In some cases – perhaps on particular loom types<sup>62</sup> – some of the warp was eliminated from the weaving by being pushed to the back and ultimately cut or worn off. In some textiles, warp crossing and elimination appear in combination.<sup>63</sup> In some independent tapestry motifs the ground weft also floated on the back.<sup>64</sup> It is noteworthy in some cases that in successive bands on a single textile the same warp threads were grouped or eliminated, so some sort of mechanical device was used to store and repeat the shed.<sup>65</sup>

62. Granger-Taylor 1992.

63. E.g. Pritchard 2006, 50 (T.1996.92).

64. Bogensperger 2012, 93 Abb. 34; Pritchard & Verhecken-Lammens 2001, 23-24 Fig. 3.2.

65. De Jonghe & Tavernier 1983, 182 Fig. 3, 174-175; Ciszuk & Hammarlund 2008, 127-129.

66. Verhecken-Lammens 2013. ‘Flying thread’ might be implied in SB XX, 14214, 10 which lists a garment ‘decorated with tapestry and by needle and ‘point’(?)’.

67. Nauerth 2009.

68. For a corpus of tapestry weavers’ cartoons on papyrus see Stauffer 2008; for wall painters’ copy-books see Ling 1991, 217-220.

69. Nutz & Ottino 2013, 56-57.

70. Cardon *et al.* 2004; Wouters *et al.* 2008.

71. P.Mich. XIV, 684, 12; Iohannes Lydus, *de Magistratibus Populi Romani* II, 13 (ed. Wünsch 1967, 68-69).

72. Willers & Niekamp 2015. Around the time of the Arab conquest of Egypt and thereafter tapestry-woven ornament seems to have been woven separately from the garments to which it was later sewn: Pritchard 2006, 83.

Another enhancement, easily mistaken for embroidery, is the so-called ‘flying thread’ technique (Fig. 12).<sup>66</sup> On an otherwise plain tapestry background white linen thread carried on spools is wrapped around warp threads and passed obliquely over the weft to create a network pattern in silhouette, all carefully counted out.

Finds of inked and/or painted cartoons on papyrus (ἐντύπα, χαρτάρια<sup>67</sup>) (Fig. 13) indicate that the *plumarius* might have a repertoire of design motifs from which a customer could choose, as has been argued for mosaics and wall paintings.<sup>68</sup> The cartoons may have served as a general guide rather than being copied at 1:1 as is modern practice.<sup>69</sup>

Diocletian’s Edict hints that the *plumarius* may have chosen and provided his own dyed yarn, an expensive business. The complexity of Roman dyers’ practices being revealed by modern dyestuff analysis may reflect the pressure which the *plumarius* exerted on dyers to achieve a particular fashionable colour nuance.<sup>70</sup>

The ταβλία πλουμαρικά, tapestry-woven panels, on tunics, cloaks and bedspreads in late antiquity were sophisticated works of art in their own right.<sup>71</sup> Ever more elaborate textile decoration was being demanded at every level in society as time went on. The huge ‘Dionysus Hanging’ in the Abegg-Stiftung, Bern, recently published, is a monument to the skills and dexterity of late Roman tapestry-weavers<sup>72</sup> The *plumarius* must have had a pivotal rather than an ancillary role in the weaving profession. Wealthy patrons might employ him on piecework in their domestic workshops; but the *plumarius* in



**Fig. 12.** The ‘flying thread’ technique on a Late Roman tapestry-woven panel from Egypt in the Musées Royaux d’Art et d’Histoire, Brussels (inv. no. ACO Tx.183). Photo by courtesy of C. Verhecken-Lammens.

turn probably employed humbler weavers to do the basic ground-weaving.

### The etymology of *plumarius* and its congeners

There is a final intriguing question to ask: what was the connection (if any) between *plumarius*, ‘tapestry weaver’, and *pluma*, ‘feather’? Kerstin Dross-Krüpe has already considered this problem, but the sources shed little direct light on it.<sup>73</sup> Petronius alludes to the variegated shimmer of a peacock’s plumage in textile-metaphorical language (*‘aureo Babylonico’*)<sup>74</sup> and

two hundred years earlier Plautus includes *‘plumatile’* in a catalogue of new-fangled clothing designations.<sup>75</sup> Some sort of visual likeness between a bright multi-coloured feather and tapestry weaving might have been in their minds and given rise to the neologism *plumarius*.

Be that as it may, the profession of *plumarius* was established in Italy at least by the close of the Republican period.<sup>76</sup> It occurs for the first time in Greek as a loanword in a papyrus dated no earlier than the late 3rd century AD.<sup>77</sup> Tapestry weaving, however, was already known in Classical and Hellenistic Greece;<sup>78</sup>

73. Dross-Krüpe & Paetz gen. Schieck 2014, 211-212.

74. *Cena Trimalchionis* 55, 2-4; compare Lucan, *Bellum Civile* X, 122.

75. *Epidicus* 233 (ed. Goetz & Schoell 1895).

76. Varro, Frag. 33, in Nonius Marcellus 162, 27 (ed. Lindsay 1903).

77. P.Oslo III, 161, 14-15.

78. Wace 1934, 110; Wace 1948; Wace 1952; Spantidaki & Moulherat 2012, 195-196.



**Fig. 13.** Papyrus from Egypt with a cartoon for tapestry-woven textile decoration, now in the Ägyptisches Museum und Papyrussammlung, Staatliche Museen zu Berlin – Stiftung Preußischer Kulturbesitz (Inv. Nr. P9926). Photo: Sandra Steiss. Copyright: Ägyptisches Museum und Papyrussammlung, Staatliche Museen zu Berlin.

but the practitioner was known simply by the portmanteau term ποικίλης, ‘decorator’.<sup>79</sup> One might suggest that as the craft of tapestry weaving became ever more demanding and sophisticated, a new term was coined to give the operative a more distinctive title.<sup>80</sup> As a loanword *plumarius* (presumably through Greek) is found in Coptic writings,<sup>81</sup> as one might expect, and once in Syriac.<sup>82</sup> But, more surprisingly, *pflūmāri* occurs in Old High German, borrowed (before the second *Lautverschiebung* of c. AD 400) from the Latin vocabulary of the northern Roman frontier provinces.<sup>83</sup>

### Concluding comments

Already at the beginning of this paper we revealed the conclusion we had reached: *vestis polymita* is *taqueté*, *vestis plumaria* is tapestry. Such a premature revelation may seem *unwissenschaftlich*. But we would plead that trying to match textile with text is like playing a game of football on shifting sands. The players move, the ball moves, and so do the goalposts. Scoring a goal is more a matter of luck than fine judgement. But it is fun to try.

### Appendix 1: Sources for textile terms based on the root *-plum-/πλουμ-*

#### 1. *Papyri and Ostraka*

Note: Abbreviations for papyrological publications used below are cited according to the standard set out in J. F. Oates *et al.* (2001) *Checklist of editions of Greek, Latin, Demotic and Coptic papyri, ostraca and tablets* (fifth edition), Oxford, and in later editions online at [www.scriptorium.lib.duke.edu/papyrus/texts/clist.html](http://www.scriptorium.lib.duke.edu/papyrus/texts/clist.html).

79. Droß-Krüpe & Paetz gen. Schieck 2014, 213. In P.Cair.Masp. II, 67163, 7, 12 the same craftsman describes himself as both ποικίλης (I.7) and πλουμάριος (I.12).

80. For a discussion of the implications of loanwords for archaeology see Wild 1976.

81. P.Ryl.Copt. 238, 15. We are grateful to C. MacMahon for the information that the term is also used by Shenute in his (Coptic) writings.

82. As *plumia*: Ioannes Ephesius, *Historia Ecclesiastica* II, 6 (*Scriptores Syri* (Paris 1935), Vol. III, iii, 105-106). We are grateful to Sebastian Brock for advice on this term.

83. We owe this reference to Roland Schumacher (see his article in this volume).

*3rd century AD*: P.Oslo III, 161, 14-15 [late C3 or very early C4 (Pruneti 1998-1999, 152)]; *4th century*: P.Oxy XXIV, 2421, ii, 32 [AD 312 - 323]; P.Dub. I, 20, 3 [AD 329]; PSI IX, 1082, 14-15; P.Oxy LIX, 4001, 19-20 [late C4]; P.Oxy XIV, 1741, 16; PSI VIII, 959, 33 [end C4]; *4th/5th century*: P. et O. El-eph. DAIK 324, 2-4; P.Aberd I, 59, i, 6-7; iii, 2 [C5/6 Turner]; SB XXIV, 16204 = P.Ant. I, 44, 9, 13 (*cf.* Rea 1996); SB XII, 11077, 26; *5th century*: SB XVI, 12838 [ostrakon] [mid C5]; SB XVI, 12839 [ostrakon] [mid C5]; SB XVI, 12840 [ostrakon] [mid C5]; SB XII, 11075, 11 [*c.* AD 400-450]; SB III, 7033, 39, 45 [AD 481]; P.Fouad 74, 6 [end C5 Diethart]; *5th/6th century*: P.Berol. 25405, 8; *6th century*: P.Cair.Masp. II, 67163, 7, 12 [AD 569]; SB XVI, 12940, 12 [= P.Vindob. G.23204]; SPP XX, 245.6, 8, 13, 14; P.Mich. XIV, 684, 12; SB XII, 10935, 21; SPP XX, 275, 1, 3-4; P.Cair.Masp. I, 6 v 85, 88; *6th/7th century*: SPP III, 83, 4; P.Vindob. G.25737 (Diethart 1986, 75-77, 12-13); SB XX, 14214, 10 (P.Vindob. G.10740: Diethart 1990, 108, doc.12, 10); SB XX, 14105, 5; P.Vindob.G.25737, 13 (Diethart 1986, 75-77); *7th century*: SB XIV, 11543, 6 [AD 616/617]; P.Oxy XVI, 2054, 8; SB XX, 14202, 5, 6 (P.Vindob. G.4993 + 23239: Diethart 1990, 82 doc.1, 5-6); P.Prag. II, 153, 1; Diethart 1983, 13, doc 3.10; P.Heid. IV, 95, iv, 64; P.Heid. IV, 97, 26; *7th/8th century*: P.L.Bat. 25, 13, 20, 27-31; *8th century*: P.Lond. IV, 1433, 247 [AD 706-707]; P.Apoll. I, 75, 3 [AD 703-715]; P.Apoll. I, 38, 6-7 [*c.* AD 708-709]; P.Apoll. I, 65, 9 [AD 710-711]; P.Apoll. I, 83 [AD 712-713]; P.Apoll. I, 49, 5; *Coptic*: P.Ryl. Copt. 238, 15 [= \*ἐμπλουμαριος].

#### 2. *Inscriptions*

CIL VI, 7411 (Vicari 2001, no. 50) (Rome) [Augustan]; CIL VI, 9814 (Rome ‘outside gate of St John’)

[1st century AD]; CIL VI, 9813 (Vicari 2001, no.51) (Rome) [1st/2nd century AD]; CIL XIII, 5708 (ILS 8379) (Le Bohec 1991) [AD 150-200]; Edictum Diocletiani, *passim* (Lauffer 1971; Giaccherio 1974) [AD 301]; CIL VI, 31898 (Rome) [4th century?]; SEG XXVII, 1977, no. 995 (Tyre); SEG LIV, 2004, no. 1512 (Pompeiiopolis, Cilicia) [5th/6th century]; CIG 4434 (b) (Cilicia); SEG LVIII, 2008 [p. 336] (IG-CVO, 153A) (Sicily) [late Roman]; SEG XXXVII, 1987, no. 1345 (Tarsus, Cilicia) [5th/6th century]; MAMA III, 496 (Korykos) [5th/6th century]; MAMA III, 685 (Korykos) [5th/6th century]; MAMA III, 441 (Korykos) [5th/6th century]; MAMA III, 285,b (Korykos) [5th/6th century]; MAMA III, 403 (Korykos) [5th/6th century]; MAMA III, 364 (Korykos) [5th/6th century].

### 3. Literature

*1st century BC*: Varro (Frag. 33) in Nonius Marcellus, p.162, 27 [c. 44 BC]; Vitruvius, *de Architectura* VI, 4, 2 [under Augustus]; *1st century AD*: Lucan, *de Bello Civili* X, 123-126 [AD 62 or 63]; *2nd century AD*: (*vacat*); *3rd century AD*: (*vacat*); *4th century AD*: Firmicus Maternus, *Mathesis* III, 6, 4 [fl.c. AD 340]; *Scriptores Historiae Augustae*, Carus XX, 5; Jerome [Hieronimus], *Epistulae* 29, 4 *Ad Marcel-lam* [AD 384]; Jerome, *Epistulae* 29, 6; Jerome, *Epis-tulae* 64, 12 *Ad Fabiolam* [AD 395-397]; *5th century AD*: Prudentius, *Hamartigenia*, 294-295 [c.AD 405]; Caesarius Arelatensis, *Regula ad Virgines* XLII [AD 503-543]; *Liber Pontificalis* I, cxlvi, cxlvii [AD 471]; *6th century AD*: Procopius, *de Aedificiis* III, 247 [AD 553-555]; Johannes Malalas, *Chronicographia* 17, 9, 20 [c. AD 565-570]; Gregory of Tours, *de Glo-ria Martyrum* 97 (S. Sergius) [AD 583-594]; *7th cen-tury AD*: Aldhelm, *de Laudibus Virginitatis* 15.

The decoration of the textiles associated with the Jewish Tabernacle is repeatedly mentioned in the Vul-gate text of *Exodus*, chapters 26-39, where a variety of terms are employed, presumably on the authority of Jerome (*Epistulae* 29, 4). This terminology, and the corresponding Greek of the Septuagint, is discussed by Mossakowska-Gaubert (2000), 305.

### Appendix 2: Word forms built on the root

#### -*plum*-/-*πλουμ*

\* not attested in Greek

#### Latin:

plumarius  
plumare (?) [SHA, *Carus* XX, 5]  
plumatus [Lucan, *de Bello Civili* X, 122; Caesar-  
ius Arelatensis, *Regula ad Virgines* XLII]  
plumatura [Edict of Diocletian *passim*]

#### Greek:

πλουμάριος  
φλουμάρης [P.Oxy. XXIV, 2421, ii, 32; SB XII,  
10935]  
πλουμαρία [P.Oxy. LIX, 400, 19-20]  
πλουμαρίσσα [P.Aberd. I, 59]  
\*πλουμαρίζω [restored from Coptic: Riedel &  
Crum (1904), 55]  
πλουμαρικός [P.Dub. I, 20; PSI VIII, 959, 33]  
πλουμάρισς [Edict of Diocletian *passim*]  
πλουμίον [Procopius, *de Aedificiis* III, 247]  
πλουμ(ία) [SPP XX, 245, 6]  
πλουμαρία [= πλουμία] [P.Oxy. XVI, 2054]  
πλουμαρισίμος [= πλουμαρι<o>σήμος] [P.Ant. I,  
44, 9]

#### Adjectival forms:

ἐμπλουμος [P.Fouad. 74, 6; SB XX, 245, 13]  
εϋπλουμος [P.Ant. I, 44, 13]  
ὀρθόπλουμος [SB III, 7033, 39; P.Apoll. I, 49, 5]  
ὀθονεμλ(ουμάριος ?) [SB XII, 11077, 26]  
\*ἐμπλουμάριος ? [P.Ryl.Copt. 238, 15]

**Abbreviations**

Abbreviations for papyrological publications are cited according to J. F. Oates *et al.* (2001) *Checklist of editions of Greek, Latin, Demotic and Coptic papyri, ostraca and tablets* (fifth edition). Oxford.

- CIG A. Broeckh (1828-1877) *Corpus Inscriptionum Graecarum*. Berlin.
- CIL T. Mommsen *et al.* (1862-) *Corpus Inscriptionum Latinarum*. Berlin.
- EdD S. Lauffer (1971) *Diokletians Preisedikt*. Berlin.  
M. Giaccherio (1974) *Edictum Diocletiani et collegarum de pretiis rerum venalium*. Pubblicazioni dell'Istituto di Storia antica e Scienze ausiliarie dell'Università di Genova. Genoa.
- IGCVO C. Wessel (1989) *Inscriptiones Graecae Christianae Veteres Occidentis*. Bari.
- ILS H. Dessau (1892-1916) *Inscriptiones Latinae Selectae*. Berlin.
- LS C. T. Lewis & C. Short (1955) *A Latin dictionary*. Oxford.
- LSJ H. G. Liddell, R. Scott & A. S. Jones (1968) *A Greek-English lexicon*. Oxford.
- MAMA W. M. Calder *et al.* (1928-) *Monumenta Asiae Minoris Antiqua*. Manchester.
- OLD P. G. W. Glare (1980-1982) *Oxford Latin dictionary*. Oxford.
- SEG *Supplementum Epigraphicum Graecum* (1923-).
- ZPE *Zeitschrift für Papyrologie und Epigraphik*.

**Bibliography**

- Beekes, R. (2000) *Etymological dictionary of Greek*. Leiden.
- Böhnke, H. (1994) Ist Diokletians Geldpolitik gescheitert? *Zeitschrift für Papyrologie und Epigraphik* 100, 473-483.
- Bogensperger, I. (2012) Spätantike und frühmittelalterliche Textilien. In Palme & Zdiarsky 2012, 89-108.
- Burnham, D. K. (1973) *Cut my cote*. Toronto.
- Carandini, A., Ricci, A. & de Vos, M. (1982) *Filosofiana: the villa of Piazza Armerina: the image of a Roman aristocrat at the time of Constantine*. Palermo.
- Cardon, D. (2003) Chiffons dans le Désert: Textiles des Dépotoirs de Maximianon et Krokodilô. In H. Cuvigny (ed.), *La route de Myos Hormos: l'armée romaine dans le Désert Oriental d'Égypte II*, 619-659. Fouilles de l'IFAO 48/2. Cairo.
- Cardon, D., Wouters, J., Vanden Berghe, I., Richard, G., & Breniaux, R. (2004) Dye Analyses of Selected Textiles from Maximianon, Krokodilô and Didymoi (Egypt). In C. Alfaro, J. P. Wild, & B. Costa (eds.), *Purpureae vestes I: Actas del I Symposium Internacional sobre Textiles y Tintes del Mediterráneo en época romana (Ibiza, 8 al 10 de noviembre, 2002)*, 145-154. Valencia.
- Carroll, D. L. (1988) *Looms and textiles of the Copts*. Washington.
- Ciszuk, M. (2000) Taquetés from Mons Claudianus – Analyses and Reconstruction. In D. Cardon & M. Feugère (eds.), *Archéologie des textiles des origines au V<sup>e</sup> siècle. Actes du colloque de Lattes, octobre 1999*, 265-282. Monographies Instrumentum 14. Montagnac.
- Ciszuk, M. & Hammarlund, L. (2008) Roman looms – A Study of Craftsmanship and Technology in the Mons Claudianus Textile Project. In C. Alfaro & L. Karali (eds.), *Vestidos, textiles y tintes. Estudios sobre la producción de bienes de consumo en la Antigüedad: Actas del II Symposium internacional sobre Textiles y tintes del Mediterráneo en el mundo antiguo (Atenas, 24 al 26 de noviembre, 2005)*, 119-133. *Purpureae vestes 2: Textiles and Dyes in Antiquity*. Valencia.
- Corcoran, S. J. (1996) *The empire of the tetrarchs: imperial pronouncements and government, AD 284-324*. Oxford.
- Crawford, M. H. (2002) Discovery, Autopsy and Progress: Diocletian's Jigsaw Puzzles. In T.P. Wiseman (ed), *Classics in progress*, 145-163. London.
- Crowfoot, G. M. & Griffiths, J. (1939) Coptic Textiles in Two-Faced Weave with Pattern in Reverse, *Journal of Egyptian Archaeology* 25, 40-47.



- Demandt, A. (2008) *Die Spätantike. Römische Geschichte von Diocletian bis Justinian 284-565 n. Chr.* 2nd edition. München.
- Diethart, J. M. (1983) Lexikalische Rara in drei byzantinischen Mitgift- und Heiratsgutlisten des 6.-8. Jh aus der Wiener Papyrussammlung, *Jahrbuch der Österreichischen Byzantinistik* 33, 7-14.
- Diethart, J. M. (1986) Neue Papyri zur Realienkunde, *Zeitschrift für Papyrologie und Epigraphik* 64, 75-81.
- Diethart, J. M. (1990) Papyri aus byzantinischer Zeit als Fundgrube für lexikographisches und realkundliches Material, *Analecta Papyrologica* 2, 81-114.
- Droß-Krüpe, K. (2011) *Wolle – Weber – Wirtschaft: Die Textilproduktion der römischen Kaiserzeit im Spiegel der papyrologischen Überlieferung.* Philippika 46. Wiesbaden.
- Droß-Krüpe, K. & Paetz gen. Schieck, A. 2014. Unraveling the Tangled Threads of Ancient Embroidery – a Compilation of Written Sources and Archaeologically Preserved Textiles. In M. Harlow & M.-L. Nosch (eds), *Greek and Roman textiles and dress. An interdisciplinary anthology*, 202-203. Ancient Textiles Series 19. Oxford.
- Dunbabin, K. M. D. (1978) *The mosaics of Roman North Africa: studies in iconography and patronage.* Oxford.
- Eastwood, G. M. (1982) Textiles. In D. S. Whitcomb & J. H. Johnson (eds.), *Quseir al-Qadim 1980: preliminary report*, 285-326. Malibu.
- von Falck, M. & Lichtwark, F. (eds.) (1996) *Ägypten, Schätze aus dem Wüstensand; Kunst und Kultur der Christen am Nil.* Wiesbaden.
- Filos, P. (2010) Greek Papyri and Graeco-Latin Hybrid Compounds. In T. V. Evans & D. D. Obbink (eds.), *The language of the papyri*, 221-252. Oxford.
- Gervers, V. (1977) An Early Christian Curtain in the Royal Ontario Museum. In V. Gervers (ed.), *Studies in textile history*, 56-81. Toronto.
- Giacchero, M. (1974) *Edictum Diocletiani et collegarum de pretiis rerum venalium.* Pubblicazioni dell'Istituto di Storia antica e Scienze ausiliarie dell'Università di Genova VIII. Genoa.
- Granger-Taylor, H. (1982) Weaving Clothes to Shape in the Ancient World: the Tunic and Toga of the Arringatore, *Textile History* 13.1, 2-25.
- Granger-Taylor, H. (1992) The Grouping of Warp Threads for Areas of Weft-Faced Decoration in Textiles of the Roman Period: a Means of Distinguishing Looms? *Vlaamse Vereniging voor Oud en Hedendaags Textiel Bulletin* 1992: Aan Daniël De Jonghe, 18-28.
- Greene, K. (2008) Inventors, Invention and Attitudes towards Innovation. In J. P. Oleson (ed.), *The Oxford handbook of engineering and technology in the classical world*, 800-818. Oxford.
- Heberdey, R. & Wilhelm, A. (1891) *Reisen in Kilikien.* Denkschriften 44/6. Wien.
- De Jonghe, D. & Tavernier, M. (1982) Le Phénomène du Croisage des Fils de Châine dans les Tapisseries coptes, *Compte-Rendu de l'Association pour l'Étude et Documentation des Textiles d'Asie* 1982, 1-13.
- De Jonghe, D. & Tavernier, M. (1983) Le Phénomène du Croisage des Fils de Châine dans les Tapisseries coptes, *Bulletin du Centre International pour l'Étude des Textiles Anciens* 57-58, 174-186.
- King, D. (1981) Early Textiles with Hunting Subjects in the Keir Collection. In M. Flury-Lemberg & K. Stollies (eds.), *Documenta textilia: Festschrift für Sigrid Müller-Christensen*, 94-104. München.
- Kuhoff, W. (2001) *Diokletian und die Epoche der Tetrarchie. Das römische Reich zwischen Krisenbewältigung und Neuaufbau (284-317 n. Chr.).* Frankfurt a.M.
- Labourt, J. (1953) *Saint Jérôme: lettres* III. Paris.
- Lampe, G. W. H. (1961) *A patristic Greek lexicon.* Oxford.
- Lauffer, S. (1971) *Diokletians Preisedikt.* Berlin.
- Le Bohec, Y. (1991) *Le testament du Lingon: actes de la journée d'études du 16 mai 1990.* Collection du CERGR N.S. 9. Lyon.
- Le Bohec, Y. (2003) *Inscriptions sur pierre. Inscriptiones latinae Galliae Belgicae I. Lingones.* Paris.
- Ling, R. (1991) *Roman painting.* Cambridge.
- Lorquin, A. (1992) *Les tissus coptes au Musée National du Moyen Âge – Thermes de Cluny. Catalogue des étoffes égyptiennes de lin et de laine d'antiquité tardive au premiers siècles de l'Islam.* Paris.
- Mayer Thurman, C. C. & Williams, B. (1979) *Ancient textiles from Nubia; Meroitic, X-Group and Christian fabrics from Ballana and Qustul.* Chicago.
- Meissner, B. (2000) Über Zweck und Anlass von Diokletians Preisedikt, *Historia* XLIX, 80-100.
- Mossakowska-Gaubert, M. (2000) Tissus Colorés et Découés Exportés d'Égypte au Premier Siècle ap. J.-C. (d'après le *Periplus Maris Erythraei*), *Topoi: Orient-Occident* 20, 289-318.
- Nauerth, C. (2009) Zu Wirkkartons in den Papyri, *Zeitschrift für Papyrologie und Epigraphik* 168, 278.

- Nutz, B. & Ottino, C. (2013) Weaving Pictures; 15<sup>th</sup> century Tapestry Production at Lengberg Castle, *Archaeological Textiles Review* 55, 55-67.
- Paetz gen. Schieck, A. (2009) Late Roman Cushions and the Principles of their Decoration. In A. De Moor & C. Fluck (eds.), *Clothing the house: furnishing textiles of the 1st millennium AD from Egypt and neighbouring countries: proceedings of the 5th conference of the research group "Textiles from the Nile Valley"*, Antwerp, 6-7 October 2007, 115-131. Tielt.
- Page, R. I. (1985) Two Problematic Old English Words. In M. Collins, J. Price & A. Hamer (eds.), *Sources and relations: studies in honour of J. E. Cross*, 198-202. Leeds Studies in English N.S.XVI. Leeds.
- Palme, B. & Zdiarsky, A. (eds.) (2012) *Gewebte Geschichte: Stoffe und Papyri aus dem spätantiken Ägypten*. Wien.
- Patera, M. (2012) Problèmes de la Terminologie grecque de la Broderie: Recherche sur une Aporie. In I. Tzachili & E. Zimi (eds.), *Textiles and dress in Greece and the Roman East: a technological and social approach*, 117-130. Athens.
- Pritchard, F. (2006) *Clothing culture: dress in Egypt in the first millennium AD*. Manchester.
- Pritchard, F. & Verhecken-Lammens, C. (2001) Two Wide-Sleeved Linen Tunics from Roman Egypt. In P. Walton Rogers, L. Bender Jørgensen & A. Rast-Eicher (eds.), *The Roman textile industry and its influence: a birthday tribute to John Peter Wild*, 19-29. Oxford.
- Pruneti, P. (1998-1999) ΠΛΟΥΜΑΡΙΟΣ e ΒΑΡΒΑΡΟΚΑΠΙΟΣ: Osservazioni Lessicali in Margine all'Edictum Diocletiani e alla Testimonianza dei Papyri, *Analecta Papyrologica* 10-11, 149-159.
- Rea, J. R. (1996) P.Ant.I, 44 revised, *Tyche* 11, 187-193.
- Reynolds, J. M. (1989) The Prices Edict. In C. Roueché, *Aphrodisias in late antiquity*, 265-318. *Journal of Roman Studies Monograph* 5. London.
- Riedel, W. & Crum, W. E. (1904) *The Canons of Athanasius of Alexandria: the Arabic and Coptic versions*. London.
- Ruffing, K. (2008) Die berufliche Spezialisierung in Handel and Handwerk. Untersuchungen zu ihrer Entwicklung and zu ihren Bedingungen in der römischen Kaiserzeit im östlichen Mittelmeerraum auf der Grundlage der griechischen Inschriften und Papyri. *Pharos* 24. Rahden/Westf.
- Sage, P. (1991) Le Testament du Lingon: Remarques sur le Texte et sur son Interpretation. In Le Bohec (1991), 17-40.
- Schmidt-Colinet, A. (1995) *Palmyra: Kulturbegegnung im Grenzbereich*. Mainz.
- Schrenk, S. (2004) *Textilien des Mittelmeerraumes aus spätantiker bis frühmittelalterlicher Zeit*. Riggisberg.
- Seagroatt, M. (1979) *Coptic weaves. Notes on the collection of Coptic textiles in the Merseyside county museums*. Liverpool.
- Seiler-Baldinger, A. (1973) *Systematik der textilen Techniken*. Baseler Beiträge zur Ethnologie 14. Basel.
- Sheffer, A. & Granger-Taylor, H. (1994) Textiles from Masada: a Preliminary Selection. In J. Aviran, G. Foester & E. Netzer (eds.), *Masada IV: The Yigael Yadin excavations 1963-1965: final reports*, 151-250. Jerusalem.
- Spantidaki, Y. & Moulherat, C. (2012) Greece. In M. Gleba & U. Mannering (eds.), *Textiles and textile production in Europe from prehistory to AD 400*, 185-200. Oxford.
- Stauffer, A. (2008) *Antike Musterblätter. Wirkkartons aus dem spätantiken und frühbyzantinischen Ägypten*. Wiesbaden.
- Tévar, M. A. V. (2013) The Late-Antique Villa at Noheda (Villa de Domingo García) near Cuenza and its Mo-saics, *Journal of Roman Archaeology* 26, 307-330.
- Thompson, J. (2003) Looms, Carpets and Talims. In R. Tapper & K. McLachlan (eds.), *Tradition and survival: aspects of material culture in the Middle East and Central Asia*, 205-216. London.
- Thompson, J. & Granger-Taylor, H. (1995) The Persian zilu Loom of Meybod, *Bulletin du Centre International d'Étude des Textiles Anciens* 73, 27-53.
- Verhecken-Lammens, C. (2006) Weft-Faced Compound Tabby with Complementary Wefts (taqueté), *Archaeological Textiles Newsletter* 42, 6-12.
- Verhecken-Lammens, C. (2007) Technology of Dated Woollen Weft-Faced Compound Tabby Textiles. In A. De Moor & C. Fluck (eds.), *Methods of dating ancient textiles of the 1st millennium AD from Egypt and neighbouring countries: proceedings of the 4th meeting of the study group "Textiles from the Nile Valley"*, Antwerp, 16-17 April 2005, 194-205. Tielt.
- Verhecken-Lammens, C. (2009) Linen Furnishing Fabrics with Pile in the Collection of Katoen Natie. In A. de Moor & C. Fluck (eds.), *Clothing the house: furnishing textiles of the 1st millennium AD from Egypt and neighbouring countries: proceedings of the 5th conference of the research group "Textiles from the Nile Valley"*, Antwerp, 6-7 October 2007, 132-143. Tielt.
- Verhecken-Lammens, C. (2013) "Flying Thread" Brocading – a Technical Approach. In A. De Moor & C. Fluck

- (eds.), *Drawing the threads together: textiles and footwear of the 1st millennium AD from Egypt: proceedings of the 7th conference of the research group "Textiles from the Nile Valley"*, Antwerp, 7-9 October 2011, 140-149. Tiel.
- Vicari, F. (2001) *Produzione e commercio dei tessuti nell'Occidente romano*. British Archaeological Reports S916. Oxford.
- Vogelsang-Eastwood, G. M. (1988a) *The development and spread of compound weave textiles with particular reference to weft-faced compound weave textiles in wool from Egypt*. PhD dissertation. Manchester.
- Vogelsang-Eastwood, G. M. (1988b) *Zilu* carpets from Iran, *Studia Iranica* 17, 225-234.
- Wace, A. J. B. (1934) The Veil of Despoina, *American Journal of Archaeology* 38, 107-111.
- Wace, A. J. B. (1948) Weaving or Embroidery? *American Journal of Archaeology* 52, 51-55.
- Wace, A. J. B. (1952) The Cloaks of Zeuxis and Demetrius, *Österreichische Jahreshefte* 39, 111-117.
- Wild, J. P. (1967) Two Technical Terms used by Roman Tapestry-Weavers, *Philologus* 111, 151-155.
- Wild, J. P. (1976) Loanwords and Roman Expansion in North-West Europe, *World Archaeology* 8, 57-64.
- Wild, J. P. (1991) Weft-Faced Compound Tabbies: a Re-cantation, *Archaeological Textiles Newsletter* 12, 11.
- Wild, J. P. (2000) Textile Production and Trade in Roman Literature and Written Sources. In D. Cardon & M. Feugère (eds.), *Archéologie des textiles des origines au Ve siècle. Actes du colloque de Lattes, octobre 1999*, 209-213. Monographies Instrumentum 14. Montagnac.
- Wild, J. P. & Wild, F. C. (1998) The Textiles. In S. E. Sidebotham & W. Z. Wendrich (eds.), *Berenike '96: Report of the Excavations at Berenike (Egyptian Red Sea Coast) and the Survey of the Eastern Desert*, 221-236. Leiden.
- Wild, J. P. & Wild, F. C. (2000) Textiles. In S. E. Sidebotham & W. Z. Wendrich (eds.), *Report of the 1998 excavations at Berenike and the survey of the Eastern Desert including excavations in Wadi Kalalat*, 251-274. Leiden.
- Willers, D. & Niekamp, B. (2015) *Der Dionysosbehang der Abegg-Stiftung*. Riggisberger Berichte 40. Riggisberg.
- Wilson, A. (2002) Machines, power and the ancient economy, *Journal of Roman Studies* 42, 1-32.
- Wilson, A. (2008) Machines in Greek and Roman Technology. In J. P. Oleson (ed.), *The Oxford handbook of engineering and technology in the classical world*, 337-366. Oxford.
- Wilson, R. J. A. (1983) *Piazza Armerina*. London.
- Wouters, J., Vanden Berghe, I., Richard, G., Breniaux, R., & Cardon, D. (2008) Dye Analyses of Selected Textiles from Three Roman Sites in the Eastern Desert of Egypt: A Hypothesis on the Dyeing Technology in Roman and Coptic Egypt, *Dyes in History and Archaeology* 21, 1-16.

## Tunics Worn in Egypt in Roman and Byzantine Times: The Greek Vocabulary<sup>1</sup>

Maria Mossakowska-Gaubert

The principal element of the fashion in clothing introduced in Egypt with the arrival of the Romans was a tunic made of two rectangular pieces of fabric sewn together. Such a tunic either would leave the arms naked, or cover the arms to the elbow (fig. 1). This fashion changed with the turn of the 2nd and 3rd century AD. At this time, in addition to the tunics without sleeves, the inhabitants of Egypt started to wear tunics with ‘true’ sleeves – long or short, wide or tight – inspired by the Eastern fashion: the manner of making the tunics changed and the decorative motifs became richer.<sup>2</sup> The tunics were woven to shape, either in one piece (fig. 3)<sup>3</sup> or, probably starting from the 5th century AD,<sup>4</sup> were made up of three pieces stitched together (fig. 4). As for

the sleeveless tunics, they were also woven in only one piece (fig. 2). In the 6th-7th century AD Egypt, one could see a certain influence of the style probably coming from Sassanid Persia.<sup>5</sup> Amongst other things, this tendency was expressed in tunics with long sleeves, sewn in several pieces (fig. 5).

These changes in fashion are reflected in the vocabulary concerning the tunics, as attested in the papyrological documents and in the literary texts. Several Greek terms are employed to indicate tunics in the texts written in Egypt at this time: *δελματική*, *καμίσιον*, *κολόβιον*, *λεβίτων*, *στιχάριον*, *χιτών*. Studies focussing on Egyptian tunics and their vocabulary are dispersed in isolated comments and lexicographical articles, as well as in the publications of

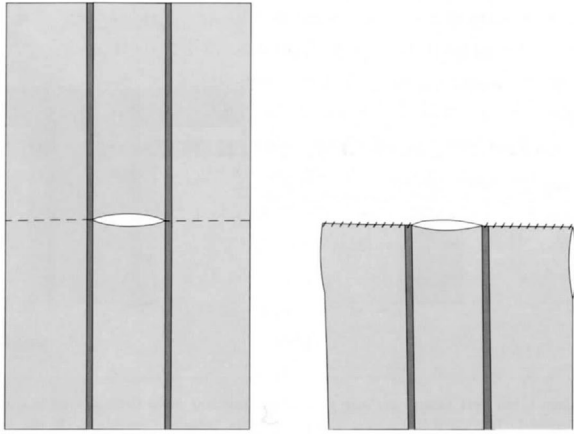
1. I am grateful to Vivienne Callender who translated my paper into English.

2. Regarding the changes in the fashion of tunics, see Croom 2000, 30-40 and 76-85; Mossakowska-Gaubert 2006, 170-173; Pritchard 2006. On the technical details of constructing the tunics, see also Verhecken-Lammens 1997.

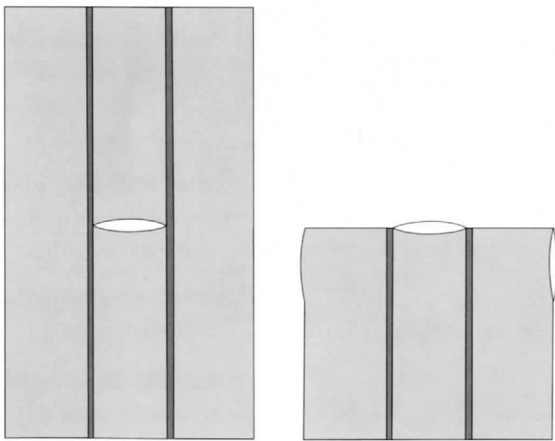
3. Up until now, the most ancient fragments of tunics woven to shape, for which the interpretation leaves no doubt, comes from Dura Europos: they are dated c. 256 AD (cf. Pfister, Bellinger 1945, nos 1-3, pl. V-VII, 14-15 and 17) and from Palmyre – c. 273 AD (Pfister 1934, no. T 20, 19, fig. 2; pl. VI and pp. 24-28).

4. Regarding this date and this phenomenon, see Pritchard 2006, 60 and 68.

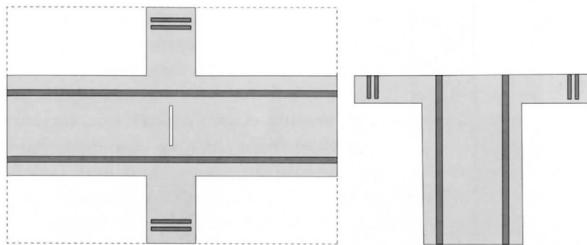
5. See, for example, Calament 1996; Martiniani-Reber 1997; Lorquin 2002.



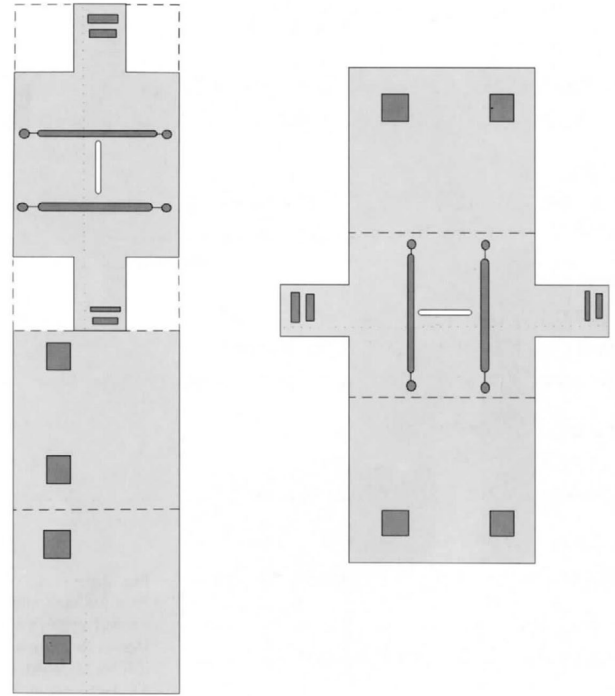
**Figure 1.** Tunic without sleeves, sewn from two pieces. Drawing: Mahmoud Bakhit © Ifao, after Granger Taylor, Sheffer 1994, fig. 28 and 29.



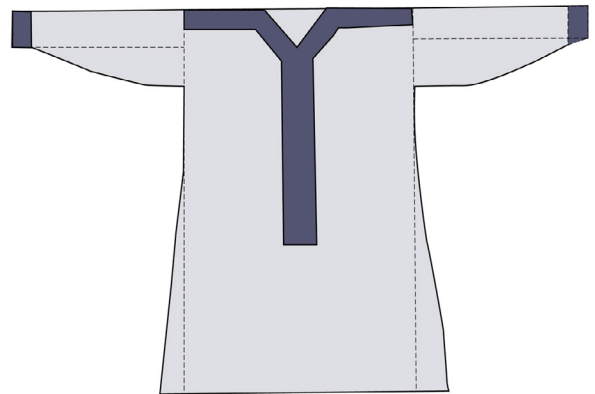
**Figure 2.** Tunic without sleeves, woven to shape, in one piece. Drawing: Mahmoud Bakhit © Ifao, after Wild 1994, fig. 31b.



**Figure 3.** Tunic with long sleeves, woven to shape, in one piece. Drawing: Mahmoud Bakhit © Ifao, after Carroll 1988, fig. 12 A.



**Figure 4.** Tunic with long sleeves, woven to shape, in three pieces. Drawing: Mahmoud Bakhit © Ifao, after Lafontaine-Dosogne, De Jonghe 1988, fig. 137 and 138.



**Figure 5.** Tunic sewn from several pieces. Drawing © Maria Mossakowska-Gaubert, after Tilke 1923, fig. 28.

objects coming from excavations or collections, and they do not exhaust the subject. It is the aim of this paper to present the evolution of the significance of these terms and their employment in the texts coming from Egypt.<sup>6</sup>

### δαλματική / δελματική / δελματικίον<sup>7</sup>

*Dalomatica* is a term having a geographical character, suggesting that the source of this clothing would be from Dalmatia,<sup>8</sup> but we do not have any archaeological or iconographic evidence confirming this etymology.<sup>9</sup>

The oldest known mention of the Latin word *dalmatica* is attested in an inscription containing the copy of a letter written by Claudius Paulinus,<sup>10</sup> governor of Britannia Inferior, dating from 220 AD.<sup>11</sup>

The first notification of the word δαλματική in the Greek language seems to be in a register of clothing written on an papyrus found in Egypt and going back to the end of the 2nd - beginning of the 3rd century, undoubtedly before the year 222 AD.<sup>12</sup> The word δελματική/ δαλματική/ δελματικίον is then frequently mentioned in the Egyptian papyri until the 5th century.<sup>13</sup> We note that this term is almost absent in other Greek texts written in Antiquity, except for the Greek version of the *Edict on Maximum Prices* of Diocletian and the *Panarion* of Epiphanius of Salamis.<sup>14</sup> Those two texts are from the 4th century AD.

The *dalmatica* is associated with the liturgical paraments used in the Roman Church at the end of the Empire.<sup>15</sup> Textual testimonies regarding a possible use of the *dalmatica* in a non-liturgical context in the western

6. One section of the studies presented in this article, especially concerning the tunics without sleeves, has been published in Mosakowska-Gaubert 2004. My studies on the tunics were conducted as part of the PhD dissertation entitled *Le costume monastique en Égypte à la lumière des textes grecs et latins et des sources archéologiques (IV<sup>e</sup>- début du VII<sup>e</sup> siècle)*, prepared under the direction of Włodzimierz Godlewski, and defended in 2006 at Warsaw University. My research on the vocabulary of clothing continues, since 2012 in the collective program "Contexts et mobiliers" directed by Pascale Ballet, Jean-Luc Fournet and myself, hosted by the French Institut of Oriental Archaeology in Cairo – IFAO, and since 2017 in my Marie Skłodowska-Curie fellowship program MONTEX, hosted by the University of Copenhagen's Centre for Textile Research – CTR.
7. On this term see, for example, Bayet 1892; Murri 1943, 121-127; Wild 1968, 222-223; O'Callaghan 1982-83; Granger Taylor 1983, 139, and Dross-Krüpe in this volume.
8. Cf. Isidor of Seville, *Etym.* XIX 22, 9.
9. See Wild 1968, 222.
10. This letter enumerates the gifts offered by Claudius Paulinus to Sennius Sollemnis, a high dignitary from Roman Gaul. Among the gifts is found a *dalmatica* from Laodicea in Syria. The edition of the text: *CIL* XIII, I, 1, 3162, col. II 10. For a reedited text, with translation and detailed commentary, see Pflaum 1948. For the *dalmatica* see particularly p. 25. Cf. also Wild 1968, 222.
11. Despite a clear comment on this subject, made by Wild 1968, 222, n. 250, one still finds in several scientific publications indications concerning the use of the term *dalmatica* / *delamtica* and of the tunic thus named already about the middle of the 2nd century. This opinion is founded on testimony in the *Historia Augusta*, according to which Commodus wore this garment (8.8). However, that work had been written towards the end of the 4th century and the term *delamtica* used there reflects the vocabulary of its author, rather than the *realia* of the time of Commodus.
12. *SB* XXIV 15922, I 22, IV 5. In addition, from the year 230 AD comes another papyrus found in Egypt containing the term δαλματική (*CPR* I 21, 16). Furthermore, *P. Harr.* I 105, containing the word δαλματικάί (l. 8), is dated by its editor to the 2nd century, however, this dating has been questioned and was taken back to the 3rd century (see *BL* XI, p. 90). One other text, the *P. Oxy.* XII 1583, has been dated in an imprecise manner to the 'second century', and it may be that it was written towards the end of the 2nd century. In the thirties and forties of the 3rd century, the δαλματική term also appears in some papyri found at Dura Europos: *P. Dura* 30, 16-18 (232 AD) and *P. Dura* 33, 8 (240-250 AD) and in a *grafitto*: Baur, Rostovtzeff & Bellinger 1933, 153, no. 300, L. 15 – *non vid.*
13. One isolated attestation of the word δαλματική, in a made up word: δαλματικομαφόριον, is found in a text from the 7th-8th century: *SB* VI 9594, 4, 5.
14. *Ed. Diocl.* (301 AD) XXVI, 39, 49, 59 and 72; (315-403 AD), *Panarion* I, I XV (*PG* 41, col. 245A).
15. It is not clear in which period exactly the *dalmatica* became the official costume of the Roman deacons. The citations coming from the *Liber Pontificalis* and *Vita Silvestrii* on this use of the *dalmatica* as a sacerdotal vestment in the 4th century, at the time of Pope Silvester, do not seem to be reliable (on this subject to see Bayet 1892, 20). However, evidence concerning the 6th century (e.g., *Life of Caesarius of Arles*, I, 42; Gregory the Great, *Dialogues*, IV, 42, 2) and much later (e.g., Isidore of Seville, *Etym.* XIX, 22) does seem to be reliable.

part of the Empire are extremely rare.<sup>16</sup> However, this term is usually associated with representations of roomy tunics, with long and wide sleeves, known from Roman art dating to the end of the Empire: they range in style either without a belt,<sup>17</sup> or girdled under the chest (among women)<sup>18</sup> or, more rarely, fastened around the lower part of the hips (among men).<sup>19</sup> One finds tunics of this type in the archaeological material coming in particular from the eastern part of the Mediterranean (fig. 6),<sup>20</sup> but not exclusively.<sup>21</sup> Moreover, one is unaware whether from the beginning this term indicated a tunic with long sleeves, and what the width of these sleeves would have been. A clearly described

*dalmatica* as a tunic with broad sleeves appears only in the later glossaries.<sup>22</sup>

According to the papyrological documents, the *δαλματική* was worn above all by women,<sup>23</sup> but also by men, especially in the 3rd and 4th century AD.<sup>24</sup> However, one does not find in the Egyptian texts any mention of a *δαλματική* like liturgical vestment. In one of the documents, a *δελματική* is mentioned among the *vestis militaris*.<sup>25</sup> This clothing is not attested in the texts and documents concerning the monks.

The *δαλματικά* mentioned in the papyrological texts are made in linen<sup>26</sup> or wool,<sup>27</sup> sometimes decorated with bands of colors: apparently, the *clavi*.<sup>28</sup>

16. It should be noted that this term is absent in the *Thesaurus Linguae Latinae*. One of the rare examples of the wearing of the *dalmatica* in the context which does not seem to be sacerdotal is found in the description of the martyrdom of Cyprian, the bishop of Carthage (*Acta proconsularia S. Cypriani*, V, ed. Th. Ruinart, *Acta Primorum Martyrum Sincera and Selecta*, Amsterdam 1713, 218, and *Corpus Scriptorum Ecclesiasticorum Latinorum* 3, 3, CXIII, 5): clothing that Cyprian removed before his execution, amongst which is found a *dalmatica*, were probably that type of garment usually worn and not liturgical – on this subject, see the comment by Bayet 1892, 20.

17. See the following examples:

*Rome*: Deckers et al. 1991, colour plate 4: orante (second decennial of the 4th century).

*Sicily*: Carandini, Ricci & de Vos 1982, 332. fig. 200: mosaic, mistress of the house, Piazza Armerina (4th century AD).

*North Africa*: Ben Abed-Ben Khader, de Balanda & Uribe Echeverria 2003, fig. 377: mosaic, young woman, Sfax, coll. Brado Museum, Tunis (4th century AD).

18. See the following examples:

*Sicily*: Carandini, Ricci & de Vos 1982, 332. fig. 200: mosaic, one of the maidservants of the mistress, Piazza Armerina (4th century AD);

*Egypt*: von Falck & Lichtwark 1996, 118-119, no. 66: stele of a Rhodia, Fayoum (5th century AD).

19. See the following examples:

*North Africa*: Ben Abed-Ben Khader, de Balanda & Uribe Echeverria 2003, fig. 196: mosaic, combats in the amphitheatre, – central figure Suirat (Amira), coll. Susa Museum (3rd century AD); Ben Abed-Ben Khader, de Balanda & Uribe Echeverria fig. 229: gymnastic show and boxing, – the men preparing decorations, Talh, coll. Gafsa Museum (4th century AD).

20. See, for example, Kendrick 1920, pl. I, no. 1: Egypt – Panopolis (late 3rd to early 4th century AD); Pritchard & Verhecken-Lammens 2001: Egypt – Panopolis? (3rd to early 4th century AD).

21. See, for example, Granger Taylor 1983: two ‘dalmatics of St. Ambrose’, Milan (4th-6th century AD?).

22. See *Corpus glossariorum Latinorum*, ed. G. Goetz, Vol. V, Leipzig 1894, 356, 72: 91 *dalamtica: tunica latas manicas habens*. In addition, in two Greek texts of the 4th century, already quoted here, one *δαλματική* was associated with a tunic having short sleeves or without sleeves, called a *κολόβιον*, either as a garment of the same value, or identical (*Ed. Diocl.* XXVI, 39, 49, 59 and 72; Epiphanius of Salamis I, 1 XV: *PG* 41, col. 245A). The question one would like to answer is whether in this period the *δαλματική* indicated a tunic with short sleeves, or if a *κολόβιον* had long sleeves? One can advance the hypothesis that in the case of these texts it concerns a tunic with short and perhaps wide sleeves, however there is no indication on this last aspect. Moreover, in the scientific literature one finds the opinion that the term *dalmatica* relates to all kinds of tunics with long sleeves (e.g., Carroll 1988, 39), which seems incorrect to us, because each type of tunic with sleeves had its own designation (see below the terms *καμίσιον* and *στιχάριον*).

23. See, for example, *P. Oxy.* XX 2273, 12 (late 3rd century AD): *δ.* destined for a girl; *P. Oxy.* LIV 3765, 12-13 (c. 327 AD): *δ. ταρσικῶν γυναικ(είων)*; *P. Stras.* III 131, 7 (363 AD) – marriage contract; *BGU* XIII 2328, 10 (middle of the 5th century AD?) – marriage contract; *SB* XII 11075, 9 (middle of the 5th century AD): given to a bride.

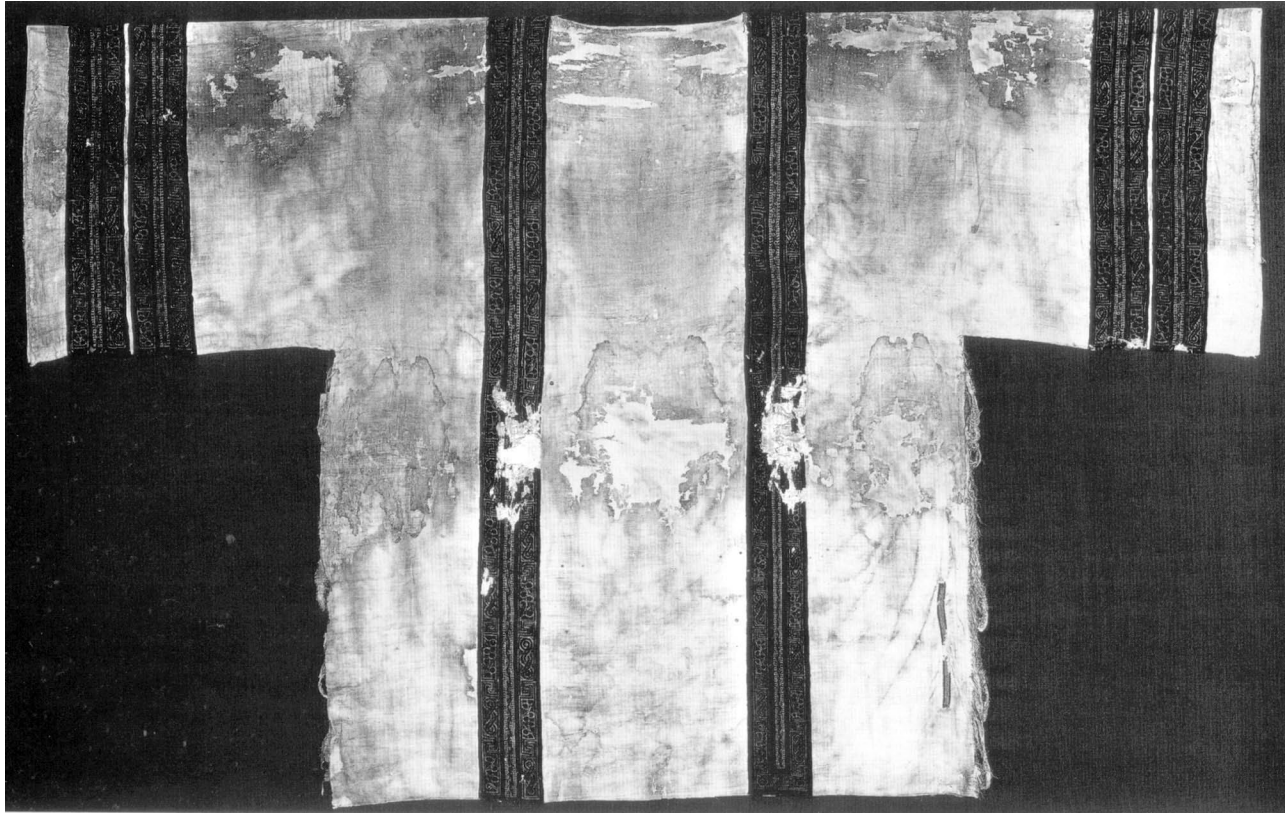
24. See, for example, *P. Oxy.* VII 1051 (3rd century AD): *δ.* of one Cyrillous; *P. Kell.* I 7, 11 (c. 350 AD): *δ.* for a Harpokration.

25. *P. Coll.* IX 247, 247 (324/25 or 325/26 AD).

26. *P. Oxy.* VII 1051, 2-3 and 16 (3rd century AD): *δ. λι[νοῦν] ριζόσημον, δ. λινᾶ*; *P. Oxy.* LIV 3764, 12-13 (c. 359 AD): *δ. ταρσικῶν γυναικ(είων)*.

27. *P. Oxy.* XIV 1741, 5 (early 4th century AD) and *P. Oxy.* VII 1026, 10-11 (5th century AD): *δ. ξοῖτιον* – ‘of the wool of Xoïs’. On this expression see Mossakowska-Gaubert 2006, 178-179.

28. *P. Oxy.* VII 1051, 2-3 (3rd century AD): *δ. λι[νοῦν] ριζόσημον*.



**Figure 6.** Roomy tunic, with wide sleeves (Panopolis; late 3rd-early 4th century AD). After Kendrick 1920, pl. I, no. 1, photo © Victoria and Albert Museum.

**καμίσιον, ὑποκαμίσιον (καμάσον, καμάσιον, *camisa, camisia*)<sup>29</sup>**

It is not established from which language this term comes: certain linguists have tried to find its origins in the Germanic languages *via* the Celtic languages.<sup>30</sup>

It seems that this term appears simultaneously in the Latin<sup>31</sup> and Greek<sup>32</sup> literature towards the end of 4th century. In the 6th century, the term ὑποκαμίσιον

makes its appearance. The words καμίσιον and ὑποκαμίσιον passed into the Coptic language (ΚΑΜΙΣΙΟΝ, ΚΑΜΙΣΙΑ,<sup>33</sup> ΣΥΠΟΚΑΜΙΣΙΟΝ<sup>34</sup>). Later, the καμίσιον term would be adopted, probably *via* the Aramaic, by the Arabic: *qamīṣ*.<sup>35</sup>

The meaning of the *camisia* / καμίσιον term is also not clear. In a letter to Fabiola written in 395-397 AD, Jerome compares a sacerdotal tunic, very close-fitting, with a *camisa* in linen worn by soldiers

29. Regarding this term, see, for example, Wild 1968, 221-222; Kramer 1994; O'Callaghan 1996; Schmelz 2002, 118-119. I thank Adel Sidarous for his remarks on this subject.

30. Walde & Hofmann 1938, *s.v.*; Chantraine 1968, *s.v.*; Ernout & Meillet 2001, *s.v.*

31. Jerome, *Letter to Fabiola* (395-397 AD), 64, 11. Regarding the date cf. Jérôme, *Lettres*, ed. J. Labourt, vol. III, *Les Belles Lettres*, Paris 1953, 227.

32. Firstly, under the form of καμάσιον: see, for example, Gregory of Nazianze (381 AD), 'Testamentum' in *Iuris ecclesiastici Graecorum historia et monumenta*, ed. J. B. Pitra, vol. 2, Rome 1868, 158, l. 7, 9, 11. In the 5th century, this word had taken the form καμίσιον (see Palladius, *Historia Lausiaca*, 65,4).

33. Regarding the other forms, cf. Förster 2002, *s.v.* καμίσιον. Also see Boud'hors 1997, 24-25.

34. Förster 2002, *s.v.* ὑποκαμίσιον.

35. Frankel 1886, 44-45 – *non vid.*



– which was a garment with sleeves, moulded to the body.<sup>36</sup> In *Historia Lausiaca* of Palladius (second decade of the 5th century) this term indicates a kind of tunic or an ‘undergarment’ worn by an imperial civil servant.<sup>37</sup> According to the texts of the 5th–6th century AD, a ‘hair shirt’ called a *καμίσιον* was sometimes worn by the monks.<sup>38</sup> In the *Chronicon Paschale* of the 7th century AD, the *καμίσιον* is a military garment.<sup>39</sup> Finally, Isidore of Seville explains in his *Etymologiae*, that a *camisia* is a garment for sleeping, as well as a liturgical vestment.<sup>40</sup> We recall that Paul the Deacon (8th century AD) in his epitome of the text *De significatione verborum*, written by Festus Grammaticus (end of the 2nd century AD), identifies the *camisia*<sup>41</sup> with the *supparus*<sup>42</sup> – a female linen garment, identified in its turn with the *subucula*<sup>43</sup> – a garment worn under another piece of clothing.

In the 6th century, the term *ὑποκαμίσιον*<sup>44</sup> appears in the Greek texts, but the relation between the *καμίσιον* and the *ὑποκαμίσιον* remains obscure. Was the *ὑποκαμίσιον* a garment which one put under a

*καμίσιον* – as suggested by the prefix *ὑπο-*? Or else, was this a garment of the same form as the *καμίσιον*, but worn under the *καμίσιον* as well as other clothing, and thus an ‘undergarment’? The word *ὑποκαμίσιον* is used in papyrological documents to the early 8th century.<sup>45</sup>

With regard to the Greek papyrological documents, the *καμίσιον* term, sometimes in the form *καμάσιον*<sup>46</sup> or *καμάσον*,<sup>47</sup> appears in the Greek papyri at the beginning of the 4th century and it is attested until the beginning of 8th century. However, an abbreviation *καμ(ι)* exists in a document dated from the end of the 2nd–beginning of the 3rd century AD and has been interpreted by editors as *καμί(σια)*.<sup>48</sup> As with other evidence of this term found in the papyri are dated from the 4th century AD and later, it either concerns the first mention of this term in the Greek language, or this reading must be called into question. The *καμάσια* quoted in the papyri were made in linen,<sup>49</sup> perhaps in cotton,<sup>50</sup> and in wool or with decorative motifs executed in wool.<sup>51</sup> Some documents contain other indications about this clothing: the attestations

36. 64, 11: [...] *solent militantes habere lineas, quas camisas vocant, sic aptas membris et adstrictas corporibus ut expediti sint vel ad cursum vel ad proellia [...]. Ergo et sacerdotes parati in ministerium utuntur hac tunica [...].*

37. *HL* 65, 4.

38. Egyptian monks: Apoph. 80 (Ars. 42 = Sys. XV 11/10); Moschus, *Pratum spirituale*, 126 (*PG* 87, 3, col. 2988 B).

39. 394 (*PG* 92, 1012A).

40. Isidore of Seville, *Etym.* XIX 21, 1; 22, 29.

41. See the edition of Festus in J. W. Pirie & W. M. Lindsay (eds.) *Glossaria Latina, IV: Placidus, Festus*. Paris 1930, F 310 (p. 407): *Supparus vestimentum puellare lineum quod et subucula, id est camisia, dicitur*. Regarding the epitome of Festus made by Paul the Deacon, see for example Woods 2007.

42. With regard to the term *supparus* cf. for example, Wilson 1938, 164–165; Potthoff 1992, 186–190.

43. On the word *subucula* cf. for example, Wilson 1938, 164–165; Potthoff 1992, 184–185.

44. See, for example, Moschus, *Pratum spirituale* 186 (*PG* 87, 3064B); Leontius of Neapolis, *Life of John the Almsgiver*, XIX, 67.

45. See, for example, *SPP* XX 245, 21 (6th century AD); *P. Apol.* 104, 2 (end of the 6th century or second half of the 7th century); *P. Wash. Univ.* II 104, 16 and 19 (6th–7th century AD); *P. Berl. Sarisch.* 22, 1 (7th century).

46. *P. Iand.* VI 125, 2 (4th century AD); *P. Heid.* VII 406, 4, 47 (4th–5th century AD); *P. Princ.* II 82, 41 (481 AD).

47. See, for example, *P. Gen.* I 80, 1 (4th century AD?): *κάμασα δ* – regarding this reading cf. *BL* VIII p. 135.

48. *SB* XXIV 15922, 31 – *editio princeps*: Pintaudi, Sijpesteijn 1996–1997, 193. On the dating of this text, see the well-founded arguments in Pintaudi, Sijpesteijn 1996–1997, 179.

49. *P. Rasin. Cent.* 157, 1 (6th century AD?); *BGU* II 550, 2 (Arabic period).

50. *P. Heid.* IV 333, v. 28 (5th century AD): *καρπάσια καμάσια*. On the adjective *καρπάσιον* understood as ‘in flax’, resulting from the substantive *κάρπασος* cf. D. Hagedorn, *Byzantinischer Brief aus Samaritanischem Medium. In Griechische Text der Heidelberger Papyrus-Sammlung (P. Heid. IV)*, Heidelberg 1986, 234. The name *κάρπασος*, however, could also indicate cotton (cf. *LSJ* s.v. *κάρπασος*), therefore it is also probably that this text is recording a cotton garment.

51. *P. Apol.* 104, 16 (end of the 6th century or second half of the 7th century): *μαλλωτ(ᾶ) κ*. Regarding the different ways in which one can understand the adjective *μαλλωτός* cf. Diethart 1989, 113–114 and Russo 2004, 140 and 141.

of καμίσιον worn by men<sup>52</sup> are more numerous than those of a καμίσιον worn by women.<sup>53</sup>

An analysis of written sources makes it possible to conclude that the καμίσιον term indicated a garment worn directly on the body and that it probably had the shape of a tunic with sleeves. Since the word καμίσιον is found in some texts beside the terms κολόβιον, στιχάριον, δαλματική<sup>54</sup> or χιτών,<sup>55</sup> this inevitably indicated different tunics. It seems that the καμίσιον was worn either like an ‘under tunic’ or ‘undergarment’ by both the laity and the soldiers, being as well a liturgical vestment, or again, like a ‘night-dress’. The appearance of the word ὑποκαμίσιον in the 6th century in Greek texts could suggest that the καμίσιον no longer qualified as a type of clothing worn under another garment, this role henceforth being allocated to the ὑποκαμίσιον.

Representations of tunics worn under another tunic are frequent in the Roman and late Roman epochs.<sup>56</sup> These ‘under-tunics’ appear at the neck edge and/or the sleeves of the tunic which is on top; they are always white or of a natural color, and are without decoration or with *clavi*, or with simple motifs around the neck – notably those belonging to women. The archaeological material of Egypt shows these tunics without decoration, and with tight sleeves. It seems that the garments of this type could be worn under an upper tunic.<sup>57</sup>

Johannes Kramer proposed identifying the

καμίσιον / *camisia* with the tunics with tight sleeves, worn by ‘barbarians’, such as those represented, for example, on Trajan’s Column.<sup>58</sup> But in all likelihood, the word in question did not appear in the Latin vocabulary, and in all probability, Greek, until the 4th century. Consequently, at the beginning of the 2nd century, another name was most probably given to clothes of this type (for example, *tunica manica* and χιτών χειριδότης or another name). However, one cannot exclude, at least in Greek, that starting from the 6th century AD the word καμίσιον indicates a kind of cut tunic, short and tight, with long sleeves, perhaps worn above trousers, as in the Persian Sassanid fashion. We know some representations of such tunics in particular from the Eastern part of the Mediterranean;<sup>59</sup> these tunics also appear in the archaeological material coming from Egypt (fig. 7).<sup>60</sup> These are, however, only assumptions.

Despite all the attestations of καμίσιον / *camisia* or ὑποκαμίσιον, and in spite of the iconographic and archaeological richness of the material, a question remains: do these terms designate the particular form or the function of a specific garment?

### κολόβιον<sup>61</sup>

The word κολόβιον was probably derived from the adjective κολοβός, which indicates “truncated”,

52. See, for example, *P. Ant.* II 96, 17 (6th century AD): κ. of a certain Menas; *P. Mich.* XV 740, 6 (6th century AD): κ. for a worker; *SB* XVIII 13750, 3, 4 (7th century AD): κ. τοῦ κυρ(ί)ου; *P. Lond.* IV 1352, 4, 10, 14 (710 AD): an order for an army’s necessities (?).

53. *BGU* II 550 (= *SPP* III 241), 2 (Arabic period) – a certain Euodia.

54. Gregory of Nazianze ‘*Testamentum*’ (*op. cit.* see note 32), p. 158, l. 7, 9, 1. See also the papyrological documents: *P. Princ.* II 82, 41 (481 AD); *P. Heid.* VII 406 (4th-5th century AD); *P. Berl. Sarisch.* 21 (5th-6th century AD); *P. Mich.* XIV 684 (6th century AD); *SPP* III 83 (6th century AD); *SPP* XX 245 (6th century AD); *P. Prag.* I 93 (6th century AD).

55. Apoph. 80 (Ars. 42 = Sys. XV 11/10).

56. See the following examples:

*Rome*: Deckers et al. 1991, color figure 21: painting with a representation of an orante (first decades of the 4th century AD).

*Sicily*: Carandini, Ricci & de Vos 1982, folio XXIV, 30. 53: mosaic representing hunters, Piazza Armerina (4th century AD).

*Egypt*: Walker & Bierbrier 1997, 99, no. 91: painting on wood with a portrait of a woman, Fayoum (c. 170-190 AD); Walker & Bierbrier 1997, 159, no. 178: painting on wood with a portrait of a woman, Thebes? (c. 220-250 AD).

57. See, for example, Bruwier 1997, no. 10; provenance unknown (4th-5th century AD?).

58. Kramer 1994, 140. For the representations of Dacians on Trajan’s Column in close-fitting tunics, see Settis et al. 1988, e.g., plates nos 21 (XVIII, 41-43); 31 (XXIV, 61-63); 39 (XXXI-XXXII, 75-77); 117 (LXX-LXXI, 179-181) and others.

59. See, for example, Piccirillo 1993, 138-139, fig. 169: mosaic – hunter on a horse. Jordan, Mont Nebo, *diaconicon* in the basilica (530 AD); Piccirillo 1993, 152, fig. 201: mosaic – hunter, Jordan, Mont Nebo, church of Saints and Martyrs Lot and Procopius (557 AD).

60. See, for example, Tilke 1923, no. 28: provenance unknown (6th century AD); Fluck, Linscheid & Merz 2000, no. 132: provenance unknown (Sassanian period: 6th-early 7th AD?).

61. On this term, see, for example Mau 1900; Wild 1994, 27; Mossakowska-Gaubert 2004, 157-161.



© Antje Voigt-SMB-Museum für Byzantinische Kunst

**Figure 7.** Tunic sewn from several pieces (provenance unknown; Sassanid period). Photo: Antje Voigt © Skulpturensammlung und Museum für Byzantinische Kunst – Staatliche Museen zu Berlin, Inv. 9935.

‘shortened’ or ‘short’.<sup>62</sup> It became adopted to the Latin language in the form of *colobium*.

The oldest mention of κολόβιον in texts written outside Egypt is in the *Edict* of Diocletian.<sup>63</sup> The word κολόβιον/*colobium* is attested in the literature in particular in the texts concerning the Egyptian<sup>64</sup> and Palestinian<sup>65</sup> monks. It also appears, though much

more rarely, in other texts which do not have a monastic character.<sup>66</sup> It signified a tunic without sleeves or with short sleeves, sometimes identified with a λεβίτων.<sup>67</sup>

They belong especially to men who work physically, who are depicted during Late Antiquity dressed in a tunic without sleeves<sup>68</sup> or, more often, with short

62. Chantraine 1968, s.v. κόλοβος.

63. *Ed. Diocl.* XXVI, 39, 49, 59 and 72: δαλματικῶν ἀνδρῶν ἤτοι κολοβίων φόπμης ... κτλ.

64. See, for example, Pachom, *Praecepta - fragmenta graeca*, LXXXI (32) 26 (Lefort 1924, 17); *Historia Monachorum* VIII 6; *Ad Castorem* 1, 6 (PG 28, col. 856 D); Apoph. 559 (Nist. 4); John Cassian, *Inst.* I, 4; Moschus, *Pratum spirituale*, 124 (PG 87, 3, col. 2985 C); Anastasius of Sinai [attributed to], *Tales of the Sinai Fathers*, ed. Nau 1902-1903, XXXI, 22. For the *colobium* in the monastic costume, see, for example, Mossakowska-Gaubert 2004, 157-161.

65. Isaïe, *Asceticon*, VI 5F i, r. ξ; Barsanuphius and Jean, *Questions and Answers*, 53, 4-5, 13-1; 326, 12, 13; Dorotheus of Gaza, *Instr.* I 15, 5-6; I 15, 14; Cyril of Scythopolis, *V. Euthymii*, l. 73; Moschus, *Pratum spirituale* 92 (PG 87, 3, col. 2949-2952C-D).

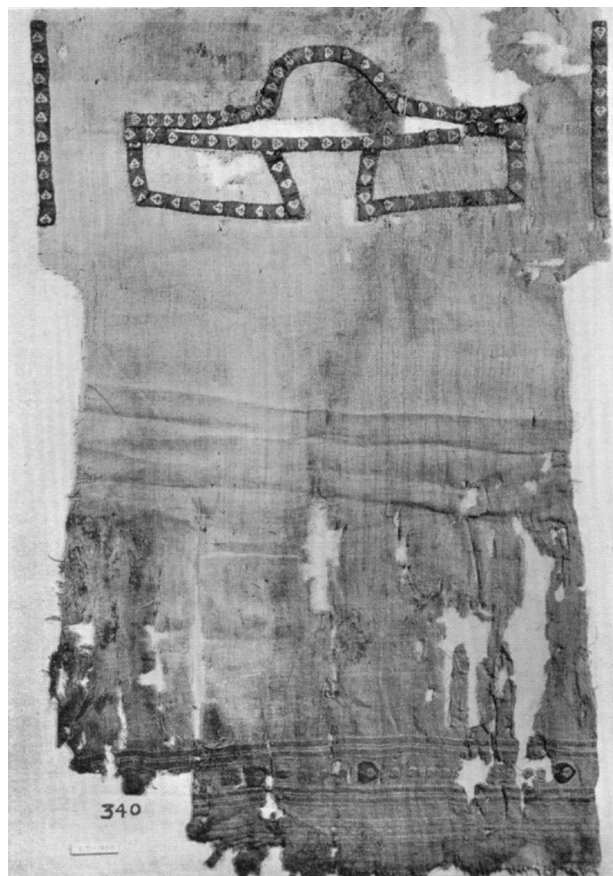
66. See, for example, Epiphanius of Salamis (315-403 AD) I, 1 XV (PG 41, col. 245A). See also, Servius Maurus Honoratus (late 4th century AD), *In Vergilii carmina commentarii*, *Aen.* IX, 613; Isidor of Seville (early 7th century AD), *Etym.*, 19, 22, 24.

67. Pachom, *Praecepta - fragmenta graeca*, LXXXI (32) 26 (Lefort 1924, 17); *Historia Monachorum* VIII 6.

68. See, for example, Piccirillo 1993, 173, fig. 224: fragment of a mosaic with a representation of a gardener, chapel of the priest Jean, Wadi ‘Afrit, Jordan (565 AD).

sleeves.<sup>69</sup> We also know of tunics of this type (fig. 8) coming from Egypt and elsewhere.<sup>70</sup>

The word *κολόβιον* / *κολόβιν* which indicates a tunic appears in some inscriptions from Dura Europos, dated to about AD 235-240<sup>71</sup> and from the same period in the papyrological texts from Egypt.<sup>72</sup> It is mostly present in the papyrological documents of the 4th and 5th centuries, only to disappear during the 6th century.<sup>73</sup> The word *κολόβιον* could both indicate a tunic of a man<sup>74</sup> as well as that of a woman<sup>75</sup>. The *κολόβια* were made either in wool<sup>76</sup> or in linen.<sup>77</sup> In some texts it is a question of a *κολόβιν* with a double



**Figure 8.** Tunic with short sleeves (provenance unknown; 5th-6th centuries AD). After Kendrick 1921, no. 340, photo © Victoria and Albert Museum.

69. See the following examples:

*Rome:* Deckers et al. 1991, coloured figure no. 20: the Good Shepherd (?), catacomb of the Via Anapo (two first decades of the 4th century); Nicolai, Bisconti & Mazzoleni 2000, 114, fig. 131: mural painting with a representation of some coopers, catacomb of Priscilla (3rd-4th century AD?).

*Egypt:* Dunand 1990, 222, no. 610: terracotta figure of a coachman (?); Antioe (3rd-4th century AD).

70. See the following examples:

*Egypt:* Kendrick 1921, pl. XIV, no. 340: tunic with short sleeves; provenance unknown (5th-6th century AD); Bruwier 1997, no. 68: tunic without sleeves, provenance unknown (c. 7th century AD); Mannering 2000: tunic A (without sleeves), tunic B (with short, sewn sleeves); the two coming from Mons Claudianus (period of occupation: between the end of the 1st century to the middle of the 3rd century AD); Hodak 2010, no. 157: tunic without sleeves; provenance unknown (3rd-5th century AD).

*Near-East:* De Jonghe & Verheeken-Lammens 1994 and Wild 1994: tunic without sleeves (Near-East, Late Roman period?); Granger Taylor 2000: fig. 13: four little tunics without sleeves, and fig. 14: child's tunic with short sleeves; Khirbet Qazone, Jordan (2nd-3rd century AD).

71. Baur, Rostovtzeff & Bellinger 1933, 93 no. 219, 98 no. 227 – *non vid.*

72. See, for example, *P. Tebt.* II 406, II, 17 (c. 266 AD); *SB* III 7244, 24-26 (middle of the 3rd century AD); *P. Oxy.* VI 921, 6 (3rd century AD); *P. Oxy.* VII 1051, 8-9 (3rd century AD); *P. Oxy.* XLIV 3201, 10 (3rd century AD); *P. Rein.* II 118, 5-11 (late 3rd century AD).

73. The only document for the 6th century AD, where the word *κολόβιον* indicates a vestment, is *P. Iand.* VI 102, 21. In the *P. Cair. Masp.* I 67001 (514 AD), l. 31 *κολόβιον* (l. *κολόβος*) indicates a measure of liquid – cf. Preisigke s.v. *κολόβος* and the commentary of P.M. Meyer in *Griechische Papyri in Museum des Oberhessischen Geschichtsvereins zu Giessen*, Band I, Teubner 1910-1912, 104 [= no. 103, l. 16-17] on this subject.

74. *P. Rein.* II 118, 9-10 (late 3rd century AD): τὸ κ. Κυρίλλ[ης]; *P. Tebt.* II 406, II, 17 (c. 266 AD): an inventory of items left by the deceased Paulus; *O. Wilck.* 1611, 10, 11, 12, 14 (3rd-4th century AD): a list of male names and garments, the purpose of which we ignore.

75. See, for example, *P. Oxy.* VII 1051, 14 (late 3rd-4th century AD): κ. γυνεκῖο[v]; *P. Wash. Univ.* II 97, 4 (5th century AD): κ. γυνηκῖον; *SB* VI 9158, 6 (5th century AD): κ. of a certain Nonna.

76. *P. Oxy.* VI 921, 6 (3rd century AD): κ. σμάλλα – translated by the editors, B.P. Grenfell and A.S. Hunt, as ‘woollen?’ (*The Oxyrhynchus Papyri*, vol. VI, London 1908, 285); *P. Ross. Georg.* III 1, r. 8-9 (3rd century AD): το εραιουον κολωβειν [l. ἐρεοῦν κολόβιον].

77. *P. Tebt.* II 406, II, 17 (c. 266 AD): [...] κ. λινοῦν; *P. Oxy.* VII 1051, 8-9 (3rd century AD): κ. [λιν]οῦν; *P. Oxy.* XLIV 3201, 10 (3rd century AD): κ. λινοῦν [...].

stripe or rather – *clavi*,<sup>78</sup> and in others of a κολόβιν with a stripe,<sup>79</sup> sometimes described as being from a crimson vegetable dye.<sup>80</sup>

**λεβίτων (λεβήτων, λεβητωνάριον, λεβητονάριον, λεβητωνάριον)**<sup>81</sup>

The Greek word λεβίτων was probably borrowed from the Semitic languages.<sup>82</sup> In the Latin language it took the form *lebitonarium*, and it was adopted into the Coptic language in the following forms: ΛΑΒΙΤΕ, ΛΑΒΙΤΟΥ, ΛΕΒΙΤΟΝ, ΛΕΒΙΤΟΥ, ΛΕΒΙΤΩΝ, ΛΕΥΒΙΤΟΝ, ΛΛΕΒΙΤΟΥ and ΛΩΒΙΤΩΝ.<sup>83</sup>

The term λεβίτων / *lebitonarium* appeared in the literature towards the end of the 4th century and it is well attested in the 5th century, only to disappear in the 6th century. The attestations of the term λεβίτων / *lebitonarium* are found in the texts, in

particular, those concerning Egyptian monks<sup>84</sup> and, more rarely, monks from other regions.<sup>85</sup> This tunic did not have sleeves.<sup>86</sup> We have illustrations of Egyptian monks dressed in a tunic without sleeves.<sup>87</sup> Tunics of this type (fig. 9) were also found on the bodies of monks.<sup>88</sup>

Up until now, we know of only three Greek papyrological documents where one could hope to see the word λεβίτων. However, the reading of this word, written each time with an erroneous orthography, is extremely doubtful.<sup>89</sup> Nonetheless, this term is attested, without any ambiguity, in an inscription and in some papyri and ostraca written in Coptic. These documents date from the 4th to the 8th century AD and, in the main, we are sure that they were written in a monastic milieu.<sup>90</sup> Nevertheless, the context of some documents where the word in question is found remains obscure.<sup>91</sup>

78. *P. Tebt.* II 406, II, 17 (c. 266 AD): κ. λινοῦν δ[ι]σημον; *P. Oxy.* VII 1051, 4-5 (3rd century AD): [...] κ. δίσημον[α].

79. *P. Oxy.* XLIV 3201, 2 and 11 (3rd century AD): κ. ἐνσήμ(ου) [...].

80. *P. Oxy.* VII 1051, 5-6 (3rd century AD): κ. [...] [ρίζό]σημον α.

81. Regarding this term see, for example, Mossakowska-Gaubert 2004, 161-163.

82. Cf. Sophocles 1900, s.v. λεβίτων.

83. Förster 2002, s.v. λεβίτων. See also Boud'hors 1997, 25.

84. Pachom (Lat.), *Praef.* 4 (Boon 1932, 6); *Praec.* 2 (Boon 1932, 13); *Praec.* 67 (Boon 1932, 33); 81 (Boon 1932, 37); Pachom, *Excerpt.* LXXXI (32) 26 (Lefort 1924, 17); *Liber Orsies.* 26 (Boon 1932, 127); *Pachomii vita prima* 14, 113, 134 and 146; Pachom (Gr.), *Paralipomena* IX 29 (ed. Fr. Halkin, *Paralipomena de SS. Pachomo et Theodoro* BHG 1399a, in *Le Corpus Athénien de Saint Pachôme*. Genève 1982, 73-93); *Historia Monachorum* VIII 6 and X 9; Palladius, *Historia Lausiaca* 32, 3; Apoph. 296 (ThP 29); Apoph. 417 (Sys. VI, 8 = JnP 2); Apoph. 439 (Cros 5); Apoph. 585 (Poe 11); Apoph. 926 (Phoc 1); Apoph. 1132 B (N 132 B = Coislins 126, 413, l. 17); Apoph. 1132 D (N 132 D = Coislins 126, 414, l. 12 and 20); Apoph. 1172 (Sys. V, 26 = N 127); Apoph. 1358 (N 358).

85. For the Palestinian monks see, for example: Barsanuphius and Jean, *Questions and Answers*, 326, 14. The word λεβήτων is also present in the Greek tradition from a Syriac text of Ephrem the Syrian: *Capita centum (Quomodo quis humilitatem sibi comparet)* 88, 3. See in addition the *Lexicon* called of Suda (10th century) in which is found an explanation which, in the language of the inhabitants of Prusa (in Bithynia), λεβητωνάριον is a monastic χιτών made of animal hair: *Suidae lexicon*, ed. A. Adler, vol. 1 part. III, Teubner 1933, Λ, p. 242.

86. See Pachom (Lat.), *Praef.* 4 (Boon 1932, 6); *Praec.* 2 (Boon 1932, 13); Pachom, *Excerpt.* LXXXI (32) 26 (Lefort 1924, 17); *Historia Monachorum* VIII 6.

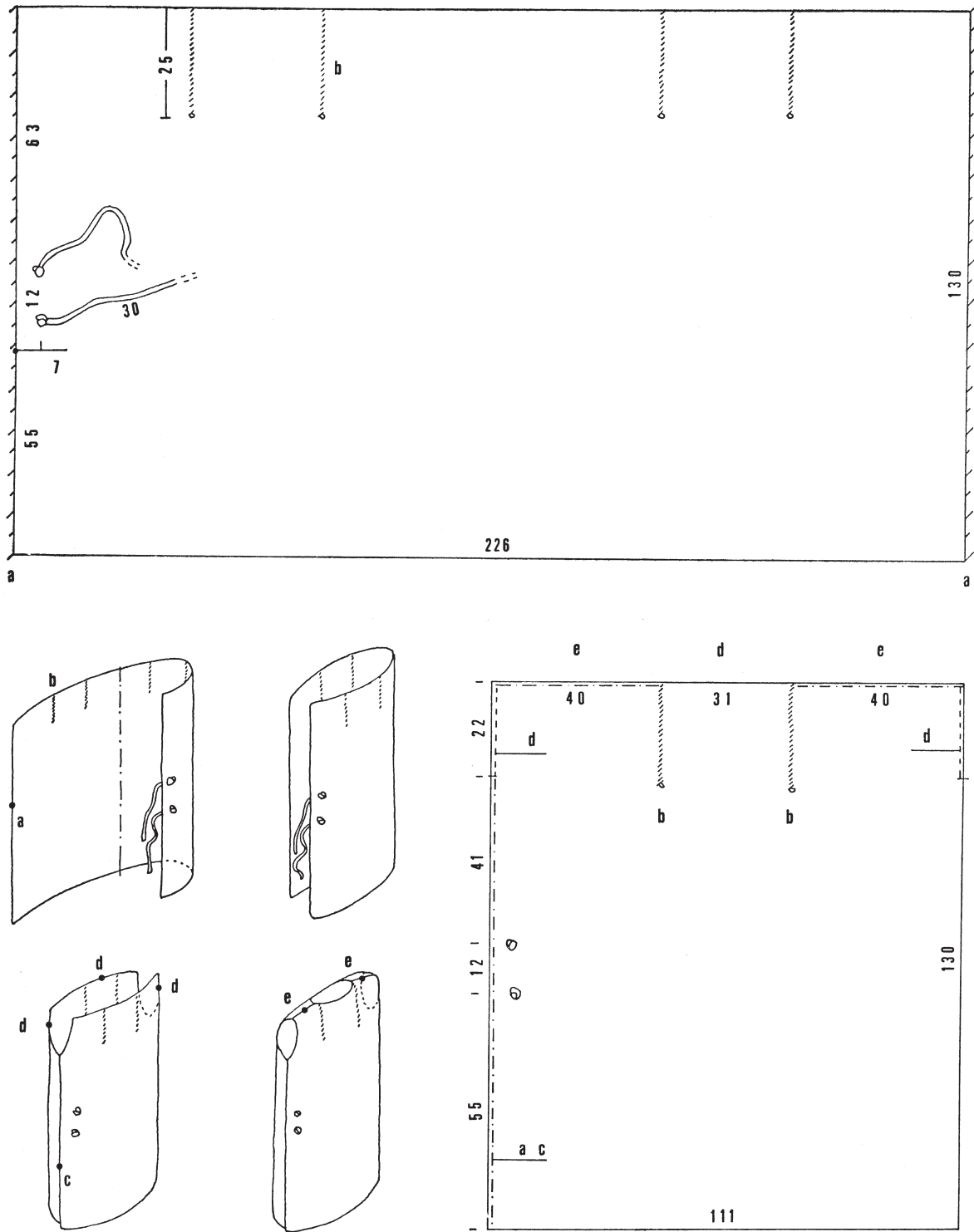
87. See, for example, Sauneron 1972, 14-15; fig. 57: *graffito* representing two monks. Esna, hermitage no. 4 (between around 550 and 630 AD).

88. See, for example, Castel 1979, 139, fig. 12: St-Mark's monastery, Western Thebes (6th-7th century AD); Winlock, Crum 1926, 70-71: *laura* of St-Epiphanius, Western Thebes (second half of the 6th century, up to the first decade of the 8th century); Bechtold 2008: *laura* of Cyriacus, Western Thebes (6th-7th century AD).

89. In all these texts it seems to be an erroneous form either, of the word λεβίτων, or of the word λέβης 'cauldron': *P. Neph.* 12, 14 (in the years 50 and 60 of the 4th century); *P. Bad.* IV 95, 105 (probably 6th century AD); *P. Oxy.* XIV 1683, 22 (late 4th century AD). Two of the first documents had been written in a monastic environment.

90. See, for example, *P. Lond.* VI 1920, 11; *P. Lond.* VI 1922, 5, 11 (c. 330-340 AD); *P. Bal.* II 263, 3 (675-775 AD); *P. Sarga* 161, 10; *P. Sarga* 164, 9 (late 6th - early 8th century AD); *P. Yale Copt.* 1, 32. V, 7, 7 (7th century AD); Heurtel 2004, inscription no. 25 (second half of 7th century AD?).

91. See, for example, *P. Mich. Copt.* 3, 9 (4th-5th century AD); *O. Vind. Copt.* 140, 15 (7th-8th century AD); *O. Crum VC* 118, 14 (7th-8th century AD).



**Figure 9.** Tunic without sleeves (St-Marc monastery, Thebes West; 6th-7th centuries AD). Drawing: Georges Castel © Ifao (Castel 1979, fig. 12).

**στιχάριον**<sup>92</sup>

The word *στιχάριον* is probably a diminutive of *στίχη*,<sup>93</sup> – a word in the *Edict* of Diocletian designating a kind of tunic.<sup>94</sup> In the Latin version it is translated as *strictoria*, which seems to be a neologism indicating a tunic which ‘is tight’ (the verb *stringo*).<sup>95</sup> This word has passed into the Coptic language in the forms: *CTIXA*, *CTIXAPIN*, *CTIXAPION*<sup>96</sup>

In Greek literary texts, the word *στιχάριον* does not appear before the 4th century AD, when it would indicate either a liturgical tunic,<sup>97</sup> or a garment worn by the monks,<sup>98</sup> or an item of the imperial costume,<sup>99</sup> Finally, in the acts of the Synod of Constantinople and Jerusalem (536 AD) there is a passage concerning baptism: those newly baptized (*νεοφωτιστοι*) were barefoot and without their *στιχάρια*.<sup>100</sup>

With regard to the documentary texts of Egypt,

the date of the appearance of the word *στιχάριον* is not certain. The word in question is frequent in the papyrological documents – in particular, from the second half of the 3rd to the 6th century, and it persists until the 8th century AD.<sup>101</sup> However, an word starting with *στ[* is attested in a register of clothing dated earlier than 222 AD, mentioned above,<sup>102</sup> and the term *στιχάριον* is attested in two papyri from Dura Europos, of which oldest goes back to 232 AD.

Given the numerous texts where *στιχάριον* is mentioned beside other terms for tunics, one must admit that it indicates a tunic with long and tight sleeves, different from the *dalamatika*, and quite distinct from all the tunics without sleeves or with only short sleeves.<sup>103</sup>

Images of men dressed in short tunics with tight sleeves are very frequent in the art of late Antiquity,<sup>104</sup> while those with long tunics and long tight sleeves are

92. On this term see, for example, Schmelz 2002, 113-115.

93. Cf. Lampe 1961, s.v. *στιχάριον*; Chantraine 1968, s.v. *σείχω*.

94. *Ed. Diocl.*, 7, 56 and *passim*.

95. Cf. the commentary by S. Lauffer in his edition of the *Edict* (p. 240). See also Souter 1949, s.v. These attestations of the term *stictaria* in the Latin literature are extremely rare; moreover, it may have other meanings as well, such as ‘bandages’: cf. a Latin translation (5th-6th century) of a Greek text of Soranus (2nd century AD), ed. V. Rose, Teubner 1882, p. 16, 11.

96. Förster 2002, s.v. *στιχάριον*.

97. See, for example, Athanasius, *Apologia contra Arianos sive Apologia secunda*, ed. H.-G. Opitz, *Athanasius Werke*, II/1, Berlin 1938, chap. 60, 2: *στιχάρια λίννα* imposed by Athanasius upon the Egyptian clergy. In addition, a *στιχάριον* of Athanasius mentioned by Palladius (*Historia Lausiaca* 63, 2) and one given by Gregory of Nazianze in his testament to Evagrius (*Testamentum*, *op. cit.*, see note no. 31, p. 158, l. 7, 9, 11) were probably also ‘liturgical’, however regarding to the context of these texts, one cannot exclude that there are simple tunics worn in everyday life. About the tunic called a *στιχάριον* worn as a liturgical vestment in Coptic Church, see Innemée 1992, 44-45.

98. See, for example, Leontius of Neapolis, *Life of John the Almsgiver*, XXII 5; Moschus, *Pratum spirituale*, 51 (PG 87, 3, col. 2905 D-2908 A); *ibidem*, 87 (PG 87, 3, col. 2944 D - 2945 A); *ibidem*, 106 (PG 87, 3 col. 2965 A); *Syntagma ad monachos* 6 (PG 28, col. 844 A); *V. Symeon Styl.*, 5, 8; *V. Symeon Styl. Jr.*, 37, 11; 26, 7.

99. For the costume of Justinian see, for example, Joannes Malalas, *Chronographia*, ed. L. Dindorf in *Corpus Scriptorum Historiae Byzantinae*, Bonn 1831, chap. XVII, 413, l. 15 (6th century AD): [...] *στιχάρην δὲ ἄσπρον παραγαυδίν, καὶ αὐτὸ ἔχον χρυσῶ πλουμμία βασιλικά* [...]. This passage is included in *Chronicon Paschale*, vol. I, ed. L. Dindorf in *Corpus Scriptorum Historiae Byzantinae*, Bonn 1832, p. 614, l. 3 (7th century). On *παραγαυδία* cf. e.g.: Lauffer 1971, 265-266.

100. *Acta conciliorum oecumenicorum*, ed. E. Schwartz, vol. III, Berlin 1940, p. 99, l. 31.

101. For the boundaries of the date, see *P. Apoll.* 103 (end of the 3rd or the beginning of the last quarter of the 7th century); *SB VI* 9594, 7 (7th-8th century AD); *P. Leid. Inst.* I 13, 5 and 28 (7th-8th century AD?); *P. Lond.* V 1743, 4 (Arabic period).

102. *SB XXIV* 15922 (late 2nd-early 3rd century AD).

103. However, certain researchers consider that the term *στιχάριον* indicates a tunic without sleeves (see, for example, J. A. Sheridan in his edition of *Columbia Papyri IX. The Vestis Militaris Codex*. ASP 39. Atlanta 1999, 76-77).

104. See the following examples:

*Rome*: Nicolai, Bisconti & Mazzoleni 1998, fig. 158: scribe, catacomb of the Giordani (4th century AD?).

*Sicily*: Carandini, Ricci & de Vos 1982, 29, fig. 12: mosaic with the figure of a soldier; Carandini, Ricci & de Vos 1982, 45, fig. 16: mosaic with a representation of a dignitary and his entourage; Carandini, Ricci & de Vos 213, fig. 118: mosaic representing some workers (?) in the port of Rome; Carandini, Ricci & de Vos 1982, folio XXIV, 30: fig. 53: mosaic representing some hunters; all of these figures come from Piazza Armerina (4th century AD).

*North Africa*: Ben Abed-Ben Khader, de Balanda & Uribe Echeverria 2003, fig. 70: mosaic from the domain of Julius, a nobleman

more rare.<sup>105</sup> It would seem that this latter tunic type is especially worn by women.<sup>106</sup> However, tunics with long and tight sleeves (fig. 10), woven in one or three pieces, are very frequent in the archaeological material coming from Egypt.<sup>107</sup>

In the papyrological documentation, the *στιχάριον* was among the garments generally mentioned in

regard to clothing intended for the army.<sup>108</sup> This term is also present in the documents concerning monastic<sup>109</sup> and liturgical<sup>110</sup> vestments or again 'civil' and 'laic' clothing: the *στιχάριον* was worn by men from all social strata,<sup>111</sup> slaves<sup>112</sup> and children.<sup>113</sup> We note, however, that there are very few authentic mentions of tunics of this type being worn by women.<sup>114</sup>

---

of Carthage – servant, coll. Bardo Museum, Tunis (4th century AD); Ben Abed-Ben Khader, de Balanda & Uribe Echeverria 2003, fig. 152: mosaic of the hunting – horsemen and men on foot, Oudhna, so-called House of the Laberii; coll. Bardo Museum, Tunis (4th century AD).

*Egypt*: Gąsiorowski 1931, Fig. 1: papyrus illustration with a representation of five charioteers, Egypt, Antinoe (c. 500 AD); Rutschowskaya 1990, 52: fragment of cloth with a figure of a boy, provenance unknown (5th century AD); von Falck & Lichtwark 1996, 168, no. 147: representation of a boy on a ceramic container Egypt (6th-7th century AD).

105. See the following examples:

*Greece*: Åkerström-Hougen 1974, coloured fig. 2.2: mosaic with a representation of the months of July and August, Argos (c. 500 AD).

*North Africa*: Ben Abed-Ben Khader, de Balanda & Uribe Echeverria 2003, fig. 217: one of the people in the retinue of a lord, public baths of Sidi Ghrib, presidential palace, Carthage (5th century AD).

*Egypt*: Bosson & Aufrère 1999, 238, no. 61: funerary stela of Hierax and of Tersi, Fayoum (Byzantine period).

106. See the following examples:

*Rome*: Deckers *et al.* 1991, coloured figure 21: painting of an orante (first decade of the 4th century).

*Egypt*: Walker & Bierbrier 1997, 159, no. 178: painting on wood of a portrait of a woman, Thebes? (c. 220-250 AD); Alaoui *et al.* 2000, 125, no. 101: funerary stela for an orante, Egypt (5th century AD); Rutschowskaya 1990, 51: tomb painting – Theodosia, Antinoe (6th century AD).

107. As an example: Dunand & Lichtenberg 1985: embroidered tunic, Douch (middle of the 4th-early 5th century AD); Bruwier 1997, no. 84: unknown source (middle of the 6th - middle of the 7th century AD); no 85: unknown source (6th century AD?); Fluck, Linscheid & Merz 2000, no. 112: Antinoopolis (6th-8th century AD); no. 124: Sohag (7th-9th century AD); Benazeth & Rutschowskaya 2009, no. 75: unknown source (6th-7th century AD).

108. See, for example, *P. Michael*. 21, 4, 9 (285 AD?) – cf. *BL V*, p. 68; *SPP XX* 75, 26 (3rd-4th century AD); *P. Oxy.* XLIV 3191 col. I, 3 (302 AD) – cf. the commentary on l. 2-3; *SB I* 4421, 9-10 (302 AD – regarding the dating cf. *BL VII*, p. 184); *P. Cair. Isid.* 54, 8, 10 (314 AD) = *SB VI* 9071; *P. Cair. Isid.* 72, 16 (314 AD); *P. Oxy.* XII 1448 (c. 318 AD); *P. Oxy.* XII 1424, 7 (c. 318 AD); *P. Oxy.* XLIV 3194, 9, 12 (323 AD); *P. Ant.* I 39, 8 (323 AD) – regarding the dating cf. *BL IV*, p. 2); *P. Coll.* IX, 247 = *SB XX* 14661 (324-327 AD); *P. Oxy.* LI 3621, 16 (329 AD); *BGU I* 21, col. II 16 (340 AD); *P. Beatty Panop.* 2, 20, 21, 26 (340 AD); *P. Panop.* 19, I (c) 2, (e) 2; X (b) 3; IV (a) 2-3, (b) 2, (d) 2 (339-346 AD); *P. Oxy.* LXI 4128, 23 (346 AD); *SPP XX* 92, 1, 2 (348 AD – regarding the date cf. *BL V*, p. 144); *P. Lips.* I 59, 13 (371 AD); *P. Lips.* I 60, 14 (after about 371 AD); *BGU III* 620, 9 = *Chr. Wilck.* I 186 (4th century AD); *P. Köln IV* 190 (4th century AD); *P. U.G.* I 24 (4th century AD) = *SB X* 10258; *P. Warr.* 7, 9 (4th century AD) = *SB V* 7536; *SB VI* 9305, 6, 7 (4th century AD); *P. Oxy.* LXII 4348, 8, 9 (4th century AD); *PSI XII* 1264, 9 (4th century AD); *P. Oxy.* XVI 1905, 4, 6 (late 4th-early 5th century AD); *P. Oxy.* VIII 1136, 4, 5 (420 AD); *SB VI* 9306, 4 (5th century AD); *P. Vind. Tandem* 19, 4 (5th-6th century AD). On the *annona militaris* and the imperial fiscal system, see Mitthof 2001. Regarding the representations of Roman soldiers stationed in Egypt in the Late Roman epoch, cf. Paetz gen. Schieck 2012.

109. *P. Heid.* VII 406, 12 and 37-38 (4th-5th century AD); *P. Berl. Sarisch.* 21; 48 (5th-6th century AD); *P. Stras.* VIII 719, 7 (5th-6th century AD); *P. Paramone* 14, 7 (6th-7th century AD); *SB III* 6024 (7th century AD?).

110. *P. Leid. Inst.* I 13 (7th-8th century AD?): inventory of a monastic church (?); *P. Apoll.* 103, 1 (end of the 3rd or beginning of the the last quarter of the 7th century).

111. See, for example, *P. Cair. Isid.* 132, 8-9, 13 (3rd century AD): σ. for one Hêrôkas; *P. Ryl.* IV 627, 2, 10 (early 4th century AD): σ. of Theophanes; *P. Oxy.* XIV 1775, 14 (4th century AD): σ. for a person named Ploutarchos; *PSI IX* 1082, 13 (4th century AD?) σ. of a ἀδελφός Ἀμμ[...]; *P. Oxy.* LIX 4004, 13-14 (5th century AD): σ. of a Nathanaël.

112. See, for example, *P. Oxy.* LI 3616, 3 (3rd century AD?): σ. of a δοῦλος Φίλιππος.

113. See, for example, *P. U.G.* I 28, 4 (5th-6th century AD): σ. παιδ[ια]κά.

114. See, for example, *P. Oxy.* VII 1051, 7 (3rd century AD): inventory of the business affairs of a certain Kyriolloutos; *P. Oxy.* LIX 4004, 14, 15 (5th century AD): σ. belonging to women named Syncletikê and Kyra; two marriage contracts: *P. Dura* I 30 (232 AD) and *P. Cair. Masp.* I 67006, 64, 83, 84 (6th century AD).





**Figure 10.** Tunic with long sleeves (provenance unknown; 6th-7th century AD). Photo: Georges Poncet © Musée du Louvre, no. AF 12190.

The *στιχάρια* could be made either in linen,<sup>115</sup> or out of wool<sup>116</sup> or even with a mixture of linen and wool: *λινόπιξον*.<sup>117</sup>

**χιτών (χιθών, χιτώνιον, κιθών, κιτώνιον)**<sup>118</sup>

The *χιτών* term is probably of Semitic origin. In a general sense, it indicated a ‘tunic’, and in particular a

115. See, for example, *P. Oxy.* VII 1051, 7-8 (3rd century AD): σ. [λιν]οῦν; *SB* III 6222, 27 (late 3rd century AD): σ. λινούν; *P. Oxy.* LIV 3776, 24, 47 (343 AD): declaration of a price for σ. in linen; *SPP* XX 92, 1, 2 (348 AD): σ. λινῶν; *PSI* IV 287, 15 (377 AD): σ. λινῶν; *SB* V 7536, 9 (4th century AD): σ. λινούν; *SB* VI 9305, 6-7 (4th century AD): σ. λινῶ; *P. Oxy.* XLVIII 3426, 10 (4th century AD): σ. λινῶν; *P. Oxy.* LXII 4348, 9 (4th century AD): σ. λινῶν; *SPP* X 188, 3 (4th century AD): σ. λινού; *P. Oxy.* LVI 3860, 29 (late 4th century AD): τὸ σ. τὸ λινούν; *P. Oxy.* XVI 1905, 6 (late 4th century AD or early 5th century AD): σ. λινούν.

*Ταρσικά:* *P. Panop.* 19, IV (a) 2-3; (b) 2; VI (b) 2, (d) 2 (339-346 AD); *P. Beatty Panop.* I 2, 20, 21, 26 (340 AD); *P. Stras.* IV 246, 6 (c. 380 AD); *P. Vind. Tandem* 19, 4 (5th-6th century AD). On the garments designated as *ταρσικά* and the artisans *ταρσικάριοι* cf. Wipszycka 1965, 110-112; Wild 1969; Mossakowska-Gaubert 2006, 177-178.

116. See, for example, *P. Oxy.* LI 3616, 3 (3rd century AD?): σ. ἔρεθ[ῶ]ν; *P. Oxy.* XLIV 3194, 9, 12-13 (323 AD): σ. ἔρεθῶν; *SB* VI 9305, 6-7 (4th century AD): σ. ἔρεθῶν δλωρόν; *P. Vars.* 26, 18 (4th - 5th century AD): τὰ ἐρεῖ σ. (cf. *BL* III, p. 254); *P. Oxy.* LIX 4004, 13-15 (5th century AD): among garments that had been fulled, there were some *στιχάρια*.

117. *P. Mich.* XIV 684, 8 (6th century AD) and perhaps, if the restoration of a lacune is well-chosen, in the *P. Wash. Univ.* II 97, 12 (5th century AD). On the *tunica pexa* (‘soft-finished tunic’ made out of wool) cf. Wild 1967, 133-134; Lauffer 1971, 269 (20, 12).

118. On this term, see for example, Amelung 1899; Blum 1919; Descamps-Lequime 1988, 93-94; Mossakowska-Gaubert 2004, 163-166.

‘tunic without sleeves’. The word χιτών is extremely frequent in Greek literature, from Homer to the 4th century AD. To indicate the tunics with sewn sleeves, worn by foreign people, one used the expression χειριδότης χιτών.<sup>119</sup> Starting from the 5th century AD, the word χιτών becomes rare in the texts dealing with contemporary events,<sup>120</sup> while still remaining present in the commentaries on older texts or in the literature inspired by these texts,<sup>121</sup> and in works having a lexicographical character.<sup>122</sup> Furthermore, Sozomen mentions χιτῶνες ἀχειριδῶτοι<sup>123</sup> (‘tunics without sleeves’) – surely to distinguish them from others χιτῶνες – ‘with sleeves’.

In the papyrological documents, the term χιτών is attested at the beginning of the Ptolemaic period and it meant a tunic without sleeves. However, to indicate a tunic with ‘true sleeves’, coming from the local tradition, the documents of the Ptolemaic period used the same expression as in classical literature: χειριδότης χιτών.<sup>124</sup>

From the 3rd century AD, when tunics with ‘true’ long sleeves would spread in Egypt and in all the Mediterranean, the word χιτών is always very common in the papyrological texts. It is mentioned in several documents beside other terms for tunics, either with sleeves (δαλματική,<sup>125</sup> στιχάριον<sup>126</sup>), or without sleeves or with short sleeves (κολόβιον).<sup>127</sup> It seems that the word χιτών maintained its most elementary meaning (*i.e.*, ‘tunic without sleeves’) in these texts. The question of the difference between χιτών and κολόβιον should be asked at this point. One can suppose that this difference was visually clear in the appearance of these tunics. In this case, it may be that, whenever the two words occurred side by side in a text, χιτών indicated a ‘tunic without sleeves’ and κολόβιον a ‘tunic with short sleeves’.

The word χιτών is still attested in documents of the 4th century AD,<sup>128</sup> and then disappears. The

119. See, for example, Herodotus VII 61 (Persians); Strabo IV 4, 3 (Gauls), XI 13, 9 (Medes), XV 3, 19 (Persians); Joseph Flavius, *Antiquitates Jud.*, VII, 171 (Jews); Cassius Dio 49, 36 (Pannonians).

120. See, for example, Zosimus (second half of the 5th century AD), *Historia Nova* V, 32, 5, 7; Procopius of Caesarea (6th century AD), *De bellis* III, 25, 7. See also those texts concerning the Egyptian monks: Palladius, *Historia Lausiaca* 47, 3 (420 AD); Sozomen, *Ecclesiastical History* III 14, 7 and 13 (the forties of the 5th century); Apoph. 80 (Ars. 42 = Sys. XV 11/10); Apoph. 180 (Fel. 5) (5th century AD).

121. See, for example, *Catena in Matthaem* (post 5th century AD), 30; John of Damascus (7th-8th century AD), *Orationes de imaginibus tres* III, 87, 12.

122. See, for example, Hesychius (5th century AD), *Lexicon*, χι, [87], *s.v.* χιτῶν and *passim*; Joannes Philoponus (6th century AD), *De vocabulis*, χι, *s.v.* χιτῶν, χιτών.

123. III 14, 7.

124. See, for example, *P. Cair. Zen.* II 59146, 2-3 (256 BC); *P. Cair. Zen.* I 59092, 9-10 (3rd century BC); *P. Cair. Zen.* III 59469, 4-6 (3rd century BC); *P. Tebt.* I 46, 34 (113 BC); *SB VIII* 9680, 3 (2nd half of the 2nd century AD).

125. See, for example, *P. Oxy.* I 114, 5-6 (2nd or 3rd century AD); *SPP XX* 31 II, 16 = *CPR* I 21 (230 AD); *P. Tebt.* II 405, 10 (3rd century AD); *P. Oxy.* XLIV 3201, 8, 9 (3rd century AD); *P. Mich.* III 218, 14 [?] (296 AD); *P. Oxy.* XX 2273, 12 (late 3rd century AD); *PSI VIII* 900, 7 (3rd-4th century AD); *P. Flor.* III 371, 7 (4th century AD).

126. See, for example, *P. Oxy.* XX 2282, 12-13 (late 3rd century AD); *P. Prag.* II 176, 6 (3rd-4th century AD).

127. See, for example, *P. Tebt.* II 406 (266 AD); *P. Oxy.* XLIV 3201, 2, 10, 11 (3rd century AD).

128. See, for example, *P. Oxy.* I 109, 13, 17, 19 (late 3rd-4th century AD); *P. Oxy.* XIV 1645, 10 (308 AD); *P. Kell.* I 65, 33 (early 4th century AD); *P. Kell.* I 66, 24 and 25 (early 4th century AD); *SB XIV* 11983, col. III 63 (c. 350 AD) = *P. Lond.* II 429; *P. Kell.* I 74, 10 (middle of the 4th century AD); *P. Flor.* III 371, 2-3 (4th century AD); *P. Münch.* III 126, 5 (4th century AD); *SB VIII* 9834 b, r. 8, 11 v. 47, 49 (4th century AD).

χιτών was worn by men<sup>129</sup> as well as women<sup>130</sup> and by children of both sexes.<sup>131</sup> The χιτών could be made of linen,<sup>132</sup> wool,<sup>133</sup> more rarely of cotton<sup>134</sup> or βύσσος<sup>135</sup> (fine linen or cotton).<sup>136</sup>

### Words derived from terms designating tunics

The papyrological texts offer many examples of words created from terms designating tunics. Most of the cases concern a tunic together with another item of clothing: μαφόριον, καρακάλλιον, φελόνιον.

In one case, the word combines the terms designating two different tunics: στιχαροκόλοβιον.

### Words composed with the term μαφόριον

The word μαφόριον<sup>137</sup> is attested in the literary texts from the 3rd century – or, at the latest, at the beginning of the 4th century AD, whereas in the papyrological texts it already appeared in the 2nd century AD, – only to disappear in the course of the 7th century AD. It indicated a shawl worn by women as well

129. See, for example, *P. Cair. Zen.* I 59087, 3-4 (258-257 BC): χ. belonging to Helenos; *P. Petr.2 Will.* 13, 18 (238-237 BC): χ. ἀνδρείου; *P. Yale* I 42, 13 (229 BC?) = *SB VI* 9259: χ. belonging to Nechthosiris; *P. Lille* I 6, 8, 24 (3rd century BC): χ. belonging to Petesuchos; *PSI VII* 866, 13 (3rd century BC): χ. belonging to Andrikos; *P. Erasm.* I 2, 11 (152 BC): κ. belonging to a Nous and a Horos; *P. Dion.* I 10, 20, 21, 22 (109 BC): κ. belonging to a Sotionchis, a Plenis, and a Papytis; *P. Oxy.* II 285, 11 (c. 50 AD): χ. belonging to a Sarapion; *P. Turner* I 18, 13 (84-96 AD): κ. belonging to a Petronios; *SB XII* 10947, 22-23 (middle of the 1st century AD): κ. belonging to a Heron; *SB VI* 9275, 4-5 (1st-2nd century AD): κ. belonging to an Antonios; *O. Claud.* I 161, 5 (100-120 AD): κ. belonging to an Ailouras; *P. Giss.* I 77, 6 (98-138 AD): κ. belonging to a Teeus; *P. Sarap.* I 1, 16 (125 AD): χ. belonging to a Pamounis; *P. Oxy.* X 1269, 30 (beginning of the 2nd century AD): κ. left by Isas, deceased; *P. Fay.* 108, 17 (c. 171 AD): κ. owned by a Pasiôn; *P. Lund.* VI 1, 13 (2nd century AD): κ. ἀν[δ]ρείος; *SB XII* 10876, 10-11 (2nd century AD): χ. belonging to an Alkibiades; *P. Oxy.* LIX 3991, 13-15 (2nd-3rd century AD): χ. for an Ischyron; *P. Oxy.* VII 1069, 3, 24 (3rd century AD): κ. for a Troilos; *P. Oxy.* LVI 3855, 4 (280/1 AD): κ. for Isidoros; *P. Oxy.* XII 1489, 2-3, 8 (late 3rd century AD): κ. belonging to a Sattos; *P. Kell.* I 65, 33 (early 4th century AD): χ. owned by a Philammon; *P. Flor.* III 371, 2-3 (4th century AD): κ. Owned by an Apollonios.
130. See, for example, *P. Cair. Zen.* I 59087, 17-18, 22, 23 (258-257 BC): χ. for a Satyra; *P. Cair. Zen.* III 59319, 3, 8 (249 BC): χ. γυναικεῖος; *P. Hib.* II 200, 10 (246-222 BC): χ. belonging to a Chrysis; *P. Petr.2 Will.* 13, 18 (238/237 BC): χ. γυναικεῖου; *P. Tebt.* III 894, fr. 9, 3 (c. 114 BC): κ. γυναικεῖος; *P. Tebt.* I 46, 34 (113 BC): χ. γυναικεῖον; *P. Tebt.* I 120, 109 (97 or 64 BC): γυναικεῖου χ.; *P. Mich.* XV 688, 12 (2nd-1st century BC): χ. γυναικεῖον; *P. Ryf.* II 151, 14 (40 AD): χ. belonging to a θυγάτηρ; *P. Tebt.* II 565 (113 AD): γυναικεῖου χ.; *P. Wisc.* II 73, 19-20 (2nd century AD): κ. for a Thermouthis; *P. Oxy.* I 109, 27 (late 3rd-4th century AD): γυναικεῖα χ.
131. See, for example, *P. Cair. Zen.* I 59060, 9 (258/7 or 257/6 BC) = *SB III* 6717: χ. for a young Pyrrhos; *P. Lond.* II 402, v. 14 (152 or 141 BC): χ. παιδα[...]; *P. Tebt.* I 127 (114 BC): χ. παιδικόν; *P. Tebt.* IV 1096, 29 (113 BC): χ. παιδικός; *P. Oxy.* XLI 2971, 27 (66 AD): χ. for a minor Heraklas; *P. Tebt.* II 565 (113 AD): παιδικούς χ.; *P. Tebt.* III 891, 19 (2nd century AD): χ. τῆς μικρᾶς; *P. Oxy.* XLII 3060, 9-10 (2nd century AD): χ. [...] παιδικόν; *P. Heid.* IV 334, 1-2 (2nd century AD?): χ. παιδικῶν; *P. Oxy. Hels.* I 40, *passim* (2nd-3rd century AD): χ. παιδικοί; *P. Mich.* VIII 514, 13 (3rd century AD): κ. τῆ μικρᾶ; *P. Oxy.* XIV 1645, 10 (308 AD): κ. παιδικόν.
132. See, for example, *P. Hib.* II 200, 10 (246-222 BC): χ. λινούν; *P. Coll. Youtie* I 7, 16-17 (224 BC): [...] ἰμάτιον καὶ χ. δύο ἐρε[σθ]ῆ καὶ λινούς [...]; *SB XVI* 12375, col. IV 53 (c. 180 BC): χ. λίνου; *UPZ* I 84, col. I 12 (163/162 BC): κ. λεινοῦν; *P. Oxy.* II 285, 11 (c. 50 AD): χ. λεινοῦν; *P. Oslo* II 56, 3-5 (2nd century AD): χ. λινούς δύο; *P. Mil.* II 76, 6-7 (2nd-3rd century AD): τ[ὸ] λιν[οῦν] κ.; *BGU* III 816, 18-19 (3rd century AD): χ. ἐριοῦν καὶ λινούν; *P. Turn.* I 43, 7-8, 14-15 (3rd century AD): χιτωνία made of a λινούφος.
133. See, for example, *P. Cair. Zen.* II 59176, 251-257 (255 BC): γ[η]ναφεῖ τῆς Ἱεροκλέους χλα[μύδος καὶ χι]τῶνος καὶ ἰματίου κτλ. – the price for the cleaning of clothing at a fuller's, therefore made out of wool; *P. Cair. Zen.* III 59398, 8 (3rd century BC): χ. γνάπτρα (γνάπτρα 'honorarium for a fuller' cf. *P. Cair. Zen.* II 59176); *P. Petr.2 Will.* 13, 18 (238/237 BC): χ. ἐρεοῦ γυναικεῖου; *P. Tebt.* I 120, 109 (97 or 64 BC): τιμὴν ἐρίω(ν) γυναικεῖου χ.; *SB XII* 10947, 22-23 (middle of the 1st century AD): ἐρίων εἰς τὸν κ.; *P. Mert.* II 71, 10-11 (163 AD): κ. λευκοὶ δύο ἄγναφοι; *P. Tebt.* II 406, 14 (266 AD): κ. πρ[ω]τό[γ]ναφον 'cleaned by a fuller'; *BGU* III 816, 18-19 (3rd century AD): χ. ἐριοῦν καὶ λινούν; *P. Oxy.* I 109, 17 (late 3rd-4th century AD): χ. οὐλίριος – the editors, B.P. Grenfell and A.S. Hunt, remarked that the word οὐλίριος is composed of οὐλος and ἔριον (*The Oxyrhynchus Papyri*, vol. I, London 1898, 176); *PSI VIII* 900, v. 11-13 (3rd-4th century AD): πέμ[ψ]ων πόκον ...ιδίων καὶ ποιήσω σοι κιτῶνιν [...].
134. See, for example, *SB VI* 9025, 31 (2nd century AD): [...] Οὐχ εὔρον τὸν χ. τὸν ἐρεόξυλον ὡς ἤθελον [...]; *P. Oxy.* LIX 3991, 13-15 (2nd-3rd century AD): [...] τὸν χ. σοι τὸν ἐρίό[ξ]υλον ἢ μήτηρ σου κ[α]τεσκεύασε [...]. Concerning the meaning of ἐρίόξυλον cf. the commentaries: Winter, *Youtie* 1944, 250 and H.G. Ioannidou, *The Oxyrhynchus Papyri*, vol. LIX, London 1992, 128.
135. See, for example, *P. Cair. Zen.* I 59087, 4, 12, 18, 19, 22, 23, 27 (257 BC) = *SB III* 6783; *BGU VII* 1525, 3 (3rd century BC).
136. Regarding this term cf. Wipszycka 1965, 40-41 and 107-110.
137. Mossakowska 1996.

as by men. This garment was worn on the shoulders, the head, or was sometimes used like a loincloth. The papyrological documentation lists several words derived from μαφόριον and from terms indicating tunics of all kinds.<sup>138</sup>

• **δελματικομαφόριον**

Δελματικομαφόριον refers to a garment made of a tunic with long and wide sleeves, and of a shawl. It is attested in some papyri dated from the 3rd to the 5th century,<sup>139</sup> as in the *Edict* of Diocletian, where it appears in the form δελματικομαφέριον / *dalmaticomaforium*.<sup>140</sup> In the papyri as well as in the *Edict*, this garment was intended for women.

• **κολοβιομαφόριον**

This term is only attested in some papyri, all dated from the 4th - 5th centuries.<sup>141</sup> It designates a tunic without sleeves or with short sleeves in association with a shawl.

• **στιχαρομαφόριον**

The term στιχαρομαφόριον appears in many papyrological documents dated from the 5th to the 7th, and perhaps to the 8th century AD.<sup>142</sup> This garment, made up of a tunic with long and tight

sleeves, combined with a shawl, was worn by women<sup>143</sup> as well as by men.<sup>144</sup>

The commentaries concerning the garment terms composed of the word μαφόριον are numerous. According to one of the hypotheses, the στιχαρομαφόριον term is made up of the adjective στιχαρο-, from στίχος ('striped'), and the noun μαφόριον.<sup>145</sup> However, most researchers consider that στιχαρομαφόριον and other terms – δελματικομαφόριον and κολοβιομαφόριον – are designations of the particular shawls worn with this or that tunic.<sup>146</sup> In accepting this last explanation, a question arises: if the στιχαρομαφόριον were a particular μαφόριον that one put on over the στιχάριον, and if the κολοβιομαφόριον were intended to be worn on over the κολόβιον, while the δελματικομαφόριον accompanied the δελματική, in what way exactly, would these μαφόρια differ from each other and be distinguished from the simple μαφόριον mentioned in the same documents?<sup>147</sup>

It is thus necessary to seek another explanation for these composit terms. It is useful to quote here the note by Friedrich Preisigke on στιχαρομαφόριον: 'ein mit dem Rocke verbundenes Kopftuch, Kapuze (?)',<sup>148</sup> as well as the comment by Siegfried Lauffer on the

138. Cf. Mossakowska 1996, 33-36.

139. *P. Oxy.* X 1273, 12 and 15 (260 AD): marriage contract; *P. Louvre* I 67, 5 (last decade of the 3rd century): private letter; *P. Ross. Georg.* III 28, 10-11 (343 or 358 AD): marriage contract; *SB* XII 11075, 9 (middle of the 5th century AD): given to a young bride.

140. *Ed. Diocl.* 19, 8.

141. See, for example, *P. Heid.* VII 406, 36 (4th-5th century AD); *P. Princ.* II 82, 36 (481 AD).

142. See, for example, *SB* III 7033, 39 (481 AD); *P. Wash. Univ.* I 58, 3, 4 (5th century AD); *P. Cair. Masp.* I 67006, v. 80 (6th century AD); *P. Coll. Youtie* II, 85, 1, 2, 6 (6th century AD); *P. Naqlun I* 11, 6 (6th century AD); *P. Oxy.* XVI 1978 (6th century AD); *SB* XX 14208, 2, 3, 4 (6th century AD); *SPP* XX 275, 6 (6th century AD); *SB* XX 14319, 2 (7th century AD); *P. Leid. Inst.* I 13, 5 (7th-8th century AD?); *SB* III 6024, 2, 3, 7 (date?).

143. See, for example, *P. Cair. Masp.* I 67006, v. 80 (c. 566-570 AD): marriage contract – on the reading of στιχα<ρο>μαφόρια cf. *BL* VIII, 70; *P. Oxy.* XVI 1978 (6th century AD): marriage contract(?).

144. Monks: *SB* XX 14319, 2 (7th century AD); *SB* III 6024, 2, 3, 7 (date ?). Other contexts: *SB* III 7033,39 (481 AD): objects stolen from the house of a deacon; *P. Coll. Youtie* II, 85, 1, 2, 6 (6th century AD): inventory of a church (?), monastic context (?); *P. Leid. Inst.* I 13, 5 (7th-8th century AD?): inventory of monastic church (?).

145. Sijpesteijn 1980.

146. P. van Minnen in F.A.J. Hoogendijk & P. van Minnen, *Papyri, Ostraca, Parchments and Waxed Tablets in the Leiden Papyrological Institute*, Leiden 1991 = *P. Lugd. Bat.* XXV, p. 55: commentary on the text no. 13, l. 5. This solution has been adapted following Montserrat 1992, 83; T. Derda, *P. Naqlun*, Warsaw 1995, 151: commentary on the text no. 11, ll. 6-7, and Schmelz 2002, 115-116.

147. The word μαφόριον in the same text as στιχαρομαφόριον: *SB* III 7033 (481 AD); *SB* XVI 12251 (6th century AD); *SPP* XX 275 (6th century AD); *P. Coll. Youtie* II 85 (6th century AD); as also δελματικομαφόριον: *P. Oxy.* I 114 (2nd or 3rd century AD); *P. Michael.* 18 (middle of the 3rd century AD).

148. Preisigke s.v. στιχαρομαφόριον.

subject of the *dalmaticomaforium*: ‘Ärmelgewand mit Kopfbedeckung’.<sup>149</sup> It seems to us that one can extend these interpretations, by rejecting however the translation ‘hood’ for μαφόριον, to all compounds containing the word μαφόριον: thus we would have different tunics with shawls attached (probably sewn), being used to cover the shoulders or to veil the head.<sup>150</sup> It is true that, until now, no tunic with a shawl stitched to it has been found. On the other hand, there are some examples of tunics with a hood;<sup>151</sup> that gives an idea of how one could attach a small shawl to this garment.

### Other composite terms

#### • στιχαροκολόβιον

This term is attested in a list of clothing from the *dossier* of Dioscorus (*P. Lond.* inv. 0584, 14; 6th century).<sup>152</sup> It is not easy to imagine a combined garment derived from two tunics, one with long sleeves (στιχάριον), the other without sleeves (κολόβιον). Jean-Luc Fournet understands this term as ‘a long tunic without sleeves’. However, another solution appears equally possible: ‘a tunic with ‘true’ short sleeves’ – that is to say, woven in the style of a tunic with long sleeves (στιχάριον), but with the form of a κολόβιον with short sleeves.<sup>153</sup>

#### • στιχαροκαρακάλλιον

In a list of clothing coming from Oxyrhynchos, probably from a monastic context, one mention

is made of two στιχαρ(ο)καρακ(άλλια).<sup>154</sup> The word καρακάλιον is borrowed from Latin *caracalla*.<sup>155</sup> The exact form of a Roman *caracalla* is not clear. It is interpreted by scholars in different, sometimes even contradictory ways: ‘a kind of fur-lined mantle with a hood and sleeves’,<sup>156</sup> ‘type of garment without sleeves and with a hood’,<sup>157</sup> ‘a hooded cape of wool’,<sup>158</sup> or again ‘una veste [...] forse non sempre caratterizzata dal cappuccio, ma spesso fornita di applicazioni decorative multiformi e multicolori’.<sup>159</sup> Considering the state of the sources, it is not impossible that, according to the place and the time, the garment called καρακάλλιον / *caracalla* changed its appearance, while keeping the same name. As for the word στιχαροκαρακάλλιον, it seems possible to us that it meant a tunic with long sleeves provided with a hood (fig. 11), an element which despite certain objections, remains characteristic of a καρακάλλιον.<sup>160</sup>

#### • στιχαροφαιλόδιον

The στιχαροφαιλόδιον term appears in a private letter dated to the 6th century<sup>161</sup>. It is also mentioned as a liturgical vestment in a text attributed wrongly to Sophronius of Jerusalem,<sup>162</sup> as well as in the *Pratum spirituale* of Moschus, like the single habit worn by two ascetics.<sup>163</sup> This garment combines a tunic named στιχάριον and a mantle

149. Lauffer, *Ed. Diocl.* p. 262.

150. On this proposition see Mossakowska 1996, 34-35.

151. For some examples see *infra*, note no. 159.

152. This unpublished document is being studied by Jean-Luc Fournet, whom I warmly thank here for having given me permission to utilise the results of his ongoing research.

153. See, for example, a tunic worn by a Fructus on the mosaic from Uthina conserve at Bardo, Tunis (5th century AD): Ben Abed-Ben Khader, de Balanda & Uribe Echeverria 2003, fig. 214. Furthermore, a tunic with short sleeves is conserved in the Victoria and Albert Museum – cf. fig. 8.

154. *SB XX* 14319, 3, 4 (7th century AD).

155. Cf. Ernout & Meillet 2001, *s.v.* *caracalla*.

156. Freund 1866, t. I, 420, *s.v.* *caracalla*.

157. Ernout & Meillet 2001, *s.v.* *caracalla*.

158. Wild 1986.

159. Russo 2004, 142.

160. For some garments of this type see, for example, Wulff & Volbach 1926, 62, fig. above-left: Akhmîm (6th-7th century AD?); Benazeth & Rutschowscaya 2009, no. 74: provenance unknown (6th - 8th century AD).

161. *P. Michael.* 38, 2, 10.

162. Pseudo-Sophronius, *Comentarius Liturgicus* 7 (*PG* 87, 3, 3988, C).

163. 171 (*PG* 87, 3 col. 3037, C).



**Figure 11.** Tunic with hood (provenance unknown; 6th-8th century AD). Photo: Georges Poncet © Musée du Louvre, no. E 26525.

called φαλόνιον, which is a Greek form of the Latin term *peanula*. A *peanula* was a mantle with the shape of bell, sometimes split at the front, fastened with hooks to close it, generally stitched, and presenting only one opening for the head. This mantle was frequently provided with a hood (*peanula cucullata*). The *peanula* was already known in Roman society during the Republic, at the beginning of the 4th century AD became one of the most common mantles.<sup>164</sup>

The shape of the garment named the στιχαροφελόνιον is not clearly identifiable. D.S. Crawford

suggests “that in compounds στιχαρο- meant ‘striped’, from στιχος; a στιχάριον would then be a ‘striped thing’ by etymology, a ‘tunic’ by use only”;<sup>165</sup> he has thus translated the term in question as a ‘striped cloak’. It seems to us, however, that this explanation – which is also used by certain scholars to explain the significance of the στιχαρομαφόριον term – is not correct.<sup>166</sup> Thus, what was the στιχαροφελόνιον? Does it refer to a tight tunic with long sleeves, easy to wear under a mantle, stitched at the front and provided with a hood, or it is a tunic with a little hood, the characteristic element of a φελόνιον?

164. Cf. Leroux 1905, 291-293; Wilson 1938, 87-92; Kolb 1973, 73-116.

165. In *Papyri Michaelidae*, Aberdeen 1955, 67.

166. For a discussion see *supra*.

## Conclusion

An analysis of the written and iconographic sources and the preserved clothing allows us to conclude that in Egypt, until the end of the 2nd century AD, the only Greek word indicating a tunic was χιτών; for a tunic with sleeves one used the term χιτών χειρίδιος. With the arrival of the new fashion wearing of tunics with long, sewn sleeves, towards the end of the 2nd - beginning of the 3rd century AD, the vocabulary became richer. The tunics without sleeves are from then called κολόβιον or λεβίτων, in parallel with the term χιτών, until the end of the 4th century AD. The λεβίτων term seems to be specific to the vocabulary used in the monastic environment, and in the papyrological documentation is attested in texts written only in Coptic. Until the end of the 5th century AD, tunics with wide sleeves were designated by the term δελματική, and those with tight sleeves by στιχάριον, a word still present in the 8th century AD in the vocabulary employed in Egypt. Finally, it may be that the καμίσιον term in the Greek language of Egypt at one time meant a tunic worn like an ‘undergarment’, at other times – in particular in the texts of the 6th and 7th centuries AD – a tight tunic known as ‘Persian’, stitched from several pieces, different from the ‘local’ style, and always called στιχάριον.

From the beginning of the 3rd century AD, new garment types also appear combining, a tunic and another element of clothing, such as a shawl, hood, mantle or another tunic. The garments of this type have their own specific composite vocabulary, not always identified in a definitive manner (δελματικομαφόριον, κολοβιομαφόριον, στιχαρομαφόριον, στιχαροκαρακάλλιον, στιχαρο-κολόβιον, στιχαροφελόνιον).

We note that certain terms are used differently according to the period, and that their meaning varies, depending on the types of texts in which they appear. Indeed, the vocabulary from the literary texts and that used by the inhabitants of Egypt, which is reflected in the papyrological documents, are sometimes dissimilar. These socio-linguistic phenomena are very evident, particularly in the case of the terms δελματική, κολόβιον, λεβίτων and στιχάριον.

## Abbreviations

- B.A.S.P.* = *Bulletin of the American Schools of Papyrologists*  
*BdE* = Bibliothèque d'Étude  
*BIFAO* = *Bulletin de l'Institut français d'archéologie orientale*  
*BRHE* = Bibliothèque de la Revue d'histoire ecclésiastique  
*FIFAO* = Fouilles de l'Institut français d'archéologie orientale  
*JEA* = *Journal of Egyptian Archaeology*  
*MDAIR* = *Mitteilungen des deutschen archäologischen Instituts*  
*MMAEE* = Metropolitan Museum of Art, Egyptian Expedition  
*TU* = Texte und Untersuchungen

## Bibliography

- Åkerström-Hougen, G. (1974) *The Calendar and Hunting Mosaics of the Villa of the Falconer in Argos*. Acta Instituti Atheniensis Regni Sueciae, Series in 4°, XX-III. Stockholm.
- Alaoui, B., Bénazeth, D., Boud'hors, A. & Rutschowskaya, M.-H. (eds.) (2000) *L'art copte en Égypte. 2000 ans de christianisme. Exposition présentée à l'Institut du monde arabe, Paris et au musée de l'Ephèbe au Cap D'Agde*. Paris.
- Amelung, W. (1899) Χιτών. In A. F. Pauly & G. Wissowa (eds.) *Real-Encyclopädie der Classischen Altertumswissenschaft*, vol. VI. 2309-2335. Stuttgart.
- Baur, P. V. C., Rostovtzeff, M. I., & Bellinger A. R. (1933) *The Excavations at Dura-Europos. Preliminary Report of Fourth Season of Work Octopbre 1930-March 1931*. Oxford.
- Bayet, C. (1892) Dalamtica. In Ch. Daremberg & E. Saglio (eds.) *Dictionnaire des antiquités grecques et romaines* II/1. 19-21. Paris.
- Bechtold, E., (2008) A Monk's Decorated Shirt from Egypt, *KUT* [journal of the doctoral school of history at ELTE University-Budapest], 81-89.
- Ben Abed-Ben Khader, A., de Balanda, E. & Uribe Echeverria, A. (ed.) (2003) *Image de Pierre. La Tunisie en mosaïque*. Paris.
- Benazeth, D., & Rutschowskaya, M.-H. (ed.) (2009), *Une autre Égypte. Collections coptes du Musée du Louvre*. Paris.

- Blum, G. (1919) Tunica. In Ch. Daremberg & E. Saglio (eds.) *Dictionnaire des antiquités grecques et romaines* V/1. 534-540. Paris.
- Boon, A. (1932) *Pachomiana Latina*. BRHE 7. Louvain.
- Bosson, N. & Aufrère S. H. (eds.) (1999) *Égyptes... L'Égyptien et le copte. Catalogue de l'exposition*. Lattes.
- Boud'hors, A. (1997) Vêtements et textiles à l'usages divers: termes coptes, *Grafma Newsletter* 1, 20-28.
- Bruwier, M.-C. (ed.) (1997) *Égyptiennes. Étoffes coptes du Nil*. Mariemont.
- Calament, F. (1996) Une découverte récente; les costumes authentiques de Thaïs, Leukyôné et Cie. *RevLouvre* 2, 27-32.
- Carandini, A., Ricci, A. & de Vos, M. (1982) *Filosofiana: la villa di Piazza Armerina. Immagine di un aristocratico romano al tempo di Constantino*. Palermo.
- Carroll, D. L. (1988) *Looms and Textiles of the Copts*. California Academy of Sciences. San Francisco.
- Castel, G. (1979) Étude d'une momie copte. In J. Vercouter (ed.), *Hommage à Serge Sauneron* II, 121-143. BdE 82. Cairo.
- Chantraine, P. (1968) *Dictionnaire étymologique de la langue grecque*. Paris.
- Croom, A. T. (2000) *Roman Clothing and Fashion*. Tempus.
- Deckers, J. G., Mietke, G., Weiland, A. L. & Nicolai, V.F. (1991) *Die Katakombe «Anonima di Via Anapo»*. Roma Sotterranea Cristiana IX. Città del Vaticano.
- De Jonghe, D. & Verhecken-Lammens, Ch. (1994) Le vêtement damassé 4219 de la Fondation Abegg à Riggisberg, *Riggisberger Berichte* 2, 41-72.
- Descamps-Lequime, S. (1988) Le costume grec. In M. Depraetere-Dargery (ed.), *Tissu et vêtement. 5000 ans de savoir-faire. Musée Archéologique Départemental du Val d'Oise*. 91-98. Guiry-en-Vexin.
- Diethart, J. (1989) Corrigenda und Addenda zu Wiener Papyri, *ZPE* 76, 107-114.
- Dunand, F. (1990) *Catalogue des terres cuites gréco-romaines d'Égypte. Musée du Louvre*. Paris.
- Dunand, F. & Lichtenberg, R. (1985) Une tunique brodée de la nécropole de Douche, *BIFAO* 85, 133-148.
- Ernout, A. and Meillet, A. (2001) *Dictionnaire étymologique de la langue latine*. Paris.
- von Falck, M. & Lichtwark, F. (eds.) (1996) *Ägypten, Schätze aus dem Wüstensand. Kunst und Kultur der Christen am Nil*. Wiesbaden.
- Fluck, C., Linscheid, P. & Merz, S. (2000) *Staatliche Museen zu Berlin-Preussischer Kulturbesitz, Skulpturensammlung und Museum für Byzantinische Kunst, Bestandskataloge, Band 1. Textilien aus Ägypten. Teil 1: Textilien aus dem Vorbesitz von Theodor Graf, Carl Schmidt und dem Ägyptischen Museum Berlin*. Berlin.
- Förster, H. (2002) *Wörterbuch der griechischen Wörter in den koptischen dokumentarischen Texten*. TU 148, Berlin.
- Frankel, S. (1886) *Die aramäischen Fremdwörter im Arabischen*. Leiden (reprint 1962).
- Freund, G. (1866) *Grand dictionnaire de la langue latine*. Paris.
- Gąsiorowski, S. J. (1931) A fragment of Greek illustrated papyrus from Antinoë, *JEA* 17, 1-9.
- Granger Taylor, H. (1983) The two dalmatics of Saint Ambrose?, *Bulletin du CIETA* 57-58, 127-173.
- Granger Taylor, H. (2000) The textiles from Khirbet Qazone (Jordan). In D. Cardon & M. Feugère (ed.) *Archéologie des textiles des origines au V<sup>e</sup> siècle. Actes du colloque de Lattes, octobre 1999*, 149-162. Monographies instrumentum 14. Montagnac.
- Granger Taylor, H. & Sheffer, A. (1994) Textiles from Masada. A Preliminary Selection. In E. Netzer et al. (ed.) *Masada IV: The Yigael Yadin Excavations 1963-1965: Final Reports*, 149-251. Jerusalem.
- Heurtel, Ch. (2004) *Les inscriptions coptes et grecques du temple d'Hathor à Deir al-Medina*. Cairo.
- Hodak, S. (2010) *Die koptischen Textilien im Museum Kunst Palast Düsseldorf. Figürliche und ornamentale Purpur und Buntwirkereien*. Wiesbaden.
- Innemée, K. C. (1992) *Ecclesiastical Dress in the Medieval Near East*. Leiden-New York-Köln.
- Kendrick, A. F. (1920) *Catalogue of textiles from the burying ground in Egypt. Victoria and Albert Museum, Department of Textiles*. Vol. I. *Græco-roman period*. London.
- Kendrick, A. F. (1921) *Catalogue of textiles from the burying ground in Egypt. Victoria and Albert Museum, Department of Textiles*. Vol. II. *Period of Transition and of Christian Emblems*. London.
- Kolb, F. (1973) Römische Mäntel: *paenula, lacerna, μανδύη*, *MDAIR* 80, 69-167.
- Kramer, J. (1994) Zu Rolle von Papyrusbelegen für die Wortgeschichte am Beispiel von *camisia* und *καμίσιον / καμίσιον*, *Archiv* 40, 133-142.
- Lafontaine-Dosogne, J. & De Jonghe, D. (1988) *Textiles coptes*. Bruxelles.
- Lampe, G. W. H. (1961) *A Patristic Greek Lexicon*. Oxford (reprint 1968).
- Lauffer, S. (1971) *Diokletians Preisedikt. Texte und Kommentare* 5. Berlin.
- Lefort, L. -Th. (1924) La Règle de S. Pachôme, *Muséon* 37, 1-28.
- Leroux, G. (1905) Pallium. In Ch. Daremberg & E. Saglio



- (eds.) *Dictionnaire des antiquités grecques et romaines* IV/1. 285-293. Paris.
- Lorquin, A. (2002) Orient et Occident dans les costumes exhumés en Égypte: questions ouvertes. In M. Durand & F. Saragoza (eds.) *Égypte, la trame de l'Histoire. Textiles pharaoniques, coptes et islamiques. Catalogue de l'exposition*. 95-99. Paris.
- Mannerling, U. (2000) Roman garments from Mons Claudianus. In D. Cardon & M. Feugère (eds) *Archéologie des textiles des origines au V<sup>e</sup> siècle. Actes du colloque de Lattes, octobre 1999*, 283-290. Monographies instrumentum 14. Montagnac.
- Martiniani-Reber, M. (1997) *Textiles et modes sassanides. Les tissus orientaux conservés au département des Antiquités égyptiennes, Musée du Louvre*. Paris.
- Mau, A. (1900) Colobium. In A. F. Pauly & G. Wissowa (eds) *Real-Encyclopädie der Classischen Altertumswissenschaft*, vol. VII, 483. Stuttgart.
- Mitthof, Fr. (2001) *Annona militaris. Die Heeresversorgung im spätantiken Ägypten*. Papyrologia Florentina 32. Firenze.
- Montserrat, D. (1992) A List of Monastic Garments from Oxyrhynchus, *B.A.S.P.* 29, 81-84.
- Mossakowska, M. (1996) Μαφόριον dans l'habit monastique en Égypte. In *Aspects de l'artisanat du textile dans le Monde Méditerranéen (Égypte, Grèce, monde Romain)*, 27-37. Collection de l'Institut d'Archéologie et d'Histoire de l'Antiquité, Université Lumière Lyon 2, vol. 2. Lyon.
- Mossakowska-Gaubert, M. (2004) Les origines des tuniques à manches courtes et sans manches utilisés par les moines égyptiens (IV<sup>e</sup> - début du VII<sup>e</sup> siècle), *AnTard* 12, 153-167.
- Mossakowska-Gaubert, M. (2006) Quelques expressions grecques liées à l'aspect technique de la production des tuniques en Égypte. In B. Mathieu, D. Meeks & M. Wissa (eds.), *L'apport de l'Égypte à l'histoire des techniques. Méthodes, chronologie et comparaisons*, 169-184. BdE 142. Cairo.
- Murri, R. (1943) Ricerche sugli abiti menzionati nei papiri greco-egizi, *Aegyptus* 21, 106-127.
- Nau, F. (1902-1903) Le texte grec des récits du moine Anastase sur les saints pères du Sinaï, *Oriens Christianus* vol. 2, 58-89.
- Nicolai, V. F., Bisconti, F. & Mazzoleni, D. (1998) *Le Catacombe cristiane di Roma*. Regensburg.
- Nicolai, V.F., Bisconti, F. & Mazzoleni, D. (2000) *Les catacombes chrétiennes de Rome*. Turnhout.
- O'Callaghan, J. (1982-83) La 'dalmatica' en los papiros griegos, *Analecta Sacra Tarraconensia Barcelona* 55-56, 285-291.
- O'Callaghan, J. (1996) La palabra «camisa» en los papiros griegos, *Aegyptus* 76, 51-55.
- Paetz gen. Schieck, A. (2012) A Late Roman painting of an Egyptian officer and the layers of its perception. On the relation between images and textile finds. In M.-L. Nosch (ed.) *Wearing the Cloak. Dressing the Soldiers in Roman Time*. 85-108. Ancient Textiles Series 10. Oxford.
- Piccirillo, M. (1993) *The Mosaics of Jordan*. American Center of Oriental Research Publications 1. Amman.
- Pfister, R. (1934) *Textiles de Palmyre*. Paris.
- Pfister, R. & Bellinger, L. (1945) *The Textiles = The Excavations at Dura-Europos, Final Report IV, 2*. New Haven.
- Pflaum, H. G. (1948) *Le marbre de Thorigny*. Bibliothèque de l'École des Hautes Études 292. Paris.
- Pintaudi, R. & Sijpesteijn P.J. (1996-1997) Registrazione di vesti con valori e percentuali (*P. Flor.* III 382 recto), *Analecta Papyrologica* VIII-IX, 179-195.
- Potthoff, A. (1992) *Lateinische Kleidungsbezeichnungen in synchroner und diachroner Sicht*. Innsbrucker Beiträge zur Sprachwissenschaft. Band 70. Innsbruck.
- Preisigke, F. *Wörterbuch der griechischen Papyrusurkunden*. Berlin, vol. I, 1925; vol. II 1927.
- Pritchard, Fr. & Verheeken-Lammens, Ch. (2001) Two wide-sleeved linen tunics from Roman Egypt. In P. Walton Rogers, L. Bender Jørgensen & A. Rast-Eicher (eds) *The Roman textile industry and its influence. A Birthday tribute to John Peter Wild*, 21-29. Oxford.
- Pritchard, Fr. (2006) Tunics and overtunics. In Fr. Pritchard (eds.) *Clothing Culture. Dress in Egypt in the First Millennium AD*. 45-115. Manchester.
- Reil, T (1913) *Beiträge zur Kenntins des Gewerbes im hellenistischen Ägypten*. Leipzig.
- Rutschowskaya, M.-H. (1990) *Tissus coptes*. Paris.
- Russo, S. (2004) L'abito del quotidiano: l'apporto della documentazione papirologica. *AnTard* 12, 137-144.
- Sauneron, S. (1972) *Les ermitages chrétiens du désert d'Esna, vol. IV. Essai d'histoire*. FIFAO 29/4, Cairo.
- Schmelz, G. (2002) *Kirchliche Amtsträger im spätantiken Ägypten nach den Aussagen der Griechischen und Koptischen Papyri und Ostraka*. Archiv Beih. 13. Leipzig.
- Settis, S., La Regina, A., Agosti, G. & Farinella, V. (1988) *La Colonna Traiana*. Torino.
- Sijpesteijn, P. J. (1980) Στταρομοφόριον / στταροφελώνιν, *ZPE* 39, 162-163.
- Sophocles, E. A. (1900) *Greek Lexicon of the Roman and Byzantine Periods*. New York.
- Souter, A. (1949) *Glossary of Later Latin to 600 A.D.* Oxford.

- Tilke, M. (1923) *Orientalische Kostüme*. Berlin.
- Verhecken-Lammens, Ch. (1997) Élaboration des tuniques. In Bruwier (ed.) (1997), 89-102.
- Walde, A. & Hofmann, J. B. (1938) *Lateinisches Etymologisches Wörterbuch*, Heidelberg.
- Walker, S. & Bierbrier, M. (1997) *Ancient Faces. Mummy Portraits from Roman Egypt*. A Catalogue of Roman Portraits in the British Museum, Part IV. London.
- Wild, J. P. (1967) Soft-finished Textiles in Roman Britain, *The Classical Quarterly*, N.S. 17, 133-135.
- Wild, J. P. (1968) Clothing in the North-West Provinces of the Roman Empire, *Bonner Jahrbücher* 168, 166-240.
- Wild, J. P. (1969) The *tarsikarios*, a Roman Linen-Weaver in Egypt. In J. Bibauw (ed.), *Hommage à Marcel Renard*, vol. II, 810-819. Collection Latomus 102. Bruxelles.
- Wild, J. P. (1986) Bath and the identification of the *Caracalla*, *Britannia* 17, 352-353.
- Wild, J. P. (1994) Tunic No. 4219: An Archaeological and Historical Perspective, *Riggisberger Berichte* 2, 9-36.
- Wilson L. M. (1938) *The Clothing of the Ancient Romans*. Baltimore.
- Winlock, H. E. & Crum, W. E. (1926) *The Monastery of Epiphanius at Thebes I*. MMAEE III. New York.
- Winter J. G. & Youtie H. C. (1944) Cotton in Graeco-Roman Egypt, *AJP* 65, 249-258.
- Wipszycka, E. (1965) *L'industrie textile dans l'Égypte romaine*. Wrocław-Warsaw-Cracow.
- Woods, C. (2007) A contribution to the King's Library: Paul the Deacon's epitome and its Carolingian context. In F. Glinister, C. Woods with J. A. North & M. H. Crawford (eds.) *Verrius, Fastus and Paul*. 109-135. Bulletin of the Institute of Classical Studies Supplement 93. London.
- Wulff, O. & Volbach, W. F. (1926) *Spätantike und koptische Stoffe aus ägyptische Grabfunden in den Staatlichen Museen Kaiser-Friedrich-Museum / Ägyptisches Museum, Schliemann-Sammlung*. Berlin.

Table 1.

Greek word	The most common meaning	Date of use attested in papyrological documentation	Other meaning	Date of use attested in papyrological documentation
δελματική	Roomy tunic, with wide sleeves	late 2nd/early 3rd – 5th century AD		
δελματικομαφόριον	Roomy tunic, with wide sleeves, and a shawl attached (?)	3rd – 5th century AD		
καμίσιον	Tunic with long sleeves, worn like an “undergarment”	• late 2nd/early 3rd century AD (uncertain) • 4th – 5th century AD	cut tunic, short and tight, with long sleeves (?)	6th – early 8th century AD
κολόβιον	Tunic without sleeves or with short sleeves	middle 3th – 6th century AD		
κολοβιομαφόριον	Tunic without sleeves, and a shawl attached (?)	4th – 5th century AD		
λεβίτων	Tunic without sleeves	Greek: uncertain		
[ΛΕΒΙΤΩΝ]		Coptic: 4th – 8th century AD		
στιγάριον	Tunic with long, tight sleeves	late 2nd/early 3rd – 8th centuries AD		
στιχαροκαρακάλλιον	Tunic with long, tight sleeves, and a hood (?)	7th century AD		
στιχαροκολόβιον	Tunic with “true” short sleeves (?); Long tunic, without sleeves (?)	6th century AD		
στιχαρομαφόριον	Tunic with long, tight sleeves, and a shawl attached (?)	5th – 7th (8th ?) century AD		
στιχαροφελόνιον	Tunic with long, tight sleeves, and a hood (?); Tunic with sleeves, easy to wear under a mantle called a φαιδόνιον (?)	6th century AD		
ὑποκαμίσιον	Tunic with long sleeves, worn like an “undergarment”	6th – early 8th century AD		
χειριδότης χιτών	Tunic with tight sleeves	3rd century BC – 2nd century AD		
χιτών	Tunic in the general sense	3rd century BC – 2nd century AD	Tunic without sleeves	3rd – 4th century AD

Table 2.

Kind of tunic	Greek name and date of its use in papyrological documentation (1)	Greek name and date of its use in papyrological documentation (2)	Greek name and date of its use in papyrological documentation (3)
Tunic in the general sense	χιτών 3rd century BC – 2nd century AD		
Tunic without sleeves	χιτών 3rd – 4th century AD	κολόβιον middle 3th – 6th century AD	[ΛΕΒΙΤΟΝ] 4th – 8th century AD
Long tunic, without sleeves (?)	στιγαροκολόβιον (?) 6th century AD		
Tunic with short sleeves	κολόβιον middle 3th – 6th century AD	στιγαροκολόβιον (?) 6th century AD	
Tunic without sleeves, and a shawl attached (?)	κολοβιομαφόριον (?) 4th – 5th century AD		
Roomy tunic, with wide sleeves	δελματική late 2nd-early 3rd – 5th century AD		
Roomy tunic, with wide sleeves, and a shawl attached (?)	δελματικομαφόριον 3rd – 5th century AD		
Tunic with long, tight sleeves	χειριδότης χιτών 3rd century BC – 2nd century AD	στιχάριον late 2nd-early 3rd – 8th century AD	
Tunic with long, tight sleeves, and a shawl attached (?)	στιγαρομαφόριον (?) 5th – 7th (8th ?) century AD		
Tunic with long, tight sleeves, and a hood (?)	στιγαροφελόνιον (?) 6th century AD	στιγαροκακακάλλιον (?) 7th century AD	
Cut tunic, short and tight, with long sleeves (?)	καμίσιον (?) 6th – early 8th century AD		
Tunic with long sleeves, worn like an “undergarment”	καμίσιον 4th – 5th century AD	ύποκαμίσιον 6th – early 8th century AD	

## Terminology Associated with Silk in the Middle Byzantine Period (AD 843-1204)

Julia Galliker

During the 1<sup>st</sup> millennium AD, silk became the most desirable fibre in the Mediterranean region. While the expansion of silk production and consumption is widely acknowledged, specific features of the industry's development are more difficult to discern. Chroniclers had little reason to document silk manufacturing processes, and producers were not inclined to record or publicise their trade secrets. Historical knowledge of silk comes mainly from accounts of its consumption in a variety of forms and contexts.<sup>1</sup>

For the middle Byzantine period (AD 843-1204), the two most elaborated sources associated with silk date from the 10<sup>th</sup> century. The *Book of the Eparch (BOE)* (911/12) is a collection of regulations applied to guilds under the supervision of the eparch of Constantinople.<sup>2</sup> The *Book of Ceremonies (BOC)*, attributed to Emperor Constantine VII Porphyrogenetos (945-959), is a compilation of 5<sup>th</sup>- to 10<sup>th</sup>-century protocols used by court officials to stage imperial rituals.<sup>3</sup>

Together, these sources have shaped much of the existing Byzantine scholarship pertaining to silk. The conventional interpretation is that for much of the middle Byzantine period, silk was an imperial prerogative confined to the most elite members of society.<sup>4</sup> However, close reading of the larger body of source evidence shows that the prevailing Byzantine silk narrative has numerous shortcomings and limited value in the study of historic processes. From the standpoint of contemporary scholarship, the role of silk in the middle Byzantine period requires reconsideration through application of current research methods.

To provide a more secure historical basis for silk research, other types of writing should be considered including histories, chronicles, and testamentary documents. A survey of Byzantine and other contemporary sources dated between the 6<sup>th</sup> and 13<sup>th</sup> centuries reveals a large number of textual 'mentions' describing textiles. Many mentions contain only partial information, but include terms associated with silk such as

1. For a more detailed discussion of the history of silk in the Mediterranean region, see Galliker 2014, 33-80.

2. *BOE*, Koder.

3. *BOC*, Reiske.

4. For example, see Lopez 1945, Muthesius 1995b; Muthesius 1997, Muthesius 2004; Oikonomides 1986; Starensier 1982; Beckwith 1974.

production place, materials, weave type, end use, design, quality, and usage context.

Philologists have long tried to clarify the meaning of textile words in Byzantine sources with limited success.<sup>5</sup> For example, in his preface to *BOC*, Vogt observed that it is not possible to know the precise nuances of textile-related terms.<sup>6</sup> The general view is that lexical analysis can recognise the incidence of various words, but there is seldom sufficient descriptive information in written works to form a reconstructive view of textiles.<sup>7</sup>

Probing more deeply, there are several reasons why textile terminology presents such a challenge. With few exceptions, authors used specific textile terms in context without elaborated definition or provision of descriptive details. Like other specialised lexicons, textile terminology usage was sometimes inconsistent and localised. Moreover, textile terms were not stable, but evolved different meanings over time. Various factors contributed to the migration of meaning including changes in material type, production location, and technology.

In recent decades, new research methods supported by computer information technologies have equipped historians to analyse evidence more exhaustively and dynamically than in the past. To study Byzantine textile terminology, I developed a relational database of textile mentions similar in concept and form to a prosopography.<sup>8</sup> This database comprises over 800 descriptive mentions of textiles found in a variety of Byzantine sources dating from the 6<sup>th</sup> to 13<sup>th</sup> centuries. The resulting corpus provides an evidentiary basis to discern patterns that are difficult to perceive with conventional methods.

The textile mention database supports critical examination of textual evidence to define the meaning of terms pertaining to or associated with silk in the

middle Byzantine period. This process is aided by considering written sources from a framework that follows the general sequence of silk textile processes including material acquisition and preparation, textile construction, decoration, and pattern reproduction. The larger objective is to use the collective terminology data to redefine historical understanding of silk in the middle Byzantine period by demonstrating its social importance, contribution to technology development, and integration in the regional economy.

### Terms for silk in Byzantine writing

Silk was explicitly identified in Byzantine sources by one of three terms: *serika*, *blattia*, and *metaxa*. In the majority of mentions, references to silk were generic and not elaborated. Several scholars have discussed silk terminology in the middle Byzantine period and concluded that the words were part of an evolving lexicon, but that their meaning became more or less synonymous over time.<sup>9</sup> Contextual analysis of the database corpus demonstrates usage patterns that clarify the development and specific meaning of the terms.

#### *Serika*

While the incidence of both *serika* and *blattia* was nearly equal among the sources surveyed, the terms developed and were used in different ways. *Serika* was the word used by Theophanes of Byzantium in the second half of the 6<sup>th</sup> century to describe the transfer of sericulture technology to the empire.<sup>10</sup> Significantly, *serika* was the principal term for finished silk goods employed by all Byzantine historians from Nikephoros, Patriarch of Constantinople (806-815), to

5. Lombard 1978, 239.

6. *BOC*, Vogt, Vol. I, 30.

7. Schmitter 1937, 201.

8. In its conventional form, prosopography is a method of extracting historical information by compiling information about individuals defined chronologically and geographically based on one or more master criteria. For additional information, see Keats-Rohan 2003; Short & Bradley 2005; Keats-Rohan 2007.

9. For example, *Imp Exp*, 205-207 n. (C) 173; Jacoby 1991-1992, 458 n. 29.

10. *Theo Byz*, 4, 270, 3.

Niketas Choniates (c. 1155-1217).<sup>11</sup> While silk was typically discussed as a luxury good, there were also exceptions. An account by Anna Komnene suggests that silk garments were included on military campaigns. Finding that he had insufficient iron for his troops at the battle of Lebounion (1091), Emperor Alexios I Komnenos (1081-1118) equipped some of his men in silken garments that resembled iron in colour for battle against the Pechenegs.<sup>12</sup>

The term *holoserika* appeared in the 7<sup>th</sup>- to 8<sup>th</sup>-century *Rhodian Sea Law* referring to the reward due to sailors for salvaging valuable silks.<sup>13</sup> In a comprehensive analysis of silk terminology centred on the late Roman period (AD 250–450), Schmitter traced the appearance of the Latin word *holosericum* to the early 3<sup>rd</sup> century.<sup>14</sup> At the time, the word referred to continuous filament silk as compared with inferior spun silk known as *subsericum*. Schmitter concluded that silk had become common enough for the meaning of *serika* to be vague, requiring more specific terms to describe silk quality distinctions and processing stages.<sup>15</sup> Analysis of the *BOC* shows that evolution of silk terminology is also evident for the word *holoserika*, which appeared only in chapters dating from the 5<sup>th</sup> to 7<sup>th</sup> centuries.<sup>16</sup>

### ***Blattia***

The word *blattia* provides another example of changing terminology associated with silk. Guillard described the semantic evolution of the term from a purple murex dye derived from shellfish in

the late Roman period to a generic designation for silk textiles by the 9<sup>th</sup> century.<sup>17</sup> However, analysis of the corpus indicates that usage remained ambiguous. Some later sources used *blattia* with reference to purple silk. Compiled in the 950s, *De Administrando Imperio* described remuneration to the Pechenegs in *blattia* and other precious textiles in a way that indicates purple silk was involved.<sup>18</sup> Similarly, Anna Komnene used the word with the specific meaning of imperial purple silk in her description of Alexios' gift to Henry IV.<sup>19</sup> In some other texts, *blattia* was combined into a compound word that specifically identified other colours.<sup>20</sup>

Among the 17 mentions of *blattia* in the *BOC*, seven were for garments, one for furnishings and nine for lengths of fabric for decoration. Nearly all references to *blattia* in the text appeared in chapters dated to the 10<sup>th</sup> century. The compilation also included two enigmatic mentions of *holoblattia*, both in reference to church singers wearing the ceremonial dress of imperial guards for the visit by foreign ambassadors in 946.<sup>21</sup> Other variations of the word, presumably with reference to types of silk, are found in the 11<sup>th</sup>-century testament of Eustathios Boilas (*blatenia*)<sup>22</sup> and in the Patmos Inventory dated 1200 (*blattitzin*).<sup>23</sup>

### ***Metaxa***

In contrast to *serika* and *blattia*, the word *metaxa* was often used with the specific meaning of raw silk fibre. Prokopios used the term *metaxa* in his account of the introduction of sericulture to Byzantium in 553/4.<sup>24</sup>

11. Middle Byzantine historical sources include: *Nikeph;* *Theoph;* *Leo Diac;* *Skyl;* *Psellos;* *Attal;* Brunet; *Nik Chon;* *V. Basilii;* *An Komn.*

12. *An Komn.* Leib, VIII, 4, 1, 6-8.

13. *Rh Sea*, 40, 4, 6-9. For discussion of the meaning and incidence of *holoserika* in various sources, see *Rh Sea*, 114 note.

14. Schmitter 1937, 224.

15. Schmitter 1937, 213, 223.

16. *BOC*, Reiske, I: 89, 404, 405; II: 28, 629; II: 51, 701.

17. Guillard 1949, 333-338.

18. *De Adm Imp.* I.6.6-9.

19. *An Komn.* Leib, III, 10, 4, 3-10.

20. For examples of mentions of *blattia* in various colours, see *BOC*, Reiske, I: 97, 441; and *BOE*, Koder, 4.3, 8.1, 9.6.

21. *BOC*, Reiske, II: 15, 577, 589.

22. *Boilas*, 24.125.

23. *Patmos*, Astruc, 22.41.

24. *Prok.* *De Bello Goth.* Niebuhr, IV, 17.

Surviving fragments of Menander's history, which covered the period 558 to 582 demonstrate a clear distinction between *metaxa* and *serika*. All discussions of bulk trade in raw silk with the Sogdians referred to *metaxa*.<sup>25</sup> In contrast, finished goods, such as hangings and gifts, were called *serika*.<sup>26</sup> Usage by Theophanes Confessor in the early 9<sup>th</sup> century is less clear. He wrote *metaxa* when describing the Roman capture of Saracen tents in 528/9 and burning the contents of the Persian palace of Destagerd in 625/6, but *serika* in two instances involving silk cloths.<sup>27</sup>

The properties of silk as both a strong and flexible material were recognised for military applications. According to the *BOC*, *metaxa* was included with the equipment assembled for the 949 expedition against Crete. *Metaxa* fibres were made into bowstrings for hand-drawn low-ballistae and for large bow-ballistae with pulleys, alone, or in combination with spart grass fibres.<sup>28</sup>

Use of *metaxa* to refer to woven silk was less common, but was used in certain instances. The term appeared in the Greek version of the 5<sup>th</sup>-century book of the Armenian Agathangelos.<sup>29</sup> It may have been incorporated in a historicising sense in the hagiographies of Saints Arethas<sup>30</sup> (martyred c. 520) and Genadios,<sup>31</sup> patriarch of Constantinople (458-471) in the 10<sup>th</sup>-century editions by Symeon Metaphrastes. The *Imperial Expedition* treatise, revised under Constantine VII Porphyrogenetos, referred to a particular type of striped silk garment imported from Egypt as *lorota metaxota*.<sup>32</sup> A marriage contract from southern Italy dated 1267 referred to silk cushions and face veils as *metaxa* rather than *serika*.<sup>33</sup>

### *Summary of silk terms*

This analysis of the three words for silk, *serika*, *blattia*, and *metaxa*, indicates that the meanings overlapped, but that each term had a distinctive identity. *Serika* was a generic word in common use for finished silk cloths. *Blattia* coincided with *serika* in reference to finished silk cloth, but also signalled an imperial association, apparently as a means to convey status. Usage patterns for *metaxa* show that the word was generally used for raw silk, but might have indicated a particular choice or as a geographical or historical reference.

### Terms for silk trade and processing

#### *Fibre trade*

Arab literary works and the Cairo Genizah contain substantial evidence concerning the regional silk trade in the 11<sup>th</sup> and 12<sup>th</sup> centuries.<sup>34</sup> A handful of Byzantine sources also provide specific information about trade in raw silk. In addition to Menander's account of the Sogdian silk trade as noted above, the 6<sup>th</sup>-century *Christian Topography* was written from the author's direct experience. He described trade in Ceylon (*Taprobana*) as a transit point for *metaxa* silk and a variety of other exotic goods. He identified *Tzini-sta*, probably Southern China, as source of raw silk.<sup>35</sup> He also referred to the land-based caravan silk trade through Asia and Persia.<sup>36</sup> The late 10<sup>th</sup>-century correspondence of Leo, Metropolitan of Synada includes a reference to silk merchants in the Anatolikon theme.<sup>37</sup>

25. *Menand*, 10.1, 24; 10.1, 50; 10.1, 56; 10.5, 14.

26. *Menand*, 10.3, 44; 10.3, 51; 25.2, 66.

27. *Theoph*, de Boor, 179, 25-26; 322, 5-8; 444, 17-18.

28. *BOC*, Reiske, II: 670, 1 and 12; 671, 15; 676, 10-11. For a brief discussion of silk for bow strings instead of gut, see Haldon 2000, 273 and n. 110.

29. *Agathan*, 121.14.

30. *Sym Metaph*, 5.

31. *Sym Metaph*, 134.

32. *Imp Exp*, C.290-291, 293-294.

33. *Syllabus*, CCCIV, 436.

34. For example, see Serjeant 1972; Goitein 1967-1993.

35. *Kos Ind*, *Wolska-Conus*, II, 45.7; 46.2; XI, 15, 4. Also, see *Kos Ind*, McCrindle, 47 n. 2.

36. *Kos Ind*, *Wolska-Conus*, II, 45; II, 46; XI, 14-15. For a discussion of *metaxa* in other sources, see 352 n. 45.

37. *Leo Syn*, 42.1-2.



Chapter 6 of the *BOE* represents the most extensive source of information about the silk fibre trade for the middle Byzantine period.<sup>38</sup> The regulations referred to *metaxa* with the specific meaning of silk in a raw state, before degumming and other processing. According to the text, the *metaxopratai* were dealers in raw silk. Their defined role was to buy bulk quantities of *metaxa* coming into the city and resell the material for processing. They were explicitly forbidden from working the material themselves.<sup>39</sup>

Another reference to *metaxopratai* comes from a document containing short notices of tenancy contracts found on the last page of codex *Patmiacus* 171.<sup>40</sup> Consisting of only 27 lines, this brief text provides a glimpse of textile commerce in 10<sup>th</sup>-century Constantinople. Among the five *ergasteria* (workshops) mentioned in the document, four were associated with various aspects of the textile trade.<sup>41</sup> One workshop (before 957) was formerly occupied by a raw silk merchant.<sup>42</sup> Other tenants included a linen seller, a merchant of head coverings made of goat hair, and a dealer in imported silks.

Descriptions of raw silk transactions in the *BOE* show that the basis for exchange was weight. One reason for close supervision of silk transactions was the potential for fraud by rigging scales or by the addition of adulterants to increase fibre weight. The eparch provided certain guilds, including the raw silk merchants, with weights and measures marked with a seal. The weighting implement associated with silk was the *bolion*, which was either a silk balance or set of weights.<sup>43</sup>

### *Silk processing*

#### *Reeled silk yarns*

Specific terms for silk preparation activities are included in only a few Byzantine sources. For example, fibre processing was mentioned in a document from John Apokaukos (c. 1155-1233).<sup>44</sup> An early 14<sup>th</sup>-century didactic work involving silk cultivation and fibre processing by Manuel Philes described various operations in what seems to have been a home-based or small-scale producer in a Byzantine context.<sup>45</sup>

Chapter 7 of the *BOE* referred to the guild of the *katartarioi* as processors of raw silk, but contains few clues about the specific work performed by guild members.<sup>46</sup> Presumably, one of the roles of the *katartarioi* was to reel raw silk. According to Lombard, the word was derived from Latin *cathartum* and Greek *kathartion serikon*, meaning silk that required cleaning.<sup>47</sup>

A possible reference to yarn weight is included in paragraph 8.2 of the *BOE*. The regulations forbade manufacture of *polon* in units of six or eight, but permitted 10 and 12 according to certain requirements. Most scholars have associated these terms with garment construction referring to pieces of cloth joined together.<sup>48</sup> Given the context of use, the term probably applied to yarn fineness, with a low value corresponding to a finer diameter, similar to the modern use of denier.<sup>49</sup> The term *polon* also appeared in the *Kletorologion of Philotheos* with a possible reference to yarn.<sup>50</sup>

38. *BOE*, Koder, Chapter 6.

39. *BOE*, Koder, 6.14.

40. *Patmos*, Oikon.

41. *Patmos*, Oikon, 347 n. 10. For a discussion of workshops and handicraft production, see Koukoules 1948-1952, II, 1, 235.

42. *Patmos*, Oikon, 346, 3, 2.

43. Hendy 1985, 334; *BOE*, Koder, 6.4.

44. *Jo Apok*, 99.10.

45. *Animalibus*, 65-67.

46. *BOE*, Koder, 7.1.

47. Gil 2002, 34.

48. *BOE*, Koder, 8.2; *BOE*, Freshfield, 245; *Imp Exp*, 217-219 n. (C) 226.

49. Muthesius 1995b, 292; see *Imp Exp*, 218 n. (C) 226.

50. *Listes*, 127.14-15; χιτῶν λευκῶς σὺν ἐπωμίοις καὶ πῶλοις χρυσοῦφάντοις λαμπρῶς ἀμφιάζεται.

*Spun silk yarns*

To consolidate the loose filaments left over from reeling silk filaments, the tangled waste fibres are combed to remove waste and debris.<sup>51</sup> The combed floss is then spun like other discontinuous fibres. The resulting yarn is silk in name, but the quality of the material is inferior in several respects. It lacks the fine, even appearance of filaments and the smooth feel. Even if tightly spun, such silk yarns appear ‘hairy’ as compared with filament silk, and tend to pill with abrasion and wear.

In general, spun silk was a cheaper substitute for filament yarn and was used in ways that imitated the material. Lopez suggested that both the Arabic and modern Italian words for silk floss, *qatarish* and *catarzo* respectively, come from the Greek word *katar-tarioi*.<sup>52</sup> Goitein noted the use of the word *qatarish* in an 11<sup>th</sup>-century business letter referring to floss silk.<sup>53</sup> The distinction between filament and spun silk was stressed in the *Imperial Expeditions* treatise where *prokrita kathara* was used to indicate ‘pure’ filaments as compared with either spun silk or a composition of mixed fibres.<sup>54</sup>

In the chapter for the *katartarioi* raw silk processors, paragraph 7.2 refers to the *metaxarioi*.<sup>55</sup> According to the text, *metaxarioi* employed women as well as men, a possible reference to insertion of twist in filament yarn or spinning of silk fibres. Identification of spinning as a female domestic occupation is frequent in Byzantine sources where it assumed symbolic meaning to represent female virtue, modesty and diligence.<sup>56</sup> Women also spun in and out of their

homes for pay. In one example, Choniates relayed that Emperor Alexios III (1195-1203) accused his wife, Euphrosyne, of adultery. She was led out of the palace “dressed in a common frock, the kind worn by women who spin for daily hire.”<sup>57</sup>

The sources covered in the corpus contain several mentions of *koukoularikos*. This material has been translated by various authors as coarse, raw, or spun silk.<sup>58</sup> Contextual analysis indicates that *koukoularikos* referred to spun silk, a cheaper version of cloth made from filament silk. For example, among the garments provided by the *eidikon* for the 949 expedition against Crete were 100 *koukoularikos* tunics and 100 pairs of *koukoularikos* leggings.<sup>59</sup> *Koukoularikos* was mentioned in a tribunal act among documents attributed to Demetrios Chomatenos (c. 1216-1236).<sup>60</sup> Among the various types of textiles mentioned in the text were 20 lengths of *koukoularikos* fabric for monastic clothing. The 1142 Panteleemon inventory includes a *koukoularikos* cloth decorated with a pattern of lions.<sup>61</sup> A marriage contract dated 1267 also referred to a silk veil of *koukoularikos*.<sup>62</sup>

An indication of the relative value of *koukoularikos* in a Byzantine context is obtained from a marriage contract published by De Lange.<sup>63</sup> The document, dated 1022, was written in the town of Mastaura, in the Byzantine region of Lydia. Among the bride’s valuables was a double-faced red dress of *koukoularikos* valued at one and a half gold pieces, comprising just 4% of the total value of movable goods.<sup>64</sup> The dowry listed at least 14 textile items for

51. CIETA 2006, 18.

52. Goitein 1967-1993, I, 418 n. 27.

53. See Goitein 1967-1993, I, 104.

54. *Imp Exp*, C.240, 250; for discussion of the term, see 225 n. (C) 250.

55. Simon 1975, 36.

56. For example, see Talbot 2001, 126; Connor 2004, 164-165.

57. *Nik Chon*, Dieten, 488, 39-43; tr. from *Nik Chon*, Magnolias, 268.

58. For example, see *LBG*, 871; Jacoby 1991-1992, 474 n. 118; Koukoules 1948-1952, 25 n. 1.

59. *BOC*, Reiske, II: 678, 4, 8.

60. *Dem Chom*, 84, 6, 69.

61. *Act Pantel*, 7, 74.18.

62. *Syllabus*, 304, 436. A variant spelling appears in the text as: κοκουλλάκιος.

63. De Lange 1996, 1-10. 7, 30.

64. De Lange 1996, 6, 30. Also, see 7 n. 30.

garments and household valued between 0.5 and 2 gold pieces. On a relative basis, the spun silk dress was less valuable than a veil with a silver clasp listed at 2 gold pieces, but more costly than other dresses recorded at 1 gold piece each.

#### *Silk fibre combinations*

In addition to silk filament yarns and those spun from loose fibres, ‘half’ silks were also mentioned in Byzantine sources. ‘Half’ silks woven from a combination of silk and another fibre had the advantage of economy, since a cheaper fibre type was used for either the warp or weft. Such cloths have a long history in the empire dating from the introduction of silk to the region.<sup>65</sup> In the mid-10<sup>th</sup> century *Broumalion* ceremony described in the *BOC*, both the *protospatharioi* and the *spatharokandidatoi* were given either a length of *molchamion* or a striped robe.<sup>66</sup> The Greek word *molchamion* was equivalent to the Arabic term *mulham*, a half silk widely cited in Islamic writing.<sup>67</sup>

#### *Metal yarns*

In addition to the fibre-based materials discussed above, metallic yarns were conspicuously mentioned in the middle Byzantine sources in association with silk. Gold was the usual metal applied to textiles; the corpus contains only two references to silver embroidery.<sup>68</sup> Techniques for incorporating precious metals into textiles are ancient, with archaeological evidence dating to the Bronze Age.<sup>69</sup> While drawn gold wire and flat metal strips were sometimes used for textiles, they are not well suited to applications requiring flexibility and drape. In order to produce a more pliable cloth, thin strips of beaten gold were wrapped around an organic core such as silk, leather,

or gut.<sup>70</sup> An example of a gold-wrapped silk yarn is shown in fig. 1.

Sillographic and textual evidence indicate that there were four types of Byzantine imperial factories: *blattion* for silk weaving, *chrysoklabon* for gold embroidery, *chrysochoeion* to fabricate gold jewelry, and *armamenton* to produce arms and weapons.<sup>71</sup> On 25 December 792 Theophanes Confessor relayed that the imperial gold embroidery workshop, the *Chrysoklabarion* situated at the *Chryision*, caught fire.<sup>72</sup> The *Kletorologion of Philotheos* dating from 899 described the processional order for three occupations associated with the *Chryision*: the imperial tailors, the gold embroiders, and the goldsmiths.<sup>73</sup> This grouping suggests that it was the goldsmiths who made the gold yarn used by the imperial workshops.

In addition to producing new gold embellished silks, the imperial gold workshop maintained and renovated existing imperial textiles. The alleged actions of Emperor Michael III (842-867) demonstrated that gold woven or embroidered textiles could be melted down to recover precious metals. Both the *Vita Basilii*, written in the mid-10<sup>th</sup> century, and John Skylitzes’ 11<sup>th</sup> century *Synopsis Historiarum* described how Emperor Michael III (842-867) allegedly gathered gold vestments belonging to the emperor and high officials and gave them to the *eidikos* to melt down.<sup>74</sup> According to these accounts, Michael’s death averted possible destruction of the garments and they were restored to the palace.

#### *Summary of silk trade and fibre processing terms*

As this analysis has shown, the properties and performance characteristics of silk fibre types were a feature of the material culture of the middle Byzantine

65. Jacoby 2004, 209.

66. *BOC*, Reiske, II: 18, 607, 9-12; ἀνά μολχαμίου βηλαρίου α’, εἶτε καὶ ἀβδίου.

67. Serjeant 1972, 255; Jacoby 2004, 209 n. 62.

68. *BOC*, Reiske, II: 41, 641.

69. Gleba 2008, 61.

70. Gleba 2008, 61-63.

71. For example, see: Oikonomides 1985, 50-52; *Listes*, 123.6-10.

72. *Theoph*, Mango, 644,

73. *Listes*, 133.9-10.

74. *Skyl*, Thurn, V, 10, 97, 52; *V. Basilii*, 29.23-26.

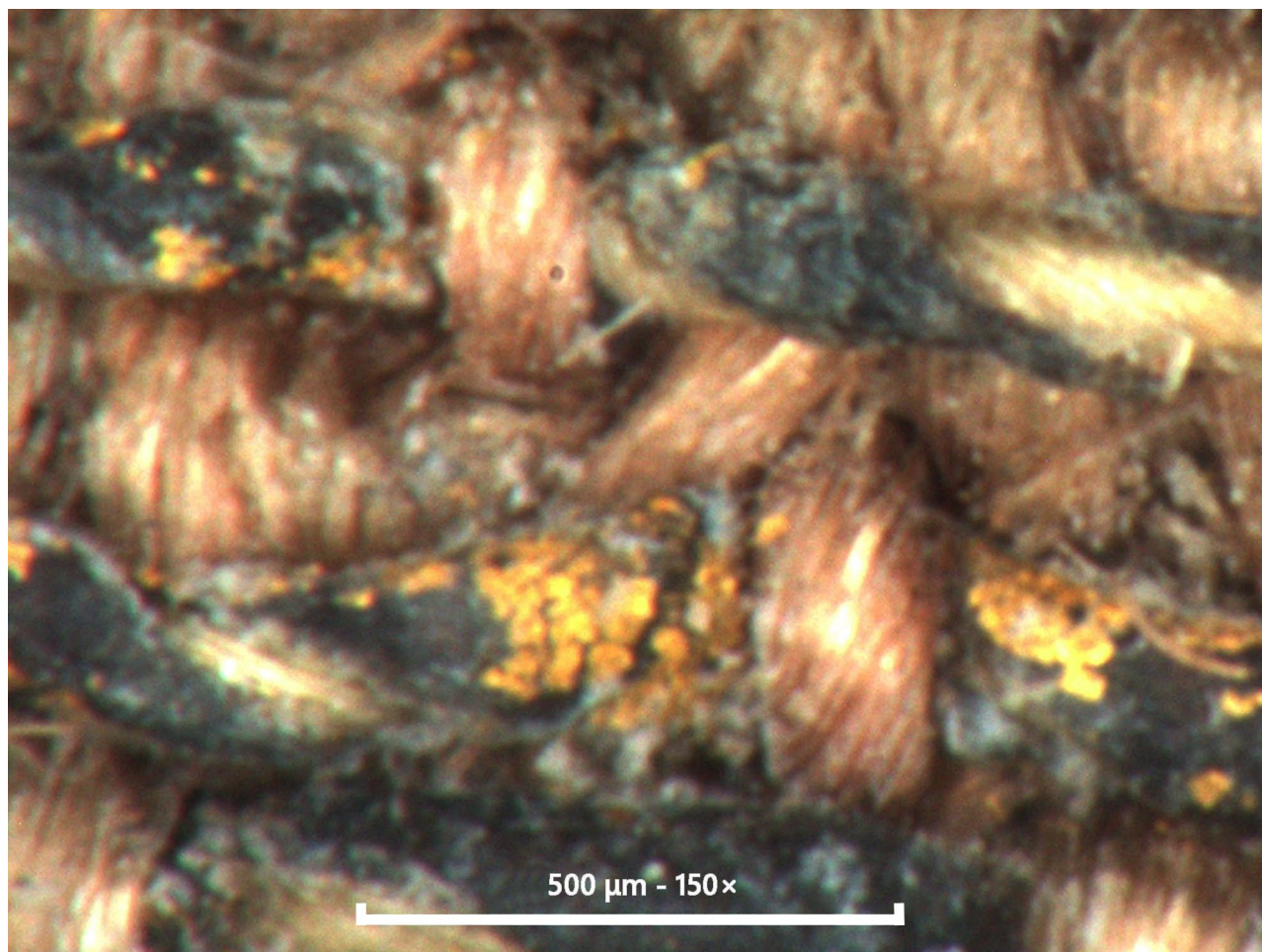


Fig. 1. Figured pattern silk woven with gold-wrapped silk yarn photographed at 150 $\times$  magnification, 1950.2 © Cleveland Museum of Art. Note that much of the gold finish applied to the strips has flaked off of the surface of the yarn. Photo by J. Galliker.

period. The *metaxopratai* regulations in the *BOE* suggest that the silk industry in Constantinople was oriented toward the regional fibre market with importers from a variety of locations. The inference is that as wholesale dealers, the *metaxopratai* were specialists in grading, buying, and selling various types of fibres through market-based transactions.

To prepare silk for weaving, the *katartarioi* performed a number of processing steps based on customer requirements and market demand. Various silk yarn types were produced with different qualitative and performance characteristics. Imitation and fraud were features of the market for silk, demonstrating the need for supervision by the *eparch*. Unlike some

other types of precious materials, silk is a divisible good that could be used in small quantities for decoration, spun from silk floss, or woven with other fibres. In contrast to the prevailing historical interpretation, silk materials were not confined to elite members of society, but functioned as a relative luxury available to a broader population in Constantinople and elsewhere in the empire.

Despite the visibility of gold in finished products, applied either through weaving or embroidery, there is no mention of trade in metal yarns. Only imperial sources hint at the production of metal yarns and decorations for textiles in the imperial palace workshop. Given the high value and weight associated

with metal yarns, they were presumably manufactured on a local basis or as part of yarn preparation in some workshops.

### Terms for textile production and cloth types

Having considered evidence for silk fibre trade and yarn processing, this analysis now turns to an examination of source information for textile production terminology. Chapter 8 of the *BOE* provides valuable information about the work of the *serikarioi*, the producers of silk cloth. The main challenge associated with this chapter is interpretation of specific terms that have few mentions in Byzantine writing. Despite this difficulty, it is evident that the work of the *serikarioi* involved at least three distinct processes: dyeing, weaving, and tailoring garments for sale to the *vestipratioi*, the silk garment merchants. Each of these distinctive processes represented a group of specialist occupations and required training and skill to plan and coordinate work.

### Dyers

The occupation of the dyers is among the best documented of the textile trades among the sources considered in the corpus. According to the framework defined by the *BOE*, dyeing of fibre and skeins could have been conducted by the *katartarioi* as part of their processing work. The regulations in Chapter 8 indicate that at least some dyeing was managed by the *serikarioi*. In addition to valuable murex stuffs, a wide variety of other dye materials were traded throughout the region. Chapter 10 of the *BOE* itemised some of the dyestuffs handled by the *myrepsoi*, the dealers in perfumes and unguents, including indigo and yellow wood for dye.<sup>75</sup>

Letters in the Cairo Genizah referred to the sale of dyestuffs to *Rūmī* (Byzantine or European) merchants.<sup>76</sup> In 1085 a Tunisian trader boasted that he made a 150% profit on the sale of brazilwood, a red dye stuff, to a merchant from *Rūm* at a port in Palestine.<sup>77</sup> A letter from Alexandria dated about 1060 reported the strange buying habits of the *Rūm*. These merchants bought indigo and brazilwood at auction for exorbitant prices and did not distinguish between high quality and inferior goods.<sup>78</sup>

In addition to dyestuffs, other chemicals were also involved in colouration processes. Describing the alum deposits mined in Upper Egypt, Ibn Mammātī (d. 1209) explained that the material was taken to Alexandria where it was sold to *Rūmī* merchants:

“It is a stone which is needed in many things, the most important being dyeing. There is some demand on the part of the *Rūm* for their requirements; for they cannot do without it nor avoid using it.”<sup>79</sup>

While we have little information about the actual work involved in professional dye processes, the industry was notable for its noxious smells and hazardous effluents. In Constantinople and other cities, dyers were often grouped together with tanners and castigated for the public hazards of their occupation. In about 1150, Michael Choniates reflected this sentiment, refusing to permit Jewish tanners and dyers to dwell in his diocese.<sup>80</sup>

In Byzantine sources, the high rate of Jewish participation in the dye industry is evident from various texts, in part because the community was subject to restrictions, exclusions, and periodic persecution.<sup>81</sup> Written in the 1160s, Benjamin of Tudela’s census is an important source for Jewish occupational participation in the textile industry. He reported that there were

75. *BOE*, Koder, 10.1.462-464.

76. The Cairo Genizah is a trove of discarded writings recovered from the Ben Ezra Synagogue at Fustat (Old Cairo). References to *Rūm* generally meant Byzantium as the modern name for the Eastern Roman Empire. The term also was used in a vague manner for Christian Europe into the 12<sup>th</sup> century. See Goitein 1967-1993, I, 43-44.

77. Goitein 1967-1993, I, 45; Bodl. MS Heb. B 3 (Cat. 2806).

78. Goitein 1976, 45-46; BM OR 5542, f. 27, ll. 10-13.

79. *Mammātī*, 23; tr. from Serjeant 1972, 162-163.

80. *Mich Chon*, I, 53; tr. from Starr 1939, 224-225.

81. Starr 1939, 1-10; Holo 2009, 9-23, 163-171.

2,000 Jews (meaning families), mostly skilled artisans in silk and purple cloth, in Thebes and throughout Greece.<sup>82</sup>

Describing the denominational and ethnic division in various occupations, Goitein noted the high rate of Jewish participation in the textile industry throughout the region, especially in silk work and dyeing.<sup>83</sup> A Genizah document described how a Jewish silk dyer fled Byzantium to seek financial support in Egypt after he was accused of spoiling a precious fabric.<sup>84</sup> He was severely punished and his children taken from him until he could reimburse.

### Weavers

In contrast to dyers, we have little written information about professional weavers or their work processes during the early and middle Byzantine periods. Wipszycka's extensive study of the late Roman textile industry in Egypt was based on papyrus and ostraca recovered from various sites. The material included numerous details about the work activities and products of professional weavers.<sup>85</sup>

The word *gynaikeion*, which in classical Greek described the part of the house reserved for women, came to mean textile workshop in early Byzantium.<sup>86</sup> The term appeared again in the *Basilika* in a title that must have been enacted in the middle Byzantine period, because it has no parallel in Roman codes.<sup>87</sup> According to the law, a fine would be levied against anyone who corrupted a woman working in a textile factory.<sup>88</sup>

Evidence associated with the administration of the imperial workshop is provided by the woven inscription on the Aachen 'imperial elephant' silk that was taken from the shrine of Charlemagne and is now housed in the Munster Treasury.<sup>89</sup> The inscription reads "in the time of Michael, *primikerios* of the imperial bedchamber and *eidikos* when Peter was the *archon* of Zeuxippos." Michael, the *eidikos*, held the rank of *primikerios* in the imperial bedchamber, one of eight ranks by which palace officials were graded. The second line of text states that Peter was the *archon* (head) of Zeuxippos, which indicates oversight of an imperial function, presumably an imperial silk factory.<sup>90</sup> Unfortunately, the inscription date is no longer visible on the silk.

Additional primary evidence pertaining to the *archontes* of silk workshops comes from seals published by Oikonomides dated to the 7<sup>th</sup> and 8<sup>th</sup> centuries.<sup>91</sup> Information pertaining to silk workshop administration is limited to a few textual citations. The *Kletorologion of Philotheos* referred to *meizoteroi ton ergodosion* meaning workshop foremen.<sup>92</sup> The vita of Antony II Kauleas, patriarch of Constantinople (893-901), included a reference to the head of the imperial silk factory.<sup>93</sup>

In an incidental mention, the 10<sup>th</sup>-century history of Leo the Deacon referred to a manager or supervisor of an imperial weaving establishment.<sup>94</sup> According to this text, the silk factory superintendent was asked to summon a body of workers from the weaving establishment to join the plot to seize the throne.<sup>95</sup>

82. *Be Tud*, 10.

83. Goitein 1967-1993, I, 100.

84. Goitein 1967-1993, I, 50, UCL Or 1081 J 9. For a revised translation, see Jacoby 1991-1992, 482 n. 169.

85. Wipszycka 1965, especially 47-102.

86. Lopez 1945, 6 n. 3.

87. Lopez 1945, 6 n. 3.

88. *Basilika*, 54.16.8-9.

89. Vial 1961; Muthesius 1997, 183.

90. Muthesius 1995b, 65.

91. Oikonomides 1985, 50-52.

92. *Listes*, 123.10 and 317.

93. *V. Kauleas*, 18.25.

94. *Leo Diac*, Hase, 146.91: βασιλικῆς ἰστουργίας ὄντι μελεδωνῶ.

95. *Leo Diac*, Talbot, 191; *Leo Diac*, Hase, 146.90-1 and 147.1-5. According to Dagron 2002, 432, the word *systema* in this text refers to a group or body of workers rather than to the usual translation in the sense of a guild or corporation.

From this passage, we surmise that silk workers were hierarchically organised and had enough male members to comprise a force capable of assisting with the plot.

To maintain a trained and skilled workforce essential to the exacting requirements of silk production in Constantinople, slaves may have comprised a significant source of labour. Some studies have examined slavery and its increased importance in the 9<sup>th</sup> and 10<sup>th</sup> centuries.<sup>96</sup> Dagron noted that slaves fell into three categories, essentially mirroring the social hierarchy of free men.<sup>97</sup>

Several sources attest to the use of slaves in imperial workshops.<sup>98</sup> The *Vita Basilii* mentions widow Danielis' gift of one 100 female textile slaves to Emperor Basil I (867-886). Theodore of Stoudios (759-826) wrote about a monk named Arkadios who was condemned for icon veneration during the Second Iconoclastic period (814-842). According to a letter, the monk was forced to work as a slave in an imperial cloth workshop.<sup>99</sup> The *BOE* stated that the slaves of some types of private artisans who broke rules could be made into state slaves.<sup>100</sup> Apparently, a large enough body of imperial slaves existed to warrant the notice of Emperor Leo VI (886-912), who provided them the right to dispose of their property during their lifetime and at death.<sup>101</sup>

### *Textile types*

The textile names that are most easily interpreted today were based on particular descriptive characteristics. The corpus includes some Greek terms that referred to striped cloths including *lorota* and *abdia*, an Arab-style striped cloak.<sup>102</sup>

One of the most frequent ways of referring to fabrics was to name them by their fibre type. Linen textiles were widely cited in a number of sources.<sup>103</sup> Examples included descriptive compound words such as blue linen (*linobenetos*).<sup>104</sup> Specific types of linen textiles included *sabana* as a type of cloth for towels.<sup>105</sup> *Sabana* was also used as a term for the linen broadcloth mantles worn by eunuch *protospatharioi* in the *BOC*.<sup>106</sup> *Linomalotaria* appeared among the widow Danielis' gifts in the *Vita Basilii* and was also mentioned in the *Imperial Expeditions* treatise.<sup>107</sup> The widow's gifts to Basil included fine linen *amalia*, which may have been a cloth without nap.<sup>108</sup> The same term appeared in the *Imperial Expeditions* treatise together with the adjective *rasika* meaning rough.<sup>109</sup> In the *BOC*, *rasikon* referred to cloth used for making sails.<sup>110</sup>

The sources included in the corpus mention *bysos*, an especially fine type of linen made with delicate yarns that may have appeared semi-transparent.<sup>111</sup> Arab accounts included many references to *kaşab*, a highly-prized, fine linen woven with precious metals

96. For example, see Hadjinicolaou-Marava 1950; Rotman 2004.

97. Dagron 2002, 420-421.

98. See Hadjinicolaou-Marava 1950, 25, 35, 45, 47.

99. *Theod Stoud*, 390.20.

100. *BOE*, Koder, 12.9.

101. *Nov Leo VI*, 150-153.

102. For *abdia*, see *BOC*, Reiske, I: 48, 255, 8; *Imp Exp*, C.241-242, 257-258 and 223 n. (C) 242.

103. For a summary of terms related to linen, see *LBG*, 940-941; for a comprehensive discuss of linen terminology in Byzantine and other Greek sources, see Georgacas 1959, esp. 255-256.

104. *Imp Exp*, C175.524.

105. *BOE*, Koder, 9.7.452; *BOC*, Reiske, I: 41, 215; see *Imp Exp*, 214-215 n. (C) 222.

106. *BOC*, Reiske, I: 17, 100; 49, 255; 67, 301-302; II: 15, 574.

107. *V. Basilii*, 74.31-37; *Imp Exp*, 214 n. (C) 222. The term is variously translated as linen tablecloth, fringed cover and rough blanket.

108. *V. Basilii*, 74.31-37.

109. *Imp Exp*, C124.

110. *BOC*, Reiske, II: 45, 674, 7, 11; 675, 7.

111. For example, see *Skyl*, Thurn, XV, 18, 310, 66; XXIII, 2, 482-483, 87-89; *Attal*, Brunet, 27, 4, 18-19. See also Maeder, this volume.

for luxury use, often as turbans.<sup>112</sup> Although not mentioned by name, Attaleiates' *Diataxis* included two valuable Saracen cloths, one of which was embroidered.<sup>113</sup> At the opposite extreme, Byzantine sources contain several mentions of sackcloth (*sakkon*), referring to a rough material worn for mourning, punishment, or atonement.<sup>114</sup> Usage context suggests that sackcloth was a general category of low quality, coarsely-woven cloth.

A few textile names in Byzantine sources referred to a specific type of weave structure. Reiske translated the word *trimita* in the *Imperial Expeditions* treatise to mean three-coloured or striped.<sup>115</sup> A more likely explanation is that the word retained its historical meaning as a term for twill weave. In literal translation 'three threads' referred to the number of warps comprising a twill unit as compared with two for tabby weave. The term *trimita* appeared in Roman Egyptian sources including a papyrus dated to the year 363.<sup>116</sup> *Trimitarioi* was an occupation identified in the *Edict of Diocletian* as well as a 4<sup>th</sup>-century tax receipt.<sup>117</sup> The word also appeared on a 2<sup>nd</sup>-century inscription found in Pessinous.<sup>118</sup>

The word *hexamitos* is of particular interest to this analysis because of its modern use as a term for weft-faced figured weave silks with a twill binding. Writing in the mid-1800s, Michel described transmission of the word from Greek to European languages through a series of terms including *exametum*, *xamitum*, *sciamitum*, *samita*, *sametum* to the present day *samitum*, *samit*, or *samite*.<sup>119</sup> The term is understood to mean a weave unit of six warps comprising three binding and three main warps.<sup>120</sup> The structure is

normally associated with sophisticated drawlooms equipped with a figure harness for reproduction of woven patterns.<sup>121</sup> *Hexamitos* was listed in the 11<sup>th</sup>-century *Typikon of Gregory Pakourianos* as an altar covering.<sup>122</sup> The 11<sup>th</sup>-century testamentary description of Kale, wife of Symbatios Pakourianos, included a yellow *hexamiton* robe.<sup>123</sup> The *BOE* included a possible related form of the term, *blattia hexalia*, in reference to silks brought for trade by merchants from other nations.<sup>124</sup>

### **Summary of textile production terms**

Summarising textile production evidence, the work of the *serikarioi* in Constantinople included dyeing, weaving, and tailoring silks for sale to garment merchants. Among textile producers, dyers are most visible to us because of the high rate of Jewish participation and the stigma associated with the trade. Production of dyestuffs and chemicals used in the process was a major industry in its own right with an extensive international exchange network.

The work of professional weavers is less well documented, but seems to have included free men as well as slaves. Diverse skills were required with occupations specialised by material and function in a variety of workshop settings. Textile names provide additional details about the production and consumption of silk and other types of cloths in Byzantium. Categories defined in terms of description, material content, and weave structure refer to luxury goods as well as common items.

112. Serjeant 1972, 249, 37.

113. *Attal*, Gautier, 1782, 1793-1794.

114. *Theoph*, de Boor, 173, 3-6; *An Komn*, Leib, III, 5, 6.

115. *BOC*, Reiske, Comm., 539 A11. Note that Haldon carried over this interpretation in his analysis; see *Imp Exp*, 219-220 n. (C) 229.

116. Wipszycka 1965, 113, *P. Strasb.* 131, 9.

117. Wipszycka 1965, 112 n. 21; 113 n. 22.

118. Broughton 1938, 820.

119. Michel 1852, 106-108; also see Jacoby 2004, 229; Weibel 1935.

120. Becker 1987, 105. In a weave unit of six warps, the structure refers to a 1/2 twill with a 1:1 binding to main warp proportion.

121. CIETA 2006, 15; CIETA 1987, 16-24.

122. *Gre Pak*, Lemerle, 1733-1734.

123. *Iveron*, 364-371.

124. *BOE*, Koder, 9.6.442.



## Terms associated with textile decoration

### Colour

In middle Byzantine sources, the hierarchical arrangement of the court was communicated through silk fabric characteristics including colour, metal embellishment, and figured pattern woven designs.<sup>125</sup> James' analysis of Byzantine colours showed that perception was not defined solely by hue, but was also influenced by brilliance and saturation.<sup>126</sup> Some literary works conveyed colour intensity to indicate hierarchy. Psellos described the emperor as being garbed in robes of purple as compared with those of the empress in a less intense shade.<sup>127</sup> James traced colour terminology from early Byzantium into the middle period to show the evolution of perception toward a scheme dominated by specific definition of hues, a development particularly evident from the organisation of complex rituals.<sup>128</sup>

The most comprehensive source of colour information for the middle Byzantine period comes from the *BOC*. My analysis of the 217 instances of textile-related colour mentions in this text shows distinctive patterns in the use of terminology. Evidently, colour terms were edited for consistency during the reign of Constantine VII, including those used in chapters originally written in earlier centuries. Significant discrepancies in colour and other characteristics occur only in chapters 96 and 97, which were added to the compilation later, during the reign

of Nikephoros II Phokas (963-969). For example, the colour words *kastorion* and *halourgis* appear in chapters 96 and 97 respectively, but do not occur elsewhere in the text.<sup>129</sup>

Generic references to purple typically applied the word porphyry. Particular garments, ranks, and persons were described specifically in terms of murex-based dyes. Each of the 25 references to the purple *sagion* worn by high officials was recorded as *alethinios* for genuine or true purple.<sup>130</sup> Mention of a porphyry *sagion* occurred only once to describe a gold-bordered garment decorated with pearls worn by the emperor.<sup>131</sup> Regular patterns of use are also evident for other murex dye types. The coloured *tablion* applied to the chlamys worn by high officials were described in each of four instances as *oxeon*, a reddish-purple colour.<sup>132</sup> The word *tyrea* appeared only six times in the entire compilation, in each case for the ground colour of a chlamys worn by a patrician.<sup>133</sup> References to white followed a similar pattern. The white chlamys worn by high officials were described as *leukon* in 22 instances, and as *aspron* only once.<sup>134</sup> In each of the three instances that veils were worn by high-ranking women in ceremonies, the colour was *aspron*, not *leukon*.<sup>135</sup>

False purple, *pseudoxea*, was mentioned one time in the *BOC* for the tunics worn by the stewards of the table and again in the *Imperial Expeditions* treatise for belts dispatched to foreigners.<sup>136</sup> While some scholars have interpreted these mentions as evidence of the restriction of murex dyes to high court officials, this

125. Garments also played a role in the scheme and have been studied by various scholars. See Parani 2003, Dawson 2002, Piltz 1997.

126. James 1996, 79.

127. *Psellos*, Renault, III, 15, 35; 19, 9; 21, 9; James 1996, 81.

128. James 1996.

129. *BOC*, Reiske, I: 96, 438; 97, 440.

130. *BOC*, Reiske, I: 10, 81-82; 16, 98; 17, 98-100; 17, 104; 18, 109; 30, 167; 30, 169; 45, 231; 46, 236; 47, 241-244; 48, 250-251; 48, 254. II: 7, 539; 11, 549, 15, 575; 15, 587; 15, 590.

131. *BOC*, Reiske, II, 37, 634.

132. *BOC*, Reiske, I, 30, 162; II, 15, 575; II, 41, 641. For the meaning of *oxea*, see *Imp Exp*, 169 (B) 108-109.

133. *BOC*, Reiske, I: 23, 128; 35, 181; 55, 271; 72, 360; II: 41, 641.

134. *BOC*, Reiske, *leukon*: I: 1, 24; 10, 71; 11, 86; 12, 89; 15, 96; 19, 115; 27, 148; 29, 161; 30, 162; 32, 171; 47, 241-242; 51, 260; 264, 284; 68, 303; 86, 391; 91, 416-417; 92, 422; II: 15, 579; 15, 590; 51, 699; 51, 701; *aspron*: II: 30, 630.

135. *BOC*, Reiske, I: 50, 258; II: 24, 623-624.

136. *BOC*, Reiske, II: 15, 578; *Imp Exp*, C.244-245.

interpretation is problematic.<sup>137</sup> As textile researchers and conservators can attest, the composition of particular dyestuffs cannot be perceived by visual inspection.<sup>138</sup> Many compounds were used to achieve various colours and even murex-based dyes contained other substances.<sup>139</sup> Consequently, *pseudoxea* may have referred to some perceptual difference in hue or intensity, in addition to possible differences in chemical composition.

### *Metal and gemstones*

Application of gold and other precious metals to textiles was another way to demonstrate hierarchical ordering of the court in the middle Byzantine period. Conspicuous display of precious metals was an obvious way to project wealth and power. James' colour analysis showed the importance attributed to the visual qualities of metal with emphasis on iridescence, shine, and gleam.<sup>140</sup> While her study pertained to mosaics, the same concepts can be applied to textile evidence. Writing about literary and visual representation, Maguire suggested that gold in imperial portraits dematerialised imperial images as a means of associating them with angelic beings and conveying divine qualities.<sup>141</sup> Brubaker noted a similar use of gold in 9<sup>th</sup>-century manuscript painting to convey light, and by inference, as an expression of divinity.<sup>142</sup> Gold interwoven with silk or applied as embroidery would produce a similar effect.

In his 6<sup>th</sup>-century ekphrasis of Hagia Sophia, Paul

the Silentary blended perception of light with metal and colour in association with silk in his description of a gold-embroidered altar cloth:

“But by the web, the produce of the foreign worm, changing its coloured threads of many shades. Upon the divine legs is a garment reflecting a golden glow under the rays of rosy-fingered Dawn.”<sup>143</sup>

As described in the *BOC*, gold was applied to textiles through a variety of means including: weaving, embroidery, gilding, and applique. The terms *chrysoyphes* (χρυσσοϋφής) or *chrysoyphantos* (χρυσσοϋφαντος) described gold woven into textiles on the loom.<sup>144</sup> Two different types of gold embroidery were mentioned in the text. *Chrysokentetos* referred to gold yarns embroidered to the cloth surface (couched), while *chrysolenokentetos* was apparently a method of affixing tiny gold tubes to the cloth surface.<sup>145</sup> The literal translation of *chrysophenges* as bright or shining gold probably meant application of gold leaf to gild textiles.<sup>146</sup>

Other types of gold decorations were sewn to finished garments. *Chrysoepikleistos* was translated by Reiske as gold-bordered, and by Vogt as edged with gold, but Dawson suggested application of tablet woven gold bands.<sup>147</sup> *Chrysoklabos* referred to woven or applied bands running from shoulder to hem.<sup>148</sup> The related terms *chrysosementos* and *chrysa holosementos* have been interpreted as either appliqué or gold-patterned.<sup>149</sup>

137. For discussion of the meaning of the term, see Muthesius 1995a, 293; *Imp Exp*, 169 n. (B) 108-109; 224 n. (C) 244; Jacoby 1991-1992, 483.

138. For example, see Verheeken 2007.

139. The literature of historic dye technology is extensive and relies upon chemical analyses to determine chemical components. For a synthesis of historical dye stuffs, see Cardon 1999.

140. James 1996, 115.

141. See Maguire 1989, 228 for panegyric references to the sun and shining light.

142. Brubaker 1998, 37.

143. *Paul Sil*, Bekker, 767-771; tr. from Mango 1986, 88-89.

144. Dawson 2002, 27.

145. Dawson 2002, 26-27; Woodfin 2012, xxiv-xxvii.

146. Dawson 2002, 29-30.

147. *BOC*, Reiske, Comm. 52; *BOC*, Vogt, Comm. I, 30, Dawson 2002, 28-29.

148. Dawson 2002, 28.

149. *BOC*, Moffatt, 294 n. 2; Dawson 2002, 28.

Terminology for the types of gold decorations in the *BOC* followed the same general pattern as the prestige colours discussed above. General references to gold textiles used the word *chrysos*. Specific terms were used to describe garments in terms of a hierarchically ordered scheme. As we have seen, except for the two chapters added during the reign of Nikephoros II Phokas, the consistent use of terminology suggests that the texts were collectively edited for greater consistency in terminology.

The addition of gemstones or pearls to garments was mentioned in the *BOC* on four occasions.<sup>150</sup> The most elaborate garment was a *kolobin*, which was known by the name *Botrys*, meaning ‘bunch of grapes’.<sup>151</sup> The figured pattern silk garment was embroidered with gold thread and decorated with precious stones and pearls. A scholion to the *Imperial Expedition* treatise referred to a special *chiton* worn by the emperor when he entered the city in an imperial triumph. Known by the name ‘rose cluster’ (ρόδόβοτρυς), it was described as *chrysoyphantos* suggesting that the design was woven with silk and gold yarns.<sup>152</sup> The garment was “covered in pearls set in a criss-cross pattern, and with perfect pearls along the hems.”<sup>153</sup> Several authors including Attaleiates and Choniates mentioned the heavy weight of imperial garments and regalia.<sup>154</sup> Function and practicality limited the extent to which heavy embellishments could be applied to silks, so other means of distinguishing high status textiles had to be devised.

### **Representation**

In addition to colour and precious metals, representational patterns provided a third means of elevating

textiles and communicating hierarchy. Textual evidence concerning figured silks shows patterned weaves to be a clear extension of the Byzantine visual sphere in terms of both aesthetic perception and symbolic reference.

### *Aesthetic Perception*

In her study of colour perception in Byzantium, James documented descriptions from various authors demonstrating aesthetic appreciation for compositions involving variegated colours in forms such as mosaics, marble columns and peacock feathers.<sup>155</sup> In an encomium describing the interior of the Nea Church, the *Vita Basilii* integrated visual references for two different media. The text described the floor mosaics as first appearing “to be fully spread with rugs woven of silk or of *sidonian* fabrics.”<sup>156</sup>

Several mentions included in the corpus referred to the use of variegated colour, particularly in creating a layered, ambivalent experience. As a visual representation of Christ’s dual nature for the feast of the Nativity, high officials wore Tyrian purple and yellow-spangled (μηλινοκάθρυπτα) *chlamyses*.<sup>157</sup> The costume worn by the emperor for the feast of the Ascension represented a similar mingling of colour and pattern with the prescription of a multi-coloured *skaramagion*.<sup>158</sup>

Sources suggest that the two qualities that were especially prized in Byzantine colour combinations were contrast and association.<sup>159</sup> John Mauropous related his aesthetic appreciation of colour interpolation in an 11<sup>th</sup> century epigram “beauty is created when two contrasting colours are wonderfully blended together.”<sup>160</sup> The medium of figured textiles required patterns to be woven with contrasting colours at a

150. *BOC*, Reiske, I: 10, 80; II: 1, 522; 15, 580; 37, 634.

151. *BOC*, Reiske, I: 10, 80, 86; ὁ βασιλεὺς κολόβιν τριβλάτιον χρυσοσωληνοκέντητον, διὰ λίθων καὶ μαργάρων ἡμφιεσμένον, ὃ καὶ βότρυς καλεῖται.

152. *Imp Exp*, C.750-752, 759.

153. *Imp Exp*, C.750-752.

154. *Attal*, Brunet, 36, 19, 8-9; *Nik Chon*, Dieten, 273.

155. James 1996, 125-127.

156. *V. Basilii*, 84.13.

157. *BOC*, Reiske, I: 23, 128; see *BOC*, Moffatt, 294 n. 2; *LBG*: (μήλινος + καθρύπτης) mit gelben Spiegeln (Pailletten).

158. *BOC*, Reiske, I: 37, 188; τριβλατίων σκαραμαγγίων.

159. James 1996, 122.

160. *Ioan Maur*, Epigram 100, 51-52.

scale appropriate for the intended viewing distance. For the reception of the foreign ambassadors, the *protospatharioi* wore green and pink *skaramangia* while the *spatharokandidatoi* and the *spatharioi* wore other colour combinations.<sup>161</sup>

### *Symbolism*

Interpretation of figured patterns described in historical sources requires critical analysis of source evidence to examine intention. Relying on earlier sources, Theophanes Confessor conveyed Byzantine suzerainty over Lazica by describing the investiture garments worn in 522 by Tzathios which bore embroidered images of Justin I (518-527).<sup>162</sup> The iconoclasm controversy was clearly referenced in Theophanes' description of the donation made by Michael I (811-813) on the investiture of his son, Theophylaktos. Michael renewed a set of four curtains of ancient manufacture "splendidly embroidered in gold and purple and decorated with wonderful sacred images."<sup>163</sup>

Several scholars have investigated patterned silks to explore how textile representation was influenced by iconoclasm.<sup>164</sup> Based on documentary evidence and available technical information about figured silks, Brubaker concluded that the imperial silk workshop remained active during iconoclasm, but that subject matter alone is an insufficient guide for dating.<sup>165</sup> For the middle Byzantine period, Maguire examined the way that costume was used to present the emperor and his court as counterparts to the invisible court of Christ.<sup>166</sup> In his study of liturgical vestments in Byzantium, Woodfin showed the later transformation of Byzantine liturgical dress from its middle Byzantine basis in the imagery and forms of the imperial court.<sup>167</sup>

Figured textiles were visible not only to court officials in imperial ceremonies, but also to the

population of Constantinople. Choniates described the imperial triumph declared in 1133 by Emperor John II Komnenos (1118-1143) to mark the capture of Kastamon. For the occasion, the streets were decorated with gold-embroidered purple cloths as well as woven images of Christ and the saints.<sup>168</sup>

### *Summary of textile decoration terms*

The properties of silk made it a highly adaptable medium for expression. The high dye receptivity of the material provided a means to convey rank through colour with the capacity for nuanced presentation of information. Like metal, silk reflects light to display a shimmering, radiant presence. Combining colour with gold intensified the visual display of wealth and divine qualities. While gold was applied to silk garments and furnishings through every available means, representations provided another device to communicate hierarchy. Woven patterns coincided with aesthetic preferences for variegated colours. Use of textiles for symbolic representation in garments provided a powerful means of projecting information with the advantages of portability and intimate association with the wearer.

### **Terms for woven pattern designs**

#### *Imperial restrictions*

Chapter 8 of the *BOE* reflected imperial efforts to maintain the exclusivity of imperial silks. The text defined certain goods as *kekolymena*, meaning forbidden or prohibited. The *serikarioi* were permitted to produce certain types of silk for sale to the *vestiopratai*. These restrictions were not applicable when the eparch commissioned silks to be woven for purchase

161. *BOC*, Reiske, I:15, 576.

162. *Theoph*, de Boor, 168, 23-26.

163. *Theoph*, de Boor, 494, 29-31; tr. from *Theoph*, Mango, 678; for re-editing and embellishing earlier iconoclastic sources, see Brubaker & Haldon 2001, 166.

164. See Maguire 1996, 100-106, 137-145; Muthesius 1997, 2, 60, 68-72, 146.

165. Brubaker & Haldon 2011, 338-340.

166. Maguire 1997, 247-258.

167. Woodfin 2012.

168. *Nik Chon*, Dieten, 18, 81-84.

by the state.<sup>169</sup> The implication is that *serikarioi* had the material resources and technical capabilities necessary to produce at least some types of imperial or sub-imperial quality silks when required, but were otherwise prohibited from doing so. The penalty for making prohibited weaves or for selling a slave who knew how to produce such silks to a foreigner was to have a hand cut off.<sup>170</sup> The consequence of delivering silks made abroad to the imperial storeroom (*basilikon kylistareion*) was to be flogged and shaved.

The particulars of prohibited goods are listed in *BOE* paragraphs 8.1, 8.2, and 8.4. These sections are difficult to interpret because the specific terms are not meaningful in literal translation. What is clear is that the regulations referred to categories of attributes. Paragraph 8.4 explicitly prohibited use of murex dyes for particular types of textiles. Paragraphs 8.1 and 8.2 restricted production of high value silks of one or more colours and in certain combinations, including those that gave variegated or multi-coloured effects. Another prohibition pertained either to the size of a finished cloth, or more likely, the scale of a pattern repeat.<sup>171</sup>

A monetary limit was placed on the maximum value of goods produced by the *serikarioi*. Any garment worth more than ten *nomismata* had to be reported to the eparch.<sup>172</sup> The regulation also applied to the guild of the *vestiopratai*.<sup>173</sup> This same market value limit appeared in the *Imperial Expedition* treatise. The *eidikon* was responsible for purchasing various types of garments from the marketplace for values up to ten *nomismata*. Purchased items included Egyptian silks and locally made purple garments. These were intended as gifts for foreigners and for military

officials in the event of a rewards presentation at a military camp (*aplekton*).<sup>174</sup>

References to loom technology and quality of workmanship are evident in chapter 8 of the *BOE*. Paragraph 8.3 required inspection of silk looms and equipment by certain officials, the *mitotes*, under the authority of the eparch, to ensure that imperial quality goods were not being produced. The inference is that inspectors monitored textiles on workshop looms as they were being woven. Finished goods were also examined by the *boullotes* and required the eparch's seal. Paragraph 8.9 defined the consequences of not having seals affixed to bales of finished cloths.

Regulations for the *serikarioi* defined three qualitative categories of silks: high (*megalozela*), medium (*mesozelon*) and lower quality (*leptozelon*).<sup>175</sup> The *Imperial Expedition* treatise used these same terms to describe the qualities of woven silks produced in the imperial workshop.<sup>176</sup> The *BOE* regulations strictly prohibited production of goods in the high and medium categories, but some lower quality items were allowed. While the full set of attributes involved in grading silks are not clear to us, quality references included yarn type, and possibly diameter.

### *Polychrome pattern weaves*

Scholars have long puzzled over the meaning of *triblattia* and *diblattia*, which appeared only in association with imperial or high prestige silks. In the sources included in the corpus, *triblattia* and *diblattia* were specifically named 15 and 16 times respectively. In addition to four mentions in the *BOE*,<sup>177</sup> the terms appeared five times in the *BOC*,<sup>178</sup> 15 in the *Imperial*

169. Note that spelling of *idikon* is from the text, as compared with *eidikon* elsewhere. *BOE*, Koder, 8.2: ἐχτὸς τῶν ἐχόντων ὀρισθῆναι παρὰ τοῦ ἐπάρχου πρὸς χορηγίαν τοῦ ἰδικοῦ.

170. *BOE*, Koder, 8.11.

171. *BOE*, Koder, 8.1, 378-379: τὰ δὲ βλαττία κατὰ περσικίων ἢ δισπίθαμα χλανίδια ἐμφανιζέσθωσαν τῷ ἐπάρχῳ....

172. *BOE*, Koder, 8.1, 379-380.

173. *BOE*, Koder, 4.2.

174. *Imp Exp*, C.290-293, 510-511.

175. *Imp Exp*, 217-219 n. (C) 226.

176. *Imp Exp*, C.225-242.

177. *BOE*, Koder, 8.1, 8.4.

178. *BOC*, Reiske, I: 10, 80, 11; 37, 188, 21; 48, 255, 7-8; 97, 442, 1-2; II: 15, 581, 2.

*Expeditions* treatise,<sup>179</sup> five in Attalates' *Diataxis*,<sup>180</sup> once in the *Typikon of Gregory Pakourianos*.<sup>181</sup>

Considering these sources collectively, the terms were used explicitly in conjunction with colour words in 11 instances and in association with figured patterns in 13 cases. In the *BOC*, *triblattia* was used coincidentally with a description of a chlamys patterned with a plane tree design.<sup>182</sup> This mention was immediately preceded and followed by a number of other descriptions referring to various patterns including griffins, lions, horsemen, and peacocks. The *Imperial Expeditions* treatise included several mentions of *diblattia* decorated with eagles and other imperial symbols in various colour combinations.<sup>183</sup> For the reception of the Saracen ambassadors in the *BOC*, the emperor put on his eagle pattern chlamys to receive the guests.<sup>184</sup> The *Diataxis* included a *diblattia* silk with a yellow griffin design.<sup>185</sup> The text also listed a purple *diblattia* curtain with a design of peacocks in conches.<sup>186</sup> For the feast of the Nativity in the *BOC*, some high officials wore chlamyses that were patterned with a design of peacocks in conches.<sup>187</sup>

In his 17<sup>th</sup>-century Latin glossary, Du Cange defined *triblattia* as a three-colour cloth and included a description by Peter Damian.<sup>188</sup> Reiske interpreted the term to mean either the number of times a silk was placed in a dye bath or a type of polychrome textile. Although some scholars have adopted the dye bath interpretation, this explanation is inconsistent with colour processing.<sup>189</sup> Submitting a cloth to multiple baths

of the same colour would not produce reliably perceivable gradations in colour intensity to support distinct terminology.<sup>190</sup>

Guilland adopted Reiske's second explanation and concluded that *di-* and *triblattia* referred to solid strips of various colours applied to a ground fabric that was usually purple in colour.<sup>191</sup> His analysis did not propose a method of application, nor did he describe the location or physical dimensions of the strips. To explain the coincidence of *triblattia* with pattern descriptions, he suggested that the designs were embroidered onto the applied colour strips.<sup>192</sup> He concluded by suggesting that the number of bands applied to a garment was an indication of hierarchy and might have designated rank in the manner of *clavi*.<sup>193</sup>

Despite its general acceptance, Guilland's explanation is problematic. Incidence and context indicate that *di-* and *triblattia* occupied a high position in the hierarchy of textiles in imperial use and contributed to the sublime presentation of the emperor and his immediate retinue. Colour banding is among oldest and most common forms of embellishment, in part because it provides a way to recycle used or damaged coloured textiles. In the middle Byzantine period, materials for coloured strips were widely available, required no special processing or skills, and could have been worn by many persons in society. For the purpose of elite differentiation, colour bands would have been inconsistent with use of fine silks, exclusive dye-stuffs, and precious metals.

179. *Imp Exp*, C.173, 213, 235, 236, 240, 242, 251, 258, 503, 508, 732, 783.

180. *Attal*, Gautier, 1306, 1779, 1887, 1792.

181. *Gre Pak*, Lemerle, 1728.

182. *BOC*, Reiske, II: 15, 581, 1-2. A plane tree is deciduous variety with a broad canopy.

183. *Imp Exp*, C.240-242, 251-253.

184. *BOC*, Reiske, II: 15, 587, 21.

185. *Attal*, Gautier, 1787-1788.

186. *Attal*, Gautier, 1376-1377.

187. *BOC*, Reiske, I: 23, 128, 14.

188. Du Cange & Carpentier 1733, VI, 1277.

189. This interpretation was carried over in Muthesius 2002, 163. For addition discussion with respect to *blattia* and dyes, see Dawson 2002, 22-26.

190. See Edmonds 2000 for an explanation of murex dye bath preparation and use.

191. Guilland 1949, 339-348.

192. Guilland 1949, 347.

193. Guilland 1949, 348. Several scholars including Haldon have adopted Guilland's interpretation; See *Imp Exp*, 205-207 n. (C) 173.

As Guiland pointed out, several different kinds of garments were made from *di-* and *triblattia* such as: *chlamys*, *skaramagia*, *kolobia*, *divetesia*, and tunics. Furnishings included cushion covers, curtains, altar cloths, hangings, and untailed lengths of cloth. Affixing coloured bands to a variety of different garments would have created a disparate appearance in the otherwise formalised and coherent system of vesture, particularly for items embellished with clavi. A ranking system for furnishings based on coloured bands is difficult to imagine. The idea of affixing coloured strips to unsewn lengths of cloth seems especially questionable since they might later have been made into tailored items. The corpus contains various references to the use of stripes for decoration on some garments, but only occasionally in association with high officials or the emperor in a ceremonial context.<sup>194</sup> Moreover, no written work included in the corpus attached symbolic or aesthetic importance to the use of colour bands.

A telling reference comes from the *Book of Gifts and Rarities*.<sup>195</sup> Included among the elaborate gifts sent by Emperor Romanos I Lekapenos (920-944) to Caliph al-Radi bi-Allah (934-940) in 938 were several brocade cloths:

“One with a design of eagles in two colours, another with a floral [design] in three colours, another also with three-coloured stripes, a red one with coloured foliate design, the design of yet another [represents] trees on a white ground, two with a design [representing] a hunter set in a roundel on a white ground, two with crouching lions on a yellow ground, two eagles in roundels....”<sup>196</sup>

The conclusion from the discussion above is that *diblattia* and *triblattia* were the middle Byzantine terms for imperial quality weft-faced compound weave figured silks. This explanation is consistent with descriptions of aesthetic and symbolic preferences as related through a variety of written sources. This analysis also agrees with accounts of pattern use and colour terminology.<sup>197</sup> Examples of two colour *diblattia* type cloths are shown in Figs. 2 a-c.; Figs. 3 a-c provide examples of three colour *triblattia* silks.

Scholars including Guiland have questioned why only one or two colours at most were named in conjunction with *triblattia* and *diblattia*.<sup>198</sup> In the prescriptive sources that included these terms, the purpose of recording information was for identification rather than comprehensive description. For a bi-colour *diblattia*, either the pattern or the ground was named. Polychrome silks with three or more colours would have had a dominant pattern colour and a ground. Reference to other colours would have been cumbersome and unnecessary. For example, a cloth described as *oxea leukotriblatton* would have had a white dominant pattern colour on a red-purple ground.<sup>199</sup>

As noted by Guiland and others, there were clear status distinctions between *triblattia* and *diblattia*. Each of the seven instances of multi-coloured patterned silks worn by the emperor was *triblattia*. Only the cushions provided for the emperor to recline while on campaign were *diblattia*. *Triblattia* silks were awarded only to the *strategos* of important themes. All other senior officials received various qualities of *diblattia* with different imperial symbols according to rank. The implication is that the privilege of wearing variegated colours in a polychrome

194. For a possible exception, see *Imp Exp*, C.241-242; 257-258.

195. The *Book of Gifts and Rarities* comes from an Arabic manuscript dating from the Ottoman period and covers the 7<sup>th</sup> to 11<sup>th</sup> centuries for the Islamic world. The text conveys extensive details about textiles and other valuable and exotic items involved in court exchanges. Recently, Christys examined the text as a historical resource. Her analysis of the purported embassy of Queen Bertha to Baghdad in 906 demonstrates some of the ways the text was altered to meet the needs and tastes of court writers. See Christys 2010, 160-161.

196. *Gifts*, 99-101.73.

197. Dawson 2002, 25-26 concluded that *tri-* and *diblattia* filled a terminology gap in the *BOC* as a technical term for figured pattern weaves.

198. Guiland 1949, 342.

199. *Attal*, Gautier, 1790-1792.

a.)



b.)



c.)



Figures 2a-c. Examples of *'diblattia'* weft-faced compound weave figured silks, photos by J. Galliker. a.) AN34973001 © Trustees of the British Museum. b.) 11.90 © Museum of Fine Arts, Boston. c.) 33.648 © Museum of Fine Arts, Boston.



a.)



b.)



c.)



Figures 3a-c. Examples of 'triblattia' weft-faced compound weave figured silks, photos by J. Galliker. a.) 1902.1.221 © Cooper Hewitt, Smithsonian Design Museum. b.) BZ.1927.1 © Dumbarton Oaks, Byzantine Collection, Washington, DC. c.) 1902.1.222 © Cooper Hewitt, Smithsonian Design Museum.

weave was a prerogative reserved for the emperor and the most senior officials. Patterns for lesser officials were available only in bi-colour silks. The wearing of patterns and particular colours to designate rank was clearly defined by the *BOC*:

“Note that on the actual day of the reception, all those mentioned previously, from the *protospatharioi* down to the lowest ranking person wearing *skaramangion*, stood each according to the colour and pattern of his *skaramangion*, that is, those wearing the pink and green eagles to either side, those wearing the owls and the many-circled eagles, likewise those wearing the wave pattern, and likewise those wearing the white lions.”<sup>200</sup>

### *Monochrome pattern weaves*

An important type of patterned weave comparable to *tri-* and *diblattion* in complexity and importance has barely been noticed in the secondary literature.<sup>201</sup> In the *BOC* and the *Imperial Expedition* texts, monochrome pattern silks were identified by the combination of a colour name with the prefix *di-*. Translated literally, *diaspron* meant two whites, a reference to tone-on-tone patterning effect.<sup>202</sup> The *Diataxis* used a similar term, *blattion diphoton*, to describe a silk pectoral garment.<sup>203</sup> With the literal meaning of two shades or tones, the use of *diphoton* to describe a silk cloth suggests a monochrome patterning effect.<sup>204</sup> The designs in monochrome weaves were formed either by incised lines or by the textural contrast of a pattern against a ground. In either case, the effect would have

been subtle and elegant. Both structures were forerunners of true damask, a modern term which itself alludes to its historical production centre, Damascus.<sup>205</sup>

Additional interpretational evidence is provided by the incidence of colours attested. The 16 mentions of the weave included: six white, four pink or rose, three yellow, and three blue. Monochrome patterns were often woven in white or light colours because textural contrasts are more easily perceived. The same paragraph of the *BOE* that prohibited the *serikarioi* from weaving *triblattion* and *diblattion* included a third term, *dimoiroxea*, which is conventionally translated as two-thirds purple.<sup>206</sup> Given the naming conventions for monochrome patterns in other sources, the term *dimoiroxea* may have referred to imperial quality ‘damask’ figured silks.<sup>207</sup>

In the *BOC*, usage context shows that monochrome patterned silks were part of the hierarchical ordering of textiles when all attendants wore white garments. For the most holy festivals – Easter Sunday, Eve of the Epiphany and the Wednesday of mid-Pentecost – only the emperor wore *diaspron* garments. The weave was also used to indicate seniority during the reign of Nikephoros II Phokas. As described in chapter 96, the president of the senate wore a pink ‘damask’ (*dirodinon*) *chiton* on appointment, and a pink ‘damask’ *sagion* shot with gold on feast days.<sup>208</sup>

By analogy to the hierarchical distinction between *triblattion* and *diblattion*, monochrome patterned weaves may have been ranked according to the quality of light. One-colour patterns in the brightest hues seemed to occupy the most superior position in the hierarchy associated with the weave. Coloured ‘damasks’ were included among the goods prepared for the expedition against Crete in 911 as

200. *BOC*, Reiske, II: 577-578, tr. from *BOC*, Moffatt, 577-578.

201. For a brief discussion of the term, but without reference to particular sources, see Muthesius 1995a, 296. For the word *diprosopon*, see Koukoules 1948-1952, 2.2, 33. For a discussion monochrome weave structures: Muthesius 1997, 85-93. For explanation of monochrome patterning methods, see Becker 1987, 118-129.

202. The meaning of *diaspra* was interpreted by Haldon as either a warp and weft of different colours or multiple dye baths. See *Imp Exp*, 217 n. (C) 225.

203. *Attal*, Gautier, 1798.

204. *Attal*, Talbot, 371 n. 48.

205. CIETA 2006, 12.

206. *BOE*, Koder, 8.4; *BOE*, Freshfield, 8.4.

207. For the sake of brevity, the term used here for monochrome pattern weaves is ‘damask’ to designate the category of such structures.

208. *BOC*, Reiske, I: 97, 440, 443.

gifts for senior officials.<sup>209</sup> In the *Kletorologion of Philotheos*, doctors wore blue ‘damask’ *skaramagia*.<sup>210</sup> As with polychrome figured silks, monochrome patterned weaves were used for furnishings as well as garments. Sets of pink ‘damask’ curtains were hung in the Hippodrome festival held for the Saracen ambassadors.<sup>211</sup>

Among the various characteristics that contributed to the hierarchical ordering of silks, quality is the most difficult to interpret from written sources. In addition to dividing textiles into high, middle, and low categories, the *Imperial Expeditions* treatise referred to subcategories for some items comprising first, second, and third grades. Haldon noted that use of tripartite grading systems was longstanding, with similar references in the *Edict of Diocletian*.<sup>212</sup> Both the *BOC* and the *Imperial Expedition* texts indicate that the qualitative hierarchy of textile gifts was visible and understood by the giver and receiver as well as the broader community of observers.<sup>213</sup> The limitation of textual evidence is that we do not know the specific textile characteristics that distinguished imperial and non-imperial categories of goods, nor do we understand the basis for ranking within each category. Nevertheless, we can surmise that this ‘qualitative hierarchy’ resulted in tangible differences in workshop practices by textile type.

### *Summary of woven pattern terms*

Pattern weaving technology provided a means of differentiating imperial silks given the long-standing problem of imitative colour and metal use. By the middle Byzantine period, textile prerogative was defined by a combination of elements that were modulated according to need. Information was conveyed through the interaction of components including garment type, material composition, precious metals, applied embellishments, and colour combinations.

Description of particular prohibitions provides the best available definition of the properties that

constituted imperial quality silks. As interpreted in this section, these included particular dyestuffs, colour combinations, pattern scale, yarn size, quality attributes, and monetary value. Critical analysis clarifies the long-debated meaning of *di-* and *triblattia* as bi-colour and polychrome weft-faced compound weave figured pattern silks. Although they had less apparent visual impact, the use of *diaspron* pattern weaves was a means of designating rank on occasions when the ceremonial rite called for one-colour garments.

### **Conclusion**

This analysis provides a synthesis of 57 terms from Byzantine sources pertaining to or used in association with silk. Considered collectively, silk terminology provides a body of evidence to examine the role and social importance of silk in the material culture of the middle Byzantine period. In contrast to the lingering perception that silk was an imperial monopoly, the material appears to have been widely available in Constantinople as well as in provincial towns. Silk fibre trade and processing terms suggest a highly developed international industry.

As compared to other fibres, silk was considered to be relatively luxurious, but was only one factor contributing to the value of a particular textile. While silk remained a luxury fibre on a comparative basis, not all luxury items contained silk and not all silk-based textiles were high value goods. Terminology analysis indicates that various types of low quality silk products were produced in response to consumer demand.

The extensive lexicon associated with textile decoration demonstrates the adaptability of silk as a medium of expression. It also demonstrates that the desire for elite differentiation spurred development of new materials and methods. Production of complex figured silks woven on specialised looms in the imperial silk workshop provided a means of limiting

209. *BOC*, Reiske, II: 44, 661.

210. *Listes*, 183.20.

211. *BOC*, Reiske, I: 15, 589.

212. *Imp Exp*, 224 n. (C) 243-244.

213. For example *BOC*, Reiske, I: 44, 227-230; II: 18, 607; *Imp Exp*, C.503-511.

imitative products. *Triblattia*, *diblattia* and high quality ‘damask’ weaves were technical and institutional adaptations to elevate precious silks as an imperial resource.

### Bibliography - Primary Sources

- Act Pantel = *Actes de Saint-Pantéléemôn*. (1982) P. Lemerle, G. Dagron & S.M. Ćirković (eds.) Archives de l’Athos.12, Paris.
- Agathan = Agathangelos (1973) *La version grecque ancienne du livre arménien d’Agathange*. G. Lafontaine (ed. & tr.) Louvain-la-Neuve.
- Animalibus = Phile de Animalibus, Elephante, Plantis, etc. (1862) In F. Dübner (ed. & tr.) *Poetae Bucolici et Didactici*. Paris, 1-70.
- An Komn = Komnène, Anna (2006) *Alexiade: règne de l’empereur Alexis I Comnène, (1081-1118)*. B. Leib & P. Gautier (ed. & tr.) Paris; English tr., E.R.A. Sewter & P. Frankopan (2009) as *The Alexiad*. London.
- Attal, Brunet = Attaleiates, Michael (1853) *Michaelis Attaliothae Historia*. W. Brunet de Presle & I. Bekker (eds.) Bonn; English tr., A. Kaldellis & D. Krallis (2012) as *The History*. Cambridge, MA.
- Attal, Gautier = Attaleiates, Michael (1981) La Diataxis de Michel Attaliate. P. Gautier (ed.) *Revue des études byzantines*, 39, 5-143; English tr., A.-M. Talbot (2000) as Rule of Michael Attaleiates for his Almshouse in Rhaidestos and for the Monastery of Christ Panoiktirmon in Constantinople. In J. Thomas, A.C. Hero & G. Constable (eds.) (tr.) *Byzantine Monastic Foundation Documents: A Complete Translation of the Surviving Founders’ Typika and Testaments*. Washington, DC, 326-376. Available online at: <http://www.doaks.org/resources/publications/doaks-online-publications/byzantine-monastic-foundation-documents/typ027.pdf>
- Basilika = *Basilicorum libri LX*. (1953) H.J. Scheltema, N. van der Wal & D. Holwerda (eds.) Groningen.
- Be Tud = *The Itinerary of Benjamin of Tudela*. (1907) M.N. Adler (ed. & tr.) London.
- BOC = Constantine VII Porphyrogenitus (1829) *De Ceremoniis Aulae Byzantinae*. J.J. Reiske (ed. & tr.) Bonn; text and partial French tr. A. Vogt (1967) as *Le livre des cérémonies*. Paris; English tr., A. Moffatt & M. Tall as *The Book of Ceremonies*. Canberra.
- BOE = *Das Eparchenbuch Leons Des Weisen*. (1991) J. Koder (ed. & tr.) Corpus Fontium Historiae Byzantinae, 33, Vienna; French tr., J. Nicole (1893) *Le livre du préfet: ou L’édit de l’empereur Léon le Sage sur les corporations de Constantinople*. (1893) Geneva; English tr., E.H. Freshfield (1938) as *Ordinances of Leo VI c. 895 from the Book of the Eparch*. Cambridge.
- Boilas = Le Testament d’Eustathios Boilas (avril 1059). (1977) P. Lemerle (ed. & tr.) in: *Cinq études sur le XIe siècle byzantin*. Paris, 13-63.
- De Adm Imp = Constantine VII Prophyrogenitus (1967) *De Administrando Imperio*. G. Moravcsik & R.H.J. Jenkins (ed. & tr.) Washington, DC.
- Dem Chom = Chomatenos, Demetrios (2002) *Demetrii Chomateni Ponemata diaphora*. G. Prinzing (ed. & tr.) Berlin.
- Gifts = *Kitāb al-Hadāyā wa al-Tuḥaf*. (1996) G.H. Qaddūmī (ed. & tr.) Cambridge, MA.
- Gre Pak = Gautier, P. (1984) Le typikon du sébaste Grégoire Pakourianos. *Revue des études byzantines*, 42, 5-145; also P. Lemerle (1977) Le typikon de Grégoire Pakourianos (décembre 1083) in *Cinq études sur le XIe siècle byzantin*. Paris.
- Imp Exp = Constantine VII Porphyrogenitus (1990) *Three Treatises on Imperial Military Expeditions*. J.F. Haldon (ed. & tr.) Vienna.
- Ioan Maur = *Johannis Euchaitarum Metropolitae quae in Codice Vaticano Graeco 676 supersunt Joh. Bollig descripsit Paulus de Lagarde edidit*. (1882) Lagarde, de P. & J. Bollig (eds.) Göttingen.
- Iveron = Ek tou archeiou tes en Hagio Orei Hieras Mones ton Iveron: Vyzantinai diathekai. (1930-1931) I. Iverites (ed.) *Orthodoxia*, 60, 66, 614-618, 364-371.
- Jo Apok = Apokaukos, J. (1971-1974) Unedierte Schriftstücke aus der Kanzlei des Johannes Apokaukos des Metropoliten von Naupaktos (in Aetolien). N.A. Bees (ed. & tr.) *Byzantinisch-neugriechische Jahrbücher*, 21, 55-160.
- Kos Ind = Cosmas Indicopleustes (1968) *Topographie chrétienne*. W. Wolska-Conus (ed. & tr.) Paris; English tr., J.W. McCrindle (1897) as *Kosmai Aiguptiou Monachou Christianik e Topographia. The Christian Topography of Cosmas, an Egyptian Monk*. London.

- LBG = Trapp, E. & W. Hörandner (1994) *Lexikon zur Byzantinischen Gräzität*. Vienna.
- Leo Diac = *Leonis diaconi Caloensis Historiae libri decem*. (1828) C.B. Hase (ed.) *Corpus Fontium Historiae Byzantinae*, Bonn; English tr., A.-M. Talbot & D.F. Sullivan (2005) as *The History of Leo the Deacon: Byzantine Military Expansion in the Tenth Century*. Washington, DC.
- Leo Syn = *The Correspondence of Leo, Metropolitan of Synada and Syncellus*. (1985) M.P. Vinson (ed. & tr.) Washington, DC.
- Listes = *Le listes de préséance byzantins des IXe et Xe siècles*. (1972) N. Oikonomides (ed. & tr.) Paris.
- Mammātī = Ibn Mammātī, As'ad ibn al-Muhadhhab (1943) *Qawānīn al-dawāwīn*. A.S. Atiya (ed.) Cairo.
- Menand = *The History of Menander the Guardsman: Introductory Essay, Text, Translation and Historical Notes*. (2006) R.C. Blockley (ed. & tr.) Liverpool.
- Mich Chon = Choniates, M. (1879) *Michaēl Akominatou tou Chōniatou Ta sōzomena*. S.P. Lampros (ed.) Athens.
- Nik Chon = Choniates, Nicetas (1975) *Nicetae Choniatæ Historia*. Diäten, J.L. van (ed.) *Corpus Fontium Historiae Byzantinae*, 11, 1-2, Berlin; English tr., H.J. Magoulias (1984) as *O City of Byzantium: Annals of Niketas Choniates*. Detroit.
- Nikeph = Nikephoros (1990) *Short History*. C.A. Mango (ed. & tr.) *Corpus Fontium Historiae Byzantinae*, XIII, Washington, DC.
- Nov Leo VI = *Les Nouvelles de Léon VI le Sage*. (1944) P. Noailles & A. Dain (eds.) Paris.
- Patmos, Astruc = Astruc, C. (1981) L'Inventaire dressé en septembre 1200 du trésor et de la bibliothèque de Patmos. *Travaux et mémoires*, 8, 15-30.
- Patmos, Oikon = Oikonomides, N. (1972) Quelques Boutiques de Constantinople au XE S.: Prix, Loyers, Imposition (Cod. Patmiacus 171). N. Oikonomides (tr.) *Dumbarton Oaks Papers*, 26, 345-356.
- Paul Sil = Paulus Silentarius (1837) *Pauli Silentarii descriptio S. Sophiae et ambonis*. I. Bekker (ed.) Bonn
- Prok, De Bello Goth = Prokopios (1833) *Corpus Scriptorum Historiae Byzantinae Pars II Procopius*. B.G. Niebuhr (ed.) Bonn.
- Psellos = Psellus, Michael (2006) *Chronographie ou histoire d'un siècle de Byzance (976-1077)*. É. Renauld (ed. & tr.) Paris; English tr., E.R.A. Sewter (1953) as *The Chronographia of Michael Psellus*. (ed. & tr.) London; English tr., K.N. Sathas (1979) as *The History of Psellus*. New York.
- Rh Sea = *Nómos Rodiōn naytikós The Rhodian Sea-law*. (1909) W. Ashburner (ed. & tr.) Oxford.
- Skyl = Scylitzes, Ioannes (1973) *Ioannis Scylitzæ Synopsis historiarum*. H. Thurn (ed.) *Corpus Fontium Historiae Byzantinae*, Berlin.
- Syllabus = *Syllabus Graecarum membranarum quae partim Neapoli in maiori tabulario et primaria bibliotheca partim in Casinensi Coenobio ac Cavensi et in episcopali tabulario Neritino iamdiu delitescentes et a doctis frustra expetitae*. (1965) F. Trincherà (ed.) Rome.
- Sym Metaph = Metaphrastes, S. (1827) *Anekdotæ: Anecdota Graeca e codicibus regiis*. J.F. Boissonade (ed.) V, Paris.
- Theo Byz = *Theophanes Byzantius*. (1841) K. Müller (ed.) 4, Paris.
- Theod Stoud = *Theodori Studitæ Epistulae*. (1992) G. Fatouros (ed.) *Corpus Fontium Historiae Byzantinae* 31, 2, Vienna.
- Theoph = Theophanes (1883) *Theophanis Chronographia*. de Boor, Carolus (ed.) Leipzig; English tr., C.A. Mango, R. Scott & G. Greatrex (1997) as *The Chronicle of Theophanes Confessor: Byzantine and Near Eastern History, AD 284-813*. Oxford.
- V. Basilii = *Chronographiae quae Theophanis Continuatī nomine fertur Liber quo Vita Basilii Imperatoris amplectitur*. (2011) I. Ševčenko (ed. & tr.) New York.
- V. Kauleas = *Monumenta graeca et latina ad historiam Photii patriarchae pertinentia*, I. (1899) A. Papadopoulos-Kerameus (ed. & tr.) St. Petersburg.

### Bibliography - Secondary Literature

- Becker, J. (1987) *Pattern and Loom*. Copenhagen.
- Beckwith, J. (1974) Byzantine tissues. In M. Berza & E. Stănescu (eds.) *Actes due XIVe Congrès international des études byzantines (6-12 September, 1971)*. Bucarest, 344-353.
- Broughton, T.R.S. (1938) Roman Asia Minor. In F. Tenny (ed.) *An Economic Survey of Ancient Rome*. Baltimore, 499-916.

- Brubaker, L. (1998) *Vision and Meaning in Ninth-century Byzantium: Image as Exegesis in the Homilies of Gregory of Nazianzus*. Cambridge.
- Brubaker, L. & Haldon, J. (2001) *Byzantium in the Iconoclast Era (ca 680-850): The Sources*. Aldershot.
- Brubaker, L. & Haldon, J. (2011) *Byzantium in the Iconoclast Era, c. 680-850: A History*. Cambridge.
- Cardon, D. (ed.) (1999) *Teintures précieuses de la Méditerranée: pourpre, kermes, pastel/Tintes preciosos del Mediterráneo: púrpura, quermes, pastel*. Musée des Beaux-Arts, Carcassonne/Centre de Documentació i Museu Tèxtil, Terrassa. Carcassonne.
- Christys, A. (2010) The Queen of the Franks Offers Gifts to the Caliph al-Muktafi. In W. Davies & P. Fouracre (eds.) *The Languages of Gift in the Early Middle Ages*. Cambridge, 149-170.
- CIETA (1987) *Notes on Hand-Weaving Techniques in Plain and Figured Textiles (English)*. Lyon.
- CIETA (2006) *Vocabulary of Technical Terms*. Lyon.
- Connor, C.L. (2004) *Women of Byzantium*. New Haven, CT.
- Dagon, G. (2002) The Urban Economy, Seventh-Twelfth Centuries. In A.E. Laiou (ed.) *The Economic History of Byzantium*. Washington, DC, 393-461.
- Dawson, T. (2002) *The Forms and Evolution of the Dress and Regalia of the Byzantine Court: c. 900 - c. 1400*. PhD, unpublished dissertation, University of New England.
- De Lange, N. (1996) *Greek Jewish Texts from the Cairo Genizah*. Tübingen.
- Du Cange, C.D.F. & Carpentier, P. (1733) *Glossarium ad scriptores mediae et infimae Latinitatis*. Paris.
- Edmonds, J. (2000) *The Mystery of Imperial Purple Dye*. Little Chalfont.
- Galliker, J. (2014) *Middle Byzantine Silk in Context: Integrating the Textual and Material Evidence*. PhD unpublished dissertation, University of Birmingham, Centre for Byzantine, Ottoman and Modern Greek Studies.
- Georgacas, D.J. (1959) Greek Terms for "Flax," "Linen," and Their Derivatives; And the Problem of Native Egyptian Phonological Influence on the Greek of Egypt. *Dumbarton Oaks Papers*, 13, 253-269.
- Gil, M. (2002) References to Silk in Geniza Documents of the Eleventh Century AD. *Journal of Near Eastern Studies*, 61: 1, 31-38.
- Gleba, M. (2008) Auratae Vestes: Gold Textiles in the Ancient Mediterranean. In C. Alfaro & L. Karali (eds.) *Purpurae Vestes, II Symposium Internacional sobre Textiles y Tintes del Mediterráneo en el mundo antiguo*. Valencia, 61-77.
- Goitein, S.D. (1967-1993) *A Mediterranean Society: The Jewish Communities of the Arab World as Portrayed in the Documents of the Cairo Geniza*. Berkeley, CA.
- Goitein, S.D. (1976) Two Arabic Textiles. *Journal of the Economic and Social History of the Orient* 19, May, 221-224.
- Guilland, R. (1949) Sur quelques termes du Livre des Cérémonies de Constantin VII Porphyrogénète. *Revue des études grecques*, 62, 328-350.
- Hadjinicolaou-Marava, A. (1950) *Recherches sur la vie des esclaves dans le monde byzantin*. Athens.
- Haldon, J. (2000) Theory and Practice in Tenth-Century Military Administration: Chapters II, 44 and 45 of the Book of Ceremonies. *Travaux et mémoires*, 13, 201-352.
- Hendy, M.F. (1985) *Studies in the Byzantine Monetary Economy c.300-1450*. Cambridge.
- Holo, J. (2009) *Byzantine Jewry in the Mediterranean Economy*. Cambridge.
- Jacoby, D. (1991-1992) Silk in Western Byzantium Before the Fourth Crusade. *Byzantinische Zeitschrift*, 84-85, 452-500.
- Jacoby, D. (2004) Silk Economics and Cross-Cultural Artistic Interaction: Byzantium, the Muslim World, and the Christian West. *Dumbarton Oaks Papers*, 58, 197-240.
- James, L. (1996) *Light and Colour in Byzantine Art*. Oxford.
- Keats-Rohan, K.S.B. (2003) *Progress Or Perversion? Current Issues in Prosopography: An Introduction* [Online]. Available: <http://users.ox.ac.uk/~prosop/progress-or-perversion.pdf> [Accessed: 9 Jun 2011].
- Keats-Rohan, K.S.B. (ed.) (2007) *Prosopography Approaches and Applications: A Handbook*. Oxford.
- Koukoules, P. (1948-1952) *Byzantinon bios kai politismos*. Athens.
- Lombard, M. (1978) *Les textiles dans le monde musulman du VIIe au XIIe siècle*. Paris.
- Lopez, R.S. (1945) Silk Industry in the Byzantine Empire. *Speculum*, 20: 1, 1-42.
- Maguire, H. (1989) Style and Ideology in Byzantine Imperial Art. *Gesta*, 28: 2, 217-231.
- Maguire, H. (1996) *The Icons of their Bodies: Saints and Their Images in Byzantium*. Princeton, NJ.
- Maguire, H. (1997) The Heavenly Court. In H. Maguire (ed.) *Byzantine Court Culture from 829 to 1204*. Washington, DC, 247-258.

- Mango, C. (1986) *The Art of the Byzantine Empire 312-1453: Sources and Documents*. Toronto.
- Michel, F. (1852) *Recherches sur le commerce, la fabrication et l'usage des étoffes de soie, d'or et d'argent, et autres tissus précieux en Occident, principalement en France, pendant le moyen âge*. Paris.
- Muthesius, A. (1995a) The Byzantine Silk Industry: Lopez and Beyond. In A. Muthesius (ed.) *Studies in Byzantine and Islamic Silk Weaving*. London, 255-314.
- Muthesius, A. (1995b) *Studies in Byzantine and Islamic Silk Weaving*. London.
- Muthesius, A. (1997) *Byzantine Silk Weaving AD 400 to AD 1200*. Vienna.
- Muthesius, A. (2002) Essential Processes, Looms, and Technical Aspects of the Production of Silk Textiles. In A.E. Laiou (ed.) *The Economic History of Byzantium*. Washington, DC, 147-168.
- Muthesius, A. (2004) *Studies in Silk in Byzantium*. London.
- Oikonomides, N. (1985) *A Collection of Dated Byzantine Lead Seals*. Washington, DC.
- Oikonomides, N. (1986) Silk Trade and Production in Byzantium from the Sixth to the Ninth Century: The Seals of Kommerkiarioi. *Dumbarton Oaks Papers*, 40, 33-53.
- Parani, M.G. (2003) *Reconstructing the Reality of Images: Byzantine Material Culture and Religious Iconography (11th-15th Centuries)*. Leiden.
- Piltz, E. (1997) Middle Byzantine Court Costume. In H. Maguire (ed.) *Byzantine Court Culture from 829 to 1204*. Washington, DC, 39-51.
- Rotman, Y. (2004) *Les esclaves et l'esclavage: de la Méditerranée antique à la Méditerranée médiévale: VIe-XIe siècles*. Paris.
- Schmitter, M.-T. (1937) Subsericae Vestes. *Revue Archéologique*, 6: 9, 201-225.
- Serjeant, R.B. (1972) *Islamic Textiles. Material for a History up to the Mongol Conquest*. Beirut.
- Short, H. & Bradley, J. (2005) Texts into Databases: The Evolving Field of New-Style Prosopography. *Literary and Linguistic Computing*, 20 (Suppl), 3-24.
- Simon, D. (1975) Die byzantinischen Seidenzünfte. *Byzantinische Zeitschrift*, 68: 1, 23-46.
- Starensier, A.L.B. (1982) *An Art Historical Study of the Byzantine Silk Industry*. PhD, unpublished dissertation, Columbia University.
- Starr, J. (1939) *The Jews in the Byzantine Empire, 641-1204*. Athens.
- Talbot, A.-M.M. (2001) Women. In A.-M.M. Talbot (ed.) *Women and Religious Life in Byzantium*. Aldershot, I, 117-143.
- Verhecken, A. (2007) Relation Between Age and Dyes of 1st Millennium AD Textiles in Egypt. In A. De Moor & C. Fluck (eds.) *Methods of Dating Ancient Textiles of the 1st Millennium AD from Egypt and Neighbouring Countries: Proceedings of the 4th Meeting of the Study Group 'Textiles from the Nile Valley'*. Antwerp, 206-213.
- Vial, G. (1961) Dossier de recensement: le Tissu aux Eléphants d'Aix-la-Chapelle. *CIETA Bulletin*, 14: July, 29-34.
- Weibel, A.C. (1935) Francisque-Michel's Contributions to the Terminology of Islamic Fabrics. *Ars Islamica*, 2: 2, 219-224.
- Wipszycka, E. (1965) *L'industrie textile dans l'Egypte romaine*. Warsaw.
- Woodfin, W.T. (2012) *The Embodied Icon: Liturgical Vestments and Sacramental Power in Byzantium*. Oxford.



## A Name of a Private Factory (or Workshop) on a Piece of Textile: the Case of the Document A.L.18 (Vienna)

Anne Regourd and Fiona J. L. Handley

### The collection

The Arabic Leinwand (A.L.) collection is held by the Department of Papyrus (Papyrussammlung) in the Austrian National Library of Vienna.<sup>1</sup> The collection was acquired in Egypt in the late 19th century by an antiquity trader in Cairo commissioned by Joseph von Karabacek, the famous papyrologist, and contains 68 items.<sup>2</sup> Almost all of these have an association with writing, hence the reason why they were collected for the Library, and only eight objects have no association at all. The language for the most part is Arabic with a few texts in Greek, or with Greek with Arabic.

The collection of pieces related to writing can be broadly divided into the following two categories:

#### 1. Writing on textiles

There are 38 examples of writing on textiles. These are items with epigraphy, with texts written by hand, stamped on, embroidered or woven into the textile. The texts themselves are non-literary and include legal deeds, accounts, letters,

talismans, and some may be purses used by merchants to carry money. Embroidered or woven examples, known as *ṭirāz*, are by far the least numerous, with only three examples in the collection.

#### 2. Writing on paper

There are 22 items that make use of reused paper documents. These are fragments of paper that are employed as structural inserts in clothing items including hats. They thus provide information on the work of tailors and hatters in the medieval period.

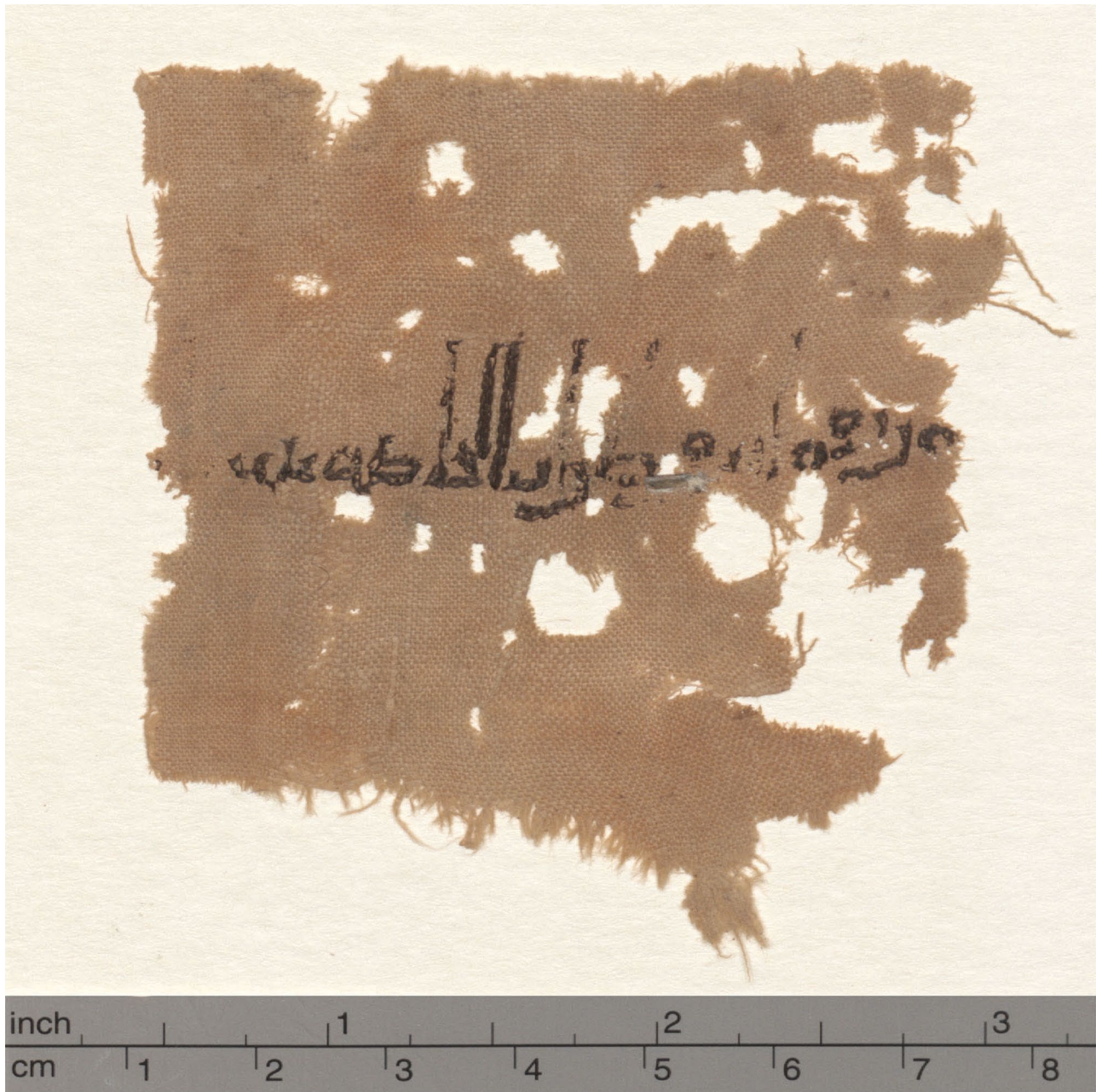
The papyrologist Adolph Grohmann attempted to organise the collection during the 1920s and 30s and undertook some cataloguing including translating some of the texts.<sup>3</sup> However, only a few of the items, mainly the talismans, were published separately via illustration or a summary of their text. So in other words, this collection is unique and largely understudied. The authors, along with a colleague, are currently completing a *catalogue raisonné* of this collection,<sup>4</sup> using a multidisciplinary approach to understand as much as possible about the provenance of the items,

1. Many thanks to the Austrian National Library of Vienna and to Prof. Bernhard Palme for allowing us to publish the data on this fragment and the images that they have copyright for.

2. One item of the 68 is accessible only through its picture.

3. CPR III, 59-60.

4. Regourd *et al.* forthcoming.



**Figure 1.** Fragment A.L. 18 *recto*

the date of their production, their use, disposal and entry into the collections. This article presents one example from this collection, A.L. 18, that challenges our understanding of the terminology around textiles identified as *ṭirāz*, in particularly their use as historical documents, and their status within the communities where they were made and used.

### **Fragment A.L. 18**

#### ***Description***

In the collection, there are only three textiles decorated with *ṭirāz*, and A.L.18 is one of them. It is a fragment 6.8 by 7.6 cm, with edges that were frayed

in antiquity, and which have possibly been trimmed in the recent past. The textile is in ‘s’-spun linen, in a tabby weave of medium quality of 30 threads per cm. The embroidery is in brown silk in rough stitches, many of which are unidentifiable, but include a majority of double rows of chain stitch. The remains of the tops of the uprights suggest that they may have been slightly ornamented. The embroidery has been heavily worn.

A.L.18’s text can be reconstructed through reference to the relevant formulas as follows:

... |امر بعمله فى طراز الخاصة بشـ|طا ...

Translation:

“... or]dered to be made in the private factory (*ṭirāz al-khāṣṣa*) at Shaṭā ...”

This replaces the previous readings made by Karabacek and Grohmann.<sup>5</sup> According to the text, A.L. 18 is an Egyptian textile from the city of Shaṭā, شطا, which is one of the production centers for *ṭirāz* in ‘Abbasid and Fatimid Egypt. The town is located in the Nile Delta close to Tinnīs and Damietta, both of which were famous places of *ṭirāz* production that slightly overshadowed Shaṭā.<sup>6</sup> The town was producing textiles in the 2nd/8th century, before that of the public factory at Miṣr.<sup>7</sup>

As the inscription suggests, the word *ṭirāz* refers both to the type of textile but also to the factory or workshop where those pieces were made, which were under the control of the caliphs and rulers.

Unfortunately, the part where the name of the caliph and the date usually appears is missing. Sometimes a missing date does not pose an obstacle to dating the *ṭirāz*, because if the name of an intendant or *amīr* (a member of the caliph’s family entrusted with the authority over the *ṭirāz*) appears, these can be cross referenced to other documents and the date worked out. However, with neither a date nor the name of an official, this piece cannot be dated from its inscription.

### *The textile industry at Shaṭā*

Shaṭā’s textile production was recorded by different Arab historians and geographers as early as al-Ya‘qūbī (d. 284/897<sup>8</sup>), *Kitāb asmā’ al-buldān*,<sup>9</sup> composed in 276/889, Ibn Ḥawqal (d. after 362/973), *Kitāb Ṣūrat al-ard*, and al-Muqaddasī (d. c., but after 400/1000), *Aḥsan al-taqāsīm fī ma‘rifat al-aqālīm*, a book mainly composed in 375/985.<sup>10</sup> They refer to the presence of Copts who may have been involved in the textile industry at Shaṭā. Various fine textiles are named after the town (“*al-bazz al-shaṭawī*”). Yāqūt (d. 626/1229), in his *Mu‘jam al-buldān*, is aware of “cloths from Shaṭā”, i.e., “*al-ṭiyāb al-shaṭawīyya*”, then gives more details through al-Ḥasan b. Muḥammad al-Muhallabī (d. 380/990),<sup>11</sup> who said that Shaṭā and Damietta were famous for their production of very fine and delicate textiles, the price of some of them being 1000 dirhams, although no gold was used in their fabric.<sup>12</sup>

5. Karabacek 1909, 38; CPR III, 60 and n. 3, where Grohmann gives a short description of the object, which mainly relates it to his typology (“stammt nach der mit schwarzer Seide eingestickten Inschrift”, i.e., belongs to the inscriptions embroidered with silk), followed by his reading of the text of the *ṭirāz*, giving the provenance of the fabric erroneously as “Banšā” (Banshā). In his footnote 3 he refers to Karabacek’s reading and revises it, suggesting “*bi-‘amalih*” as the right reading rather than “*bi-‘amal*”, which is Karabacek’s reading, but leaves the provenance of the fabric as “Banšā”. On the original envelope in which the textile was stored is a note written by Karabacek with his reading of the text.

6. See for instance, Ibn Ḥawqal 1938-39, 152 [20]; Maqrīzī 1422/2002, vol. 1, 476-493, the long entry on Tinnīs.

7. Kuhnel & Bellinger 1952, 84.

8. The first date is given in the Hegira calendar and the second is in AD, here and elsewhere.

9. Aḥmad al-Ya‘qūbī, cf. Kaḥḥāla c. 1376/1957, vol. 1, 161, and the bibliography. Al-Ya‘qūbī 1892, 338; translation into French, Wiet 1937, 195.

10. Al-Muqaddasī 1906, 202; partially translated into French by Miquel 1972, 122.

11. Author of *K. al-masalik wa-al-mamalik*, cf. Kaḥḥāla c. 1376/1957, vol. 3, 313; Ḥājjī Khalīfa c. 1360/1941, vol. 2, 1665.

12. Yāqūt (d. 626/1229) 1410/1990, entry 7110, vol. 3, 388. See also Wüstenfeld 1867, vol. III.1, 288. All these authors, out of al-Fākihī (see below) and al-Muhallabī, are quoted, although sometime only partially by Ramzī 1375/1955, vol. 1/2, 243. Ibn Ḥawqal 1938-39, 152-153 [20], said that the price of *al-ṣaṭawī* was even more during his time, from 20,000 to 30,000 dinars, but the passage is a little confusing.

Al-Maqrīzī, the famous Egyptian historian, who died in 845/1442, refers to the city twice: first he mentions as his predecessors did, a type of cloth (*ṭiyāb*) which is named after the city, *al-ṭiyāb al-shaṭawiyya*. While he is a little late in date for our item, he also quotes al-Fākihī (d. 272/885),<sup>13</sup> who saw a *kiswa* from Shaṭā bearing the name of Hārūn al-Rashīd, the famous ‘Abbasid caliph, whose reign started in 170/786, as well as the name of al-Faḍl b. al-Rabī‘, who took over the government under Hārūn al-Rashīd in 187/803, and moreover the date of 191H, *i.e.*, 806-807 AD, the very beginning of the reign of the Caliph Hārūn. The complete text of the *kiswa* is given by al-Fākihī according to Maqrīzī,<sup>14</sup> and this piece of cloth is described by al-Fākihī as a piece of “*qabāṭī Miṣr*”.

So literary sources state that the city of Shaṭā was a place for textile production including some very high quality textiles from at least the end of the 2nd/8th through to the 4th/10th centuries.

### *The private factory*

According to its inscription, the factory where A.L. 18 was made was *al-khāṣṣa* or private. In Cairo under the ‘Abbasids there was a distinction made between the public *ṭirāz* workshops (*‘amma*) and the private *ṭirāz* workshops (*khāṣṣa*) whose production was reserved for the caliph.<sup>15</sup> By the time of the Fatimid caliphs, the sale of *ṭirāz* textiles to the public from the *‘amma* was a significant source of revenue with the largest *ṭirāz* factories providing an income of more than 200,000 dinars each day<sup>16</sup> and this presumably increased in the later Fatimid period given the dramatic rise in *ṭirāz* production at court and the penchant of the middle

and upper classes for imitation.<sup>17</sup>

There is some information known about the factory system at Shaṭā. In 937 AD, under the Caliph Abū al-‘Abbās Muḥammad al-Rāḍī bi-llāh, the intendant at Shaṭā was Jābir, following on from one called Shāfī.<sup>18</sup> Later pieces include those produced under the Caliph al-Muṭī‘ (334-363/946-974) that mention an intendant called Fā’iz, as well various pieces that mention the public and private *ṭirāz* factories at Shaṭā which were under the direction of Fā’iz. He was evidently the chief intendant of all the Caliph’s factories in Shaṭā,<sup>19</sup> and his office spanned the end of the ‘Abbasid period and the new era of the Fatimids, which started in 341/952 with the Caliphate of al-Mu‘izz (from 341/952 to 365/975). An inscription on a textile in the Benaki Museum dated 387/997-998 AD, which states that it comes from the public factory at Shaṭā, confirms that the city hosted a public factory in the 4th/10th century.<sup>20</sup>

The other well-known places of production in the Nile Delta also had both public and private factories. According to Grohmann, production in both the private and public factories was very well regulated, with those of the private factories particularly bound to ritual as their textiles were reserved for royal use:

“At the head of the administration of these state factories there was always an official of high rank from the judicial or military service... When he arrived with the fabrics intended for the royal use (...) he was received with the highest honours (...) when the bales of the precious fabrics were brought in, the superintendent of the *ṭirāz* presented himself to the caliph, showed

13. Muḥammad al-Fākihī, cf. *El*, II, 49; *GAL*, G1, p.137; Kaḥḥāla c. 1376/1957, vol. 9, 40-41.

14. Maqrīzī 1422/2002, vol. 1, 611-612; this text does not appear in the book *Tārīkh al-Fākihī, Akhbār Makka*, see the note of the ed., it seems only conserved in Maqrīzī’s; Quatremère, *Mémoires géographiques et historiques sur l’Égypte et sur quelques contrées voisines*, I, Paris, 1811, 339; text reproduced in *RCEA*, I, no. 80.

15. Grohmann 1913-1936, 793.

16. Grohmann 1913-1936, 790.

17. Stillman & Sanders 2000, 537.

18. Kuhnel & Bellinger 1952, 40. no. 73.214, pl. XVIII, dated 325/936-937, *RCEA*, IV, no. 1271.

19. Kuhnel & Bellinger 1952, 48, no. 73.638, pls. XXI and XLI, dated 338/949-950; *RCEA*, IV, no. 1442. Berlin-Museum für Islamische Kunst, no. I.5569, dated 357/967-968; *RCEA*, V, no. 1644; and text by Pevzner 1960, 39 (quoted after Kalus). Private collection, *RCEA*, V, no. 1648, dated 357/967-968.

20. Athens, Benaki Museum, no. A. 173; Combe 1940, 264, no. 7, pl. I; *RCEA*, VI, no. 2056.

him all that he had brought with him, and called his attention to each piece".<sup>21</sup>

Another item within the Arabic Leinwand collection (A.L. 1) is a fine piece of linen bearing a stamped inscription in red color, the text of which refers, according to Grohmann, to the Caliph al-Mu'izz. The stamp demonstrates one of the mechanisms for controlling the quality of the bolts of cloths produced in royal factories, in this case probably for the purpose of taxes.<sup>22</sup>

In contrast to the state-controlled factories, domestic production of cloth continued but in very different circumstances. Grohmann suggests that in the Delta there was "an industry conducted in private houses, probably alongside of the state factories. The lot of the workmen—women span and men wove and the work rooms were rented by them—was wretched; the half dirhem, which was the daily wage, was not sufficient for the minimum necessities of life".<sup>23</sup>

In terms of helping date the textile, the mention of the term *al-khāṣṣa* can help slightly because by stating that it was private it, by default, suggests that there was also a public factory, thus dating the piece to probably at least the mid-4th/10th century, as early references to factories were simply described as factories, and these were presumably private.<sup>24</sup>

### *Dating from comparable textiles*

Grohmann's notes on the textile, which were recorded on the envelope where it was originally stored, refer to several comparator textiles.<sup>25</sup> Out of these, only

two are traceable, and only one relevant, a textile published in the *Journal of the Royal Asiatic Society* in 1906 which is an embroidery on linen in red thread. The embroidery is now in the V&A collections and is in a stem or running stitch. It is dated to 895 AD with a provenance of the cemetery at Akhmīm in the Sohag Governorate (Egypt).<sup>26</sup> The simplicity of the calligraphy was what probably made Karabacek consider this a comparator, however now that the provenance of the textile has been identified more relevant comparators from Shaṭā can be looked at.

Shaṭā was well known as a textile centre from the end of the 2nd/beginning of the 9th century, and produced fine pieces such as the veil for the Kaaba (191H). As stated above, the complete text is given by al-Fākihī according to Maqrīzī,<sup>27</sup> and this piece of cloth is described by al-Fākihī as a piece of "*qabāṭī Miṣr*", *i.e.*, tapestry from Miṣr according to the Editor of the text, Ayman Fu'ad Sayyid.<sup>28</sup>

Other tapestry examples from Shaṭā include pieces in the Royal Ontario Museum such as a linen with blue silk weft tapestry dated to 949 AD, blue and yellow silk weft tapestry dated to 937 AD, and a further example attributed to Shaṭā dating to 944-945 AD.<sup>29</sup> Other examples include a piece with small red lettering on a yellow band, dated 370/980-981,<sup>30</sup> and another in red silk tapestry dated to 350/962.<sup>31</sup>

There seem to be very few surviving examples of embroidered *ṭirāz* from Shaṭā, although there is one example in dark brown silk in a variety of stitches, made under al-Mu'tamid, dated 276/889-890, which is in the Kelsey Museum of Archaeology

21. Grohmann 1913-1936, 790.

22. CPR III, 59, and Fig. 2.

23. Grohmann 1913-1936, 789.

24. Kuhnel & Bellinger 1952, 121, 124.

25. There were four references cited by Grohmann in CPR III: Staatlichen Museen in Berlin, Papyrussammlung, "ein Linnenstück mit einem mit blauer Seide eingestickten Tirāz (P. Berol. 7616)" (which were not traceable); South Kensington Museum, Guest 1906, with 4 pl.; linen, 2-6, 8, 11-14, silk and linen, 10, 15, 16, silk 1, 7, 9 (which has been traced); Sewell 1907, 163 (traced but is not relevant); and Fraehn 1822, MASP 8, 572-574 (which was not traceable).

26. Guest 1906, No 2; Victoria & Albert Museum 2014, Textile Fragment 257-1889.

27. See our footnote 12, and the note of the ed. Ayman Fu'ad Sayyid, 611.

28. Maqrīzī 1422/2002, vol. 1, 489, note 5, where A.F. Sayyid retraces "*al-qabāṭī*" as a *nisba* of "Aqbāṭ Miṣr", the Copts of Egypt, and says that it means tapestry on the basis of one of his previous publications.

29. Kuhnel & Bellinger 1952, 73.638, 47; 73.214; 73.651, 47.

30. *RCEA* V, 1889.

31. Boston-Museum of Fine Arts, no. 34.118, cf. Britton 1938, 48, fig. 28.



**Figure 2.** Detail of front of A.L. 18 showing double row of chain stitch

at Ann Arbor.<sup>32</sup> Embroidered examples from nearby Tinnīs are far more numerous, with examples from the Royal Ontario Museum dated to 911-912 AD,<sup>33</sup> the Ashmolean Museum, Oxford, dated to 901 AD (1988.47)<sup>34</sup> and Cleveland Museum of Art dated to 889-890 AD.<sup>35</sup>

There are temporal changes in the techniques used to create *ṭirāz* within the factory system. Generally, the factory production of *ṭirāz* in the Delta area of Egypt began in the 2nd/8th century by emulating embroidered *ṭirāz* imported from areas of the Middle East such as Iran. The Egyptian factories used a different suite of embroidery stitches on a linen rather than cotton ground, then shifted in the later 4th/10th century to producing similar designs in tapestry, a technique which had a longer and more embedded tradition in Egypt.

Stylistically, all the cited examples both in embroidery and tapestry bear a resemblance to A.L. 18, with unadorned long lettering with little embellishment apart from the slight capping of the uprights reminiscent of Tinnīs tapestry and embroidery. However there is one factor that complicates this scenario, and indeed brings the whole issue of the provenance of the textile based on its inscription into doubt. From a technical perspective, all of the above examples are very high quality and fit clearly into technical categories associated with production in the Delta in the early to late 3rd/9th century. In the



**Figure 3.** Reverse of A.L. 18 showing the slanted stitch which is the reverse of chain stitch

case of embroideries, this means that the majority of their stitches are running or couched stitches. In contrast, the decipherable stitches of A.L. 18, which is the majority of them, are executed in chain stitch. Chain stitch was used in Iran, and typified *ṭirāz* from those factories, and although the stitch was occasionally used by Egyptian embroiderers, for example in turning the corners of letters,<sup>36</sup> examples where it was the sole stitch used in a *ṭirāz* piece have been identified as the hand of Iranians working in Egyptian factories (*e.g.*, Tinnīs).<sup>37</sup> However, the examples identified by Kuhnel are the work of a professional, while it is less likely that A.L. 18 is. Its poor quality is exacerbated by having quite a loose chain, with, in some areas such as the uprights on the letters, two rows running parallel to each other (see figure 2). While the chain stitch is hard to decipher on the front side of the cloth, the typical reverse of chain stitch of a line of slightly slanting stitches, can be seen on the back of the textile, the two parallel rows representing the two rows of chain stitch on the uprights (figure 3). It is immediately obvious that the embroiderer struggled to control the stitch

32. Day 1937, no.2, 423 and fig. 2. See Kuhnel & Bellinger 1952, 40.

33. Kuhnel & Bellinger 1952, 978.76.18.

34. Ellis 2001, 1.

35. Cleveland Museum of Art 1932.17.

36. Kuhnel & Bellinger 1952, 103.

size, and that there was little planning of the placing of the letters or how the stitch work would run between them. For example, on the front side, the ‘tails’ of the letters are worked as a curve on the left hand side, but on the right, they are ‘counted’, that is following the warp and weft, giving a block effect to the letter shape. It would seem that the needlework was certainly not that of a professional embroiderer in chain stitch, nor indeed even a competent one.

### Discussion

During the late 2nd/8th, 3rd/9th and 4th/10th centuries Shaṭā produced a variety of textiles from state-controlled factories, initially private ones, later both private and public, which at times were under the control of just one intendant. While there are few examples of surviving embroidery this must have made up a substantial part of the early production. The surviving examples of linen with silk tapestry dating from towards the end of the 4th/10th century form a distinct assemblage of textiles, in line with other production from neighbouring towns. As is the case when comparisons with documentary sources are possible, the texts recount a much wider variety of types of textiles produced at Shaṭā than have actually survived, including some very high status fabrics.

Where does A.L. 18 fit into this picture? With the possibility of this being done by an Iranian embroiderer working in Shaṭā being ruled out, the question is raised of why a private *ṭirāz* factory in Shaṭā was producing such poor quality embroidery that emulated Iranian embroidery techniques. If, as Grohmann suggests, the produce of the private factories was individually presented to royals, then A.L. 18 seems unlikely to be this caliber of textile. It may have perhaps been reserved for the humbler members of the royal entourage, or given away as a low quality gift. However its combination of strange technique and poor execution surely suggests that this was not the product of any state workshop, or if it was, it was perhaps some kind

of trial, that somehow ended up leaving the factory, although the wear on it suggests that it was used extensively before being disposed of.

Could this be that this was not a private factory production at all, but *ṭirāz* created outside the state system attempting to pass off both an inscription and technique? It could be a copy of an ‘authentic’ *ṭirāz* textile, which mixes an Egyptian inscription with an Iranian embroidery technique. This would certainly fit with this period’s ‘penchant for imitation’ whereby there was a strong trade in reproductions and poorer quality imitations,<sup>38</sup> and where domestic embroiderers replicated in stitches tapestry work that had been produced on a loom.<sup>39</sup> So could this then be an embroidery that was not produced in the *khāṣṣa* factory, but ‘claims’ to be? Why though would the embroiderer choose a technique that they were evidently incompetent in—this surely would have revealed it as a fake to anyone who knew the production from the private factories of Shaṭā? Perhaps it was created in one of the workshops which Grohmann described as “wretched”,<sup>40</sup> that were outside the state system, and thus beyond its quality controls. These must have sold on to a ‘black’ market where imitations, such as the tapestry example in the Musée des Tissus de Lyon,<sup>41</sup> were the norm.

If there were any questions asked about provenance of the *ṭirāz* the evidence could easily be cut off and discarded—and indeed this would be the fragment that would contain that evidence that it was a fake. A further point which is worth bearing in mind is that A.L. 18, in line with the other textiles in the collection including the other two *ṭirāz* pieces (A.L. 11 and 48), did not come from a burial site, but from a rubbish dump. It was not therefore carefully disposed of as most surviving *ṭirāz* pieces in other collections were, but it really was worn out and thrown away. Even as a poor quality imitation of an example of *ṭirāz* that was either very rare or never actually existed, it still had enough value that it was used until it was worn into a rag.

37. Kuhnel & Bellinger 1952, 26, 107.

38. Stillman & Sanders 2000, 537.

39. Fluck & Helmecke 2014, 255.

40. Grohmann 1913-1936, 789.

41. Day 2010, 42.

## Conclusions

The analysis of this piece of textile has highlighted how complicated deciphering textile terminologies can be. Many *tirāz* textiles contain the written information that identifies them as a type of object and gives them a historic and production context. As a textile category they helpfully reveal what they are, even when fragmentary. This does mean that each piece's historical value has tended to be based on the information in its written text, therefore textiles that cannot be dated or are uninscribed have been neglected.<sup>42</sup> However, this example has raised some interesting, albeit unanswerable, questions—what does it mean if the information on *tirāz* is not true? Suddenly, new ideas about the people producing the item and the life history of the object are opened up to scrutiny, questions that would probably never been raised if there was a consistency between decorative technique, quality and inscription. Instead, the analysis throws up more questions than answers, but these questions are ones that lead to a deeper consideration of how *tirāz* textiles were made and used, and to our understanding of the term *tirāz*.

## Abbreviations

- CPR III = Grohmann, A. (1924) *Allgemeine Einführung in die arabischen Papyri*. Vol. 1, part 1: *Einführung*. Corpus Papyrorum Raineri III. Vienna.
- EP*<sup>1</sup> and *EP*<sup>2</sup> = *Encyclopaedia of Islam* (1st and 2nd edition).
- GAL* = Brockelmann C. (1937-1949) *Geschichte der arabischen Litteratur*, 4 vols. Leiden.
- MASP* = Mémoires de l'Académie impériale des sciences de Saint-Pétersbourg.
- RCEA* = *Répertoire chronologique d'épigraphie arabe*. Cairo 1931-.

## Bibliography

- Britton, N. P. (1938) *Some Early Islamic Textiles in the Boston Museum of Art*, Boston. Boston.
- Cleveland Museum of Art (nd) Fragment of a Tiraz, 889-890 1932.17. *Online Catalogue*. <http://www.clevelandart.org/art/collection/search> (Accessed 10 December 2014).
- Combe, E. (1940) Tissus fāṭimides du Musée Benaki, in *Mélanges Maspero*, III. *Orient islamique*. Mémoires publiés par les membres de l'Institut Français d'Archéologie Orientale du Caire LXVIII. Cairo, 259-272.
- Day, F. E. (1937) Dated Ṭirāz in the Collection of the University of Michigan, *Ars Islamica* IV, 420-447.
- Day, S. (2010) Fragment de *tirāz* à l'épigraphie coufique. In M.-A. Privat-Savigny (ed.), *Guide des collections: Musée des tissus de Lyon*, Chap. II, « L'Orient », 42. Lyon.
- Ellis, M. (2001) *Embroideries and Samplers from Ancient Egypt*. Oxford.
- Fluck, C. & Helmecke, G. (2014) Egypt's Post-Pharonic Textiles. In G. Gabra (ed.), *Coptic Civilization: Two thousand years of Christianity in Egypt*, 237-260. Cairo.
- Frähn, C. M. (1822) *Inscriptiones cuficae acu pictae lineolo inserto*. MASP 8. St-Petersburg.
- Grohmann, A. (1913-1936) *Ṭirāz*. In *EP*<sup>1</sup>, vol. IV, 785-793.
- Guest, A. R. (1906) Notice of some Arabic Inscriptions on Textiles at the South Kensington Museum, *Journal of the Royal Asiatic Society* 38/2, 387-399.
- Hājī Khalīfa (c. 1360/1941) *Kashf al-ẓunūn 'an asāmī al-kutub wa-al-funūn*. 2 vols. Beirut.
- Ibn Ḥawqal (d. after 362/973) (1938-39) *Kitāb Ṣūrat al-ard. Opus geographicum ... Liber imaginis terrae*. Ed. J. H. Kramers, Leiden.
- Kaḥḥāla, 'U. R. (c. 1376/1957) *Mu'jam al-mu'allifin: Tarājim muṣannifī al-kutub al-'arabiyya*. 15 vols. Beirut.
- Karabacek, J. von (1909) *Zur orientalischen Altertumskunde*. II. *Die arabischen Papyrusprotokolle*. Vienna.
- Kühnel, E. (1933) Zur Tirāz-Epigraphik der Abbasiden und Fatimiden. In von Oppenheim, M. (ed.) *Aus fünf Jahrtausenden morgenländischer Kultur: Festschrift Max Freiherrn von Oppenheim zum 70. Geburtstag gewidmet von Freunden und Mitarbeitern*. Berlin, 59-65.

42. Stillman & Sanders 2000, 534.



- Kühnel, E. & Bellinger, L. (1952) *Catalogue of Dated Tiraz Fabrics: Umayyad, Abbasid, Fatimid*. Washington.
- Maqrīzī (d. 845/1442) (1422/2002), *Al-mawā'iz wa-al-i'tibār fī dīkr al-ḥiṭāt wa-al-aṭār*, ed. A.F. Sayyid, vol. I. London.
- Miquel, A. (1972) L'Égypte vue par un géographe arabe du X<sup>e</sup> s, *Annales islamologiques* XI, 109-139.
- Muqaddasī (d. c., but after 400/1000) (1906) *Aḥsan al-taqāsīm fī ma'rifat al-aqālīm*, ed. M. J. de Goeje, *Al-Muqaddasi, Descriptio Imperii Moslemici*. Leiden, Brill.
- Pevzner, S. B. (1960) Fatimidskij tirāz iz sobranija Gosudarstvjenного Ermitazha, *Epigrafika Vostoka* XIII, 35-40.
- Quatremère, J. (1811) *Mémoires géographiques et historiques sur l'Égypte et sur quelques contrées voisines*. Vol. I. Paris.
- Ramzī, M. (1375/1955) *Al-qāmūs al-jughrāfī bi-al-bilād al-miṣriyya. Min ahd qudamā' al-miṣriyyīn ilā sanat 1945*. Vol. 1/2. Cairo.
- Regourd, A., Handley, F.J.L. & Reinfandt, L. (Forthcoming) *Catalogue raisonné of the Arabisch Leinwand collection. Papyrussammlung, Austrian National Library*. Vienna.
- Sewell, R. (1907) Arabic Inscriptions on Textiles. *Journal of the Royal Asiatic Society of Great Britain and Ireland (New Series)*. Volume 39, 163-164.
- Soudan, F. & Kalus, L. (ongoing database) *Thésaurus d'épigraphie arabe*, Geneva, Foundation Max van Berchem, <http://www.epigraphie-islamique.org/epi/search.php> (Accessed in January 2015).
- Stillman, Y. & Sanders, P. (2000) *Ṭirāz*. In *EP*, vol. 10, 534-538.
- Victoria & Albert Museum 2014 Textile Fragment 257-1889 *Search the Collections* <http://collections.vam.ac.uk/item/O77072/textile-fragment/> (Accessed 10 December 2014).
- Wiet, G. (1937) *Ya'kūbī. Les Pays*. Cairo. (French transl.)
- Wüstenfeld, F. (ed.) (1867) *Jacut's geographisches Wörterbuch aus den Handschriften zu Berlin, St. Petersburg und Paris*. vol. III.1. Leipzig.
- Al-Ya'qūbī (d. 284/897) (1892) *K. al-Buldān*, ed. de Goeje. Leiden.
- Yāqūt (d. 626/1229) (1410/1990) *Mu'jam al-buldān*, ed. Farīd 'Abd al-'Azīz al-Jundī. Beirut.

## Zur Bekleidung der Krieger im Avesta: Rüstung und magischer Schmuck

Götz König

Während die in Altavestisch komponierten Lieder des Avesta (die *Gāθās* und das *Yasna Haptanhāiti*) einen rituellen Dichtungsstil pflegen, der sich in eigentümlicher Weise gegen die Dinge der Welt weitgehend verschließt, d.h. Wörter, die auf Materiales – auf in Raum und Zeit Identifizierbares – vermeidet, stellen die in Jungavestisch abgefaßten metrischen wie prosaischen Texte des Avesta eine weitaus ergiebigere Quelle zur Rekonstruktion der materiellen avestischen Kultur dar. Richten dabei diejenigen Texte, welche die tägliche bzw. zu bestimmten Anlässen zu feiernde, um die altavestischen Texte herum komponierte Priesterzeremonie bilden (*Yasna* bzw. *Yasna* mit *Vīsparad*), ihre Aufmerksamkeit auf das Ritual und dessen Gegenstände, so dringt mit den interkalierbaren Sammlungen (*naska*) der Hymnen (*Yašts*; einst im *\*naska- baganqm* zusammengestellt<sup>1</sup>) und dem sich weitgehend auf Rechtsgegenstände beziehenden *Vīdēvdād* ‚Welt‘ in die Ritualsphäre ein, die selbst wiederum in ihrer gegenständlichen Konkretion von dem priesterlichen Unterweisungstext *Nērangestān* beschrieben wird.

Ob die in den drei genannten jav. Texten *Yašt* (Yt), *Vīdēvdād* (V) und *Nērangestān* (N) reflektierte

materiale Kultur dabei einem einheitlichen zeitlichen, räumlichen und sozialen Horizont angehört, ist keineswegs sicher (s.u.). Während *Vīdēvdād* und *Nērangestān* weitgehend die Lebenswelt der Priester bzw. Gläubigen zum Zeitpunkt ihrer Textkomposition beschreiben, beziehen sich die (teilweise ‚archaisch‘ anmutenden) *Yašts* auf eine eher aristokratische Sphäre, die sich immer wieder in eine heroisch-mythische Vorwelt ausdehnt.

In Hinsicht auf Terminologien für Gegenstände der Bekleidung sind es vor allem zwei jungavestische Textpartien, die sich diesen konzentriert widmen. Die Kapitel 67-69 und 73-78 des *Nērangestāns* beschreiben diverse Kleidungsstücke (meist textilen Charakters) der *Mazdāverehrer* (insbesondere auch deren heiligen Gürtel). Die Listen in V 14.7-10 stellen die für die drei Gesellschaftsklassen Priester, Krieger und Bauern spezifischen *zaiia* ‚Instrumente‘ zusammen, welche im Falle von Priestern (*aθauruuan*) und Kriegern (*raθaēštar*) auch Kleidung einschließen. So nennt V 14.8 das bis in die Moderne für den zoroastri-schen Priester typische ‚Vor-Tuch‘ (*paiti.dāna*) (s. Anhang). V 14.9 listet für den Krieger sechs Angriffswaffen und sechs Kleidungsstücke = Rüstungsgegenstände,<sup>2</sup> zeigt also ein Gleichgewicht der offensiven

1. Kreyenbroek 2004; Kreyenbroek 2008; Cantera 2010; König 2012.

2. Zu avestischen Waffentermini s. Malandra 1973.

V 14.9	Pahlavi Übersetzung	Verwandtes	Bedeutung
<i>zrādō.</i>	<i>zreh</i>	arm. LW <i>zrahk</i> [Hübschmann Nr. 238]; mp. <i>zreh</i> „Bewaffnung“; np. <i>zereh</i> „Cuirass; Kettenhemd“	Cuirass (frz. <i>cuirasse</i> „armour [leather]“)
<i>kūiris.</i>	<i>grīwbān [ān ī az tarag abāz ō zreh bast ēstēd]<sup>4</sup></i> „Halsschutz [was vom Helm aus an das Cuirass gebunden wird]“ <sup>5</sup>	Vgl. Bergname <i>kaoirisas(ca)</i> Yt 19.6 (IE * <i>kur-/gur-</i> „Hals“)	Halsschutz <sup>6</sup>
<i>paiti.dānō.</i>	<i>padān [ān ī azēr ī zreh dārēnd]</i> „Mundvorsatz [was man unter dem Cuirass trägt]“	Vgl. ai. <i>prati-dhāna-</i> „Anziehen“	Mundvorsatz(-Tuch?)
<i>sārauuārō.</i>	<i>sārwār [tarag]</i> „ <i>sārwār</i> [Helm <sup>7</sup> ]“	arm. LW <i>salavart</i> [Hübschmann Nr. 566]; syr. <i>sanvartā</i> „Helm“; vgl. av. <i>hqm-varaiti-</i> „Wehrhaftigkeit“ etc.	Helm; Hut (?)
<i>kamara.</i>	<i>kamar</i>	np. <i>kamar</i>	Gürtel <sup>8</sup>
<i>rānapō.</i>	<i>rānbān [xsparzag (Mss. šplc’)]</i>	Zu <i>sparzag</i> vgl. mmp./parth. ‘spr; np. <i>separ</i> „Schild“	Beinschutz

und defensiven *zaiia*. In historischer Hinsicht wird darum der Vergleich mit den Ausrüstungsverhältnissen, wie sie sich in den *Yašts*, insbesondere in Yt 14, finden, aufschlußreich sein, da diese Ausrüstungsgegenstände in Yt 14 in bezug auf den Schutz des Körpers markant von V 14.9 abweichen.

### Vīdēvdād 14.9

Die sechs Bekleidungsgegenstände, die V 14.9 als die für den Krieger typischen listet, beschreiben eine Einkleidung des gesamten Körpers, also eine vollständige Rüstung. Die Übersetzungen einiger Gegenstände ins Pahlavi, ebenso Wortparallelen im armenischen

Lehnwortschatz oder im Neupersischen scheinen auf einen metallenen Charakter der Rüstung hinzuweisen, wie er spätestens seit sasanidischer Zeit durch Relieffabbildungen oder Graffiti bezeugt wird und typisch für den *aswār* (np. *sowār*) (< ap. *asabāra*<sup>3</sup>), den iranischen Ritter, ist.

Die für die im avestischen Text gelisteten Rüstungsteile verwendeten Materialien sind unbekannt. Die (defensiven) Rüstungsgegenstände des Gottes Vaiiu, die Yt 15.57 als „goldene“ (*zaraniia*<sup>9</sup>) beschreibt, entsprechen in ihren Bezeichnungen (°*xaoda-* „Hut; Helm“; <sup>9</sup>°*minu-* „Halsgeschmeide“; <sup>10</sup>°*vastra-* „Kleid“; °*aoθra-* „Schuh“; <sup>11</sup>°*aiβiūānhana-* „Gürtel“) nicht den in V 14.9 genannten. Jedoch

3. Die Bildung ist im Avestischen nicht bezeugt. In N 19.6 findet sich ein *barō.aspa-* „ein Pferd reitend“ (im Gegensatz zu *vazō.raθa-* „einen Wagen fahrend“). Zum Zusammenhang von Pferd und Mann s.a. das Kompositum Yt 10.101 *aspa.vīra.gan-* „Pferd und Mann schlagend“.

4. Das bei der *Nōzūt*-Zeremonie angelegte Hemd wird *kīse-ye kerfe* und *gerebān* genannt, letzteres ist vermutlich eine volksetymologische Umbildung von *grīwbān* (Junker 1959, 28).

5. Zu Helm und Halsschutz aus safawidischer Zeit s. Rehatsek 1882.

6. Zu *kuris-* „Helm“ s. Bailey 1954, 7-8. Zum Wort siehe auch Duchesne-Guillemin 1937-1939, 861.

7. Np. *targ* „Helm“ (s. ŠN).

8. Der Gürtel (*kamar*) zählt im 3. Jh. zu Würdezeichen des zum „Ohrmazd Mowbed“ erhöhten Ehrbed Kirdīr, s. KSM 5 (KKZ 4, KNRm 9-10) „Und der König der Könige Ohrmazd verlieh mir Hut und Gürtel“ (*u-m Ohrmazd šāhān šāh kulāf ud kamar dahēd*).

9. Yt 9.30 *uruui.xaoda-* „spitzhelmig“ (zu *uruui-* „spitz“ s. EWA II, 456); der Helm gehört dem (700 Kamele besitzenden) *Ašta.auruuant. Vīspa.θauruuō.ašti.* (Yt 9.30, 17.50), einem Feind des Vīštāspa. Ihm eignet auch ein spitzes Schild/Brustwehr (*uruui.vərəθra-*).

10. Auch von Frauen getragen, s. Yt 5.127, 17.10.

11. Vgl. Yt 5.64, 78; V 6.27 (PÜ *mōg* „Schuh“); *x’ā.aoθra-* (PÜ *xwēš mōg*) V 13.39, PV 5.46.

zeigt weitere Analyse, daß sich aus einer Kleidungsbezeichnung i.d.R. nicht auf das für die Kleidung verwendete Material schließen läßt. So tragen, wie das Bildnis des Skunxa in Bisotun zeigt, die „spitzmützig“ (*tigra-xauda-*) Saken *xaudas* aus Stoff/Filz; hingegen beschreibt Yt 13.45 die *xaoḍas* der Frauuašis (wie deren gesamte Rüstung) als „eiserne“ (Yt 13.45 *aiiō.xaoḍā. aiiō.zaiiā. aiiō.vərəθrā.* „eiserne Hüte, eiserne ‚Instrumente‘ [= Angriffswaffen<sup>12</sup>], eiserne Schilder/Brustwehren“), vgl. np. *xūd* „Helm“, jedoch pašto *xol* „Helm; Hut“, oss. *xūd/xodæ* „(Pelz-) Mütze“ (EWA III, 148; sem. LW ḥwd’ „Tiara, Diadem“). Ähnliches gilt im Falle der Gürtelschnüre.<sup>13</sup> Der historisch nächste Vergleichspunkt der Kriegerbekleidung, die V 14.9 aufführt, dürften Relief- und Siegeldarstellungen des achämenidischen Irans bzw. Beschreibungen der mit dem achämenidischen Iran vertrauten griechischen Historiker sein. Ein solcher Vergleich kann hier freilich nicht geleistet und nur darauf hingewiesen werden, daß die griechische historische Literatur diesbezüglich sehr wertvolle Nachrichten enthält (s. z.B. Her. 7.84.1 über einen aus Bronze oder Silber gehämmerten Kopfschutz der berittenen Perser [πλήν ἐπὶ τῆσι κεφαλῆσι εἶχον ἔνιοι αὐτῶν καὶ χάλκεα καὶ σιδήρεα ἐξεληλαμένα ποιήματα]<sup>14</sup>).

#### Yašt 14

Innerhalb des Jungavesta begegnen in der Textgruppe der *Yašts* in Yt 14 Beschreibungen von Schutzmaßnahmen des Körpers, die wenig zu denjenigen zu passen scheinen, die das *Vīdēvdād* nennt. Die in Yt 14 beschriebenen Schutzmaßnahmen sind durchwegs magischer Natur.

Yt 14 ist dem Gott *Vərəθraγna* gewidmet. Sein Hymnus ist der 14. von 21 (22) Hymnen des

autoritativen Ms. F1 (Indien 1591) und bildete einst die Nr. 11 des sasanidischen *Nask Bayān*, eine der 21 Abteilungen der in der Sasanidenepoche unternommenen Kanonisierungen des Avesta. Der Ursprung des *Vərəθraγna* ist vieldiskutiert.<sup>15</sup> Sein Name bedeutet „Schläger des Widerstands / der Widerstandskraft (*vərəθra*)“, was auf einen Zusammenhang mit den als *vṛtra-hán-* „die *Vṛtra*-Schlange schlagend“ qualifizierten vedischen Gottheiten Indra, aber auch Agni („Feuer“), hindeutet. Eigentümlicherweise ist der avestische *Vərəθraγna* indes nie *vərəθra-jan-* – *vərəθra-jan-* ist vielmehr das Epitheton des avestischen Schlangentöters *Θraētaona* –, und dunkel ist, ob *vərəθra-* (≈ ai. *vṛtra-*) im Avesta auch die (dämonische) Schlange bezeichnet (hat). Das Wesen des *Vərəθraγna* scheinen folgende Züge zu bestimmen:

1. Er besitzt eine enge Beziehung zum Krieg;
2. Er ist der Schützer der Wege (der Totenseele?) und Reisenden (seine in späterer Zeit wichtigste Aufgabe);
3. Er ist – im Avesta nur in Spuren zu erkennen – der Gott der ewigen Feuer (vermutlich enger Bezug zu 2.);
4. Er besitzt eine besondere magische Kraft.<sup>16</sup> Yt 14 zerfällt im wesentlichen in zwei Hälften. Die erste Hälfte beschreibt 10 (meist tierische) Metamorphosen der Gottheit, mittels derer sich der Gott offenbar einem Opferer (*Zaraθuštra*) nähert.<sup>17</sup> Diese Fähigkeit zur Veränderung des *corpus* (av. *kəhrpa-*) ist höchst ungewöhnlich für einen iranischen *ahura*, indes typisch für einen *daēuua* (Dämon) (s. PY 9.15). Die zweite Hälfte des *Yašt* beschreibt (auch falsche [s. Yt 14.54-56]) Opfer an *Vərəθraγna*, besonders aber eine Reihe von magischen Praktiken. Diese scheinen

12. Vgl. Y 58.1 *taṭ. sōidiš. taṭ. vərəθrəm. dadəmaidē. hiiṭ. nəmē.* ... „Das bestimmen wir als Waffe, das als Schild/Rüstung, das Gebet ...“

13. In ZWY 7.11 begegnen die *dēw ī dawāl-kustīg* „ledergegürtete Dämonen“. Demgegenüber scheint der zoroastrische *kustīg* (≈ av. *aiβiiāṅhana-* / *aiβiiāsti-*) immer aus Lammwolle gewebt zu sein. In N 77.5, da der Fall besprochen wird, daß der „auf nacktem Körper“ (*maṅnam. tanūm*) getragene Gürtel Schaden verursacht, wird lieber auf den Gürtel verzichtet als das Material des Gürtels zu wechseln.

14. Auch bei den Offensivwaffen verwenden noch im 5. Jh. einige iranische Stämme nur teilweise aus Metall gefertigte Waffen, s. Her. 7.85.1 über die Sagartier.

15. Benveniste & Renou 1934; Gnoli 1989 mit Lit.

16. Stark hervorgehoben von Pirart 1999.

17. Man vergleiche Agnis „fetischartige Verkörperungen“ bestimmter Tiere bei der Feueranlegung (s. Oldenberg 1923, 75, 251).

sich sämtlich auf Krieger zu beziehen. Sie bestehen aus apotropäischen Sprüchen/Formeln, die sich mit Hantierungen mit kleinen, weitgehend unbearbeiteten Objekten verbinden, welche offenbar den nackten Körper berühren oder aber am Körper befestigt werden.

Das Alter von Yt 14 ist nicht bekannt. Wie die anderen *Yašts* setzt der Text von Yt 14 nicht nur die Domestizierung und das Reiten des Pferdes (s. Yt 14.9) voraus (bei Iranern um 2000 v. Chr.<sup>18</sup>), sondern auch das Kamel scheint – anders als vermutlich das Schwein<sup>19</sup> – bereits von großer Bedeutung zu sein (Yt 14.11-13, 39),<sup>20</sup> ebenso wie der Falke (also vermutlich die Falknerei). Wie alle anderen Hymnen ist auch Yt 14 mit der Königsinstitution offenbar unvertraut, was ein Datum vor den Achämeniden (Mitte des 6. Jh.) wahrscheinlich macht. Der geographische Horizont der *Yašts* läßt sich besser als der des *Yasna* fassen, und einige Hymnen sind sogar zu lokalisieren (Yt 5, 19 am Hamun-See; Yt 13 im nördlichen, Yt 14 im nuristanischen Hindukush). In Yt 10 (an Miθra) scheint das Zentrum der Miθra-Verehrung im zentralen Hindukush zu liegen, von wo aus der Dichter die Länder des östlichen/nord-östlichen Iran (Xoresmien und späteres Xorāsān) sukzessive überschaut (Haraiuua > Margu > Gauua > Suxda > Xvāiriza).

### **Magische Gegenstände und Zauber in Yašt 14**

In der zweiten Hälfte von Yt 14 finden sich Beschreibungen von vier Zauberpraktiken:

1. Yt 14.34-40<sup>21</sup>  
Zauber mit Federn und Knochen I<sup>22</sup>  
magischer Text in Yt 14.38

2. Yt 14.42-46 Zauber mit Federn II<sup>23</sup>  
magischer Text in Yt 14.45
3. Yt 14.57-58 Zauber mit *haoma* Zweig<sup>24</sup>  
magischer Text in Yt 14.57(-58)
4. Yt 14.59-60 Zauber mit einem Stein<sup>25</sup>  
magischer Text in Yt 14.59(-60)

Die besondere magische Bedeutung, die den Federn zukommt, ist Vərəθraγnas wichtigster Gestaltung als Falke (*vārənjan(a)*; s. Yt 14.18-21; 14.35) geschuldet. Der zweite Federzauber scheint eine entscheidungslose Schlachtsituation zu beschreiben. Er bewirkt ein *vərəθra* für die den Zauber ausführende Armee, d.h. er führt den „Sieg“ in der Schlacht herbei. Zugleich kommt den Federn eine apotropäisch-defensive Wirkung zu (ob das in Yt 14.45 mit verschiedenen Präverbien verwendete Verb *marəz-* „streifend berühren“ auf ein Bestreichen des Körpers hinweist [s. Fußnote 45 zu *māl-*], ist unklar). Sie sind *apātar-* and *nipātār-* „Schützer“, bzw. *nišharətar-* „Wächter“. Die von diesen Termini angedeutete Dialektik von Schutz und Sieg wird sich in allen anderen drei Zaubern (Nr. 1, 3, 4) wiederfinden. Diese Zauber beziehen sich unmittelbar auf den menschlichen Körper, indem sie Handlungen mit kleinen Gegenständen an diesem beschreiben.

### **Zauber mit haoma und Steinen (Zauber 3 + 4)**

Die magischen Praktiken Nr. 3 (*haoma*) + 4 (Stein) teilen dieselbe Beschreibung. Nach einer kurzen Dedikation an Vərəθraγna nennen die Strophen Yt 14.57 bzw. 59 den Zaubergegenstand und dessen Behandlung. In Yt 14.58 bzw. 60 folgt sodann die Nennung des erhofften Erfolgs:

18. Boyce 1975, 151.

19. Das Schwein wird im Avesta nur selten erwähnt. Yt 14.15 redet von „des Ebers Schweinsgestalt“ (*hū.kəhrpa. varāzahe.*), ebenso Yt 10.70, da der Eber eine besonders herausgehobene Erscheinungsweise des Vərəθraγna darstellt. Dieser Eber scheint als ein wildes Tier vorgestellt zu sein.

20. Das Kamel wird bereits in Y 44.18 erwähnt, und es figuriert nicht zuletzt im Namen des Zaratustra, was darauf hinweist, daß die aav. Texte in einem Gebiet entstanden sein müssen, da die Domestizierung von Kamelen üblich war („der *zarat*-Kamele besitzt“).

21. Zu magischen zoroastrischen Texten und den Texten Yt 14.34-40 s. Modi 1894 (1911); 1900a (1911); 1900b (1911).

22. Dazu Lommel 1927, 139 n. 3; Friš 1951, 502-504.

23. Zu diesem s. Hübschmann 1882, 99; Geldner 1884, 82-83; Lommel 1927, 134, 140 n. 1; Friš 1951, 509-512; Humbach 1976.

24. Zu diesem Lommel 1927, 134; Friš 1951, 504-506.

25. Zu diesem Lommel 1927, 135. Zu Steinamuletten s. Callieri 2001, 26-31. In der Pahlavi-Literatur enthält *Pahlavi Rivayat Dādestān ī dēnīg* 64 eine Aufzählung magischer Steine.

Yt 14.58, 60

*yaθa. azəm. auuata. vərəθra. hacāne.*  
*yaθa. vīspe. anīe. aire.*  
*yaθa. azəm. aom. spāδəm. vanāni. yaθa.*  
*azəm. aom. spāδəm. niuuanāni. yaθa.*  
*azəm. aom. spāδəm. nijanāni. yō. mē.*  
*paskāt. vazaiite.*

Daß ich begleitet (*hac-*) werde von solch einem *vərəθra* wie alle anderen Arier.  
 Daß ich jenes Heer überwinde, daß ich jenes Heer vollständig überwinde, daß ich jenes Heer niederschlage, welches hinter mir herzieht.

*vərəθra-* ist definiert als der Wunsch, zu siegen (*van-*, *ni-van-*), die feindliche Armee zu schlagen (*spāδəm. ni-jan-*). Die Bedeutung von *vərəθra-* ist folglich (wie schon im zweiten Zauber) „Sieg“. Zugleich ist *haoma* – wie die Federn im zweiten Zauber – bestimmt als „guter Schützer“ (*nipātārəm. vohu.*) und „Wächter für den Körper“ (*pātārəm. tanuiie.*):

Yt 14.57

*vərəθraynəm. ahuraδātəm. yazamaide.*  
*haoməm. baire. +sāiri. baoyəm. haoməm.*  
*vərəθrājanəm. baire. nipātārəm. vohu.*

*baire. pātārəm. tanuiie. baire. haoməm.*  
*yim. niuūzaiti. niuuanānā. apaiiēiti.*  
*dušmainiiao. pāšana. haca.*

Wir opfern dem / beten zu<sup>26</sup> dem *vərəθrayna*. Ich trage den *sāiri.baoyəm* *Haoma*<zweig>, den Widerstand brechenden *Haoma*<zweig><sup>27</sup> trage ich, den guten Schützer trage ich, den Hüter für den Leib trage ich, den *Haoma*<zweig>, den man ansteckt (?), <den man> aus der Fessel<sup>28</sup> befreit (?) vom Feind mittels des Kampfes.<sup>29</sup>

Yt 14.57 sagt, jemand „trägt“ (*bar-*) den *haoma*. Die Form *baire* (1.Sg.Pr.Inj.med.) weist darauf hin, daß *bar-* im Sinne von „etw. an sich tragen“ verwendet wird.<sup>30</sup> Die Bedeutung von *ni-viz-* ist unsicher (möglicherweise „anhängen“).<sup>31</sup> *Haoma*, der angehängte (?) Gegenstand, entspricht dem altindischen *soma* und ist sowohl der Name der im „Opfer“ (*yasna*) gepreßten (*hu-*) Pflanze (oder des Pilzes) wie des gewonnenen (ehemals toxischen) Saftes. Yt 14.57 scheint den *haoma* als Pflanze/Pilz zu bezeichnen. Deren Attribut *sāiri.baoya-* ist unklar (vielleicht „den Kopf einbiegend“<sup>32</sup>).

26. *yaz-* meint sowohl einen Opfer- wie Gebetsakt. Letzteres zeigt Yt 10.32: *surunuiā. nō. miθra. yasnahe.* „Erhöre, o Miθra, unser Gebet (*yasna*)“.

27. Nach Benveniste & Renou 1934, 20, eine „allusion au pouvoir de Hauma comme amulette“; s.a. Flattery & Schwartz 1989, 51, 58.

28. Zur Bindung des *haoma* vgl. Y 10.17 *vīspe. haoma. upastaomi. ... yačē. qzahu. dərətāhō. jaininəm. upadarəzāhu.* „Ich preise alle *Haoma*<zweige> ... die gepreßt gehalten werden in den Befestigungen der Weiber“.

29. Im *Šāhnāme* besiegt Kay Xosrō den Afrāsiyāb durch Hōms Hilfe (s. Boyce 1975, 159).

30. Allerdings zeigt Yt 14.27 *barač.*, daß auch das Aktiv verwendet werden kann.

31. <sup>31</sup>*niuūzaiti.* → PÜ *ēn kāmāg +sahist*; NpÜ M4 *morād xwāste* (← *niuuazaiti.*). 3.Sg.Pr.Ind. *ni-viz-* „anstecken“ (?). AiW 1329 bestimmt die Bedeutung des av. Hapax *ni-viz-* rein kontextuell als „an-, einstecken“. Friš 1951, 505, erwägt verschiedene Etymologien, ist jedoch der Meinung, die Bedeutung sei in jedem Fall „directly opposed to Bartholomae’s“ (Friš übersetzt: „I carry a haoma twig as protection (literally „protector“) to my body because it liberates (lifts) from captivity and is the cause of winning the battle over the enemy“). Bailey 1979, 387b, und dann Flattery/Schwartz 1989, 137 n. 9, haben für *ni-viz-* auf av. *a-vaēza-* (s. AiW 168; PÜ *awināh*) und idg. Parallelen hingewiesen (Bailey: „without bond (of evil)“). Kellens 1984, 101-102 („?“) gibt 1995, 56, als Bedeutung „rendre un culte“ – dem folgend de Vaan 2003, 229 („to pay homage to“), Cheung 2007, 433 („to venerate?“) –, jedoch ohne Anbindung im Iranischen noch Indogermanischen. Die Mss. zeigen verschiedenste Schreibungen: *niuuazaiti.* (für diese Lesung entscheidet sich Geldner 1884, 89-90, mit einer Übersetzung „trägt“; sie wird ebenfalls bei Friš 1951, 505, erwogen [vgl. ai. *nī vahati* „to carry home“]) in M4 ließe sich als „führt nach unten“ deuten (s. V 5.8 → *nigōn-wazēnēd*); *niuuazaič.* K36, K37; *nijaiči.* K40; *nizač.* K12; *niuuizaiči.* Jm4 / M12; *niuujaide.* Pt1, L18, P13, O3; *naiuuazaiti.* J10; *nizaiče.* L11. Die PÜ/NpÜ(M4) stellt zu *vaš-* „wünschen“.

Das Anstecken des Zweiges wird von Clemen 1920, 144, mit einer „in (oder in der Nähe von) Persien (und Indien)“ verbreiteten Sitte der Baumberührung verglichen (wofür allerdings nur Yt 14.57 als Beleg beigebracht wird).

32. *sāiri.baoyəm.* → PÜ *sardār +bay* (*baγ*); NpÜ M4 *sardār [o] hešše o qesmat-konande.* Das Wort *sāiri.* ist vermutlich zu *sāiriuuant-* „around which carrion birds are flying“ (Humbach/Ichaporria 1998, 74) zu stellen. AiW 1573 gibt für *sāiri.baoya-* „aus, vor dem Untergang rettend“. Humbach/Ichaporria 1998, 74-75, vergleichen mit *Vaiius* Epitheton Yt 15.45 *aiπi.δbaoya-* „hinterher einbiegend“

Das Motiv des *haoma*-Tragens scheint in einem Indra-Mythos eine Parallele zu besitzen. AV 2.27 zeigt Indra in einem Redestreit mit den *asuras*. Um diesen zu gewinnen, ruft Indra eine *pātā-* genannte Pflanze an (Vers 1/4). Diese wurde einst von einem Adler (*suparṇás*) gefunden und von einem Eber ausgegraben (Vers 2). Indra plaziert die Pflanze als ein Amulett am Arm (Vers 3) und ißt (*vi-aś-*) sie schließlich (Vers 4):<sup>33</sup>

1. May the enemy not win **the debate!**  
Thou art mighty and overpowering.  
Overcome the debate of those that debate against us, render them devoid of force, O plant!
2. An **eagle** found thee out, a **boar** dug thee

out with his snout. Overcome the debate of those that debate against us, render them devoid of force, O plant!

3. **Indra placed thee upon his arm** in order to overthrow the Asuras. Overcome the debate of those that debate against us, render them devoid of force, O plant!
4. **Indra did eat the pātā-plant**, in order to overthrow the Asuras. Overcome the debate of those that debate against us, render them devoid of force, O plant!<sup>34</sup>

Der *suparṇás*-Vogel wurde von Malandra als der mythologische Vogel Śyena (av. Saēna) identifiziert,<sup>35</sup> der mit *soma/haoma* in enger Verbindung steht.<sup>36</sup> Wahrscheinlich ist *pātā* ein spezieller indischer Name

(AiW 85; EWA II, 274-275), bieten jedoch keine Übersetzung. Als „Kopf“ ist *sāiri*. (*sāre*. L18 / J10.) gedeutet bei Geldner 1884, 89; Lommel 1927, 142; Flattery/Schwartz 1989, 51 („head-saving“). Darmesteter 1892-1893 II, 575 N.80, verweist indes auf V 8.83 *saire.hiia-* „Mistdarre“ (s. *sairiia-* „Mist“ V 8.8, np. *sar-gm*). Die Übersetzung *sāiri*. → *sardār* „Hauptmann“ basiert wohl demgegenüber auf Anklang (*sāre*. L18 / J10; vgl. Yt 14.46 *sāram*. → *sar*). Die Übersetzung von *baoyam*. → PÜ *bay* geschah möglicherweise nach einem fehlerhaften Manuskript (*bayam*. L18, P13, O3 / Jm4 [sec.m.] / J10).

33. Zu Zusammenstellungen von Indra, Soma und *aś-* „essen“ vgl. RV 3.36.8, 9.51.3 (beide *vi-aś-*), s.a. RV 1.170.5, 10.85.3,4.

34. Übersetzung Bloomfield 1897, 137-138

35. Fünf Belege von *suparṇá-* im RV in dieser Verbindung.

36. Malandra 1979, 220-221 and n. 13. Die ausführlichste Darstellung des zentralen Mythos des Śyena („Falke“ [in Geldners RV-Übersetzung bevorzugen die ersten Bücher eine Bedeutung „Adler“, während in den späteren Teilen Geldner mit „Falke“ übersetzt]) im RV bilden die Lieder RV 4.26&27. Sie halten einen Bericht Indras vor den Maruts fest: Der *prá śyenaḥ śyenebhya āsupátvā* „den Śyenas voraus schnellfliegende Śyena“, der „gedankenschnelle“ (*mānojavā*) habe sich, als ein „Ausgesandter“ (*iśitās*, RV 9.77.2), auf den Weg zur Herbeibringung der Opferspeise, des „somischen Met“ (*mādhunā somyénotā*), gemacht. RV 4.26.6-7a erzählen das mythische Urbild dieses Tuns: „Vorausschießend, den Stengel (*añśúm*) haltend, brachte der Adler, der Vogel aus der Ferne (*parāvataḥ* [vgl. RV 9.68.8, 10.144.4]) den erfreulichen Rauschtrank, der Götterfreund den Soma, ihn festhaltend, nachdem er ihn aus jenem höchsten Himmel geholt hatte. Nachdem er ihn geholt hatte, brachte der Adler den Soma, tausend und zehntausend Trankopfer auf einmal“ (Übersetzung Geldner 1951 I, 454-455). RV 4.27 (vgl. dazu Oldenberg 1923, 173-174) berichtet den Mythos sodann aus der Perspektive seiner Protagonisten, Śyena und Soma. Śyena erzählt, er sei vor seinem Somaraub von „hundert ehernen Burgen“ (*śatām ... pūra āyasīr*) bewacht worden (RV 4.27.1b [Text zitiert in *Aitareya-Upanishad* II, 4]), und Soma, Śyena habe ihn ungern (wegen seiner überlegenen Kraft) hinfortgetragen. Das Geschehen ist dramatisch: Śyena stürzt sich zum Raub vom Himmel herab, der Schütze *Kṛṣānu* schießt nach ihm (s.a. RV 9.77.2.); doch Śyena gelingt der Raub (er reißt den *madirām añśúm* „berauschenden Stengel“ [RV 6.20.6] vom Felsen [*ādreh*], s. RV 1.93.6), wobei er, als der „Eisenkrallige“ [*āyopāśtis*], die *Dasyus* tötet, s. RV 10.99.8), und er bringt den Soma „von den hohen (Himmels)rücken zu den Indraanhängern“ (RV 4.27.4; RV 8.82.9 sagt, er habe den Soma zu Indra „mit dem Fuß gebracht“ [*padābharat*]), während der Schütze lediglich eine Feder des Śyena herabzuschießen vermag (s. dazu noch Geldner 1951 I, 455-456 n. 4.27.4c). Die Bedeutung des Soma-Raubes besteht in folgendem: 1. In Parallelität zur Herbeibringung des Feuers (*Agni*) wird durch den Raub das Opfer erst ermöglicht (s. dazu RV 1.93.6); 2. Der Genuß des „vom Śyena gebrachten“ (*śyenaḥbhṛta-*, RV 1.80.2, 8.95.3, 9.87.6; vgl. °*jūta-* RV 9.89.1) Soma ermöglicht es erst dem keulenträgenden Indra, den *Vṛtra* zu erschlagen. (In RV 5.45.9 stehen Śyena und Soma in Beziehung zum Wiederhervortreten der Sonne aus dem Himmelsfels, doch scheint dies nicht mit dem Raubmythos in Verbindung zu stehen, da dieses Lied sagt, der Śyena fliege zum Somatrank.)

Auch neben dem Mythos werden Śyena und Soma durch Vergleich eng einander verbunden. RV 9.38.4 sagt, Soma „läßt sich in den menschlichen Ansiedlungen (*mānuśīṣu ... vikṣu* [vgl. RV 1.148.1]) nieder wie ein Falke <im Nest>“ (Übersetzung Geldner; vgl. RV 9.62.4, zur Ergänzung s. z.B. RV 9.71.6; in RV 9.65.19 dient ein ähnliches Bild des Śyena zum Vergleich mit dem Rinnen des Soma ins Holzgefäß). Besonders aber ist auf das Bild RV 9.67.14/15 hinzuweisen: „In die Krüge eilt der Falke; er taucht in seinen Panzer unter. Brüllend (geht) er auf die Holzgefäße los. Dein ausgepreßter Saft, o Soma, ward in den Krug übergegossen; er schießt dahin wie der Falke im Fluge“ (Übersetzung Geldner; vgl. RV 9.82.1, 9.96.19). Hier wird der Śyena selbst zum Soma, Soma selbst zum Śyena.

Zu einer Parallele der Beziehung von Adlervogel und göttlichem Rauschtrank (in RV 4.18.18 *mādhu-* statt *sóma-*) in der *Snorra Edda* s. Kuiper 1970, 283-284.

der *haoma*-Pflanze. Problematischer ist zumindest im vedischen Material die mythologische Identifizierung des Ebers.<sup>37</sup> Die Zusammenstellung von *Śyena* und Eber erinnert allerdings an avestische Verhältnisse. In Yt 14.41 wird *Vərəθraϥna*, dessen zweitwichtigstes *Avatar* sonst das des Ebers ist (Yt 14.15; Yt 10.70-72), mit dem *Saēna* verglichen. Veda und Avesta zeigen also einen Motivzusammenhang von Falke + Eber + *haoma/soma* (*pātā*) + *Vərəθraϥna*/Indra.

Im vierten Zauber ist der Zaubergegenstand ein Stein. Er wird näher bestimmt als *siϥūire*. bzw. *siϥūire. ciθra-*, (vermutlich) „von *siϥūirischer* Herkunft“. Das Wort *siϥūiriia-* scheint mit den altindischen *śigravas*, einem im RV erwähnten Stamm, verwandt zu sein.<sup>38</sup>

Yt 14.59

*asānəm. siϥūire. ciθrəm. / abarə. (?<sup>39</sup>)  
ahurō.puθrō. / puθrāñhō. baēuuarə.  
pataiiō. / amauua. ās. vərəθrauuu. nqma.  
/ vərəθrauuu. ās. amauua. nqma.*

Der Sohn eines Herrn (*ahura*) [„Söhne“ <bezeichnet> die Herren über 10000], er trägt den Stein von *siϥūirischer* Herkunft <auf dem stand / über den gesprochen war>: „Er ist der Starke (*amauuañt-*), *vərəθrauuu-* ist sein Name; er ist der Widerstehende (*vərəθrauuu-*), *amauuañt-* ist sein Name.

Die Passage weist in die Sphäre militärischer Macht.<sup>40</sup> Der Ausdruck „Herr der 10000“ (*baēuuarə. pataiiō.*), der im Text m.E. als inneravestische Glosse zur Definition von *puθra-* „Prinz“ (?) geführt wird, gemahnt an die berühmten 10000 ἀθάνατοι (Her. 7.83)

bzw. „Immortales“ (Quintus Curtius 3.3.13) des achämenidischen Heeres der antiken Historiker:

*Proximi ibant quos Persae Immortales vocant, ad decem milia. Cultus opulentiae barbarae non alios magis honestabat ; illi aureos torques, illi vestem auro distinctam habebant manicatasque tunicas, gemmis etiam adornatas.*

Als nächste marschierten zu 10000 diejenigen, die die Perser „Unsterbliche“ heißen. Niemand anders wurde im Rahmen der Verehrung barbarischer Opulenz mehr geehrt; goldenen Halsschmuck, ein goldgeziertes Kleid besaßen sie, sowie langärmelige Tuniken, sogar mit geschnittenen Edelsteinen (*gemmis*) besetzt.<sup>41</sup>

Auch hier tragen die Elitesoldaten Steine/Gemmen als Teil ihrer militärischen Bekleidung. Man mag in solcher Praktik eine Erinnerung an Zeiten sehen, da (geschnittene) Steine nicht bloßer Schmuck, sondern die eigentliche, nämlich magische ‚Rüstung‘ darstellten.

Der in Yt 14.59 zitierte Zauberspruch ist aufgrund seiner chiastischen Struktur interessant:

*amauua. ās. vərəθrauuu. nqma.  
X  
vərəθrauuu. ās. amauua. nqma.*

Folgen wir der allgemeinen Meinung, die eine Niederschrift des Avesta vor der Sasanidenzeit für unwahrscheinlich hält – ausgeschlossen ist eine solche Niederschrift in einem semitischen Alphabet

37. *Sāyana* hatte das Eberbild von AV 2.27 auf *Viṣṇu* bezogen.

38. *siϥūire*. → PÜ *ān kāmag*; NpÜ M4 *morād*. AiW 1580; Cantera 1999. Nur hier belegt. AiW 1580 verbindet *siϥūire* (< \**siϥuir-ia* zu av. \**siϥru-*, s. Cantera 1999, 45) mit dem in RV 7.18.19 figurierenden, pferdeschlachtenden Volk der *śigravas* (Grassmann 1873, 1393, *çigru-* „Eigennamen eines Volksstammes“), eine Verbindung, der sich auch Cantera 1999, 45, angeschlossen hat (zu *śigru-* „*Moringa pterygosperma*“, eine u.a. in Nordindien vorkommende und verwendete Heil- und Nahrungspflanze, dem Namen nach verwandt mit ir. \**sigra-* > *sīr* „Knoblauch“, s. mit Lit. EWA II, 635). Die Genese der PÜ/NpÜ(M4) (*siϥūiri*. M4; *suϥure*. L11, K40; *suϥuiri*. Jm4 (sec.m.); *suguri*. Pt1, L18, O3; *siϥūrəmi*. K36, K37, M12; *sugərəm*. P13; *sogauuare*. J19.) ist dunkel (ein Erklärungsversuch bei Dhabhar 1963, 261 N. 59.1). In noch späterer Übersetzung scheint *siϥūire*. von *zūdī* „Schnelligkeit“ übersetzt zu werden, eine Wiedergabe, die auf der Interpretation des Wortes als skr. *śīghrya-* (s.a. guj. *śīgh* „schnell“) beruht.

39. 3.Sg.Impf. (?); oder \**ābaira*. (Geldner 1884, 91).

40. Vgl. Yt 5.85 *auruuāñhō. ahurāñhō. daiñhu.pataiiō. puθrāñhō. daiñhu.paitinqm*. „die *auruuant-* Herren, die Landesherren, die Söhne der Landesherren“. Zu *auruuant-* vgl. Darius Eigenschaft der *aruvasta-* in DNb.

41. Her. 7.83.3 κόσμον δὲ πλείστον παρείχοντο διὰ πάντων Πέρσαι „die Perser zeigten (unter den 10000) den reichsten Schmuck“. Zum Schmuck der Achämeniden s. Rehm 1992.



nicht, da der korrekte avestische Vokalismus durch die orale Tradierung abgesichert ist –, so müssen wir von einem Besprechen des Steines ausgehen. Diese Praktik, einen Kleidungsgegenstand magisch zu besprechen, ist im zoroastrischen Iran nicht unbekannt. Sie erfolgt z.B., wenn die Gürtelschnur der Zoroastrier vom Webstuhl genommen wird.<sup>42</sup>

### Zauber mit Federn (Zauber 1)

Der erste Zauber in Yt 14, Yt 14.34-40, operiert mit Federn und Vogelknochen. Wie Yt 14.59/60 bezieht sich auch dieser Zauber auf hochrangige Krieger bzw. auf mythische Helden.<sup>43</sup> In Yt 14.38 scheint der Text wiederum einen magischen Spruch zu zitieren. Die gesamte Passage beginnt in Yt 14.34 mit einer Frage:

Yt 14.34  
*yaṭ. bauuāni. aiβi.sastō. aiβi.šmarətō.*  
*+pouru. narqam. + t̄bišiiantqam. ciš. +aṅhe.*  
*asti. baēšazō.*

Wenn ich von feindlichen Männern mit Worten und Gedanken verflucht sein sollte, was ist das Heilmittel dagegen?

Der folgende Zauber bildet die Antwort. Der Verfluchte soll seinen Körper mit einer Feder bestreichen (*aiβi.sifōiš.*) (Yt 14.35) oder aber Federn und Knochen eines Vogels tragen (*baraiti.*) (Yt 14.36):

Yt 14.35  
*mərəyahe. pəšō.parənahe. +vārənjanahe.*  
*parənəm. aiiasaēša. spitama. zaraθuštra.*  
*ana. parəna. tanūm. aiβi.sifōiš. ana.*  
*parəna. hamərəθəm. paiti.sajhaēša.*

Des Vogels mit weit gespreizten Flügeln, des Vārənjana<-Vogels> Feder sollst du nehmen, o Spitama Zarathustra! Mit dieser Feder sollst du über <deinen> Leib streichen, mit dieser Feder sollst du <deines> Widersacher<s Fluch> bannen.

Bis in die Moderne hinein hat eine magisch-medizinische Praktik überlebt, welche die Rezitation von Yt 3 – an Aša (Vahišta), ebenfalls eine ‚Feurgotttheit‘ – mit einem (später durch ein Handtuch ersetzt<sup>44</sup>) Federritual kombinierte. Das Ritual wurde vor ca. 100 Jahren von Jackson und Modi beschrieben. Parallelen im *Šāhnāme* indizieren,<sup>45</sup> daß diese Art der Federheilung in Iran eine lange Tradition besitzt. Die

42. „Fast vollendet, wird das ganze Gewebe vom Webstuhl abgenommen und von einem Priester zurechtgeschnitten und durch vorgeschriebene Sprüche geweiht.“ (Junker 1959, 29). Möglicherweise handelt es sich dabei um Y 55.2. Dieser Vers – er bezeichnet die in Y 54 beendeten *Gāḡās* als *xʷarθam. vastramca. uruuane*. „Essen und Kleid für die Totenseele“ – wird von den Hss. eines Pāzand-Traktats über das *Kustīg* zitiert.

43. Yt 14.39-40: Welche <Kraft und Kraft der Widerstandsbrechung> bei sich führten die Herren, bei sich führten die Herrensöhne, bei sich führten die Ruhmreichen (?) (*ahurāṅhō. ... āhūrīiāṅhō. ... haosrauuāṅhanō.*), die bei sich führte Kauui Usan ... <und> der starke θraētaona trug/besaß, welcher die Schlange Dahāka erschlug, ...“.

44. In späterer Zeit: “When the custom of making passes was introduced among the Parsees, though the Parsee priest used his handkerchief for making passes over the patient, the foreign word ‘pichhi,’ (feather) came into use with the custom. I have more than once seen the Ardibehest Yasht recited over a patient but have never seen the use of feathers.” Modi 1924, 66; vgl. Jackson 1906, 379; Callieri 2001, 20.

45. Die Federzauber von Yt 14 sind schon früh zu den Zaubern im ŠN in Beziehung gesetzt worden (s. Spiegel 1863, XXXIII). Dort dienen die Federn des Sīmorǰ (= av. *saēna- mərəya-*) als Heilmittel von Kampfunden oder aber als Schutzmittel, und zwar sowohl gegen körperliche Gefahren wie verbale Anfeindungen. Dazu werden die Federn entweder über den Körper gerieben (*māl-*; vgl. Yt 14.45 *āmarəzən. vīmarəzən. framarəzən.*), oder aber verbrannt, eine Praktik, von der Yt 14 nicht berichtet. Die wesentlichen Stellen des ŠN sind die folgenden: ŠN 15, 3664-3668 (Kampf Rustam – Isfandiyār) (vgl. ŠN 7.1686): *negah kard morǰ andar ān xastegī / be-ǰost andar ān nīz peywastegī // az-ū cār paykām be-bīrūn kešīd / be-menqār az ān xastegī xūn kešīd // bar ān xastegīhā be-mālīd parr / ham andar zamān gašt bā zūr o farr // bed-ū goft k-īn xastegīhā be-band / hamī bās yek-hafte dūr az gazand // yekī parr-e man tar be-gardān be-šīr / be-māl andar-īn xastegīhā-ye tīr* „Der Vogel besah die Wunde und suchte sie zu heilen. Er entfernte vier Pfeilspitzen und sog mit dem Schnabel das Blut heraus. Mit den Federn strich er über die Wunden, da kamen Kraft und *farr* <zu Rustam> zurück. Er sagte zu ihm: ‚Verbinde die Wunden, und nach einer Woche wird sich das Übel entfernt haben! Eine meiner Federn befeuchte mit Milch und reibe sie in die Pfeilwunden!‘“ Rustam wird Isfandiyār schließlich mit einer List überwinden, in der ein Tamariskenzweig (*šāx-e gaz*) und das Reiben von Rustams Kopf mit den Vogelfedern eine bedeutende Rolle spielen (ŠN 15.3692ff.). ŠN 7.181-183 (Sīmorǰ spricht zu Sām) (vgl. ŠN 7.1665): *abā xwīštan bar yekī parr-e man / hamī bās dar sāye-ye farr-e man // gar-at hīc saxtī be-rūy āwarand / ze nīk ō ze bad goft o gūy āwarand // bar ātaš bar aṅkan yekī parr-e man / be-bīnī ham andar zamān farr-e man* „Nimm eine meiner Federn mit Dir, so wirst Du unter meinem *farr* stehen. Solltest

durch Federn und Knochen bewirkte Widerstandskraft macht in Yt 14 den Bestrichenen unüberwindlich:

Yt 14.36

*\*yō. nā. baraiti. astauuō. vā. taxmahe. mərəyahe. parənanuuō. vā. taxmahe. mərəyahe. naēda.ciš. raēuuu. mašīia. jaiṅti. naēda. fraēšīieiti/\*frašāuuaiieiti. (?) paouruuu. hē. nāmō. baraiti. paouruuu. xʷarəṅā. vīdāraiieiti. upastqm.*

<Denn> welcher Mann <am Leib> <sie> trägt, ob der mit Knochen des starken Vogels Versehene, ob der mit der Feder des starken Vogels Versehene, kein <noch so> prächtiger Mensch<sup>46</sup> schlägt <ihn dann>, und keiner vertreibt <ihn dann>. Ihm zuerst bringt sie (die Feder des Vogels) Ehrerbietung <und> zuerst die *xʷarəṅahs*;<sup>47</sup> sie verteilt Beistand, die Feder des Vogels der Vögel.

Yt 14.37

*tā. ahurō. sāstranqm. daijhupaitiš. nōit. satəm. jaiṅti. vīraja. nōit. hakərət. jaiṅti. \*vaēsifō. ōim./\*aēm. jaiṅti. \*fraēšīieiti./ \*frašāuuaiieiti. (?)*

Dadurch <geschieht folgendes>: Der Herr unter den Gebietern (*ahurō. sāstranqm.*),

der Landesherr, schlägt/tötet nicht hundert, der <sonst> Männertötende schlägt/tötet nicht auf einmal, – der Bestrichene allein schlägt/tötet <und> vertreibt.

Yt 14.38

*+vīspe. tərəsəṅti. \*parənine. auuaθa. māuuaiiaciṭ. (tanuuō. auuaθa. māuuaiiaciṭ.) tanuiie. vīspe. tərəsəṅtu. auruuuθa. vīspe. tərəsəṅtu. duš.mainiuš.aməmca. vərəθraynəmca. niḍātəm. tanuiie. manō.*

[Amuletttext:] ‚Alle fürchten den Gefieder-ten (Dat.) – so <denn> auch mein <Gefieder> (des Leibes, so auch meinen <von der Feder bestrichenen>) Leib sollen fürchten alle Feinde (?), sollen fürchten alle Übelgesinnten <meine> Kraft und Kraft zur Widerstandsbrechung (*aməmca. vərəθraynəmca.*), <sowie> den <in/an> <meinem> Leib niedergelegten Gedanken.‘

Federn als Teil der Rüstung sind aus parthischer wie sasanidischer Zeit bekannt. In Hung-e Kamālwand<sup>48</sup> findet sich ein parthisches Relief, das einen Ritter in einer sehr eigentümlich mit Federn besetzten Rüstung zeigt.

Besser bekannt sind Federn (bzw. Flügel, s. Relief Wahrām II, Sar Mašhad) als Teil der sasanidischen Kronen<sup>49</sup> Der erste Sasanidenherrscher, Ardašīr I,<sup>50</sup>

Du jemals in Schwierigkeiten geraten, sollte man Dich wie immer auch mit Worten anfeinden, dann wirf eine meiner Federn aufs Feuer, und Du wirst sogleich mein *farr* erfahren!“

46. Zu den inhaltlichen/syntaktischen Problemen von *naēda.ciš. raēuuu. mašīia*. s. Kellens 1975, 66 n. 10. Vgl. mit *raēuuu. mašīia*. auch RV 7.1.23 *mārto ... revān*. In V 20.1 ist es Θrita, der als erster „unter den zauberkundigen, prächtigen ... Paraḍāta-Menschen\* Krankheit <und> Tod ... abhält“ (*mašīiānqm. ... yātumatqm. raēuuatqm. ...paraḍātqm. yaskəm. ... mahrkəm. ... dāraiiat*; nach AiW 1285 ist *yātu*<sup>o</sup> gemäß der PÜ in *+yāta*<sup>o</sup> zu korrigieren).

\*Zu *paraḍāta-* „am Anfang erschaffen“ (?) vgl. die Bezeichnung der Königsskythen als *παράλαται* in Her. 4.6; zum Wort s. Kellens 1974, 264-265.

47. Übersetzung weitgehend nach Hintze 1994, 23. Die Opposition zu *baraiti. ... xʷarəṅā*. formuliert Yt 10.27 *yō. ... paiti. xʷarəṅā. vāraiieiti. apa. vərəθraynəm. baraiti. auuarəθā. hiš. apiuuaiti*. „welcher (Miθra) die *xʷarəṅahs* (des feindlichen Landes) abwendet, die Kraft zur Widerstandsbrechung wegbringt, ihre (der feindlichen Länder) Wehrlosen jagt.“ Malandra 1983, 85, sieht bezüglich Yt 14.36 in *xʷarəṅā*. eine Qualität der Feder (“possessing much (?) *xwarənah*”).

48. Vanden Berghe & Schippmann 1985, 42-46 + Pls 7-19.

49. Zur Darstellung des Vogels bzw. seiner Federn an Kronen s. Stricker 1964, 312-313; Shahbazi 1984, 317; s.a. Widengren, 1965, 335. Bilder von Vögeln auf Helmen ostiranischer Krieger finden sich in Widengren 1969, Abb. 18+19. Allgemein wird in diesen Darstellungen ein Verweis der Vogeldarstellung auf *Vərəθrayna* gesehen, die weitere Deutung ist jedoch umstritten. Nach Koch 2001, 4 & Abb. 2, sind auch die eigenartigen Mützen jener als Perser gedeuteten Bogenschützen auf den Nordpalastreliefs von Nive (Mitte 7. Jh. v. Chr.) als Federn zu identifizieren, deren sublimierte Form sich dann in den typischen kannelierten Kopfbedeckungen der Persergardisten in Persepolis wiederfinden soll.

50. Dazu Mosig-Walburg 1982, 31-36.

trägt einen Vogel an seiner Krone, und er bezieht sich damit auf persische Herrschertraditionen, wie sie bereits im 2. Jh. v. Chr. bezeugt sind (Vogel an der Tiara).<sup>51</sup> Von Wahrām II an (276-293) – ein nach *Vərəθraγna* genannter König<sup>52</sup> – fügen dann zahlreiche Herrscher Federn/Flügel ihrem Kronschmuck zu (Hormizd II,<sup>53</sup> Wahrām IV, Pērōz, Xusrō II, Ardašīr III, Burān, Hormizd V, Xusrō V, Yazdegerd III),<sup>54</sup> und noch das Navsariier np. Ms. F46 (kopiert im 19. Jh.) schließt einen moralischen Text ein, der von den „21 *Kanguras* (Federn) an der Krone von Kaiser Noširwan“ zu berichten weiß.<sup>55</sup>

### **Die Zauber Yt 14 (Zusammenfassung)**

Das Ziel der Zauber 1, 3 + 4, ist ein doppeltes. Mittels magischer Gegenstände, die dem Körper oder der Kleidung angefügt werden, machen die verschiedenen Zauber den Körper gegen feindliche Angriffe widerstandskräftig, so daß schließlich ein Sieg errungen werden kann. Diesem doppelten Ziel dienen freilich alle Defensivwaffen. Gleichwohl scheint zwischen den magischen Gegenständen in Yt 14 und der technologisch fortgeschrittenen Rüstung in V 14.9 der Wandel eines Zeitalters zu liegen. In Yt 14 begegnet (wie in allen anderen jav. Texten) eine semantische Kuriosität, die jedoch in Yt 14 eine besondere Pointe besitzt. Diese Kuriosität besteht darin, daß das Neutrum *vərəθra-* „Widerstand“ (*var-* „einschließen“) (bzw. *vərəθrauuant-* „widerstandsfähig“) dieselbe Bedeutung wie dessen

Antonym *vərəθra-γna-* (wörtl.) „Schläger des Widerstands“ (bzw. *vərəθra-jan-* „den Widerstand schlagend“) hat: Beide Wörter bedeuten „Sieg“ (bzw. „siegreich“) (eine Bedeutung, die im übrigen für ai. *vītrá-* m. nicht angesetzt werden kann). Ich vermute, daß diese Entwicklung von *vərəθra-* („Widerstand“ > „Sieg“) durch einen Wandel in der Militärtechnologie, einen Fortschritt bei der Entwicklung der Defensivwaffen zu erklären ist. Ein Krieger, dessen Widerstand (aufgrund seiner Ausrüstung) nicht gebrochen werden kann, der jedoch zugleich fähig ist, einen anderen Widerstand zu brechen – nur ein solcher Krieger, der über die besseren Defensivwaffen verfügt, wird siegreich sein. Möglicherweise markiert der semantische Wandel von *vərəθra-* jenen historischen Punkt, an dem Offensiv-<sup>56</sup> und Defensivwaffen über den Schlachtausgang entschieden.<sup>57</sup> Die Bedeutung von *vərəθra-* wäre folglich „Sieg durch Defensivkraft“.

In Yt 14 ist dieser semantische Wandel darum doppelt eigentümlich, als die beschriebenen Defensivwaffen, d.h. die ‚Rüstungen‘, quasi imaginierte, magische, vortechnologische sind. Folglich wären zwei Zeitebenen in Yt 14 überblendet: Eine archaische Zeitebene, auf der die ‚Rüstung‘ des Körpers lediglich von Zauberpraktiken und weitgehend ‚natürlichen‘ magischen Gegenständen abhing, und eine technologisch fortgeschrittene Zeitebene, die jener von V 14 (oder auch Yt 13.45) entspricht.

Solche Gleichzeitigkeit des Ungleichzeitigen begegnet auch im ŠN (s. N. 45) in anderer antiker sowie

51. Carter 1995, 124 mit Lit. Seit parthischer Zeit machen bis ins 20. Jh. die Vogelzeichen die wohl häufigsten Verzierungen iranischer Kronen aus (s. Calmeyer/Peck/Shahbazi/Dokā’ 1993, bes. 410, 415, 417, 418, 421-422 (Seljuken; Sogdien; Buyiden), 424-426.

52. Wahrām II kennt auch eine Eberkopfhaube (s. Göbl 1968, 7). Diese wird vor allem von der Königin und dem Kronprinzen getragen, wobei der Eber „gelegentlich dem Kopf eines Sēnmurw ähnelt“ (Göbl 1968, 44). Bezüglich Šābūhr II (309-79) berichtet Ammianus Marcellinus 19.1.3, daß dieser eine diamantenbesetzte, goldene Figur eines Widderkopfes, was vielleicht als ein Verweis auf *Vərəθraγnas* achte Gestaltung zu verstehen ist.

53. Hier ist der Vogel in voller Gestalt dargestellt, s. Shahbazi 1984, 316, 317; Carter 1995, 129.

54. Siehe Colpe 1986, 232, gemäß Göbl 1968, 9 & Abb. 48-72. In achämenidischer Zeit findet sich die Verbindung des Großkönigs mit der Falkengestalt in seiner Funktion als ägyptischer Pharao (Sternberg-el Hotabi 2009). Sternberg-el Hotabi 2009, 403, schreibt: „Ikonographische Anknüpfungspunkte, Dareios in Falkengestalt zu verehren, gab den Persern sicherlich ihr höchster Gott Ahura Mazda, der selbst Falkenzüge aufwies.“ Eine solche Darstellung des Ahuramazdā (oder des Ahura Mazdā) ist m.W. nicht bekannt. Wenn die ägyptische Falkendarstellung des Dareios überhaupt ikonographische Bedeutung für die Perser besaß, dann wohl nur im Sinne einer *Vərəθraγna*-Darstellung.

55. Dhabhar 1923, 28.

56. Yt 14 nennt an Offensivwaffen Yt 14.27 ein „Messer mit Goldinlay“ (*karətəm. zaraniiō.saorəm.*).

57. Zur Bedeutung von Defensivwaffen für den Schlachtausgang s. Yt 13.26.

mittelalterlicher Literatur,<sup>58</sup> und letztlich stehen auch die achämenidischen Gemmen oder die parthischen Federn in diesem asynchronen Verhältnis. Im Falle von Yt 14 erwecken die geschilderten magischen Gegenstände bzw. ihre Behandlung im Vergleich zum westiranischen Rüstungs- ‚Schmuck‘ jedoch den Eindruck, als seien sie mehr als sublimierte Erinnerung, mehr als symbolischer Zierrat. Ihnen fällt die Aufgabe des Körperschutzes tatsächlich und ausschließlich zu. Die Zauberpraktiken in Yt 14 dürften darum einen Einblick in militärische ‚Kleidungspraktiken‘ (‚Rüstungen‘) geben, die wesentlich älter sind als die finale Komposition des *Yašt*.

#### *Anhang: Der priesterliche paiti.dāna*

Unter den priesterlichen „Ausrüstungsgegenständen“ in V 14.8 wird als einziges Kleidungsstück das *paiti.dāna*- „(Mund-)Vorsatz(-Tuch)“ erwähnt. Bis heute gehört das *paiti.dāna/padān* zu den Kennzeichen des zoroastrischen Priesters. Seine Existenz wird funktional begründet, es soll das Feuer vor dem unreinen Atem schützen.<sup>59</sup> Möglich (und nicht notwendig im Widerspruch zu der genannten Erklärung stehens) ist aber auch, daß sich das Vorsatztuch aus einer regionalen, auch die Priester betreffenden Bekleidungspraktik herleitet, bevor sich der Brauch dann über den gesamten (zoroastrischen) Iran ausgeweitet hat. Wie gesehen, tragen auch und noch im Avesta die Krieger *paiti.dānas*, und in Yt 5.123 trägt es auch (in Gold, wie bei Götten üblich) die Göttin Anāhitā. Im

Westen begegnen *paiti.dānas* bei einigen wenigen Völkerschaften auf den persepolitischen Reliefs der Apadāna (Thronhalle), und zwar bei den Gesandtschaften der Meder, Areier und Arachosier. Bemerkenswert ist nun, daß es wiederum allein Meder und Areier (oder Arachosier) zu sein scheinen, die auf einer ganz bestimmten Reliefgruppe in Persepolis abgebildet sind. Es handelt sich dabei um jene Reliefs, die vom nördlichen, öffentlichen Sektor (am Tripylon) den Weg zum südlichen, privaten Sektor flankieren, und schließlich zu den sog. Königspalästen geleiten. Diese Meder und Areier/Arachosier tragen Schafe, Geschirr, Flüssigkeiten. Angesichts der Tatsache, daß auf den Reliefs der Terrasse von Persepolis, die man doch immer wieder mit dem Vollzug von großen Riten (Neujahrsfest) in Verbindung gebracht hat, rituelle Szenen fehlen, scheint es plausibel, jene Träger als Opferpriester zu identifizieren.<sup>60</sup> Mit ihrer Prozessionsszene lassen sich zwei Bilder im *Vīdēvdād* vergleichen. In V 5.39 wird von einer Prozession vermutlich von Priestern berichtet: „In dieser knochenversehene Welt tragen wir (die Priester [?]), o *aš*versehener Ahura Mazda, das Feuer, das *barəsmān*, die Tassen, den *haoma* und das Preßgerät“ (*yōi. nmānā. hqm.barāmahi. ašāum. ahura. mazda. ahmi. aḡhuuō. yaṭ. astuuaiṅti. ātrəmca. barəsmaca. taštaca. haomaca. hāuuanaca.*). Ein ähnliches Bild zeichnet V 3.1, jedoch ohne Nennung des Feuers,<sup>61</sup> das sich schon am Ritualort zu befinden scheint: „Wo wahrlich der *aš*versehene Mann ‚voranschreitet‘ (in Prozession?), o Spitamā Zaraθuštra, Brennholz in der

58. In der dritten *Auventure* des *Nibelungenlied* redet der Text von „lichten bruneie ... veste helmen ... schilde schoene vnde breit“ (Hs. A, *Auventure* 3, Str. 67 c-d), zugleich aber heißt es über Siegfried, er „badete sich in dem (lintrachen) bluote, sin huot wart hurnin“ (Hs. A, *Auventure* 3, Str. 101). Bisweilen treffen beide Entwicklungsstufen aufeinander: Quintus Curtius 10.7.16-26 erzählt die Geschichte des *pugil nobilis* Dioxippus, der nackt und mit einer Keule bewaffnet gegen einen gerüsteten Makedonen kämpft, zum allgemeinen Erstaunen, *quippe armato congregi nudum dementia, non temeritas videbatur* „denn für einen Nackten schien es nicht nur Unbedachtheit, sondern Wahnsinn, mit einem Bewaffneten zu kämpfen“.

59. Strabo 15.3.14 sagt, daß das Anblasen des Opferfeuers (der Text bezieht sich auf das sog. *Ātaš Zōhr* [Y 62]) verboten war: διαφερόντως δὲ τῷ πυρὶ καὶ τῷ ὕδατι θύουσι, τῷ μὲν πυρὶ, προστιθέντες ξηρὰ ξύλα τοῦ λέπους χωρὶς πιμελῆν ἐπιτιθέντες ἄνωθεν: εἶθ' ὑφάπτουσιν ἔλαιον καταχέοντες, οὐ φυσῶντες ἀλλὰ ῥιπίζοντες: τοὺς δὲ φυσησαντας ἢ νεκρὸν ἐπὶ πῦρ θέντας ἢ βόλβιτον θανατοῦσι „Vorzugsweise opfern sie dem Feuer und dem Wasser; dem Feuer, indem sie trockene Holzscheite ohne Rinde anlegen und oben darauf Fett (πιμελῆν). Dann gießen sie Öl darüber und zünden sie an, jedoch nicht anblasend, sondern fächelnd. Wer das Feuer anbläst, oder etwas Totes oder Kot hineinwirft, wird getötet.“ (Übersetzung Forbiger)

60. Vgl. Razmjou 2005, 152.

61. Ob das Feuer unter den getragenen Gegenständen sich befindet, ist unklar. Die Wendung *hqm.bar- ātrəmca. barəsmaca. ...* „Feuer und *barəsmān* etc. zusammenbringen“ erzwingt diese Interpretation nicht (V 5.39 könnte auch eine metonymische Formulierung sein, vgl. V 5.39 „a) das Feuer, b) das *barəsmān*, c) die Schalen, d) *haoma* und Preßgerät“ und V 3.1/Y 62.1 „a) Brennholz in der Hand, b) das *barəsmān* in der Hand, c) Milch/Fleisch in der Hand, d) das Preßgerät in der Hand“.

Hand, das *barəsmān* in der Hand, Milch/Fleisch in der Hand, das Preßgerät in der Hand, Worte aufsagend im Einklang mit der *daēnā*, bittend den weite Fluren besitzenden Miθra und den gute Weiden habenden Rāman“ (*yaŋ. bā. paiti. nā. ašauua. fraiiaŋ. spitama. zaraθuštra. aēsmō.zastō. barəsmō.zastō. gao.zastō. hāuuanō.zastō. āxštaēda. daēnaiia. vacō. framrū. miθrəmca. vouru.gaoiiaoitīm. jaiδiiq. rāmaca. x’āstrəm.*). Die Komposita *aēsmō.zastō. barəsmō.zastō. gao.zastō. hāuuanō.zastō.* „Brennholz in der Hand, das *barəsmān* in der Hand, Milch/Fleisch in der Hand, das Preßgerät in der Hand“ begegnen auch in Y 62.1 (= Ny 5.7), wo sie offenbar die für die „Libation an das Feuer“ (*Ātaš Zōhr*) benötigten Ritualgegenstände beschreiben.<sup>62</sup>

### Abkürzungen

aav.	altavestisch
ai.	altindisch
ap.	altpersisch
arm.	armenisch
av.	avestisch
jav.	jungavestisch
LW	Lehnwort
mmp.	manichäisch-mittelpersisch
mp.	mittelpersisch
np.	neupersisch
oss.	ossetisch
parth.	parthisch
sem.	semitisch
syr.	syrisch
→	Übersetzung (aus dem Avesta)
AiW	Altiranisches Wörterbuch (= Bartholomae 1904)
EWA	Etymologisches Wörterbuch des Altindoarischen (= Mayrhofer 1992-2001)
Her.	Herodot
N	Nērangestān
NpÜ	Neupersische Übersetzung (des Avesta)

PÜ	Mittelpersische Übersetzung (des Avesta)
ŠN	Šāhnāme
V	Vīdēvdād
Y	Yasna
Yt	Yašt
ZWY	Zand ī Wahman Yasn
ArOr	Archiv Orientalni
BSEI	Boletín de la Sociedad Española de Iranología
IJJ	Indo Iranian Journal
JA	Journal Asiatique
JAOS	Journal of the American Oriental Society
KZ	Zeitschrift für vergleichende Sprachforschung (Kuhns Zeitschrift)
MSS	Münchener Studien zur Sprachwissenschaft
ZDMG	Zeitschrift der Deutschen Morgenländischen Gesellschaft

### Bibliography

- Bailey, H. W. (1954) *Ariana*. In *Donum natalicium H. S. Nyberg oblatum*, 1-16. Uppsala.
- Bailey, H. W. (1979) *Dictionary of Khotan Saka*. Cambridge.
- Bartholomae, Chr. (1904) *Altiranisches Wörterbuch*. Straßburg.
- Benveniste, E. & Renou, L. (1934) *Vrtra et Vrθragna. Étude de Mythologie indo-iranienne*. Paris.
- Bloomfield, M. (1897) *Hymns of the Atharva-Veda. With extracts from the Ritual Books and the commentaries*. Oxford.
- Bowman, R.A. (1970) *Aramaic Ritual Texts from Persepolis*. Chicago.
- Boyce, M. (1975) *A history of Zoroastrianism. Vol. 1. The early Period*. Leiden-Köln.
- Callieri, P. (2001) *In the Land of the Magi. Demons and Magic in the Everyday Life of Pre-Islamic Iran*. In R. Gyselen (ed.), *Démons et merveilles d’Orient*, 11-36. *Res Orientales XIII*. Bures-sur-Yvette.
- Calmeyer, P. et al. (1993): *Crown*. In: *Encyclopædia Iranica* 6, 407-426.

62. Zu den vielen aramäisch beschriebenen Mörsern, Stößeln und Schalen, die man in der Schatzkammer der Terrasse gefunden hat, und die möglicherweise von einer Preßzeremonie (*prkn*) berichten (vermutlich *haoma*-Zeremonie), s. Bowman 1970; kritischer Levine 1972. Zu Siegelbildern aus Persepolis, die Ritualszenen abbilden (auch *haoma*-Opfer?), s. Schmidt 1957, Pl. 7.

- Cantera, A. (1999) Av. *ayuriia-* und *siyuriia-*: Zu einem umstrittenen Lautgesetz im Jungawestischen, *MSS* 59, 39-50.
- Cantera, A. (2010) Rituales, manuscritos y ediciones del Avesta: Hacia una nueva edición de los textos avésticos de la liturgia larga, *BSEI* 1, 28-42.
- Carter, M. L. (1995) Aspects of the Imagery of Verethragna: The Kushan Empire and Buddhist Central Asia. In B.G. Fragner (ed.), *Proceedings of the Second European Conference of Iranian Studies*, 119-140. Roma.
- Cheung, J. (2007) *Etymological Dictionary of the Iranian Verb*. Leiden-London.
- Clemen, C. (1920) *Die Griechischen und Lateinischen Nachrichten über die Persische Religion*. Giessen.
- Colpe, C. (1986) Altiranische und zoroastrische Mythologie. In H. W. Haussig (ed.), *Wörterbuch der Mythologie*. Bd. IV: *Götter und Mythen der kaukasischen und iranischen Völker*. Unter Mitarbeit von C. Colpe, G. Dumézil, J. Elfenbein, K. Ishkol-Kerovpian, S. 161-48. Stuttgart.
- Darmesteter, J. (1892-1893) *Le Zend-Avesta. Traduction nouvelle avec commentaire historique et philologique*. 3 Vols. Paris.
- Dhabhar, E. B. N. (1923) *Descriptive Catalogue of all manuscripts in the first Dastur Meherji Rana Library, Navsari*. Bombay.
- Dhabhar, E.B.N. (1963) *Translation of Zand-i Khūrtak Avistāk*. Bombay.
- Duchesne-Guillemin, J. (1937-1939) Etymologies Avestiques. *BSOS* 9, 861-869.
- Flattery, D.S. & Schwartz, M. (1989) *Haoma and Harmaline. The Botanical Identity of the Indo-Iranian Sacred Hallucinogen „Soma“ and its Legacy in Religion, Language, and Middle Eastern Folklore*. Berkeley/Los Angeles-London.
- Friš, O. (1951) The Avestan Studies, *ArOr* 19, 492-513.
- Geldner, K. Fr. (1884) *Drei Yasht aus dem Zendavesta*. Stuttgart.
- Geldner, K. F. (1951) *Der Rig-Veda aus dem Sanskrit ins Deutsche übersetzt und mit einem laufenden Kommentar versehen*. 3 Bde. Cambridge/Mass.
- Gnoli, Gh. (1989) Bahrām. i. In Old and Middle Iranian Texts. In *Encyclopædia Iranica* 3, 510-513.
- Göbl, R. (1968) *Sasanidische Numismatik*. Braunschweig.
- Grassmann, H. (1873) *Wörterbuch zum Rig-Veda*. Leipzig.
- Jackson, A. V. W. (1906) *Persia, Past and Present*. London.
- Junker, H. F. J. & Tavadia, J. (1959) *Der wissbegierige Sohn. Ein mittelpersischer Text über das Kustik*. Leipzig.
- Hintze, A. (1994) *Der Zamyād-Yašt. Edition, Übersetzung, Kommentar*. Wiesbaden.
- Hübschmann, H. (1882) Zu Geldner's Übersetzungen aus dem Avesta, *Zeitschrift für vergleichende Sprachforschung (KZ)* 27, 92-103.
- Humbach, H. (1976) Das awestische Federorakel. In: *Yādegārnāme-ye Pūrdāvūd (Miscellanea in Honorem Ibrahim Purdavud)* [= Farhang-i Īrān-zamīn 21], 58-63. Tehran.
- Humbach, H. & Ichaporia, P. (1998) *Zamyād Yasht. Yasht 19 of the Younger Avesta. Text, Translation, Commentary*. Wiesbaden.
- Kellens, J. (1974) *Les noms-racines de l'Avesta*. Wiesbaden.
- Kellens, J. (1975) Sur la transmission des Yašts, *MSS* 33, 61-66.
- Kellens, J. (1984) *Le verbe avestique*. Wiesbaden.
- Koch, H. (2001) *Persepolis. Glänzende Hauptstadt des Perserreichs*. Mainz.
- König, G. (2012) Das Nask *Bayān* und das *Xorde Avesta*. In A. Cantera (ed.) *The Transmission of the Avesta*, 355-394. Wiesbaden.
- Kreyenbroek, Ph. G. (2004) Ritual and Rituals in the Nērangestān. In M. Stausberg (ed.) *Zoroastrian Ritual in Context. Studies in the History of Religions*, 317-331. Leiden.
- Kreyenbroek, Ph. (2008) The Term Bâgân Yasn and the Function of the Yashts in the Zoroastrian Ritual. In: M. Jaafari-Dehaghi (ed.) *One for the Earth: Prof. Dr. Mahyar Nawabi, Memorial Volume.*, 81-94. Tehran.
- Kuiper, F. B. J. (1970) R. Gordon Wasson, Soma, Divine Mushroom of Immortality, *IJJ* 12, 279-285.
- Levine, B. A. (1972) Aramaic ritual texts from Persepolis, *JAOS* 92, 70-79.
- Lommel, H. (1927) *Die Yāšt's des Avesta. Übersetzt und eingeleitet. Mit Namenliste und Sachverzeichnis*. Göttingen-Leipzig.
- Malandra, W. W. (1973) A Glossary of Terms for Weapons and Armor in Old Iranian, *IJJ* 1973, 264-289.
- Malandra, W. W. (1979) Atharvaveda 2.27: Evidence for a Soma-Amulet, *JAOS* 99, 220-224.
- Malandra, W. W. (1983) *An Introduction to the Ancient Iranian Religion. Readings from the Avesta and Achaemenid Inscriptions*. Minneapolis.
- Mayrhofer, M. (1992-2001) *Etymologisches Wörterbuch des Altindoarischen*. 3 Bde. Heidelberg.
- Modi, J. J. (1894) Charms or Amulets for Some Diseases of the Eye, *Journal of the Anthropological Society of*

- Bombay* 3, 338-345. (Repr.: Modi, J. J. (1911) *Anthropological Papers* I, 43-50. Bombay.)
- Modi, J.J. (1900a) Nirang-i-Jashan-i-Burzigarān. A Religious Formula Used as a Charm on the Festival of the Cultivators (the Fifth Day of the Current Parsee Month, Spendārmad, i.e., 15<sup>th</sup> August 1900). In: *Journal of the Anthropological Society of Bombay* 5, 398-405. (Repr.: Modi, J. J. (1911) *Anthropological Papers* I, 122-130. Bombay).
- Modi, J. J. (1900b): An Avesta Amulet for Contracting Friendship, *Journal of the Anthropological Society of Bombay* 5, 418-425. (Repr.: Modi, J. J. (1911) *Anthropological Papers* I, 131-139. Bombay).
- Modi, J.J. (1924) A few Parsee Nīrangs (Incantations or Religious Formulæ). In: *Anthropological Papers III. Papers Read before the Anthropological Society*, S. 52–71. Bombay.
- Mosig-Walburg, K. (1982) *Die frühen sasanidischen Könige als Vertreter und Förderer der zarathustrischen Religion. Eine Untersuchung der zeitgenössischen Quellen*. Frankfurt a. M./Bern.
- Oldenberg, H. (1923) *Die Religion des Veda*. Stuttgart.
- Pirart, E. (1999) Les métamorphoses de Vṛthragna, *JA* 287.2, 465-522.
- Razmjou, Sh. (2005) Religion and Burial Customs. In J. Curtis & N. Tallis (eds.) *Forgotten Empire. The World of Ancient Persia*. 150-156 (180). London.
- Rehasek, E. (1882) Orientalische Rüstungsstücke, *ZDMG* 36, 655-658 + 1 Pl.
- Rehm, E. (1992) *Der Schmuck der Achämeniden*. Münster.
- Schmidt, E. F. (1957) *Persepolis II: Contents of the Treasury and Other Discoveries*. Chicago.
- Shahbazi, A. Sh. (1984) On *vārəγna*- the Royal Falcon, *ZDMG* 134, 314-317.
- Sternberg-el Hotabi, H. (2009) 'Der Gute Gott, Herr der Beiden Länder, Dareios': Bemerkungen zur Stele Berlin ÄS 7493. In Chr. Allison, A. Joisten-Pruschke & A. Wendtland (eds.) *From Daēnā to Dīn. Religion, Kultur und Sprache in der iranischen Welt. Festschrift für Philip Kreyenbroek zum 60. Geburtstag.*, 399-407. Wiesbaden.
- Stricker, B. H. (1964) Vārəgna, the falcon, *IJJ* 7, 310-317.
- de Vaan, M. (2003) *The Avestan Vowels*. Amsterdam-New York.
- Vanden Berghe, L. & Schippmann, Kl. (1985) *Les Reliefs Rupestre d'Elymaïde (Irān) de l'Epoque Parthe*. Gent.
- Widengren, G. (1965) *Die Religionen Irans*. Stuttgart.
- Widengren, G. (1969) *Der Feudalismus im alten Iran. Männerbund – Gefolgswesen – Feudalismus in der iranischen Gesellschaft im Hinblick auf die indogermanischen Verhältnisse*. Köln-Opladen.

## Sasanian Exegesis of Avestan Textile Terms

Miguel Ángel Andrés-Toledo

**T**he Zoroastrian religion, taking its name from the prophet Zoroaster, Greek version of the Avestan name *Zaraθuštra*, developed in South and Central Asia out of the Indo-Iranian religious practices going back to the 2<sup>nd</sup> millennium BC, and is one of the few ancient Indo-European religions that still survive, concretely in some communities in Iran, India and the diaspora. The most ancient Zoroastrian sacred texts, commonly designated as the Avesta, were orally composed and transmitted during the 2<sup>nd</sup> and 1<sup>st</sup> millennia BC in the most archaic Iranian language preserved, known as Avestan, until they were eventually put down to writing in manuscripts going back to the beginning of the 2<sup>nd</sup> millennium AD. The difficulties of understanding this language, no longer spoken but still needed for the ritual recitations, motivated that several priests rendered the Avestan texts into Pahlavi, the Middle Iranian language of the Sasanian dynasty (AD 224 - 651), from which they were eventually translated into New Persian in Iran, and into Sanskrit and Gujarati in India.

Although Avestan was and still is used by Zoroastrians for ritual purposes, it was no longer a living language since the 1<sup>st</sup> millennium AD, when Middle Iranian languages had already emerged from the linguistic pool of the ancient period. Of these Middle Iranian languages, Pahlavi acquired special relevance, insofar as it was the language spoken by the Sasanian kings, under the rule of which Zoroastrianism was the main state religion. Pahlavi was spoken in the Southwestern Iranian province of Fārs after the fall of the Achaemenid Empire in BC 330, during which Old Persian was the language of the ruling class, and before the first written documents in New Persian or Fārsi, dating back to the 8<sup>th</sup> century AD.<sup>1</sup> Since the Sasanian kings, whose creed was Zoroastrian, established the center of their political power in Fārs, this province became a stronghold for Zoroastrianism, and Pahlavi, the language spoken there and used by the Sasanian administration, also became the language of culture for most of the Zoroastrian communities. Indeed, some centuries after Iran was conquered by

1. The most recent descriptions of the Middle Persian language and writing systems are found in Sundermann 1989 and Skjærvø 2009. According to Lazard 1963, 31, the first preserved texts written in New Persian would be the fragmentary inscriptions in Hebrew alphabet found in Afghanistan and dating back to AD 752-753.



the Muslims, Pahlavi was still in use as one of the sacred languages of these religious communities but also for literary compositions, being brief texts composed in Pahlavi by Zoroastrian priests as late as the 19<sup>th</sup> century AD.

The exegetical schools of Pahlavi-speaking priests during the Sasanian period rendered into their vernacular language most of the Avestan texts that had reached to them, and provided their Pahlavi translations with several commentaries, which reflected the different interpretations of the Avestan texts by the leading priests of each school. When rendering the Avestan texts into Pahlavi, these priests applied diverse techniques, but they mostly tried to accurately reproduce the Avestan originals by means of word-for-word literal translations that mirrored the Avestan syntax.<sup>2</sup> Nevertheless, they sometimes deviated from their models when challenged by terms no longer understood, or customs and regulations that had changed in their contemporary society. How the Pahlavi translators and commentators tried to bridge the exegetical gap between the Avestan and Pahlavi languages and contexts highly determined their (and subsequently our) understanding of the Avestan and Pahlavi texts. In this paper I will show by some examples how this problem affects our interpretation of Avestan textile terms and their Pahlavi translations.

Avestan textile terms were rendered into Pahlavi by means of the following different techniques:

1. As loanwords.
2. By etymological translations based on phonetic similarity.
3. By synonymic translations.
4. By another word from the same semantic field.
5. By reinterpretations.

Avestan technical terms and words no longer understood were sometimes incorporated into Pahlavi as loanwords. This is the case, for instance, of Av. *aḍka-* / *aṭka-* “mantle, cloak,”<sup>3</sup> rendered into Phl. *adag* <’tk’> in N 74.2:<sup>4</sup>

Av. *aḍkā-sca*.<sup>5</sup> *frazušō. varjhasca.*  
+*upasmaēni*.<sup>6</sup>

pleasing<sup>7</sup> cloaks and garments made of  
land animals,

Phl. [PWN ’w’ zwt’n’ t’pyt’] ’tk’-c<sup>8</sup>  
<y> pr’c<sup>9</sup> hw’stk’ kp’h-HD [’y’ ywt’k]  
QDM nyh’n’-c [y’+KZY<sup>9</sup> lwtk HWE-  
t AMT mwd <y> +’ywt’k<sup>10</sup> QDM ZK y  
'nd gyw’k ’ytwn’ YHWWN-yt’ cygwn  
gwn’k HWE-yh

[*pad ō zōtān tābīd*] *adag-iz* <ī> *frāz*  
*xwāstag kabāh-ē* [*ay ēw-tāg*] <ī> *abar*  
*nihān-iz* [*ī’+ahy rūdag hād ka mōy* <ī>  
+*ēw-tāg abar ān ī and gyāg ēdōn bawēd*  
*cīyōn gōnāg hē*]

[spun for the *zōt* (priests)] and pleasing  
cloaks (or) an overcoat [that is, in  
one piece] that is also hidden [of the first  
shearing, that is, when the hair (is) in one  
piece over that much place, it is as if it  
were dyed]

The fact that Phl. *adag* has no other parallel out of the Pahlavi translation of the preceding passage and is not continued in New Persian indicates that it has to be taken as a loanword, which translated a term scarcely attested in Avestan and probably unknown to the Pahlavi translators.

2. See Cantera 2004, 240-328. On the techniques of the Pahlavi translators see also Josephson 1997 and Buyaner 2010.

3. Attested in Yt 5.126, N 74.2 (Bartholomae 1904, 61). cf. Ved. *átka-* “mantle” (Mayrhofer 1992-2001, 1.58; Andrés-Toledo 2010, 439).

4. All the Avestan and Pahlavi texts quoted are edited by me according to the oldest manuscripts preserved of each text, the different readings of which I include as footnotes. The English translations are also mine.

5. HJ *aṭ.kā-sca*.

6. HJ *uparsmanāi*.

7. Regarding Av. *frazuš-* “pleasing,” see Kellens 1974, 86.

8. HJ y add.

9. HJ KZY-yh.

10. HJ t’k.

The second technique, based on phonetic similarity but perhaps also on a basic etymological knowledge, finds some good examples in the Pahlavi translations of Av. *vastra-*, *drafša-* and *barəziš-*. The first,<sup>11</sup> generally applied to clothing and derived from the Proto-Indo-European root \**ues-* “to wear,”<sup>12</sup> was systematically rendered into Phl. *wastarag*, also a general term for clothing derived from the same Proto-Indo-European root. Although the Pahlavi translators could have chosen other synonyms for clothing like Phl. *jāmag* and *paymōg*, they preferred to render Av. *vastra-* into its etymological and phonetically related equivalent in Phl. *wastarag*. The same applies to Av. *drafša-* “standard, banner,”<sup>13</sup> rendered into Phl. *drafš* “banner,” both deriving from Proto-Indo-European \**drep-* “to cut off,”<sup>14</sup> and to Av. *barəziš-* “cushion,”<sup>15</sup> systematically rendered into Phl. *bāliš* “cushion,” both deriving from the same Proto-Indo-European root \**b<sup>h</sup>elǵh-* “to swell.”<sup>16</sup> Phl. *drafš* and *bāliš* are also attested in other passages apart from the Pahlavi translations and continue as NP. *derafš* and *bāliš* respectively with the same meaning as in Pahlavi.

Etymological Pahlavi translations also help correctly interpreting Avestan textile terms, as demonstrated by the Pahlavi translation of Av. *naḍa-* in N 77.4:

Av. +*yōi*.<sup>17</sup> +*vaṇhənti*.<sup>18</sup> *naḍəśca*.  
+*sāḍaiiantīšca*.<sup>19</sup> *carəmaṇca*. +*hiku*.<sup>20</sup>

11. Attested in Y 10.20, 55.2, V 3.18-19, 4.46, 5.38, 5.49, 5.54-58, 6.27, 7.11-13, 7.17-18, 7.64, 7.69, 8.23-25, 9.32-35, 9.49, 12.2, 12.4, 12.6, 12.8, 12.10, 12.12, 12.14, 12.16, 12.18, 12.20, 12.22, 16.16, 17.3, 18.19, 18.21, VN 13, N 68.1, 69.2, 73.3, 75.1, 78.2, Yt 5.129, 10.126, 14.61, 17.14, 19.56, 19.59, 19.62, Vyt 7.45, ViD 2, 12 and 20 (Bartholomae 1904, 1385).

12. Present, for instance, in Ved. *vāstra-*, Gr. *heimata* and Lat. *vestis* (Mayrhofer 1992-2001, 2.529).

13. Attested in Y 10.14a, 57.25d, Yt 1.11, 4.3, 8.56, 10.93, 13.136 and 14.48 (Bartholomae 1904, 771-772), and rendered into Phl. *drafš* <dlpš> in Y 10.14a and 57.25d.

14. Present, for instance, in Ved. *drāpi-* “mantel, cloak” and Gr. *drépō* “I cut off” (Mayrhofer 1992-2001, 1.758).

15. Attested in V 5.27b, 5.59c, 7.8e, 7.9, 14.14d and 18.26a (Bartholomae 1904, 950). This word was also identified in the Avestan compound Av. *x<sup>w</sup>ābarəziš-* “own cushion” (Bartholomae 1904, 1878), rendered into Phl. *xwad-bāliš* <BNPŠE b’lš’> in V 6.51. Phl. *bāliš(n)* <b’lš(n)> was wrongly written <w’lš(n)> in the manuscript L4 (f. 247r, l. 11) in V 18.26.

16. cf. Ved. *barhiṣ-* “grass bedding spread for the offerings” (Mayrhofer 1992-2001, 2.213-214).

17. HJ *yō*.

18. HJ *vaṇhaiti*.

19. HJ *sāḍaiiantīšca*.

20. HJ *huki*.

21. HJ *hwmb’ynd*.

22. HJ *dyyw’k-HD* **دځو ک**.

23. HJ *lyp’*.

24. Mayrhofer 1992-2001, 2.7.

Who wear reeds, *sāḍaiiantī-* and dry furs

Phl. OLE-š’ n’ MNW +*nhwmb’ynd*<sup>21</sup>  
KNYA W +*dyp’k-HD*<sup>22</sup> [krc] <W>  
+*clm*<sup>23</sup> y *hwšk*

*awēšān kē +nihumbēnd nāy ud +dēbāg-ē*  
[karz] <ud> +*carm ī hušk*

Those who wear reeds, a [silk] brocade  
(and) dry furs

Insofar as Av. *naḍa-* is the object of the verb *vah-* “to wear,” it is very likely that it designates a sort of clothing, “Name eines Kleidungsstücks” according to Bartholomae 1904, 1038. Waag 1941, 137 and 140, followed by Kotwal & Kreyenbroek 2009, 48-51, went a step further and proposed a highly hypothetical translation as “cap.” Av. *naḍa-* is actually related to Ved. *nadā-* and *naḍā-* “cane, reed,”<sup>24</sup> and was rightly understood by the Pahlavi translators, who rendered it into Phl. *nāy* “reed,” being impossible to know what kind of clothing made of reeds (or similar vegetal fibres) the Avestan term *naḍa-* referred to.

Some examples of the third technique, the synonymic translation, also reveal the Pahlavi translators’ skills to rightly interpreting and translating Avestan words, and are the key to correctly editing them. This is the case of Av. *aoḍrauuan-* “footwear,” attested in V 8.23a and N 68.2:

V 8.23a. Av. |a| *dātarə. gaēθanqm.*  
*astuuaitinqm. ašāum. yō. vastrəm.*  
*uparharəzaiti. upairi. aētəm. iristəm.*  
*ubdaēnəm. vā. izaēnəm. vā. auuuauaṭ.*  
*aipi. yaθa. narš. aoθrauuana.* |b| *kā. hē.*  
*asti. ciθa.* |c| *āaṭ. mraoṭ. ahurō. mazdā.*  
*caθβārō. sata. upāzananqm. upāzōiṭ. as-*  
*pahe. aštraia. caθβārō. sata. sraošō.*  
*caranaiia.*

|a| Maker of the material creatures, Righteous one, whoever casts clothes upon this dead, woven or made of goat's (leather), in as much as man's footwear, |b| what is the atonement for it? |c| And Ahura Mazda said: "four hundred lashes with the horse's whip one must decree (for him), four hundred with the Sraoša's lash."

Phl. |a| d't'l MNW wstlg QDM  
 ŠBKWN-yt' QDM 'w' ZK lyst' ttk  
 'ywp pwstyn' ZK y 'nd cnd GBRA  
 +LGLP-p'nk |b| kt'l OLE AYT' twcšn'  
 |c| AP-š gwpt 'whrmzd AYK 400 PWN  
 QDM znšnyh QDM znšn' 'sp' 'štl 400  
 slwšcln'm

|a| *dādār kē wastarag abar hilēd abar ō*  
*ān rist tadag ayāb pōstēn ān ī and cand*  
*mard +pāybānag* |b| *kadār ōy ast tōzišn* |c|  
*u-š guft ohrmazd kū cahār sad pad abar*  
*zanišnīh abar zanišn asp aštar čahār sad*  
*srōšōcarnām*

|a| Maker, whoever casts clothes upon the dead, spun or leathern, in as much as man's footwear, |b| what is the atonement for it? |c| And Ahura Mazda said: "one

must beat him with four hundred lashes of the horse's whip, four hundred of the Sraoša's lash."

N 68.2. Av. *yaθa. +aoθrauuano.*<sup>25</sup> *biš.*  
*paiti.*<sup>26</sup> *maidiiōi. +paitištāne.*<sup>27</sup>

When wearing footwear, twice to the middle of the leg<sup>28</sup>

Phl. cnd 2<sup>29</sup> p'dyp'nk<sup>30</sup> [GBRA<sup>31</sup> pr'c  
 hwmbyt'] OD OL nymk +ptyšt'n<sup>32</sup>  
*cand dō pāybānag [mard frāz humbēd]*  
*tā ō nēmag +padištān*

As much as [a man wears] two footwear, to the middle of the leg

In the first passage Av. *aoθrauuana-* is written as *aoθrauuana* in the Iranian manuscripts 4000, 4045, 4050 and 4055. In the passage of the Nērangestān, *āθrauuano* (with *ā-* instead of the diphthong *ao-*) is the common variant of the manuscripts TD and HJ, the oldest preserving this text. Ch. Bartholomae 1900, 125-127 and 1904, 323 preferred the latter variant and translated it as "Strumpf," following its Pahlavi translation *pāybānag* "protecting the feet," but did not explain it etymologically. Kotwal & Kreyenbroek 2009, 31 also edited Bartholomae's form *āθrauuano* and translated it as "stockings," but they were also unable to explain its etymology. Thanks to the Pahlavi translation *pāybānag* "protecting the feet" we can confirm that the variant *aoθrauuana* of V 8.23a is the right one, and that *āθrauuano* of N 68.2 is merely a corrupted form out of the former, probably introduced during the written transmission by contamination of the usual word for priest in Avestan: *āθrauuana-*. That Av. *aoθrauuana-* "having shoes," a noun deriving from *aoθra-* "shoe"<sup>33</sup> and going back to

25. TD HJ *āθrauuano*.

26. TD HJ *pai.i. biš*.

27. TD *paitištāno*; HJ *paiti.štāno*.

28. That is, the sacred girdle can reach up to the middle of the leg in both legs.

29. TD y 1.

30. TD p'dyp'n'.

31. HJ GRRA.

32. TD HJ *ptyšt'n'*.

33. Attested in Yt 5.64, 78 and V 6.27.

Proto-Indo-European \**h<sub>2</sub>eu-* “to weave,”<sup>34</sup> was identified and rightly translated by the Pahlavi translators is just another proof of their competence.

In other instances the Pahlavi translators did not choose a Pahlavi synonym of the Avestan textile term, but another word from the same semantic field. This is the case of the Pahlavi translations of Av. *ubdaēni*-<sup>35</sup> and *ubdaēna*-<sup>36</sup> “woven, made of textile,” rendered into Phl. *tadag* <ttk> “spun.” Although the Avestan verbal root *vaf-* “to weave,”<sup>37</sup> from which the preceding Avestan adjectives are formed, also existed in Pahlavi as *waf-* “to weave,” the Pahlavi translators preferred the verbal root *tadan*, *tan-* “to spin,” from which *tadag* “spun” derives, to render these adjectives into Pahlavi. Although spinning is certainly not the same as weaving, the Pahlavi translators simply picked up another term from the common semantic field of verbal roots related to textile production.

Finally there are also examples in which the Pahlavi translators reinterpreted the Avestan terms, either because they did no longer understand them or because they were trying to update them to make them fit into their own contemporary context. This is the case, for instance, of the *hápax legómenon* Av. *sādaiaiantī-* in N 77.4, rendered into Phl. *dēbāg-ē* [*karz*] “a [silk] brocade.” Although Bartholomae 1904, 1570 was again very cautious and just identified this Avestan word as a sort of clothing, “Name eines Kleidungsstücks,” A. Waag 1941, 137 and 140, followed by Kotwal & Kreyenbroek 2009, 48-51, was more imaginative and translated it as “Hose,” that is, trousers. Actually, the only thing we can guess from this word is that it derives from Ilr. \**scad-* “to cover,”

present in Ved. *chad-* “to cover,”<sup>38</sup> and that it would designate something covering the body. Although several Iranian words related to clothing and outfit, like Phl. *cādur* “sheet, veil” (actually a loanword from Late Sanskrit), its New Persian form *cādor* “veil” and Paštō *psōl* “necklace, belt,”<sup>39</sup> go back to this Indo-Iranian root, it is not possible to precise the meaning of Av. *sādaiaiantī-*, which therefore remains unknown. Many centuries ago the Pahlavi translators of the Sasanian period were challenged by the same problem, which they solved by choosing the contemporary terms *dēbāg-ē* [*karz*] “a [silk] brocade” for translating this Avestan *hápax legómenon*. The reason for this choice might be found in a parallel passage of N 73.1, in which another Avestan textile *hápax legómenon*, Av. *kərətī-*, is mentioned:

Av. <sup>+yōi.</sup><sup>40</sup> <sup>+vanhənti.</sup><sup>41</sup> *kərətīšca*.

(Those) who wear *kərətī-*

Phl. OLE-š' n' MNW <sup>+nhwmbynd</sup><sup>42</sup>  
ZK-cy klynytk' [cygwn twp <y> gy-  
tyg hm nmtk cygwn krc <sup>+dyp</sup>'k-HD<sup>43</sup>  
AYT' MNW 'ytwn' YMRRWN-yt' 'y  
HD MNW hm hdyb' l OL hm' mynyt'  
YKOYMWN-yt']

*awēšān kē* <sup>+nihumbēnd</sup> *ān-iz kīrrēnīdag*  
[*cīyōn tōf* <ī> *gētīg ham namadag cīyōn*  
*karz* <sup>+dēbāg-ē</sup> *ast kē ēdōn gōwēd ay ēw*  
*kē ham ayār ō ham menīd ēstēd*]

Those who wear the *kīrrēnīdag* (= cut)  
[like spun wool of flock together with  
felt;<sup>44</sup> like a silk brocade. There is (a

34. Mayrhofer 1992-2001, 1.754-755 and 1.758; Andrés-Toledo 2010, 439. Av. *aōθra-* is also the second element of the compound *x'ā.aōθra-* “having its own shoes,” attested in V 13.39 and VN 53, 62 (Bartholomae 1904, 1875).

35. Attested in V 7.15a.

36. Attested in V 8.23a, 8.24a and 8.25a.

37. Bartholomae 1904, 1346; Mayrhofer 1992-2001, 2.506; Andrés-Toledo 2010, 437-438.

38. Bartholomae 1904, 1570; Mayrhofer 1992-2001, 1.554-555.

39. Morgenstierne 2003, 60; Cheung 2007, 341-342.

40. HJ *yō*.

41. HJ *vanhənti*.

42. HJ HWE-d.

43. HJ *dypk*-HD.

44. cf. NP. *namad* “felt; a garment of coarse cloth; cloak worn during rain; a rug or coarse carpet on which people sit; a thick veil” and *namad dar bar* “with a coarse cloak or garment over the shoulders” (Steingass 1930, 1425-1426). Or maybe “wild plum” used as a dye; cf. NP. *namatk* “wild plum” (Steingass 1930, 1425).

commentator) who says: “all have agreed that (it is) one that helps for everything.”]

It is noteworthy that the Pahlavi translators of this passage were still able to identify that Av. *kərāti-* was related to the verbal root *\*kart-* “to cut,”<sup>45</sup> as their Pahlavi translation *kirrēnīdag* “cut” suggests. However, it seems that the exact meaning of both Av. *kərāti-* and Phl. *kirrēnīdag* was not clear enough to them, because they added a short explanation to it in Pahlavi, according to which this textile term was like a silk brocade. As we observe, the Pahlavi translators and commentators of N 77.4 and 73.1 reached the same conclusion when trying to identify the Avestan *hápax legómena sādaiiañtī-* and *kərāti-*, which according to them might have been silk brocades. Obviously none of these translators regarded whether or not these types of textiles were used by the Avestan-speaking population of South-western and Central Asia during the 2<sup>nd</sup> and 1<sup>st</sup> millennia BC, when the Avestan text of the Nērangestān was probably composed. They were simply interested in finding an equivalent in the Sasanian period for these ancient textile terms. The use of this technique, together with the rest they resorted to, demonstrates that the Pahlavi translations of Avestan texts, in spite of their many inaccuracies, were the product of learned and skilled translators who still were able not only to mechanically render one language into another, but also to reflect on the meanings of the very difficult texts they were confronting, and to provide the best possible contributions to their interpretation.

### Abbreviations

Av.	Avestan
Gr.	Greek
IIr.	Indo-Iranian
Lat.	Latin
N	Nērangestān
NP.	New Persian
Phl.	Pahlavi
V	Wīdēwdād
Ved.	Vedic
ViD	Wizargard ī dēnīg
VN	Vaēθā Nask
Vyt	Wištāsp Yašt
Y	Yasna
Yt	Yašt

45. Present for instance in Ved. *kart-* “to cut,” going back to Proto-Indo-European *\*(s)kert-* “to cut” (Mayrhofer 1992-2001, 1.315-316; Cheung 2007, 243-244).

**Bibliography**

- Andrés-Toledo, M. Á. (2010) Some Considerations about Vedic, Avestan and Indo-Iranian Textile Terminology. In C. Michel & M. L. Nosch (eds.), *Textile Terminologies in the Ancient Near East and Mediterranean from the Third to the First Millennium BC*. Ancient Textile Series 8. Oxford, 430-444.
- Bartholomae, Ch. (1900) Arica XIII. *Indogermanische Forschungen* 11, 112-144.
- Bartholomae, Ch. (1904) *Altiranisches Wörterbuch*. Straßburg.
- Buyaner, D. (2010) Different Modes of Rendering Avestan into Pahlavi. *Zeitschrift der Deutschen Morgenländischen Gesellschaft* 160/1, 79-88.
- Cantera, A. (2004) *Studien zur Pahlavi-Übersetzung des Avesta*. Wiesbaden.
- Cheung, J. (2007) *Etymological Dictionary of the Iranian Verb*.
- Josephson, J. (1997) *The Pahlavi Translation Technique as Illustrated by Hōm Yašt*. Uppsala.
- Kellens, J. (1974) *Les nom-racines de l'Avesta*. Wiesbaden.
- Kotwal, F. M. & Kreyenbroek, Ph. G. (2009) *The Hērbedestān and Nērangestān. Volume IV: Nērangestān, Fragard 3*. Paris.
- Lazard, G. (1963) *La langue des plus anciens monuments de la prose persane*. Paris.
- MacKenzie, D. N. (1971) *A Concise Pahlavi Dictionary*. London.
- Mayrhofer, M. (1992-2001) *Etymologisches Wörterbuch des Altindorischen*. Heidelberg.
- Morgenstierne, G. (2003) *A New Etymological Vocabulary of Pashto*. Wiesbaden.
- Shaked, Sh. (1996) The Traditional Commentary on the Avesta (Zand): Translation, Interpretation, Distortion? In *La Persia e l'Asia Centrale: da Alessandro al X secolo*. Roma, 641-656.
- Skjærvø, P. O. (2009) Middle West Iranian. In G. Windfuhr (ed.), *The Iranian Languages*. London – New York, 196-278.
- Steingass, F. J., Richardson, J., et al. (1930) *A comprehensive Persian-English dictionary, including the Arabic words and phrases to be met with in Persian literature*. London.
- Sundermann, W. (1989) Mittelpersisch. In R. Schmitt (ed.), *Compendium Linguarum Iranicarum*. Wiesbaden, 138-164.
- Waag, A. (1941) *Nirangistan. Der Awestatraktat über die rituellen Vorschriften*. Leipzig.

## “Der Faden soll nicht reißen, während ich meine Dichtung webe...”: Zum metaphorischen Gebrauch von Textilterminologie im Rigveda

Stefan Niederreiter

Wenn man sich als historisch-vergleichender Sprachwissenschaftler mit einem speziellen realienkundlichen Thema einer ausgewählten Epoche einer altindogermanischen Sprache beschäftigt, so ist man aus Erfahrung darauf gefasst, dass Informationen zumeist lückenhaft vorhanden sind und die Erschließung der Texte mit den unterschiedlichsten philologischen und linguistischen Schwierigkeiten verbunden sein kann.

Trägt man das Erkenntnisinteresse textilterminologischer Fragestellungen an den ältesten indischen Text, den Rigveda (RV), heran, liegt es schon an der Textsorte der für rituelle Zwecke bestimmten sacerdotalen Dichtung, dass Informationen zur handwerklichen Praxis des Webens allenfalls verstreut, beiläufig und dann vor allem in poetischen Metaphern den vedischen Hymnen zu entnehmen sind. Aber gerade der Befund der – wie gezeigt werden soll – ausgebauten Metaphorik beweist den „Sitz im Leben“ dieses Handwerks in dieser Zeit; der hohe Stellenwert und die weit verbreitete Kenntnis der Kunst des Webens ist ohne Zweifel eine Voraussetzung für ihren

Gebrauch in Metaphern, die ja bei nicht vorhandenem Verständnis ihre Wirkung verfehlt hätten. So kann auch keine Spezialuntersuchung, die sich mit der Textilterminologie im Altindischen beschäftigt, diesen Aspekt außer Acht lassen. In seiner Untersuchung *Weben und Flechten im Vedischen Indien* bietet Wilhelm Rau<sup>1</sup> zunächst einen klar strukturierten Überblick über das einschlägige Vokabular, das er folgenden Bereichen zuordnet: *Rohstoffe; Aufbereitung; Spinnen; Weben; Namen für Kleidungsstücke; Flechten*. Bereits innerhalb dieser onomasiologischen, im Sinne der „Wörter- und Sachenforschung“ präsentierten Betrachtungen ist es oft unvermeidlich, die metaphorischen Gebrauchsweisen der einzelnen Termini zumindest zu erwähnen; zudem beschließt Rau seinen Aufsatz mit einer kurzen Betrachtung zur indischen Geistesgeschichte: Sieht man die Textilterminologie von einem anderen Blickwinkel als dem des Handwerks, kann man einiges über die Selbstauffassung altindischen Denkens lernen. Es ist sicher kein Zufall, dass manche Termini, die in der frühen Philosophie eine Rolle spielen, und vor allem solche,

1. Rau 1970.

die als Bezeichnung für wissenschaftliche Texte dienen, aus der Sprache der textilen Technik stammen: *grantha-*, ein Nomen zur Verbalwurzel *grath-/granth-* „knüpfen, binden, verbinden“ bedeutet also nicht nur „das Binden“ oder (konkretisiert) „Knoten“, sondern bezeichnet auch eine kunstvolle Verskomposition (vorwiegend den *śloka*-Vers mit 32 Silben), eine wissenschaftliche Abhandlung oder ein beliebiges literarisches Produkt. - *tantra-*, eine Ableitung zur Wurzel *tan-* „spannen, dehnen“, einerseits der Aufzug eines Gewebes, die Webkette, ist aber vor allem in seinen vielen übertragenen Bedeutungen bekannt: ausgehend vom Bild der „Hauptsache“, dem „durchlaufenden System“, einer Norm oder Lehre steht es eben für Regeln, Theorien bzw. wissenschaftliche Abhandlungen, die in mündlicher Tradition oder in schriftlicher Fixierung als *Texte* überliefert sind. – In *nibandha-* und *prabandha-* erkennt man unschwer die Verbalwurzel *bandh-* „(zusammen)binden“, wobei die beiden Ableitungen je nach Belegstelle für „Vertrag“ oder „Kommentar“ stehen können, jedenfalls aber einen Text im allgemeinen bezeichnen. – *sūtra-*, eine Ableitung zum Verbum *sīvy-* „nähen“, ist in seiner Bedeutung „Folge, Sammlung von Regeln“ wohl das geläufigste Vokabel mit der allgemeinen Bedeutung „Text“, das seinen Ursprung im textilen Handwerk hat.<sup>2</sup> Diese Beispiele könnten noch erheblich vermehrt werden; es ist also offensichtlich, dass vor allem die Philosophen und Dichter des Alten Indien ihre Arbeit mit textilen Metaphern bezeichneten: Jemand, der einen Text (*grantha-*) erstellt, knüpft oder bindet etwas zusammen; wer eine Folge oder Sammlung von Regeln (*sūtra-*) verkündet, spinnst gewissermaßen die einzelnen Regeln wie Fasern zu einem (Leit)faden zusammen; und jemand, der einen wissenschaftlichen Text (*tantra-*) verfasst, spannt gewissermaßen Kettfäden auf einen Rahmen, also im übertragenen Sinn Gedanken in ein Bezugssystem. Allen diesen sprachlichen Bildern ist gemein, dass ein vorhandener Rohstoff mit Geduld und Geschick zu einem neuen Gebrauchsgegenstand verarbeitet wird.

Im Folgenden seien einige Beispiele für diese metaphorische Verwendung der Textilterminologie im Rigveda präsentiert. Meine Herangehensweise ist

– aus beruflichen Gründen – die eines Lexikographen; als solcher gehe ich zunächst an die Erstellung eines Wörterbucheintrags (Lemmas) für das hier wohl wichtigste Verbum *o-* „weben“; die durch langjährige Praxis bewährte Form der Behandlung und Darstellung<sup>3</sup> führte zu folgendem Ergebnis:

**o- (v.) facientiv-transitiv „WEBEN“ –**

“WEAVE”; **ápa, prá** (sich hin- und herbewegen, weben, entstehen – move to and from, weave, emerge); **ví** („auseinanderweben“, ausbreiten – “weave apart”, spread out); **sam** (zusammenweben – weave together)

Tiefenkasus-Schema (semantische Rollen):

- Deep Case Scheme (semantic roles):

**1** ACTOR – (THEME)

**1** ACTOR – THEME „jmd. webt etw.“; ACTOR = Nom. +bel., -abstr.; THEME = Akk. -bel., +/-abstr.; (**Simplex; sam**); Aktiv [optionaler BENEFACTIVE (Dat. +bel., -abstr.) ist mit \* gekennzeichnet]; Aktiv

- ACTOR – THEME “s.o. weaves s.th.” ACTOR = Nom. +bel., -abstr.; THEME = Akk. -bel., +/-abstr.; (**Simplex; sam**); Aktiv [optional BENEFACTIVE (Dat. +bel., -abstr.) marked with \*]; active

**1a** ACTOR „jmd. webt weg (**ápa**) und vorwärts (**prá**)“; ACTOR = Nom. +bel., -abstr.; THEME ist unspezifiziert;<sup>1</sup> Aktiv

- ACTOR “s.o. weaves away (**ápa**) and forward (**prá**)”; ACTOR = Nom. +bel., -abstr.; THEME is unspecified;<sup>1</sup> active

**2** Partizip, substantiviert: „die Webende“; ACTOR in der Substantivierung enthalten; THEME ausgespart; Aktiv

- participle, nominalized: “she who weaves”; ACTOR kept in nominalisation; THEME left out; active

**3** *ta*-Partizip (beide Belege mit **ví**): „auseinander gewoben“, i.S.v. „ausgebreitet“; ACTOR ausgespart; THEME = Nom. -bel., +/-abstr.; Passiv

- *ta*-participle (both references with **ví**): “woven apart”, in the sense of “spread out”; ACTOR left out; THEME = Nom. -bel., +/-abstr.; passive

2. Vgl. auch Rau 1970, 38.

3. Vgl. Krisch 2006, 2012.



**4** Infinitiv (final); THEME unspezifiziert  
▪ infinitive (final); THEME unspecified

Präsensstamm themat. (X. Kl.) (váya-):

**\*\*Aktiv**

**\*Indikativ Präs.** 3.Pl. *váyanti* **1** 6,9,2<sup>2</sup>; *vayanti* **1** 5,47,6\*; 9,99,1\*; 10,130,1<sup>3</sup>

**\*Imperativ** 2.Sg. *vaya* **1a** 10,130,1 (**ápa**); 10,130,1 (**prá**); 2.Pl. *vayata* **1** 10,53,6<sup>4</sup>

**\*Partizip Präs.** Gen.Sg.m. *váyatas* **1** 2,28,5<sup>5</sup>; Nom. Pl.m. *váyantas* **1** 7,33,9;<sup>6</sup> Nom.Sg.f. *váyanti* **2** 2,38,4; Nom.Du.f. *váyanti* **1** 2,3,6 (**sam**)

Perfektstamm (ūv-):

**\*\*Aktiv**

**\*Indikativ Perfekt** 3.Pl. *ūvur* **1** 1,61,8<sup>7</sup>

Futurstamm (vay-iṣyá-):

**\*\*Aktiv**

**\*Partizip** Nom.Sg.m. *vayiṣyān* **1** 7,33,12<sup>8</sup>

-ta-Partizip

Akk.Sg.m. *utam* **3** 1,122,2<sup>9</sup> (**ví**); Lok.Sg.m. *ute* **3** 3,54,9<sup>10</sup> (**ví**)

Infinitiv

*ótave* **4** 10,130,2; *otavai* **4** 1,164,5

Vielleicht iir., vgl. sogd. *ptw'y* „rollen“. Idg. *\*h<sub>2</sub>ey-* „weben“, vgl. lit. (mit Dentalerweiterung) *áusti* „weben“. Der Präsensstamm geht auf *\*h<sub>2</sub>u-éje-* zurück, vgl. EWAia I: 275f. Aus dem Präsensstamm wurde eine neue Wurzel *vay-* abstrahiert und zur Futurbildung verwendet; vgl. auch LIV: 224 s.v. *\*Heu-*. VIA:163.

<sup>1</sup> Selbstgespräch der Väter, die „weben“ [an dieser Stelle (10, 130,1) metaphorisch-allegorisch für das Weben des „Opferteppichs“ (= Zubereiten des Opfers)].

▪ Soliloquy of fathers, who “weave” [in this passage (10,130,1) metaphorical-allegorical for the weaving of the “sacrifice carpet” (= preparing of the sacrifice)].

<sup>2</sup> Das THEME („Faden“) ist zu ergänzen. – In der „Webeallegorie“ auf die Dichtkunst angewandt, vgl. *ótu-* „Schussfaden“ (s.d.).

<sup>3</sup> Metaphorisch für die Opferhandlung.

<sup>4</sup> Metaphorisch für die Opferhandlung.

<sup>5</sup> In der „Webeallegorie“ auf die Dichtkunst angewandt, vgl. Fn. 2.

<sup>6</sup> THEME metaphorisch für die Generationsfolge, vgl. Ge. Kommentar z.St.

<sup>7</sup> THEME metaphorisch: Preislied (*arkám*).

<sup>8</sup> Vgl. Fn. 6.

<sup>9</sup> *átkam* „Gewand“ wahrscheinlich metaphorisch für den Sternenhimmel, vgl. Renou EVP 5: 6.

<sup>10</sup> Vgl. aber Wackernagel KZ 46: 269, der (gegen Pp.) den Beleg zu *yav<sup>2-</sup>* „fernhalten“ stellt.

Wie bei den Lemmaeinträgen für Verben üblich, wird zunächst eine allgemeine Übersetzung (in Großbuchstaben, deutsch und englisch) gegeben; es folgt ein grau hinterlegter Block mit syntaktischen Informationen. Im darunter befindlichen morphologischen Teil wird jede belegte Verbalform mit der Nummer der jeweiligen syntaktischen Konstruktion verbunden. Diese Kreuzklassifikation ermöglicht ein Höchstmaß an Information auf möglichst geringem Raum.<sup>4</sup> Besonders an den Fußnoten zu einigen Belegstellen ist sofort zu erkennen, dass auch bei diesem Verbum der metaphorische Gebrauch häufig anzutreffen ist, wie z.B. in RV 10,130,1-2:<sup>5</sup>

10,130,1a yó yajñó · viśvátas tántubhis tatá ékaśataṃ devakarmébhir áyataḥ |

10,130,1c imé vayanti pitáro yá áyayúḥ prá vayápa vayéti ásate taté ||

10,130,2a púmāñ enaṃ tanuta út kṛṇatti púmān ví tatne ádhi náke asmín |

10,130,2c imé mayúkhā úpa sedur ū sádaḥ sāmāni cakrus tásarāṇi ótave ||

„(1) *Das Opfer, das nach allen Seiten mit seinen Fäden aufgespannt ist, das mit hundert und einem gottes(dienstlichen) Werken aufgezogen ist, das weben diese Väter, die herbeigekommen sind. Sie sitzen bei dem aufgespannten und sprechen: Webe hin, webe her!*“

4. Zu Genauerem vgl. Krisch 2006, VIIIff.

5. Der vedische Text ist entnommen aus Van Nooten & Holland 1994; die Übersetzungen richten sich nach Geldner 1951=2003 und Witzel & Gotō 2007.

(2) *Der Mann spannt es auf, zieht den Fäden aus, der Mann hat es an diesem Firmament festgespannt. Dies sind die Pflöcke. Sie haben sich an ihren Sitz gesetzt; sie haben die Melodien zu Webschiffchen gemacht, um zu weben.“*

*„Nicht verstehe ich den Faden noch den Einschlag, nicht (weiß ich), welchen (Faden) sie weben, wenn sie in den Wettstreit eintreten. Wessen Sohn könnte hier wohl Worte reden, höher als sein Vater hienieden?“*

Diesen beiden Strophen ist zu entnehmen, dass das Opfer, dessen Erschaffung hier allegorisch geschildert wird, mit Fäden aufgespannt wird, das heißt, es hat eine gewisse vorbestimmte Form, und die Hymnen, also die einzelnen Wörter, hier verglichen mit Webschiffchen, werden in diesen Rahmen verwoben. Die Väter, die hin- und herweben, produzieren eigentlich die Hymnentexte.

Die metaphorische Verwendung von *tántu-*, der Webkette als die Form eines Opferhymnus und von *ótu-*, dem Schussfaden, der mit dem Webschiffchen eingewoben wird als die Wörter dieses Texts wird in der folgenden Passage RV 6,9,2 noch klarer: Die Stelle beschreibt die Selbstzweifel eines jungen Priesters, der befürchtet, „den Faden zu verlieren“ und in einem Dichterwettstreit zu unterliegen:

6,9,2a *nāhám tántuṃ ná ví jānāmi ótuṃ*  
*ná yám váyanti samaré 'tamānāḥ |*  
 6,9,2c *kásya svit putrá ihá váktuvāni paró*  
*vadāti ávareṇa pitrá ||*

Was genau ist nun unter „Faden“ und „Einschlag“ in diesem Kontext zu verstehen? Von entscheidender Wichtigkeit ist hier die Tatsache, dass es sich bei diesen ältesten vedischen Hymnen um metrische Texte handelt. Das grundlegende Prinzip, das diese Metrik bestimmt, ist die Vorgabe einer bestimmten Anzahl von Silben, die in einem sog. Pāda enthalten sind. Ein Pāda entspricht in dem obigen Beispiel 6,9,2 der Hälfte einer Zeile bzw. einem Viertel der Strophe. Dazu kommt, dass diese Verse mehr oder weniger strikt einem quantitativen Rhythmus folgen, nach dem sich kurze und lange Silben abwechseln, wobei der zweite Teil eines Pāda, die Kadenz, in dieser Hinsicht strenger reguliert ist. Um den folgenden Beispielen besser folgen zu können, sei noch (kurz und vereinfacht) auf den Begriff *Positionslänge* hingewiesen: Eine Silbe, die auf den ersten Blick als kurz erscheint, ist als Länge zu messen, wenn ihr mehr als ein Konsonant folgt (daher bildet z.B. das *á* in *váktuvāni* den Gipfel einer langen Silbe).<sup>6</sup> Die Stelle 6,9,2 hat nun folgende metrische Gestalt: Es sind vier Zeilen bzw. Pādās zu je elf Silben, was das sog. Triṣṭubh-Metrum ergibt.

ná	hám	tán	tum	ná	ví	jā	nā	mí	ó	tum
ná	yám	vá	yan	ti	sa	ma	ré	'ta	mā	nāḥ
ká	sya	svit	pu	trá	i	há	vák	tu	vā	ni
pa	ró	va	dā	tí	á	va	re	ṇa	pi	trā

In vertikaler Richtung sind so in diesem (sprachlichen) Bild elf Kettfäden (*tántu-*) ausgespannt, die jeweils eine Stelle für eine Silbe repräsentieren. *ótu-*, der Einschlag, läuft horizontal von links nach rechts mit seiner festgelegten Abfolge von langen und

kurzen Silben: Die langen Silben sind hier schwarz hinterlegt, die kurzen grau; auf weißem Grund sind diejenigen Silben, die hinsichtlich ihrer Länge nicht festgelegt sind.<sup>7</sup> Hier wird die die strengere Reglementierung der Kadenz, die auch für andere Metren

6. Eine nützliche Einführung in die vedische Metrik bietet z.B. MacDonell 1916 (=1990), 436ff.

7. Gängige Kennzeichnungen sind: - für eine lange, ~ für eine kurze Silbe und = oder x für eine kurze oder lange Silbe („anceps“). – Die hier gewählte Darstellungsweise soll einerseits die fixierte „Breite“ des Text(il)stücks veranschaulichen, die farbliche Kennzeichnung lässt andererseits das Entstehen eines (Web-)Musters erkennen.

gilt, deutlich sichtbar. Diese Darstellung zeigt, dass der Dichter innerhalb des Triṣṭubh-Metrums zwischen zwei Verstypen wählen konnte: Pāda a folgt dem Vers-Typ 1,<sup>8</sup> die Pādās b-d dem zweiten möglichen Muster.<sup>9</sup> Wie zu erkennen ist, werden die für dieses Metrum vorgegebenen Muster genau eingehalten; bezogen auf den Inhalt der Textpassage kann man demnach sagen, dass der junge Poet wohl keinen Grund hat, unsicher oder nervös in den Dichtertwist einzutreten.

Diese Nervosität und Unsicherheit kann freilich vor dem Hintergrund gesehen werden, dass im gesamten Rigveda sehr genau auf eine möglichst saubere metrische Gestalt der Hymnen geachtet wurde. Dies liegt im Glauben begründet, dass metrisch mangelhafte Verse nicht die Aufmerksamkeit der Götter, an die sie gerichtet waren, erhalten würden. In der folgenden Stelle RV 2,28,5 kommt dieser Anspruch zum Ausdruck:

ví	mác	chra	thā	ya	ra	śa	nám	i	vá	ga
ṛ	dhyā	ma	te	va	ru	ṇa	khám	ṛ	tá	sya
mā	tán	tuś	che	dī	vá	ya	to	dhí	yam	me
mā	mā	trā	śā	rī	a	pá	saḥ	pu	rā	ṛtóḥ

An dieser Darstellung von RV 2,28,5 ist zu erkennen, dass das metrische Muster wieder durch das Triṣṭubh-Versmaß bestimmt ist, wir sehen also elf Kettfäden bzw. Silben in jedem der vier Halbverse (Pādās) als Einschlüge mit der festgelegten Abfolge von langen und kurzen Silben.

Nicht nur das Material, also Webkette und Schussfaden, sondern auch Wörter für den Weber selbst – oder seltener die Weberin, wie im folgenden Beispiel – konnten in verschiedenen Kontexten metaphorisch gebraucht werden, vgl. z.B. RV 2,3,6:

2,3,6a sādhú āpāmsi sanátā na ukṣité  
uśāsānāktā vayíyeva raṇvité |

8. Das heißt: x - x - , - - - | - - - x.

9. Das heißt: x - x - x, - - | - - - x.

10. Vgl. auch die Behandlung von uśás- „Morgenröte“ in Andrés-Toledo 2010, 42-45.

11. Es sollte nicht unterschlagen werden, dass der Padapāṭha *vayyā* zeigt, der Form nach also ein mask. Dual; der hier eigentlich anzunehmende fem. Dual *vayíye* (u.a. weil dann auch in Kongruenz mit *raṇvité*, fem.Du.) kann zugrunde gelegt werden, wenn man einen doppelten Sandhi annimmt: *vayíye iva* → *vayíya iva* → *Samh. vayíyeva*. Vgl. auch Oldenberg 1909 (zur Stelle).

2,28,5a ví mác chrathāya raśanām ivāga  
ṛdhyāma te varuṇa khám ṛtasya |

2,28,5c mā tántuś chedi váyato dhíyam me  
mā mátrā śāri apásaḥ purá ṛtóḥ ||

„Löse die Sünde von mir wie einen Gurt!  
Wir möchten dir die Quelle der Wahrheit recht machen. Der Faden soll nicht reißen, während ich meine Dichtung webe, noch soll der Maßstab des Werk tätigen vor der (rechten) Zeit zerbrechen.“

Der Dichter hofft also, weiterhin seiner Tätigkeit, der Erschaffung von Hymnen gemäß den vorgegebenen Richtlinien nachgehen zu können; er fürchtet einen vorzeitigen Tod, der sein Werk unterbrechen könnte.

2,3,6c tántuṃ tatām samváyantī samīc' ya-  
jñāsya péśaḥ sudúghe páyasvatī ||

„Nacht und Morgen, seit alters erwachsen, (wirken) für uns geschickt ihre Werke wie zwei fröhliche Weberinnen, die vereint den aufgespannten Aufzug (und) die Verzierung des Opfers verweben, sie die gut milchenden, milchreichen (Kühe).“

Hier werden die Tageszeiten *Nacht* und *früher Morgen*<sup>10</sup> mit Weberinnen<sup>11</sup> verglichen; *tántu-*, die

Webkette, kann hier als die vorgegebene Zeit interpretiert werden, während der Einschlag als *pésas-*, also das eingearbeitete Muster bzw. die Verzierung

erscheint und wohl auch für das Opfer steht,<sup>12</sup> das diese wichtige Tageszeit ausfüllt.

sā	dhī	á	pāṃ	si	sa	ná	tā	na	u	kṣi	té
u	ṣā	sā	nák	tā	va	yí	ye	va	raṇ	vi	té
tán	tum	ta	tám	saṃ	vá	yan	tī	sam	ī	cí	
ya	jñá	sya	pé	śaḥ	su	dú	ghe	pá	yas	va	tī

An dieser Strophe sieht man, dass sich eine Zuordnung zu einem bestimmten Metrum bisweilen schwierig gestalten kann bzw. dass Unregelmäßigkeiten in der metrischen Ausformung der Verse immer wieder auftreten. Die hier gegebene Darstellung zeigt (bis auf Pāda c) 12 Silben pro Pāda, was einem Jagatī-Metrum entspricht.<sup>13</sup> RV 2,3,6 wird von Van Nooten & Holland als zwölfsilbige Triṣṭubh geführt, mit Pāda c als katalektischem Vers.<sup>14</sup> Bedenkt man nun, dass der übrige Hymnus RV 2,3 sich im allgemeinen sauber an das Triṣṭubh-Versmaß hält und die Strophe 7 klar als Jagatī einzuordnen ist, könnte man von einem spielerischen Changieren der beiden Metren bzw. einer kunstvollen Überleitung in den Zwölfsilbler der siebten Strophe sprechen, was gerade in dieser Passage, in der die Metaphorik des Webens anklingt, als das „Einflechten“ eines auffälligen Musters in einen sonst metrisch gleichförmigen Text verstanden werden könnte.

Richtet man den Blick wieder auf thematische Kerngebiete des behandelten Themas, so fällt immer

wieder die zentrale Rolle der rituellen Handlungen auf, und so wird, wie in der folgenden Stelle, der Opferpriester als Weber angesprochen und eingeladen, sein Werk weiterzuführen:

10,53,6a tántum tanván rájaso bhānám ánv  
 ihi jyótiṣmataḥ pathó rakṣa dhiyá kṛtán |  
 10,53,6c anulbaṇám vayata jóguvām ápo  
 mánur bhavā<sup>15</sup> janáyā daíviyaṃ jánam ||

„Deinen Faden weiterspannend geh du dem Lichte des Luftraums nach; nimm die lichten Pfade, die mit Kunst bereitet, in acht! Webet ohne Knoten das Werk der Sänger! Sei du Manu, schaffe das göttliche Volk (herbei)!“

Hier ist die Webkette *tántu-*, die ausgespannt wird, das Opfer selbst (in 2,3,6 wird ja eher die entsprechende Zeitspanne gemeint, s.o.), und die Verse, die es begleiten, sollen „ohne Knoten“ sein, das heißt ohne Fehler in der metrischen Gestaltung:

tán	tum	tan	ván	rá	ja	so	bhā	núm	án	vi	hi
jyó	tiṣ	ma	taḥ	pa	thó	ra	kṣa	dhi	yá	kṛ	tán
an	ul	ba	ṇám	va	ya	ta	jó	gu	vām	á	po
má	nur	bha	vā	ja	ná	yā	daí	ví	yaṃ	já	nam

12. Bzw. für den Sternenglanz und die ersten Sonnenstrahlen, die sie selbst verbreiten, vgl. Witzel & Gotō 2007, 783.

13. Beispielsweise entspricht Pāda a einem Jagatī-Vers vom Typ b bei MacDonell 1916 (= 1990), 442.

14. Also unterzählig, vgl. die obige Darstellung bzw. Van Nooten & Holland 1994, 600.

15. *bhavā* nach Arnold 1905, 320; Van Nooten & Holland 1994, s.v. *bhava*.

Man sieht hier, dass die geforderte Silbenanzahl für Jagatī-Verse genau eingehalten wird (4x12); bezüglich der Silbenquantität kann zumindest den diesbezüglich so wichtigen Kadenzen Regelmäßigkeit zugeschrieben werden; Pāda a und d folgen dem ersten von zwei möglichen Jagatī-Mustern,<sup>16</sup> während Pāda c dem zweiten, sich in der Zäsur unterscheidenden Typ folgt.<sup>17</sup> Die auffälligste Unregelmäßigkeit stellt jedoch die Zäsur in Pāda b dar, die sich in keines der gängigen Schemata eingliedern lässt.<sup>18</sup>

Der metaphorische Gebrauch von *tántu-*, der Webkette als das Opfer kann nun selbst wieder in einem erweiterten Sinn aufgefasst werden, vgl. RV 1,142,1:

1,142,1a sámiddho agna á vaha devāñ  
adyá yatásruce |

sám	iddh	o	a	gna	á	va	ha
de	vāñ	a	dyá <sup>19</sup>	ya	tá	sru	ce
tán	tuṃ	ta	nuṣ	va	pūr	ví	yám
su	tá	so	mā	ya	dā	sú	ṣe

Klar tritt wieder die Einhaltung des metrischen Musters in den Kadenzen hervor; die ersten vier Silben der Verse werden, wie üblich, freier behandelt, obwohl häufig versucht wird, sie einem Grundmuster anzunähern (vgl. Fn. 18).

Dass dieses oft sehr komplexe System von Metaphern auch dazu führen kann, ein Wort wieder in einer – manchmal schwer zu ermittelnden – konkreten Bedeutung zu verwenden, soll an einer Strophe aus einem Hymnus an Soma gezeigt werden. Soma ist das heilige Getränk des vedischen Opfers; seine Zubereitung wird zwar ausführlich, aber meist mit vielen schwer aufzulösenden Metaphern und Allegorien im neunten Buch des Rigveda geschildert. In der

1,142,1c tántuṃ tanuṣva pūrviyám  
sutásomāya dāsúṣe ||

„Entzündet fahre, o Agni, heute die Götter zu dem (Opfernden), der den Schmalzlöffel erhebt. Spanne den altgewohnten Faden für den Opferspender, der Soma ausgepresst hat!“

Agni, der Gott des Feuers, der hier angerufen wird, wird als Bote zwischen den Menschen und den Göttern angesehen; der ausgespannte Faden *tántu-* kann also einerseits für die Kontinuität der Opferpraxis stehen, andererseits auch als Verbindung zum Bereich des Göttlichen verstanden werden. Das metrische Schema zeigt vier Zeilen (= Pādās) zu je acht Silben:

folgenden Stelle werden die Somasäfte als die „raschen Güsse“ bezeichnet:

9,69,6a sūryasyeva raśmáyo drāvayitnávo  
matsarāsaḥ prasúpaḥ sākám īrate |  
9,69,6c tántuṃ tatám pári sárgāsa áśávo  
néndrād ṛté pavate dhāma kíṃ caná ||

„Gleich den Sonnenstrahlen, die die Schläfer auf die Beine bringen, kommen die berausenden (Säfte) auf einmal hervor. Die raschen Güsse um(kreisen) den ausgespannten Faden. Ohne Indra läutert sich kein Ding.“

16. Typ a nach MacDonell 1916 (= 1990), 442.

17. Typ b nach MacDonell 1916 (= 1990), 442; Arnold 1905, 320 nimmt *vayatā* an, um Pāda c an a und d anzugleichen.

18. Vgl. Van Nooten & Holland 1994, 656: „uncommon break“.

19. Arnold 1905, 295: *adyá*; metrisch nicht notwendig nach Van Nooten & Holland 1994, 591.

Die Wörter, die uns hier besonders interessieren, sind *tántum tatám*, der ausgespannte Faden: Im speziellen Kontext dieses Hymnus kann man sie als das Opfer, das als Kettfäden die Verbindung zu den Göttern herstellt, sehen,<sup>20</sup> aber zugleich wird das Bild von Fasern der Somaseihe evoziert: Der Somasaft wird

während seiner Herstellung durch ein Sieb gegossen, um sich zu läutern. Diese wie so oft sehr voraussetzungsreichen poetischen Bilder werden auch hier in einem klaren metrischen Schema dargebracht, was erneut auf die Parallelität von Dichtung und Webkunst verweist:

sūr	yas	ye	va	raś	má	yo	drā	va	yit	ná	vo
mat	sa	rā	saḥ	pra	sú	paḥ	sā	kám	ī	ra	te
tán	tum	ta	tám	pá	ri	sár	gā	sa	ā	śá	vo
nén	drād	ṛ	té	pa	va	te	dhā	ma	kīm	ca	ná

Die Jagatī-Strophe ist vor allem in den Kadenzten sehr regelmäßig gebaut;<sup>21</sup> am auffälligsten ist noch die unregelmäßige Zäsur in Pāda a (positionslanges *raś*), das kurze *sa* in Pāda b steht im ersten, freier gehaltenen Versteil.

Diese Rigvedapassagen, die zeigen, wie eng die Dichtkunst mit dem Vokabular des Webandwerks verbunden ist, und wie auch die Breite eines Textilstücks mit der Silbenanzahl eines Verses korrespondiert bzw. die Längen und Kürzen der Silben ein Muster ergeben, könnten noch um weitere Beispiele vermehrt werden. Man kann aber auch zeigen, dass sich der metaphorische Gebrauch der Textilterminologie nicht auf den Bereich der Komposition von metrischen Texten für den rituellen Gebrauch beschränkt. Die folgende Stelle aus dem zweiten Buch des Rigveda zeigt, wie die Textilproduktion auf andere Schaffensprozesse übertragen werden kann:

2,32,4a rākām ahám suhávāṃ suṣṭutí huve  
 śṛṇótu naḥ subhágā bódhatu tmánā |  
 2,32,4c sīvyatv aḥ paḥ sūciyāchidyamānayā  
 dādātu vīrāṃ śatádāyam ukthīyam ||

*„Ich rufe die gut zu rufende Rākā mit schönem Loblied; die mit gutem Anteil soll es von selbst bemerken. Sie soll (ihr) Werk mit unzerbrechlicher Nadel nähen; sie soll einen hundertfachen Anteil habenden, preiswürdigen Heldensohn schenken.“*

Hier wird Rākā, die Göttin, die über den Tag des Vollmondes, um Hilfe in der Zeit der Schwangerschaft und Geburt angerufen. Man sieht sehr klar an dem hier verwendeten Vokabular wie dem Verb *sīvy-* „nähen“ und *sūci-* „Nadel“, dass das Konzept der Textilproduktion auch auf natürliche Zeugungs- und Schaffensprozesse übertragen wird. Genau wie der Dichter eine Hymne ohne Fehler „weben“ muss, damit sie von den Göttern akzeptiert wird, so wird auch die Göttin Rākā darum gebeten, ein gesundes Neugeborenes „anzufertigen“.

Überblickt man den Rigveda in seiner Gesamtheit, so kann man beobachten, dass die Dichter dieser Zeit nicht nur im Kontext der Dichtkunst auf Metaphern aus dem Handwerk des Webens zurückgriffen. Diese poetischen Kunstgriffe erfüllten freilich eine wichtige

20. Diese verbindende Funktion begegnet wie bei Agni immer wieder, vgl. z. B. RV 9,22,6-7:

9,22,6a tántum tanvānām uttamám ánu praváta āsata |

9,22,6c utédám uttamāyīyam ||

9,22,7a tuvāṃ soma pañibhya ā vásu gávyāni dhārayaḥ |

9,22,7c tatám tántum acikradaḥ ||

„Entlang der Höhen haben sie den ausgespannten höchsten Faden erreicht, der als der Höchste gelten muss. Du, Soma, sollst den Pañis die Rinderschätze abnehmen. Du hast den aufgespannten Faden laut erklingen lassen.“ – Der aufgespannte Faden steht hier wieder für das Opfer, das der heilige Rauschtrank Soma als wichtiger Bestandteil der Zeremonie zum Erfolg führt.

21. Vgl. den Typ a bei MacDonell 1916 (=1990), 442.

Funktion: Sie sollten den am Ritus beteiligten Menschen religiöse Wahrheiten näherbringen und psychologische Prozesse begreiflich machen. Natürlich hat dieses Verfahren der sehr ausgebauten Metaphorik für den Übersetzer dieser Texte in der Gegenwart oft zur Folge, vor enigmatischen Formulierungen zu stehen und dem vollen Gehalt dieser Texte nur schwer näher zu kommen. Aber es erweist sich doch immer wieder, dass der Rigveda als ältester indischer Text auch für die Kulturgeschichte wertvolle Quellen bietet.

### Bibliographie

- Andrés-Toledo, M.-Á. (2010) *El Hilo de la Vida y el Lazo de la Muerte en la Tradición Indoiranica*. Institució Alfons el Magnànim. Diputació de Valencia.
- Arnold, E. V. (1967 = 1905) *Vedic Metre in its historical Development*. Delhi.
- Geldner, K. F. (1951) *Der Rig-Veda. Aus dem Sanskrit ins Deutsche übersetzt und mit einem laufenden Kommentar versehen* (4 Bände). Cambridge.
- Gonda, J. (1975) *A History of Indian Literature. Vedic Literature (Saṃhitās and Brāhmaṇas)*. Wiesbaden.
- Grassmann, H. (1999 = 1873) *Wörterbuch zum Rig-Veda*. Delhi.
- Krisch, T. (2006) *RIVELEX: Rigveda-Lexikon. Band 1. Unter Mitarbeit von Christina Katsikadeli, Stefan Niederreiter und Thomas Kaltenbacher*. Graz.
- Krisch, T. (2012) *RIVELEX: Rigveda-Lexikon. Band 2. Unter Mitarbeit von Christina Katsikadeli, Stefan Niederreiter, Konstantinos Sampanis und Sabine Ziegler*. Graz.
- MacDonell, A. A. (1990 = 1916) *A Vedic Grammar for Students*. Bombay-Calcutta-Madras.
- Mayrhofer, M. (1992–1996–2001) *Etymologisches Wörterbuch des Altindoarischen. I., 2. und 3. Band*. Heidelberg.
- Müller, F. M. (1877) *The Hymns of the Rig-Veda in the Samhita and Pada Texts*. London.
- Oldenberg, H. (1909) *Rigveda. Textkritische und exegetische Noten. I. 1.-6. Buch*. Berlin.
- Oldenberg, H. (1912) *Rigveda. Textkritische und exegetische Noten. II. 7.-10. Buch*. Berlin.
- Rau, W. (1970) *Weben und Flechten im Vedischen Indien*. Mainz-Wiesbaden.
- Rix, H., Kümmel, M., Zehnder, T., Lipp, R., Schirmer, B. (2001) *LIV. Lexikon der indogermanischen Verben. Die Wurzeln und ihre Primärstambildungen. Unter Leitung von Helmut Rix und der Mitarbeit vieler anderer. 2. erweiterte Auflage bearbeitet von Martin Kümmel und Helmut Rix*. Wiesbaden.
- Van Nooten, B. A. & Holland, G. B. (1994) *Rig Veda. A Metrically Restored Text with an Introduction and Notes*. Cambridge-London.
- Werba, C. H. (1997) *VIA. Verba Indoarica. Die primären und sekundären Wurzeln der Sanskrit Sprache. Pars I: Radices Primariae*. Wien.
- Witzel, M., Gotō T. (2007) *Rig-Veda. Das heilige Wissen. Erster und zweiter Liederkreis. Aus dem vedischen Sanskrit übersetzt und herausgegeben von Michael Witzel und Toshifumi Gotō unter Mitarbeit von Eijirō Dōyama und Mislav Ježić*. Frankfurt am Main-Leipzig.

## Der Text als Gewebe: Lexikalische Studien im Sinnbezirk von Webstuhl und Kleid

Oswald Panagl

Die Thematik des folgenden Beitrags ist gleichsam doppelt gepolt. Sie ist zunächst im terminologischen Feld der Prozesse, Instrumente und Produkte der Sachbereiche von Weben und Flechten verankert. Zugleich ist sie auch in den metaphorischen Verwendungsweisen der zugehörigen Sinnbezirke bzw. Wortfelder, also im weitgespannten Horizont der Herstellung von Stoffen, Tüchern und Gewändern verortet. „Vom Textil zum Text“ ließe sich die Intention des Artikels bündig zusammenfassen: Dabei verläuft also die Richtung der Bedeutungsentwicklung des Produkts in ihrer Tendenz gegen den Vorgang der zugehörigen morphologischen Ableitung.

Ich möchte mich meinem Vorhaben zunächst mit einem Blick auf die bekannten beiden konversen Zugänge zur Semantik von Einzelwörtern und lexikalischen Systemen zuwenden.<sup>1</sup> Das onomasiologische Verfahren untersucht die Bezeichnungsweise bestimmter Gegenstände, Vorgänge oder Sachverhalte und wirft dabei ein Licht auf die Benennungsmotive, die für die Prägung der einschlägigen Ausdrücke wesentlich waren und für deren ‚Erfinder‘ mental bzw.

pragmatisch im Vordergrund standen. Die Kehrseite der semantischen Analyse ist bekanntlich das semasiologische *Procedere*, in dem Lexeme bzw. Syntagmen ihre sprachlichen Merkmale preisgeben. Erst das Zusammenspiel der beiden Vorgangsweisen ergibt ein Resultat, das als aufschlussreiches semantisches Profil gelten darf.

Was sich für das Weben und die Herstellung von Textilien behaupten lässt, gilt ebenso für die Praxis des Dichtens. Diese nach unserer modernen Einschätzung geistige Tätigkeit wurde in der durch alte Texte zugänglichen Frühzeit als Handwerk empfunden oder schien sich - als ein alternatives Extrem - göttlicher Inspiration zu verdanken. Ein spezifischer, verbindlicher allgemein gültiger Wortschatz, wie er sich für manuelle Verrichtungen oder kriegerische Vorhaben herausgebildet hat, scheint in diesem Segment des geistigen Überbaus zu fehlen. Und gerade dieses Defizit erklärt den späteren metaphorischen Gebrauch oder - mit anderen Worten - die sekundäre Sublimierung von professionellen Handgriffen und technischen Abläufen zur Beschreibung geistiger Leistungen und künstlerisch-kreativer Vorgänge.

1. Vgl. Bußmann 2002, svv.



Das Lexikon ausgewählter Synonyme indoeuropäischer Sprachen, als kollektives Nachschlagewerk unter der Leitung von Carl Darling Buck<sup>2</sup> in Chicago entstanden, stellt den ehrgeizigen Versuch dar, Forschungsergebnisse der linguistischen Einzeldisziplinen zu sammeln, aufzubereiten und einer interessierten breiteren Öffentlichkeit zugänglich zu machen. Die einzelnen Sprachen sind dabei unterschiedlich ausgewertet und dokumentiert: Die später entdeckten und philologisch aufbereiteten Idiome erscheinen darin unterrepräsentiert, und nicht alle vorgeschlagenen Etymologien sind nach dem neuesten Stand der Forschung stichhaltig. Dennoch eignet sich das Werk noch heute für einen ersten Blick auf die komparatistische Gliederung und verbale Besetzung eines thematischen Bereichs. Was ich unter (1) in Auswahl vorstelle, sind Bezeichnungen für das Weben in einer Reihe von verwandten Sprachen, die allein in dieser Auflistung völlig unterschiedliche Wurzeln erkennen lassen. Auch Sprachzweige, die sonst häufig vergleichbare Wege gehen, zeigen in diesem Fall anderes Wortmaterial.

- (1) Buck (1949): 6.33 WEAVE  
(Auswahl) - gr. ὑφαίνω, lat. *texere*,  
ir. *figim*, an. *vefa*, ae. *wefan*, ahd.  
*weban*, lit. *áusti*, aksl. *tvkati*, ai. *u-*

Ich verweise, ohne auf etymologische Details einzugehen, auf die Varianten im germanischen, baltischen und slawischen Bereich sowie auf die lateinisch-keltische Evidenz. Über die Differenzierung einer gleichen Wurzel durch morphologische Veränderungen oder Erweiterungen, etwa im Verhältnis zwischen den griechischen, germanischen und altindischen Formen, informieren in Einzelheiten jeweils die entsprechenden etymologischen Nachschlagewerke.<sup>3</sup>

Ein vergleichbar heterogenes Bild bietet Bucks Liste zu den Bezeichnungen des Dichters:

- (2) 18.67 POET (Auswahl) - gr. ποιητής,  
lat. *poeta*, (*vātēs*), ir. *faith*, *fili*, an.

*skald*, ae. *scop*, ahd. *scof*, mhd.  
*tihtaere*, *poëte*, lit. *poëtas*, skr.  
*pjesnik*, russ. *poet*, *stichotvorec*, ai.  
*kavi-*

Auch in diesem Bereich dominieren die Unterschiede vor den Gemeinsamkeiten, die sich ihrerseits zumeist sekundären Lehnbeziehungen verdanken, wie die Verbreitung von gr. ποιητής z.B. im lateinischen, mittelhochdeutschen, slawischen und litauischen Lexikon darlegt. Das alternative lateinische Wort *vātēs*, das man mit einem Etymon „wehen“ in Verbindung bringen wollte, wurzelt wohl im kultisch-magischen Bezirk. Es bezeichnete in älterer Zeit ein eher unheimlich-dämonisches Wesen, einen Hexer quasi, ehe es in der augusteischen Periode zu einem besonders rühmenden Ausdruck für den inspirierten und begnadeten Autor aufstieg.<sup>4</sup>

Geht man, sofern die einzelnen Bezeichnungen überhaupt sicher gedeutet sind, auf ihre Benennungsmotive ein, so zeichnen sich einige Schwerpunkte bzw. „Nester“ oder Konvergenzen ab, die gleichsam einen onomasiologischen Pfad säumen. Der Dichter erscheint dabei vor allem als „Macher“ bzw. genauer als „Schöpfer von Versen“; eine jüngere Kulturstufe setzt ihn mit der Tätigkeit des Schreibens gleich, auch „Sänger“ wird er apostrophiert oder mit prophetischen Gaben bedacht. Ein besonderer Fall ist der Name *Dichter* und das zugrundeliegende Verbum *dichten* im Deutschen. Es gehört nicht in einer Lesart „dicht machen, verdichten“ zum Adjektiv *dicht*, sondern ist ein frühes Lehnwort aus lat. *dictāre* „wiederholt sagen, ansagen“ und gewährt damit gleichsam einen Blick in die Werkstatt dieses Berufs.

- (3) - *themo dihtôn ih thiz buah* (Otfrid,  
*Widmung an König Ludwig*, 82)  
- *dizze buoch dihtôte zweier kinde*  
*muoter diu sageten ir disen sin*  
(*Jüngstes Gericht bei Diemer* 292,13)  
- *der ime daz buoch wider liez und*

2. Buck 1949.

3. Vgl. Frisk 1970, 976f; Beekes 2010, 1540; Mayrhofer 1992, 275; Kluge & Seebold 2002, 975; Falk & Torp 1960, 1405 s.v. *vaeve*; Fraenkel 1962, 26; Vasmer 1958, 109 s.v. *tkaty*; Matasović 2009, 409 s.v. *\*weg-yo-*.

4. Vgl. Tacitus *Dialogus de oratoribus* 9.2: “Quis Saleium nostrum, egregium poetam vel, si hoc honorificentius est, praeclarissimum vatem, deducit [...]?”

*iz in vol tihten hiez* (Veldeke, *Eneit* 13,311)<sup>5</sup>

Distinktives Merkmal für das Selbstverständnis und die Fremdbezeichnung des Poeten war zur Zeit der Lexikalisierung des einschlägigen Vokabulars offenbar das Ansagen, das Diktieren von Worten und Sätzen, die von professionellen Schreibern festgehalten wurden. Die drei Zitate aus dem ahd. Otfrid, der Darstellung des Jüngsten Gerichts und dem frühmittelniederdeutschen Heinrich von Veldeke zeigen, dass die Ausdrucksweise eng mit der bereits blühenden Buchkultur verknüpft war: An der letztgenannten Stelle überließ der adelige Auftraggeber dem Dichter wieder das Buch und befahl ihm, es „voll zu dichten“, d.h. als Werk zu vollenden.

Wenden wir uns nun dem Spezialfall von lat. *texere* zu:

- (4) lat. *texere* – Ableitungen<sup>6</sup>: *textilis*, *textor*, *textus*, *textūra*, *tēla*, *subtilis*, *extexere*, *praetexta*. Etym. Anknüpfung: heth. *takš-zi* „ersinnen, unternehmen“, mhd. *dehsen* „Flachs brechen“, ai. *tákṣati* „to hammer, form, fashion“ - *táṣtar-* „carpenter, master“, aav. *tāšt* 3.Sg.Inj. „bildet, formt“, *tašta-* „geschaffen“.

Die angeführten, reichhaltigen, durchwegs früh bezugten innerlateinischen Derivate zeigen die feste Verankerung des Ableitungsparadigmas im Fachwortschatz, doch in der Folgeperiode auch in der Standardsprache. *textor* ist der Berufsname, *textilis* das Adjektiv für alle Produkte, *textus* zunächst der vollzogene Prozess, *textūra* das Gewebe, *tēla* (< \**teks-la-*) ist das fertige Tuch, aber auch der Webstuhl. *subtilis* bezog sich auf den feinen Faden bei der Verarbeitung und *praetexta* ist als besonderes Epitheton der Toga sogar zu einem Gattungsnamen des römischen Dramas geworden.

An ursprünglich verwandten Verben nennt das jüngste etymologische Wörterbuch des Lateinischen,<sup>7</sup> wie oben unter (4) vermerkt, Beispiele aus dem Hethitischen, Germanischen und Avestischen. Deren Bedeutungen lassen auf eine zunächst konkrete Werk Tätigkeit schließen, die sich (lat., ahd.) auf die Flachsverarbeitung spezialisiert hat, aber auch schon Ansätze zur semantischen Sublimierung bzw. zu bildlichem Gebrauch (heth., avest.) zeigen.

Wenigstens am Rande möchte ich auf die Diskussion um die rekonstruierte Grundform des lat. Verbums hinweisen, die zuletzt Gerhard Meiser<sup>8</sup> belebt hat. Er bespricht zunächst die traditionelle, auch im LIV<sup>9</sup> vertretene Analyse als \**te-tk-* „erzeugen, herstellen“, bevorzugt aber dann ein Rekonstrukt \**tek-s-* mit wurzelerweiterndem *-s-*, das vielleicht als sekundärer, aus einer Desiderativbildung erwachsener Stamm zu erklären sei. Bei dieser Herleitung bieten sich gr. *τέχνη* (< \**tek-s-nā*) „Fügung, Verfahren“, ahd. *dehsala* „Deichsel, Achse“ und air. *tál* „Axt“ an. Michiel de Vaan<sup>10</sup> tritt zuletzt für eine Wurzelgestalt \**teks-* ein, da sich inlautendes *-tk-* im Lateinischen zu *-s(s)-* (vgl. *ursus* vs. gr. *ἄρκτος*, ai. *ṛkṣa-*) entwickeln sollte.

Meiser geht auch auf eine alte Beobachtung von Darmesteter<sup>11</sup> ein, der in der Junktur dieses Verbums und seiner Derivate mit einem Ausdruck für „Rede, Wort“ als Objekt eine frühe grammatikalisch-poetische Metapher erkennen wollte. Die Beispiele aus dem Vedischen und Griechischen (ved. *vácāṃsi* ... *takṣam*, RV 6,32,1; gr. *ἑπέων* ... *τέκτονας*, Pind. Pyth. 3,199) lassen für das Verbum an eine Bedeutung „zimmern“ denken, das avestische Kompositum *vacastašti-* „Strophe, Hymnentext“ weist bereits auf eine Verfestigung zum Terminus technicus der Poetik hin. Für die folgende Plautusstelle, in der *sermones* die Objektstelle besetzt (*quamvis sermones possunt longi texier* Plaut. Trin. 797, „wiewohl lange Reden gefügt/gewoben werden können“), bieten sich zwei

5. Zitiert nach Grimm 1860, s.v. *dichten*.

6. Nach de Vaan 2008, 619 s.v.

7. Vgl. Fn. 5.

8. Vgl. Meiser 1998, 96f; 2003, 126f.

9. Vgl. Rix *et al.* 2001.

10. Vgl. Fn. 6.

11. Vgl. Darmesteter 1883 in deutscher Übersetzung bei Schmitt 1968, 26-29.

Erklärungswege an: entweder ist die Fügung vor der Spezialisierung des Verbums zur Semantik „weben“ entstanden, oder das Syntagma ist insgesamt als Textilmetapher zu verstehen. Die letztere Lösung hätte vielleicht den Vorzug, dass in diesem Fall *sermō* als Ableitung von *serere* „reihen, knüpfen“ ursprünglich auf eine anschauliche Lesart hindeutet.

Als Stellen, die bereits den Übergang des handwerklichen Vokabels zu einer bildlichen Verwendung für sprachliche Vorgänge markieren, empfehlen sich die drei lateinischen Beispiele unter (5):

- (5) Cic.Fam. 9.21.1: *epistulas ... cotidianis verbis texere*; Cic.Qu.fr. 3.5/6.1: *sermo ... in novem et dies et libros distributus ... de optimo cive (sane texebatur opus luculente)*; [Quint.] Decl. 3B.2: *ita callidissimus actor orationem suam ordinavit et texuit, ut ... tribunum impudicitiae criminetur*.

Im Brief Cic.Fam. 9.21.1 verwendet der Autor eine Konstruktion *epistulas ... texere* für den Prozess einfacher verbaler Verknüpfung; im Schreiben an seinen Bruder Cic.Qu.fr. 3.5/6.1 wird ein auf neun Tage und Bücher verteilte *sermo* als *texebatur opus* resümiert. In einer pseudoquintilianischen Schrift ([Quint.] Decl. 3B.2) erweisen bereits die beiden verbundenen Verben *ordinavit* „gliederte“ und *texuit* „verknüpfte“ neben dem Objekt *orationem*, dass das Sprachbild schon zur unmarkierten Ausdrucksweise verallgemeinert worden bzw. verblasst ist. Übrigens findet sich auch beim litauischen Verbum *áusti* „weben“ eine Tendenz zur metaphorischen Verwendung, die allerdings leicht pejorativ gefärbt ist und nur in spöttischem Jargon auftritt: „Geschwätz, Lügenreden, Phantasien“ sind die typischen nominalen Ergänzungen.

Das Nomen acti *textus* ist in der lateinischen Literatur gut belegt, hat aber über einen langen Zeitraum seine fachsprachliche Lesart konsequent bewahrt. Als Schaltstelle für die zunächst bildliche, später terminologische Verwendung, in der sich der Ausdruck in allen germanischen sowie romanischen Sprachen,

später auch als internationales Vokabel durchgesetzt hat, bietet sich ein Beleg aus Quintilian an:

- (6) Quint.Inst. 9.4.13: *verba eadem qua compositione vel in textu iungantur vel claudantur*.

In dieser Passage wird die kontextspezifische Geltung angesprochen und die Anwendung auf Wortverbindungen erörtert. Ich verweise auf den unter (6) zitierten entscheidenden Teilsatz innerhalb einer längeren Periode: „In welchem Zusammenhang (*qua compositione*) dieselben Wörter (*verba eadem*) entweder im Gewebe (scil. textlich eingebettet) verbunden werden (*textu iungantur*) oder als Klausel am Satzende auftreten (*claudantur*).“<sup>12</sup>

Im mittellateinischen Schrifttum wird die eben besprochene Bedeutung und Verwendung von *textus* als bald ganz üblich, was wenigstens an drei Beispielen aus Urkunden bzw. Protokollen belegt sei:

- (7) „Urkunde“: *donationum nostrarum textus ostendant; de venditione quam textus iste continet*; „Evangeliar“: *dedit rex quatuor evangeliorum librum qui textus dicitur*.<sup>13</sup>

An den ersten beiden Stelle handelt der ‚Text‘ von einer Schenkung bzw. einem Verkauf (*de venditione*), während der andere Beleg einen Evangeliar im prägnanten Wortsinn *textus* nennt.

Wie die unter (8) stehenden Beispiele erweisen, treten bisweilen zwei konkrete handwerkliche Tätigkeiten, nämlich *weben* und *kneten*, als Metaphernspender in Konkurrenz zueinander:

- (8) lat. *ingere* mit gutem idg. Anschluss (ai. *deh-*, arm. *dizanem*, got. *digan*, toch. *tsik-*; gr. *τεῖχος*, got. *daigs* u.a.

Das gilt im Lateinischen etwa für *texere* und *ingere*. Das Verbum *ingere* „kneten, plastisch formen“ hat sich als technischer Ausdruck für die Verarbeitung von Lehm, also Tonerde etabliert, was auch Ableitungen wie *figulus* „Töpfer“, *figūra* „aus Ton gebildete Gestalt“ und *effigiēs* „geformtes Bild“ bezeugen.

12. Eine grundlegende Studie zur metaphorischen Verwendung des Sinnbezirks von Weben und Flechten in den klassischen Sprachen hat Wagner-Hasel (2005) vorgelegt.

13. Vgl. Niermeyer & van de Kieft II, 2002, 1341.

Das Etymon ist in den indogermanischen Einzelsprachen weit verbreitet, was die oben zitierte Auswahl an Belegen bezeugt. Wie eine Grundbedeutung lexikalisch verschieden aufgefächert wird, zeigt sich u.a. in der Gegenüberstellung von gr. *τείχος* „Mauer“, *τοιχος* „Wand“ und got. *daigs*, dt. *Teig*, denen das gleiche ursprüngliche Muster eines plastischen Gebildes aus Lehm zugrunde liegt.

Betrachtet man die Wortgeschichte von *ingere* im Detail, so führt der Weg der Bedeutungsentwicklung von „kneten“ über allgemein „plastisch gestalten“ (mit bereits künstlerischer Ambition) zu verbalem „dichten, ersinnen“ und schließlich pejorativem „lügen“. Alte Derivate wie *figulus* oder *figūra* haben diesen semantischen Prozess nicht mitvollzogen; jüngere- auch als Fremdwörter geläufige - Ableitungen wie *fictiō* oder *fictīvus* hingegen begegnen in beiden Richtungen und mit den gleichen Resultaten als „(Er-) Dichtung“ wie als „Lüge“.<sup>14</sup>

In der Diskussion über die Rekonstruktion einer indogermanischen Dichtersprache spielt eine Wendung aus Toch. A, auf die Wilhelm Schulze in einem Aufsatz erstmals hingewiesen hat,<sup>15</sup> eine wichtige Rolle: In einem Text, der ein wenig an den Mythos von Pygmalion und Galatea erinnert, wird eine Phrase *tseke ši peke ši pat arämpāt*, die sich als eine Junktur mit Reimwörtern präsentiert, zur Bezeichnung von plastischer und malerischer Gestaltung (*tseke ši peke ši*) und künstlerischer Schönheit (*arämpāt*) verwendet. Etymologisch wie idiomatisch kann man diese festgefügte Wendung mit lat. *figura vel pictura* paraphrasieren.

Gewebe, Kleider, Tücher und andere Textilien spielen auch in einer verbreiteten Textsorte bzw. einem Typus literarischer Darstellung eine Rolle, der unter dem Terminus *Ekphrase* kursiert. Als berühmtestes Beispiel und Vorbild für viele spätere Varianten gilt die Schildbeschreibung im 18. Gesang (V. 468-608) der homerischen Ilias. Hephaistos hat auf Bitte von Thetis ihrem Sohn Achilleus eine neue Rüstung geschmiedet, da Patroklos als sein Stellvertreter in der Schlacht ums Leben gekommen war und

die ursprünglichen Waffen des Helden an Hektor verloren hatte. In einem weitgespannten narrativen Bogen beschreibt der Dichter den bildlichen Schmuck der Waffe, auf der eine Reihe von Szenen geradezu einen visuellen Kosmos erzeugt. Wesentlich an dieser Art der literarischen Darstellung ist die erzählerische Verselbständigung der Textsorte und ihre Ablösung von plausiblen realen Vorstellungen. Wir dürfen daher als Leser nicht fragen, wie groß denn eigentlich das Objekt sein muss, um allen erwähnten Vorgängen und Milieus überhaupt Platz zu bieten. Das sprachliche Kunstwerk löst sich von der Funktion einer Beschreibung optischer Eindrücke ab; es wird autonom und begründet eine eigene literarische Gattung. Der homerische Archetyp hat nach mehreren Richtungen ausgestrahlt und in zahlreichen Beispielen fortgewirkt, von denen ich in diesem Rahmen nur drei erwähnen möchte:

- Als Schildbeschreibung spiegelt sich das große Vorbild in einer analogen Episode der Aeneis Vergils, in der die entsprechende Schutzwaffe des Titelhelden mit den Stilmitteln der epischen Tradition dargestellt wird<sup>16</sup>.
- In einem Chorlied der euripideischen Tragödie *Ion* zeigen sich die Frauen des Kollektivs von den ästhetischen Eindrücken und bildlichen Details begeistert, die ihnen die Metopen, Friese, Säulenkapitelle und anderen Architekturelemente des Apollontempels von Delphi vermitteln.<sup>17</sup>
- In einem von mir als Student der Universität Wien erlebten Vortrag hat der Gräzist Joannis Theophanes Kakridis aus neugriechischer Volksdichtung die Ekphrase eines kunstvoll gewebten Teppichs nacherzählt, in der in gut homerischer Tradition Ensembles, Situationen, Konstellationen, ja ganze Handlungszüge in den materiellen Gegenstand als dekorative Elemente einbezogen sind. Auch und gerade bei einem solchen physisch begrenzten Kunstobjekt ist die Frage nach der Plausibilität redundant, ja verfehlt: es handelt sich demnach gerade nicht um einen überdimensionalen Zierrat,<sup>18</sup>

14. Vgl. Panagl 1992, 307-320, bes. 318-320.

15. Vgl. Schulze 1933 in Schmitt 1968, 34-39.

16. Vgl. Aeneis VIII, V. 608-731; in: Binder & Binder 2001.

17. V. 185-235, in: Seeck & Buschor 1972, 238-242.

sondern das narrative Genre behauptet sich vor und gegenüber den gegenständlichen Fakten.

Zu diesem Typus zählt auch die Dichtung, aus der ich in der Folge einige Verse zitiere und interpretiere. Das Carmen 64 des römischen Lyrikers Catull ist ein Epyllion, das sich mit der Hochzeit von Peleus und Thetis, also eines Sterblichen mit einer Göttin, beschäftigt. Da die beiden Brautleute später die Eltern von Achilleus werden, stiftet der Text personell gleichsam eine mittelbare Verbindung zum homerischen Muster. Das ungewöhnliche Ereignis wird im Erzählduktus mit allem Pomp begangen; auch die olympischen Götter erscheinen als geladene Gäste, wobei das Erscheinen von Zeus-Juppiter eine erzählerische Pointe darstellt. Denn immerhin war er einst selbst als Freier um die Hand der schönen Meeresgöttin bemüht, hatte aber auf den Rat der Moiren/Parzen hin von diesem Vorhaben abgesehen. Gemäß einer Prophezeiung drohte ihm nämlich von einem Sohn aus dieser Beziehung Gefahr: und nach seinem eigenen Verhalten gegenüber seinem Vater Kronos musste der oberste Gott ein gebranntes Kind sein. In die Schilderung des Textes eingebettet ist die Beschreibung eines Kunstwerks, das in den Versen 48-55<sup>19</sup> vorgestellt und in direktem Anschluss bildlich nacherzählt wird.

(9) *Puluinar uero diuae geniale locatur  
Sedibus in mediis, Indo quod dente politum  
Tincta tegit roseo conchyli purpura fuco.  
Haec uestis priscis hominum uariata figuris  
Heroum mira uirtutes indicat arte.  
Namque fluentisono prospectans litore Diae  
Thesea cedentem celeri cum classe tuetur  
Indomitos in corde gerens Ariadna furores,*

„Doch inmitten erhebt sich das bräutliche  
Lager der Göttin,  
Schimmernd von Elfenbein, in Indiens  
Ländern gewonnen,  
Und darüber sich breitet ein purpurfarbener  
Teppich.

Mannigfache Gestalten der Vorzeit, Taten von  
Helden

Zeigte in vielerlei Bildern der kunstvollendete  
Teppich:

Sorgsam späht Ariadne von Naxos<sup>4</sup>  
flutenumrauschem

Strande hinaus in die See nach Theseus<sup>4</sup>  
fliehenden Schiffen,

Und unendlicher Kummer ihr Innres aufs  
tiefste erschüttert.“<sup>20</sup>

In epischer Breite wird sodann die Geschichte von Theseus und Ariadne in Gestalt einer Ekphrase wiedergegeben. Die Aussetzung der Heroine auf der Insel Dia/Naxos gipfelt in einer weitgespannten Klagerede von 70 Versen, die später zum Vorbild der zahlreichen *Lamenti di Arianna* in Oper und Oratorium geworden ist. Die endliche Befreiung, Erlösung und Tröstung durch den Gott Bacchus/Dionysos/Iacchus fehlt auch in dieser Fassung nicht, doch wird ihr nur ein bemerkenswert knapper Raum zugestanden, und das wohl aus künstlerischen Gründen: entweder weil die erhabene Frau als trauernde Gestalt im Zentrum bleiben sollte oder gleichsam aus kunstökonomischen Gründen, indem auf die Bildbeschreibung ohnehin erneut der Festesjubiläum folgt, der sich an die Verse 265f. anschließt:

(10) *Talibus amplifice uestis decorate figuris  
Puluinar complexa suo uelabat amictu.*

„Mit solchen Gestalten verschwenderisch  
geziert war die Decke,  
die das Lager rings als Überwurf umhüllte.“

Nur am Rande erwähnen möchte ich eine andere Variante bildlicher Darstellung eines Geschehens, das sich zur Ekphrase gewissermaßen spiegelverkehrt verhält. Hatte diese die visuellen Eindrücke von plastisch oder malerisch gestalteten Vorgängen in Worte umgesetzt, so vertritt im folgenden Fall eine nonverbale Botschaft den vereitelten Bericht. Es geht um den Mythos von König Tereus, der Philomele, die Schwester seiner Gattin Prokne vergewaltigt und ihr,

18. So neuerdings die volksetymologisch motivierte („Zier-rat“), offizielle Rechtschreibung des Nomens, das eigentlich eine suffixale Ableitung (wie *Armut* oder *Kleinod*) von der Basis *zier-* darstellt.

19. Zitiert nach Holzberg 2009.

20. Übersetzung nach [http://www.deutsche-liebeslyrik.de/europaische\\_liebeslyrik/catull.htm](http://www.deutsche-liebeslyrik.de/europaische_liebeslyrik/catull.htm).

damit sie die Untat nicht anzeigen kann, die Zunge herauschneidet. In ihrer Verzweiflung macht die geschändete Frau ihre Misshandlung bekannt, indem sie die erlittene Schmach als Vorgang in ein Tuch stickt. Die Sage endet mit einer mehrfachen Verwandlung: Tereus wird zum Wiedehopf, Prokne zur Nachtigall, Philomele aber zur Schwalbe, da deren unartikulierte Tongebung dem antiken Ohr unangenehm und wie eine lautliche Verstümmelung klingen musste. Apollodor (3,193ff.) und Pausanias (1,41,8) teilen in mythographischer Darstellung das sagenhafte Geschehen in dieser Variante mit. Die römische Literatur hat in ihrer Version der Metamorphose<sup>21</sup> die Rollen getauscht: In dieser Fassung und in den späteren Traditionen wird Philomela (so die lateinische Wortform) zur Nachtigall, deren Gesang man - man denke nur an die romantische Dichtung - den Gestus von Sehnsucht, Trauer und Klage unterlegte.

Mit der Deutung der folgenden Sequenz überschreite ich den Referenzzeitraum der Tagung und ihrer Dokumentation, freilich nicht so stark, wie es auf den ersten Blick den Anschein haben mag. Denn Richard Wagner hat sich in der Dichtersprache seiner Musikdramen, besonders aber im Zyklus *Der Ring des Nibelungen* die frühdeutsche und altnordische Epik anverwandelt, stilistische Figuren zitiert oder imitiert und archaische Metaphern aufgegriffen, allerdings zusätzlich pointiert und mit den Merkmalen seiner eigenen poetischen Diktion angereichert. Im zweiten Aufzug von *Siegfried* greift der Dichterkomponist das alte Motiv der sprechenden und weissagenden Tiere auf. Der Waldvogel, der den jungen und naiven Titelhelden vor bösen Nachstellungen warnt, ihm die Wirkung der erbeuteten Objekte Ring und Tarnhelm enthüllt und dazu künftiges Liebesglück verheißt, fasst die Ambivalenz seines eigenen Wesens und Wirkens in einem schönen Sprachbild zusammen, das in seinem zweiten Teil das Thema dieser Konferenz im Wandel von Gewebe zum Text auf den Punkt bringt (II, 3):

(11) *Lustig im Leid sing ich von Liebe.  
Wonnig aus Weh 'web ich mein Lied:  
nur Sehrende kennen den Sinn.*

21. Vgl. Ovid: *Metamorphosen*, VI, 412-674.

22. Vgl. Panagl 2014, 1-25, bes. 23f; 2015, 272-283, bes. 279.

An mehreren Stellen meiner Auseinandersetzung mit Dramaturgie, Mythenrezeption und Sprachkunst des Bühnenschaffens von Richard Wagner habe ich mich mit dieser und vergleichbaren Passagen seiner Dichtersprache auseinandergesetzt.<sup>22</sup>

Wie produktiv der metaphorische Wirkungsreich von Webstuhl und Spinnwirtel auch und gerade unsere heutige Zeit geblieben - oder vielleicht wieder geworden - ist, mag zum Ausklang eine keineswegs vollständige Liste von englischen Fachtermini belegen, die drei einschlägige Ausdrücke unseres Forschungsgegenstandes (*weben*, *spinnen*, *Netz*) aufgreifen und zu verbindlichen technischen Begriffen des internationalen Wortschatzes der neuen elektronischen Medien verfestigen:

(12) *web address, on the web, web based, web browser, web designer, webcast, web forum, webhead, webmaster, web page, web-site; spin doctor; network, internet, net speak*

Dass dabei auch das Randgebiet der Augenblicksbildungen mit eingeschlossen ist, zeigt das letzte Beispiel der Liste, denn *net speak* wird von rezenten Wörterbüchern des Englischen unter Hinweis auf den Funktionalstil als informelle Bezeichnung des Internetjargons gebucht.

## Bibliographie

- Beekes, R. (2010) *Etymological Dictionary of Greek II*. Leiden.
- Binder E. & G. (2001) *Aeneis: lateinisch - deutsch / P. Vergilius Maro*. Stuttgart.
- Buck, C. D. (1949) *A dictionary of selected synonyms in the principal Indo-European languages: a contribution to the history of ideas*. Chicago.
- Bußmann, H. (2002) *Lexikon der Sprachwissenschaft*. Stuttgart.
- Darmesteter, J. (1968) *Eine grammatikalische Metapher des Indogermanischen*. In R. Schmitt (1968), 26-29.
- De Vaan, M. (2008) *Etymological dictionary of Latin and the other Italic languages*. Leiden.

- Falk, H. S. & Torp, A. (1960) *Norwegisch-dänisches etymologisches Wörterbuch : mit Literaturnachweisen strittiger Etymologien sowie deutschem und altnordischem Wörterverzeichnis. II.* Oslo - Bergen.
- Fraenkel, E. (1962) *Litauisches etymologisches Wörterbuch I.* Heidelberg.
- Frisk, H. (1970) *Griechisches etymologisches Wörterbuch II.* Heidelberg.
- Grimm, J. & W. (1991=1860) *Deutsches Wörterbuch.* München.
- Holzberg, N. (2009) *Catullus, Gaius Valerius: Carmina = Gedichte : lateinisch - deutsch.* Düsseldorf.
- Kluge, F. / Seebold, E. (2002) *Etymologisches Wörterbuch der deutschen Sprache.* Berlin.
- Matasović, R. (2009) *Etymological Dictionary of Proto-Celtic.* Leiden.
- Meiser, G. (2003) *Veni Vidi Vici: die Vorgeschichte des lateinischen Perfektsystems.* München.
- Meiser, G. (1998) *Historische Laut- und Formenlehre der lateinischen Sprache.* Darmstadt.
- Niermeyer, J. F. & van de Kieft, C. (2002) *Mediae latinitatis lexicon minus = Lexique latin médiéval = Medieval Latin dictionary = Mittellateinisches Wörterbuch. Éd. remaniée par J. W. J. Burgers.* Darmstadt; Leiden.
- Panagl, O. (1992) Bedeutungswandel, relative Chronologie und Ableitungsparadigmen im Lichte lateinischer Daten. In R. Beekes et al., *Rekonstruktion und relative Chronologie. Akten der VIII. Fachtagung der Indogermanischen Gesellschaft, Leiden, 31. August - 4. September 1987.* Innsbruck, 307-320.
- Panagl, O. (2014) „Die Tonsprache ist Anfang und Ende der Wortsprache“ Zur Diktion der Opern und Musikdramen Richard Wagners. In *Die Musikforschung* 67. Jahrgang, 1-25.
- Panagl, O. (2015) „Lustig im Leid sing' ich von Liebe“ Richard Wagners Siegfried - beim Wort genommen. In U. Müller & O. Panagl (eds.), *Von der Wartburg nach Walhall. Studien zum musikdramatischen Werk Richard Wagners*, 272-283. Anif/Salzburg.
- Rix, H. (2001) *Lexikon der indogermanischen Verben: LIV; die Wurzeln und ihre Primärstammbildungen.* Wiesbaden.
- Schulze, W. (1933) *Tocharisch tseke peke.* In R. Schmitt, 34-39 (1968).
- Schmitt, R. (1968) *Indogermanische Dichtersprache.* Darmstadt.
- Seeck, G. A. (1972) *Sämtliche Tragödien und Fragmente: griechisch - deutsch / Euripides. Übers. von Ernst Buschor.* München.
- Vasmer, M. (1958) *Russisches etymologisches Wörterbuch III.* Heidelberg.
- Von Albrecht, M. (ed.) (2010) *Ovidius Naso, Publius: Metamorphoses Metamorphosen: lateinisch - deutsch.* Stuttgart.
- Wagner-Hasel, B. (2005) Textus und texere, hýphos und hyphaínein: Zur metaphorischen Bedeutung des Webens in der griechisch-römischen Antike. In L. Kuchenbuch & U. Kleine (eds.), *Textus im Mittelalter. Komponenten und Situationen des Wortgebrauchs im schriftsemantischen Feld.* Göttingen, 15-43.

## Weaving a Song. Convergences in Greek Poetic Imagery between Textile and Musical Terminology. An Overview on Archaic and Classical Literature<sup>1</sup>

Giovanni Fanfani

εἰ γὰρ ἠδύνατο ἕκαστον τῶν ὀργάνων κελευσθὲν ἢ προαισθανόμενον ἀποτελεῖν τὸ αὐτοῦ ἔργον, ὥσπερ τὰ Δαιδάλου φασὶν ἢ τοὺς τοῦ Ἥφαίστου τρίποδας, οὓς φησὶν ὁ ποιητής αὐτομάτους θεῖον δύεσθαι ἀγῶνα, οὕτως αἱ κερκίδες ἐκέρκιζον αὐταὶ καὶ τὰ πλῆκτρα ἐκιδάριζεν, οὐδὲν ἂν ἔδει οὔτε τοῖς ἀρχιτέκτοσιν ὑπηρετῶν οὔτε τοῖς δεσπόταις δούλων.

Arist. *Pol.* 1253b34-1254a1

For if each tool could perform its own task either at our bidding, or anticipating it, and if – as they say of the artefacts made by Daedalus or the tripods of Hephaestus, of which the poet says, “self-moved they enter the assembly of the gods” – weft-beaters should beat the weft of their own accord, and plectra should pluck the *kithara* of themselves, then master-craftsmen would have no need of assistants and masters no need of slaves.<sup>2</sup>

In an analysis of the household-management (οἰκονομία) in the first book of the *Politics*, Aristotle discusses the nature and use of tools (ὄργανα), both inanimate (τὰ ἄψυχα) and animate (τὰ ἔμψυχα). While such a distinction is functional, in Aristotle’s argument, to illustrate the priority of the latter group (represented by the assistant, ὁ ὑπηρετής, and the slave, ὁ δοῦλος)

over the first,<sup>3</sup> what interests us here lies mainly within the realm of inanimate tools. As commentators to the passage have not failed to notice, a first literary frame of reference for Aristotle’s *exemplum fictum* is to be found in the conflation of two motifs: the myth of self-moving (ἄντοματα) artefacts created by divine or divinely-gifted craftsmen (Hephaestus’ wheeled tripods

1. I would like to thank the three editors for both their work on this volume and for the organization of the conference in Copenhagen back in June 2014; I am grateful to the Danish National Research Foundation’s Centre for Textile Research for hosting my postdoctoral research in the last two years in a stimulating environment. Deborah Steiner, whom I sincerely thank, has generously given me access to a draft version of a forthcoming discussion of hers on weaving and chorality. The research for this chapter has been generously supported by the Danish Council for Independent Research and FP7 Marie Curie Actions – COFUND (DFE – 1321-00158) through a MOBILEX grant.

Greek texts are quoted from the most recent OCT (Oxford Classical Texts) editions, unless otherwise stated. English translations are adapted from the most recent Loeb editions. Double quotation marks are only used for direct quotations (in translation) of passages from classical authors and for quotations of modern scholars; single quotation marks are adopted in all other cases.

2. Translation: Saunders 1995, adapted.

3. A further, significant distinction is operated by Aristotle between assistant and slave: while the first can be defined as “a superior tool among tools” (ὄργανον πρὸ ὀργάνων, 1253b33, literally “a tool that is prior to/outperforms other tools”: see Barker 1961, 10 n.1; Newman 1950, 138; on πρὸ as conveying here a notion of superiority in status see Schüttrumpf 1991, 244-245; on the whole passage see now Besso & Curnis 2011, 226-228), the slave is rather “a sort of animate possession” (κτῆμά τι κτήσις, 1253b32), granted that “a possession is also a tool for the purpose of life” (καὶ τὸ κτῆμα ὄργανον πρὸς ζωὴν ἐστί, 1253b31).



and Daedalus' statues),<sup>4</sup> and the Old Comedy utopia of a golden age when no slaves were needed, as household utensils would move and perform their task by themselves.<sup>5</sup> In addition to that, however, a further underlying element that joins together the τέχνη (crafts) alluded to in the *Politics* passage can be detected in the relationship these entertain with the concept (*cum* technology) of weaving, reflected at the level of poetic imagery by patterns of textile terminology. This may seem pretty obvious in the case of the verb κερκίζειν, *i.e.* the action of beating the weft threads into place by means of a weft-beater (κερκίς).<sup>6</sup> As a fundamental principle in the mechanics of weaving on the vertical warp-weighted loom, striking the threads with a κερκίς had a distinctive visual and acoustic dimension: it was one of the most typical gestures of the weaver, and, more important, it seems to have produced a

recognizable rhythmic sound. Both these features explain, to a certain degree, why in a number of literary as well as iconographic sources the technique of striking the strings of a *lyra* or *kithara* with a plectrum (κιθαρίζειν is the verb used in *Politics* 1254a1) is assimilated to the act of hitting and strumming threads on a loom with a weft-beater.<sup>7</sup> Aristotle's juxtaposition of κερκίδες and plectra is a case in point: while the focus is kept on the similar function performed by the two objects in the realm of their respective (and thus comparable) τέχνη,<sup>8</sup> the passage may, if only indirectly, reflect the long-standing association in ancient Greek musical imagery between the craft of weaving and the craft of playing (mainly stringed) instruments. At the root of this connexion lies a terminological convergence grounded on the semantics of the verb κρέκειν ('to weave', 'to pluck the strings, play' and 'to cause

4. Aristotle quotes from *Il.* 18.376: the passage (vv. 373-377) describes Hephaestus who "was fashioning tripods, twenty in all, to stand around the wall of his well-built hall, and golden wheels he had set beneath the base of each so that of themselves they could enter the assembly of the gods (ἄφρα οἱ αὐτόματοι θεῶν δυσαιάτ' ἀγῶνα), a wonder to behold". As it happens, the elaborate tripods' handles have a 'daedalic' connotation (οὐατα ... δαιδάλεια, v. 378-379): see below on the series δαιδάλεος, δαίδαλον and δαιδάλλω. For Daedalus as "human double of Hephaestus" see Power 2011, 78 and n. 29, in the context of a fine discussion of the choral features of Hephaestean and Daedalic automata (77-82). The reference works on Daedalus in Greek literature and art are Frontisi-Ducroux 1975 and Morris 1992; McEwen 1993 brings architecture into the picture.
5. Several Old Comic passages on the topic are collected by Athenaeus in a section on slavery in the sixth book of his *Deipnosophistai* (267e-270a); a fragment from Crates' *Beasts* (Θηρία), fr. 16 K-A = Ath. 267e, explicitly connects needlessness of slaves and self-moving household equipment (τὰ σκευάρια). Interestingly, a number of literary references to Daedalus' moving figures are also found in humorous context in drama (satyr play: Aeschylus *Theōroi* fr. 78.6-7 Radt (*TrGF* vol. 3); Euripides *Euristheus* fr. 372 Kannicht (*TrGF* vol. 5.1); comedy: Aristophanes' *Daedalus*, fr. 191-204 K-A; Cratinus fr. 75 K-A and Plato Comicus fr. 204 K-A, both in Σ Eur. *Hec.* 838) and in Plato (*Euthphr.* 11b-c; *Men.* 97d-e): see the rich discussion in Morris 1992, 215-237. Cf. Besso & Curnis 2011, 229; Newman 1950, 138 *ad loc.*
6. For an excellent discussion of the multiple functions of the κερκίς in ancient weaving see Edmunds 2012, §40-§51; in addition to beating up the weft threads, two further uses of the device were "to even out the warp threads by strumming across them" and "to pick the shed, especially in pattern weaving" (§46). See also Crowfoot 1936-1937, 44-45; Barber 1991, 273-274; Andersson Strand & Nosch 2015. Moxon 2000 surveys the Greek sources on the 'sound of the κερκίς' and argues for a use of the device as a "laze rod" to create the shed(s) in a "properly vertical" loom (p. 25). On the term κερκίς see chapter by Flemestad, Harlow, Hildebrandt & Nosch in this volume.
7. Pomeroy 1978, 19 points out the "physical resemblance between the loom and the lyre", drawing on two vase paintings depicting a woman sitting and weaving on a tapestry hand-loom (fig. 1, 2 p. 22): the posture of the weavers is remarkably similar to that of female string instruments players (fig. 3 p. 22). See McIntosh Snyder 1981, 194-195 on the "structural similarities between looms and lyres" as a key-element in shaping the imagery of the 'web of song' in archaic Greek lyric. For a more nuanced and convincing view see Restani 1995, 99-100: the analogy in the posture between hand-loom weavers and *barbitos*-players is rather meant to recall, metonymically, the auditory experience of (*i.e.* the sound produced by) weaving on the warp-weighted loom. Keuls 1983, 219 argues that the prominence of depictions of hand-loom weavers over warp-weighted looms in vase paintings is the result of them being more "aesthetically pleasing or symbolically meaningful". See Power 2010, 122-134 for an exhaustive discussion of the technical and performative features of both lyre and *kithara*, including the use of the *plēctron*. On the musical terminology related to the *technē* of lyre-playing in the *Homeric Hymn to Hermes*, where the invention of the tortoise-shelled instrument is narrated, see Franklin 2003.
8. Restani 1995, 106 sees the *Politics* passage as an instance of a persistent and effortless "associazione concettuale dell'utensile da telaio con il suono percussivo degli strumenti a corde", thus laying emphasis on the acoustical sphere.

to resound' in the new *GE* s.v.),<sup>9</sup> which has been traced back to the idea of "hitting strings noisily with sharp instruments":<sup>10</sup> literary and lexicographical sources help locating certain stages in the semantic development of the term. In the first part of this chapter, a sustained pattern of interaction between textile and musical terminology is shown through a survey of passages where κρέκειν, or the cognate term κερκίς, occur in musical context in archaic and classical Greek poetry. Perceived similarities in craft, technology and auditory experience seem to favour the exchange; what we also see is the appropriation of the technical lexicon of weaving by emerging discourses on musical innovation in Greek poetry,<sup>11</sup> in the context of the imitative poetics of early lyric as well as in the late 5<sup>th</sup> century BC musical 'revolution', the so-called New Music.<sup>12</sup>

In the second part of this chapter, such a pattern of terminological interaction is positioned within the broader area of textile imagery for poetry-making. Instances of κρέκειν governing an internal accusative of the type of song/poem or musical mode being executed invite comparison with a group of metaphoric metaphors mapping aspects of the crafts of weaving, plaiting and interlacing onto poetic (and musical, the two notions being largely co-extensive in archaic

and classical Greek literature) composition and performance. The metaphorical domain of textile crafts is in turn to be seen as part of the larger system of Greek craftsmanship imagery for poetic creation:<sup>13</sup> this is particularly evident in the case of cross-craft terminology, as a number of weaving metaphors are generated through the semantically marked use of verbs and adjectives that, while being applied to different crafts in the literary record, convey a specific technical meaning when used in a textile-related context. To illustrate the point, a few instances of textile imagery are shown as produced by two families of terms whose roots, δαιδάλ- and ποικιλ-, seem to express the structural and aesthetic quality of an intricate and variegated pattern in association with skilfully craftsmanship.<sup>14</sup> Finally, the juxtaposition of Hephaestus and Daedalus in the *Politics* passage points back to a Homeric case of interaction between δαιδάλ- and ποικιλ- terms, weaving, and choral dancing.

#### **More than beating threads: κρέκειν in (musical) context and the sound of the κερκίς**

In a study of the semantics of κερκ- and κρεκ- terms – a vast cluster of words encompassing material objects,

9. The meaning 'to cause (the voice, a type of song, a musical instrument) to resound' translates the Italian expression 'far risuonare', which renders the interpretation of κρέκειν as ἠχεῖν 'to resound, echo' and (causative, with internal accusative) 'to cause something to resound' by ancient lexicography, see *infra* and cf. Restani 1995, 97; Raimondi 2000, 144-145.
10. So Barber 1991, 273. Specific discussions on κρέκειν: Manessy-Guitton 1977; Dunbar 1995, 426-427 *ad* Aristoph. *Av.* 682-683; Restani 1995, 97-99; Raimondi 2000, 138-146; Rocconi 2003, 35 n. 185.
11. On the rhetoric of innovation in music as a recurrent motif throughout Greek literature see D'Angour 2011, *passim* (184-206 on the discourse of novelty in *mousikē*); Prauscello 2012 on late 6<sup>th</sup> century BC Peloponnesian musicians and Pindar's position within the musical debate of his time. See LeVen 2014, 71-112 on late 5<sup>th</sup> century BC musicians and their strategies of self-presentation, "which included [...] a reinterpretation of the concept of novelty" (73); as she aptly points out, New Music was in fact "only the latest, and the best documented, in a series of [*sc.* musical] revolutions" (83).
12. See Restani 1995, 105-109 on the lexical borrowings from craft (especially textile) terminology by representatives of the New Musical style in tragedy and comedy as a means to describe "il 'traumatico' passaggio a un nuovo tipo di produzione musicale che, lentamente, professionalizzandosi, precisa i propri contorni rispetto alle alter τέχναι" (105). Restani's emphasis on the language of *mousikē* as craft (τέχνη) and on its auditory sphere ("universo sonoro") in both literary sources and later lexicographical systematisation is a line of inquiry that Rocconi 2003 has broadened through a systematic investigation of the semantic processes leading to the formation of a technical lexicon of Greek music: I build here on these scholars' insights to present a different argument.
13. Nünlist 1998, 83-125 surveys and discusses the occurrences of *Handwerk* metaphors in archaic Greek literature: textile imagery (110-118) represents a substantial portion of the whole picture, together with the domain of *Bauwesen* (98-106), where both carpentry and architecture metaphors belong. On craftsmanship imagery and its implications in terms of archaic Greek poetics see Svenbro 1976, 173-212; Gentili 1988, 50-60; Ford 2002, 93-130.
14. In the case of ποικιλ-terms, the focus on the interaction with craftsmanship imagery serves the limited scope of this discussion: in fact, however, it does not exhaust the rich semantics of the root, which often appears in archaic literature in connection with the natural world: see LeVen 2014, 101-105.

plants, and animals (notably birds) – J. Manessy-Guitton detects the basic concept of the two cognate roots in the idea of a sharp, pointed object: thus κερκίς ‘weft-beater’, a sharp tool used to beat up the weft in weaving, generates κρέκειν ‘to beat the weft with a κερκίς’ and (with extension) ‘to weave’; the same basic gesture of ‘beating rhythmically with an object’, analogically applied to the sphere of music-making, would be at the root of the prevalent usage of κρέκειν with the meaning ‘to strike the strings of/play an instrument’ and ‘to cause [the voice, a song] to resound’ *i.e.* ‘to sing’:<sup>15</sup> in such a view, therefore, any notion of sound or noise connected to the semantics of κερκίς and κρέκειν is a derived, and thus secondary connotation.<sup>16</sup> In fact, the assumption that the κερκίς would have produced a sharp sound while beating the warp threads on the warp-weighted loom is supported by two sets of sources: 1) the ancient lexicographical and etymological tradition connecting κερκίς with κρέκειν (= ἠχεῖν) ‘to resound’, and 2) the literary *topos* of the ‘voice of the κερκίς’ (also in the variant ‘melodious κερκίς’), a characteristic sound that we find associated in Hellenistic epigram with singing and crying birds or insects.<sup>17</sup>

The etymological and semantic relationship between κερκίς and κρέκειν is presented by *lexica* and *etymologica* in connection with the earliest occurrence of the verb, Sappho 102 V., a short poem drawing on a traditional motif of popular song:<sup>18</sup>

γλύκηα μάτερ, οὐ τοι δύναμαι κρέκην  
τὸν ἴστον  
πόθῳ δάμεισα παῖδος βραδίναν δι’  
Ἀφροδίταν.

Sweet mother, I really cannot weave  
my web/strike the loom [with the  
κερκίς],  
for I am overcome with desire for a boy  
because of slender Aphrodite.

Object of the infinitive κρέκην (the Aeolic form for κρέκειν) is ἴστος (Aeolic for ἰστός), ‘loom’ or (with semantic extension) ‘web’: for the latter meaning the literary model is Homeric (*Il.* 3.125 ἡ δὲ μέγαν ἴστον ὕφαινε “she was weaving a large web”, cf. also *Od.* 24.139), and one might be tempted to see Sappho’s κρέκην τὸν ἴστον as a variation on the epic hemistich effected through the choice of κρέκειν (Homer uses the more common verb for weaving on the loom, ὑφαίνειν). The only other occurrence of κρέκειν as ‘weave’ is in Euripides’ *Electra*, where the verb governs the accusative πέπλους ‘peploi’ (εἰ δὲ κάκρεκον πέπλους “and even if I had been weaving clothes [lit. *peploi*]”, 542), closely following a mention of κερκίς three lines earlier (κερκίδος ... ἐξύφασμα σῆς “a garment of [*i.e.* woven by] your κερκίς”).<sup>19</sup> Back to Sappho 102 V., the occurrence of κρέκειν has called for semantic and etymological

15. See Manessy-Guitton 1977, 253: “De « battre un chant, scander un chant », serait issu le sens de « faire retentir un chant », de « battre un instrument à cordes » serait issu celui de « faire résonner »”.

16. See Manessy-Guitton 1977, 236-237, 252 (“nous avons vu que κρέκειν signifiait « battre avec un bâton » et que l’idée de « bruit », musical ou non, était secondaire”) and 253, where the relevant κερκ- and κρεκ- terms are grouped in semantic categories.

17. As Raimondi 2000, 138-146 shows through a systematic survey and typology of the occurrences of κρέκειν, such a motif is paralleled by the sustained pattern of imagery, similarly found in the genre of epigram, where κρέκειν designates the sound of singing birds or insects, often with an implied comparison to stringed instruments (this is the type 2<sup>1</sup>, pp. 139-140: the occurrences are Meleager *A.P.* 7.196.6 (cicada), Archias *A.P.* 7.213.3 (cicada), Archias *A.P.* 7.191.3 (jay)); the first author to associate κρέκειν with birds is Aristophanes in the *Birds*, as we shall see. On the sound produced by the κερκίς see Restani 1995, 98-99; Noxon 2000.

18. The motif of the opposition of love (seen as a distracting activity) to weaving is widely attested in a series of dedicatory epigrams in the sixth book of the *Greek Anthology*: see the detailed discussion in Tarán 1979, 115-131. Sappho’s date is problematic, wavering between the last quarter of 7<sup>th</sup> century and the first quarter of 6<sup>th</sup> century BC: see *e.g.* the discussion by Hutchinson 2001, 139-140 and n.1, who proposes 600-570 as the period of the poetess’ activity. A further occurrence of κρέκειν (in the compound form διακρέκειν) in Lesbian context is a papyrus fragment, attributed to Sappho by Lobel and Page (S 99 L-P) and to Alcaeus by Voigt (303A V.), with the sequence χόρδαισιδιακρέκην interpreted by Lobel and Page as χόρδαισι διακρέκην ‘to strike on the strings’: see McIntosh Snyder 1981, 195.

19. The significance of textiles in these lines is given by the context, *i.e.* the exchange between Electra and the Old Man on the return of Orestes (503-544), in which Euripides stages a rationalistic confutation of the famous recognition scene in Aeschylus’ *Choephoroi*. The date of Euripides’ *Electra* is unknown: the range 422-416 BC, proposed by J. Diggle in his OCT edition, seems a safe collocation.

interpretations by ancient lexicography:<sup>20</sup> interestingly, the first line of the poem is quoted, and the meaning of κρέκειν discussed, in the explanation of the lemma κερκίς. The *etymologica* and *lexica* present κερκίς as a noun derived from the verb κρέκειν,<sup>21</sup> which they gloss as ἤχεῖν ‘to resound/echo’: παρὰ τὸ κρέκειν ὃ ἐστὶν ἤχεῖν “(derived) from κρέκειν, that is to resound (ἤχεῖν)”; κερκίς is thus an instrument that resounds (ἢ ἠχοῦσα in Pseudo-Zonaras), and κρέκειν may have originally referred to the sound or noise produced by the κερκίς on the loom, as suggested by Donatella Restani.<sup>22</sup> The occurrence of κρέκειν with internal accusative (τὸν ἴστων ‘loom’ or ‘web’) in Sappho’s poem suggests that the semantic overlap with ἤχεῖν includes the causative meaning of the verb ‘to make/cause something to resound/echo’: in this perspective κρέκειν τὸν ἴστων in Sappho 102 V. may mean “to make the loom resound (with the sound of the κερκίς)”. The idea of a resounding instrument is especially at home in the semantic field of music: Alcman’s compound formation κερκολύρα (*PMGF* 140 = fr. 196 Calame), a one-word fragment, represents the earliest instance (the poet was active in 7<sup>th</sup> century BC) of the long-standing connection between the roots κρεκ-/κερκ- and stringed instruments – a *lyra* in this specific case.<sup>23</sup> The term, preserved by ancient lexicography, is traced back to κρέκειν

(again, through alleged metathesis: ἀντὶ τοῦ κρεκολύρα “in place of κρεκολύρα”) and, according to the equivalence κρέκειν = ἤχεῖν, it describes a “re-sounding, echoing *lyra*” (ἠχητικὴ λύρα in Pseudo-Zonaras): in this explanation, the supposed onomatopoeic nature of κρέκειν is also part of the picture (as Pseudo-Zonaras illustrates in his gloss: τὸ γὰρ κρέκε κρέκε ἦχος ἐστὶ τῆς κιθάρας “for κρέκε κρέκε is the noise of [the strings of] the *kithara*”). Modern interpretations of κερκολύρα entertain the possibility that, in fact, the first component of the term may be κερκίς: the compound would express the functional analogy between the action of the weft-beater on the threads and that of the plectrum on the strings.<sup>24</sup> A more nuanced interpretation locates the fragment within the archaic Greek poetics of *mimesis*: the poet-musician devises and composes through the imitation of nature and other crafts,<sup>25</sup> and Alcman offers indeed early instances of such a conceit when he claims to know “the modes of song of all the birds” (fr. 40 *PMGF* φοῖδα δ’ ὀρνίχων νόμως / παντῶν) and to “have devised verses and song by putting into words the tongued cry of partridges” (fr. 39 *PMGF* φέπε τάδε καὶ μέλος Ἀλκμάν / εὔρε γεγλωσσαμέναν / κακκαβίδων ὄπα συνθέμενος).<sup>26</sup> Though we lack a broader literary context for Alcman’s κερκολύρα, the image of a *lyra* imitating or echoing the

20. In chronological sequence (9<sup>th</sup> to 12<sup>th</sup> century AD): *Etymologicum Genuinum* β p. 183 Miller = *Etymologicum Magnum* 505.57-61; *Etymologicum Gudianum* 316.35 Sturz; Pseudo-Zonaras col. 1190 Tittmann (κερκίς). *Etymologica* and *lexica* only give the first line of the poem; Sappho 102 V. (lines 1-2) is transmitted by Hephaestion in his metrical treatise *Encheiridion* (10.5 p. 34 Consbruch) as an instance of antispastic tetrameter catalectic (scheme ~ ~ ~ ~ / ~ ~ ~ ~ / ~ ~ ~ ~ / ~ ~ ~ ~, where only the second unit has the form of an antispast ~ ~ ~ ~) used by Sappho in her seventh book: on the antispastic and glyconic sequences see Gentili & Lomiento 2003, 154-166.

21. The derivation is explained as a transition from the unattested form κρεκίς (κρεκ- + the nominal suffix -ίς) to κερκίς through internal metathesis (our sources call it ὑπερβίβασμός ‘transposition’). I thank Marco Ercoles for helpful suggestions on the *Etymologicum Gudianum* gloss of κερκίς.

22. Restani 1995, 97: “l’etimo, forse onomatopeico, di tale verbo [*sc.* κρέκειν] si riferirebbe al risuonare, ἤχεῖν, della κερκίς sul telaio”.

23. The testimonia of Alcman 140 *PMGF* are: *Etymologicum Genuinum* s.v. (p. 33 Calame); *Etymologicum Magnum* 506.18 Gaisford; Pseudo-Zonaras col. 1190 Tittman.

24. Cf. Manessy-Guitton 1977, 252, who sees the root κερκ- in κερκολύρα as referring to the plectrum, and the compound thus designating “la lyre dont on joue avec le plectre, la lyre à plectre”.

25. See Restani 1995, 98-99, who interprets Alcman’s κερκολύρα as “a *lyra* echoing the sound of the κερκίς” (p. 99 “una ‘*lyra*’ riecheggiante il suono della *kerkis*”). The poetics of *mimesis* is elaborated by Gentili 1988, 50-54 in relation to the archaic Greek view of poetic creation and music-making: as he puts it, imitation is often presented as “re-creation, through voice, music, dance, and gesture, of the actions and utterances of men and animals” (51).

26. See Gentili 1988, 54: “[I]t is in terms of this poetics – a poetics of heuristic imitation rather than of aesthetic creation – that an author’s reference to the novelty of the modes and techniques found in his own work are to be understood. [...] To “know the songs of all birds” is to have at one’s disposal a full assortment of natural modules to be used in devising melodies”. For the connections of κρέκειν and κερκίς with singing birds (or insects) and stringed instruments in Hellenistic epigram, see note 16 above.

sharp sound of the κερκίς may lie somewhere at the origin of the semantic extension of κρέκειν (in the sense of ἠχεῖν ‘make something to resound’) as to include stringed instruments – a connotation which encompasses as well the more specialised meaning ‘to strike the strings of a musical instrument’.<sup>27</sup> This is reflected by a strand of ancient lexicography that connects κρέκειν to the sphere of instrumental music, often in association with κρούειν ‘to beat, strike’, a verb undergoing a similar semantic extension into the technical language of music-making, with particular regards to the area of stringed instruments.<sup>28</sup> In this respect, the peculiarity of κρέκειν seems to lie in the fact that its semantics is originally grounded in the craft and technical language of weaving, and the terminological convergence with the domain of music reflects an exchange (via *mimesis*) at the level of τέχναι that Alcman’s κερκολύρα may express in terms of musical novelty.

When we meet again κρέκειν in a music-related context, we are in late 5<sup>th</sup> century Athenian drama, at the height of a phase of musical innovations (conventionally labelled as ‘New Music’ in modern scholarship) investing the sung sections of tragedy and comedy, and the lyric genres of dithyramb and kitharodic *nomos*:<sup>29</sup> it is probably not a coincidence, therefore, that three out of four occurrences of κρέκω feature in the lyric sections, both choral and monodic, of the respective drama. The only case where the verb occurs in association to a string instrument is a fragment in

recited verses (iambic trimeters) of the Athenian tragedian Diogenes (*Semele* fr. 1.9-10 *TrGF* vol.1), where κρέκειν ‘strike, pluck the string’ governs the accusative μάγαδιν (a type of harp).<sup>30</sup> Two lyric passages in the *parabasis* of Aristophanes’ *Birds* (staged in 414 BC) exploit the semantic range of the verb and the potential of its connexions with singing birds, as we find κρέκειν associated to the sound of the αὐλός (a wind instrument with double reed) and with the swan’s song. In the opening of the *parabasis* (vv. 676-684), the Chorus of birds sings an invocation to the Nightingale, the archetypal singer-bird, addressed as ὦ καλλιβόαν κρέκουσ’ / αὐλὸν φθέγμασιν ἠρινοῖς “you who cause the fair-toned *aulos* to resound [by playing it] with spring-time tunes” (682-683)<sup>31</sup> – a transparent reference to the αὐλός-player accompanying the singing and dancing of the choral ensemble. In a later section of the *parabasis*, an ode in celebration of the swans’ song depicts how the birds συμμαγῆ βοῆν ὁμοῦ πε- / ροῖσι κρέκοντες ἴακον Ἀπόλλω “vocalizing all together a mingled shout, accompanying it with (the sound of) their wings, celebrated [lit. ‘cried, shouted’] Apollo” (771-772):<sup>32</sup> the wing-beats function here as instrumental and rhythmical accompaniment to the swans’ cry. Parallelism in the syntax of the two passages – similarly structured with κρέκειν + accusative of the instrument/voice that resounds + instrumental dative – is reinforced by diction, with βοή ‘shout’ qualifying both the swans’ cry and, via the epithet καλλιβόας ‘fair-toned’, the αὐλός-sound. The pattern of semantic extension of κρέκειν

27. For a survey of these two semantic areas of κρέκειν, and of further sub-types, see Raimondi 2000, 139-142 (groups 2 and 3).

28. Hesychius s.v. 4044 Schmidt κρέκειν· κιθαρίζει “plays the *kithara*”; *Suda* κ 2367 κυρίως δὲ κρέκειν τὸ τὴν κιθάραν κρούειν “but in most cases κρέκειν (means) to strike the *kithara*”; Pollux 4.63 lists κρέκειν among “instruments that strike/beat” (ὄργανα τὰ κρουόμενα) together with κιθαρίζειν, ψάλλειν (‘pluck the strings with fingers’) and others: see the fine observations by Restani 1995, 107; on the semantic extension of ψάλλειν and κρούειν into the technical terminology of music see the comprehensive discussion by Rocconi 2003, 26-51: the pattern seems to be one of extension and abstraction within the domain of musical, from the more specific meaning ‘strike the strings of an instruments with a plectrum’ to ‘play an instrument’.

29. On the socio-economic context that favoured the rise of New Music in theatrical genres see Csapo 2004; cf. Csapo 1999-2000 on Euripides and New Music; LeVen 2014 is the most comprehensive study of late 5<sup>th</sup> century lyric.

30. See Rocconi 2003, 27 n. 124 for a different interpretation of *magadis* here as a kind of musical accompaniment (“più che uno strumento, [...] una pratica di responsione tra due fonti sonore”), suggested by the musical context of the fragment, a description of rituals connected to the Asian cult of *Semele*, where at v. 9 two other instruments of the harp family are mentioned, the *πηκτίς* and the *τρίγωνος* (on which see Gentili & Lomiento 2003, 85). The passage is transmitted by Athenaeus 14.636, who quotes the verses to argue that Diogenes considered *πηκτίς* and *μαγαδῖς* two different instruments.

31. The text of *Birds* is quoted from Dunbar 1995. The Loeb translation (by J. Henderson) tries to restore the textile semantics of the verb: “weaver of springtime tunes on the fair-toned pipes”. The opening section of the *parabasis* is an astrophic system in aeolochoriambic metre (682-683 are both glyconics). See Dunbar 1995 *ad loc.*

32. Translation Dunbar 1995, 427; see commentary *ad loc.*

in the two Aristophanic passages has been explained in different ways. Raimondi sees a derivation of the meaning ‘play a wind instrument’ from the broader connotation of κρέκειν = ἤχεῖν as applied to the vocal expression (‘to make a voice resound’, ‘to sing’).<sup>33</sup> Locating the original semantics of κρέκειν in the concept of ‘beating, striking with a beating tool’, Manessy-Guitton proposes to set the image of the wing-beats accompanying the swans’ song in *Birds* 771-772 against its textile counterpart, the beating action of the κερκίς on the loom that provides the rhythm for the weaver; the direction of the semantic extension is in this case ‘to beat, to rhythm a song with a beating instrument’ → ‘to make a song resound’, and a similar development invests the specific meaning ‘to strike a stringed instrument’ to encompass the use of κρέκειν in reference to other families of instruments.<sup>34</sup> While a similar pattern of semantic extension – from the domain of stringed instrument to that of the αὐλός – has been illustrated as taking place in the same chronological range for another verb meaning ‘to strike, beat’, κρούειν,<sup>35</sup> the distinctive textile background of κρέκειν may add to the texture of imagery of the two passages from the *Birds*. The same syntactic structure, in reference to the sound of the αὐλός, is found in a fragment of a ‘New Musician’, the dithyrambographer Telestes (late 5<sup>th</sup> century BC), where a weaving verb, ἀμφιπλέκειν ‘to plait/weave around’, is used in place of κρέκειν: the passage, quoted by Athenaeus (14.617b = *PMG* 806), depicts the “Phrygian king of the fair-breathing holy *auloi*”, probably Olympus, as the first “who fit

together (Λυδὸν ἄρμοσε ... νόμον) the Lydian tune, rival of the Dorian Muse, weaving around (ἀμφιπλέκων) his reeds of quick-moving forms (αιολομόρφοις καλάμοις) the fair-winged breeze of his breath (πνεύματος εὐπτερον αὔραν)”.<sup>36</sup> As Pauline LeVen has recently pointed out, a distinctive stylistic feature of the New Music that emerges in Telestes’ archaeology of *aulos*-music of fr. 806 is the innovative exploitation of “the materiality of language to evoke musical features”:<sup>37</sup> the ‘breeziness’ connected to the art of playing the αὐλός is expressed through paronomasia at v. 4 (in the consonantal roots of the terms for ‘breathe’, ‘wing’ and ‘weave’ πνεύματος εὐπτερον ... ἀμφιπλέκων), and through the metaphor of the winged and volatile nature of Olympus’ breath.<sup>38</sup> The archaizing rhetorical strategy of Telestes, who traces back the intricacy of his style of αὐλός-playing to the invention of the Lydian mode by the mythical musician Olympus, is one of self-legitimation: by adopting the technical term ἀμφιπλέκειν ‘to weave/plait around’ to illustrate the variegated and composite nature of the Lydian νόμος, Telestes may have in mind the use of another compound of πλέκειν ‘plait, weave’ in a similar context (a previous musical revolution investing αὐλός-music) in a victory ode by Pindar.<sup>39</sup> In *Pythian* 12 (performed in 490 BC), an epinician ode in celebration of a victory in the *aulos* competition by Midas of Acragas, Pindar describes the invention of the αὐλός-music by the goddess Athena.<sup>40</sup> The poem begins with an invocation to Acragas (the Sicilian city), requested to receive Pindar’s choral song as a crown of victory (στεφάνωμα) from Pytho, and to

33. See Raimondi 2000, 145: “l’espressione vocale è assimilata all’emissione di uno strumento a fiato”.

34. See Manessy-Guitton 1977, 236-237, who sees in the occurrence of κρέκειν ‘to weave’ governing πέπλους at Eur. *El.* 542 a similar case of semantic extension from the original connotation of the verb as ‘strike the weft-threads’.

35. See the exhaustive discussion by Rocconi 2003, 32-43, esp. 35 n. 180 (on *PMG* 878 where κρούειν is found together with ἀυλεῖν ‘to play the *aulos*’).

36. Translation: LeVen 2014, 104 adapted; the reading νόμον αιολομόρφοις at v. 3 is the result of two conjectures (Dobree and Wilamowitz respectively): the manuscript reads νομοαίολον ὀρφναι. See the discussion of the fragment in LeVen 2014, 113-15 in the context of the New Musicians’ self-presentation of their intricate musical style as variegation (*poikilia*) through reference to different musical modes (the Lydian and the Dorian in Telestes 806 *PMG*). See Steiner 2013, 190-191 for a discussion of the technical aspects of *aulos*-playing mentioned in Telestes’ fragment, and for the fascinating hypothesis that the dithyrambographer may allude in the final verse to an actual change in the shape of the mouthpiece of the *aulos*, which would have taken place in the late 5<sup>th</sup> century BC.

37. LeVen 2014, 166.

38. See LeVen 2014, 167-168.

39. On the *aulos* revolution of early 5<sup>th</sup> century BC and the role of Pindar in it see Prauscello 2012; Steiner 2013; LeVen 2014, 81-83 with further bibliography.

40. As the scholium 12a (p. 265 Drachmann) to the passage points out, the reference is to ἡ αὐλητικὴ τεχνή ‘the art of playing the *aulos*’; later in the ode Pindar refers to the melody that Athena “fashioned with every sound of *auloi*” (αὐλῶν τεῦχε πάμφωνον μέλος,

welcome Midas, who “defeated the Greeks in the art (τέχνη) which Pallas Athena once invented (ἔφευρε) by weaving into music the fierce Gorgons’ deathly dirge (θρασεΐαν <Γοργόνων> / οὔλιον θρῆνον διαπλέξαισ’ Ἀθάνα)” (vv. 5-6).<sup>41</sup> In the act of heuristic *mimesis* represented here, the goddess devises (ἔφευρε) the craft of playing the αὐλός by imitating the “echoing lament” (ἐρικλάγταν γόον, v. 21) of the two Gorgons as they are slaughtered by Perseus,<sup>42</sup> and by weaving it into a θρῆνος ‘dirge’, a structured form of music – the term designates as well a sub-genre of choral lyric.<sup>43</sup>

While it is difficult to imagine the exact musical effect of διαπλέκειν and ἀμφιπλέκειν in association with the art of playing the αὐλός, the use of compound forms of πλέκειν in the context of programmatic declarations of musical poetics suggests that the craft of weaving represented a favourite source of techniques and technical terminology for illustrating innovations in instrumental music; the composite nature of the αὐλός, made of two reeds, resulted in a highly mimetic and variegated sound according to the sources, and the semantic domain of interlacing, plaiting, and weaving (especially the technique of pattern-weaving) may have been perceived as aptly conveying the complexity of the αὐλετική τεχνή. Occurrences of κρέκειν in association with the αὐλός, and in general the use of the verb in musical context, may thus gain a further layer of connotations if set against the term’s semantic origin in the craft of weaving.

This is especially the case when κρέκειν is matched by the cognate κερκίς, as in a sung monody from Euripides’ fragmentary *Hypsipyle*, a tragedy dating to the last decade of 5<sup>th</sup> century BC and, as far as the text conserved in the Bodleian papyrus (*POxy.* 852) allows to conclude, displaying significant metrical variegation and sustained musical imagery in its lyric sections.<sup>44</sup> The first conserved fragment of the play transmits the end of *Hypsipyle*’s opening lyric monody, which the girl sings to the baby Opheltes: the theme of the song, and of the following lyric dialogue with the Chorus, is a metamusical reflection on just what kinds of song are appropriate for *Hypsipyle* to sing as she wishes to amuse the baby. A reference to the rhythmical sound of castanets (ἰδοῦ, κτύπος ὄδε κορτάλων “Look, here is the sound of castanets”, v. 8) is followed after a one-line lacuna by a *recusatio*, where *Hypsipyle* mentions the work-songs she is not going to sing, as the norm of generic appropriateness (a fundamental principle of archaic aesthetics)<sup>45</sup> requires her to turn to “what is fitting for a tender young boy” (ὄτι ... π]αιδι πρέπει νεαρῶ, v. 14):

οὐ τάδε πήνας, οὐ τάδε κερκίδος  
ἱστοτόνου παραμύθια Λήμνι’ ἄ  
Μοῦσα θέλει με κρέκειν· (...)

Eur. *Hyps.* fr. 752f 9-11 K. (*TrGF*  
vol. 5.2)<sup>46</sup>

v. 19) and “called it the many-headed tune” (ὠνόμασεν κεφαλᾶν πολλᾶν νόμος, v. 23), the *nomos polykephalos*, a melody for the αὐλός which might have been used by Midas in his victorious performance.

41. The text of Pindar is Snell-Maehler (Teubner).

42. The “echoing wail” of v. 21 is referred to just one of the sisters, Euryale: however, as also the scholium 35c (p. 268 Drachmann) makes explicit, the γόος is issued by both the Gorgons. Held 1998, 384 makes the different point that “[T]he singling out of one of the Gorgons implies the singling out of the other”, which supports his view that the deathly dirge woven into music by Athena is composed of two strains of sound, *i.e.* the groaning of each of the two sisters.

43. Through a survey of the occurrences of διαπλέκειν in pre-Hellenistic literature, Held 1998 persuasively argues that in most cases the verb refers to the woven product, rather than to the materials that are interlaced to fashion it: in this perspective, the οὔλιος θρῆνος composed by Athena is the final product of her interweaving.

44. I draw in this section on the detailed discussion of the *parodos* of *Hypsipyle* by Battezzato 2005; other important studies of the fragments of the play are Bond 1963 and Collard, Cropp & Gibert 2004. The reference edition is Kannicht 2004 (*TrGF* vol. 5.2, ffr. 752-769). As Collard, Cropp & Gibert 2004, 230 synthetically remark in their introduction, the style of the *Hypsipyle* “is that of the ‘New Music’ of which Euripides was a leading practitioner, characterized by freedom and variety of form and emotional expression, especially through female voices, and mimetic musical performance such as *Hypsipyle*’ castanet-song”.

45. On this crucial principle of distinction between poetic genres see Ford 2002, 13-22.

46. At the end of v. 10 I print Battezzato’s proposal of reading Λήμνι’ ἄ, with the relative pronoun ἄ introducing the following clause (“... the Lemnian songs that the Muse..”) in place of Λήμνια of the papyrus, thus linking the double τάδε at v. 9 to the sound of the

These are not the Lemnian songs, relieving the labour of [inserting] the weft-threads and (the labour) of the sounding-on-the-loom [or ‘stretched-on-the-loom’] *kerkis*, (these are not the Lemnian songs) that the Muse desires me to make resound; (...)

The “Lemnian alleviations” (παραμύθια Λήμνια, v. 10) that the Muse wants Hypsipyle to κρέκειν (‘cause to resound’) are at first sight songs sung at the loom to relieve the boredom and labour of weaving; the weft (πήνη, v. 9) and the κερκίς are generally taken as referring metonymically to the act of weaving on the loom. The rare compound adjective ιστότονος is translated as ‘loom-stretching’ or ‘stretching-across-the-loom’:<sup>47</sup> the first component, ιστός ‘loom’, designates the area of application of τόνος, a *nomen actionis* from the verb τείνειν (‘to stretch, put under tension’) meaning ‘tension’, but undergoing a semantic shift into musical terminology with the connotation of ‘sound’ (generated by the tension of a string) and ‘note’.<sup>48</sup> It is inviting to speculate that the adjective may bear here its entire semantic range, and that the notion of ‘tension’ associated with the κερκίς invests both the physical (the striking of the stretched threads) and the auditory sphere of the tool’s action; this seems to be supported by Euripides’ choice of the verb κρέκειν, whose perceived connexion with κερκίς (in terms of the ‘resounding’ of the weft-beater on the loom) is well attested by the lexicographic tradition, as we have seen. Aristophanes’ parody of Euripidean lyric in the *Frogs* (staged in 405), sung by the character of Aeschylus, includes a citation of *Hypsipyle* monody in a passage mimicking the hyper-mimetic and densely imagistic New Musical style of

Euripides’ late production. In this case, the adjective ιστότονος is connected to weft-threads (πηνίσματα), in turn defined as “practisings of singer *kerkis*” and wound by spiders with their fingers – an image with no apparent logical coherence, as it is aimed at mocking Euripides through a juxtaposition of excerpts from his lyric verses:

αἴθ’ ὑπώροφιοι κατὰ γωνίας  
εἰειειλίσσετε δακτύλοις φάλαγγες  
ιστότονα πηνίσματα,  
κερκίδος ἀοιδοῦ μελέτας

Aristophanes *Frogs* 1313-1316

and you spiders in crannies beneath the roof  
who with your fingers wi-i-i-i-i-nd  
the weft-threads stretched across the loom,  
practisings of singer *kerkis*

The focus on the sound/noise produced in weaving is mimetically rendered by the repetition of the first syllable of ειλίσσετε “you who wind”, signalling “the setting of a single long syllable to a cluster of shorter notes, forming an ornamental turn”.<sup>49</sup> When referred to the weft-threads, ιστότονος makes good sense as ‘stretched across the loom’, in this case by the action of the “singer *kerkis*” κερκίδος ἀοιδοῦ – also a Euripidean quotation, according to the scholia *ad loc.* (ascribed to the fragmentary *Meleagros*, fr. 523 N.<sup>2</sup> = fr. 528a K. *TrGF* vol. 5.1).

The *topos* of the ‘tuneful κερκίς’, with the variant ‘sound/voice of the κερκίς’, surfaces in 5<sup>th</sup> century BC drama in two fragments of Sophocles,<sup>50</sup> but enjoys a new popularity in a number of votive epigrams collected in the sixth book of the *Anthologia Palatina*,

castanets: see Battezzato 2005, 183-189. At v. 11 θέλει (“desires”) is a conjecture by Morel: the papyrus has the problematic μέλει (“is concerned (for me to sing)”). The metrical pattern is acatalectic dactylic tetrameter (four dactyls), also known as ‘Alcmanian’ due to its frequent use in Alcman.

47. Respectively Collard, Cropp & Gibert 2004, 190-191 and Dover 1993 in the commentary *ad loc.*

48. See the discussion on the semantics and usage of τόνος as a technical musical term in Rocconi 2003, 21-26.

49. Barker 1984, 115, who quotes the scholium *ad loc.* and translates ἐλίσσειν with ‘weave’ in the passage: the verb is Euripides’ favourite for denoting the whirling movements of circular Dionysiac dance: see Csapo 1999-2000, 422. In the MMS the number of repetition of εἰ vary between four and six; the metrical pattern of the song is Aeolic, with v. 1316 that can be interpreted as *ia + cho* or as a variation on the preceding *cr + io<sup>ma</sup>* with an added final syllable (hypercatalectic).

50. Both in a non-musical context: the “voice of the *kerkis*” (κερκίδος φωνή) of fr. 595 Radt (*Tereus*), transmitted by Aristotle in his discussion of tragic recognition (ἀναγνώρισις, *Poetics* 1454b 36-37), refers to Philomena’s in-weaving into a fabric of the story of her rape by Tereus; fr. 890 Radt mentions the “songs of the *kerkis*” (κερκίδος ὕμνοις) that (subject is κερκίς) “wakes up those who are sleeping”.



where weavers dedicate the implements of their figuring work on the loom to the goddess Athena, patron of handicraft, often with the purpose of abandoning textile activity to turn hetaerae.<sup>51</sup> The range of sounds attributed to the κερκίς in this group of epigrams encompasses several birds' cries (the swallow, the halcyon, the nightingale):<sup>52</sup> such a ornithological characterization of the sharp noise produced by the striking of threads on the loom may be positioned within a broader pattern of imagery in Hellenistic epigram, where we find instances of κρέκειν in association with singing birds and insects whose cry is compared with the sound of stringed instruments.<sup>53</sup> This seems to have become at this stage a literary *topos*, very far from the imitative poetics of Alcman's singing birds and κερκολύρα, and it certainly does not retain the semantic proximity with the domain of textile craft that we have seen in fifth century occurrences of κρέκειν in musical context.

#### **Metapoetics of weaving and cross-craft terminology: the case of ποικιλ- and δαιδαλ- terms**

Very similar in structure and theme to *PMG* 806, another fragment by Telestes (*PMG* 810) is concerned with projecting innovations in instrumental and sung music back to an archetypal time and to barbarian, Oriental origin; the Phrygian νόμος ('mode' or 'tune') was introduced in Greece by "the companions of Pelops; and the Greeks began to make the Lydian *hymnos* to resound (κρέκον / Λύδιον ὕμνον) with the shrill-voiced plucking of the *pēktis*". While in *PMG*

806 the Lydian νόμος was composed through the act of weaving around (ἀμφιπλέκειν) the composite sound of the αὐλός, here Telestes chooses κρέκειν to convey the image of a song executed with the accompaniment of a harp-instrument. The Lydian ὕμνος ('song') which is made to resound in *PMG* 810 could be set against a sample of metaliterary metaphors that conceptualize the composition and the performance of a choral song in terms of weaving, plaiting and interlacing. As it has been aptly noted, craftsmanship imagery in Greek choral lyric, especially in the well-attested genre of victory ode (*epinikion*), often presents the analogical relationship between the poem/song and the artefact as qualified by "a word for 'loud' or 'sounding'".<sup>54</sup> To stay within the association with the Lydian musical mode that we have seen picked up by Telestes, Pindar presents the choral persona in his eight *Nemean* as bringing a metaliterary "pattern-woven Lydian headband endowed with sound" (φέρων / Λυδίαν μίτραν καναχηδὰ πεποικιλμέναν, vv. 14-15); in the fourth *Nemean* (vv. 44-46) the image of the φόρμιγξ (a stringed instrument) that is invited to "weave out (ἐξύφαινε) this choral song (μέλος) in the Lydian mode (Λυδία σὺν ἁρμονίᾳ)" reaffirms the terminological osmosis between the τέχναι of weaving and music-making.<sup>55</sup> The popular etymology linking the term ὕμνος ('choral song' in pre-classical poetry, but later generally 'song', as probably also in Telestes 810 *PMG*) to the verb ὑφαίνειν ('to weave') in the sense of 'fabric' reflects the significant role of textile imagery within the broader metapoetics of craftsmanship specific to the genre of choral lyric.<sup>56</sup> A good number of metaphors for

51. This group of epigrams, and the dynamics of variation on the model, are discussed in Taràn 1979, 115-131.

52. Swallow: Philip of Thessalonica *A.P.* 6.247.1-3; swallow + halcyon: Antipater Sidonius *A.P.* 6.160.1-2; nightingale: Antipater Sidonius *A.P.* 6.174.5-6. In a few epigrams, the κερκίς is more generally "melodious" (φιλασιδός): Antipater Sidonius *A.P.* 6.247; "singer-and-dancer of the looms" (μολπάτις): Leonidas of Tarentum *A.P.* 6.288.4-5; "sonorous" (εὐθροός): Archias *A.P.* 6.39.5.

53. See the systematic survey of the occurrences by Raimondi 2000, whose starting point is Theocritus *A.P.* 9.433.

54. Ford 2002, 120, in the context of a fine discussion of "singer and craftsman" (113-130).

55. On Pindar's references to Lydian *harmonia*, and the relationship with the rhythmical pattern of the respective poem, see Prauscello 2012, 65 and 80-81: *Nemean* 4 is in Aeolic metre, *Nemean* 8 in dactylo-epitrite.

56. Bacchylides plays on this (par)etymology in two well-known passages (5.9-10 ὑφάνας ὕμνον "weaving a *hymnos*"; at 19.8 ὕμνοισιν ὑφαίνε κτλ. we have juxtaposition but no syntactical relationship). A systematic survey of ὕμνος and ὕμνεῖν in archaic poetry and especially in Pindar is presented by Maslov 2015, 286-307, who discusses as well the prehistory of the term and convincingly proposes as its original meaning 'cult choral song'. A comprehensive argument supporting the different view that *hymnos* is grounded in the semantics of fabric-making and, pointing to a pervasive conception of poetic performance as weaving, should always be taken as 'fabric, weave' in archaic poetry, is built by Gregory Nagy in a number of works of his: see e.g. Nagy 2002, 70-98.

song-making in Pindar are drawn from the semantic domains of weaving (ὄφαινειν: fr. 179 S-M), plaiting (πλέκειν: *Ol.* 6.86-87), and interlacing (εἴρειν: *Nem.* 7.77): they are thus integral to, and should be set against, the communicative strategy of the poet, who may want to illustrate the chorus' performance or dramatize the author's process of composition, and often makes these two temporal levels interact within the structure of the poem.<sup>57</sup>

A distinctive characteristic of textile metaphors within the wider frame of craftsmanship imagery to which they belong is the capacity to appropriate cross-craft terms and integrate them into the imagery of weaving.

It is with regards to the τέχνηαι of metal-working, carpentry and especially weaving that the semantic range of the series (adjective-verb-noun) δαιδάλεος/δαιδάλλειν/δαίδαλον and ποικίλος/ποικίλλειν/ποικίλμα partially converge in archaic and classical Greek literature: both formations point to an underlying model for the different techniques used to craft artefacts of different material (bronze, wood, fibre), and both reflect the perception of the beauty and complexity of elaborately wrought objects (in the case of the adjective ποικίλος, the concept of variegation entails as well the sensory dimensions of colour and sound).<sup>58</sup> The particular weaving techniques that let the intricate, variegated and multicoloured quality of δαιδάλεος and ποικίλος emerge in the shape of in-woven designs and patterns in fabrics have been identified with tapestry and pattern-weaving.<sup>59</sup> Two samples

of literary imagery featuring ποικιλ- or/and δαιδαλ- terms bear special relevance for the purpose of this chapter: a) occurrences of the syntactical construct ποικίλλειν τι ἔν τινι, which in a textile-related context can be rendered as 'to in-weave something (a pattern or pictorial motif) in/on something (the structure of a fabric)', and b) the metaphorical use of δαιδάλεος/δαιδάλλειν and ποικίλος/ποικίλλειν in association with the poem/song as metapoetic markers: this seems to be a distinctive trait of choral lyric poetics, as the extant instances of the trope feature prominently in Pindar and may serve to advertise the composite nature of the choral performance (made of music, singing, dance, and their respective rhythmic, melodic and orchestric patterns) as well as the complexity and variety of the poem's structure.<sup>60</sup>

Among the extant instances of the phrasing ποικίλλειν τι ἔν τινι in archaic and classical literature, the only occurrence in prose is represented by the scene of cosmic weaving described by Pherecydes of Syros (6<sup>th</sup> century BC) in his cosmological work, the earliest depiction of earth as a work of craftsmanship: on the occasion of the wedding between Zas and Chthonie, the god "fashions a beautiful and large robe, and in-weaves into it Gē [the earth], Ogēnos [the see] and Ogēnos' dwellings" (ποιεῖ φᾶρος μέγα τε καὶ καλόν, καὶ ἐν αὐτῷ ποικίλλει Γῆν καὶ Ὠγηνὸν καὶ τὰ Ὠγενοῦ δώματα fr. 68 Schibli = D-K 7 B2).<sup>61</sup> *Pythian* 9.76-79 is a typical statement of epinician poetics on the part of Pindar, who advertises the interlacement of different themes within the ode: "great achievements are

57. On this specific aspect of archaic lyric poetics see D'Alessio 2004. See Gallet 1990, 77-82 for a discussion of weaving metaphors in Pindar.

58. Frontisi-Ducroux 1975, 52-63 explores the technical aspects of metal-working, wood-working and weaving associated with the δαιδάλεος object: in detecting "homologie des procédés techniques" and "solidarité et interdépendance des différentes matières" (60), she concludes that "[L]es diverses techniques mises en œuvre pour la réalisation du *daidalon* paraissent pensées selon un même modèle intellectuel. L'accent y est mis, semble-t-il, sur la relation entre l'ensemble et les parties. Découpage et assemblage en constituent les axes privilégiés" (61). For a survey of δαιδαλ- terms in Greek literature, with focus on the metaphorical use of δαιδάλλειν in Pindar, see Coward 2016, 48-49 with n. 24. LeVen 2013 offers an analysis of the concept of ποικίλος from the point of view of the semantics of colour and sounds, and traces the transformation of the term (and the cognate noun ποικιλία) in the musical discourse of the late classical period (in connection with specific features of the New Musical style); as for the connotation of ποικίλος in archaic poetry as a colour term, LeVen observes that the adjective "does not describe one colour, pattern, or chromatic shade, but a mottled or dapple appearance, or a skilful arrangement of parts" (233).

59. See the rich discussions of the relevant passages, and further bibliography, in Frontisi-Ducroux 1975, 53-55; Barber 1991, 358-365; Nagy 2010, 273-308; Edmunds 2012, §§52-57.

60. On this regard see Pfeijffer 1999, 22: "[T]he kind of ποικιλία Pindar is aiming at is structural diversity that results from the use of different kinds of material", with references to ποικιλία in ancient literary criticism.

61. See the edition and commentary by Schibli 1990, 50-77 on this section of Pherekydes' book.

always worthy of many words; but to in-weave ancillary themes into the structure of the main themes of the ode (βαῖα δ' ἐν μακροῖσι ποικίλλειν, v. 77) is something that (only) wise men can understand (ἀκοῶ σοφοῖς, lit. 'that can be heard by *sophoi*'), for the *kairos* maintains the cohesion of the whole structure (ὁ δὲ καιρὸς ὁμοίως / παντὸς ἔχει κορυφάν).<sup>62</sup> It is significant that the image gains in coherence once it is set against its material background in textile technology: the poetic technique of inscribing minor themes within larger ones, making them surface in a way that only the *sophoi* in the audience can fully appreciate, is described in terms of pattern or tapestry-weaving. The picture acquires a further layer if, as Bernard Gallet suggests, the term καιρὸς 'due measure, right time' is traced back to its homograph καῖρος, the 'chained spacing cord' that keeps the warp-threads separated and in due order: Gallet sees a further connotation of the weaving term καῖρος in the starting-border of the weave, and applying this meaning to *kairos* at vv. 78-79 sees in it a description of the function of the starting band, which "holds the summit of the whole fabric by keeping the threads constantly in order".<sup>63</sup>

Two lyric passages in Euripides present the construct ποικίλλειν τι ἐν τινι associated with the craft of in-weaving (through pattern- or tapestry-weaving) episodes of the myth on fabrics or garments destined to cultic or ritual functions: the Chorus of Trojan captives in *Hecuba* 466-471 envisages the weaving of the Panathenaic *peplos* for Athena in terms of "pattern-weaving into Athena's saffron-coloured *peplos* in weft threads intricately quilted with flowers (ἐν δαιδαλέαισι ποικίλλουσ' / ἀνθοκρόκοισι πή- / ναϊς) the joking of her lovely chariot mares, or the race of Titans", with an interesting juxtaposition of δαιδαλ- and ποικιλ- terms in the same line. The motif of the

sound of the loom in connection with the κερκίς surfaces in the *parodos* of the *Iphigenia among the Taurians*, where Iphigenia laments that she is not allowed to sing in honour of Hera at Argos, nor is she able to "pattern-weave with the κερκίς on the fair-sounding looms (ἱστοῖς ἐν καλλιφθόγγοις / κερκίδι, vv. 222-223) the likeness of Athena Pallas and the Titans".

The second sample of imagery marks Pindar's appropriation of δαιδαλ- and ποικιλ- terminology as a vehicle of metapoetic metaphors, integrating or substituting ὑφαίνειν and πλέκειν, and adding a connotation of intricateness and variegation that may refer to the musical and rhythmical features of the song. The metaphorical use of the verb δαιδάλλω with the meaning 'to ornament, to adorn with song' is a Pindaric innovation: we find instances of this image both in epinician verse (*Ol.* 1.105 "to ornament in famous folds of songs" κλυταῖσι δαιδαλωσέμεν ὕμνων πτυκαῖς, see also *Nem.* 11.17-18) and in a Theban *daphnephorikon* (fr. 94b.31-32 S-M δαιδαλλοῖσ' ἔπεσιν "adorning with verses"). The usage of ποικίλος/ποικίλλω is more regularly associated with weaving imagery: the adjective qualifies both the variegated and multi-coloured aspect of the woven object (fr. 179 S-M ὑφαίνω δ' Ἀμυθαονίδαισιν ποικίλον / ἄνδημα "I am weaving a pattern-woven headband for the sons of Amythaon") and the composite nature of the *hymnos* that is being performed (*Ol.* 6.86-87 "I shall drink [*sc.* the lovely water of Thebe], as I plait for spearmen a pattern-woven choral song" ἐρατεινὸν ὕδωρ / πίομαι, ἀνδράσιν αἰχματαῖσι πλέκων / ποικίλον ὕμνον).<sup>64</sup>

While the metaphor of 'weaving a hymn' is widely attested in Vedic and Avestan poetry, instances of the 'weaving a choral dance'-motif suggests that Greek literature appropriates the image of poetic weaving in a rather genre-specific way.<sup>65</sup>

62. For the interpretation of this gnomic passage I draw on the excellent discussion by Gallet 1990, 83-101.

63. Gallet's identification of καῖρος with the chained spacing cord and, as in the passage discussed, with the starting border of the weave, draws on the lexicographic tradition: see pp. 31-32 for a survey of the glosses.

64. On the future πίομαι see D'Alession 2004, 289-290: "[I]f the subject represents the narrative function of the author, and if the verb suggests a metaphor for poetic inspiration, we have here a case of production projected into the future [...]. If, however, it refers to the performers, the verb may indicate their receiving the water of poetry from Pindar and their performing his song". A further instance of ποικίλος illustrating the poetic artefact (a *kosmos* endowed with words) is fr. 194 S-M., and interesting case of cross-craft metaphor.

65. On Old Indian and Old Iranian texts using weaving and spinning metaphors as poetological device to claim poetic originality see Andrés-Toledo 2016, with further bibliography; West 2007, 37 argues that the prominence of the metapoetics of weaving in Pindar and Bacchylides is to be traced back to the "Dorian tradition of choral song [...] a repertory of Indo-European or at least Graeco-Aryan imagery that is hardly visible in the Ionian epic and Lesbian traditions"; Maslov 2015, 299 links the survival of the Proto-Indo-European metapoetics of craftsmanship in Greek poetry to "the genre of (cult) choral song". For the image of 'weaving a chorus' see Calame 1997, 34-37 n. 63 and the detailed discussion in Steiner (forthcoming).

This brings us back to the *Politics* passage, with the mention of τὰ Δαιδάλου (“the artefacts of Daedalus”, 1253b36) and Hephaestus’ tripods from *Iliad* 18: a constellation of δαιδάλ- terms is used by Homer in that same book<sup>66</sup> – a celebration of the art of the smith-god culminating in the *ekphrasis* of the Shield of Achilles, that Hephaestus “crafted cunningly in every part” (πάντοσε δαιδάλλων, 479) and on which he “made many δαίδαλα” (482). One of these wondrous creations is a scene of choral dancing (590-606) represented on one of the outer circles of the shield; indeed, the opening lines see the only appearance of Daedalus in Homer:

ἐν δὲ χορὸν ποίκιλλε περικλυτὸς ἀμφιγυήεις  
τῷ Ἴκελον, οἶον ποτ’ ἐνὶ Κνωσῷ εὐρείῃ  
Δαίδαλος ἤσκησε καλλιπλοκάμῳ Ἀριάδνῃ.  
ἔνθα μὲν ἠἴθειοι καὶ παρθένοι ἀλφεσίβοιοι  
ὠρχεῦντ’, ἀλλήλων ἐπὶ καρπῷ χεῖρας ἔχοντες.

Hom. *Il.* 590-594

On it furthermore the famed god of the two  
lame legs inlaid (ποίκιλλε) a dance (χορὸν)  
like the one which once in wide Cnossus  
Daedalus fashioned for fair-tressed Ariadne.

There youths and maidens of the price of  
many oxen  
were dancing, holding their hands on one  
another’s wrists.

The passage offers a comparison between Hephaestus and Daedalus as fashioners of a χορός: in its Homeric usage the term can denote both a dancing floor and the actual dance of a choral formation;<sup>67</sup> the choice between the two meanings seems to have troubled already ancient commentators to these lines, as shown by the interpretations provided by the scholia. While the locative adverb ἔνθα (‘there’) at v. 593 seems to suggest that χορός designates here the dancing floor,<sup>68</sup> a scholium connects Daedalus’ χορός for Ariadne to the circular choral dance that Theseus ‘wove’ (ἔπλεκεν, lit. ‘plaited’) after his victorious exit from the labyrinth with the fourteen youths (seven young men and seven girls);<sup>69</sup> the image of ‘weaving a chorus’ of dancers (the ensemble of youths) may as well have been generated here, as the scholiast suggests, by the fact that the choreography of the dance, created by Daedalus and transmitted to Theseus and the youths, was inspired by the “twists and turns of the labyrinth”.<sup>70</sup> In the first line of the Homeric passage (590), χορὸν is

66. See Morris 1992, 226: “*Iliad* 18 is the richest source of such expressions [*sc.* artefacts endowed with “legendary, divine, or exotic craftsmanship”] in their full range, convening Hephaistos, Daidalos, every variant of δαιδάλ- words, and the power of movement in art”. Occurrences of δαιδάλ- terms in *Iliad* 18: adjective δαιδάλεος, vv. 379, 390, 612; noun δαίδαλον (pl. δαίδαλα), vv. 400, 482; verb δαιδάλλειν, 479.

67. χορός indicates the choral ensemble later in the passage, at v. 603 (where a crowd of spectators take delight in the “lovely chorus” ἡμερόντα χορὸν) and in the choral performance executed for Odysseus by Phaeacian dancers in *Od.* 8.264 (whereas at 8.260 χορός is the dancing floor). See Morris 1992, 12-15 for a thorough discussion of our passage and its significance for later traditions about Daedalus (“[R]eaders since antiquity have made him an architect, sculptor, or choreographer on the basis of this passage and its possible interpretations, beginning with the scholia”, p. 14); cf. Power 2011, 80-82 on Daedalus and chorality, and on this passage as “an impetus to the metaphoric elaboration of the choral singer-dancer as a ‘bionic’ statue of stone or metal” (82).

68. See Scholia A *ad* 18.590a (Erbse IV p. 564) τὸν τόπον χορὸν εἶρηκεν, οὐ τὸ σύστημα τῶν χορευόντων “[Homer] calls χορός the place [of the dance], not the formation of dancers” and Scholia BT *ad* 18.590b (Erbse IV p. 564) χορὸν: τὸν πρὸς χορείαν τόπον “χορός: the place for choral dance”, adding that this is made explicit by the following ἔνθα ‘there’; Scholia T *ad* 18.590c (Erbse IV p. 564) introduces architectural ποικιλία (‘variegation’), explaining that Hephaestus adorned the dancing floor with columns and statues in circle. See Morris 1992, 14 on ancient ‘architectural’ interpretations of Daedalus’ χορός, especially Pausanias 9.40.3 (a marble relief with dancers in Cnossos).

69. Schol. AB *ad* 18.590 (Bekker p. 514, ll. 33-37) ἐξελθὼν δὲ μετὰ τὸ νικῆσαι ὁ Θησεὺς μετὰ τῶν ἠθέων καὶ παρθένων χορὸν τοιοῦτον ἐπλεκεν ἐν κύκλῳ τοῖς θεοῖς, ὅποια καὶ ἡ τοῦ λαβυρίνθου εἰσοδὸς τε καὶ ἐξοδὸς αὐτῷ ἐγεγόνει. τῆς δὲ χορείας τὴν ἐμπειρίαν ὁ Δαίδαλος αὐτοῖς ὑποδείξας ἐποίησεν “When Theseus emerged after his victory [over the Minotaur] with the young men and the young girls, he wove such a χορός in a circular formation for the gods, just as his entrance and exit from the labyrinth had been. Daedalus devised the craft of the *choreia* and showed it to them” (transl. Power 2011, 82).

70. Muellner 1990, 91. In other sources this choreography is associated with the ‘crane dance’ (γέρανος), performed by Theseus and the youths in Delos: on the mythical episode, and Daedalus’ role in it as both choreographer and architect, see Frontisi-Ducroux 1975, 145-147; Power 2011, 80-82. Cf. the exhaustive discussion on the ritual prerogatives of Theseus as chorus-leader of circular dances in Calame 1997, 53-58.

direct object of the verb ποικίλλειν in what is our earliest instance of the construct ποικίλλειν τι ἔν τινι, often occurring in textile-related contexts to describe pattern-weaving or tapestry, as we have seen. The choice of the verb (ποικίλλε, 590, a *hapax legomenon* as well as Δαίδαλος at 592) in relation to a choral performance has been seen as pointing towards weaving imagery.<sup>71</sup> However, the cross-craft nature of ποικιλ- terminology and its semantic focus on techniques rather than materials provide the verb with an entirely satisfactory meaning as ‘to inlay’ in our passage: the Homeric verse seems rather to offer an interesting instance of terminological convergence between τέχνη.

While the loss of the totality of the melodic patterns of ancient Greek music accompanying the performance of archaic lyric – a loss that should be paired with that of the choreography of dramatic and non-dramatic choruses – makes it difficult and tentative any discussion on the nature of the relationship between the craft of weaving and the τέχνη of musical and poetic composition and performance, certain patterns of convergence at the level of terminology seem to suggest a profound dynamics of exchange between the two arts. The usage of κρέκειν in 5<sup>th</sup> century BC lyric and drama, and its partial overlapping with instances of other technical terms of weaving applied to instrumental music, invite further considerations and a more systematic study of aspects of musical imagery and poetic technique (metrical and rhythmical patterns, stylistic and structural features) that can still be detected and analysed, and that may reveal precise correspondences between certain instrumental practices, musical modes and rhythmical patterns, and particular techniques of the craft of weaving. The generic appropriation by archaic Greek choral lyric of a repertoire of metapoetics of craftsmanship of Proto-Indo-European origin should be seen as a distinctive tract of poetics, and as the frame against which to explore the prominent role of weaving imagery in illustrating and conceptualizing song-making.

71. See especially the rich discussion and the argument built by Nagy 2010, 273-310, who argues for a number of connections (ritual, religious, technological) between metal-working and pattern-weaving as early as the Bronze Age, and sees the technique of ‘variation’ expressed by ποικίλος/ποικίλλειν (and the equivalent πάσσειν ‘sprinkle’, which the Scholia A and T ad 22.441d2 gloss as the Cypriot term for ποικίλλειν) in the crafts of metal-working and pattern-weaving as apt metaphors for the variegation of Homeric poetry; in the specific case of *Il.* 18.590 Nagy argues that “the bronzework of the god is pictured as an act of pattern-weaving” (291), and that ποικίλλειν as pattern-weaving is a metaphor for metalworking. Steiner (forthcoming) proposes the fascinating hypothesis that χορός (*qua* expression of chorality and its nexus with weaving imagery) may have determined, by means of semantic and imagistic ‘attraction’, the choice of the verb ποικίλλω in the passage.

## Abbreviations

- D-K H. Diels (ed.), *Die Fragmente der Vorsokratiker*<sup>6</sup> 3 vols., rev. W. Kranz., Berlin, 1951-1952.
- GE Franco Montanari. *The Brill Dictionary of Ancient Greek*. Editors of the English Edition: M. Goh & Ch. Schroeder. Leiden Boston 2015.
- PCG R. Kassel and C.F.L. Austin (eds), *Poetae Comici Graeci*. 8 vols. Berlin and New York 1983-1998. 2 (1991); 3.2 (1984); 4 (1983); 5 (1986); 6.2 (1998); 7 (1989); 8 (1995).
- PMG D.L. Page (ed.), *Poetae Melici Graeci*. Oxford 1962.
- PMGF M. Davies (ed.), *Poetarum Melicorum Graecorum Fragmenta* Vol. 1 Oxford 1991.
- S-M B. Snell, rev. H. Maehler (eds), *Pindari Carminum Fragmentis*<sup>8</sup>. 2 vols. Leipzig 1987-1989.
- TrGF *Tragicorum Graecorum Fragmenta*. vol. 1 *Didascaliae Tragicae, Catalogi Tragicorum et Tragoediarum, Testimonia et Fragmenta Tragicorum Minorum* (ed. B. Snell; Göttingen 1971<sup>1</sup>, 1986<sup>2</sup>); vol. 2 *Fragmenta Adespota* (eds R. Kannicht and B. Snell; 1981); vol. 3 *Aeschylus* (ed. S.L. Radt; 1977); vol. 4 *Sophocles* (ed. S.L. Radt; 1985<sup>1</sup>, 1999<sup>2</sup>); vol. 5 *Euripides* (ed. R. Kannicht; 2 parts; 2004).
- V. E.-M. Voigt (ed.), *Sappho et Alcaeus. Fragmenta*. Amsterdam 1971.

## Bibliography

- Andersson Strand, E. & Nosch, M.-L. (eds) *Tools, Textiles and Contexts. Investigating Textile Production in the Aegean and Eastern Mediterranean Bronze Age*. Ancient Textiles Series 21. Oxford.
- Andrés-Toledo, M. Á. (2016) Indo-Iranian Weavers of Old and New Hymns. In Fanfani, Harlow & Nosch 2016, 17-23.
- Barker, A. (1984) *Greek Musical Writings: I. The Musician and his Art*. Cambridge.
- Barker, E. (1961) *The Politics of Aristotle*. Oxford.
- Battezzato, L. (2005) La parodo dell’*Ipsipile*. In G. Bastianini & A. Casanova (eds) *Euripide e i Papiri. Atti del*

- Convegno Internazionale di Studi. Firenze, 10-11 Giugno 2004*, 169-204. Firenze.
- Besso, G. & Curnis, M. (2011) *Aristotele. La Politica. Libro I*. Roma.
- Bond, G. W. (1963) *Euripides. Hypsipyle*. Oxford.
- Calame, C. (1997) *Choruses of Young Women in Ancient Greece. Their Morphology, Religious Role, and Social Function*. Lanham, MD.
- Collard, C., Cropp, M. J., Gibert J. (2004) *Euripides. Selected Fragmentary Plays. Vol. 2*. Oxford.
- Coward, T. R. P. (2016) The Robes of Alcman's and Pindar's *Parthenoi*. In Fanfani, Harlow & Nosch (eds), 43-60.
- Crowfoot, G. M (1936/1937) Of the Warp-Weighted Loom. *ABSA* 37, 36-47.
- Csapo, E. (1999-2000) Later Euripidean Music. In M. Cropp, K. Lee & D. Sansone (eds) *Euripides and Tragic Theatre, Illinois Classical Studies* 24-5, 399-426. Champaign.
- Csapo, E. (2004) The politics of the New Music. In P. Murray & P. Wilson (eds) *Music and the Muse. 'Mousikē' in the Classical Athenian City*, 207-248. Oxford.
- D'Alessio, G. B. (2004) Past Future and Present Past: Temporal Deixis in Greek Archaic Lyric. *Arethusa* 37.3, 267-294.
- D'Angour, A. (2011) *The Greeks and the New. Novelty in Ancient Greek Imagination and Experience*. Cambridge.
- Dover, K. (1993) *Aristophanes. Frogs*. Edited with introduction and commentary. Oxford.
- Dunbar, N. (1995) *Aristophanes. Birds*. Edited with introduction and commentary. Oxford.
- Edmunds, S. T. (2012) Picturing Homeric Weaving. In *Donum natalicum digitaliter confectum Gregorio Nagy septuagenario a discipulis collegis familiaribus oblatum*. <http://chs.harvard.edu/CHS/article/display/4365>. Center for Hellenic Studies.
- Fanfani, G., Harlow, M., Nosch, M.-L. (2016) *Spinning Fates and the Song of the Loom. The Use of Textiles, Clothing and Cloth Production as Metaphor, Symbol and Narrative Device in Greek and Latin Literature*. Ancient Textile Series 24. Oxford.
- Franklin, J. C. (2003) The Language of Musical Technique in Greek Epic Diction. *Gaia. Revue interdisciplinaire sur la Grèce archaïque* 7, 295-307.
- Frontisi-Ducroux, F. (1975) *Dédale. Mythologie de l'Artisan en Grèce Ancienne*. Paris.
- Gallet, B. (1990) *Recherches sur kairos et l'ambiguïté dans la poésie de Pindare*. Bordeaux.
- Gentili, B. & Lomiento, L. (2003) *Metrica e Ritmica. Storia delle Forme Poetiche nella Grecia Antica*. Milano.
- Held, G. F. (1998) Weaving and Triumphal Shouting in Pindar, *Pythian* 12.6-12. *Classical Quarterly* 48.2, 380-388.
- Hutchinson, G. O. (2001) *Greek Lyric Poetry. A Commentary on Selected Larger Pieces*. Oxford.
- Keuls, E. C. (1983) Attic Vase-Painting and the Home Textile Industry. In W. G. Moon, *Ancient Greek Art and Iconography*, 209-230. Madison – London.
- LeVen, P. A. (2013) The colors of sound: Poikilia and its aesthetic contexts. *Greek and Roman Musical Studies* 1, 229-242.
- LeVen, P. A. (2014) *The Many-Headed Muse. Tradition and Innovation in Late Classical Greek Lyric Poetry*. Cambridge.
- Maslov, B. (2015) *Pindar and the Emergence of Literature*. Cambridge.
- Manessy-Guitton, J. (1977) La navette et la lyre. Variations sur le thème kerk-. In *Mélanges offerts à Léopold Sédar Senghor. Langues, littérature, histoire anciennes*, 225-253. Dakar.
- McEwen I. K. (1993) *Socrates' Ancestor. An Essay on Architectural Beginnings*. Cambridge MA.
- McIntosh Snyder, J. (1981) The Web of Song: Weaving Imagery in Homer and the Lyric Poets. *The Classical Journal* 76, 193-196.
- Morris, S. P. (1992) *Daidalos and the Origins of Greek Art*. Princeton.
- Moxon, I. S. (2000) Music While You Work: Weaving in Classical Antiquity. *Ars Textrina* 34, 15-28.
- Muellner, L. (1990) The Simile of the Cranes and Pygmies: A Study of Homeric Metaphor. *Harvard Studies in Classical Philology* 93, 59-101.
- Nagy, G. (2002) *Plato's Rhapsody and Homer's Music. The Poetics of the Panathenaic Festival in Classical Athens*. Cambridge MA-London.
- Nagy, G. (2010) *Homer the Preclassic*. Berkeley - Los Angeles.
- Newman, W. L. (1950<sup>2</sup> [1887]) *The Politics of Aristotle*. Oxford.
- Nünlist, R. (1998) *Poetologische Bildersprache in der frühgriechischen Dichtung*. Stuttgart.
- Pfeijffer, I. L. (1999) *Three Aeginetan Odes of Pindar. A Commentary on Nemean V, Nemean III, & Pythian VIII*. Leiden-Boston-Köln.
- Power, T. (2010) *The Culture of Kitharōidia*. Cambridge (MA)-London.

- Power, T. (2011) Cyberchorus: Pindar's Κηληδόνες and the aura of the artificial. In L. Athanassaki & E. Bowie (eds) *Archaic and Classical Choral Song. Politics, Performance and Dissemination*, 67-113. Berlin-Boston.
- Prauscello, L. (2012) Epinician sounds: Pindar and musical innovation. In P. Agócs, C. Carey & R. Rowles (eds) *Reading the Victory Ode*, 58-82. Cambridge.
- Raimondi, V. (2000) Πακτίδ(α)... τι κρέκειν in *A.P.* 9, 433, 2-3. *Quaderni Urbinati di Cultura Classica* n.s. 66, 133-148.
- Restani, D. (1995) I suoni del telaio. Appunti sull'universo sonoro dei Greci. In B. Gentili & F. Perusino (eds) *Mousike. Metrica, ritmica e musica greca in memoria di Giovanni Comotti*, 93-109. Pisa-Roma.
- Rocconi, E. (2003) *Le parole delle Muse. La formazione del lessico tecnico musicale nella Grecia antica*. Roma.
- Saunders, T. J. (1995) *Aristotle. Politics. Books I and II*. Oxford.
- Schibli, H. S. (1990) *Pherekydes of Syros*. Oxford.
- Schütrumpf, E. (1991) *Aristoteles. Politik. Buch I*. Berlin.
- Steiner, D. (2013) The Gorgons' Lament: Auletics, Poetics, and Chorality in Pindar's *Pythian* 12. *American Journal of Philology* 134.2, 173-208.
- Svenbro, J. (1976) *La parole et le marbre. Aux origines de la poésie grecque*. Lund.
- Taràn, S. L. (1979) *The Art of Variation in Hellenistic Epigram*. Leiden.
- West, M. L. (2007) *Indo-European Poetry and Myth*. Oxford.

## Xie, a Technical Term for Resist Dye in China: Analysis Based on the Burial Inventory from Tomb 26, Bijiatan, Huahai, Gansu

Le Wang and Feng Zhao

In May 2002, a burial site was found in Bijiatan, Huahai, in the Gansu province. During the following two months, the Gansu Institute of Archaeology excavated the graveyard and 55 tombs were excavated in total. A female corpse wrapped in several layers of silk garments was found in tomb 26 together with a burial inventory.<sup>1</sup>

### The Burial Inventory from Tomb 26

A burial inventory is a list of buried items that would accompany the deceased to the afterlife. It was commonly found in the tombs in northwest China during the 4th to 7th centuries AD. The inventory of Tomb 26 is a rectangular pine wood tablet with characters written on both sides. On one side of the inventory are the names and numbers of the garments and other articles buried in the tomb; on the other side is the name of the tomb owner and the year in which she had died. According to the record, the tomb occupant was “the eldest daughter *Gounu Sun*” who lived in the Eastern Jin Dynasty and died in the year 377 AD.

Three columns and a total of 35 items are recorded in the inventory:

故紺絰一枚 故紬頭一枚 故絳纏相一枚 故鍮石叉三枚 故紺青頭衣一枚 故巾一枚 故練面衣一枚 故纏絲一斤 故練衫一領 故緋羅綉兩當一領 故綠襦一領 故紫綉襦一領 故碧禪一立 故緋綉袴一立 故布幫一牒 故緋碧幫一牒 故碧襪一量 故頭系履一量 故銀履簾一具  
故布□一枚 故紺績被一牒 練里 故邊□囊一枚 故縷囊一枚 故練手巾四枚 故布衫一領 故青延一枚 故鏡鑷一枚  
故銀鏡一枚 故發刀一枚 故尉斗一枚 故疏二枚 含一枚 故雜綵五百匹 為道用 故雜綵瓢一具 松柏器一口

As used by the owner, *gan-gua* [dark red coarse silk] (headscarf?) – 1 piece.

As used by the owner, *chou-tou* (headscarf?) – 1 piece.

As used by the owner, red *chan-xiang* (headscarf?) – 1 piece.<sup>2</sup>

As used by the owner, hairpins made of copper alloy – 3 pieces.

As used by the owner, navy blue hood – 1 piece.

1. Zhao *et al.* 2008, 94.

2. According to the research by Dou Lei, *gan-gua*, *chou-tou*, and *chan-xiang* could all belong to headdresses, maybe headscarves. Dou 2013, 96.



As used by the owner, shawl (?) – 1 piece.  
 As used by the owner, face cover made of *lian* – 1 piece.  
 As used by the owner, silk floss – 1 *jin*.  
 As used by the owner, shirt made of *lian* – 1 piece.  
 As used by the owner, red gauze vest with embroidery – 1 piece.  
 As used by the owner, green jacket – 1 piece.  
 As used by the owner, purple jacket with embroidery – 1 piece.  
 As used by the owner, green trousers (with crotch) – 1 piece.  
 As used by the owner, red trousers (without crotch) with embroidery – 1 piece.  
 As used by the owner, hemp skirt – 1 piece.  
 As used by the owner, skirt in red and green – 1 piece.  
 As used by the owner, green socks – 2 pieces.  
 As used by the owner, *tou-xi* (uncertain) shoes – 2 pieces.  
 As used by the owner, silver box for shoes – 1 piece.  
 As used by the owner, hemp [text missing] – 1 piece.  
 As used by the owner, navy blue quilt with a lining made of *lian* – 1 piece.  
 As used by the owner, *bian*-[text missing]-*nang* (uncertain) – 1 piece.  
 As used by the owner, *lv-nang* (uncertain) – 1 piece.  
 As used by the owner, hand towels made of *lian* – 4 pieces.  
 As used by the owner, hemp shirt – 1 piece.  
 As used by the owner, green bamboo mat – 1 piece.  
 As used by the owner, mirror cover/box (?) – 1 piece.  
 As used by the owner, silver mirror – 1 piece.  
 As used by the owner, hair cutting knife – 1 piece.  
 As used by the owner, iron – 1 piece.  
 As used by the owner, *shu* (combs?) – 2 pieces.  
 Gem of pearl formerly put into the mouth of a corpse (?) – 1 piece.

As used by the owner, colourful silks – 500 bolts.

For the ritual:

As used by the owner, ladle decorated with colourful silks – 1 piece.

Pine coffin – 1 piece.

Most of the items listed in the burial inventory are the clothing items and accessories used by the owner of the tomb and 25 of them are associated with textiles or costumes. The materials for the costume include silk and hemp. *Lian*, degummed plain weave silk, were used mostly. The smaller quantities are more likely to be descriptions of real items while larger quantities (500 bolts) probably represent desired amounts for use in the next world. The burial inventory is important for identifying the accurate date of the tomb, and for providing the names of garments to match with the excavated items.

### The Silk Garments Found in Tomb 26

The clothes worn by the female corpse are not in good condition. Only the textiles on the upper part of the body were relatively well preserved, while those on the back were decayed. These garments were conserved by the China National Silk Museum. With the aid of the burial inventory, the silk fragments were grouped into eight garments, one quilt and one face cover.

According to the study by Feng Zhao, the eight garments are: a purple jacket with resist dyed pattern, red trousers (with crotch) with embroidery, a red gauze vest with embroidery, a green jacket, a skirt in red and green, a shirt made of *lian*, green pants (without crotch), and navy blue hood.<sup>3</sup> The weave structures of the fabrics include plain weave, gauze and weft-faced compound tabby. Other techniques used for the pattern are embroidery and resist dye. Most of them match the burial inventory very well except the purple jacket with resist dyed pattern.

This jacket was reconstructed from two fragments (fig. 1), which were the two front sides. It has an overlapping collar with right over left and has loose sleeves. The main fabric of the upper part of the jacket is purple tabby with resist dyed patterns and

3. Zhao *et al.* 2008, 95-109.

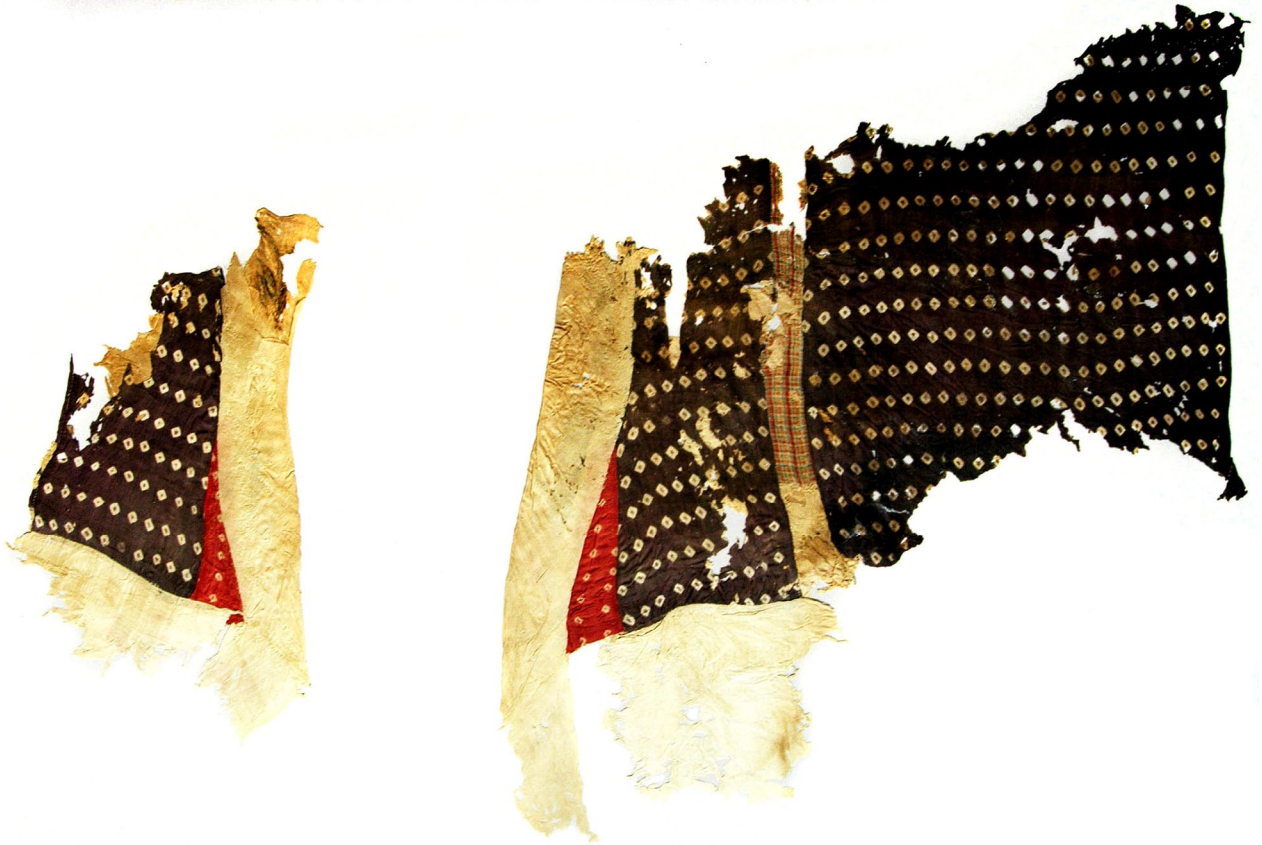


Fig. 1. Purple jacket with resist dyed pattern. Gansu Institute of Archaeology

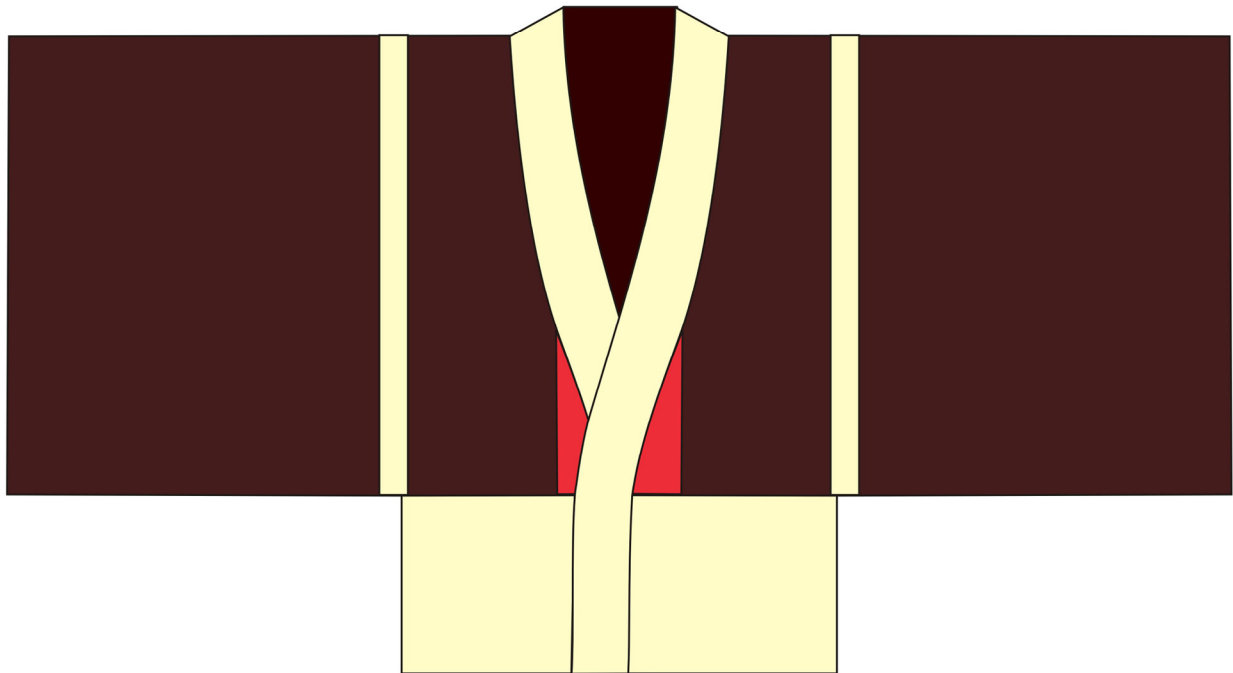


Fig. 2. Reconstruction of purple jacket with resist dyed pattern. Drawn by Wan Fang.

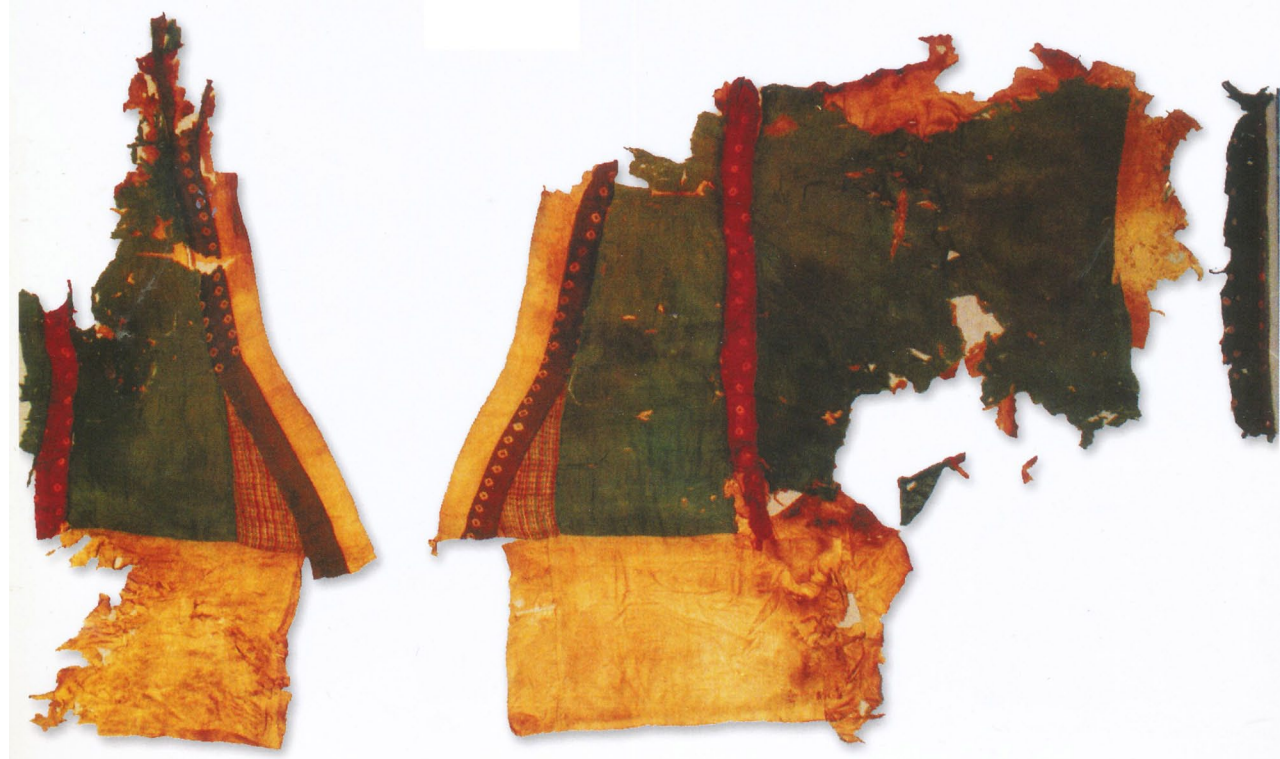


Fig. 3. Green jacket. Gansu Institute of Archaeology

the lower part is white tabby. There is a piece of red triangular resist dyed tabby sewn between the collar and the panel and a strip of checked pattern silk sewn between the panel and the sleeve (fig. 2).

The design of this purple jacket is quite similar to the green jacket found in the same tomb. The green jacket also has overlapped collar with right over left and loose sleeves. The main fabric is green and white tabby. The collar was made of white tabby and a purple resist dyed tabby. There is a piece of checked pattern silk sewn between the collar and the panel and a strip of red resist dyed silk sewn between the panel and the sleeve (fig. 3).

The pattern of these resist dyed silks are similar: small, white spots on purple/red background. The spots are about 1 cm × 1 cm in size with small irregular tiny dots in the centre. The four edges of the spots are 45 degrees from both the warp and the weft directions. About six spots are arranged in 10 cm in warp direction, and 4 spots in 10 cm in weft direction (fig.

4). The technique of this kind of resist dye is called *xie* in Chinese.

According to the burial inventory, there were only two jackets buried with the tomb owner: one purple jacket with embroidery and one green jacket. Looking through the archaeological findings, there are indeed two jackets: the purple jacket with resist dyed pattern and one green jacket. We can deduce that the purple jacket described as with embroidery and recorded in the burial inventory should be identified as the purple jacket with resist dyed pattern.

#### The Appearance of Resist Dye (*xie*) in China

The origin of dyed silk in China could date to West Jin dynasty (265-316 AD) in northwest China. Closest to *Huahai* in location, a piece of blue tabby with resist dyed patterns was found in tomb M1 which is date to 405 AD at Foyemiaowan in Dunhuang.<sup>4</sup> Another deep red tabby with resist dyed patterns was

4. Museum of Dunhuang County 1983, fig. 13.



**Fig. 4.** Detail of the purple tabby with resist dyed pattern. Gansu Institute of Archaeology

found in tomb 63TAM1 in Astana dating to 417 AD.<sup>5</sup> In tomb 95BYMC in Yingpan which dates from the 4th to 5th century AD, a red tabby with resist dyed pattern was excavated (fig. 5).<sup>6</sup>

However, the Chinese character *xie* appeared much later, in about 5th to 6th century AD. *Wei Shu* [The Book of Wei] is an important text recording the history of the Northern Wei and Eastern Wei dynasties

from 386 to 550 AD. In a proposal presented by Yuan Yong (470?-528 AD), the Prince *Wenmu* of *Gaoyang*, he suggested Empress Dowager Hu to forbid the servants wearing damasks and *xie*. *Luoyang qie lan ji* [The monasteries of Luoyang] is a report of all Buddhist monasteries in the Northern Wei dynasty (386-534 AD). It recorded the wealth of Yuan Chen, one of the richest men in the Northern Wei dynasty. In his warehouses there were countless jewels and textiles, including *jin*, gauzes, damasks, embroideries and *xie* etc.

From the records above we know that the character *xie* appeared in the Northern and Southern dynasties. This kind of silk was different from embroidery and was precious during that period.

In China the original meaning of *xie* was tie dyeing.<sup>7</sup> Before dyeing, a series of knots are made in the textile by stitching or binding, so when it is dyed, the dye will not penetrate the knotted area. The textile then gets a resist dyed pattern. The resist dyed silk for the purple jacket found in Tomb 26 at Huahai and other silks dated from the 3rd to 5th centuries found in northwest China were all made by the technique of tie dye.

The reason, therefore, for using the term “*xiu* [embroidery]” for “*xie* [tie dyeing]” in the burial inventory of Tomb 26 might be the following: firstly, tie dyeing was still a new technology and a new type of decoration at that time and the patterns made by tie dyeing look like those made by embroidery; secondly, the Chinese character for tie dyeing appeared later than the technique itself, so people first used *xiu* as a term which also covered the meaning of *xie*.

### The Types of Resist Dye in China

Though the original meaning of *xie* is tie dye, it gradually became a general term for resist dye in ancient China, including: tie dye, clamp resist dye, wax resist dye and ash resist dye.

5. Xinjiang Uyghur Autonomous Region Museum 1973, fig. 50.

6. Zhao (ed.) 2002, pl. 12.

7. In *yi qie jing yin yi* [Phonetic and semantic dictionary for all Buddhist Sutras], the explanation of *xie* is: tying the silk with silk threads and dyeing, resulting in a pattern called *xie*.



**Fig. 5.** Red tabby with resist dyed pattern found in Yingpan. Xinjiang Institute of Archaeology

### *Tie Dye*

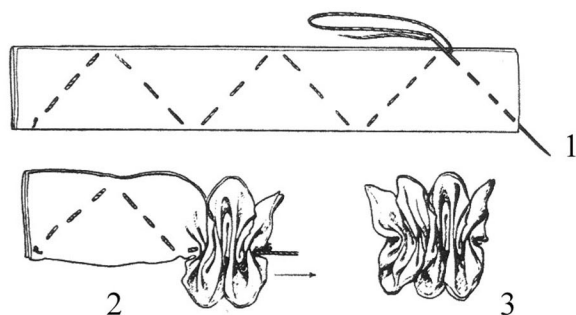
Tied with knots first and then dyed, the textile gets a resist dyed effect. This method appeared in the 3rd to 4th century AD, became prevalent in the 7th to 9th centuries and is still used today. The methods of tie

dye typically include stitching, binding and knotting.

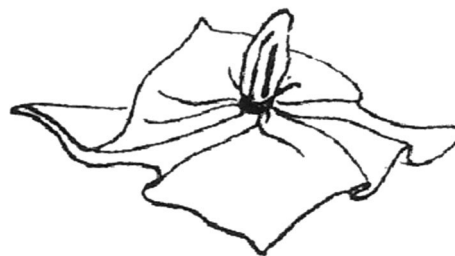
Stitching is the most widely used method in ancient China: sewing stitches into a pattern and then bunching the fabric along the seams before dyeing. Net, floret and coin patterns were commonly seen on the tie dyed silks found in Turfan, Xinjiang.



**Fig. 6.** Tie dye silk with net pattern found in Astana. Xinjiang Uyghur Autonomous Region Museum



**Fig. 7.** Stitching method. *Wang Xu & Textile Archaeology in China*, p. 83.



**Fig. 8.** Binding method. *Wang Xu & Textile Archaeology in China*, p. 93.

A tie dyed silk with net pattern was found in Astana Turfan. It was dated to about 683 AD.<sup>8</sup> There are obvious folds and needle holes on the silk (fig. 6). The tying process was: folding white tabby first; then sewing long stitches into a zigzag pattern; in the end, tightly gathering the stitching (fig. 7).<sup>9</sup> When the

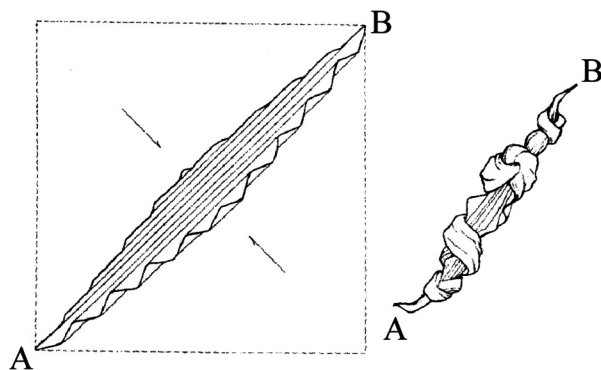
tabby was dyed, the brown dye could not penetrate the stitched area, resulting in a white net pattern on brown background.

The binding method is very simple: wrapping the fabric and then binding it tightly with threads (fig. 8).<sup>10</sup> The areas of the fabric that are under the binding

8. Xinjiang Uyghur Autonomous Region Museum *et al.* 1973, pl. 50.

9. Wang 2001, 83.

10. Wang 2001, 93.



**Fig. 9.** Knotting method. Wang Xu & *Textile Archaeology in China*, p. 92.

will remain undyed when dipping in the dye. Compared to the stitching method, the binding method usually results in a limited range of patterns, usually small dots. If the binding areas are small enough, the pattern will result in tiny square spots. The purple jacket found in Tomb 26 was made by applying the binding method. The tie dye in China probably derived from this method.

The knotting method is the simplest one among all the tie dye methods. No needle or thread is required when applying the knotting method. It is just to knot the textile, and the knotting area will remain undyed and commonly results in a striped patterns.<sup>11</sup> The damask with grape motif found in the Dulan Qinghai province was an example dyed by the knotting method. It was dyed into alternating stripes of green and white (fig. 10).<sup>12</sup>

### **Clamp Resist Dye**

By using two symmetrically carved concave blocks to clamp the folded textiles and dye, the pattern of the convex part is obtained. It is said that the sister

of Liu Jieyu during the reign of Emperor Xuanzong in the Tang dynasty invented this method.<sup>13</sup> A piece with a floral pattern created by using carved blocks was presented to the Empress Wang, whereupon Xuanzong ordered more pieces to be made within the palace. The technique was kept secret at first, but gradually spread until clamp resist dyed textiles became commonplace.

The written records give us a preliminary understanding of clamp resist dye. First, it was invented in the middle of the Kaiyuan period (713-741) but before 724;<sup>14</sup> second, clamp resist dye is a technique involving the use of two symmetrically carved blocks, which are placed on either side of the textile, clamped together, and placed in a dyeing vat; third, the earliest pattern attested by clamp resist dye was a floral pattern.

Actually most of the clamp resist dyed textiles from Dunhuang and Turfan have floral motifs. Clamp resist dyed textiles with animal motifs appeared later, mainly in the mid-late Tang and Five Dynasties (9<sup>th</sup>-10<sup>th</sup> century AD).

By using blocks with areas specially designed for different colours of dye, clamp resist dyed textiles could be dyed with more than one colour. Clamp resist dyed textiles of the Tang dynasty were usually dyed in blue and orange (sometimes in reddish brown, which would originally have been red, but later faded). However, clamp resist dyed textiles could also be in more than two colours. Most examples from Dunhuang were dyed in blue and red, then yellow was added by brush to some blue areas to create green, and to some red areas to form orange, such as the plain woven silk with clamp resist dyed confronting geese in a roundel (fig. 11).<sup>15</sup> In this way, textiles that were clamp resist dyed with two wooden blocks in two colours could achieve four colours.

11. Wang 2001, 92.

12. Zhao (ed.) 2002, pl. 41.

13. According to *Xian yuan* [Great Ladies] in Wang Dang's *Tang yulin* [Historical Documents of the Tang Dynasty] (originally in *Yin hualu* [A Collection of Notes and Novels of the Tang Dynasty]), clamp-resist dyeing was invented in the Tang dynasty, allegedly by the sister of an imperial concubine Liu Jieyu during the reign of Xuanzong (712-756 AD).

14. According to *Xuanzong ji* [Records of Xuanzong] in *Jiu Tang shu* [Old Records of the Tang Dynasty], this was the last date for the Empress Wang.

15. Zhao *et al.* (eds) 2007, 197.



**Fig. 10.** Damask with grape motif dyed in stripes. Qinghai Institute of Archaeology





**Fig. 11.** Clamp resist dyed silk with a pattern of confronting geese inside rosette roundel (MAS.876.a-b). British Museum

Clamp resist dye was very popular in the Tang and Song dynasties and still applied for the Tanka cover in Ming and Qing dynasties.

#### ***Wax Resist Dye***

When painting with melted wax on the textile first and dyeing then, the dye will not penetrate the wax



Fig. 11. b.

printed areas. Wax resist dye did not originate in China. The earliest wax dye textile found in China is a piece of wax dyed cotton excavated from an Eastern Han dynasty (25-220 AD) tomb in Niya. The images on the fabric are all Hellenistic: the woman holding a

cornucopia in the left bottom corner is the Greek goddess Tyche; the image on the top right might be Hercules wrestling the Nemean lion.<sup>16</sup> This wax dyed fabric is probably not a Chinese production and possibly comes from India.

16. Zhao 2012, 97.



Fig. 12. Wax resist dyed tabby (400-421 AD) found in Turfan. Xinjiang Uyghur Autonomous Region Museum

The technique of wax resist dye was probably introduced into northwest China along the Silk Road between the 3rd and 5th centuries. The wax resist dyed pattern on silk began from dots. Several single dots were arranged to form a more complicate pattern, such as floret or lozenge (fig. 12).<sup>17</sup> Wax resist dye became popular in the Tang dynasty. After that, this method became very limited to the minority area of southwestern China.

#### *Ash Resist Dye*

As wax was limited in China, people turned to use ash or other alkaline materials as the resist agent instead of wax. This will achieve a similar result to wax resist dyeing. The alkaline paste adopted in the Tang dynasty was mainly plant ash or alkaline lime. According to Wu Min's research most of the paste resist dyed silks found in Turfan are ash resist dyed.<sup>18</sup>

Sometimes ash resisted dye was combined with clamp resist dye technique. Applying the paste made of an alkaline substance on the convex parts of blocks and then clamping the textile, a paste pattern was created. The areas of the fabric that are coated by the paste will remain undyed when dipping in the dye. Such technique was commonly applied to the ash resist dyed silk in northwest China in the Tang dynasty (fig. 13).<sup>19</sup>

Since then ash resist dye was adapted to cotton cloth and became the popular blue-and-white printed clothes known in modern times.

#### **Conclusion**

Our study of the textiles and burial inventory found in tomb 26 Huahai, Gansu province, confirmed that the textiles match the textual records in the burial inventory well. The purple jacket with *xiu* [embroidery] recorded in the burial inventory should be the purple jacket with *xie* [resist dyeing]. The reason might be: firstly, tie dyeing was still a new way of decoration in the late 4th century and the patterns made by tie dyeing look like those made by embroidery; secondly, the Chinese character for tie dyeing appeared later than the technique itself, so people used *xiu* as a loan word for *xie* before *xie* appeared.

The original meaning of *xie* was tie dyeing. It gradually became a general term for resist dye in ancient China, including: tie dye, clamp resist dye, wax resist dye and ash resist dye. Tie dye appeared in the 3rd to 4th centuries, became prevalent in the 7th to 9th centuries and is still used today. Clamp resist dye was invented in the early 8th century. At first floral motifs were prevalent. Animal motifs appeared later, mainly in the 9th to 10th centuries. The technique of wax resist dye was probably introduced into northwest

17. Xinjiang Uyghur Autonomous Region Museum *et al.* 1973, pl. 49.

18. Wu 1973, 40-46.

19. Xinjiang Uyghur Autonomous Region Museum *et al.* 1973, pl. 59.



**Fig. 13.** Ash resist dyed silk with a pattern of confronting ducks and flowers (c. 721 AD) found in Tuffan. Xinjiang Uygur Autonomous Region Museum

China along the Silk Road in the 3rd to 5th centuries, and became popular in the Tang dynasty. After that, this technique became very limited to the minority area of southwestern China. As wax was limited in China, people turned to use ash or another alkaline material as the resist agent instead of wax. After the Tang dynasty, ash resist dye was adapted to cotton cloth and became the popular blue-and-white printed clothes.

### Bibliography

- Dou, L. (2013) *Bijiatan chu tu yi wu shu bu shi* [Supplementary Explanation to the *yiwushu* found in Bijiatan]. In *Kao gu yu wen wu* [Archaeology and Cultural Relics], Feb. 2013, 94-97.
- Museum of Dunhuang County (1983) Excavation of the Tombs of the Five Liang Period at Foyemiaowan in Dunhuang, Gansu Province, *Wen wu* [Cultural Relics], Oct. 1983, 51-60.
- Wang, X. (2001) *Wang Xu & Textile Archaeology in China*, ISAT/Costume Squad Ltd.

- Wu, M. (1973) The Printing and Dyeing Techniques of the Tang Dynasty as Indicated by the Silk Fabrics Unearthed at Turfan, Xinjiang, *Wen wu [Cultural Relics]*, Oct. 1973, 37-47.
- Xinjiang Uyghur Autonomous Region Museum (1973) Excavation of Ancient Tombs at Astana and Karakhoja in Turfan, Xinjiang 1963-1965, *Wen wu [Cultural Relics]*, Oct. 1973, 7-27.
- Xinjiang Uyghur Autonomous Region Museum *et al.* (1973) *Si chou zhi lu: Han Tang zhi wu* [Textiles between Han and Tang dynasties along the Silk Road], Cultural Relics Press.
- Zhao, F. (ed.) (2002), *Fang zhi kao gu xin fa xian* [Recent Excavations of Textiles in China], ISAT/Costume Squad Ltd.
- Zhao F., Wang, H., Persson, H., Wood, F., Wang, L. and Zheng, X. (eds) (2007) *Textiles from Dunhuang in UK Collections*, Donghua University Press.
- Zhao, F., Wang, H. & Wan, F. (2008) Silk Garments Excavated from Tomb 26 in Bijiatan, Huahai Gansu. In F. Zhao (ed.), *Xi bei feng ge: Han Jin zhi wu [Northwestern Imprints: Textiles from Han and Jin Dynasties in China]*, 94-113, ISAT/Costume Squad Ltd.
- Zhao F. (2012) *Jin cheng: zhong guo si chou yu si chou zhi lu* [Chinese Silk and the Silk Road]. City University of Hong Kong Press.

# The Textile Terminology in Ancient Japan<sup>1</sup>

Mari Omura and Naoko Kizawa

This paper investigates key Japanese words related to textiles and their production in ancient Japan that is during the 1st millennium AD. At this time the language known as ‘Old Japanese’ evolved and eventually systems for writing it down emerged, based on borrowing the Chinese characters. Textiles used for clothing, coverings, tax items, and ritual objects played an integral role in the society, and thus terms related to textiles provide insight into the life style, politics, religion and economy of Japan as it emerged from a tribal-based localized society into a centralized nation state. The linguistic study also points to cultural pathways along which inventions, materials, and processes passed, tying the

island country to the distant areas on the neighboring continent.

Words, their meanings, and their written forms change over time, making it difficult to pinpoint clear definitions. We have therefore approached the subject from several directions in hopes that superimposing the information from each will help clarify the picture. The core of the essay presents terms in the textile section of the earliest Japanese dictionary. It supplements these with examples of the use of the words in ancient Japanese literary resources and with iconography. The second half turns to actual tools excavated at sites ranging from the 1st millennium BC through the 1st millennium AD.

1. We would like to express our sincere gratitude for all the individuals and institutions who co-operated in this study and to Monica Bethe (Director, Medieval Japanese Studies Institute, Kyoto) who went over the English. Detailed comments on the material for dyeing and weaving tools were provided by Joy Boutrup, Chikayo Kawabe, Akiko Miyazaki, Nobue Nakama (University of the Ryukyus), Akira Shimura, and Monica Bethe. We are most grateful also to Marie-Louise Nosch for inviting us to contribute this theme, to Elizabeth Barber for proofreading, and to Professor Kazuhiko Yoshida (Graduate School of Letters, Kyoto University) and Junko Higashimura (University of Fukui) for giving appropriate advice or ideas to construct the thesis. We would like to thank Dr. Margarita Gleba (MacDonald Institute, Cambridge University) for proofreading and for leading us to the archaeological textile field in the West. Photographic materials and drawings were kindly provided by the followings: The Fukuoka City Board of Education in Fukuoka Prefecture, the Iwata City Board of Education in Shizuoka Prefecture, the Kanagawa Archaeology Foundation in Kanagawa Prefecture, the Kikugawa City Board of Education in Shizuoka Prefecture, the Kobe City Museum in Hyōgo Prefecture, the Komatsu City Board of Education in Ishikawa Prefecture, the Mie Prefectural Center for Excavated Properties, the Munakata Taisha Shinto shrine in Fukuoka Prefecture, the Shimotsuke City Board of Education in Tochigi Prefecture and the National Diet Library.

This study is supported by JSPS KAKENHI, the Grant-in-Aids for Scientific Research of Japan Society for the Promotion of Science as follows. Project number 25370847 Basic (C) The basic study of the appearance and transmission of braiding techniques in ancient Asia. Project number 25370903 Basic (C) Comparative studies on the funeral rituals in ancient East Asia throughout the research of excavated combs.

The earliest use of Chinese characters in Japan appears as inlaid inscriptions found on some excavated iron swords and cast bronze mirrors dating to around the 5th century AD. Until then the Japanese had no writing system, though China already had a well-developed one and a nationwide political system. Inscriptions found on wooden tablets and Buddhist sculptures show that in Japan a systematic writing system started about the early 7th century AD at the same time as a nationwide administrative system has emerged. It is believed that the innovative Japanese use of Chinese characters merely for their sound, known as Man'yōgana, in order to express elements of their grammar not found in Chinese, such as particles, started about the late 7th century.<sup>2</sup>

The terms concerning textile materials and production first appeared in the Chronicles of Japan such as *Kojiki* (edited in AD 712) and *Nihon Shoki* (edited in AD 720). These texts trace the genealogy of the imperial family from historical figures back to mythological times. In the former text, for example, the fiber of wisteria (*fuji* in Japanese) is mentioned as a material for weaving, and the Japanese madder (*akane* in Japanese) as a dye material.<sup>3</sup> In the latter, textile terms are reflected in the names of families or clans attached to the Court or government during the Asuka period (6th-7th centuries AD), such as *Nishikgoribe* <nishiki+ori+be (“compound-weave weavers clan”), *Kinunui* <kinu+nui+be (“garment tailoring clan”), etc.<sup>4</sup>

## Sources

About the end of the 1st millennium AD in the 930s, one of the earliest dictionaries called the *Wamyō Ruijushō* or *Wamyōshō* was edited by a poet and man of letters, Minamoto no Shitagō, at the request of the Emperor Daigo's (885-930) daughter, Princess Kinshi. It includes vocabulary for textile technologies, fabrics and clothing. In addition, the *Engishiki* (Codes

of the Engi Era), written between 907-927 (the Engi era: 901-923) details regulations of dress, including their production during the Heian period.<sup>5</sup>

It is significant that most of the textile terms found in these Heian-period sources were already in use around the 7th to 8th centuries (the Asuka and Nara period), as evidenced by the *Man'yōshū*, a compilation of older and newer poems edited in 759. This continuity of textile terminology corresponds to the continuous use of similar tools and materials for the textile production during ancient times.

Some of the terms are also found in the documents edited in the *Shōsōin-monjo* (Documents from the *Shōsōin* Repository) dating mostly to the first six decades of the 8th century. Many of these documents concerned the office managing the copying of sutras. The paper for this national project was frequently dyed, and the materials used for dyes, often also used for medicines, can be found mentioned in it.

Because some of the tools, such as spindle whorls and beaters (probably for back strap looms), were used long before the development of the Old Japanese language, it is important to go further back in time and look at related archaeological remains throughout Japan. The earliest fabrics are of twinning excavated from the Neolithic (Jōmon) sites. These are thought to have been made with weights and bars. Woven textiles have been found from the late Neolithic (Jōmon period) and the early Bronze/Iron Age (Yayoi period).

The mention of textile production at the end of the Yayoi period appears in Chinese documents on Japan, but exactly when bast fiber weaving and sericulture began in Japan is still open to debate, particularly since carbon 14 dating suggests pushing the beginnings of the Yayoi period back to around 800 BC. It is at the sites (e.g. Sasai site, Fukuoka Prefecture) dated to this period where the earliest wooden textile tools (presumably for weaving circular warped cloth<sup>6</sup>) were excavated.

2. Inaoka 1997, 407-429.

3. Yamaguchi & Kōnoshi 2004, 278-279. 88-89. Here the name of Japanese madder is written 'atane'.

4. Kojima *et al.* 2004, 174-175.

5. Kuroita 1965.

6. Higashimura 2008.

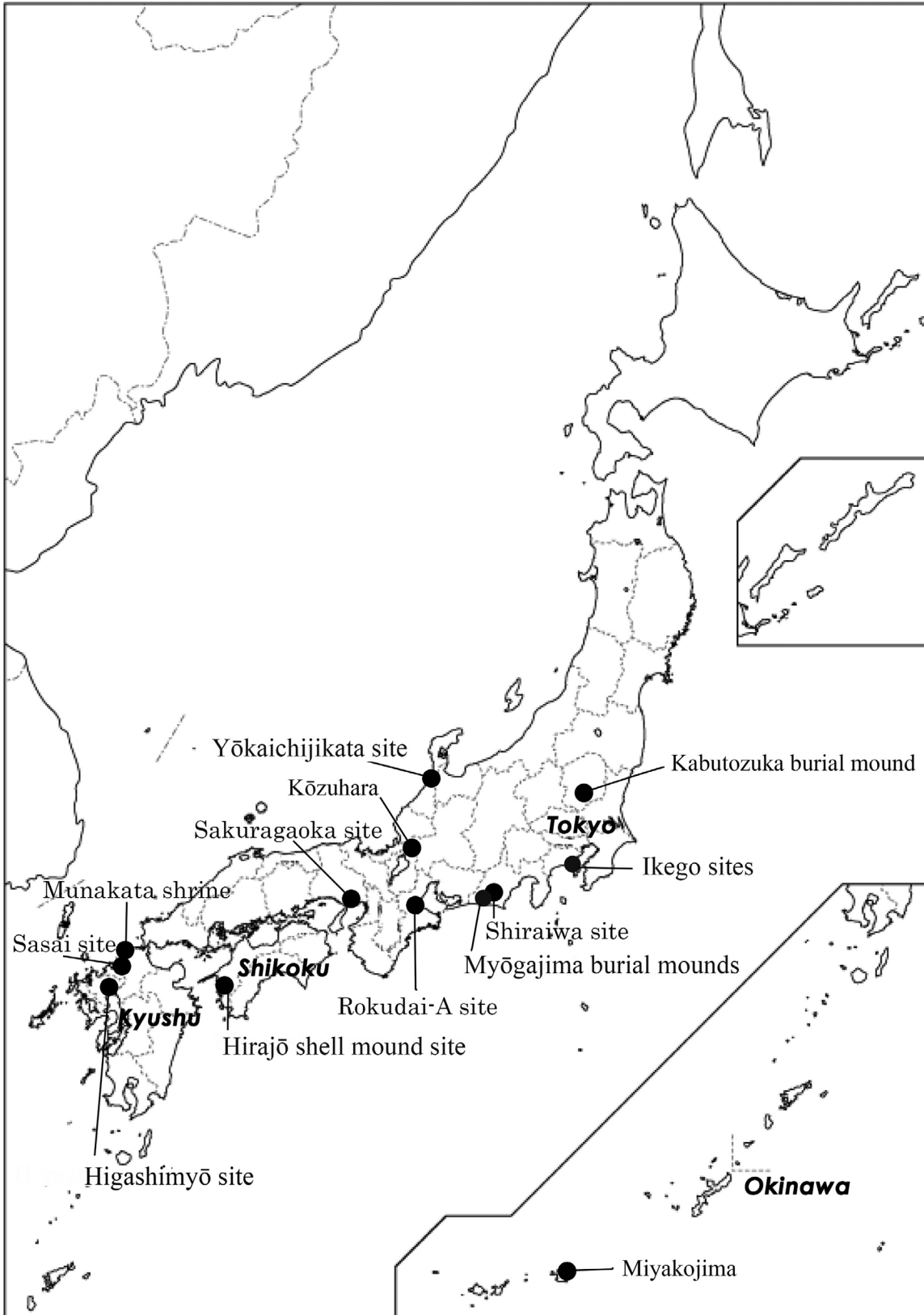
**Table 1.** Chronological table of Japan.

Paleolithic	200,000(?) - 11,000 BC (*13,000 BC by AMS)	Early, 200,000(?) - 30,000 BC Late, 30,000 - 11,000 (or 13,000) BC
Jōmon (Neolithic)	10,500 - 400 BC (*800 BC by AMS)	Incipient, 10,500 - 8000 BC Initial, 8000 - 5000 BC Early, 5000 - 2500 BC Middle, 2500 - 1500 BC Late, 1500 - 1000 BC Final, 1000 - 400 (or 800) BC
Yayoi (Bronze and Iron Ages)	400 BC (*800 BC by AMS) - about AD 250	Initial, 400 (or 800) BC - 300 BC Early, 300 - 100 BC Middle, 100 BC - AD 100 Late, AD 100 - 250
Kofun	About AD 250 - 600	Early, AD 250 - 400 Middle, AD 400 - 500 Late, AD 500 - 600
Asuka	AD 6 <sup>th</sup> century - 710	
Nara	AD 710 - 794	
Heian	AD 794 - 1185	
Kamakura	AD 1185 - 1333	
Muromachi	AD 1333 - 1573	
Momoyama	AD 1573 - 1603	
Edo	AD 1603 - 1868	
Meiji	AD 1868 - 1912	
Taishō	AD 1912 - 1926	
Shōwa	AD 1926 - 1989	
Heisei	since AD 1989	

(cf. *Ancient Japan* by the Arthur M. Sackler gallery, Smithsonian Institution and the Agency for Cultural Affairs. 1992)

\*Calibrated AMS dating are referred to the catalogue of the "『発掘された日本列島 2014』 Hakkutsu sareta Nihon-retto 2014 (Exhibitions of Excavations in the Japanese Archipelago 2014) " by the Agency for Cultural Affairs.)





Map 1. Map of the sites.

***Senchū Wamyō Ruijūshō (Dictionary of Japanese words with notes)***

The *Wamyō Ruijūshō* dictionary of Japanese is based on one style of Chinese dictionaries, like the *Erya* 爾雅 (the 3rd century BC), and covers vocabulary for various fields, including textiles, noting the source, the meaning, the annotation, the Chinese-derived pronunciation and the Japanese reading, using the Man'yōgana. This kind of dictionary was required by an increasing number of educated readers, including women like Princess Kinshi, who wished to read and understand texts written in Chinese, including records and tales. Most of the official documents and academic pieces were written in Chinese. Although the original manuscript of the *Wamyō Ruijūshō* was lost, it was copied and exists today in variant texts (printed and manuscript versions). What follows is based on the *Senchū Wamyō Ruijūshō*<sup>7</sup> revised by the Japanese scholar Ekisai Kariya, in 1827 during the Edo period. He compared several versions of the texts in great detail providing a clear overview of the material.

***Man'yōshū***

The anthology *Man'yōshū* (ten thousand leaves collection) was edited by Ōtomo no Yakamochi (about AD 718-785), a famous poet during the Nara period. In the *Man'yōshū*, over 4500 pieces of *waka*, traditional Japanese poems, are collected. They include poems by people of all ranks, composed during 400 years before AD 759. The poems contain many native Japanese words, called *wa-go*, and show little Chinese language influence. The original texts are lost, but the earliest poems seem to have been written down using Chinese characters purely as phonetic symbols known as the Man'yōgana.

We will introduce how these words were used to represent the scenes in the poems.<sup>8</sup> It is difficult for modern readers to understand the poems in their

original orthography. They were written down using Chinese characters both for meaning and at other times for phonetic value and several different characters could express the same sound.

**Terms Appearing in *Senchū Wamyō Ruijūshō***

Here we have kept the category and the word order as it appears in the *Senchū Wamyō Ruijūshō*. According to the classification, the terms for cloth and clothing (costume) are categorized independently under the main heading (*bu*, literally section or part). The terms for tools for cutting (*tatsu* or *kiru*: to cut) and sewing (*nufu*: to sew), dyeing (*somu*: to dye < *shimu*: to soak into, in modern times it is written *someru* and *shim-iru*), weaving (*oru*: to weave), sericulture (*kogahi*), interior *etc.* correspond to subheadings (*ru*, literally kind or sort), which are included under the main headings for the 'furnishing'. This paper focuses on the terms related to cloth and tools for textile production.

Although the headings are originally Chinese terms written in Chinese character, here they are replaced with the Japanese style reading corresponding to those found in the text.<sup>9</sup> Their sounds shown here are based on the old use of *kana*, the Japanese syllabary at that time. Because the modern use of *kana* appeared in instructions given in 1946,<sup>10</sup> until then the old use of *kana*, which started at early Heian period, had continued almost uninterrupted with few changes. It is said that in many cases the sound would have shown the characteristic of those pronunciations from the South Chinese dialect called Wuyin.<sup>11</sup> If there are multiple Japanese readings, they are written down together. The problem is that some of the terms have not been given native Japanese words in the dictionary, which are to be replaced as headings here. Ōtsuki mentioned that it was because some terms would have been read using the Chinese terms' sound and the rest would have no source to refer to in the author's materials even if they had Japanese style readings. Others

7. Kyoto Univ. 1999, 1-525.

8. Inaoka 1997.

9. Kyoto University 1999.

10. Tsukishima 2014, 11.

11. Tōdō 1995, 1584.

which show Japanese readings surely have the reference noted.<sup>12</sup> In the latter case the Japanese readings are covered by those from other parts of this dictionary or archaic word dictionaries. The former is placed in single bracket ( ), and the latter is placed in double bracket (( )).

Since both Chinese and Japanese style readings have changed, these terms do not always correspond to modern ones. In addition, there are often multiple Chinese style readings for one Chinese character, depending on the region and period.

Illustrations are taken from an Edo-period publication of the *Wakan Sansai Zue*,<sup>13</sup> originally edited in 1712 by Ryōan Terajima, and from the *Kishoku Ihen*,<sup>14</sup> a manual for textile technology during the Edo period edited in 1830 by Masunari Ōzeki, one of the feudal lords.

The terms for silk and the bast fiber processing found in these books follow a traditional style that is consistent from ancient times through the end of the Edo period (middle of the 19th century) when Japan opened the country to foreign trade and diplomatic relations.

### *Cloth*<sup>15</sup>

In the following, the Chinese-style reading reconstructed of the Early Middle Chinese, from the Sui to Tang dynasties or earlier<sup>16</sup> of a character will be preceded by a ‘Ch’ for China, and the Japanese style by a ‘Jp’ for Japan. When needed, modern Japanese reading will be added for references preceded by a ‘MJp’.

The terms for the cloth, bast fiber cloth, silk cloth, consist of two parts. These include bast fiber cloth (Ch: pə<sup>h</sup>, Jp: *nuno*) and silk cloth or fabric: (Ch: baijk/bɛ:jk, Jp: *haku-no-kinu*) and others. They are divided into patterned silk fabrics such as compound weaves and patterned in weft and warp faced twill, on the one hand, and plain weave and other materials on the other.

12. Ōtsuki 2004, 1,17.

13. Terajima 1824. Courtesy of the National Diet Library Digital Collection: the chapter entitled “Women’s handcraft tools”; info:ndjp/pid/2569720 [24]

14. Ōzeki 1830.

15. Kyoto Univ. 1999, 176-180.

16. Pulleyblank 1991; Tōdō 1995.

### *Terms for nishiki (compound patterned weave) and aya (patterned in weft and warp faced twills)*

***Nishiki***: a general term for multicolored patterned weaves of various structures. At the time the dictionary was written, it probably referred to samite, a weft-patterned twill compound weave. In the Asuka-Early Nara period, *nishiki* referred to warp-faced compound weaves, introduced already in the 5th century, and weft-faced compound weaves, some with a plain weave ground but many with a twill ground, introduced in the 8th century. The dictionary specifies several types of *nishiki*: *ungen nishiki*, a samite with gradated stripes including small patterns, *koma nishiki*, compound weave with Korean (Koguryo) patterns, *ryōmen nishiki*, two-sided multicolored pattern weave, possibly a double weave. Because *nishiki* textiles were valued as highly as gold, the Chinese character for *nishiki* 錦 combines gold 金 as a radical on the left with silk fabric 帛 on the right.

***Ori-mono/ kamuhata***: 綺 (Ch: k<sup>h</sup>jiē’/ k<sup>h</sup>ji’) woven cloth with a woven pattern in more than one color, *ori*<*oru*: to weave, *mono*: thing

***(Tokachi)***: Fabric made from spun hare or rabbit hair. Headdresses (caps or hats) were made with this fabric. Rabbit is called Jp: *usagi* (Ch: t’o).

***(Kaukechi)***: clamp-resist dye, Jp: *itajime*. Because the original heading is nowadays read *kyōkechi*, clamp-resist dye, this term seems to be confused with *kōkechi*, tie-dye, Jp: *yu-hata*, *yufu*: to tie or to knot, *hata*: fabric. Even though E. Kariya mentioned that later it was (and still is) called Jp: *itajime*. ***Ita***: board(s), *jime*<*shimu*: to tighten. (MJp: *shimeru*). *Man’yōshū poem* no. 3791 mentions a dress with tie-dyed design sleeves.

***Numu-mono***: embroidery, *nufu*: to sew (MJp: *nū*), *mono*: thing or material. In the chronicles it is read *nuhimono*.

***Aya***: 綾 twill (often patterned in weft and warp faced

twill). *Man'yōshū* poem no. 3791 mentions a violet dress made of silk twill. (Ch:liq).

**(Ra) / ((Semi-no-ha)):** (Ch: la) Leno or gauze i.e. crossed warp weave called also *usu-mono* or *usu-hata*, in the Chronicles. *Usu*(<*usushi*): thin or transparent, *mono*: thing, *hata*: fabric. *Man'yōshū* poem no. 3791 mentions gauzy cloth. *Semi-no-ha* means wings of the cicadas.

**Kome/kome-no-kinu:** a type of patterned gauze-weave silk, E. Kariya suggests the reading: *kome*<*kagome* (woven pattern of the basketry, *kago*) and *kinu* (silk fabric) and suggests that the surface of this fabric looks like the spreading rice grains.

**Katori:** closely woven silk cloth with fine raw silk threads.

**Terms for kenpu (kinu and nuno): (silk and bast fiber cloths)**

**Kinu:** 絹 (Ch: kjwian<sup>b</sup>) silk fabric. It seems that there exists a phonetic resemblance between these terms.

**Neri-kinu**(<*kinu*): degummed silk fabric

**Ashi-kinu**(<*kinu*): coarse silk fabric

**Haku-no-kinu:** fine (or thin) silk fabrics, thin plain weave

**(Sha):** gauze weave made of fine (raw) silk threads (Ch: 紗/せ:)

**Nuno:** 布 bast fiber fabrics using the fiber of *asa* hemp, *karamushi* false nettle, or *ku(d)zu* (*Pueraria lobata*, Japanese arrowroot), etc.

**Tezukuri-no-nuno:** hand woven bast fiber cloth. *Man'yōshū* poem no. 3373 mentions the process of bleaching the *tezukuri-no-nuno* in the *Tama* River (near present day Tokyo).

**Asa (karamushi)-nuno:** cloth made of false nettle, ramie, *Boehmeria* Jacq., such as *Boehmeria nivea*.

**Tsuki-no-nuno:** cloth for taxation. One of the taxes in kind, *tsuki*. Cloth is also accepted in order to

replace a labor tax, or corvée called *yō*.

**Sayomi-no-nuno:** cloth made of threads taken from the inner bark of the Japanese linden tree, *Shinanoki*. *Tilia Japonica* Simk (or lime tree, bass-wood)

**Tani:** cloth made for sale or trade, not for tribute.

**Wata:** silk floss

**Tools and materials for textile production**<sup>17</sup>

*Cutting and Sewing*

In ancient times in Japan, no vocabulary existed related to wool and cotton manufacture, though mention was made of cloth made from the hair of *usagi* (hare or rabbit). Yet, beautiful woolen felt carpets from the Nara period were stored in the *Shōsōin* Treasure House, possibly imported as gifts to persons of high rank. The words 'hitsuji' (sheep),<sup>18</sup> 'kamo' (felt carpet) and 'ori-kamo' (woven carpet) are found under the headings of 'animals' and of 'rugs/mats'. It is significant that even the Chinese might have borrowed their word for sheep from some form of Iranian or Tocharian language.<sup>19</sup> The terms for tools related to cutting and sewing follow below.

**Kara-usu:** a (Chinese style) mortar for pounding cloth (in this case). The same style mortars were also used for polishing rice by stepping on a board attached to the mallet. *Kara* means "Chinese or foreign style".

**Kinu-ita:** a stone block on which clothes are beating to soften them. (MJp: *kinuta*)

**Tsuchi:** wooden mallet to beat (*utsu*) the clothes.

**Kata-ki:** woodblock carved with a pattern for dye-printing.

**Mo-no-tachikatana:** a knife for cutting clothes.

**Takahakari:** bamboo ruler (*taka*: bamboo, we now call it *take*), *bakari* is from *hakaru* (vb.), to measure.

**Hari:** needle (it is also used for medical treatment, such as acupuncture and moxibustion)

17. Kyoto Univ. 1999, 306-315.

18. Kojima *et al.* 2004, 534-535. In the *Nihon Shoki*, a camel (*rakuda*), a donkey (*usagi-uma*, literally a horse which has rabbit's ears, nowadays *roba*) two sheep and a white pheasant (*kigisu*, nowadays *kiji*) were mentioned as offerings from Paekche in the 7th year of Empress Suiko (599 AD).

19. Mallory & Mair 2000, 229.

**Hari-tsutsu:** cylindrical needle case.

**Oyobinuki:** ring-shaped (metallic) thimble. Nowadays we call it *yubinuki*, *yubi* means finger(s) and *oyobi* is its old form. *Nuki* comes from *nuku* which means through something.

**Noshi:** a kind of iron (or presser), a dipper-shaped metallic tool with a charcoal fire to make clothes and fabric smooth.

### Materials for dyeing

The terms for dyestuffs come next. They are mainly names of plants. We have added their Latin names after the Japanese terms for general identification. The dyes were used not only on fabrics, but also to dye papers for sutra-copying. Dye materials were important tribute items and are mentioned in the *Engishiki*. Previous studies about the historical use of dyestuffs proved helpful to our study.<sup>20</sup>

Color played an important role as an indicator of rank in the Japanese government of ancient times. The concept of wearing garments distinguished by rank-regulated colors was adopted along with other aspects of the Sui and Tang dynasty Chinese administrative system, which was formulated in Japan as legal code known as *ritsuryō*. This included stipulations about textile production, taxation (including threads, fabrics, and dyes) and designation of court ranks. In 603, Prince Shōtoku (AD 574-622) established the “*Kan-i* (crown rank) *jūni-kai* (12 levels)”, a system whereby court ranks were distinguished by the color of the headgear.<sup>21</sup> Lighter and darker shades of six colors were used to indicate 12 ranks in the court. The order of colors as set by Prince Shōtoku from the highest rank down was as follows, though this order changed over time: *Murasaki* (purple or violet)/ *Awo* (blue)/ *Aka* (red)/ *Ki* (yellow)/ *Shiro* (white)/ *Kuro* (black).

These and other colors were dyed with the following plants.

**(Suhau):** LEGUMINOSAE *Caesalpinia sappan*, L. (sappan wood). Nowadays it is written *suō*.

(Native to India and Malaysia). *Suō* chips from the Nara period are still stored in the *Shōsōin* Repository. *Suō* was used both to stain wood and to dye fabric and sutra papers. Dyes reds and purples.

**Hanishi:** ANACARDIACEAE *Rhus* L. *Rhus succedarea* L. (Japanese wax tree). MJp: *haze*. Dyes tan to brown.

**Kihada:** RUTACEAE *Phellodendron amurense* Rupr. (Amur Cork). Used as dyestuff for sutra scroll papers and binding ribbons. Dyes yellow.

**Kuchinashi:** RUBIACEAE *Gardenia jasminoides* Ellis. (Gardenia) Dyes a warm yellow.

**Tsurubami:** FAGACEAE *Quercus* L. *Quercus acutissima* Carruth. MJp: *kunugi*. Acorn caps. Dyes grey to black. *Tsurubami*-dyed garments are mentioned in *Man'yōshū* poems nos. 1311. 1314. 2965. 2968 and 4109.

**Akane:** RUBIACEAE *Rubia akane* Nakai. (Japanese madder). Dyes red. According to the *Engishiki*, *akane* was included among the agricultural tributes through the Heian period, but the ancient dye methods were lost by the Edo period or earlier. Recently, Akiko Miyazaki tried to reconstruct the technique using the material and tools found in the *Engishiki*.<sup>22</sup> She discovered that both brown rice (*genmai*) and polished rice (*hakumai*, literally white rice) would have been fermented to extract the red (*aka*) colorant from the plant root at that time. The Japanese name of this plant *aka-ne* (red root) comes from the red color of the plant roots. In the *Man'yōshū*, *akane* is used to express the brightness of evening and the light of day in poems nos. 20. 169 and 916. (cf. *aka-shi* (adj.) means bright, light). (MJp: *akarui*)

**Murasaki:** BORAGINACEAE *Lithospermum officinale*, L. subsp. *erythrorhizon* (Sieb. et Zucc.) Hand.-Mzt. (Gromwell). Dyes purple.

Textiles and threads were mordanted with the camellia ash, which is known to contain aluminum, and then dyed with *murasaki* root. According to the *Engishiki*, *murasaki* was an agricultural tribute during the Heian period. The purple

20. Uemura 1979; Gotō & Yamakawa 1937.

21. Kojima *et al.* 2004, 540-542.

22. Miyazaki 1997, 1-21.

dyed with *murasaki* was restricted to the people of the highest rank in the Court.

In the *Man'yōshū*, *murasaki* appears as a plant that grew in a field guarded for the Imperial Court (no. 20), also as a color of threads (no. 1340), of clothing (no. 3791), and as a dye for clothing (nos. 395 and 3101). In poem 3101, the use of ash as a mordant is mentioned. Other poems including the term *murasaki* are as follows: Nos. 21, 395, 1825, 2974, 2976, 2993, 3099 and 3500.

**Kure-no-awi:** (MJp: *kurenai*) ASTERACEAE *Carthamus tinctorius*; safflower, (originally introduced from West Asia). Dyes pink to red (also yellow). Jp: *kure* refers to the name of the Chinese kingdom *Wu* (AD 222-280). The flower petals are used to dye red though in other countries they dye yellow. Recent analysis using fluorescence spectrometry on *Shōsōin* items revealed that safflower red was used to dye a carpet, an undergarment, a gown with tie-dye design, and a pair of shoes.<sup>23</sup> In the *Man'yōshū*, *kurenai* is often mentioned as a color that fades easily. The term is found in following poems; Nos. 1044, 1297, 1313, 1742, 2623, 2624, 2655, 2827, 2828, 3877, 3969, 4109 and 4157.

**Awī:** (MJp: *ai*) Two plants names are mentioned here as the contents of the other book of pharmacy or pharmacology *Honzo Wamyō* written in the Heian period (about 918) by Fukane Sukehito. One is *tsubaki-awī*, The original Chinese term means 'wood indigo' (*ki-awī*). Although we do not know exactly which plant corresponds to it, there are two possibilities; one is *ryūkyū-ai*, ACANTHACEAE *Strobilanthes flaccidifolius*, Nees. The other is *indo-ai*, FABACEAE *Indigofera tinctoria*, L. The other is *tade-awī*: POLYGONACEAE *Polygonum tinctorium* Lour. (Originally imported from China for cultivation in Japan<sup>24</sup>). Dyes blue. Lake colour called *awishiru* (sap of *awī*) taken from *kiawī* was mentioned as well.

Note that the *Yama-awī*; EUPHORBIACEAE *Mercurialis leiocarpa*, Sieb. et Zucc., was native

to Japan, but is missing from the *Wamyō Ruijūshō*, though it is found in the *Engishiki*. The *Man'yōshū* mentions it as applied by rubbing it into cloth to print blue color (No. 1742). The usage of the *Yama-ai* has already been forgotten in modern days though it had been used to decorate the imperial garment for the coronation ceremony, which is called 'omi-goromo'. Kiichi Tsujimura studied the materials and reconstructed the dyeing method.<sup>25</sup> He discovered a place where this plant grew naturally and investigated how it can be successfully printed. *Yama-awī* is named after the color of *awī* indigo, though it does not contain indigotin.

**Kaina:** *Miscanthus tinctorius*. Dyes yellow. (MJp: *kariyasu*)

It was used to dye sutra papers according to the *Shōsōin* documents.

**Tsukikusa:** *Commelina communis* L.; (Dayflower). Dyes an impermanent blue.

The water-soluble colorant in the dayflower is squeezed from the flower and used to print cloth by rubbing, though the color fades easily (*utsurofu*, MJp: *utsurou*). In the *Man'yōshū* the impermanence of the color appears in poems: nos. 583, 1255, 1339 and 1351.

**Aka-hiyu:** AMARANTACEAE *Amaranthus mangostanus* L.

**Akaza-no-hahi:** ash (MJp: *hai*) from the plant called *akaza*; CHENOPODIACEAE *Chenopodium album* var. *centrorubrum*. Used for degumming. According to the *Engishiki*, *wara-bai* (straw ashes) were prepared to degum the silk threads.

**((Hisakaki-no-hahi)):** ash of the *hisakaki* tree and leaves, THEACEAE *Eurya japonica* Thunb. It is suggested that it would be a kind of *tsubaki-no-hahi*, ash taken from camellia. Used as a mordant. Aluminum is richly contained in its ash. The *Man'yōshū* poem no. 3101 indicates that *murasaki* dyestuff requires ash (presumably taken from *tsubaki*) for mordanting.

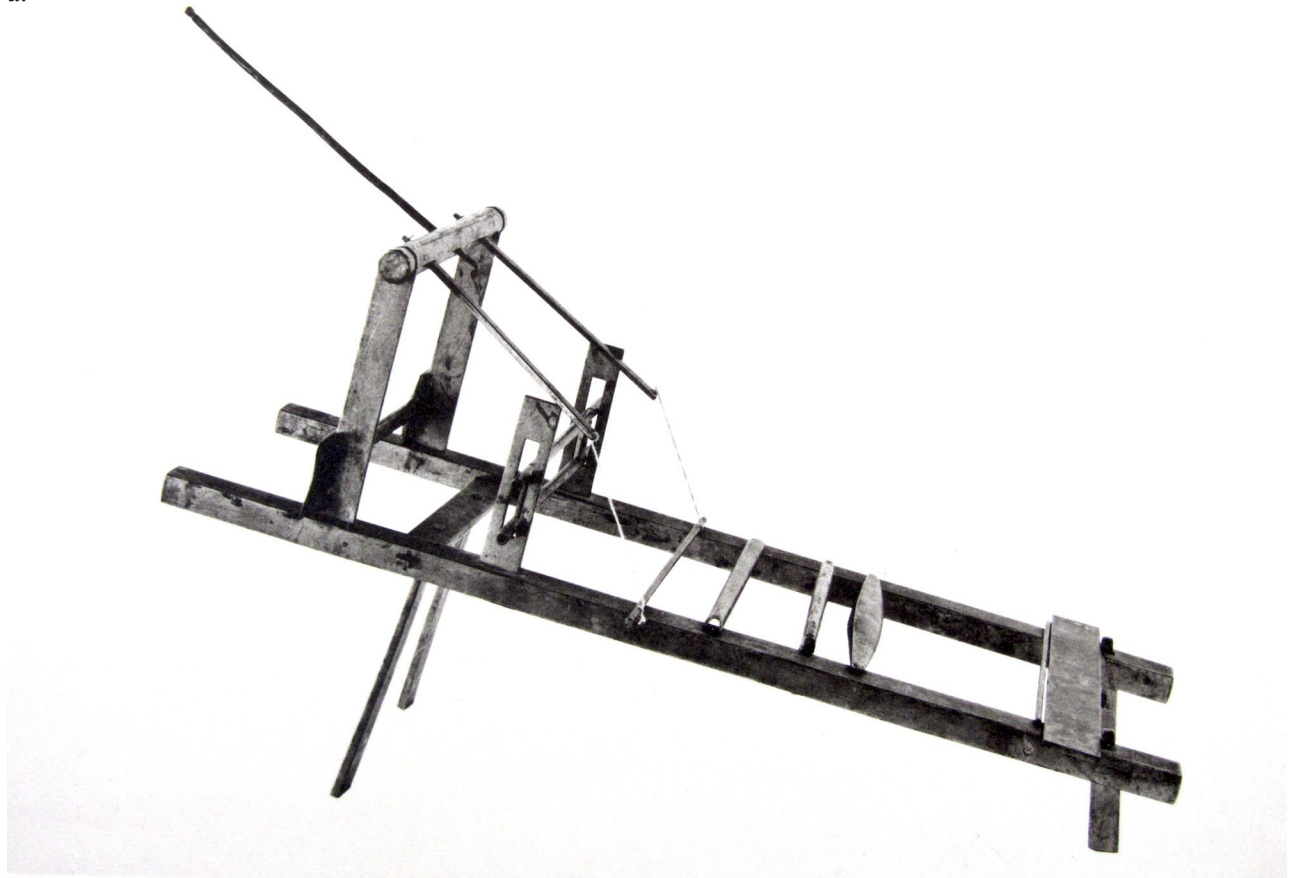
**Aku:** lye. Water poured through ashes leaches the alkaline and mineral content and produces lye, used

23. Nakamura *et al.* 2014.

24. Kitamura & Murata 1973, 312.

25. Tsujimura 1984.

a.



**Fig. 1.** A model loom (length: 48 cm, width: 16.7 cm, height of the front legs: 12.8 cm) : a) Side view (left); b) Back view (center); c) A boat shuttle (right center and lower) and a reed (right upper), 8th to 9th centuries AD, excavated from the ritual sites in Oki no Shima Island, Munakata Taisha Shinto shrine, Fukuoka Prefecture. (National Treasures) Courtesy of the Munakata Taisha Shinto shrine.

as an alkaline used for degumming or as a mordant depending on the mineral content.

### *Weaving tools and materials*

The *Senchū Wamyō Ruijūshō* lists weaving tools next. To illustrate this section, we have used pictures of ancient excavated textile tools, of ritual tools from shrines, such as the Munakata Taisha Shinto shrine<sup>26</sup> and later drawings taken from an Edo-period encyclopedia edited in 1712, the *Wakan Sansai Zue*<sup>27</sup> and

from an early 19<sup>th</sup>-century textile production manual, the *Kishoku Ihen*.<sup>28</sup> Although these drawings are more recent than the period under discussion, archaeological evidence and early paintings suggest the general form of many of the weaving tools did not alter significantly until recently.

**((Hata)):** loom, see Fig. 1

**Taka-hata:** (treadle loom, literally ‘high-loom’) was used for weaving silk fabrics. E. Kariya presumes that this included patterned weaves like compound

26. Munakata Taisha Hukkōkisei-kai (ed.) 1979, Pl. 93

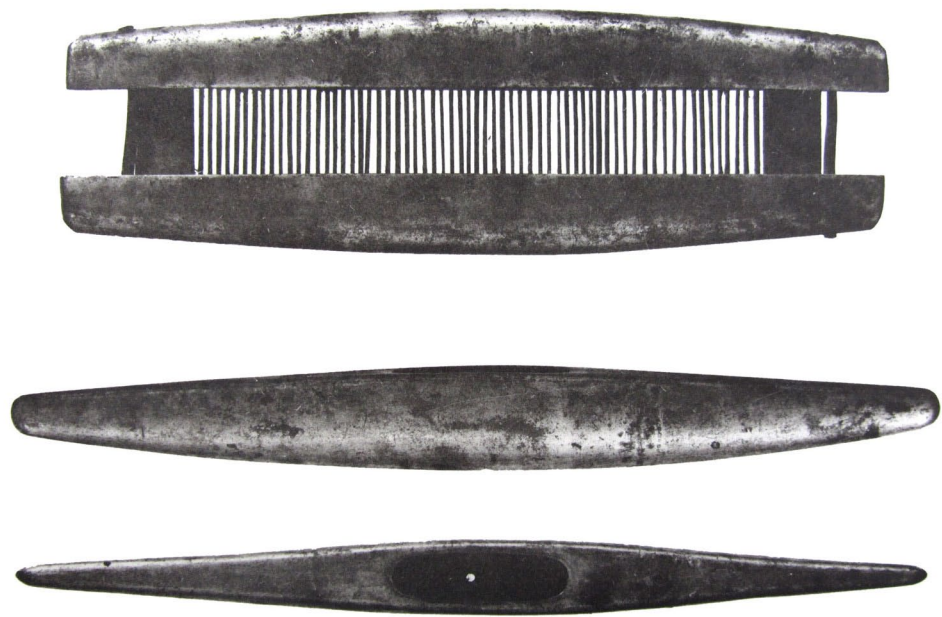
27. Terajima, 1824 (info.ndjp/pid/2569720 [24])

28. Ōzeki, 1830.

b.



c.







**Fig. 2.** Miniature textile tools including *tatari* (fiber stands), *tsumi* or *tsumu* (spindle whorl), *kase* or *kasehi* (niddy noddy), *woke* (a container for spliced threads) and *kushi* (comb) or beaters. 6th to 9th centuries AD, excavated from the ritual sites in Oki no Shima Island, Munakata Taisha Shinto shrine, Fukuoka Prefecture. (National Treasures) Courtesy of the Munakata Taisha Shinto shrine.

weaves and patterned twills.<sup>29</sup> He was inspired by the opinion of Kotosuga Tanikawa, an 18<sup>th</sup>-century scholar, who argued that the character for woven patterning 繪 (*e*) can also be read as *hata* indicating the patterns are woven on a loom 機 that has some mechanism to produce patterns.

The exact form, however, of the *takahata* or *takabata* loom used in ancient times remains unknown. Old texts supply several hints. For instance, a record from the 8<sup>th</sup> century concerning the origin of the Dai'anji Temple<sup>30</sup> in Nara, lists *takahata* among cloths for men's garments, noting it is red, but giving no explanation of its weave structure or pattern.

References to looms in the *Man'yōshū* use the term *tana-bata* (literally 'shelf-loom'). *Man'yōshū* poems nos. 2027 and 2040 refer to women weavers as *tana-bata tsu-me* (shelf-loom-weaving girl). No.2062 describes the *maneki* (foot pedals, literally *fumu*: to tread or step on with the feet + *ki*: wood), of her loom being set up by the riverside, which would enable her lover to cross a river, the Galaxy, using them as a bridge, a reference to a local myth.<sup>31</sup> Whether the *tana-bata* was a type of *taka-bata* needs further research.

The Chinese character for a loom 機 *hata* is composed of a radical indicating the material the loom is made of: 'wood' 木 and the construction

29. Kyoto University 1999 (E. Kariya, *Senchū Wamyō Ruijūshō*), 310.

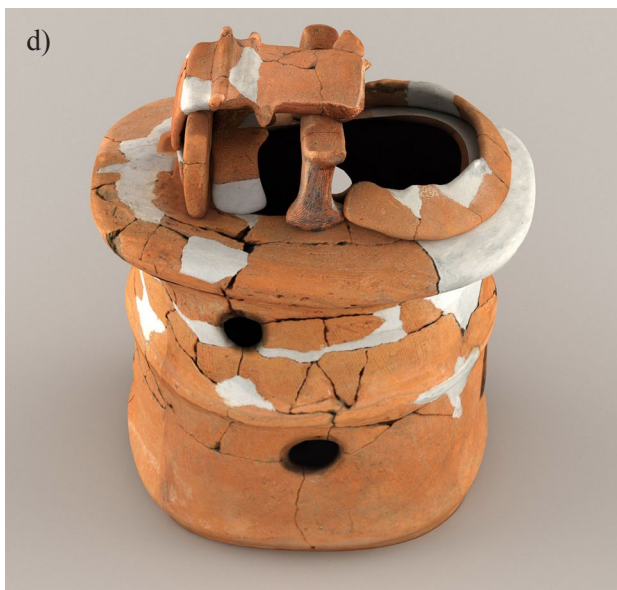
30. *Dai'anji Engi Ruki Shizai Chō*, 19<sup>th</sup> year of the Tempyō Era (AD 729-749).

31. Perhaps by association with "weaving girls", the Japanese came to call their seasonal rites on the seventh day of the seventh month *Tanabata* and incorporated into them the Chinese tradition of honoring the annual tryst of the weaving girl (the star Vega) with her Oxherd lover (the star Altair).

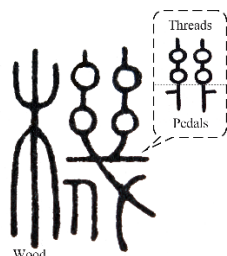


**Fig. 3.** Clay figurines from the 6th century Kabutozuka Kofun burial mound:

- a) Side view of a frame back strap loom;
- b) & c) Reconstruction of the loom with a weaver by CG, the side and back views;
- d) & e) A part of loom without frame. Courtesy of the Shimotsuke City Board of Education, Tochigi Prefecture.



of the loom showing foot pedals attached to string heddles and/or harness. This style of character is found after the Warring State period in China. Its predecessor does not have the part for wood.<sup>32</sup> The historical development of the looms would have been reflected in the form of the character.



The left side of the character means wood (material to make the loom). The foot pedals are connected to the heddles (*he*) with threads of harness, as the top right part indicates. This part is the simplified version of the original letter composed from threads and pedals. The bottom right part indicates the sound of the character.

This same 機 character was read as *wakatsuri* or *wokotsuri* in a tale in the *Nihon Ryōiki* (Miraculous Tales of Buddhism, compiled in the early 9th century AD).<sup>33</sup> The tale relates how a crane with *wakatsuri* or *wokotsuri* (probably a kind of pulley) was used to rescue people who had fallen into a hole in the mountain. E. Kariya goes on to comment that this might be the origin of the name for heddles, nowadays called *kazari*. Perhaps the loom might have used pulleys to operate the heddles.

**Hi:** shuttle, boat shuttle (right center and lower).

**Wosa:** reed. Fig. 1c (right upper) (MJp: *osa*)

Reeds in Japan were generally made of finely split bamboo. This tool was not always required to weave cloth. Beaters that seem to have been used for back strap looms have been found in many archaeological sites in Japan. The wood used tended to be hard wood. Wooden combs *kushi* are sometimes mentioned in a context of combing tangled fibers or threads for textile preparation, though

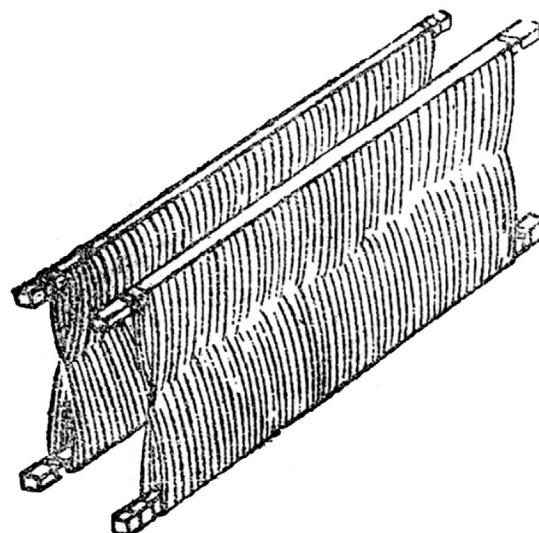


Fig. 4. He (heddles), ayatori from the *Kishoku Ihen* (Saigusa 1946, 542).

in the *Wamyō Ruijūshō* combs were categorized among the cosmetic tools.

The *Man'yōshū* poem no. 1233 describes young girls combing the warp (of bast fiber) with a “*magushi* <*ma-kushi*: excellent comb” on the loom. Its historical development and typological analysis reveal some interesting aspects in the context of ritual and cultural interaction among areas.<sup>34</sup>

**Chikiri:** warp beam. cf. *Chimaki* (cloth beam)

**He:** heddles; Fig. 4 (During the Edo period it was also called *ayatori*, *kazari*, *mojiri* and *akeito*)

**Kutsuhiki:** frame back strap looms; Fig. 1

These looms have a foot pull-rope to operate one heddle with the weaver's foot. *Kutsu* literally means ‘shoe(s)’, *hiki* <*hiku*, to pull. A 6th century clay model of this style of loom was recently found among the clay figurines excavated from the late Kofun period Kabutozuka burial mound in Tochigi Prefecture, northern Tokyo area of the Honshū Island. A part of another clay model presumed to be a back strap loom (for two-layer circular warp) without frame was also unaed (Figs. 3d & 3e).<sup>35</sup>

32. Katō 1970, 144-146.

33. Izumoji 1996, 146-148.

34. Kizawa 2011; 2014, 47.

35. Shimotsuke City Board of Education (ed.) 2014.

It is significant that the Chinese term which is used as the heading 臥機 in the dictionary literally means ‘lying loom’. It does not mean foot or shoes at all. In addition, the depicted Chinese looms had already been prepared with pedals to operate the heddles since at least the Later Han dynasty. Japanese style reading means that they would have used a foot pull-rope to operate the heddles traditionally in Japan.

In general, the loom in East Asia is not upright (except for that of straw mats ‘*mushiro*’ and/or bamboo blinds ‘*sudare*’ and ‘*misu*’ producing) though in the Orient both types are included. In order to understand the reason for which the character meaning “lying” is added to the Chinese term, further discussions will be required.

The *Engishiki* mentions a ritual concerning garments made for the *kami* god twice a year, in spring and autumn. The production of textiles for goddesses was treated as sacred work that was carried out in two different shrines near the grand shrine of Ise in Mie Prefecture, where the sun goddess Amaterasu-omikami and the goddess of grains Toyo’uke-no-omikami are enshrined as the ancestors of the Imperial Household. In one shrine, silk threads were prepared and woven by the Hattori clan: *hata* (loom) + *ori* (<*oru*, to weave). The woven cloth was called *nigitaie*, fine and soft cloth. In the other shrine, *asa* (or *wo*, hemp and false nettle) threads were prepared and woven by the Woumi clan: *wo* (hemp) + *umi* (splice or ply-join). The woven cloth was called *aratae*, coarse cloth.

The existence of the two clans specializing in different fabric production suggests that initially weaving for the Imperial family was a localized art. The Hattori (*hata-ori*) clan (*be*) would have specialized not only in weaving but also in tailoring. It is believed that the system was based on that of Paekche, and was replaced in 645 after the Taika Reforms. Again, arguing from the semantics of names, the splicing method of joining bast fibers base to tip into long threads must have been wide spread since we can find villages called *Woumi* in various places throughout Japan. The members of the *Woumi* clan belonged to the upper clan Kam-be, (*kami*, god) section or clan for

ritual, which was attached to the shrines and paid taxes only to the shrine. The hemp and false nettle fibers were used for important Shrine purification ceremonies called *harahe*, MJp: *harai*, literally meaning to remove or get rid of evil spirits.

The *Engishiki* mentions gold- and silver-plated bronze tools including *tatari*, *woke* (container for spliced threads originally made of steamed and bent wood), *kasehi*, and *tsumi*. Twenty-one kinds of holy treasures, including textile production tools, such as spindles and fiber stands, have prepared for each 20-year reconstruction of the grand shrine of Ise over the past thousand and more years. Actual examples from the early Heian period still exist. A gilt bronze *hata* (loom) and *hi* (shuttle) from the 8th to 9th centuries (Fig. 1) were found in the Munakata Taisha Shinto shrine located on two small islands in the open sea of Genkai *nada* and northern Kyūshū where three goddesses of sailing, daughters of the Sun goddess, are deified. Munakata Taisha Shinto shrine consists of three shrines (Okitsu-gū, Nakatsu-gū, and Hetsu-gū) situated in different places. Okitsu-gū is enshrined on the small island Oki-no-Shima, half way between Japan and Korea. Nakatsu-gū is enshrined on the small island Ōshima and Hetsu-gū is located on the Kyūshū Island. The shrine has long been held sacred and these tools seem to have been made for the goddess’s use.

**Maneki:** foot pedals. Nowadays this term is used for harness levers to move a heddle (see model loom, Fig. 1)

**Nukikaburi:** bobbin winder or winding.

**Kuta:** bobbin core. MJp. *kuda* literally means ‘tube’.

**Wi-no-ashi:** cloth beam (see model loom, Fig. 1).

Literally, the term means foot of the wild boars though the meaning is hoof(s) since the both beam ends look hoof-like in shape. 猪 *Wi* means the wild boars and *ashi* means feet (or foot). (MJp. of the wild boars: *i-no-shishi*).

A part of the loom onto which the woven cloth is wound up.

**Asa:** (Ch: mai/mɛ: / Jp: *wo*, *so*)(MJp: *o*): a generic term referring to bast fibers, such as hemp: *taima* (*Cannabis sativa* Linne) (Ch:da<sup>h</sup>/daj<sup>h</sup>+mai/mɛ:) and false nettle (various species of *Boehemia*, in

the family of the *Urticaceae*, often called ramie or Chinese grass in English, and referring mainly to *cho-ma* (Ch: driä'+mai/me:) or Jp: *karamushi* (*Boehmeria nivea* L. Gaud). Kitamura and Murata mention that the *Boehmeria nivea* L. Gaud was brought from China already in ancient times.<sup>36</sup>

To splice: *umu* is the verb used for making long threads out of bast fibers (*asa*) like hemp, false nettles, and *bashō* (banana plant fiber). Various splicing or ply-joining methods have been used, but an important key for making all ply-joins (*ito-umi*) is “to join the base of the new element to the tip of the old element by plying them together with a Z or S twist, or a combination of the two.”<sup>37</sup>

To twist: *hineru* or *yoru*, general terms for adding twist

To spin: *tsumugu*, for silk floss and cotton

In the *Man'yōshū* poem no. 2990, young girls splicing beaten bast fibers (*uchi-so*) set on *tatari* (fiber stands) think of their lovers, their activity of making continuous thread serving as a metaphor for the continuous longing in their hearts. Here, the word *umu* (splice) is pronounced the same way as *umu* (grow tired), creating a play on words, with *umu* meaning both tireless effort for ‘splicing’ and longing for someone without ‘getting tired’.

**Heso:** hollow thread balls. The navel is also called *heso*.

### **Tools and materials for silk thread production**

**Kahiko:** silkworm (*Bombyx mori*; silkworm moth) (MJp: *kaiko*).

**Mayu:** cocoons.

**Kuha-mayu:** wild silkworms (*Bombyx mandarina*) grown in mulberry trees (MJp: *kuwamayui/kuwako*). *Man'yōshū* poem no. 3350 describes clothing made of silk threads from silkworms fed with fresh mulberry leaves.

**Ko-guso:** silkworm *kuso* (excrement)

**Ebira:** silkworm spinning frames.

**Kuha and tsumi:** mulberry trees including *morus alba* and *morus bombycis*.

**Ito:** threads reeled from silk cocoons.

**Shikeito:** threads from the outer parts of the cocoon.

**(Waku):** frame spool (Fig. 5) (Ch: *fiuak*).<sup>38</sup> Tōdō mentions that this pronunciation reflects Wuyin during the Sui and Tang dynasties.

**Kurubeki:** (literally ‘reverse turn’) swivel, rotating device on which the skein (*kase*) is set, and from which the thread is drawn out. Although we do not know the exact shape of this device from the name as we do not use this word nowadays but we can suggest its function by the heading written in Chinese characters. Ekisai Kariya suggested that it was *mai-no-ha* (*mafu* means to turn around, *ha* means blade), turning around horizontally to make skeins, which were still called *kurubeki* in the Kantō region, eastern Japan during the Edo period.<sup>39</sup> He also mentioned that it was found in the Chinese *Sancai Tuhui* written in the early 17th century, which was the model of the *Wakan Sansai Zue*, though this type of swivel dated back to the 14th century *Nung Shu* (Book of Agriculture) written by Wang Chen.

A dictionary of Old Japanese states that the noun *kurubeki* derives from the verb < *kurubeku* (also *kurumeku*): “to turn around, rotate”.<sup>40</sup> It gives an example of the phrase “turn around like a top” from the 12th century *Konjaku Monogatari* (Anthology of Tales from the Past; vol. 20 no. 6). Probably it rotated horizontally (Fig. 6). Some of the ritual clay objects series found from the Myōgajima Kofun no.5 mound in Shizuoka Prefecture show their rough shapes during the 5th century (Middle Kofun period) (Figs. 6c & 6d Important Cultural Properties).<sup>41</sup>

The *Man'yōshū* poem no. 642 compares King Yuhara’s feelings to a thread, which if it frays/

36. Kitamura 1973, vol. II, 339.

37. Hiroi & Nagano 1999, 368.

38. Tōdō 1995, 975.

39. Kyoto University 1999, 313-314.

40. Ohno *et al.* 1982, 424.

41. Iwata City Board of Education 2003, 449. 627.

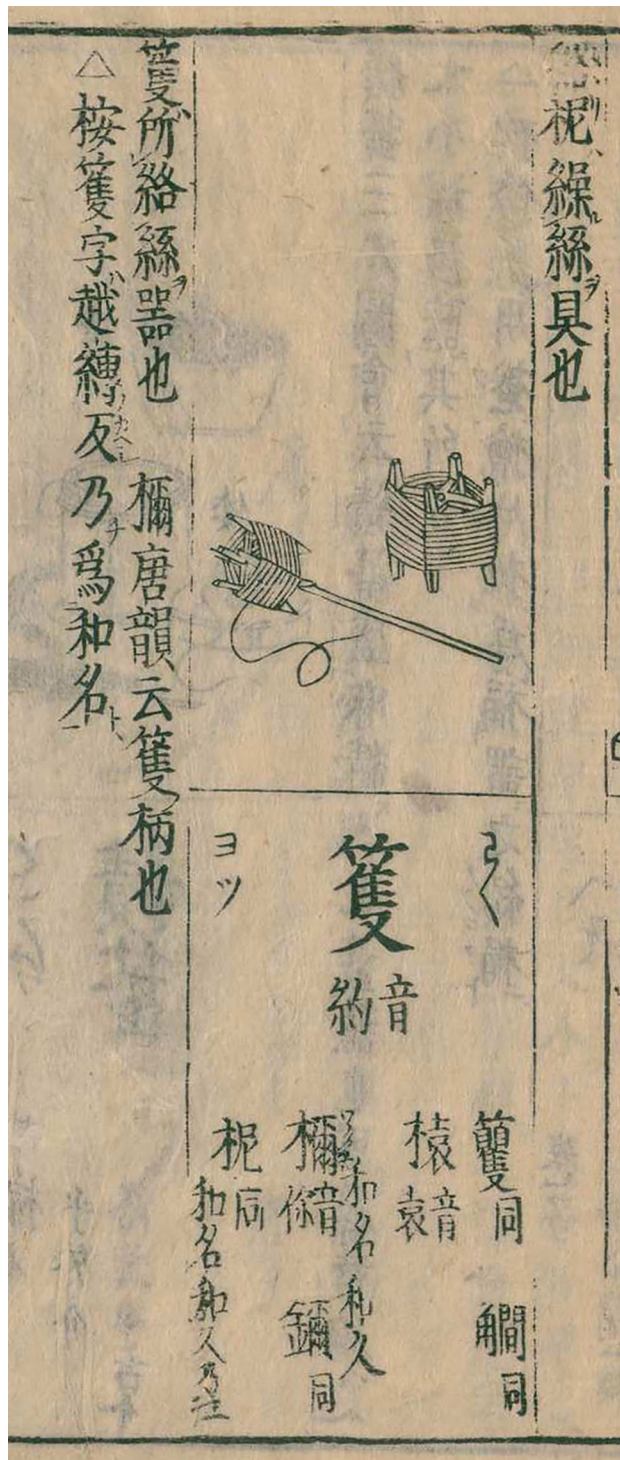


Fig. 5. Waku from the Wakan Sansai Zue. Courtesy of the National Diet Library.

strays or tangles, he will set on the *kurubeki* and fix. The phrase used is *kurubeki ni kakeru*, “to set on a rotating device” in order to bring the thread(s) together (縁, Ch; yen), a term used also to express a connection or relationship.

**Ohoga:** a silk reeling device to take the silk fibers from cocoons while they are being boiled. (MJp: *ōga*)

**Tsumi:** spindle whorl (cf. Fig. 2, lower right). It was and still is called *tsumu* <*tsumugu*, to spin, during and after the Edo period.

**Tatari:** standing skein pole holders

Usually three poles form one set for holding skeins while winding threads onto spools (Fig. 7).

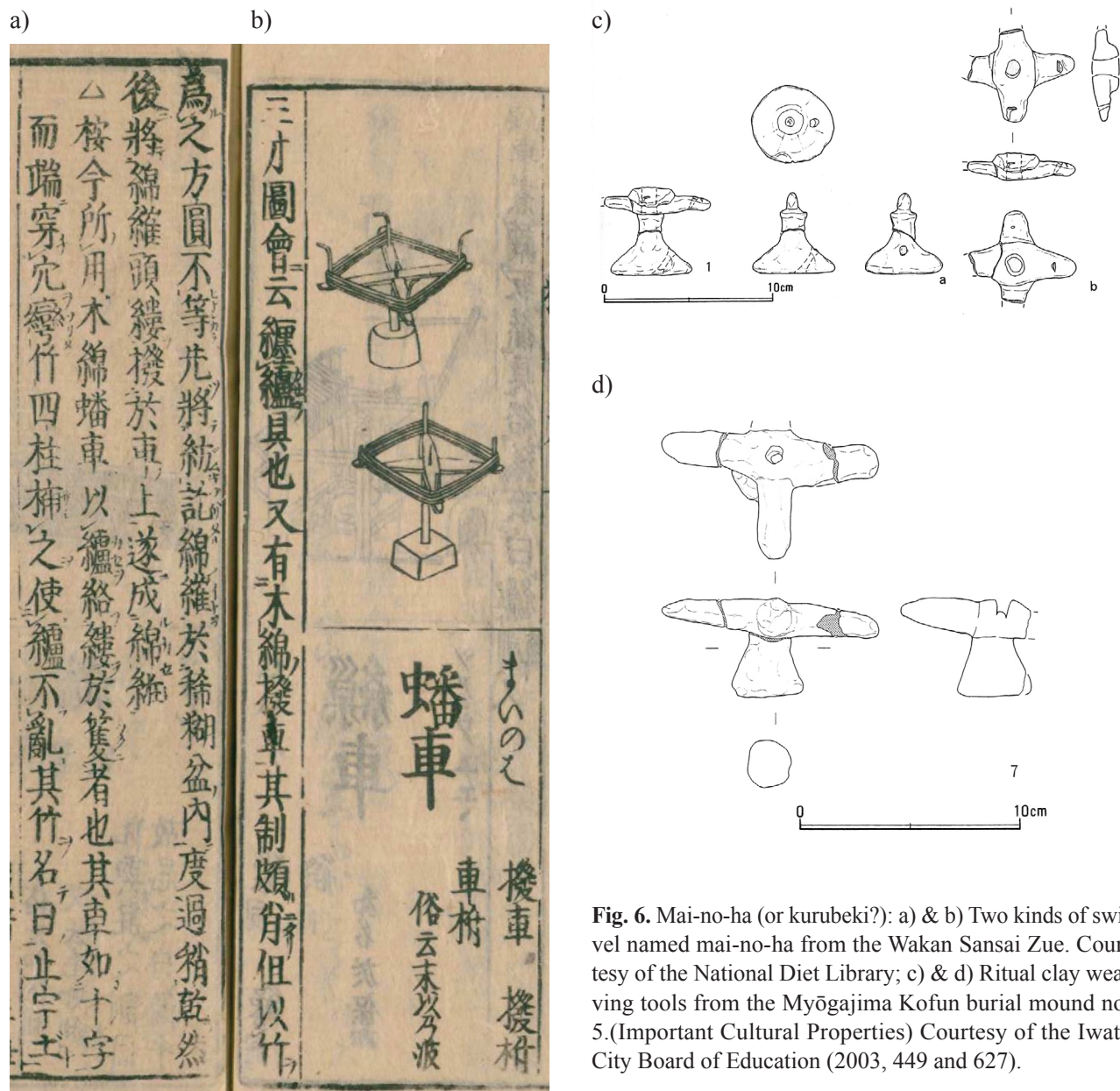
The *tatari* (standing skein holder, Fig. 2) is also found in the Muromachi period (early 1600’s) drawings<sup>42</sup> and Edo period publications. They have the same function and structure as that described in the *Wamyō Ruijūshō*. We have recognized that the term *tatari* refers to two different tools, a skein holder and a fiber stand used while ply-joining bast fiber threads, similar to the votive *tatari* shown in fig. 2, upper right.

### Archaeological evidence

The Neolithic Period in Japan is named Jōmon (rope pattern) after the decorative impressions on the pottery using twisted cords, a practice that deserves special mention. Varied patterns were developed during the period that continued for about 10,000 years (10,000-400 BC). This technique required plying the plant fibers in S or Z directions. Sometimes they combined several twisted fibers together into one cord adding a counter twist. The technique is similar to rope making and also to ply-joining, though weaving had not yet developed. The discovery of weights (*omori*) made of stones and wood from this period suggests they made twined fabrics called *angin* (an<*amu*-, to twine or to net + *gin(u)* <*kinu*, cloth or fabric), though the precise technique is unknown.

Basketry and pottery production were already highly developed at this time. In Higashimiyō wetland shell mound site, Saga Prefecture and in the

42. *Shokunin Zukushie*, Kita-in Temple, Kawagoe City, Saitama Prefecture



**Fig. 6.** Mai-no-ha (or kurubeki?): a) & b) Two kinds of swivel named mai-no-ha from the Wakan Sansai Zue. Courtesy of the National Diet Library; c) & d) Ritual clay weaving tools from the Myōgajima Kofun burial mound no. 5.(Important Cultural Properties) Courtesy of the Iwata City Board of Education (2003, 449 and 627).

northern Kyūshū area, over 700 baskets and woven bags have been excavated. The basket's fragment is dating back to 5891-5790 cal. BC by AMS dating.<sup>43</sup> Ropes, braided bark and bracken in two-ridge, material for basketry, as well as a wooden combined comb were found.<sup>44</sup>

The evidence of woven cloth appeared towards the end of the Jōmon to early Yayoi period (about

800~400 BC to AD 250). The earliest examples of tabby weave were found at the Hirajō shell mound site, Ehime Prefecture in the western part of Shikoku Island.<sup>45</sup>

In the Yayoi period, before frame back strap looms (see above) appeared, simple stick back strap looms (*koshi-bata*) would have been used for weaving. Some wooden artifacts from the Sasai site, Fukuoka

43. Matsui 2006,144.147.

44. Saga City 2009, (Fifth volume), 36, 38-39, 412-413, 420-423, 424-454.

45. Matsuura 2002, 13.

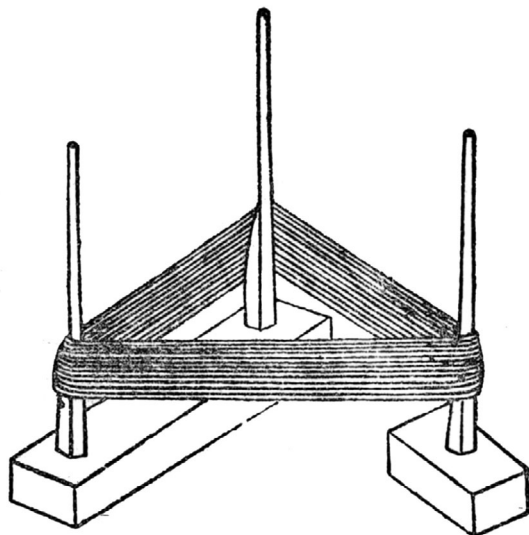


Fig. 7. Tatari (as standing skein holder) from the Kishoku Ihen (Saigusa 1946, 550).

Prefecture in northern Kyūshū are categorized as this type of textile tool. Although these artifacts have not been precisely dated, pottery fragments excavated from the same site is considered to belong to the final Jōmon period or early Yayoi period.<sup>46</sup> The excavated loom parts (Fig. 8a) are now thought to be a pair of bars for holding a circular warp (two-layer circular warp) engaging their v-shaped concave (Fig. 8a upper) and convex (Fig. 8a lower) edges,<sup>47</sup> though they were once considered to be weft beaters.<sup>48</sup> Their narrow ends would have been tied up with ropes and/or cords to fix them together with the weaver's back using a back strap. In addition, two clay spindle whorls were found at the same site (Fig. 8b).<sup>49</sup> This loom would have been the same type as that of the bronze figurines found from Yunnan, China, early Han dynasty, the loom with tension controlled using toes mentioned by Barber.<sup>50</sup> Flat rectangular

wooden boards (see Figs. 3d & 3e) have been found from the Kofun period, in exchange for the rod on one end. Some of them were partially cut off on one of its longer sides (presumably the base) to keep the lower warp threads in midair (Fig. 9).<sup>51</sup>

The area of the Sasai site is located near the open sea and from early on acted as a conduit through which rice cultivation, bronze-casting techniques, metal-smelting techniques, and weaving techniques arrived from the Asian Continent and the Korean peninsula. A gold seal given by the Chinese Emperor *Guwanwu* in the late *Han* dynasty in AD 57 was also excavated from this region. In addition, the so-called Indo-Pacific beads reached here already before the Christian era.<sup>52</sup> It seems that those innovative technologies were not originally developed in the Japanese archipelago.

Furthermore, tools like the niddy-noddy called *kase* (柵) or *kasebo*, are found all over Japan. A wooden I-shaped tool from the Shiraiwa site in Kikugawa City, Shizuoka Prefecture confirms that the niddy-noddy has been used since the Yayoi period in textile production to make *kase* (紜), skeins, and for warping. It is useful to count the length of the threads required to weave. Interestingly, the pronunciation of the name of the tool and the result of its use are the same, though the Chinese characters used to write them differ. The example shown in fig. 10 is carefully formed and assembled. The estimated date is about the 2nd century AD. An oracle bone and rice husks were also found at the same site.<sup>53</sup>

This kind of tool has been used in a wide area in East Asia since ancient times (Warring States period Jiangxi, China),<sup>54</sup> though the size, the structure and material are different depending on the function.

The following are wooden artifacts (presumed to be textile tools) excavated from the Yōkaichijikata

46. Fukuoka City Board of Education (Sasai Iseki 3) 1995.

47. Higashimura 2008, 1-21; Okamura 1977, 210-211.

48. Nunome 1995, (Sasai Iseki 3) 133-135.

49. Fukuoka City Board of Education (Sasai Iseki 3) 1995, 50. 56.

50. Barber 1991, 80-81.

51. Kanagawa Archaeology Foundation 1999, PL.4; Higashimura 2008, 14-15.

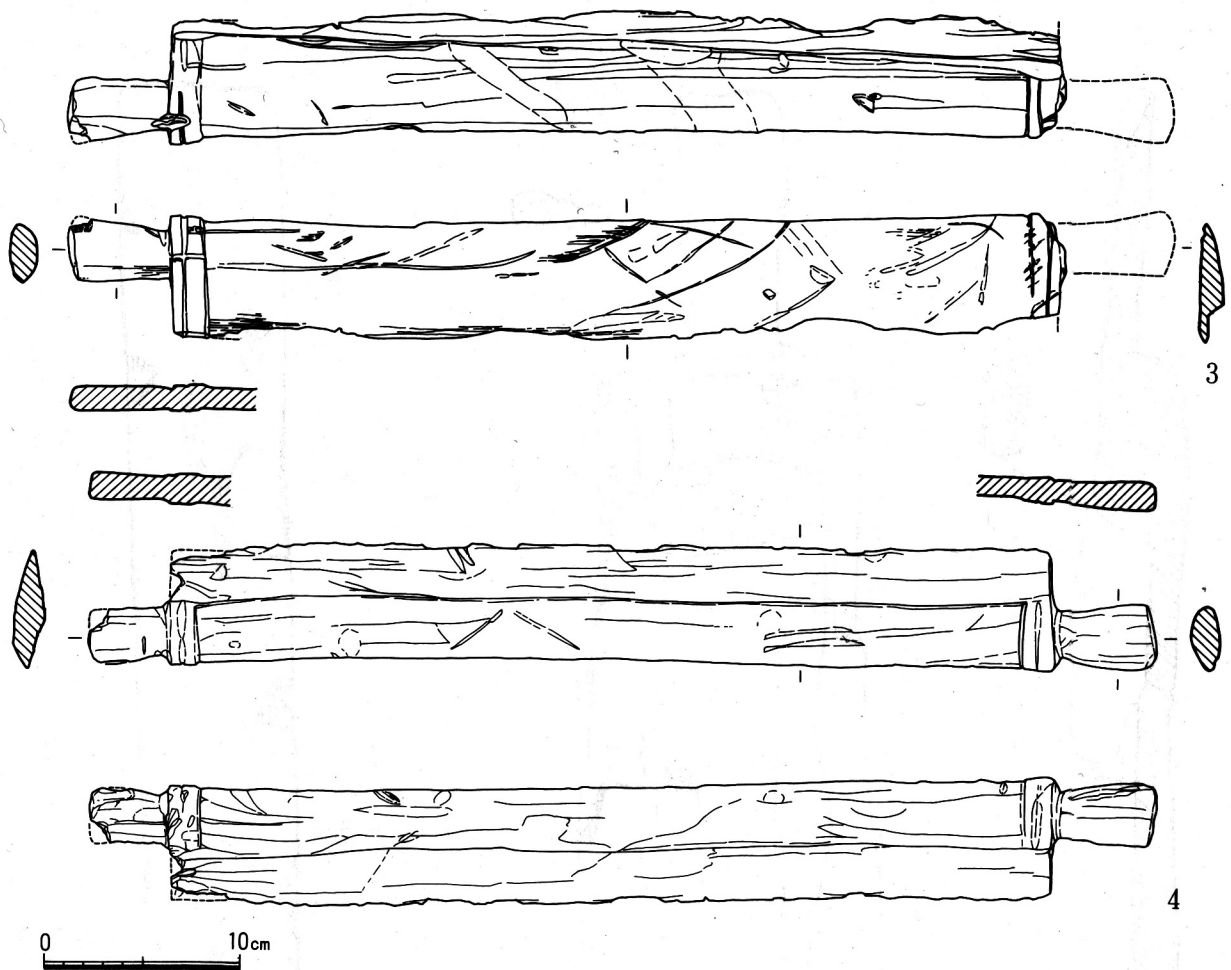
52. Fransis 1990.

53. Sakakibara & Ishikawa 1975.

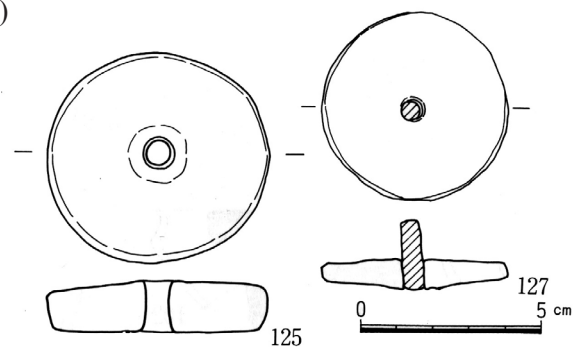
54. 纺织卷 (A History of Science and Technology in China/ vol. of the textile technology) 2002, 157-158.



a)



b)



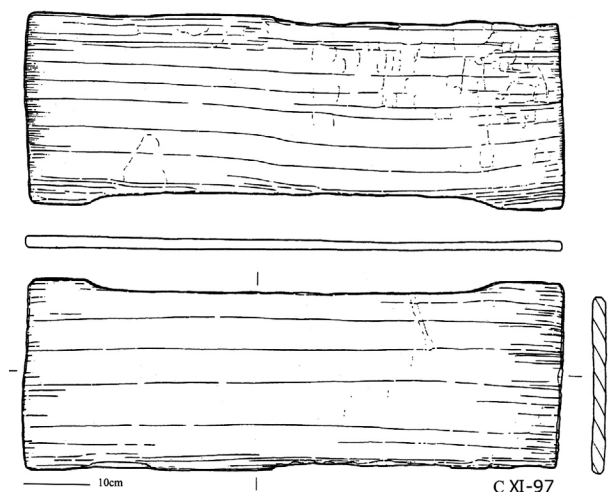
**Fig. 8.** Textile tools from the Sasai site; a) A pair of warp bars; b) Clay whorls owned by the Fukuoka Municipal Center for Excavated Cultural Properties. Courtesy of the Fukuoka City Board of Education (1995, 50 and 53).

site (Fig. 11 Important Cultural Properties),<sup>55</sup> Ishikawa Prefecture and Rokudai A site (Fig. 12),<sup>56</sup> Mie Prefecture. The textile tools found at Yōkaichijikata site include spindle whorls, parts of the niddy-noddy, a back strap, a beater, and a pair of flat bars to hold the warp.

Wood species were identified as plum-yew for a part of a rotating device and as Japanese mulberry for five objects including the weft beaters and pairs of the flat warp clip bars, though it is popular to use hard wood like evergreen oak in other regions.

55. Komatsu-shi Maizō Bunkazai Center 2013, 144-146.

56. Mie-ken Maizō Bunkazai Center 2000, 158-161.



**Fig. 9.** A wooden flat board from the Ikego site, Zushi City, Kanagawa Prefecture. Courtesy of the Kanagawa Archaeology Foundation (1999, Pl. 4).

The Rokudai A site finds also include spindles whorls, parts of a niddy-noddy, a back strap, a beater, parts of the frame spool (*waku*), and parts of wooden rotating devices which turn horizontally. We suppose these might be what is called *kurubeki*, though it is labeled *mai-no-ha* in *Wakan Sansai Zue* written in the 18th century (Figs. 6a and 6b). A similar type is also found in ritual clay remains from the Myōgajima Kofun burial mound no. 5 (Figs. 6c and 6d). In China this type of reel is mentioned as being used in the southern area for cotton production.<sup>57</sup> Horizontal swivels turn more slowly than vertical ones. Without this kind of tool the threads stored in skeins cannot be used to set up the warp. The species of wood used for these tools were identified as mainly soft woods such as Japanese cedar *sugi* and Japanese cypress *hinoki*.

The term *kase* is found in the *Engishiki* as *kasehi* and in the *Man'yōshū* as *kase* though it is not found in the *Wamyō Ruijūshō*. The function of the niddy-noddy is to make skeins or for warping. This tool is still in use in some regions in Japan and the neighboring countries. In Miyakojima Island, Okinawa Prefecture, they

use *kashigi* for making *chomafu* (*karamushi* cloth).<sup>58</sup> In Kōzuhara, Shiga Prefecture they use *kase* for hemp cloth production.<sup>59</sup> The technique dates back to at least the Yayoi period when the rice cultivation, bronze casting, and iron smelting spread in Japan.

For example, we can find several scenes on cast bronze bells called *dōtaku*, dated to about the 1st century AD, Yayoi period. These bells are often found with protrusions along their sides, suggesting they were for ritual use. One such bell depicts a person holding a niddy-noddy-like tool in his/her hands, though this is not definitively identified as a textile tool (Fig. 13). Some say that it might be a kind of fishing tool, as fish are depicted nearby the person. These bells are often found alongside weapons and are thought to be ritual items.

From the Sakuragaoka site in Hyōgo Prefecture, a series of the cast bronze ritual items were excavated. On two bronze bells, No. 4 and No. 5, people with I-shaped tools are depicted.

During the Kofun period (3rd to 6th centuries AD), which follows after the Yayoi period, weaving techniques developed along with the evolution of the social structure. Towards the end of the Kofun period, movements began to establish a nation state, many aspects being adopted from China and Korea: the administrative system, ceremonial appearance and manners, *etc.* They also built their capital according to the Chinese model. In order to carry out all these projects, they needed developed techniques, which of course included the textile technologies.

In the Japanese chronicle *Nihon Shoki*,<sup>60</sup> the entry about the era of the legendary Emperor Ojin mentions the invitation of four specialists from Wu (Jp. *Kure*), one of the Three Kingdoms in the southern area of China. Indeed, the *hata-ori* weavers clan is sometimes called *kure-hatori* (garment and dress makers from *Wu*). In addition, the name *ana-hatori* (pit loom weavers),<sup>61</sup> another of the four specialists, is well worth consideration in the context of the textile terminology in the Orient.

57. 中国科学技术史 纺织卷 (A History of Science and Technology in China/ vol. of the textile technology) 2002, 183-184.

58. Nagano & Hiroi 1999, 57.

59. Nagano & Hiroi 1999, 39.

60. Kojima *et al.* 1994.

61. In a similar story found in a different part of the Chronicle, the name '*aya-hatori*' (Han-style weaver) is found instead of '*ana-hatori*'.



**Fig. 10.** A wooden kase from the Shiraiwa site. Height: 79.8 cm, width: 33.5 cm / 32.5 cm. Courtesy of the Kikugawa City Board of Education, Shizuoka Prefecture.

### Conclusion and discussion

A discussion of textile terminology in ancient Japan spans a wide geographical and chronological range, being influenced not only by its neighbors Korea and China, but also through them by the Eurasian Continent.<sup>62</sup> The Neolithic Jōmon culture, which lasted for about 10,000 years, produced excellent basketry from the very beginning, and over time pottery with cord impressions came to flourish. During the succeeding Yayoi period, many innovative textile technologies were brought to Japan, leading to the development of weaving, which spread through specialists to many parts of the area.

The terms related to textile production found in ancient records about Japan are mostly related, on the one hand, to bast fibers taken from hemp and ramie and, on the other hand, to silk production along with sericulture. The bast fiber production dates further back than the silk production. The importance laid on bast fiber production reflects the natural vegetation of Japan, but also mimics a similar situation in China, as documented in the *Wei Zhi* section of the Chinese chronicle *Sanguo Zhi* (Records of the Three Kingdoms, AD 220-265).

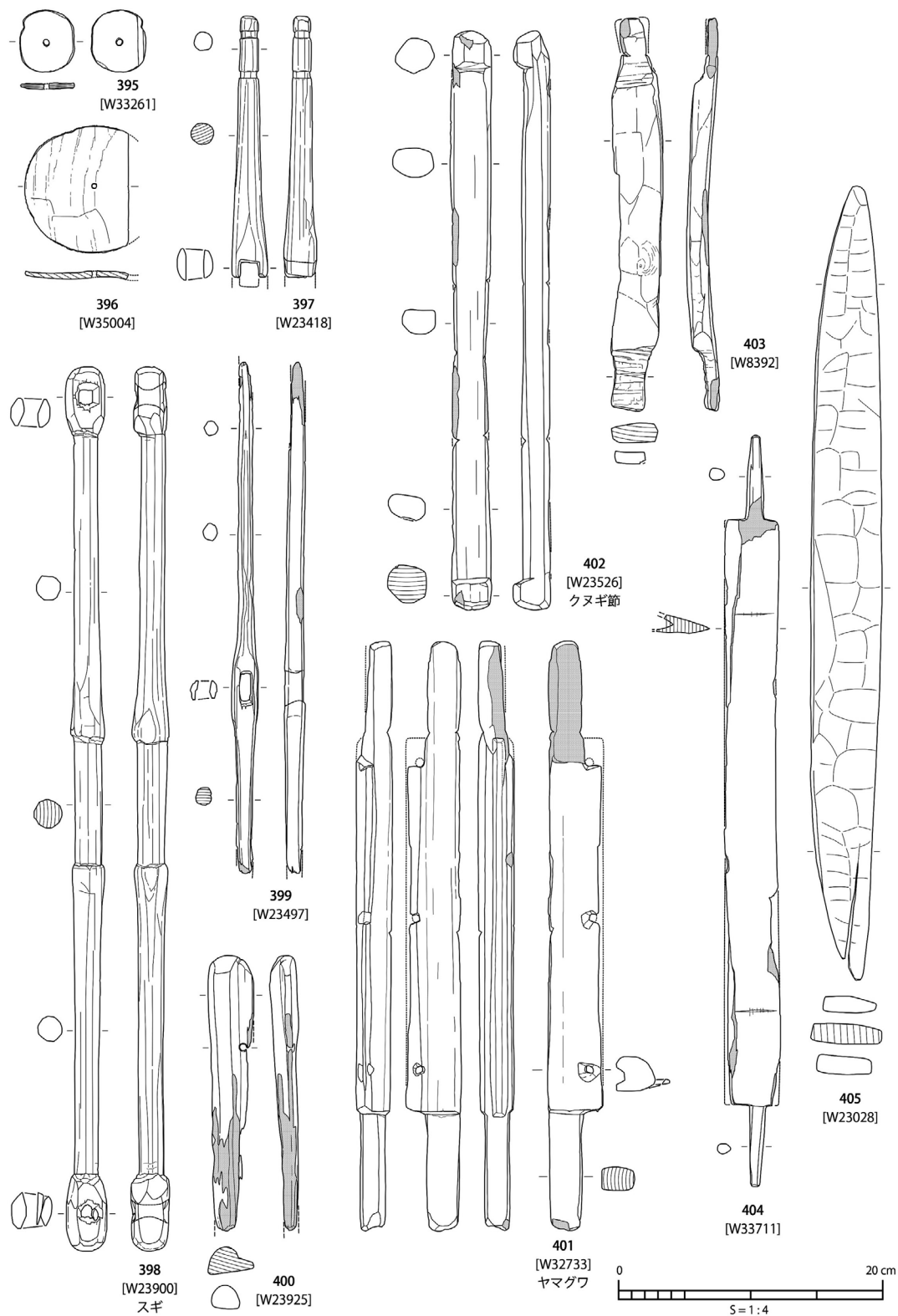
During the Jōmon period items made with bast fibers used the plant fibers without joining them into longer threads. Exactly when splicing to form continuous threads began is as yet unverified, but it is likely to date back to the Yayoi period. This needs further cooperative investigation.

The knowledge of sericulture and the art of weaving silk are thought to have been introduced from China and indeed many of the Chinese characters used to denote the related terms are the same in both languages, though they are read with different pronunciation.

Among all the early textile terms, the *kurubeki* (swivel) seems particularly important for considering the historical and technical contexts of textile terminologies within the wide area of the Eurasian Continent. The term *kurubeki* is derived from the word *kuru* (to wind, reel, spin), which in turn is related to rotating devices. Significantly, *kurubeki* has phonetic similarities to words for ‘wheel’ (*\*k<sup>w</sup>ék<sup>w</sup>lo* ; Jp: *kuruma*).<sup>63</sup> One might say silk reeling techniques in China were highly developed with the help of the ‘wheel’, which would have been brought with chariots from the West in the 2nd millennium BC. Without these, they could never have manipulated the fine and long silk filaments so efficiently.

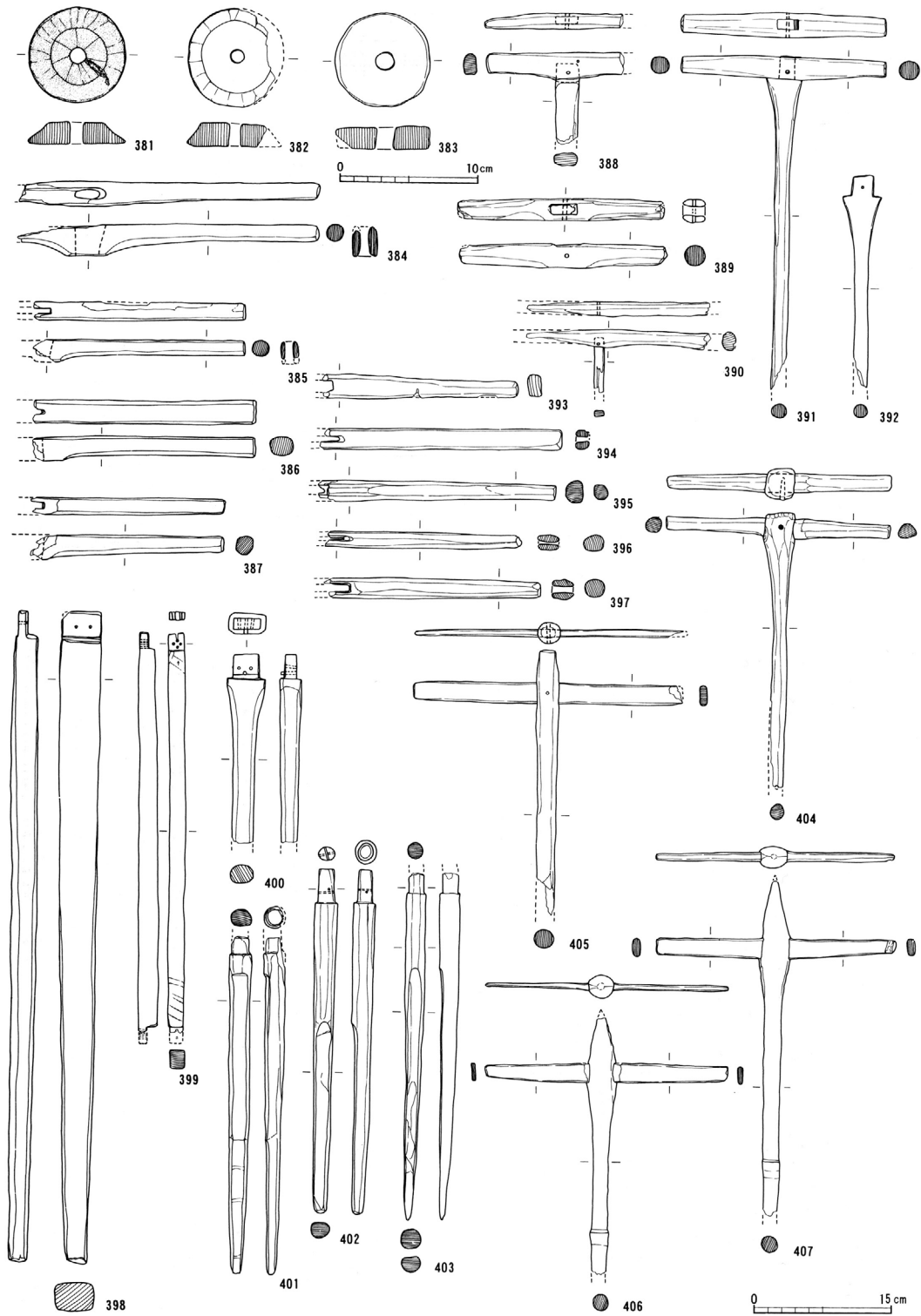
62. 林梅村 Lin Meicun 2005, 228-262. He discusses a similar process for the origin and development of bronze sword production in the Eurasian Continent.

63. Mallory & Adams 1997, 640-641; Mallory & Mair 2000, 326.



第 53 図 紡織具 (S=1/4)

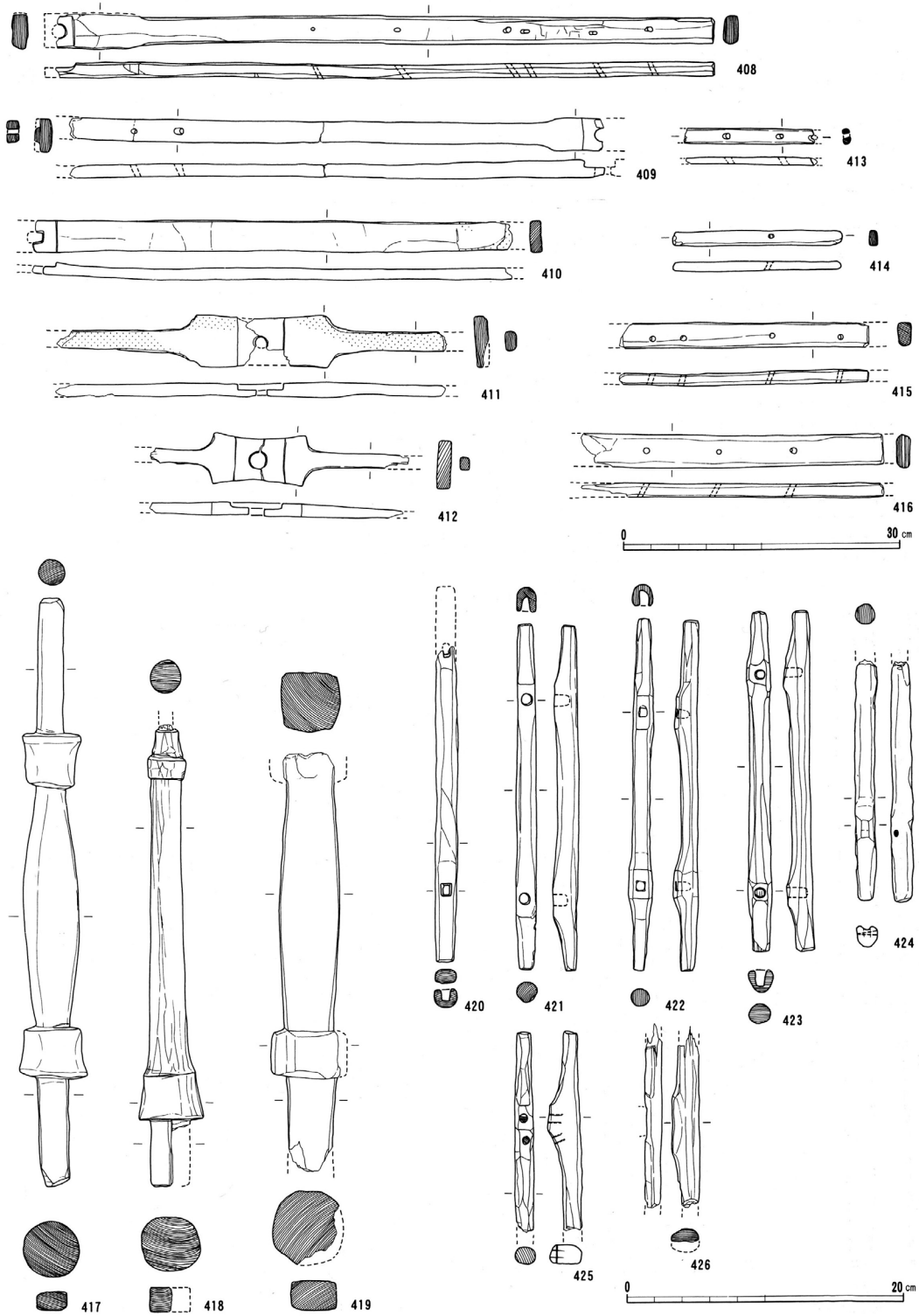
Fig. 11. Wooden textile tools from the Yōkaichijikata site (Important Cultural Properties/ mid. Yayoi period). Courtesy of the Komatsu City Board of Education, Ishikawa Prefecture (2014, 146).



第30図 紡錘車・棒(381~407)

(381~383は1:4、その他1:6)

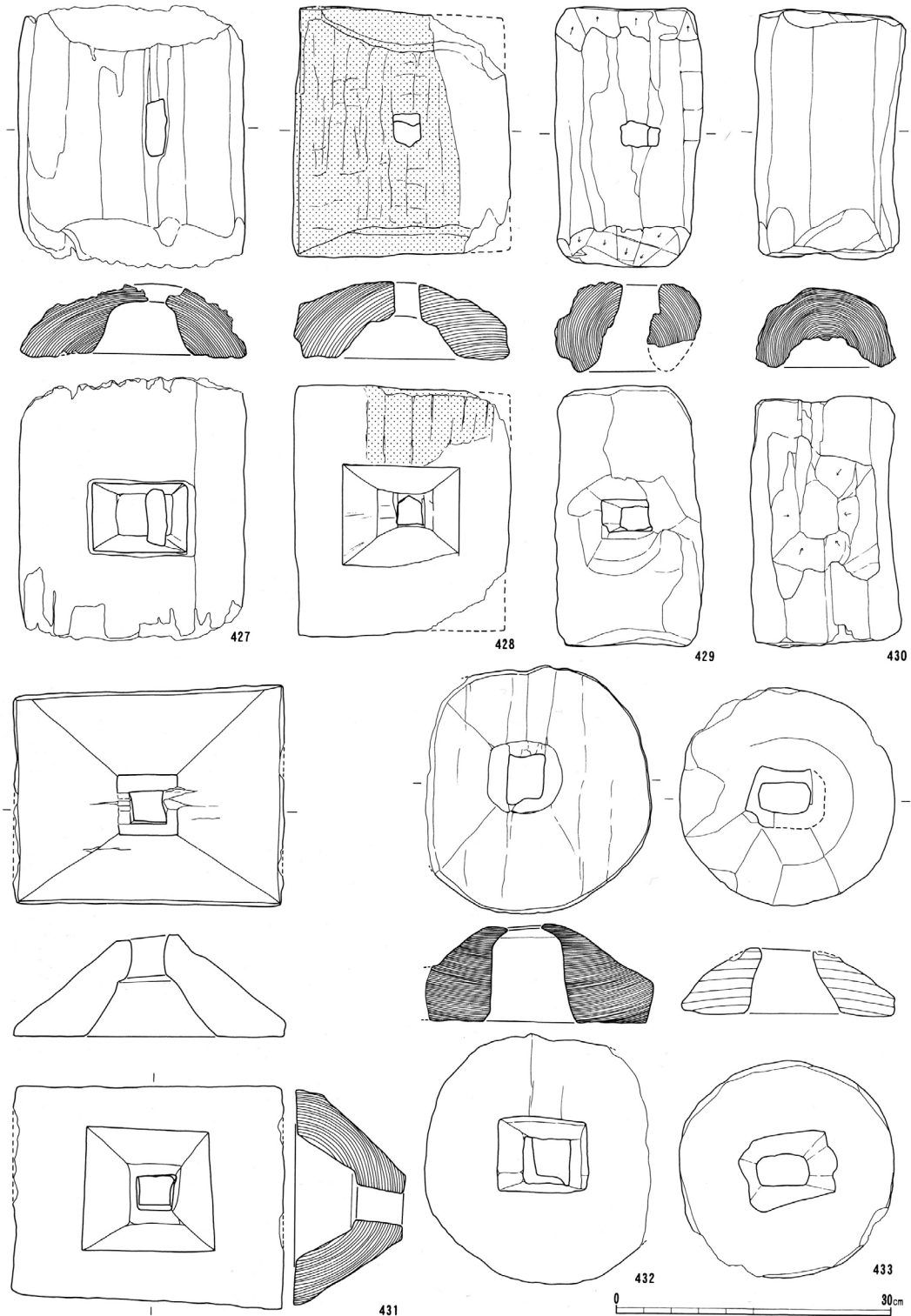
**Fig. 12.** Wooden textile tools from the Rokudai A site. Courtesy of the Mie Prefectural Center for Excavated Cultural Properties; a) Wooden whorls (nos. 381-383) and parts of niddy-noddies (nos. 384-407) The Mie Prefectural Center for Excavated Cultural Properties (2000, 158);



第31図 杵・総かけ・糸杵(408~426)

(408~416は1:6、その他1:4)

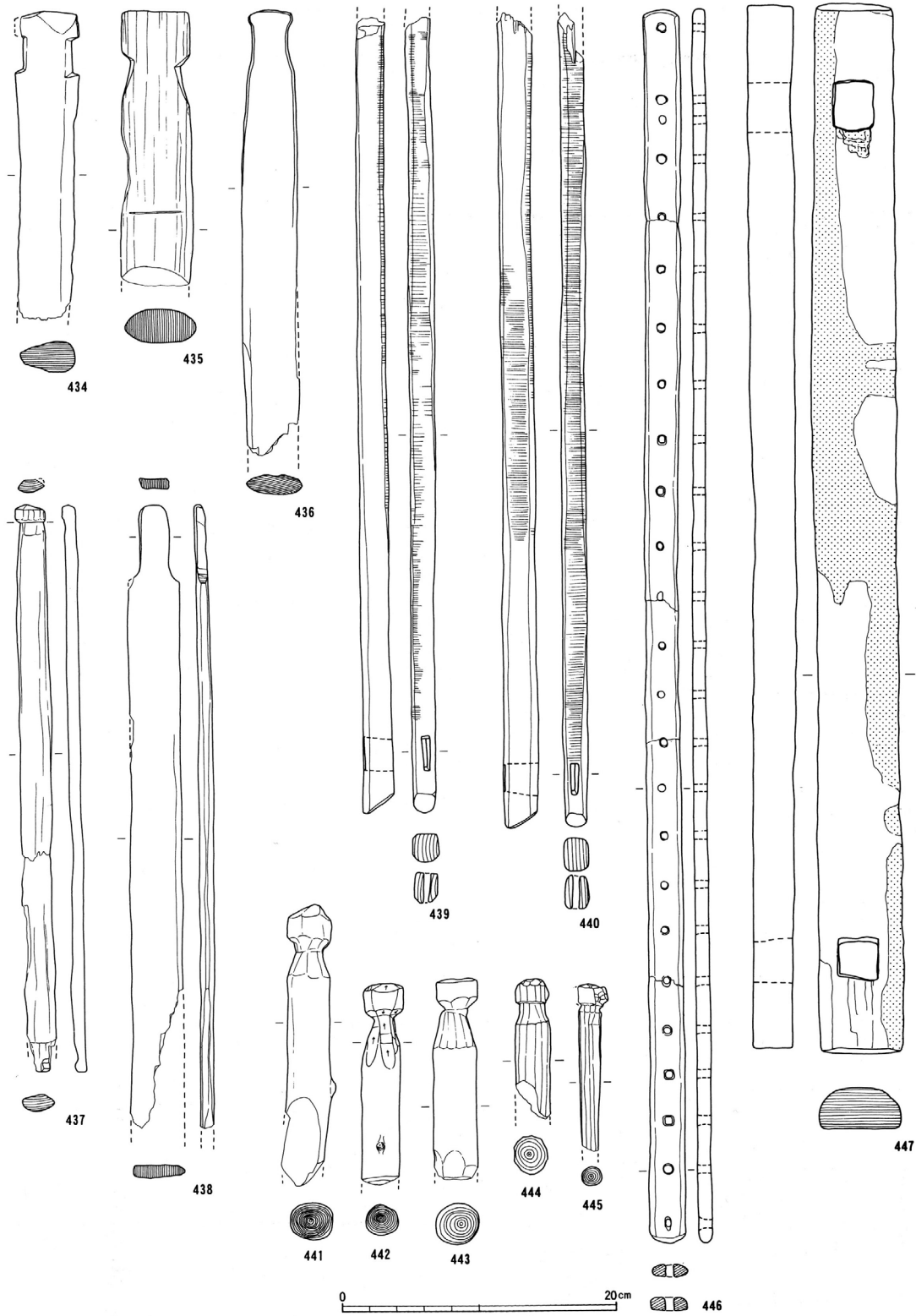
Fig. 12. b) Parts of niddy-noddies (nos. 417-419), rotating devices (nos. 408-416), and frame spools (nos. 420-426). The Mie Prefectural Center for Excavated Cultural Properties (2000, 159);



第32図 タタリ(427~433)

(1:6)

Fig. 12. c) Stands of the skein holders and/or fiber stands (nos. 427-433). The Mie Prefectural Center for Excavated Cultural Properties (2000, 160);



第33図 織機(434~447)

(1:4)

Fig. 12. d) Parts of looms (nos. 434-447). The Mie Prefectural Center for Excavated Cultural Properties (2000, 161).





**Fig. 13.** a) & b) Full view and a figure with a niddy-noddy-like tool on Kamika bronze ritual bell no.5 from the Sakuragaoka site (National Treasure), Courtesy of the Kobe City Museum.

Although we cannot know the exact time when the specialists brought textile related techniques into Japan, it was probably during the Yayoi period. This probably occurred in conjunction with the importation of other rotating devices. According to the research on wooden vessel processing, it was also during the Yayoi period that rotating devices, like the lathe (Jp: *rokuro*) appeared.<sup>64</sup> The lathe, like the wheel, is said to have originated in the West Asia, and the word *rokuro* also has a phonetic resemblance to other terms from that area.

Parts of wooden rotating devices found in Rokudai A site, Mie Prefecture, which date back to between the 4th to 9th centuries AD, give evidence to the Japanese having such rotating devices by then, though, unfortunately, we cannot be sure what they were called during that period.

It may be that in the Yayoi period, native terms for the tools and techniques had come into common use before the Chinese terms (developed during the Han dynasty) arrived. For instance, the Chinese word *che*, meaning car, is read *kuruma* in Japanese. This reading does not follow the modern Chinese pronunciation, but has been treated as a Japanese term (*wa-go*), since at least the Nara period. At the same time it has a phonetic resemblance to proto-Indo-European words of the same meaning.<sup>65</sup> Other Japanese words related to wheels use the same *kuru* as a base, such as *kurukuru* or *guruguru* (adverbs for *mawaru*, *mawasu* or *korogaru*, *korogasu*: to rotate or twirl) and *kurubushi* (ankle). Clearly terms related to wheels provide clues to understanding the cultural interconnections across Asia and invite further linguistic examination.<sup>66</sup>

## Bibliography

### Japanese

- Fukuoka City Board of Education (ed.) (1995) *Sasai Iseki 3*, 雀居遺跡3, Fukuoka-shi Maizō Bunkazai Chōsa Hōkokusho Dai 407shū (Report on excavated cultural properties in Fukuoka City, no. 407, Fukuoka, Japan).
- Gotō, S. & Yamakawa, R. (eds.) 後藤捷一・山川隆平 編 (1937), 染料植物譜 *Senryō Shokubutsufu* (Genealogy of vegetables for dyeing) Hakuousha. Kyoto.
- Higashimura, J. (2008), 輪状式原始機の研究, The Archaeological study of Back-strap Looms in the Yayoi and Kofun Periods. 古代文化60巻1号, *CULTURA ANTIQUA*, vol. 60 Number 1 June.2008, 1-21 公益財団法人古代学協会 The Paleological Association of Japan. Inc. Kyoto.
- Inaoka, K. (1997), 稲岡耕二, *Waka Bungaku Taikei 1*, *Man'yōshū* (1), (2), (3) 和歌文学大系 1 万葉集 (一) / (二) / (三) (A compendium of Japanese poems 1, *Man'yōshū*), Meiji Shoin, Tokyo.
- Iwata City Board of Education (ed.) (2003), *Excavation report of the cultural properties in the demarcation project of the Eastern part of Iwata City, Research of the Futagozuka Kofun, Myōgajima Kofun-gun and clay models.* (The 2nd of the tree volumes and volume of plates.) 東部土地区画整理事業地内埋蔵文化財発掘調査報告書 二子塚古墳・明ヶ島古墳群・土製模造品の調査他 中巻, Shizuoka.
- Kanagawa Archaeology Foundation (ed.) (1999), *Ikego sites, Zushi City, Corpus of wooden artifacts No.1-A · No.1-A East · 1-A South site.* 逗子市池子遺跡群 No.1-A · No.1-A 東 · 1-A 南地点木器集成図録 Kanagawa.
- Kariya, E. (1827), *Senchū Wamyō Ruijūshō*. In Kyoto Daigaku Bungakubu Kokugogaku Kokubungaku Kenkyūshitsu (ed.) (1999) 1-525. 京都大学文学部国語学国文学研究室編, *Shohon Shūsei Wamyō Ruijūshō, Honbun-hen* 諸本集成倭名類聚抄本文編 (Compilation of the *Wamyō Ruijūshō* texts edited by
64. Kuraku 1989, 98-99.
65. Mallory & Mair 2000, 326. “The old Chinese word for chariot, the modern Mandarin *ch'e*, would have been pronounced roughly as *\*kʰʌg* during the Shang dynasty, and this word bears a certain resemblance to one of the Proto-Indo-European words for ‘wheel’ (*\*kʷékʷlo*)’ which provided the base for the word for vehicle in Tocharian, *i.e.*, Tocharian A *kukäl* and Tocharian B *kukare*.” Rather than a direct borrowing from the Tocharian, however, linguists suggests that all the terms for wheels go back to a proto word from an early Iranian language.
66. Among the previous linguistic studies on resemblance of the terminology of not only textiles but also of religion, rice cultivation, *etc.* between the Old Japanese, Korean and proto-Dravidian was carried out by Susumu Ohno. For example the term for the loom and cloths (*hata* or *fata*) is supposed to relate ‘*patam*’, Dravidian, from ‘*pata*’, Sanskrit.

- the Office of Japanese Language and Japanese Literature, The Faculty of Letters, Kyoto University). Rinsen Shoten, Kyoto.
- Katō, J. (1970) 加藤常賢, *Kanji no Kigen* 漢字の起原 (Origin of the Chinese characters), Kadokawa Shoten, Tokyo.
- Keikai (or Kyōkai) (787-824) (ed.) 景戒, 法華經を写さむとして願いを建てたる人日を断つ暗き穴に願の力を頼みて命を全くすること得る縁 第13, *Hokeyō wo utsusamutosite negai wo tatetaruhito hi wo tatsu kuraki ana ni negahi no chikara wo tanomite inochi wo mattakusurukotoeru kotonomoto dai 13* (A man who believed in the hand-copying of Hokeyō sutra was rescued from a dark hole he had fallen into, then he died of old age, part 13). In O. Izumoji (ed.) 出雲路修 (1996), *Shin Nihon Koten Bungaku Taikei 30 Nihon Ryōiki, Gekan no. 13* (Miraculous Tales of Buddhism Volume Two, New Japanese classical literature vol. 30, 146-148, 271) 新日本古典文学大系30日本霊異記 (下巻 第13縁) 岩波書店 Iwanami Shoten, Tokyo.
- Kitamura, S. & Murata, G. (1973) 北村四朗・村田源. *Genshoku Nihon Shokubutsu Zukan*, COLORED ILLUSTRATIONS OF HERBACEOUS PLANTS OF JAPAN (vol. I . II . III), HOIKUSHA, Osaka.
- Kizawa, N. (2011) 木沢直子, 木製横櫛の用材選択と製作技術に関する基礎調査 A basic study of excavated wooden combs, wood species, and manufacturing techniques (Research report of Grant-in-Aid for Scientific Research, Japan Society for the Promotion of Science, Project Number: 20520674), Gangoji Institute for Research of Cultural Property, Nara.
- Kojima, N. et al. (eds.), (1994) *Nihon Shoki* ① (日本書紀 ①) *Shinpen Nihon Koten Bungaku Zenshū* 新編日本古典文学全集2 (New edition of Japanese Classics vol. 2), Interpreted for modern Japanese by N. Kojima 小島憲之, K. Naoki 直木孝次郎, S. Kuranaka 蔵中進, M. Mōri 毛利正守, K. Nishimiya 西宮一民, Shogakukan, Tokyo.
- Kojima, N. et al. (eds.), (2004) *Nihon Shoki* ② (日本書紀 ②) *Shinpen Nihon Koten Bungaku Zenshū* 新編日本古典文学全集3 (New edition of Japanese Classics vol. 3), Interpreted for modern Japanese by N. Kojima 小島憲之, K. Naoki 直木孝次郎, S. Kuranaka 蔵中進, M. Mōri 毛利正守, K. Nishimiya 西宮一民, Shogakukan, Tokyo.
- Komatsu-shi Maizō Bunkazai Center (Komatsu City Board of Education, Ishikawa Prefecture) (ed.) 石川県小松市教育委員会, (2014) *Yōkaichijikata Iseki II*, 八日市地方遺跡 II (Excavation report of the Yōkaichijikata site II)
- Kuraku, Y. (1989) 工楽善通 Mokusei-takatsuki no Fukugen 木製高坏の復元 (Reconstruction of a wooden pedestal bowl by the turnery). In Kuraku (ed.), *Kodai-shi Fukugen 5, Yayoi-jin no Zōkei*, 古代史復元 5 弥生人の造形 (Reconstruction of ancient history vol. 5 Art of the Yayoi period people) Kōdansha, Tokyo.
- Kuroita, K. & Kokushi Taikei Henshūkai, *Engishiki*, 延喜式, In K. Kuroita & Kokushi Taikei Henshūkai (eds.), *Shintei Zōho Kokushi Taikei* vol. 26 (1965) 新訂増補国史大系26 黑板勝美, 吉川弘文館 1-1005. Yoshikawa Kōbunkan, Tokyo.
- Kyoto Daigaku Bungakubu Kokugogaku Kokubungaku Kenkyūshitsu (ed.) (1995). *Shohon Shūsei Wamyō Ruijūshō Sakuin-hen* 京都大学文学部国語学国文学研究室編, 諸本集成倭名類聚抄索引編 (Compilation of the *Wamyō Ruijūshō*, volumes of the index edited by the Office of Japanese Language and Literature, The Faculty of Letters, Kyoto University.) Rinsen Shoten, Kyoto.
- Lin, M. (2005) 林梅村, *Ryūsa no Kioku wo saguru* 流砂の記憶をさぐる (Searching the memories of the quicksand), NHK 出版, NHK Publishing, Tokyo.
- Matsui, A. (2006) 松井 章 The excavation of the wetland site of Higashimyo, Saga Prefecture and its dating. In *Proceedings of the 19th Symposium on Chronological Studies at the Nagoya University Center for Chronological Research in 2006, Part 2*, 佐賀市東名遺跡の年代とその問題点(第19回名古屋大学年代測定総合研究センターシンポジウム平成18(2006)年度報告, 第2部), 144-147.
- Matsuura, Y. (2002) 松浦宥一郎 *Nihon Shutsudo Genshikodai Sen'i-seihin no Shūsei oyobi Kisoteki Kenkyū* 日本出土原始古代繊維製品の集成及び基礎的研究 (Compilation and Basic Study of Prehistoric and Early Historic Textiles Excavated in Japan, Research Project Number: 10301020) Tokyo.
- Mie-ken Maizō Bunkazai Center (Mie Prefectural Center for Excavated Properties) (ed.) 三重県埋蔵文化財センター (2000) *Rokudai A Iseki Hakkutsu Chōsa Hōkoku (Mokuseihin Hen)* (Excavation report of the Rokudai A site, wooden objects series), 158-161. Mie.
- Miyazaki, T. & Miyazaki, A. (1997), 宮崎隆旨・宮崎明子 *Kodai-akanezome ni kansuru Ichikōsatsu* 古代茜染に関する一考察『延喜式』に基づく「緋」色再現の小実験 (A study on the ancient madder red dyeing process -an experimental for reconstruction of the *hi-iro* red color according to the “*Engi-shiki*”-) *Nara Kenritsu Bijutsukan-kiyō* 奈良県立美術館紀要 11 (*Journal of the Nara Prefectural Museum of Art*, vol. 11, 1-21.) Nara.

- Nagano, G. & Hiroi, N. (1999) 長野五郎・ひろいのぶこ, The glossary (362-371. translated by Monica Bethe), *Orimono no Genhūkei* 織物の原風景 Base to tip: Bast Fiber Weaving in Japan and Its Neighbouring Countries, Shikōsha, Kyoto.
- Ohno, S. 大野晋 (2004) *Yayoi Bunmei to Minami Indo* 弥生文明と南インド (Yayoi-period Culture and South India), 236-242, Iwanami Shoten, Tokyo.
- Ohno, S. *et al.* (ed.) (1982), *Iwanami Kogo-jiten* 岩波古語辞典 (Dictionary of old Japanese), Iwanami Shoten, Tokyo.
- Okamura, K. (1977) 岡村吉右衛門 *Nihon Genshi-orimono no Kenkyū*, 日本原始織物の研究 (Study of ancient weaving techniques in Japan).文化出版社 Bunka Shuppansha, Tokyo.
- Ōtsuki, M. 大槻信 (2004) *Japanese Readings in the Wamyō Ruijūshō –Headings without Japanese Readings-*, 倭名類聚抄の和訓—和訓のない項目—, 1-24. In Kyoto Daigaku Bungakubu Kokugogaku Kokubungaku Kenkyūshitsu (ed.) *Kokugo Kokubun* (Japanese Language and Literature) Vol.838 (vol.73-no.6) The Office of Japanese Language and Literature, The Faculty of Letters, Kyoto University)
- Ōzeki, M. (1830) 大關増業, *Kishoku Ihen* 機織彙編, 473-607. 日本科学古典全書第13巻 In Saigusa, H. 三枝博音 (ed.) *Nihon Kagaku Koten Zensho* vol.13, (1946) Asahi Shinbun Sha, 朝日新聞社
- Saga City Board of Education (ed.) 佐賀市教育委員会, *Higashimyou Iseki-gun II*, *Saga-shi Maizō Bunkazai Hakkutsu Chōsa Hōkokusho, Dai 40 Shū* (Excavation Report of Saga City, vol. 40) 東名遺跡群II佐賀市埋蔵文化財調査報告書第40集, (Higashimyou sites II, Saga, 2009)
- Sakakibara, S. & Ishikawa, K. (1975) 榊原松司・石川和明, Shizuoka-ken Kikugawa-chō Shiraiwa-iseki Shutsudo no Kase 静岡県菊川町白岩遺跡出土の杵, In *Kōkōgaku Zasshi* 考古学雑誌 (Journal of the Archaeological Society of Nippon) vol.61, no. 2, 59-63.
- Saso, M. (2013) 笹生衛, 古代祭祀の形成と系譜—古墳時代から律令時代の祭具と祭祀—The Changes from Ritual Artifacts of the Kofun Period to Ritual Objects under the Ritsuryō System, 古代文化65巻3号, *CULTURA ANTIQUA*, vol. 65 Number 3 Dec. 2013. 46-64. 公益財団法人古代学協会 The Paleological Association of Japan. Inc. Kyoto.
- Shimotsuke City Board of Education (ed.) (2014) 下野市教育委員会, *The Kabutoduka Kofun* (burial mound with scallop shell-shaped ground plan), Excavation Report of Shimotsuke City, vol.11 Tochigi Prefecture, 栃木県下野市埋蔵文化財調査報告書第11集, Shimotsuke.
- Tanikawa, K. (1903) 谷川士清, *Wakun no Shiori* 和訓栞, Seibido, Gifu.
- Terajima, R. (ed.) (1824) 寺島良安編, *Wakan Sansai Zue: 105 volumes*. 倭漢三才図会:105巻首1巻尾1巻, Akitaya, Osaka and others. (info:ndjp/pid/2569720 [24]). National Diet Library Digital Collections.
- The third field survey team of Okinoshima (ed.) (1979) 第三次沖ノ島学術調査隊編著, *Munakata Okinoshima (Honbun, Siryō and Zuhan)*, 宗像沖ノ島『本文』『史料』『図版』 (Reports and studies on excavation projects in Munakata Okinoshima, of 3 volumes: texts, archives and plates) 宗像大社復興期成会 Munakata Taisha Hukkōkisei-kai.
- Tōdō, A. (ed.) (1995) 藤堂明保, *Gakken Kanwa Daijiten* 学研漢和大辞典 (A dictionary giving the meaning of Chinese characters by Gakken), Gakushū Kenkyūsha, Tokyo.
- Tsujimura, K. (1984) 辻村喜一, *Man'yō no Yamaai-zome* 萬葉の山藍染め (Dyeing using Yamaai during the time of the *Man'yōshū*), Senshoku to seikatsusha, Kyoto.
- Tsukishima, H. (2014) 築島裕, *Rekishiteki Kanadzukai* 歴史的仮名遣い (Historical use of the Japanese Syllabary), Yoshikawa Kobunkan, Tokyo.
- Uemura, R. (1979) 上村六郎, *Uemura Rokorō Chosakushū* 上村六郎染色著作集一, 二, 三 (Works of Rokurō Uemura on the dyeing 1, 2, 3), Shibunkaku, Kyoto.
- Yamaguchi, Y. & Kōnoshi, T. (2004), *Kojiki* (古事記) *Shinpen Nihon Koten Bungaku Zenshū* 新編日本古典文学全集1 (New edition of Japanese Classics vol. 1), Interpreted and edited for modern Japanese by Y. Yamaguchi and T. & Kōnoshi.

### English

- Barber, E.J.W. (1991) *Prehistoric Textiles*, Princeton.
- Broudy, E. (1993) *The Book of Looms*, New York.
- Francis, Jr., P. (1990) Glass Beads in Asia Part Two. Indo-Pacific Beads, *Asian Perspectives*, Vol. 29, no. 1, 1-23.
- Kizawa, N. (2014) 木沢直子 A study of “Double-sided comb” in Ancient East Asia -Excavated examples and their origin. In *2014 Society for East Asian Archaeology 6<sup>th</sup> World Conference in Mongolia*, supported by JSPS

- KAKENHI, grant-in aid of Japan Society for Promotion of Science, no. 25370903 Basic (C), 47. Ulaanbaatar.
- Kuhn, D. (1988) Textile technology: spinning and reeling, part IX of the vol. 5 Chemistry and Chemical technology. In J. Needham (ed.), *Science and Civilisation in China Volume V :9*, 60-235. Cambridge and others.
- Mallory, J. P. & Mair, V. H. (2000) *The Tarim Mummies*. London.
- Mallory, J. P. & Adams, D. Q. (eds.), (1997) *Encyclopedia of Indo-European Culture*. London-Chicago.
- Nakamura, R., Tanaka, Y., Ogata, A., & Naruse. M. (2014) Scientific evidence by fluorescence spectrometry for safflower red on ancient Japanese textiles stored in the *Shōsōin* Treasure House repository, *Studies in Conservation*, Volume 59, Number 6, November 2014, 367-376.
- Pulleyblank, E.G. (1991) *Lexicon of Reconstructed Pronunciation in Early Middle Chinese, Late Middle Chinese, and Early Mandarin*. Vancouver.

### Chinese

- 中国科学技术史 纺织卷 (中国科学技术史 紡績卷)  
赵承泽 主编 C. Zhao *et al.*, (eds.) (2002) (A History of Science and Technology in China / vol. of the textile technology) 科学出版社 Science Press, 北京 Beijing.

## The Textile Term *gammadia*

Maciej Szymaszek

This paper aims to investigate the origin of the term *gammadia* by determining the oldest examples of its use both in source texts and secondary literature.<sup>1</sup> For nearly four centuries this term was commonly applied to the various motifs on mantles of figures represented in art of the 1st millennium AD.<sup>2</sup> These right-angled and letter-like signs attracted the attention of several authors who were seeking to explain their possible symbolic meaning, but they did not pay attention to the correctness of the term adapted to name such motifs.<sup>3</sup> This approach contributed to the terminological confusion and difficulties in understanding the issue at hand.

### Dictionaries and travel guides

The semantic scope of the term *gammadia* was defined by the editors and authors of Latin dictionaries and travel guides in the 17th century. The definition of this term most likely appeared for the first time in 1663 in the lexicon *Vocabulista ecclesiastico*,<sup>4</sup> a book which became very popular and was reprinted many times.<sup>5</sup> According to this laconic and anonymous text, the term referred to a garment or chasuble which had woven signs in the shape of the Greek letter *gamma*.<sup>6</sup> At roughly the same time, Benedetto Mellini gave a similar explanation mentioning the opinions of other

1. The present contribution is an adapted English version of my study published in Polish: Szymaszek 2013. The paper was supplemented with a catalogue of all passages of the *Liber Pontificalis* containing the term *gammadia*.

2. Among others: Ciampini 1690, 90-105; Sarnelli 1716, 41-43; Martigny 1865, 285; Wessel 1971, Ghilardi 2007.

3. On the state of research see: Szymaszek 2014, 21-37.

4. Forte 1663, 79. It is difficult to point the authorship of this term, as it does not appear in the earlier versions of the lexicon of Giovanni Bernardo Forte, printed for the first time in the year 1480.

5. Cf. Marazzini 1987; Gaburri 1994; Marazzini 2009, 37-53.

6. Forte 1663, 79: “gammadia, ae, & gammodium ij, veste, ò pianeta tessuta con figure del Γ γ lettera greca, non sò, se grande o piccola. Anastas. Biblioth.”.

people who recognized *gammadiae* as signs composed of four gammas forming a cross  $\Gamma$ .<sup>7</sup> A very similar definition and illustration were also included in the *Hierolexicon sive sacrum dictionarium* which was published in 1677.<sup>8</sup> In all three texts the authors referred to Anastasius the Librarian as the origin of the term, more specifically to the Book of Pontiffs, *Liber Pontificalis*, whose authorship was once attributed to him.<sup>9</sup>

### The Book of Pontiffs

The *Liber Pontificalis* (here abbreviated *LP*) is probably the only textual source in which the term *gammadia* appears.<sup>10</sup> The term can most often be found in acc. pl. fem. as *gammadias*, rarely in abl. pl. fem. as *gammadiis*<sup>11</sup> or in acc. pl. fem. without gemination as *gamadias*.<sup>12</sup> It is present in the sections covering the lives of six popes over a narrow period of only 63 years. It is mentioned for the first time in the

description of the gifts of Pope Leo III (795-816)<sup>13</sup>, and for the last time in the biography of Pope Benedict III (855-858).<sup>14</sup> In the text the term *gammadia* is mostly applied in conjunction with the names of various types of utilitarian textiles called *vestis*, *velum* and *tetravila*. It also appears in relation to the names of architectural elements such as columns and arches.

### *Gammadia* on altar cloths (*vestes*)

In the *LP* the word *vestis* is one of the terms denoting altar cloths.<sup>15</sup> Such pieces were described as made of silk or woven *de fundato*<sup>16</sup> and had a purple, red or white colour. The number of *gammadia* occurring on each fabric is described in three segments of the text, in which four motifs of this type are listed.<sup>17</sup> Moreover, techniques in which *gammadia* were produced are mentioned in the *LP*. They were woven with gold and silver thread or created by “golden stripes” (*chrisoclabas*). The other two terms which

7. This information was provided by Giovanni Ciampini who owned a copy of Mellini’s guide and included a Latin translation of his text in: Ciampini 1690, 95: “At istae Gammadiae nihil aliud erant, quàm Crucium figurae ex quatuor Gammatis co(m)positae, videlicet  $\Gamma$  tam in profanis, quàm in sacris vestibus textae, ut etiam hodie in suis Casulis Graeci habent”. Cf. Guidobaldi & Angelelli 2010, 341-342.
8. Macro 1677, 285: “vestis sacra cum figuris in forma litterae graecae. Gamma  $\Gamma$  contexta, qua utebantur etiam Latini, ut in musiu, & antiquis Romae picturis conspicitur. (...) Igitur hoc vocabulum nedum vestem; sed etiam textile hisce characteribus angularibus formatu significat”. The lexicon was published after the Macro’s death and it is not possible to state who wrote this entry.
9. The problem of attribution of the *LP* to Anastasius the Librarian was widely discussed in Arnaldi 1963 and 2000.
10. Fragments of the *LP* are taken from a critical edition of the source: Duchesne 1955 (abbreviated here as *LPDu*). On the historical value of *LP* and its reception in later periods, see among others: Leclercq 1930, 354-459; Geertman 1989; Bauer 2004, 27-38.
11. For instance: *LPDu*, 55: “in circuitu altaris vela rubea sirica IIII, cum gammadiis et cruce de quadrapulo”; *ibidem*, 122: “vestem de fundato I, habentem in medio crucem cum gammadiis et periclisin de blata, legentem de nomine domni Leonis quarti papae”.
12. *LPDu*, 9: “veste de stauraci cum cruce et gamadias, simul et paratrapetis suis, cum periclisin de chrisoclavo”; *ibidem*, 26: “arcum argenteum I cum gamadias suas”.
13. *LPDu*, 2: “velum alithinum rotatum, habentem periclisin in rotas cum aucellos et in medio cruce cum gammadias et IIII rotas de tyreo filopares”.
14. *LPDu*, 146: “veste de fundato I, habentem in medio crucem cum gammadias de quadrapulo”.
15. Cf. Braun 1924, 9-10. Other terms used as names of altar cloths in the early medieval period are discussed in: Speck 1966 and Bovini 1974, 77-81.
16. Interpretation of this term remain unclear: Szymaszek 2013, n. 17; cf. Petriaggi 1984, 44 (“trapunto d’oro a disegno della rete da Funda, ‘rete da pesca’”); Martiniani-Reber 1999, 292 (“tissu de luxe [...]. Il peut aussi servir à décorer un textile, sans doute en application. On présume qu’il se composait principalement de fils d’or”); Ripoll 2005, 60 (“tejido de seda decorado con figuras tejidas, a modo de contorno u orla, siempre destinado a paramentos sacros”).
17. *LPDu*, 3: “vestem de blathin, habentem in medio crucem de chrisoclavo et tabulas chrisoclabas IIII, cum gemmis ornatas, atque gammadias in ipsa veste chrisoclabas IIII, cum periclisin de chrisoclavo”; *ibidem*, 96: “necnon et aliam vestem rubeam I, cum caballo albo habente alas, cum periclysi de chrysoclavo et gammadias IIII et crucem de chrysoclavo”; *ibidem*, 125: “vestem de fundato cum IIII gammadiis auro textis I”. No similar information can be found in other sections which may indicate that it was not necessary to specify the number of *gammadia*.

appear in this context - *de quadrapulo* and *de obtapulo* - remain unclear.<sup>18</sup>

The general descriptions in the *LP* are helpful to determine the location of the *gammadia* on the altar cloths. The author of the analysed section of the *LP* first mentions elements he considered to be the most important, such as a theme or a scene which was usually located in the centre of the cloth.<sup>19</sup> The description then continues with other motifs that were placed away from the centre and concludes with information about the borders (*periclisin*, *lista*).<sup>20</sup> Keeping this schema in mind, it can be stated that the term *gammadia* predominantly occurs in the final part of the description, prior to information about the borders.

### ***Gammadia* on curtains (*vela*)**

*Vela* is the second type of fabric mentioned in relation to *gammadia*. Such curtains were usually donated in sets of four,<sup>21</sup> and thanks to the descriptions in the *LP* it can be said that they were suspended, *inter alia*, around the altar. *Gammadia* were made *de obtapulo*, *de chrisoclavo* or *de tyreo*,<sup>22</sup> an expression which may be associated with the colour of the fabric (purple?), the material with which they were made (silk?), or their place of manufacture (Tyre?).<sup>23</sup> Neither the number nor the location of *gammadia* on the curtains are defined in the

*LP*. The only exception is the section of text acknowledging that these motifs were placed *in circuitu*, denoting a location around the edges of the fabric.<sup>24</sup>

### **Set of four curtains (*tetravila*) decorated with *gammadia***

The third term, *tetravila*, only appears in connection with *gammadia* in the life of Pope Leo III.<sup>25</sup> On the semantic and syntactic layers it refers to the four *vela* and specifies a set of curtains that surrounded the altar on all four sides. Both the material used to make *tetravila* and the way it was decorated correspond with information in the descriptions of the curtains. These were fabrics made of silk which were white, purple or red. *Gammadia* were executed *de chrisoclavo*, which can be translated as ‘by the golden stripes’.

### ***Gammadia* as a name of curtain**

The term *gammadia* also occurs in the biographies of Leo III, Paschal I, and Benedict III in connection with architectural elements in churches, such as arches and columns.<sup>26</sup> Three passages explicitly confirm their location as in close proximity to the altar, probably in the construction of *ciborium* standing over altar.<sup>27</sup>

18. For the discussion of both terms see: Szymaszek 2013, 127; cf. among others: Martiniani-Reber 1999, 292 (“Les chiffres huit et quatre peuvent indiquer un rapport d’armure ou énoncer les côtés d’une forme géométrique, octogonale ou carrée, composant les décors de ces tissus”); Saxer 1996-1997, 222 (“I *quadrapola* o *quadrapula* sono grandi pezze di stoffa ornate di graniture di oro o di seta ai quattro angoli”).

19. The issue of figural representations on the fabrics described in the *LP* was discussed by several authors: De Waal 1888, Beissel 1894; Von Sydow 1912, 7-14; Croquison 1964; Phillips 1988; Andaloro 1976; Andaloro 2003.

20. On the relations between the terms *periclisin* and *lista* see: Wiener 1917, 255-258.

21. Among others: *LPDu*, 57-58: “Fecit vela alitina venerabilis pontifex pendentes in circuitu altaris IIII, habentes cruces et gammadias de fundato et quadrapulo”; *ibidem*, 128: “fecit in circuitu altaris beati Petri apostoli vela sirica de prasino IIII, habentia tabulas de chrysoclavo, cum effigie Salvatoris et apostolorum Petri ac Pauli, seu ipsius almifici praesulis, et in medio cruces et gammadias de chrysoclavo cum orbiculis, in quibus sunt imagines apostolorum mirae pulchritudinis decoratas, quae in diebus festis ad decorem ibidem suspenduntur”.

22. *LPDu*, 75: “vela alba sirica IIII, unum habens undique tyreum et in medio crucem et gammadias de chrisoclavo, aliud de stauraci, habens in medio crucem de olovero et gammadias de tyreo”.

23. Cf. Du Cange 1887, 221; Oikonomides 1986, 37; Delogu 1998.

24. *LPDu*, 79: “vela de fundato VI, habentes in circuitu gammadias de obtapulo”.

25. *LPDu*, 26: “tetravila rubea alitina IIII, habentes cruces cum gammadias et in circuitu periclisin de tyreo”; *ibidem*, 30: “tetravila alba olosirica rosata, ex quibus unum habente in medio crucem de chrisoclavo et gammadias de chrisoclavo”.

26. For instance, *LPDu*, 53: “(...) super quem constituit arcora II de argento et gammadias IIII qui simul pens. lib. LX”; *ibidem*, 146: “arcum cum duobus gammadiis ex argento purissimo, pens. insimul lib. XL”.

27. *LPDu*, 3: “fecit et confessionem eiusdem altaris ex argento purissimo, pens. lib. CIII, uncias II; columnas argenteas VIII cum



Table 1. The use of the term *gammadia* in the *LP*

Donors	Type and number of textiles with <i>gammadia</i> -motifs mentioned <i>expressis verbis</i> in the <i>LP</i>			Number of <i>gammadia</i> -textiles in the <i>LP</i>	Quantity
	<i>Vestis</i>	<i>Velum</i>	<i>Tetravila</i>		
Leo III	2	1	5	4	12
Paschal I	-	8	-	8	16
Gregory IV	2	8	-	-	10
Sergius II	1	1	-	-	2
Leo IV	20	12	-	4	36
Benedict III	1	-	-	2	3
Total quantity	61			18	79

Relationships between architectural elements and *gammadia* are not expressed in the *LP*. It is therefore necessary to consider whether the author of the text used the term to name a pattern that appeared in the columns and arches, or an object with a specific decoration. A passage from the life of Paschal I, in which all of these terms occur, is helpful in answering this question.<sup>28</sup> Firstly, there are two columns mentioned, then an arch, and finally two *gammadia*. This may suggest that *gammadia* were seen as separate objects, not as integral part of the decoration of architectural elements.<sup>29</sup>

*Gammadia* is thus used in close conjunction with the names of structural elements and partitions of *ci-boria*. Given the context, it is clear that there were places for the suspension of *vela* and *tetravila*. This conclusion is crucial, as it presents the word *gammadia* not only in relation to the motif on the fabric, but also with a curtain decorated in a certain way.

### Popularity of *gammadia* among papal gifts

In order to interpret information concerning *gammadia*, it is helpful to compare the quantities and types of fabrics given by donors (tab. 1). On the one hand,

it can be observed that the decorative motifs called *gammadia* appear in the context of at least 61 textiles (30 *vela*, 26 *vestes* and five *tetravila*). On the other hand, *gammadia* is also used as a name for a curtain 18 times. This type of gift was most popular during the pontificate of Leo IV, who gave at least 32 *vestes* and *vela* with *gammadia* patterns to the churches, along with a further four curtains which were identified as *gammadia*. Summing up the data, the total number of fabrics listed in the *LP* which are decorated with and defined as *gammadia* could be at least 79. However, it is worth noting that these fabrics do not constitute a dominant part of the papal gifts and account for less than 4% of the total number of curtains and altar cloths donated by Leo III, Paschal I, Gregory IV, Sergius II and Leo IV.<sup>30</sup>

### *Gammadia* and *gammula*

The results of the analysis indicate that the term *gammadia* referred to a decoration on the altar cloths and curtains, but also that it was used as a term for certain fabrics hung around an altar. The decoration of these textiles probably featured signs constructed of two stripes that met at right angles. They could easily

*gammadias* II et arcora II, cum cruce argenteas V et gabathas XV, pens. simul libras CL”; *ibidem*, 17: “veste de stauraci super eum posuit; atque regularem ubi supra investitum ex argento purissimo fecit; et super ipsum regularem posuit arcum et gammadias ex argento, qui pens. simul lib. LXXX”; *ibidem*, 57: “ante vestibulum altaris regularem investitum ex lamminis argenteis et columnis duabus, ubi et posuit arcum I et gammadias II, pens simul. lib. C semis [sic!]”.

28. *LP*Du, 57 (quoted in the previous footnote).

29. In one case, the reference to “cum gammadias suas” states that *gammadia* were associated with arches, cf. note 11.

30. Statistical information regarding textiles mentioned in the *LP* was provided in Delogu 1998, 124. The gifts of Pope Benedict III were not analysed by Delogu.



**Fig. 1.** Altar cloth with signs in a right-angled shape, central panel of the casket donated by Pope Paschal I (Thunø 2002, fig. 65).

be associated with the shape of the *gamma* letter and gave rise to the term which was seemingly invented by the author or the authors of papal biographies in the first half of the 9th century.

A similar term, *gammula*, can be found in a section of *LP* written more than 100 years prior to the part of the text featuring *gammadia*. It appears only once in the life of Pope Benedict II (684-685).<sup>31</sup> Analogous to *gammadia*, the term is a name of an ornamental motif on a purple altar cloth (*coopertorium*). The context of

use and the similar root of both words may indicate the decoration of covers and curtains with the signs of the same shape.<sup>32</sup>

### Representations in art

These hypotheses are confirmed by iconographic and archaeological sources which include late antique and early medieval representations and fabrics.<sup>33</sup> An example of this is a casket donated by Pope Paschal I

31. Duchesne 1955, vol. 1, 363: “Similiter in ecclesia beate Mariae ad alium Martyres coopertorium porphyrum cum Croce et gammulas et clavos IIII auroclavos et al circuito palergium de olosiricum pulcherrimum”.

32. It should also be noted that the similar understanding of the term *gammula* appears in the 14<sup>th</sup> century in Pietro Bohier’s comments to the *LP*: “Gamulas: Id est litteras; ad gamma, quod est littera” (Přerovský 1978, 259).

33. For the scope of this paper only some examples will be given. More extensive material is discussed in Szymaszek, *forthcoming*.



**Fig. 2.** White hanging with red decorations, Monastery of St. John in Müstair, Switzerland (Goll, Exner, Hirsch 2007, 198).



**Fig. 3.** Curtains in the intercolumnia of the so-called palace of Theodoric, Church of Sant'Apollinare Nuovo in Ravenna, Italy (© Maciej Szymaszek, 2007).

(817-824) which originated from the period in which the biographies of relevance for this work were edited (fig. 1).<sup>34</sup> The central panel depicts the scene of the communion of the Apostles; Christ stands behind the altar covered with a cloth on which a cross and four motifs are visible, each made of two strips joined at right angle. The number and location of these signs, as well as the way in which they were represented on the surface - clearly distinguished and with a different texture than the background fabric - corresponds to the descriptions in the *LP*.

Gold, purple and black signs in a right-angled shape can be seen on many altar cloths depicted in the representations of a variety of topics. They are dated to the period preceding the redaction of part of the papal biographies discussed here, or are contemporary to them, or later. Among others they appear on mosaics in churches of Ravenna, such as Sant'Apollinare Nuovo, San Vitale and Sant'Apollinare in Classe, but also on the diptych from the National Museum in Warsaw, and on the so-called Vatican dalmatic now kept at the Museo del Tesoro di San Pietro.<sup>35</sup>

34. Grisar 1907, 129-135, fig. 34; Thunø 2002, 79-117, pl. III, figs. 65, 66, 67.

35. Szymaszek 2013, 132-133.



**Fig. 4.** Templon screen with suspended white hangings with right-angled marks, Small Metropolis in Athens, Greece (© Maciej Szymaszek, 2008).

In regard to curtains, the paintings at the monastery in Müstair in Switzerland dated to the second quarter of the 9<sup>th</sup> century are especially valuable. They represent a suspended white hanging with red decorations and most probably mimic fabrics used in the interiors of churches (fig. 2).<sup>36</sup> The cloth is enclosed on four sides with red marks in the shape of two strips at right angles. Such a distribution of motifs is in conformity with the *LP* in which *gammadia* occurred on *vela* along with crosses and circles.

Similar signs also appear in the earlier monuments,<sup>37</sup> for instance, on the mosaic in the church of Sant'Apollinare Nuovo in Ravenna which is dated to the 6<sup>th</sup> century. It represents the so-called palace of Theodoric with white curtains suspended in the intercolumnia of the façade (fig. 3).<sup>38</sup> Golden motifs in shape of “gamma” with gold squares placed between the arms of the signs can be found on hangings in the central passage of the palace.

36. Goll, Exner, Hirsch 2007, 108-109, 198.

37. Szymaszek 2013, 134.

38. Deichmann 1958, figs. 107, 108. The same motifs also appear on preserved textiles interpreted as altar cloths, table covers or hangings. For instance, on a fabric from Egypt dated to the 4<sup>th</sup>-5<sup>th</sup> century, two corners are occupied by colored right angled stripes (Turell Coll 2004, 146-148, fig. 1). Another example is dated to the period between the 6<sup>th</sup> and 9<sup>th</sup> century and is believed to be a curtain (Schrenk 2004, 114-116). There are two marks formed from two strips at right angles in the corners.

## Conclusions

The aim of this study was to reveal the origins of the term *gammadia* through the source texts. This term was found exclusively in the *Liber Pontificalis* and only in the biographies of the popes from the end of the 8th to the middle of the 9th century. In this limited period the term was used both as a name of right-angled motifs placed in corners of altar covers and curtains and also as a name of a textile hanging with such decorations. As such, there is no support in the *LP* for the belief expressed in literature that the term *gammadia* was connected with motifs of other shapes, such as those widely recurring on mantles of figures in the 1st millennium AD.<sup>39</sup>

The method of decorating curtains with right-angled decoration placed in the corners of the cloth persists to the present day. An example of this is the hangings photographed by the author in 2008 at the Small Metropolis in Athens (fig. 4). These bands correspond to the shape of the motifs appearing on textiles and representations dated back to the 1st millennium AD and to the description of *gammadia* in the analysed part of the *LP*.

## Bibliography

- Andaloro, M. (1976) Il Liber Pontificalis e la questione delle immagini da Sergio I a Adriano I. In *Roma e l'età carolingia. Atti delle giornate di studio 3-8 maggio 1976*, Roma, 69-79.
- Andaloro, M. (2003) Immagine e immagini nel Liber Pontificalis da Adriano I a Pasquale I. In H. Geertman (ed.), *Atti del colloquio internazionale "Il Liber Pontificalis e la storia materiale"*, Roma, 21-22 febbraio 2002, Roma, 45-103.
- Arnaldi, G. (1963) Come nacque l'attribuzione ad Anastasio del Liber Pontificalis, *Bullettino dell'Istituto Storico Italiano per il Medio Evo e Archivio Muratoriano* 75, 321-343.
- Arnaldi, G. (2000) Anastasio Bibliotecario, antipapa. In *Enciclopedia dei Papi*, vol. 1, Roma, 744-746.
- Bauer, F.A. (2004) *Das Bild der Stadt Rom im Frühmittelalter*, Wiesbaden.
- Beissel, S. (1894) Gestickte und gewebte Vorhänge der römische Kirchen in der zweiten Hälfte des VIII. und in der Hälfte des IX. Jahrhunderts, *Zeitschrift für Christliche Kunst* 9, c. 357-374.
- Braun, J. (1924) *Der Christliche Altar in seiner geschichtlichen Entwicklung*, vol. 2, München.
- Bovini, G. (1974) Le tovaglie d'altare ricamate ricordate da Andrea Agnello nel Liber Pontificalis Ecclesiae Ravennatis, *Corso di Cultura sull'Arte Ravennate e Bizantina* 21, 77-81.
- Ciampini, G. (1690) *Vetera monimenta*. Romae.
- Croquison, J. (1964) L'iconographie chrétienne à Rome d'après le Liber Pontificalis, *Byzantion* 34, 581-603.
- Deichmann, F.W. (1958) *Frühchristliche Bauten und Mosaiken von Ravenna*, Baden-Baden.
- Delogu, P. (1998) L'importazione di tessuti preziosi e il sistema economico romano nel IX secolo. In P. Delogu (ed.) *Roma medievale. Aggiornamenti*, Firenze, 123-141.
- De Waal, A. (1888) Figürliche Darstellungen auf Teppichen und Vorhängen in Römischen Kirchen bis zur Mitte des IX Jahrhunderts nach dem Liber Pontificalis, *Römische Quartalschrift* 2, 313-321.
- Du Cange, C. (1887) *Glossarium mediae et infimae latinitatis*, vol. 8, Paris.
- Duchesne, L. (1955), *Le Liber Pontificalis, texte, introduction et commentaire*, vol. 2, Paris.
- Exner, M. (2007) Il programma iconografico della chiesa abbaziale nel contesto storico. In J. Goll, M. Exner, S. Hirsch (eds.), *Müstair. Le pitture parietali medievali nella chiesa dell'abbazia*, Müstair.
- Forte, G. B. (1663) *Vocabularium ecclesiasticum*. Romae.
- Gaburri, E. (1994) Il Vocabulista ecclesiastico (1480-1731) di Giovanni Bernardo Forte, *Quaderni Franzoniani* 7:2, 267-282.
- Geertman, H. (1989) Nota sul Liber Pontificalis come fonte archeologica. In P. Pergola & F. Bisconti (eds.), *Quaeritur inventus colitur. Miscellanea in onore di padre Umberto Maria Fasola*, Città del Vaticano, 349-361.
- Ghilardi, M. (2007) Gammadie. In A. di Berardino (ed.), *Nuovo dizionario patristico e di antichità cristiane*, vol. 1, Genova-Milano, c. 2054-2056.
- Goll, J., Exner, M., Hirsch, S. (2007) *Müstair. Le pitture parietali medievali nella chiesa dell'abbazia*, Müstair.
- Grisar, H. (1907) *Il Sancta Sanctorum ed il suo tesoro sacro*, Roma.
- Guidobaldi, F. & Angelelli C. (2010), *La 'Descrizione di Roma' di Benedetto Mellini nel Codice Vat. Lat. 11905*, Città del Vaticano.

39. Cf. note 3; Szymaszek 2015; 2016. See also the catalogue with over 360 representations with the so-called *gammadia* in: Szymaszek 2014.

- Leclercq, H. (1930) *Liber Pontificalis*. In F. Cabrol & H. Leclercq (eds.), *Dictionnaire d'archéologie chrétienne et de liturgie*, vol. 9, Paris, 354-459.
- Macro, D. (1677) *Gammadia*. In D. Macro (ed.), *Hierolexicon sive sacrum dictionarium*, Romae, 285.
- Marazzini, C. (1987) Un vocabolario per il pulpito. Note sulla fortuna del 'Vocabulista ecclesiastico' nei secc. XV-XVI, *Annali della Facoltà di Lettere e Filosofia dell'Università di Macerata* 20, 327-337.
- Marazzini, C. (2009) *L'ordine delle parole. Storia di vocabolari italiani*, Bologna.
- Martigny, J.A. (1865) *Dictionnaire des Antiquités Chrétiennes*, Paris.
- Martiniani-Reber, M. (1999) Tentures et textiles des églises romaines au haut Moyen Âge d'après le *Liber Pontificalis*, *Mélanges de l'École française de Rome. Moyen-Âge* 111, 289-305.
- Oikonomides, N. (1986) Silk Trade and Production in Byzantium from the 6<sup>th</sup> to the 9<sup>th</sup> Century: the Seal of the Kommerkiarioi, *Dumbarton Oaks Papers* 40, 33-53.
- Petriaggi, R. (1984) Utilizzazione, decorazione e diffusione dei tessuti nei corredi delle basiliche cristiane secondo il *Liber Pontificalis* (514-795), *Prospettiva. Rivista di storia dell'arte antica e moderna* 39, 37-46.
- Phillips, L.E. (1988) A Note on the Gifts of Leo III to the Churches of Rome: 'vestes cum storiis', *Ephemerides Liturgicae* 102, 72-78.
- Ripoll, G. (2005) Los tejidos en la arquitectura de la antigüedad tardía. Una primera aproximación a su uso y función. In A. Köb & P. Riedel (eds.), *Kleidung und Repräsentation in Antike und Mittelalter*, München, 45-62.
- Sarnelli, P. (1716) *Lettere Ecclesiastiche*, vol. 8, Venezia.
- Saxer, V. (1996-1997) Le informazioni del *Liber Pontificalis* sugli interventi dei papi nella decorazione tessile delle chiese romane: l'esempio di S. Maria Maggiore (772-844), *Rendiconti. Pontificia Accademia Romana di Archeologia* 69, 219-232.
- Schrenk, S. (2004) *Textilien des Mittelmeerraumes aus spätantiker bis frühislamischer Zeit*, Riggisberg.
- Speck, P. (1966) Die Ἐνδυτή. Literarische Quellen zur Bekleidung des Altars in der byzantinischen Kirche, *Jahrbuch der Österreichischen Byzantinischen Gesellschaft* 15, 323-375.
- Szymaszek, M. (2013) Termin *gammadia* w *Liber Pontificalis*, *U schyłku starożytności. Studia źródłoznawcze* 12, 119-147.
- Szymaszek, M. (2014) *Signs (so-called gammadia) on Roman and Late Antique Textiles in the Light of Archaeological, Iconographic and Literary Sources*, Lublin.
- Szymaszek, M. (2015) On the interpretation of textile finds with right-angled or H-shaped tapestry bands. In A. De Moor, C. Fluck, P. Linscheid (eds.), *Textiles, tools and techniques of the 1st millennium AD from Egypt and neighbouring countries. Proceedings of the 8th conference of the research group 'Textiles from the Nile Valley'*, Antwerp, 4-6 October 2013, Tiel 2015, 168-175.
- Szymaszek, M. (2016) L'origine delle cosiddette *gammadiae* nell'arte cristiana antica. In O. Brandt, G. Castiglia, V. Fiocchi Nicolai (eds.), *Acta XVI Congressus Internationalis Archaeologiae Christianae Romae (22-28.9.2013): Costantino e i costantinidi. L'innovazione costantiniana, le sue radici e i suoi sviluppi*, Città del Vaticano 2016, 2415-2426.
- Szymaszek, M. (forthcoming) *Signs, symbols or ornaments? The origin and function of so-called gammadia*.
- Thunø, E. (2002) *Image and Relic. Mediating the Sacred in Early Medieval Rome*, Rome.
- Turell Coll, L.G. (2004) Los tejidos coptos del Museo de Montserrat. Presentación de la colección, *Antiquité Tardive* 12, 145-152.
- Von Sydow, E. (1912) *Die Entwicklung des Figuren Schmucks der Christlichen Altar-Antependia und -Retabula bis zum XIV. Jahrhundert*, Strassburg.
- Wessel, K. (1971) *Gammadia*. In K. Wessel (ed.), *Reallexikon zur Byzantinische Kunst*, vol. 2, Stuttgart, c. 615-620.
- Wiener, L. (1917) *Contributions Toward a History of Arabico-Gothic Culture*, vol. 1, New York.

## The *oscillum* Misunderstanding<sup>1</sup>

Francesco Meo

*Et te, Bacche, vocant per carmina laeta, tibi que  
Oscilla ex alta suspendant mollia pinu*

Verg. G. II, 389

In this passage the Latin term *oscillum* refers to a particular class of objects: a small face or mask hung on trees during certain religious feasts celebrated by the Ausones in honour of Bacchus (Fig. 1). The Roman *oscilla* most probably derives from the *Αἰῶραι*, small images related to Dionysus hung on trees during the *Αἰῶρα*, an Athenian public feast. They were believed to purify the air as they swung in the wind.<sup>2</sup>

Both the Greek and the Latin words refer to objects used during particular sacred feasts, in the first case public and in the second case private, inside *villae*.

However, the term *oscillum* has also been applied to certain shapes (circular and semicircular) of loom weights (Fig. 2). Italian archaeologists in particular have traditionally used the term *oscillum* to refer

to these weights, reserving the term ‘peso da telaio’ (loom weight) for the traditional shapes (truncated pyramid and truncated cone). Most of the archaeological literature identifies circular and semicircular loom weights as such, although there have been contrasting interpretations of their function ever since the late 19<sup>th</sup> century. What caused the term *oscilla* to be transferred from sacred objects to loom weights must surely have been the latter’s unconventional shape and their decorations and inscriptions. But when and why did this take place?

Before 1906 they were studied for their inscriptions and they were generically described as “clay disks”, probably used as labels. Percy Gardner was the first archaeologist to deal specifically with these disks, analysing samples with the inscription *ηνιω*.<sup>3</sup>

1. I would like to thank Marie-Louise Nosch and Cécile Michel for their kind invitation to the Workshop, and S. Gaspa and the whole of the CTR group for their wonderful hospitality. The present paper was developed as part of the project *L’attività tessile nell’Italia meridionale preromana: tecniche, tecnologie, materiali e protagonisti* (nr. JPCNYJ5), co-funded by the *Fondo di Sviluppo e Coesione 2007-2013 – APQ Ricerca Regione Puglia “Programma regionale a sostegno della specializzazione intelligente e della sostenibilità sociale ed ambientale - FutureInResearch”*.

2. Mansuelli 1963.

3. Gardner 1883. Before his study, discs had never been considered in specific studies but only mentioned in publications on choroplastic art (Lenormant 1881-82, 166) or inscriptions from Taranto (Barnabei 1882, 387).

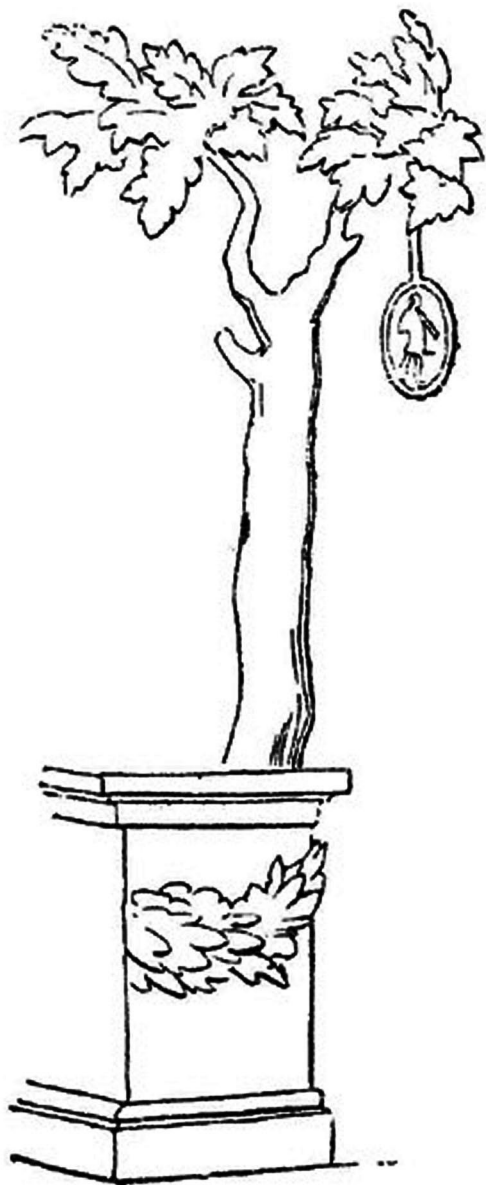


Fig. 1. Drawing of the *oscillum* use (after Daremberg, Saggio 1877-1919).

He argued the disks “were used to weigh out a half obol’s worth of some commodity”.<sup>4</sup> A few years later, Giulio Emanuele Rizzo proposed that two disks from Agrigento with both faces decorated with a *gorgoneion* could have been terracotta *emblemata* with several functions: toys for children, *ἀποτρόπαια* hung inside houses or loom weights.<sup>5</sup> At the beginning of the 20<sup>th</sup> century, Wilhelm von Christ saw them as *ex-voto* objects to be hung on a wall or a panel using their two holes.<sup>6</sup>

In 1906, Paolo Orsi understood they could be loom weights, but also gifts for children or *ἀποτρόπαια* in houses.<sup>7</sup> However, he perceived their main use as being hung on trees in order to provide symbolic protection and to prevent birds from entering the fields and eating the crops. Studying their decorations, he saw that some of them may indeed have been related to Dionysus but even if they were not expressly Greek *αἰῶραι* or Latin *oscilla*, their purpose was similar.

This hypothesis would not be revisited until 1945. In the 1920s, Walton Brooks McDaniel suggested that the disks “were attached by custom-house officers who had exacted that amount of duty or some other fee”,<sup>8</sup> as had been partially hypothesised by Gardner in 1883. In the 1930s, Pierre Wuilleumier suggested that the disks could be an indicator of either the value of the goods in the bag they sealed<sup>9</sup> or a tax.<sup>10</sup>

In 1945, Biagio Pace argued they were clearly an attestation of the cult of trees “Più sicuro documento del culto degli alberi...”.<sup>11</sup> He did not use the term *oscillum* but “mascheretta fittile” (small clay mask). However he clearly connected them to *oscilla* because he wrote that peasants hung these objects on trees in honour of Dionysus.

In 1953, Piero Orlandini understood the main value of these objects to be ritual and symbolic.<sup>12</sup> His analysis was very detailed, describing all their

4. Gardner 1883, 157.

5. Rizzo 1897, 284-285.

6. von Christ 1900.

7. Orsi 1906, 753-758, tav. LVI.

8. McDaniel 1924, 44, footnote 7.

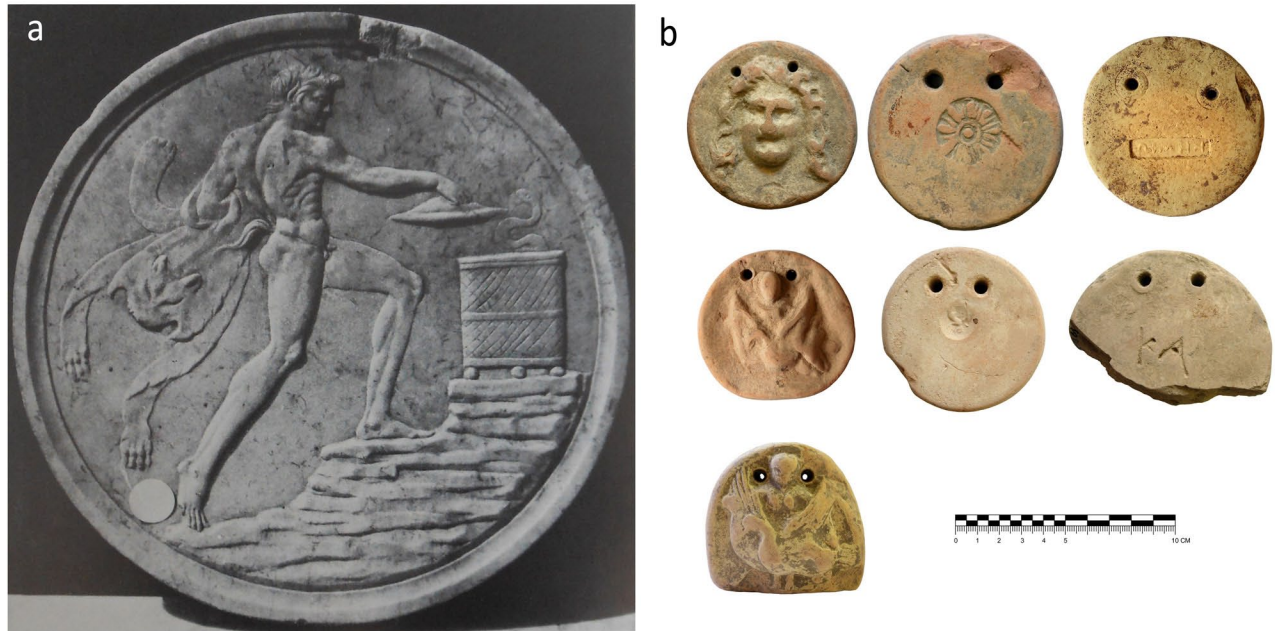
9. Wuilleumier 1932, 48-49.

10. Wuilleumier 1939, 223.

11. Pace 1945, 460-462.

12. Orlandini 1953.





**Fig. 2.** Marble *oscillum* from Pompei (after Dwier 1981) and loom weights (sometimes defined *oscilla*) from Herakleia (author).

sacred functions. First of all, noting many of these items were from the foundations of Greek buildings, he proposed that they served a consecratory function. At the same time however, they wouldn't have been used in such a way if they hadn't already acquired a sacred meaning, that is, if they hadn't been hung by their holes. Thus, Orlandini wrote that they had been specifically created to be hung and they are therefore *oscilla*.<sup>13</sup>

After these considerations he also wrote: “Una prova di ciò l'abbiamo nello stretto legame che intercorre fra i «pesi» e gli *oscilla* fittili nel IV e III secolo av. Cr.”. In this sentence, “pesi” (weights) clearly refers to the truncated pyramids, while the *oscilla* are the circular forms.<sup>14</sup> However, he also wrote that the truncated pyramids were not actually loom weights

either, but were hung on trees even before the appearance of the circular type in the 4<sup>th</sup> century BC.

The following year, Sebastiana Lagona also insisted that the so-called *oscilla* served a primarily votive purpose.<sup>15</sup>

In 1970, Ciro Santoro once more considered the hypothesis that they could represent payment of taxes, analysing the inscriptions on a few examples.<sup>16</sup>

While not doubting the primary use of these objects as loom weights, in 1974 Paolo Mingazzini proposed a series of secondary uses based on stamps and inscriptions.<sup>17</sup> His view was shared by Franca Ferrandini Triosi (1986).<sup>18</sup>

Most of the archaeological literature by now considers the so-called *oscilla* to be circular or hemispherical loom weights,<sup>19</sup> in some cases proposing a

13. Orlandini 1953, 444.

14. Orlandini 1953, 443.

15. Lagona 1954.

16. Santoro 1970, 149.

17. Mingazzini 1974.

18. FerrandiniTroisi 1986.

19. Some examples are: Dotta 1989; Caminnecki 1996; Manganaro 2000, 124-125; Rossoni, Vecchio 2000, 887-891, tav. CLXV.2; Nicotra 2007, 241-248; Spatafora, De Simone 2007, 38-40; Anelli 2008, 224; Bonanno 2008; Foxhall 2011; 2012.

series of secondary purposes for the decorated and inscribed specimens.<sup>20</sup>

The distinction between truncated pyramid and circular weights is still made in many museum catalogues at two different levels: one is functional, depending on the shape, while the other is based on the presence of decoration or a particular inscription.

As an example of the first case, Angela Marinazzo writes in the catalogue of the museum of Brindisi that “gli oscilla venivano appesi sulle architravi delle porte di abitazione” (the *oscilla* were hung on the lintels of the doors of houses),<sup>21</sup> and Alberto Bacchetta subsumes circular loom weights with Roman *oscilla*.<sup>22</sup>

Other catalogues reflect the second type of distinction. Simon Besques separates loom weights (*pesons*) from disks (*disques*) in the 1986 catalogue of the Louvre museum. In this case the *pesons* include both truncated pyramid and circular loom weights with engraved and stamped letters,<sup>23</sup> while *disques* are discoid weights with at least one fully decorated face and moulded inscriptions.<sup>24</sup> In the catalogue of the Lagioia Collection in Milan, Federica Giacobello describes one hemispherical and three discoid circular loom weights as *oscilla*.<sup>25</sup> The catalogue of the De Brandis Collection in Udine, compiled by Marina Rubinich in 2006 makes a further distinction: circular weights with inscriptions or stamps are *pesi* (weights) while those with decoration are *oscilla* (Fig. 3).<sup>26</sup>

However, in my view the misunderstanding arises from the approach to studying these objects. Most of the published material is from museum catalogues, which never offer a precise picture because the material they are based on is part of a selection. The consequence is that only decorated or inscribed examples usually feature in publications, making it seem

as if that all loom weights are decorated or inscribed. However, if we systematically study specific contexts we can see that this is not the case: in the western part of the Collina del Castello district of Herakleia, a Greek town in Southern Italy, about 60% of the specimens (1661 out of 2794) have no decoration or inscription,<sup>27</sup> and similar situations are seen in the rural settlements near this and other Greek towns in the same area (Fig. 4).<sup>28</sup>

Italian archaeologists have traditionally focused on decorations and inscriptions, neglecting their functional aspect, and the weights described in the literature are often selected for their decoration or inscriptions. Most of the publications concerning the Vallo of Herakleia, a sacred context in the Greek town, refer only to decorated loom weights, even though more than 67% of the discoid loom weights (51 out of 76) have no decoration or inscription, despite this being a sacred context.<sup>29</sup>

The systematic study of archaeological materials from various sites along the northern shore of the Gulf of Taranto suggests the presence of a substantial textile industry in the 3<sup>rd</sup> and 2<sup>nd</sup> centuries BCE that used circular weights with two holes. Their shape, which has caused so many problems in their interpretation, actually enabled the creation of a denser fabric than the traditional truncated pyramid weights.<sup>30</sup>

A secondary function for those specimens with decoration or inscriptions cannot be ruled out, but I argue that their main use was as weights. Furthermore, the Latin word *oscillum* used in this case is inappropriate, since these objects are usually from Greek towns. Even if they were hung on trees or used during religious feasts, the correct term is *aio-rai* rather than *oscilla*.

20. Ad esempio L’Erario 2012.

21. Marinazzo 2004, 72-73; 2009, 138-139.

22. Bacchetta 2006, 32.

23. Besques 1986, 91-92.

24. Besques 1986, 92-93.

25. Giacobello 2004, 383-384, 411-412.

26. Rubinich 2006, 232-236.

27. Meo 2015, cap. IV.1.

28. Meo 2015, cap. IV.3-IV.5.

29. Meo 2015, cap. IV.2.

30. Mårtensson *et al.* 2007; Mårtensson *et al.* 2009; Andersson Strand 2010; Meo 2012; Meo 2014a; Meo 2014b; Meo 2015.

nile è stata sostituita la testa di una civetta. Il medesimo schema è riprodotto nel n. 356, che, a differenza del precedente, discoidale, ha una forma trapezoidale; anche in questo caso non si riesce a leggere l'oggetto tenuto dall'essere mostruoso, ma in entrambi gli *oscilla* compare, in basso a destra, un *kalathos* di fibre vegetali intrecciate<sup>250</sup>.

Degli esemplari semicircolari, il n. 357 riporta sui due lati la figura di un delfino che si tuffa in un mare stilizzato da onde correnti, un soggetto ben noto a Taranto perché appartiene all'iconografia del dio fluviale eponimo della città, *Taras*, e compare infatti sui suoi tipi monetali. Gli altri due *oscilla* con questa forma (nn. 358 e 359) presentano invece due busti affrontati, presumibilmente entrambi femminili, ammantati e con il volto sollevato verso l'alto, un altro schema singolare di difficile interpretazione<sup>251</sup>.

Pur essendo tipologicamente differenti, i pesi-*oscilla* della collezione udinese rivelano una certa omogeneità sia nelle caratteristiche tecniche, con argille prevalentemente di tonalità aranciate, *beige*-rosate più o meno scure<sup>252</sup>, sia per la scelta dei motivi figurati e lo stile, piuttosto corsivo e sommario. A parte il caso del n. 342, la statuetta con fori dietro al capo, che potrebbe essere un giocattolo per bambini e che trova un buon confronto nella tomba 118 di contrada Vaccarella, alcuni soggetti, come si è detto, potrebbero essere compatibili con una provenienza tarantina e anche con un ambito funerario<sup>253</sup>, ma non sembrano risultare presenze di pesi e *oscilla* nelle tombe della colonia laconica; più frequente, anche se in realtà abbastanza episodica, la segnalazione di *oscilla*, e anche pesi da telaio, nelle stipi votive, particolare in quelle rinvenute nell'area della necropoli<sup>254</sup>.

<sup>250</sup> Il medesimo soggetto su BESQUES 1986, tav. 87, D3826. Le Sirene hanno nel mondo greco valenze funerarie e sono collegate alle divinità ctonie; secondo una versione del mito, erano le compagne di giochi di Kore e, quando la giovane dea fu rapita da Hades per diventare Persefone, la regina dell'Oltretomba e la seguirono, così trasformate, nell'Ade; la metamorfosi da loro subita le rende un simbolo delle fasi di transizione della vita umana, in particolare di quella che conduce alla morte, ma anche del passaggio di *status* più importante nella vita di una donna, cioè il matrimonio, tanto più che la donna con corpo di uccello è associata anche ad Afrodite e compare su molti oggetti tipicamente femminili, come manici di specchi e cassetine per oggetti da toeletta: PRÜCKNER 1968, nota 373 a p. 146. In generale, sull'iconografia delle Sirene: HOFSTETTER 1997; sul significato della loro rappresentazione nei *pinakes* del *Persephoneion* di Locri Epizefirii: RUBINICH 1999, nota 6 a p. 186, con bibliografia, e RUBINICH c.s. (tipo 10/7).

<sup>251</sup> Sui tipi monetali tarantini: GARRAFFO 1995, pp. 148-151, in cui si sottolinea che la figura che cavalca il delfino è stata in passato identificata, ma probabilmente in modo non corretto, con l'eroe fondatore della città, *Phalanthos*. *Oscilla* con il medesimo soggetto del n. 357 (delfino verso sinistra o verso destra) in BESQUES 1986, tav. 87, D 3827-3828; il n. 358 trova confronto con BESQUES 1986, tav. 87, D 3824 (affine, ma di tipo diverso, il n. 359).

<sup>252</sup> Si distinguono il n. 349 e anche il 353, con argilla molto chiara. Anche le misure dei pesi discoidali sono abbastanza costanti, oscillando fra i 6,8 e i 7,9 cm. Dei quattro esemplari semicircolari, tre (nn. 356, 358 e 359) rientrano in questa fascia dimensionale, mentre il n. 357 è molto più piccolo e di forma non regolare.

<sup>253</sup> Si pensi alle sirene con testa di civetta dei nn. 355 e 356, o al busto femminile aprosopo del n. 351.

<sup>254</sup> Esempi citati in IACOBONE 1988, tabb. I.26, 36, e LIPPOLIS 1995, p. 111, D.3.g.14; p. 116, g.19.

342. Peso o *oscillum* configurato: vecchia dolente

Inv. n. 1702.

*Materia e tecnica*: argilla colore 7.5YR 7/6, più chiara e porosa in superficie, con inclusi litici e granuli di *chamotte* piccoli e piccolissimi; matrice stanca; retro plasmato a mano; ingobbio 2.5Y 8/2; tracce di colore rosso scuro sul mantello.

*Misure*: alt. 6,8; largh. 4,2.

*Stato di conservazione*: superficie abrasa; mento scheggiato.

*Descrizione*: figura femminile seduta e chinata in avanti, con il braccio destro piegato e appoggiato sulle ginocchia, e il sinistro portato in alto a sostenere il volto; avvolta in un mantello liscio (poche pieghe oblique fra le gambe), sollevato a velare il capo; restano scoperti i piedi, piccoli e informi, appoggiati su una basetta dai contorni indistinti, e, sulla fronte, una corona di capelli a fascia liscia percorsa da radi tratti paralleli verticali; grandi occhi



ovali non rilevati con iride rotonda e incavata; naso schiacciato e bocca illeggibile per difetto di impressione o alterazione accidentale; mano sinistra tozza con dita diritte e grassocce. Due fori passanti sul retro della testa.

*Cronologia*: seconda metà del IV - prima metà del III secolo a.C.

*Bibliografia*: inedito.

*Confronti*: GRAEPLER 1994, fig. 216 a p. 287.

343. **Peso** discoidale con bollo

Inv. n. 1754.

*Materia e tecnica*: argilla colore 5YR 7/3, con inclusi litici piccoli e piccolissimi; matrice del bollo fresca.

*Misure*: diam. 7,5; spess. 2,3.

*Stato di conservazione*: piccole scheggiature sparse sul bordo.

*Descrizione*: forma regolare; bollo al centro del lato principale: rosetta con otto petali entro cerchio sottile e rilevato. Due fori passanti.

Fig. 3. Example of misunderstanding about weights and *oscilla* (after Rubinich 2006).



*Cronologia:* IV-III secolo a.C.  
*Bibliografia:* inedito.  
*Confronti:* DOTTA 1989, tav. XL (il terzo da sinistra).

344. **Peso** discoidale con sigla impressa  
*Inv. n.* 1755.



*Materia e tecnica:* argilla colore 5YR 6/8, ben depurata; superficie rifinita a stecca; bollo realizzato con punzone.  
*Misure:* diam. 7,1; spess. 2.  
*Stato di conservazione:* bordi scheggiati.  
*Descrizione:* forma regolare, con numerose solcature lasciate dalla rifinitura a stecca; al centro del lato principale, bollo NI impresso prima della cottura; lettere grandi, regolari e profonde. Due fori passanti.  
*Cronologia:* IV-III secolo a.C.  
*Bibliografia:* inedito.  
*Confronti:* non individuati.

345. **Oscillum** discoidale a rilievo  
*Inv. n.* 1753.

*Materia e tecnica:* argilla colore 5YR 6/6-6/8, ben depurata; matrice mediocre; forse ingobbio bianco e tracce di colore rosso scuro sullo sfondo.  
*Misure:* diam. 7,2; spess. 2,3/2,8.  
*Stato di conservazione:* superficie consunta e incrostata.



*Descrizione:* forma regolare; sul lato principale: figura femminile di prospetto su cocchio tirato da due colombe verso sinistra (Afrodite?); forse ammantata e velata, si tiene con il braccio sinistro alla sponda del carro e protende il destro verso i due volatili; dettagli del volto e del pannello indistinti; mani informi. Cocchio di ridotte dimensioni con sponda bassa, ruota a quattro raggi con mozzo rilevato e spesso timone quasi rettilineo. Tozze colombe di profilo con una sola ala rappresentata, testa grossa e tondeggianti e coda trapezoidale. Due fori passanti.

*Cronologia:* IV-III secolo a.C.  
*Bibliografia:* inedito.  
*Confronti:* non individuati.

346. **Oscillum** discoidale a rilievo  
*Inv. n.* 1758.

*Materia e tecnica:* argilla colore 7.5YR 7/6, con inclusi litici piccoli e piccolissimi; matrice molto stanca.  
*Misure:* diam. 6,8; spess. 1,4.  
*Stato di conservazione:* superficie consunta e screpolata.

*Descrizione:* forma non perfettamente regolare; lato principale leggermente concavo con bordo rilevato per l'impressione della figurazione a rilievo: fanciullo inginocchiato, con busto in



torsione e testa inclinata verso destra, che sta trattenendo e sollevando con il braccio sinistro piegato un oggetto informe, forse un volatile o un cagnolino; gamba sinistra in primo piano, destra più piccola e parzialmente nascosta; braccio destro teso verso il basso; forme enfiate e prive di dettagli anatomici. Due fori passanti.

*Cronologia:* IV-III secolo a.C.

*Bibliografia:* inedito.

*Confronti:* BONGHI JOVINO 1972, p. 81, n. 184b.

347. **Oscillum** discoidale a rilievo  
*Inv. n.* 1759.

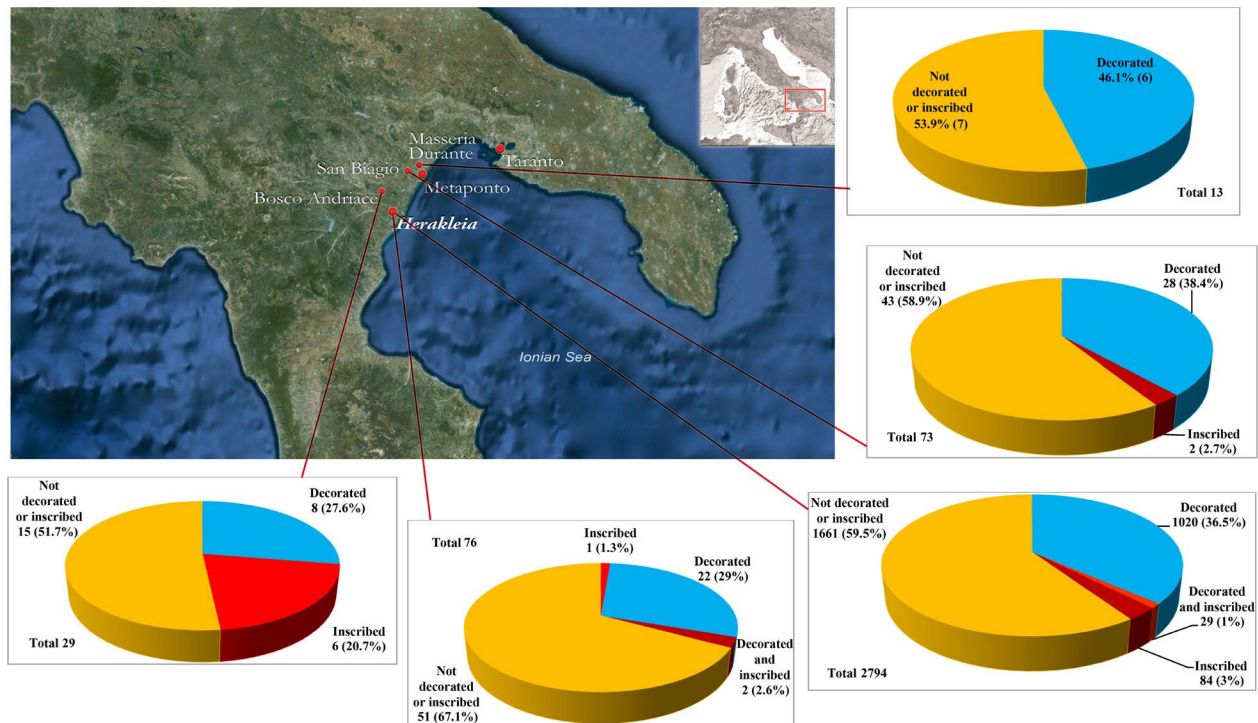
*Materia e tecnica:* argilla colore 2.5YR 6/6, ben depurata; matrice stanca; rarissime tracce di ingobbio bianco.

*Misure:* diam. 7; spess. 2,6.

*Stato di conservazione:* tracce di scottatura su un lato; superficie molto consunta; ingobbio abraso; scheggiature sparse.

*Descrizione:* forma non perfettamente regolare; sul lato principale: figura femminile con busto di prospetto cavalca 'all'amazzone' un cigno con ali spiegate rivolto verso sinistra; il personaggio (forse la dea Afrodite) ha il volto completamente liscio, le spalle leggermente sollevate, i seni evidenziati dal contorno curvilineo, le braccia aperte, le gambe di tre quarti, con piccoli piedi informi; con le mani si tiene alle ali del cigno; il volatile ha il corpo leggermente di tre quarti, con coda di scorcio e zampe prive di dettagli anatomici e come sospese nel vuoto; il muso è di profilo, con testa rotonda e grande becco appuntito; il collo lievemente ricurvo; le ali grandi e appuntite, quella di destra di profilo, quella di sinistra proiettata sul piano frontale. Due fori passanti praticati ai lati della testa femminile.





**Fig. 4.** Southern Italy. Archaeological data from a Greek town (Herakleia) and three settlements in Metaponto and Herakleia territories (author).

Therefore, I argue that the term *oscillum* should no longer be used to refer to circular and semicircular loom weights, since on the one hand it involves applying a Latin term to Greek material and above all because the main function of these discs does not correspond to what the word originally indicated.

## Bibliography

- Andersson Strand, E. B. (2010) The Basics of Textile Tools and Textile Terminologies: From fibre to fabric. In C. Michel & M.-L. Nosch (eds.), *Textile Terminologies in the Ancient Near East and Mediterranean from the Third to the First Millennia B.C.*, 10-22. Ancient Textiles Series 8. Oxford.
- Anelli, M. (2008) La ceramica d'uso comune. In P. Militello (ed.), *Scicli: archeologia e territorio*, 217-225. K.a.s.a. 6. Palermo.
- Bacchetta, A. (2006) *Oscilla. Rilievi sospesi di età romana*. Il Filarete 243. Milano.
- Barnabei, F. (1882) Notizie degli scavi. Ottobre. In *NSc* 1882, 381-404.
- Besques, S. (1986) *Catalogue raisonné de figurines et reliefs en terre-cuite grecs étrusques et romains. IV. Époques hellénistique et romaine. Italie méridionale – Sicile – Sardaigne*. Paris.
- Bonanno, C. (2008) Gli oscilla discoidali. In C. Bonanno (ed.), *Apollonia. Indagini archeologiche sul Monte di San Fratello - Messina 2003-2005*, 57-61. Roma.
- Caminnei, V. (1996) Pesì. In R. M. Bonacasa Carra (ed.), *Agrigento. La necropoli paleocristiana sub divo*, 82-84. Studi e materiali 10. Roma.
- Daremberg, C. & Saglio, E. (1877-1919) *Dictionnaire des Antiquités Grecques et Romaines*. Paris.
- Dotta, P. (1989) I pesi da telaio. In M. Barra Bagnasco (ed.), *Locri Epizefiri III. Cultura materiale e vita quotidiana*, 185-201. Firenze.
- Dwier, E. J. (1981) Pompeian Oscilla Collections. *MDAIR* 88.2, 247-306, taf. 80-130.
- Ferrandini Troisi, F. (1986) «Pesi da telaio». Segni e interpretazioni. In *Miscellanea greca e romana* 10, 91-114, tavv. I-XII.
- Foxhall, L. (2011) Loom weights. In J. C. Carter & A. Prieto (eds.), *The Chora of Metaponto 3. Archaeological Field Survey Bradano to Basento. I*, 539-554. Austin.

- Foxhall, L. (2012) Loom weights. In E. Lapadula, *The Chora of Metaponto 4. The Late Roman Farmhouse at San Biagio*, 99-101. Austin.
- Gardner, P. (1883) Clay Disks form Tarentum. *JHS* 4, 156-157.
- Giacobello, F. (2004) La coroplastica e gli *oscilla*. In G. Sena Chiesa (ed.), *La Collezione Lagioia. Una raccolta storica della Magna Grecia al Museo Archeologico di Milano*, 375-415. Milano.
- L'Erario, M. (2012) I cosiddetti *oscilla* e l'economia della lana di Taranto: nuove prospettive d'indagine. In M. S. Busana & P. Basso (eds.), *La lana nella Cisalpina Romana: economia e società. Studi in onore di Stefania Pesavento Mattioli. Atti del Convegno (Padova-Verona, 18-20 maggio 2011)*, 551-557. Antenore Quaderni 27. Padova.
- Lagona, S. (1954) *Oscilla* fittili nell'Antiquarium dell'Università di Catania. *ArchStorSicOr* 8, 89-95.
- Lenormant, F. (1881-82) Notes archéologiques sur Tarente. *Gazette Archéologique* 7, 148-190.
- Marinazzo, A. (2004) *Museo Archeologico Provinciale "F. Ribezzo" di Brindisi*. Bari.
- Marinazzo, A. (2009) *Museo Archeologico Provinciale Francesco Ribezzo*. Roma.
- Mårtensson, L., Andersson, E., Nosch, M.-L. & Batzer A. (2007) *Technical Report. Experimental Archaeology. Part 3, Loom weights*, in *Tools and Textiles-Texts and Contexts Research Program*. <http://ctr.hum.ku.dk/tools/exreports/>.
- Mårtensson, L., Nosch, M.-L. & Andersson Strand, E. (2009) Shape of things: understanding a loom weight. *OxfJA* 28, 4, 373-398.
- Meo, F. (2012) Attestazioni archeologiche di attività laniera a Eraclea di Lucania tra III e II secolo a.C. Nota preliminare. In M. Osanna & G. Zuchtriegel (eds.), *AMΦΙ ΣΙΠΙΟΣ ΠΟΑΣ. Nuove ricerche su Eraclea e la Siritide*, 259-271. Venosa.
- Meo, F. (2014a) New Archaeological Data for the Understanding of Weaving in Herakleia, Southern Basilicata, Italy. In M. Harlow & M.-L. Nosch (eds.), *Greek and Roman Textiles and Dress: An Interdisciplinary Anthology*, 236-259. Ancient Textiles Series 19. Oxford.
- Meo, F. (2014b) From archaeological finds to high quality textile fabrics: new data from Herakleia, Southern Basilicata, Italy. In S. Lipkin & K. Vajanto, (eds.), *Focus on Archaeological Textiles. Multidisciplinary Approaches*, 76-87. MASF 3. Helsinki.
- Meo, F. (2015) *L'attività tessile a Herakleia di Lucania tra III e I secolo a.C.* Fecit Te 7. Roma.
- Mingazzini, P. (1974) Sull'uso e sullo scopo dei pesi da telaio. *RendLinc* 29, s. VIII, 201-220.
- Manganaro, G. (2000) Onomastica greca su anelli, pesi da telaio e glandes in Sicilia. *ZPE* 133, 123-134, tavv. X-XII.
- Mansuelli, G.A. (1963) Oscillo. In *Enciclopedia dell'Arte Antica, Classica e Orientale*, V, 780-781. Roma.
- McDaniel, W. B. (1924) The Holiness of the Dischi Sacri. *AJA* 28, 24-46.
- Nicotra, M. (2007) Collezione archeologica della Pinacoteca Zelantea. In *Atti e rendiconti dell'Accademia di scienze, Lettere ed Arti dei Zelanti* 6, 194-262.
- Orlandini, P. (1953) Scopo e significato dei cosiddetti «pesi da telaio». *RendLinc* 8, s. VIII, 441-444.
- Orsi, P. (1906) *Gela. Scavi del 1900-1905*. MonAnt 17. Roma.
- Pace, B. (1945) *Arte e civiltà della Sicilia antica. Cultura e vita religiosa III*. Milano.
- Rizzo, G.E. (1897) Forme fittili Agrigentine. Contributo alla storia della coroplastica greca. In *RM* 12, 253-306.
- Rossoni, G. & Vecchio, P. (2000) Elementi per la definizione di attività domestiche nell'abitato di Mozia, "Zona A". In *Terze giornate internazionali di studi sull'area Elima (Gibellina - Erice - Contessa Entellina, 23-26 ottobre 1997) II*, 879-894, tavv. CLX-CLXV. Pisa - Gibellina.
- Rubinich, M. (2006) *Ceramica e coroplastica dalla Magna Grecia nella collezione De Brandis*. Trieste.
- Santoro, C. (1970) Iscrizioni greche su dischi fittili di Taranto. *Annali della Facoltà di Magistero di Bari* 9, 149-191.
- Spatafora, F. & De Simone R. (2007) *Makella. La montagna di Marineo. Guida breve*. Palermo.
- von Christ, W. (1900) Gewichte von Tarent. *SBMünchen* 1900, 106-118.
- Wuilleumier, P. (1932) Les disques de Tarente. *RA* 35, 26-64.
- Wuilleumier, P. (1939) *Tarente des origines à la conquête romaine*. Paris.



# Irritating Byssus – Etymological Problems, Material Facts, and the Impact of Mass Media<sup>1</sup>

Felicitas Maeder

**B**yssus and sea-silk made of the fibre beard of the *Pinna nobilis* – zoologically called byssus – have both become subjects of scholarly interest in the last decade. The subject is discussed not only in scientific books and journals, but also in mass media around the world. Although scientific research has clarified some old misunderstandings,<sup>2</sup> the double meaning of the term *byssus*<sup>3</sup> has created new doubts and scepticism in the scholarly debate, bearing the danger of new,

additional erroneous interpretations. This article recapitulates the present state of knowledge and calls attention to the consequences of assumed ‘old/new knowledge’ entering the scientific discussion.

The *Oxford English Dictionary*<sup>4</sup> shows the following etymological entry for the term *byssus*:

< Latin *byssus*, < Greek βύσσοϛ ‘a fine yellowish flax, and the linen made from it, but in later writers taken for cotton, also

1. I thank Marie-Louise Nosch and Cécile Michel for the invitation to the key lecture at the CTR congress *Textile Terminologies from the Orient to the Mediterranean and Europe 1000 BC – AD 1000* in Copenhagen (18th-22nd June 2014) and the possibility to intensify the scientific discussion on the topic of byssus and sea-silk. I thank Prof. Susanne Bickel, Ägyptologisches Seminar, Universität Basel, and Agneszka Wos-Jucker, a specialised textile conservator from the Abegg Stiftung Riggisberg, for introducing me to the fascinating world of Egyptian linen.
2. Notably McKinley 1998, and, from 1998 onward, the Sea-silk Project at the Natural History Museum Basel, Switzerland ([www.muschelseide.ch](http://www.muschelseide.ch) in English, German and Italian), both with extensive bibliography. For the term sea-silk see also Yates 1843; Bezon 1857; de Simone 1867; Karabacek 1882; Laufer 1915; Basso-Arnoux 1916; Mastrocinque 1928; Brühl 1938; Villani 1948; Zanetti 1964; Vial 1983; Sagot-Ortega 1992; Sroka 1995; Carta Mantiglia 1997; Maeder 2002, 2004, 2008, 2009, 2010, 2013, 2015, 2016 a, b, 2017; Maeder & Halbeisen 2001, 2002; Maeder et al. 2004; Campi 2004.
3. For the term byssus see: Braun 1680; Chambers 1753; Rosa 1786; Mongez 1818; Scot 1827; Gardner Wilkinson 1842; Yates 1843; Gilroy 1845; Long 1846; Smith 1854; Bock 1866 und 1895; Forbes 1956; Wipszycka 1965; Vial 1983; Sroka 1995; Quenouille 2006, 2012, 60-67; Kersken 2008.
4. OED, [www.oed.com](http://www.oed.com) (12.4.2014). See also: Smith *et al.* 1890. German: *Paulys Real-Encyclopädie der classischen Altertumswissenschaft*, term Byssos (vol. III, 1, Olck 1897); Italian: Treccani, *Enciclopedia Italiana di scienze, lettere ed arti*, term BISSO (vol. 7, L. M. C., G. Cal., G. Mon. 1930); French: *L'Encyclopédie, Texte établi par D'Alembert – Diderot*, term BYSSE ou BYSSUS (Tome 2, de Jaucourt 1751, 471-472).

silk, which was supposed to be a kind of cotton' (Liddell & Scott), < Hebrew būts, applied to 'the finest and most precious stuffs, as worn by kings, priests, and persons of high rank or honour' (Gesenius), translated in Bible of 1611 'fine linen', < root \*būts, Arabic bād to be white, to surpass in whiteness. Originally therefore a fibre or fabric distinguished for its whiteness.<sup>5</sup>

James Yates refers in his book *Textrinum Antiquorum* (1843) to Forster's *Liber singularis de bysso antiquorum* of 1776. In Yates' book vol. II about fibres of vegetal origin, in §70 titled Byssus, is discussed whether byssus is linen or cotton, especially in relation to Egyptian mummy bandages.<sup>6</sup> In the following I will examine the term *byssus* using the example of Egyptian mummy bandages based on antique written sources and material evidence.

### Written evidence of byssos in antiquity

In a German lexicon of hieroglyphs, we find a whole chapter on clothing. In the section about fabrics two pages show different hieroglyphs for linen (*Leinen* in German). Among them are hieroglyphs for *Königsleinen*, *Byssus* (king's linen, byssus).<sup>7</sup> The term is also found on the Rosetta stone from the 2nd century BC, a decree issued on behalf of King Ptolemy the Fifth. Here the Greek term *byssinon* is used in a legislative text treating the tax reduction on

βύσσοϛ. King's linen respectively Byssus are referred to as the finest quality of linen, fabricated – at least in Pharaonic times<sup>8</sup> – only in temple surroundings and exclusively reserved for the clothing of priests or statues of gods and for burial use.<sup>9</sup> We know that byssus workers even had special tools for the production process.<sup>10</sup> Hall considers the production of "the fine royal or byssos linen as the state monopoly of the king himself ... but a fixed quantity had to be delivered to the king for export."<sup>11</sup> The special status of byssus manufacturing is confirmed by an account for celebration and ritual occasions of the temple of Soknebtynis in Tebtunis of the 1st half of the 2nd century AD, written on papyrus: For the priestly expenses is mentioned the price of byssos for the robes of Sarapis, 316 drachmas, for the βύσσοϛουργοί, the manufacturer of king's linen two garments and x artabas<sup>12</sup> wheat, and 24 drachmas.<sup>13</sup> This is only one example of Quenouille's study with an in-depth analysis of the context of 27 references to the Greek term *bissos* (with the adjective *byssina*, *byssinon* and the noun *byssourgoi*) on papyri from different places in Egypt, dated 3rd century BC to 3rd century AD, referring to numerous quotations of ancient authors. Almost all these papyri are temple registers, payment lists and laws.<sup>14</sup>

### Material evidence of byssos in antiquity

Fortunately, many written sources about the mummification process have survived. And even more fortunately, many Egyptian tombs have survived

5. The 'whiteness' of antique byssos not only refers to the fibre, but stands also as a symbol for purity and innocence, especially in religious sense.

6. Yates 1843, 267-279. For an analysis and discussion of the term see Maeder 2015; 2016 a; 2017.

7. Hannig & Vomberg 2012, 478-479. Vigo 2010, 291-292 shows that the term was already used in Akkadian, and often found in the correspondence between the Egyptian and Hittite courts.

8. Quenouille 2005, 231.

9. Cooke & El-Gamal 1990, 69.

10. Quenouille 2005, 232. She cites many antique sources for the term byssos and discusses the possible material: linen, cotton, a mixed textile, or byssos as a statement of quality.

11. Hall 1986, 9.

12. An antique measure of capacity.

13. Quenouille 2012, 60-62: "Und für die priesterliche Kasse wenden wir die vorliegenden Beträge auf. ... als Preis für Byssos für die Gewänder des Sarapis 316 Drachmen, ...für die Byssurgen für 2 Gewänder und für den Unterhalt für sie x Artaben Weizen, als Lohn für sie 24 Drachmen, ...".

14. Quenouille 2005.



– some of them intact – and have been found in the last 200 years. Today, the analysis of the found mummy bandages or other textile fragments is standard procedure. This allows us to compare the written sources of textile designations with the material evidence.

For the procedure of mummification, enormous quantities of linen were necessary. To eliminate all moisture from the body, the textile had to be changed several times. So it may not surprise that 12 or more layers of linen bandages have been found on Egyptian mummies.<sup>15</sup> Yet, linen was not only used for wrapping the body, linen cloth also belonged to the principal offerings for the deceased. The higher the status, the larger in amount and finer in quality were the linen gifts. A good example of the importance of linen textiles is the mummy of Wah found in the 1930s in a four-thousand-year-old untouched tomb at Thebes. Today it belongs to the collection of the Metropolitan Museum of Art, New York. Wah was not a royal person, but an estate manager to the early Middle Kingdom vizier Meketra (around 2100 BC). The total of cloth found in his tomb has been estimated to 845 square metres.<sup>16</sup> 375 square metres of linen were used for the body only.<sup>17</sup>

Not only the masses of linen used for the dead are amazing, the quality is also quite stupendous. Cooke & El-Gamal told us about the “ability of ancient cultures to produce textiles woven from exceptionally fine staple yarns ... manufactured from linen... known as byssus or royal linen”.<sup>18</sup> Ancient hand spinners were capable of spinning linen yarns finer than 50 micrometres.<sup>19</sup> Byssus or King’s linen, the finest quality, was made of green flax, the early stage of the

plant’s maturity, when the fibres are still soft. “All the technical procedure [of flax processing] was developed in Egypt, where the finest quality of linen tabby, the *byssos*, constituted the luxury clothing – even of the Pharaoh himself.”<sup>20</sup> The tomb of Tutankhamun of the 18th dynasty (around 1300 BC) contained at least 400 items of cloth.<sup>21</sup> Some were made from a fine, almost silk like linen (112 warps and 32 wefts per square cm).<sup>22</sup> In classical literature we find for such gauze-like linen the Latin terms *linea nebula*, misty linen, or *ventus textilis*, woven wind, or woven air<sup>23</sup> – an expression often found in reference to byssus (we will later see the confusion this creates in reference to sea-silk). From another tomb of 18th dynasty Thebes, we know about a linen sheet of 515 cm x 161 cm, which weighs only 140 grams (46 warp x 30 weft per square cm).<sup>24</sup>

Another, more recent example: In 2012, Susanne Bickel and her team from the University of Basel’s King’s Valley Project<sup>25</sup> found an unknown tomb in the Valley of the Kings. It received the number KV 64. The coffin belongs to a young temple singer of God Amun, daughter of a priest of Karnak; her name, Nehemes-Bastet, is known from the coffin lid and a wooden stela found aside. The typology of the coffin and the stela as well as the lady’s name and title indicate a 22nd dynasty date (around 900 BC).<sup>26</sup> Underneath the thick layer of debris on which the burial was placed were found remains of another burial, dated 18th dynasty, like the tomb of Tutankhamun. There are hints that the original owner of this tomb was a princess of the reign of Amenhotep III. In the debris of this first, original burial many textile fragments were found. The examination revealed ten different

15. Veiga 2012, 3.

16. Vogelsang-Eastwood 2001, 295.

17. Winlock 1940, 256; Vogelsang-Eastwood 2001, 295.

18. Cooke & El-Gamal 1990, 69.

19. Cooke & El-Gamal 1990, 71.

20. Geijer 1971, 687.

21. Vogelsang-Eastwood 2001, 295.

22. Vogelsang-Eastwood 2001, 286.

23. Bock 1884, 515; 1895, 4, 8, 10; Heiden 1904, 105.

24. <http://www.metmuseum.org/collection/the-collection-online/search/545138>

25. <https://aegyptologie.unibas.ch/forschung/projekte/university-of-basel-kings-valley-project/report-2012/> (6.1.2015).

26. Bickel & Paulin-Grothe 2012, 36-40.

qualities of linen fabric, from coarse sackcloth to the finest quality.<sup>27</sup>

All mummy bandages analysed until today are made of linen of different qualities. Already the body of a prehistoric burial found in the cemeteries at Mostagedda (Upper Egypt) was wrapped in linen,<sup>28</sup> and even an animal mummy; but here “the fibre consisted of coarse material, which proves the low quality of the linen”.<sup>29</sup> A single mummy textile was once analysed as cotton – which proved to be wrong: The mummy in question (Philadelphia University Museum: PUM II) had been shipped to America in raw cotton – and the cotton fibres found on the mummy were remains of the travel packaging. The mummy bandages were instead all of linen.<sup>30</sup>

### The term *byssus* in the Bible

The Bible, especially the Old Testament, is another well-known source where the term *byssus* is found more than 40 times – depending on the language and the version. The most translated book of the world is also the best source to demonstrate the difficulties in reference to the term *byssus*. The Hebrew Bible knows six different terms for linen: *Būš*, *Šeš*, *Bād*, *Pištim*, *Eṭin* and *Kūtoneth*. Two of them – *Būš* and *Šeš* – were in the Latin vulgate<sup>31</sup> translated as *byssus*. In two other papers I analysed the translation of this Latin term into English, French, Italian and German in Bible versions of the 16th to the 21st century.<sup>32</sup> Table 1 shows the conclusion: a great variety of terms, which makes it difficult to find any congruence. Most common is linen or fine linen, but also cotton and silk occur – and *byssus*, without translation; only once, in German, *byssus* is annotated finest white cotton. The

greatest diversity of translations is found in German Bible editions. *Bād* has very seldom been translated as *byssus* in Latin; the Hebrew linen term *Pištim* – although never translated as *byssus* in Latin – is in some German Bible versions, paradoxically, translated as *Byssus*.

To sum up: In the Old Testament, different Hebrew linen terms were translated with the single term *byssus* in the Latin vulgate. *Byssus* was again translated differently – in different languages and at different times: beside linen and fine linen, (white) cotton, (white) silk occurs, and *byssus*, mostly without specification, and this in English, French and German. In Italian it is *bisso*. This may lead to the conclusion that many Bible translators had most probably no real notion about the material of *byssus*.<sup>33</sup>

Not much different was the notion of *byssus* outside religious discourse. In the lexicon of *Krünitz*, with 242 volumes the most substantial lexicon of the German language, published between 1773 and 1858, the term *byssus* appears 40 times.<sup>34</sup> We find 15 entries in textile contexts (beside the zoological term for the filaments of bivalves). Once *byssus* is another term for *batiste*, explained as finest linen:

*Batist, Battist, F. Battiste, L. Byssus, ist eine sehr feine, ganz dichte, und sehr weiße Leinwand, die von weißem, sehr schönen Flachse fabriciret wird; wie denn der Batist das allerfeinste Gewebe von Leinen ist....*

Then, as main entry that emphasizes the above mentioned ignorance:

*Byssus, Fr. Bysse, nannten die Alten eine gewisse kostbare Materie, woraus*

27. Franz Bock analysed in the 1880s several German textile relics and identified different qualities of linen; the finest one he called Alexandrian linen, less fine was the Syrian one, from Antiochia (Bock 1895).

28. Jones *et al.* 2014, <https://doi.org/10.1371/journal.pone.0103608>

29. Abdel-Maksoud & Abdel-Rahman 2013, 56.

30. Vogelsang-Eastwood 2001, 268.

31. The source of the Old Testament of Christian Bibles in most modern languages is generally the Septuagint, a pre-Christian Greek translation, and the Vulgate, a Latin translation going back to the 4th century AD, with several revisions up to the Late Middle Ages.

32. Maeder 2015 (German), and Maeder in print a (English), with lists of translations of all Hebrew linen terms in Bible versions from the 16th to the 21st century.

33. I did not refer to the annotations of the respective Bible versions – I only took the word itself.

34. <http://kruenitz1.uni-trier.de/> (15.1.2015). *Byssus* was in addition a name for different kinds of algae, sponges, and lichen.

**Table 1.** Hebrew linen terms translated in Latin, English, Italian, French and German in Bible versions from 16th to 21th century

Hebrew	<i>Būš</i>	<i>Šeš</i>	<i>Būd</i>	<i>Pištim</i>
Vulgate Latin	<i>byssus (serico)</i>	<i>Byssus</i>	<i>linea (byssus)</i>	<i>linea</i>
English	linen <b>byssus</b> silk	fine linen <b>byssus</b> silk	linen	linen
Italian	<b>bisso</b> lino fino lino bianco	<b>bisso</b> lino fino lino finissimo	lino <b>bisso</b>	lino
French	<b>byssus</b> lin fin	<b>byssus</b> fin lin fin coton	lin	lin
German	Leinen <b>Byssus</b> Leinwand Baumwolle	weisse Seide <b>Byssus</b> (= feinste weisse Baumwolle) köstliche Leinwand gele (gelbe) Seide	(weisse) Seide Leinwand <b>Byssus</b> weisse Baumwolle	Leinwand <b>Byssus</b> Baumwolle

*Zeuge zu allerley Kleidungsstücken für die Vornehmen und Reichen, insonderheit auch für die Damen und Priester, gewebt wurden. Imgl. die aus dem Byssus gewirkten Zeuge selbst.*

*Worinn aber die Materie des Byssus eigentlich bestanden habe, das scheint man seit vielen Jahrhunderten nicht mehr zu wissen. Einige nennen sie eine wahre Seide; Andre, eine Seide von der Pinne marine, oder von der Perlenuauster; Andre, den schönsten ägyptischen Flachs; Andre, eine sehr feine Baum=Wolle; noch Andre leiten sie aus dem Mineralreich her.*

Silk? Linen? Cotton? No wonder there was anything but agreement about the term *byssus*. At the end of this entry, we seem to hear the doubts about all this:

*Die wahrscheinlichste Meinung ist vielleicht die, welche der Chevalier de Jaucourt in der Encyclopédie äussert, daß Byssus ein generischer Name gewesen,*

*womit die Alten allerlei Arten kostbarer Materien zu feinen Kleidungsstücken, bezeichnet hätten.*

Which means: The most probable opinion is perhaps the one of Chevalier de Jaucourt expressed in the *Encyclopédie* that Byssus was a generic name, given by the ancients to all kinds of precious cloth made into fine garments. More than 200 years later, Nadine Quenouille comes to the same conclusion in a study of the term *byssus* in Roman Egypt: “...therefore I would like to propose to keep the Greek term ‘byssus’ without translating it.”<sup>35</sup>

#### 16th century: A second meaning of the term *byssus*

In the above mentioned lexicon entry we find for the first time an additional meaning for the term *byssus*: silk from the fan shell (*Pinna nobilis* L.).<sup>36</sup> In fact: consulting the *Merriam-Webster online*, we find a second – zoological – meaning of the term *byssus*:<sup>37</sup> “a tuft of long tough filaments by which some bivalve molluscs (as mussels) adhere to a surface”.

35. Quenouille 2005, 242.

36. The also mentioned pearl oyster (*Pinctada margaritifera*) is in fact mentioned several times in connection with byssus in older literature – the reason for this has not been studied yet.

37. <http://www.merriam-webster.com/dictionary/byssus> (22.1.2015).

Although in this second case the term *byssus* also derives from the Greek βύσσοϛ, it changed the meaning from a vegetal to an animal fibre.<sup>38</sup> So, not only have we got a second meaning of the term *byssus* for the filaments of the *Pinna*, but these filaments are the raw material for textile use, as explained in an illustrative statement of Beck's *Draper's Dictionary*:<sup>39</sup>

“These filaments have been spun, and made into small articles of apparel. Their colour is brilliant, and ranges from a beautiful golden yellow to a rich brown; they also are very durable. The fabric is so thin that a pair of stockings may be put in an ordinary-sized snuff-box.”

A beautiful, golden-brown, brilliant textile! And very thin – symptomatic for the stories around byssus fibres and its product, sea-silk, as it contains the standard assertion about the fineness and transparency of byssus (sea-silk) fabric. The topos of the sea-silk stockings in a snuffbox<sup>40</sup> – or a walnut shell, alternately – is wide spread. The same is said of “Limerick gloves so delicate that they fit into a walnut shell”.<sup>41</sup> Looking at the entire article to the term *byssus* in *Draper's Dictionary*, we find the second – crucial – mistake: “This manufacture [meaning sea-silk] was well known to the ancients, and is mentioned by Pliny and Aristotle.” However: neither Pliny<sup>42</sup> nor Aristotle<sup>43</sup> ever used the term byssus in connection with the fan shell.

In English dictionaries we find this inconsistency already earlier. While in dictionaries of 1756<sup>44</sup> and

1768<sup>45</sup> the term *byssus* or a derivation of it does not even occur, we find in an edition of 1828<sup>46</sup> at least the term *byssine*, with the only explication: made of silk. In lexica of antiquity we find mostly the long discussion, if byssus would be linen or cotton.<sup>47</sup> Other lexica – mostly specialised – make a clear distinction between byssus/linen and byssus/sea-silk.<sup>48</sup> Or the term sea-silk is explained without reference to the antique byssus.<sup>49</sup>

### The supposed role of Aristotle

Aristotle was by some called the father of sea-silk manufacture: “*Abbiamo anche la testimonianza di Aristotile il quale chiamò la conchiglia porta-seta, aggiungendo che il suo bisso ... poteva essere filato e tessuto.*”<sup>50</sup> None of this is true.

In the 4th century BC, the Greek philosopher Aristotle wrote a *Historia animalium*. He described the fan shell *Pinna*: “Αἱ δὲ πίνναι ὀρθαὶ φύονται ἐκ τοῦ βύσσοϛ ἐν τοῖς ἀμμώδεσι καὶ βορβορώδεσιν” (*HA* 547b15-16, ed. Balme 2002). In the 13th century, Willem van Moerbeke (approx. 1215-1286), a Flemish Dominican priest, wrote a Latin version of the book and translated the phrase: “*Pinnae rectae nascuntur ex fundo in arenosis...*” (“The *Pinna*-mussels grow upright out of the depth in sandy places...”). This is correct, as ‘ὁ βύσσος’ is masculine, with accent on the last syllable – it means depth. Aristotle was a good observer, he remarked the fibres anchoring the *Pinna* on the ground, and wrote in the same chapter, some

38. ... if we leave aside the very rarely found connection of ancient byssus with real silk.

39. Beck 1882, 39-40.

40. One only has to look at the pair of stockings in the sea-silk inventory to know that this is impossible: <http://www.muschelseide.ch/en/inventar/Objekte/Str-mpfe-Braunschw-.html> (13.1.2015).

41. Williams 2010, 122. Limerick gloves were made from the skins of unborn calves, and therefore very thin.

42. Plinius, *Naturalis Historiae* IX 142: “*Concharum generis et pina est. Nascitur in limosis, subrecta semper nec umquam sine comite, quem pinoterem vocant, alii pinophylacem. Is est squilla parva, aliubi cancer dapis adsector.*”

43. See the following chapter.

44. Bailey's *Universal Etymological English Dictionary* of 1756.

45. The third edition of *Johnson's Dictionary of the English language* of 1768.

46. *Johnson's Dictionary of the English language* of 1828.

47. E.g., *A Dictionary of Greek and Roman Antiquities*, 1890.

48. E.g., Harmuth 1915.

49. E.g., Yates 1843, 152-159: Fibres of the *Pinna*.

50. Basso-Arnoux 1916, 4; Carta Mantiglia 1997, 90.

phrases later about sedentary molluscs: “Of those that keep to one spot the pinnae are rooted to the ground”. So it is clear that he did not use the term *byssus* for the filaments of the Pinna.

200 years later, in the second half of the 15th century, Theodorus Gaza (approx. 1400-1475), a Byzantine humanist living in Italy, made another translation of Aristotle’s History of animals. He translated the same phrase: “*Pinnae erectae locis arenosis coenosisque ex bysso ...*”.<sup>51</sup> Theodorus Gaza misunderstood the term ‘ἐκ τοῦ βύσσοῦ’ and mistranslated ‘*ex bysso*’: “the Pinna-mussels grow upright from the bysso...” – ‘ἡ βύσσος’, feminine, with accent on the first syllable, meaning fine linen – as we know it now.<sup>52</sup>

In this way the term *byssus* for the filaments of the Pinna was born: a translation mistake with far-reaching consequences. From that moment on there are two kinds of bysso: “*Byssus terrenus est et marina*” – one of the land, of linen, and one of the sea, of the filaments of the fan shell *Pinna nobilis*, as stated by the French naturalist Guillaume Rondelet (1507-1566). From that moment on the filaments of all bivalves were given the zoological term *byssus*.

I cite only one of many authors to show the consequences of this misunderstanding:

*Il più antico scrittore che non solo conosce la pinna, le sue proprietà zoologiche e le sue abitudini di vita ... ma anche il preziosissimo filo, è tra i greci, Aristotele, il quale è anche l'unico (che si sappia), ad usare la denominazione di βύσσος, mentre negli altri antichi quell fibra è chiamata con altro nome.*<sup>53</sup>

The result of this is seen in the double entry in the *Oxford English Dictionary* for the term *byssus*:

- 1) An exceedingly fine and valuable textile fibre and fabric known to the ancients; apparently the word was used, or misused, of various substances, linen, cotton, and silk, but it denoted properly (as shown by recent microscopic examination of mummy-cloths, which according to Herodotus were made of βύσσος) a kind of flax, and hence is appropriately translated in the English Bible ‘fine linen’.
- 2) Zool. The tuft of fine silky filaments by which molluscs of the genus *Pinna* and various mussels attach themselves to the surface of rocks; it is secreted by the bysso-gland in the foot.

The conclusion is: In antiquity bysso was a fine textile of linen (or cotton, rarely silk). In the 16th century the filaments of bivalves like *Pinna*, blue mussel and others were given the name bysso, in analogy to the ancient bysso.

The fatal consequences for textile history are: From that moment on, textiles called bysso in antique texts were no longer associated only with linen (or cotton, rarely silk). Bysso became, in popular wisdom, for journalists and for some authors, sea-silk. With the simple logic: bysso is the name of the filaments of the *Pinna nobilis* of which was made sea-silk, bysso is found in the Bible and in profane antique literature, so bysso is, almost always and everywhere and at any time: sea-silk.

51. van der Feen 1949, 66-71; the faulty translation was contradicted very soon (see Beullens & Gotthelf 2007, 503), but unfortunately not in English: with the translation from D’Arcy Wentworth Thompson in 1910, the incorrect text persisted until the beginning of the 20th century: “The pinna grows straight up from its tuft of anchoring fibres in sandy and slimy places”. It is still online: [http://classics.mit.edu/Aristotle/history\\_anim.5.v.html](http://classics.mit.edu/Aristotle/history_anim.5.v.html) (25.1.2015) and has been repeated on and on. It even found its way in an actual book about marine biological materials: “Aristotle (transl. 1910) noted that the holdfast in the fan mussel (*Pinna*) consisted of a robust bundle of fibres with sticky tips. The term bysso (Greek “byso” for flax linen) was accidentally coined by him for the holdfast (van der Feen 1949) and has since gained universal acceptance.” The author interpreted van der Feen in a completely reverse sense (Ehrlich 2010, 301).

52. A more extensive discussion about this is found in Maeder 2015, 2016. For additional linguistic and translation problems see van der Feen 1949.

53. Zanetti 1964, 246. To find these other names for sea-silk in different languages and different times is one of the – future – aims of the Project sea-silk.

To be quite clear: “Nowhere in classic literature the Latin word ‘byssus’ or one of the two Greek words ‘βυσσός’ (masculine) or ‘βύσσος’ (feminine) is used in connection with any molluscs<sup>54</sup> – nor with the sea, or with a sea-creature. Laufer confirms this, speaking of the byssus of a mollusc: “In this sense ... the word was not used in the language of the ancients.”<sup>55</sup> In the last centuries, several Italian writers discussed the problem of the nature of byssus textiles in antiquity, and all reject the idea that it could have meant sea-silk.<sup>56</sup> Byssus, before the 16th century, had nothing to do with the filaments of a shell, and therefore nothing to do with sea-silk. Only from the 16th century onward a textile mistakenly called byssus may – perhaps – be sea-silk.<sup>57</sup>

### Sea-silk already existed in antiquity

However: sea-silk is a fact, it existed not only in modern times, but already in antiquity. The fibre is with 10-50 microns in diameter comparable with other natural fibres,<sup>58</sup> and it was spun and woven – later knitted – like any other high quality natural fibre. To what extent we do not know. Probably it was at any time only a very small production, but surely highly valued.<sup>59</sup> However: in antiquity, it was never called byssus! Alciphron called it first in Greek ἄ ἐκ τῆς θαλάσσης ἔργα, wool of the sea (Lettres 1.2.3). It was also paraphrased, as we know from different written statements, e.g., of the church father Tertullian in the 2nd century AD in his text ‘On the Mantle’: “*Nec fuit satis*

*tunicam pangere et serere, ni etiam piscari vestitum contigisset: nam et de mari vellera, quo mucosae lanusitatis plautiores conchae comant.*”<sup>60</sup> Yet, Tertullian knew about linen byssus! In his text ‘On the Apparel of Women’, he says: “*Vestite nos serico probitatis, byssino sanctitatis, purpura pudicitiae.*”<sup>61</sup> The bishop Basil the Great in the 4th century and the Byzantine historian Procopius in the 6th century were other witnesses for sea-silk.<sup>62</sup> The material evidence of the existence and use of sea-silk is a textile fragment dated 4th century AD, found in 1912 in a women’s grave in the Roman town Aquincum, today Budapest.<sup>63</sup> Unfortunately, the fragment and all documents about the excavation got lost in the 2nd world war.

The problem of the additional ambiguity of the term *byssus* started at the moment the filaments of the fan-shell were given the term byssus. The result can be seen in books from the 16th to the 20th century, where I found terms for sea-silk, in English, Italian, French, and German as reported in Table 2.

In all four languages, we find the term *byssus*, sometimes alone (bisso, bysse, Byssus), sometimes with an adjective (e.g., marine byssus). They are marked in bold face. And in all four languages we find fibre terms – wool or silk – associated with the origin of the sea or from a sea-creature, fish or shellfish. Interestingly, it is never associated with linen or cotton, the two materials associated with the byssus in antiquity.

That this variety of terms invites misinterpretations is obvious. Even scientific institutions cannot resolve the problem. In the 1970s, the *Centre International d’Etudes des Textiles Anciens* C.I.E.T.A. in

54. van der Feen 1949, 66. This is confirmed by my own research in classic literature.

55. Laufer 1915, 105.

56. Fabbroni 1782, Rosa 1786, Viviani 1836.

57. For sea-silk as a product of the Mediterranean fan shell *Pinna nobilis*, the manufacturing process and the textiles made of it see the catalogue of the first exhibition in 2004 in Basel: Maeder *et al.* 2004, and the homepage of the Sea-silk Project in English, German and Italian: [www.muschelseide.ch](http://www.muschelseide.ch).

58. ... such as mulberry silk or Egyptian linen 11-15 micron, Merino wool 18-25 micron, cotton 12-35 micron, mohair/alpaca 20-40 microns.

59. Maeder 2016 b.

60. “Nor was it enough to plant and sow your tunic, unless it had likewise fallen to your lot to fish for raiment. For the sea withal yields fleeces, inasmuch as the more brilliant shells of a mossy wooliness furnish a hairy stuff.” Tertullian, *De Pallio* III, 6, translation by Thelwall 1870, <http://www.tertullian.org/anf/anf04/anf04-03.htm> (11.1.2015).

61. “Clothe yourselves with the silk of uprightness, the fine linen of holiness, the purple of modesty.” Tertullian, *Cult. Fem.* II, 13: [http://www.tertullian.org/latin/de\\_cultu\\_feminarum\\_2.htm](http://www.tertullian.org/latin/de_cultu_feminarum_2.htm) (12.1.2015).

62. See Maeder 2015, 2017.

63. Hollendonner 1917; Nagy 1935; Maeder 2008.

**Table 2.** Synonyms and translations of sea-silk in English, Italian, French and German from the 16th to the 20th century

English	Italian	French	German
Sea-silk	<b>Bisso marino</b>	Soie marine	Muschelseide
<b>marine byssus</b>  <b>byssus silk</b> pinna silk marine silk  pinna wool marine wool sea wool fish wool  silkworm of the sea	<b>bisso</b>  seta di mare seta marina  lana marina lanapinna lana pena lanapesce lana di nacchera lana dorata  pelo d'astura pelo di nacchera  gnacara	soie de mer soie de pinne <b>soie de byssus</b>  laine de mer laine marine laine de pinne  <b>bysse</b> <b>byssus de pinne marine</b>  poil de nacre	<b>Byssus</b>  <b>Byssusseide</b> Seeseide Fischseide Steckmuschelseide Meeresseide Pinnamarina-Seide  Seewolle Fischwolle Meerwolle
C.I.E.T.A.: Pinna, sea-silk, sea-wool	C.I.E.T.A.: seta della conchiglia	C.I.E.T.A.: soie de coquillage	

Lyon published a textile vocabulary in different languages. The chosen terms *soie de coquillage* or *seta della conchiglia* are probably mere literal translations of the German term *Muschelseide*, known already in the 18th century.<sup>64</sup> In 1980, clarity was not greater when Irene Emery cited among animal fibres: “byssus (pinna, or sea-) silk, from the byssus or ‘beard’ by which certain marine molluscs (*Pinna nobilis* and related varieties) attach themselves to the rock or sand floor of the sea.”<sup>65</sup>

### Byssus and sea-silk in the Italian language – and in Italy

I have addressed the ambiguity of the term *byssus* in antiquity, and – with the additional meaning of sea-silk – even greater ambiguity in modern times. Sea-silk is an ancient Mediterranean phenomenon,

interesting from the cultural and textile history point of view. However, it is in Italy where we are confronted with additional linguistic problems. The correct and coherent term *bisso marino* appears already in 1681, in the first illustrated guide for sea-shells with the beautiful title *Ricreatione dell’occhio e della mente nell’osservation’ delle chioccioline*.<sup>66</sup> The author, Filippo Buonanni (1638-1725), presents the fan shell with its filaments: “... *bisso marino a distintione del terrestre, fatto di lino, ò bambagia*”. *Bisso marino*, the byssus of the sea, which he clearly opposes to the so-called *Bisso terrestre*, the ‘rural’ byssus, which consisted of linen, or cotton.

100 years later, in 1798, an Italian-French dictionary mentions *bisso* only as a precious textile in the Bible, of unknown material.<sup>67</sup> Only 20 years later, in 1819,<sup>68</sup> *bisso* becomes the common name for sea-silk, as again in the merchant’s polyglot manual of

64. The term *Muschelseide* is first mentioned in Rudolph 1766.

65. Emery 1980, 4.

66. Buonanni 1681: Recreation for the eye and mind in the study of shells. Three years later, in 1684, the book is released in Latin.

67. Bettinelli 1798, term *bisso*.

68. Bonavilla 1819-1821.

1860: *Bisso* followed by another term, *Lanapesce* - fishwool.<sup>69</sup> In a vocabulary of the written and spoken Italian language of 1895,<sup>70</sup> a clear distinction is made between the antique byssus and sea-silk:

*Bisso. s.m. V. G. Tela finissima, molle, delicata, che usavano gli antichi.  
Il Bisso marino chiamano i naturalisti quello che volgarmente dicesi Pelo di nacchera....*

And again ten years later, in 1905,<sup>71</sup> *bisso* is correctly presented as the filaments of bivalves, although open for misinterpretation regarding antique byssus:

*Bisso. È un prodotto di secrezione di una ghiandola che si trova nel piede di molti molluschi bivalvi, come la pinna, il mitilo ecc., e che fu detta appunto ghiandola del bisso. Questa secrezione appena emessa, si solidifica in fili assai resistenti, che servono a fissare il mollusco agli scogli. Talora il bisso di certi molluschi, come quello della Pinna nobilis, è bello ed elegante, di riflessi bronzati e simile a seta. Ora non è più in uso, ma anticamente era assai pregiato e serviva a fare tessuti preziosi. E. G.-T.*

As a second meaning, in the same dictionary, follows *bisso* as a ‘technical’ term: finest, most precious textile used by the ancients, possibly linen:

*Bisso. (tecn.) Tela o panno finissimo, preziosissimo, molle, delicato, che usavano gli antichi. Si crede che fosse un tessuto*

*di lino sottilissimo delle Indie e dell’Egitto, di cui erano fatte le vesti più nobili e più stimate. Siccome poi tali vesti erano spesso colorite di porpora, il colore fra tutti il più pregiato, quindi è che da taluni fu detto bisso lo stesso color di porpora. F. MZZL.*

In the Bible, the two terms *bisso* e *porpora* (byssus and purple) are often found together. It is discussed whether in this sense byssus meant a linen textile dyed with purple, or the colour purple itself.<sup>72</sup> In 1928, Beniamino Mastrocinque uses these two terms as title for his publication: *Bisso e Porpora – per la rinascita delle due grandi industrie. Bisso* (sea-silk), and *porpora*, the colour – according to him – with which sea-silk was dyed. He writes about the two manufactures of his hometown Taranto, capital of *Magna Grecia*,<sup>73</sup> hoping for a revival of both.<sup>74</sup>

Some years earlier, the same efforts had been made in Sardinia. In 1916, Giuseppe Basso-Arnoux published the study *Sulla pesca ed utilizzazione della ‘Pinna Nobilis’ e del relativo bisso*. We find the same mixture of terms concerning byssus: “*Questo fiocco viene chiamate Butz dagli ebrei, Bussos dai greci, Bissus dai francesi ed inglesi; Arbi dagli Arabi; da noi italiani lana-pinna, lana dorata, gnacara; venne anche chiamato ‘seta di mare’.*”<sup>75</sup> It is interesting how Basso-Arnoux explains the differences in the meaning of the term *byssus*: “*Non si deve confondere il bisso della Pinna nobilis, colle filamenta vegetali, pur desse sottilissime, che servivano per tessere delle tele di lino più fine della battista e che solo per analogia di esilità si denominavano bissus...*”<sup>76</sup> – first there was

69. The merchant’s polyglot manual 1860. 100 years later, in 1958, D’Alessio would speak in an article “Il bisso tarantino: leggende e inesattezze” of *lanapesce*, fish-wool, o *lanapenna*, Pinna wool.

70. Fanfani 1895, 129.

71. Lessona 1905, 483.

72. Or is it just an expression of extreme luxury: royal linen (=byssus) and royal purple, together the most famous materials for dressing in antiquity? For the term byssus as colour, see Brunello 1968, 58.

73. Whether sea-silk was already manufactured in antiquity in Taranto is contested. Purple manufacture in antiquity is proved by shell finds.

74. Mastrocinque shows examples made by him of linen dyed with purple; he also mentions wool dyed with purple (tav. VII) and p. 54). There is no material reference of purple dyed sea-silk. Recent experiments show that sea-silk cannot be dyed with purple; see Maeder (2017).

75. Basso-Arnoux 1916, 2.

76. Basso-Arnoux 1916, 4.



the term byssus for the filaments of the molluscs, and in analogy to them the term was given to the fine linen of antiquity – just the opposite of how it really was! While Basso-Arnoux designates the processed byssus always as *bisso marino*, Mastrocinque never uses this term; he speaks of *bisso*, *lanapinna* or *lanapesce*.

The *Enciclopedia italiana di science, lettere ed arti di Treccani* belongs to the greatest encyclopaedias.<sup>77</sup> In the *Treccani* of 1930<sup>78</sup> we find a complete, extensive and comprehensive statement, including the known discussion of linen or cotton, with corresponding authors:<sup>79</sup>

**BISSO** (*dal gr. βυσσός, e questo dal fenicio būš; fr. bysse, sp. biso; ted. Byssus; ingl. byssus*). - Fu così chiamata dai Greci una tela sottilissima e preziosa fatta col lino, proveniente dall'India e dall'Egitto e diffusa nel mondo mediterraneo dai Fenici. In Egitto le manifatture appartenevano ai templi che sotto i Tolomei avevano il monopolio delle tele per le mummie (G. Lombroso, *Recherches sur l'econ. polit. de l'Égypte sous les Lagides*, Torino 1870, p. 108 segg.). Per il suo pregio era adoperata da principi e sacerdoti, anche della religione ebraica. Da alcuni si ritiene che si ricavasse dal *linum asbestinum*, altri poi dicono non essere altro che il moderno cotone. Dall'uso ebraico volle la Chiesa che gli abiti dei sacerdoti fossero di lino.

Nell'ambiente romano, il byssus si trova per la prima volta ricordato in Plinio. A Roma, oltre che dall'Egitto, il bisso era fornito dalla città di Scythopolis presso Damasco, dalla Siria, e da Tarso in Cilicia, come sappiamo dall'editto di Diocleziano in cui ci sono date le qualità migliori. L'Italia ne produceva poco.

L'uso di tela fine sia per indumenti, sia per fazzoletti, tovaglioli, asciugamani, si diffuse negli ultimi tempi della repubblica:

*la donna fu la prima ad abbandonare la veste di lana per quella di tela; e il più antico costume di lino fu il supparum. Alessandro Severo fu un grande amatore delle tele di lino e gl'imperatori in genere facevano tessere il lino per proprio conto.*<sup>80</sup>

Also the statement about the zoological term *byssus* is correct, explaining that it was given to the filaments of bivalves in analogy to the byssus of the ancients.

Zoologia. - Nel piede di molti Molluschi Lamellibranchi si trova una ghiandola, che secerne una sostanza semifluida, la quale, a contatto con l'acqua, si solidifica, formando una sorta di peduncolo, o, più spesso, un fascio di filamenti, che servono a fissare l'animale a un sostegno. Per lo più questo fascio di filamenti a cui, per analogia col nome del tessuto sopra ricordato, fu dato il nome di bisso, è di natura cornea, alquanto elastico, e in alcuni casi (*Anomia*) è impregnato di sali calcarei. La ghiandola del bisso non sbocca direttamente all'esterno, ma immette in una cavità del piede, che comunica con l'esterno per mezzo di una piccola apertura. Non tutti i Lamellibranchi sono provvisti del bisso; lo posseggono ad es. i generi *Pecten*, *Tridacna*, *Avicula*, *Mytilus*, *Meleagrina*, *Pinna*; nei generi *Cyclas*, *Unio*, *Anodonta* ed altri esiste in un periodo della vita, ma scompare allo stato adulto.

The entry ends with the use of these filaments as textile fibre, but there is no special term given to this textile:

*Il bisso della Pinna è così abbondante e fine, che può essere tessuto in una stoffa morbidissima, sericea, d'un colore bruno dorato, con riflessi verdastri. Un tempo gli abitanti delle coste siciliane, calabresi,*

77. ... together with the Encyclopaedia Britannica and the Spanish [Enciclopedia universal ilustrada europeo-americana](#).

78. Treccani 1930.

79. Byssus with the meaning asbestos is mentioned also in Rondelet 1558, 38-39; see also Maeder (2016 b).

80. Today the Italian term *bisso* means first a fine linen or cotton used for embroideries.

*tarentine e di Malta, ne facevano guanti, cravatte e altri oggetti di abbigliamento. Tale industria fioriva ancora nel sec. XVIII, ma la materia prima era troppo scarsa perché essa potesse acquistare notevole importanza (v. lamellibranchi). L. M. C., G. Cal., G. Mon.*<sup>81</sup>

Today's *Treccani* Internet entry is a summary of the above-mentioned – still with no special term for sea-silk.<sup>82</sup>

In 1780, Giuseppe Capecelatro (1744-1836), Archbishop of Taranto, dedicated his study "*Spiegazione delle conchiglie che si trovano nel piccolo mare di Taranto*" to the Russian Empress Catherine II and sent it with several sea-silk gloves to the court of St. Petersburg. Luigi Sada has the great merit to have reprinted the text in 1983. Capecelatro uncovers some continually repeated legends of sea-silk in antique Taras (Taranto): "*Le vesti di lanapenna non sono trasparenti... Le Tarantinidie così dette dall'uso, che facevasene in Taranto, dovevano essere di sottilissimo bisso [in lino, not in sea-silk], perchè così si accorda, e che erano diafane, e che convenivano all'uso, ed al poco pudore insieme delle antiche Ballerine.*"<sup>83</sup> However, in an appendix, Sada contradicts Capecelatro's statement: "*Inventori e maestri dell'arte dell'apparecchiatura e tessitura del bisso [filaments of *Pinna nobilis*, ergo byssus] ... nella città bimare [Taranto] si confezionavano le celebri vesti tarantinidie, diafane, morbide, leggere, di colore aureo, ricercate e indossate da matrone, famose etère, danzatrici e baccanti*".<sup>84</sup> Once more, the famous fineness and transparency of antique

linen byssus is transferred to sea-silk byssus. Capecelatro, a great promoter of sea-silk manufacturing and knowing very well the whole manufacturing process, never spoke of *bisso* – meaning sea-silk – but of *lanapenna*, Pinna wool.<sup>85</sup>

In 1994, the Italian textile journal *Jacquard* published an article titled "*Il Bisso*". Byssus of the *Pinna nobilis* would be the byssus of antiquity, known in Egypt, Greece and Rome, and in the Bible. The contradiction with the term would be old, "*poiché la stessa denominazione era impropriamente attribuita a tessuti di cotone o di lino, mentre solo il filato derivato dalla *Pinna nobilis* può definirsi 'bisso'*"<sup>86</sup> – because the term *bisso* was misleadingly attributed to textiles of cotton or linen while the only true *bisso* comes from the *pinna nobilis*, as the article concludes, this corroborating the age-old misunderstanding.

How persistently some opinions survive is also seen in the estimable book *La seta del mare - il bisso. Storia, cultura, prospettive* – the first illustrated monograph about the sea-silk production in Taranto: "*L'uso millenario della parola bisso per indicare la seta marina ricavata dal mollusco bivalve denominato *pinna nobilis*, ha lasciato esili tracce anche in alcuni testi della Bibbia.*"<sup>87</sup> Thousands of years the term *bisso* would have meant sea-silk, having left also traces in the Bible...

In scientific texts published in Sardinia, more importance is attached to clearness in the matter. While Paolo Piquereddu, former director of the *Museo etnografico Sardo*, speaks of *lana marina*,<sup>88</sup> Gerolama Carta Mantiglia, folklorist at the University of Sassari,

81. Authors: Leone Mattei Cerasoli, Guido Calza, and Giuseppe Montalenti.

82. <http://www.treccani.it/enciclopedia/ricerca/bisso/> (20.1.2015).

83. Capecelatro, in Sada 1983, 29-62 and 42. However, Capecelatro adds in a footnote that we do not know yet what was meant with the byssus of the ancients: some have had the opinion that it was sea-silk ("*che il bisso sia codesta lana Pinna*"). The Online Lidell-Scott-Jones Greek-English Lexicon confirms this. Yet, we still do not know for sure of what material the *tarantinidie* were, the diaphane light dresses for dancers in antique Taras: of the finest Apulian wool, or of the also famous finest cotton? See also D'Ippolito 2004, 73-113.

84. Sada 1983, 66.

85. For the eminent role of Capecelatro in the history of sea-silk see <http://www.muschelseide.ch/en/geschichte/neuzeit/giuseppe-capecelatro.html>

86. Bardini Barbafiga 1994, 10.

87. Campi 2004, 201-205. Unfortunately the nicely illustrated book contains also many traditional myths and legends concerning the term *bisso*.

88. Piquereddu 2009, 22.

makes often a distinction between the raw material *bisso* and the textile *bisso marino*.<sup>89</sup>

Why did I present the ambiguity of the term *bissus* so extensively in the Italian language? Italy is of particular importance for sea-silk in two respects. Not only is it still the only country with a documented sea-silk production, at least since medieval times.<sup>90</sup> Sant'Antioco, a small island southwest of Sardinia, is – together with Taranto in Apulia – the only place where the manufacturing of sea-silk was known until the 1950s. We have an interesting statement by Vittorio Alinari, a famous Florentine photographer who was travelling – and photographing – in Sardinia at the beginning of the 20th century and made the following remarks about the textile production in Sant'Antioco:

*Ma la lavorazione più curiosa è quella che si fa della Pinna Nobilis, che viene pescata in grande abbondanza nel golfo e la cui appendice terminale (bisso), formata da filamenti setacei, viene, in prima, ripulita dalle concrezioni calcaree che vi stanno aderenti, quindi filata e tessuta. Ne deriva una stoffa di un bel colore metallico, che si avvicina al rame, con la quale si confezionano delle sottovesti che, guarnite di bottoni in filigrana d'oro, pure lavorati nel paese e nel cagliaritano, producono bellissimo effetto. Per ogni sottoveste occorrono almeno novecento code la cui filatura costa, all'incirca, una lira al cento. Questo non può ritenersi un prezzo esagerato perché non può filarsene che un centinaio al giorno essendo il filo delicatissimo e facile a strapparsi.*<sup>91</sup>

Sant'Antioco is also the only place where the sea-silk processing still is alive, if only on a small scale and just for demonstration purposes.<sup>92</sup> Women of Sant'Antioco who had learned sea-silk processing in the weaving studio of Italo Diana in the 1930s passed on their knowledge to many locals of the younger generation. The last sea-silk weaver that once learnt from Italo Diana – Efisia Murrone – died in 2013 at the age of one hundred years. So it is not surprising that several sea-silk weavers still live in Sant'Antioco. The Sardinian journalist Claudio Moica has recently reanimated the local history of sea-silk production in the 20th century in several articles in the local *Gazzetta del Sulcis*. They are available online.<sup>93</sup> And the English marine biologist Helen Scales takes also a critical look at the present situation in Sant'Antioco in chapter VI of her book *Spirals in Time - The Secret Life and Curious Afterlife of Seashells*.

#### **Invented tradition and the role of mass media**

Beside this well-founded local history, Sardinia seems to have a rich history of mystification around sea-silk and its processing: "... è strano che si parli di segreto e di conservazione ereditaria del metodo del quale si servono gli antichi per fissarne la doratura" – this is a statement of Giuseppe Basso-Arnoux in 1916.<sup>94</sup> Apparently this tendency has survived and keeps evolving since the 1990s, especially in Sant'Antioco. Against better knowledge, the term *bisso* is used by some without any distinction in the sense of sea-silk, which leads to assertions like: the Bible is full of sea-silk, all mummies are wrapped in sea-silk, and more and more textile relics around the world are – of course – from sea-silk. Even perfectly researched

89. Carta Mantiglia 1997; 2006. Unfortunately some of the stories about Aristotle and transparency persist.

90. Other possible but not yet confirmed countries are Croatia, Spain, and, may be, Malta and Tunisia.

91. Alinari 1915, 114. This shows clearly that sea-silk products were made for the market – at least at that time – and sold.

92. The fan shell *Pinna nobilis* is protected since 1992: European Council [Habitats Directive](#) 92/43/EEC, on conservation of natural habitats and the wild fauna and flora. Annex IV, Animal and Plant Species of Community Interest in Need of Strict Protection. No part of the shell may be harmed.

93. <http://www.gazzettadelsulcis.it/archivi.asp>: no 682, 10.7.2014, p. 6: *Si scoprono nuovi maestri della tessitura: il bisso a Sant'Antioco*; no 685, 31.7.2014, p. 7: *La difficile ricostruzione della vita di Italo Diana, il misterioso maestro del bisso di Sant'Antioco*; no 688, 4.9.2014, p. 6: *Felicitas Maeder e la ricerca della verità intorno alla storia del bisso*; no 690, 18.9.2014, p. 7: *Gli insegnamenti del maestro Italo Diana ad Efisia Murrone, l'ultima allieva del bisso*; no 692, 9.10.2014, p. 9: *Italo Diana ricordato dai figli di Jolanda Sizia: L'allieva e la rievocazione del maestro*; no 694, 23.10.2014, p. 9: *Le sorelle Pes maestre di tessitura e di bisso: La passione di Assuntina e Giuseppina*.

94. Basso-Arnoux 1916, 3.

textile techniques like *l'or de Chypre* is brought in connection with sea-silk.<sup>95</sup> So-called 'secret oral traditions' around sea-silk manufacturing flourish and encounter numerous fascinated admirers, if not local, then outside of the island, and around the world. Mass and social media play an important, albeit questionable, role in the spread of this so-called 'cultural heritage'. Countless interviews, radio broadcasts, documentary films and self-promoting books diffuse a made-up story of sea-silk, which has – except the real process of washing, combing, spinning and weaving – very little to do with the historical record.

One endlessly re-echoed assertion has a particularly dangerous effect: the assumed transparency of sea-silk. In Manoppello, a little town in the Abruzzi (Italy), exists a very fine, translucent veil in the Capuchin church, the so-called *Volto Santo*, venerated as the face of Christ. In 2004 it was 'identified' as *bisso* – only at sight.<sup>96</sup> This *bisso* has been – without any questions or doubts – translated by journalists and authors as sea-silk, and thus found its way in several books, papers, videos, and films.<sup>97</sup> Manoppello is today a growing pilgrimage destination and has an enormous repercussion in the Catholic world.<sup>98</sup> This fact determines more and more how sea-silk 'looks' – even if none of the inventoried sea-silk objects have the slightest resemblance with a translucent, veil-like textile. Another veil, shown in Assisi and venerated as the veil of Madonna, has newly been 'identified' as sea-silk in the Vatican Magazin.<sup>99</sup> This textile has

been examined in 1980<sup>th</sup> and analysed as mulberry silk.<sup>100</sup> In the meantime, also two textile relics in German minsters are marked sea-silk: in Kornelimünster the sudarium of Jesus "*aus feinsten äußerster zarter alexandrinischer Muschelseide (Byssus)*"<sup>101</sup> and in Aachen Mary's robe, made of linen and "*aus kostbarem orientalischem Byssus, auch Muschelseide genannt.*"<sup>102</sup> Both textile relics have been analysed by Franz Bock in the 1880s and were clearly identified as fine linen.<sup>103</sup>

Eric Hobsbawm and Terence Ranger published in 1983 the widely discussed book "The Invention of Tradition". The chapter of the invention of Scottish Highland traditions is especially interesting, as it contains an example from the textile world: the kilt as embodiment of a traditional Scottish costume – in fact quite modern, invented in the 18th century.<sup>104</sup> What we presently observe regarding sea-silk is a similar development: the worldwide spread of half-knowledge about a so-called 'ancient sea-silk tradition', a mixture of 'old wisdom' and sacral vows, which is, in fact, in great parts an invented one.<sup>105</sup> No problem that this forged ancient sea-silk tradition is mentioned in every Sardinian traveller guide. But what we must consider is the fact that the enormous publicity worldwide enters slowly – like a reverted trickle-down effect – into the heads of those who are seriously interested in textiles. At least, several publications of the last decade mentioning byssus and/or sea-silk suggest this, even if the source is not mentioned, or not even perceived.

95. "Qu'est donc cet or de Chypre, qui n'a visiblement rien de métallique? C'est un produit des fonds marins, le byssus de la grande nacre (*Pinna nobilis*), c'est la Soie de Mer. Le Maestro di Bisso Chiara Vigo le confirme, et précise que le terme 'or de Chypre' désigne une façon particulière du travail de la Soie de Mer, donnant un fil grège (non teinté) réservé à la décoration des vêtements sacerdotaux." <http://www.sardolog.com/bisso/france/loanec.htm> (28.1.2015). About gold threads in textile see: Bock 1884, 4-5; de Reyer et al. 1997; Gleba 2008; Karatzani 2012; Jacoby 2014; and [http://www.annatextiles.ch/vo\\_sti/dictiona/metmat.htm](http://www.annatextiles.ch/vo_sti/dictiona/metmat.htm) (7.8.2015).

96. <http://manoppello.eu/eng/>

97. E.g., Badde 2005, 2010a & b, 2011, 2014; Schrader 2007; Gaeta 2010; van den Hövel 2013.

98. <http://manoppello.eu/eng/index.php?go=bisior> (3.2.2015).

99. Badde 2010c.

100. Flury-Lemberg 1988, 318 and 492. More detail in Maeder 2016, 829.

101. <http://katholisch-informiert.ch/2014/06/aachener-reliquien-historisch-authentisch/> (3.2.2015).

102. Domkapitel Aachen: Pilgern in Aachen 2014. In the English edition of this leaflet only 'byssus' is mentioned – a good example of the translation problems.

103. Bock 1895, 8-14.

104. Trevor-Roper 1983: The invention of tradition: the Highland tradition of Scotland. In Hobsbawm and Ranger 1983, 15-42.

105. The old homepage [www.chiaravigo.com](http://www.chiaravigo.com). Chiara Vigo – not the sea-silk manufacturing! – would be presented for Italian candidate as UNESCO Intangible Cultural Heritage.

**2007: Example one**

In the *Collection de l'École Française de Rome*, an impressive volume of 752 pages: *La culture matérielle médiévale – l'Italie méridionale byzantine et normande*. In chapter IV, *Métiers et activités et la draperie*, are presented on the same level: animal fibres, vegetal fibres, silk, furs – and byssus.<sup>106</sup> Entering the topic, we read that antique authors took byssus as a linen *de couleur gris-cendre* (of ash-greyish colour<sup>107</sup>). Latin and Greek dictionaries would take *byssus* and *byssos* as a vegetal fibre, cotton or linen. But this is wrong, we read: “*En réalité, le byssus est un tissu diaphane, créé en utilisant une fibre provenant d'un mollusque acéphale à coquille bivalve.*” (In reality, byssus is a sheer fabric using the fibre of a bivalve mollusc.)

**2008: Example two**

In the third edition of a German practical lexicon for textile studies we find for the term *Byssus* the known reprises of transparent cloth for mummies and relics:

*Ein feinfädiger Netzhemdenstoff aus Dreherbindung; ferner feinfädige, zarte, ungemusterte oder mit eingewebten Mustern versehene Gewebe aus Seide, Muschel-seide oder Flachs. Diese Gewebe (Byssos) wurden schon zur Pharaonenzeit zum Einhüllen der Mumien und Reliquien benutzt. ... Seit dem Altertum wurde dieses Sekret 'geerntet' und zu durchsichtigem, naturfarbigem Gewebe verarbeitet (gewirkt).*<sup>108</sup>

**2010: Example three**

Outside textile discussions, we find a scary example of an uncritical copy-paste text in a recent Springer

book about marine biology materials. In chapter 18 titled “Byssus – An Ancient Marine Biological Material”, the same old mythical stories are assembled. We read about the ‘Cloth of gold’ and Jason’s ‘Golden Fleece’ and the tunic found by Herodotus “made of a loose fabric of exceedingly fine thread ... finer than a hair”, and of course, the “fine, diaphanous fabrics ... commonly used in making the apparel of the queen and the princesses and the wives and daughters of rich men and high officials.” Even the legend of ‘the byssus gloves folded and packed inside a walnut shell’ is included. The author ends the chapter with the following words: “Because of the very simple (and today unique) technique of the spinning of the byssus threads, I take the liberty to represent here several images which, in my opinion, will astonish our material research community.” Shown is a whole page with photographs of the sea-silk production with our ‘last and only *maestro di bisso*’.<sup>109</sup>

**2010: Example four**

In a linguistic study of Neo-Assyrian textiles and their colours, we read about the byssus of molluscs for luxury clothes: “*Le byssus, tissu très fin et de grande valeur, réalisé à partir de filaments produits par des mollusques, était réservé à quelques vêtements de luxe.*”<sup>110</sup> This cannot be taken amiss, as the reference to this statement is a paper of 1991 in which, about the Akkadian term *būṣu*, ‘Hebrew *būṣ*, Phoenician *bṣ*’, is said: “Knowledge of true byssus appears to have fallen out of the focus of modern scholars of history; most recent works on ancient textiles only mention it in passing as a fine linen, although conchologists are still aware of its existence”... Byssus would be “an ultra-fine fabric woven from the tuft of fine silky filaments ... of the genus *Pinna*...”<sup>111</sup> Unfortunately, Dalley here referred to several pieces of misinformation debunked since. Her bold conclusion is: “From Late

106. Ditchfield 2007, 425-427.

107. Did he take this idea by Harmuth 1915, where one concept of *Buz* is a “plain woven gray cotton fabric made in Central Asia”?

108. Wadisch 2008, 18.

109. Ehrlich 2010, 299-318. Although he refers to some papers of Maeder, and Maeder & Halbeisen, all citations are copied from a homepage without any scientific background ([www.designboom.com](http://www.designboom.com)), dated 2002.

110. Villard 2010, 388-399.

111. Dalley 1991, 121.

Bronze Age and Early Iron Age sources it may be possible to show, both from representations and from texts that indicate the direction of trade, that Akkadian *būṣu* is indeed the fabric made of mollusc filaments.”<sup>112</sup>

### 2013: Example five

In a discussion about the term *thalassai* in the *Book of Prefect*, a Byzantine commercial manual of the 9th century, a “textile from byssos – the so-called sea silk (also: marine wool or marine silk)” is mentioned.<sup>113</sup> The authors not only refer to the above-mentioned book of Ditchfield, but also to the *Der Kleine Pauly. Lexikon der Antike*:

Byssos (βύσσος) bezeichnet verschiedene pflanzliche und tierische Fasern, βύσσινος, βύσσινον πέπλωμα ... Kaum jünger als die Bezeichnung für Leinfasern dürfte die für die bis heute Byssos genannten Haftfasern festsitzender Meermuscheln, besonders der im Mittelmeer verbreiteten *Pinna nobilis* sein, aus deren 3-8 cm langen Fasern seit dem Altertum Stricke, Strümpfe, Handschuhe u.a. hergestellt werden.<sup>114</sup>

The same term in *Der Neue Pauly*:

Byssos (βύσσος). Pflanzliche und tierische Fasern, die in weitgehend durchsichtigen Gewändern (βύσσινος, βύσσινον πέπλωμα) verarbeitet wurden.<sup>115</sup>

Some facts, some ambiguities, some similarities... it is no wonder that the authors of the article come to the following conclusion: “We therefore believe that *thalassai* is a manufacture fabricated from *byssos* (‘sea silk’, ‘marine wool’) and imported from Syria

as luxurious commodity.” It should be added that *thalassai* really could refer to textiles made of sea-silk, made of the byssus of *Pinna nobilis*! But it was not the *byssos* of the ancients.

### 2013: Example six

The term *byssus* and its derivations are also mentioned and discussed in the book *Etymologies of Isidor of Sevilla and in the Summarium of Heinrici*. The conclusion of the authors is: „Byssum ist kein bestimmtes Material, sondern ein Qualitätsbegriff, hinter dem sich die Rohstoffe Leinen, Baumwolle und Muschelseide verbergen können.“<sup>116</sup> Of course, sea-silk was known in the 7th and 11th century, but as I have demonstrated above, it would not have been called byssus.

### 2013: Example seven

In a recent semiotic thesis about the traditional costume in Sardinia, the whole chapter of byssus and sea-silk consists of unquestioned stories about this so-called ‘oral tradition’ heard from the above mentioned Sardinian weaver who has declared herself the last and only sea-silk weaver of the world, “*Maestro di bisso*” since 20 generations!<sup>117</sup> No questioning, no discussion of terms, no precise references to any literature. The chapter ends with a poem of Giovanni Pascoli, a 19th century Italian poet citing the precious silk «*la preziosa seta*»: “*O mani d’oro, le cui tenui dita menano i tenui fili ad escir fiori dal bianco bisso, e sì, che la fiorita sembra che odori*” – even the ‘white byssus’ is not scrutinised or questioned.<sup>118</sup>

112. Dalley 1991, 121-122.

113. Jaroszinsky & Kotlowska 2013, 39-46.

114. *Der Kleine Pauly. Lexikon der Antike* 1979, 978–979 (H. Gams).

115. Hünemörder 1997, 866.

116. Müller *et al.* 2013, 320.

117. <http://www.donneuropa.it/lifestyle/2014/04/18/chiara-vigo-maestro-bisso-venti-generazioni/> (20.12.2014).

118. Sedilesu 2013, 98-102. ‘White byssus’ is another topos in byssus/sea-silk discussion, probably referring to cotton, or used in a symbolic sense. This is only one of a dozen Italian Universities theses on sea-silk in Sardinia of the last years, all referring to Chiara Vigo. Corresponding events have taken place in different universities like Cagliari, Siena, Venice, Rome and other cultural institutions.

**2014: Example eight**

In a book of 2014 titled “Unwrapping Ancient Egypt” we read:

*The finest linen, known as ‘royal linen’, was almost sheer and is sometimes erroneously translated as byssus, after the Greek word for a thread spun from mollusk secretions, whose miraculous, gossamer quality the finest woven flax may have resembled.*<sup>119</sup>

**Conclusions of the Italian situation**

John Peter Wild stated once: “To discover the meaning of a specific textile term, a lexicon is a good place to start, but a bad place to end.”<sup>120</sup> How true! Studying the terms byssus and sea-silk in lexicons and dictionaries is of nearly no help. They only render the researchers uncertain with all their inconsistencies and contradictions. As we have seen, even actual specialised dictionaries raise more questions than answering them.

This background explains why fantastic stories around real sea-silk production – as we hear of Sant’Antioco – encounter such an enormous interest. Sea-silk exists! You can touch it! How could all this not be true?

These few examples – from the thesis of a Roman university to historical and textile studies of antique and medieval times up to a modern specialised lexicon and biological reference book – show the consequences of the impact of mass media in present-day research, at least in the matter of byssus and sea-silk. The ‘power of naming’ – so it seems – lies more and more in fanciful websites, odd blogs, facebook accounts, and magic events around ‘secret and sacred old traditions’. How should textile research handle this?

**Bibliography**

- Abdel-Maksoud, G. & Abdel-Rahman, E.-A. (2013) The investigation and conservation of a gazelle mummy from the late period in ancient Egypt, *Mediterranean Archaeology and Archaeometry*, 13(1), 45-67.
- Alinari, V. (1915) *In Sardegna. Note di viaggio*. Firenze.
- Badde, P. (2005) *Das Muschelseidentuch. Auf der Suche nach dem wahren Anlitz Jesu*. Berlin.
- Badde, P. (2010a) *L’autre suaire: Enquête sur le secret de Manoppello*. Paris.
- Badde, P. (2010b) *The Face of God - The Rediscovery Of The True Face of Jesus*. San Francisco.
- Badde, P. (2010c) Der Schleier der Jungfrau. Die Franziskaner in Assisi zeigen ein ganz besonderes Muschelseidentuch. *Vatican Magazin* 12, 48-51.
- Badde, P. (2011) *Das göttliche Gesicht im Muschelseidentuch von Manoppello*. Kisslegg.
- Badde, P. (2014) *Die Grabtücher Jesu in Turin und Manoppello: SUDARIUM ET VESTES*. Berlin.
- Bardini Barbafera, L. (1994) Il Bisso, *Jacquard* 21, 5-12.
- Basso-Arnoux, G. (1916) *Sulla pesca ed utilizzazione della “Pinna Nobili” e del relativo bisso*. Roma.
- Battisti, C. & Alessio, G. (1950) *Dizionario Etimologico Italiano*. Firenze.
- Beck, S. W. (1882) *The Draper’s Dictionary. A Manual of Textile Fabrics: their history and applications*. London.
- Beekes, R. (2009) *Etymological Dictionary of Greek*. Leiden.
- Beullens, P. & Gotthelf, A. (2007) Theodore Gaza’s Translation of Aristotle’s *De Animalibus*: Content, Influence, and Date, *Greek, Roman, and Byzantine Studies* 47, 469-513.
- Bezon, J. (1857) *Dictionnaire général des tissus anciens et modernes, ...* Lyon.
- Bickel, S. & Paulin-Grothe, E. (2012) The Valley of the Kings: two burials in KV 64, *Egyptian Archaeology* 41, 36-40.
- Bock, F. (1866) *Geschichte der liturgischen Gewänder des Mittelalters oder Entstehung und Entwicklung der kirchlichen Ornate und Paramente*. Bonn.
- Bock, F. (1884) *Goldstickereien und Webereien in alter und neuer Zeit und das dazu verwandte Goldgespinnst*. Nürnberg.
- Bock, F. (1895) *Die textilen Byssus-Reliquien des christlichen Abendlandes, aufbewahrt in den Kirchen zu Köln, Aachen, Cornelimünster, Mainz und Prag*. Aachen.

119. Riggs 2014, 117. The author refers to Dalley 1991 (as did Villard 2010), but also to the homepage of the Sea-silk Project; I take it as an appeal to re-read it carefully and look for misunderstandings.

120. Wild 2007, 5.

- Bonanno, P. (1684) *Recreatio mentis et oculi - In Observatione Animalium Testaceorum*. Roma.
- Braun (Braunius), J. (1680) *Vestitus sacerdotum hebraeorum: sive commentarius amplissimus in Exodi cap. 28 ac 39 et Levit. cap. 16, aliaque loca s. Scripturae quam plurima*. Amsterdam.
- Brühl, L. (1938) Muschelseide. In F. Pax & W. Arndt (eds.), *Die Rohstoffe des Tierreichs*, 963-985. Berlin.
- Brunello, F. B. (1973) *The Art of Dyeing in the History of Mankind*. Vicenza.
- Buonanni, F. (1681) *Ricreatione dell'occhio e della mente - Nell'Osseruatione delle Chioccioline*. Roma.
- Campi, E. (2004) Il bisso nella Bibbia. In E. Campi (ed.), *La seta del mare - il bisso. Storia, cultura, prospettive*. 201-205. Taranto.
- Campi E. (ed.) (2004) *La seta del mare - il bisso. Storia, cultura, prospettive*. Taranto.
- Carta Mantiglia, G. (1997) La produzione del bisso marino. In G. Mondardini Morelli & G. Lilliu (eds.), *Pesca e pescatori in Sardegna. Mestieri del mare e delle acque interne*, 89-99. Cinisello Balsamo-Milano.
- Carta Mantiglia, G. (2006) I materiali della tessitura: lana, lino, cotone, seta, bisso, canapa. In *Tessuti. Tradizione e innovazione della tessitura in Sardegna*, 65-103. Nuoro.
- Chambers, E. & Scott, G. L. (1753) *A supplement to Mr. Chambers's cyclopaedia: or, universal dictionary of arts and sciences*. London.
- Cooke, W. D. & El-Gamal, M. (1990) Ancient textile technology - the hand spinning of ultra-fine yarns, *CIETA-Bulletin* 68, 69-74.
- D'Alessio, C. (1958) Il bisso tarantino: leggende e inesattezze, *Voce del Popolo* LXXV, no. 15. Taranto.
- Dalley, S. (1991) Assyrian textiles and the origins of carpet design, *Iran* 29, 117-135.
- de Reyer, D., Pilbout, S., Dennebouy, N. & Monnerot, M. (1997) Autour de la chasuble de saint Yves, analyse des fils d'or utilisés dans les décors de textiles médiévaux. *Comptes rendus des séances de la Société de Biologie et de ses filiales* 191 (4), 511-519.
- de Simone, L. G. (1867) *La madreperla tarentina e il suo bioccolo. Monografia illustrativa di un album di lavori in lanapenna spedito all'esposizione di Parigi*. Taranto.
- Diderot, D. & d'Alembert, J. B. I. R. (eds.) (1751) *Encyclopédie, ou dictionnaire raisonné des sciences, des arts et des métiers*. Paris.
- D'Ippolito, L. (2004) Fra antiche tradizioni e ambizioni industriali: la produzione di bisso marino a Taranto / Zwischen alter Tradition und industriellen Ambitionen: Die Produktion von Muschelseide in Taranto. In Maeder, F., Hänggi, A. & Wunderlin, D. (2004) *Muschelseide - Goldene Fäden vom Meeresgrund / Bisso marino - Fili d'oro dal fondo del mare*, 73-112. Milano.
- Ehrlich, H. (2010) Byssus: From Inspiration to Development of Novel Biomaterials. In *Biological Materials of Marine Origin. Biologically-Inspired Systems 1*, 299-318. Berlin.
- Emery, I. (1980) *The primary structures of fabrics: An illustrated classification*. Washington.
- Fabbroni, A. (1782) *Del bombice e del bisso degli antichi*. Perugia.
- Fanfani, P. (ed.) (1895) *Novissimo vocabolario della lingua Italiana, scritta e parlata; compilato... e riveduto; aggiuntovi in appendice, un dizionario di geografia moderna, e un compendio di mitologia*. Napoli.
- Flury-Lemberg, M. (1988) *Textilkonservierung im Dienste der Forschung*. Katalog 77. Bern.
- Forbes, R. J. (1956) *Studies in ancient technology*. Leiden.
- Gaeta, S. (2010) *L'enigma del Volto di Gesù*. Milano.
- Gardner Wilkinson, J. (1842) *Manners and Customs of the Ancient Egyptians: Including Their Private Life, Government, Laws, Arts, Manufactures, Religion and Early History*. Vol. 3. London.
- Geijer, A. (1971) Technical viewpoints on textile design. Continuity and evolution especially during the first millennium A.D. In *Artigianato e tecnica nella società dell'alto medioevo occidentale*, 685-712. Spoleto.
- Gilroy, C. G. (1845) *The History of silk, cotton, linen, wool and other fibrous substances; including observations on spinning, dyeing and weaving*. New York.
- Gleba, M. (2008) 'Auratae vestes': Gold textiles in the ancient Mediterranean. In C. Alfaro & L. Karali (eds.), *Vestidos, textiles y tintes. Estudios sobre la producción de bienes de consume en la Antigüedad. Actas del II Symposium Internacional sobre Textiles y tintes del Mediterráneo en el mundo antiguo (Atenas, 24 al 26 de noviembre, 2005)*, 61-77. Purpureae Vestes II: Textiles and Dyes in Antiquity. Valencia.
- Hall, R. (1986) *Egyptian textiles*. Aylesbury.
- Hannig, R. & Vomberg, P. (2012) *Kulturhandbuch Ägyptens. Wortschatz der Pharaonen in Sachgruppen*. Mainz.
- Harmuth, L. (1915) *Dictionary of Textiles*. New York.
- Heiden, M. (ed.) (1904) *Handwörterbuch der Textilkunde aller Zeiten und Völker*. Stuttgart.
- Hollendonner, F. (1917) Az aquincumi römái szövet anyaga, *Botanikai Közlemények* XVI, 35-37.
- Hünemörder, C. (1997) Byssos. In *Der Neue Pauly - Enzyklopädie der Antike*, 866. Stuttgart.
- Jacoby, D. (2014) Cypriot gold thread in late medieval silk weaving and embroidery. In S. B. Edgington & H. J. Nicholson (eds.), *Deeds Done Beyond the Sea. Essays on William of Tyre, Cyprus and the Military Orders presented to Peter Edbury*. London.



- Jaroszynski, A. & Kotlowska, A. (2013) Eparchikon Biblion V, 2. Is Thalassai the Same as Byssos? *Studia Ceranea* 3, 39-46.
- Jones, J., Higham, T. F. G., Oldfield, R., O'Connor, T. P. & Buckley, S. A. (2014) Evidence for Prehistoric Origins of Egyptian Mummification in Late Neolithic Burials. *PLoS ONE* 9(8): e103608. <https://doi.org/10.1371/journal.pone.0103608>
- Karabacek, J. (1882) *Ueber einige Benennungen mittelalterlicher Gewebe*. Wien.
- Karatzani, A. (2012) Metal threads: the historical development. In I. Zimi & E. Tzachili (eds.), *Textiles and Dress in Greece and the Roman East: A Technological and Social Approach*, 55-65. Athens.
- Kersken, S. A. (2008) *Töchter Zions, wie seid ihr gewandet? Untersuchungen zu Kleidung und Schmuck alttestamentlicher Frauen*. Münster.
- Krünitz, J. G. (ed.) (1805) *Ökonomisch-technologische Encyklopädie, oder allgemeines System der Staats-, Stadt-, Haus- und Landwirthschaft, und der Kunst-Geschichte*. Berlin.
- Laufer, B. (1915) The story of the pinna and the Syrian lamb, *The journal of American folklore* 28 (108), 103-128.
- Lessona, M. (ed.) (1905) *Dizionario di Cognizione utile, enciclopedia elementare*. Torino.
- Long, G. (1846) *The Egyptian Antiquities in the British Museum: Monuments, Obelisks, Temples, Sphinxes, Sculpture, Statues, Paintings, Pyramids, Mummies, Papyrus, and the Rosetta Stone*. Vol. 2. London.
- McKinley, D. (1998) Pinna and her silken beard: a foray into historical misappropriations, *Ars Textrina* 29, 9-223.
- Maeder, F. (2002) The Project Sea-silk – Rediscovering an Ancient Textile Material, *Archaeological Textile Newsletter* 35, 8-11.
- Maeder, F. (2004) Muschelseide - wie weiter? *Archaeological Textiles Newsletter* 39, 12-15.
- Maeder, F. (2008) Sea-silk in Aquincum: First production proof in antiquity. In C. Alfaro & L. Karali (eds.), *Vestidos, textiles y tintes. Estudios sobre la producción de bienes de consume en la Antigüedad. Actas del II Simposium Internacional sobre Textiles y tintes del Mediterráneo en el mundo antiguo (Atenas, 24 al 26 de noviembre, 2005)*, 109-118. Purpureae Vestes II: Textiles and Dyes in Antiquity. Valencia.
- Maeder, F. (2009) Die Edle Steckmuschel und ihr Faserbart: Eine kleine Kulturgeschichte der Muschelseide, *Mitteilungen der Naturforschenden Gesellschaften bei der Basel* 11, 15-26.
- Maeder, F. (2010) La soie marine en France et les objets tricotés du XIVE-XXe siècle. In Coppens, M. (ed.), *La maille. Une histoire à écrire. Association française d'Etude du Textile, Journées d'Etude 20/21 novembre 2009*, 77-101. Troyes.
- Maeder, F. (2013) Gesucht und gefunden: Muschelseide in einem alten Wollmusterbuch des 18. Jahrhunderts, *Das Monschauer Land, Jahrbuch 2013*, 10-22.
- Maeder, F. (2015) Byssus und Muschelseide – ein sprachliches Problem und seine Folgen. In H. Harich-Schwarzbauer (ed.), *Weben und Gewebe in der Antike: Materialität – Repräsentation – Episteme – Metapoetik. / Texts and textiles in the ancient world: Materiality – Representation – Episteme – Metapoetic*. Ancient Textile Series 23, 3-20. Oxford.
- Maeder, F. (2016) Nicht überall, wo Byssus draufsteht, ist Muschelseide drin. Sprachliche und materielle Aspekte eines Missverständnisses – und die Folgen. In K. Dietz, C. Hannick, C. Lutzka, & E. Maier (eds.), *Das Christusbild. Zu Herkunft und Entwicklung in Ost und West*. Akten der Kongresse in Würzburg (16.-18.10.2014) und Wien (17.-18.3.2015), 790-848. Würzburg.
- Maeder, F. (2017) Byssus and sea-silk: a linguistic problem with consequences. *Ancient Textiles Series* 30, 4-19. Oxford.
- Maeder, F. (2016 b) Landscape of Sea-Silk. Traces of traditional production around Mediterranean Sea. *Proceedings of the ICOM Costume Committee Annual Meeting, Milan 2016*. [http://network.icom.museum/fileadmin/user\\_upload/minisites/costume/pdf/Milan\\_2016\\_Proceedings\\_-\\_Maeder.pdf](http://network.icom.museum/fileadmin/user_upload/minisites/costume/pdf/Milan_2016_Proceedings_-_Maeder.pdf)
- Maeder, F. & Halbeisen, M. (2001) Muschelseide: auf der Suche nach einem vergessenen Material, *Waffen- und Kostümkunde* 1, 33-41.
- Maeder, F. & Halbeisen, M. (2002) Il Bisso marino: alla ricerca di un materiale perduto, *Jacquard* 50, 4-10.
- Maeder, F., Hänggi, A. & Wunderlin, D. (2004) *Muschelseide – Goldene Fäden vom Meeresgrund / Bisso marino - Fili d'oro dal fondo del mare*. Milano.
- Mastrocinque, B. (1928) *Bisso e porpora - per la rinascità delle due grandi industrie*. Taranto.
- Michelsen, E. H. (1860) *The merchant's polyglot manual, in 9 languages*. Oxford.
- Mongez, A. l'ainé (1818) *Recherches sur l'habillement des anciens: I<sup>ère</sup> Partie. Matières employées par les anciens pour leurs vêtements, et du travail de ces matières*. In *Histoire et Mémoires de l'Institut Royal de France. Classe d'Histoire et de Littérature Ancienne*, 228-229. Paris.
- Müller, M., Babin, M.-L. & Riecke, J. (eds.) (2013) *Das Thema Kleidung in den Etymologien Isidors von Sevilla und im Summarium Heinrici I*. Berlin.
- Nagy, L. (1935) *Aquincumi Mumia-temetkezések. Mumien-gräbnisse aus Aquincum* (Deutscher Auszug). Budapest.

- Olck, F. (1897) Byssos. In G. Wissowa (ed.), *Paulys Real-Encyclopädie der classischen Altertumswissenschaft*, 1108-1114. Stuttgart.
- Piquereddu, P. (2003, ristampa 2009) Note di storia dell'abbigliamento in Sardegna. In M. T. Binaghi Olivari (ed.) *Costumi. Storia, linguaggio e prospettive del vestire in Sardegna*, 15-60. Nuoro.
- Quenouille, N. (2005) Some aspects of the Textile Industry in Roman Egypt. New Archaeological and Papyrological Researches on the Fayyum, *Papyrologica Lupinensia* 14, 229-250.
- Quenouille, N. (2012) Edition und Kommentar neuer Papyri aus den französisch-italienischen Grabungen in Tebtynis (Ägypten) (P. Tebt. Quen.). Inaugural-Dissertation Universität Trier, WS 2007/2008, *Fachbereich III / Papyrologie*. Trier.
- Riggs, C. (2014) *Unwrapping Ancient Egypt*. London-New York.
- Rondelet, G. (1555) *Universae aquatilium historia*. Lyon.
- Rondelet, G. (1558) *L'histoire entière des poissons*. Lyon.
- Rosa, D. M. (1786) *Delle Porpore e delle materie vestiarie presso gli antichi*. Modena.
- Rudolph, D. G. (1766) *Hand-Buch oder kurze Anweisung wie man Naturalien-Sammlungen mit Nutzen betrachten soll*. Kopenhagen.
- Sada, L. (1983) *Perle dei mari di Puglia*. Taranto.
- Sagot-Ortega, A. (1992) Le byssus ou laine d'or, *Techniques et Culture* 19, 191-196.
- Scales, H. (2015) *Spirals in Time. The Secret Life and Curious Afterlife of Seashells*. London, New York. In Italian: (2017) *Spirali nel Tempo. Le Conchiglie e Noi*. Trieste.
- Schrader, C. (2007) *Vor dem Angesicht: Betrachtungen und Erfahrungen vor dem Muschelseidenbild in Manoppello*. Berlin.
- Scot, D. (1827) On the substance called Fine Linen in the Sacred Writings, *The Edinburgh New Philosophical Journal* 3, 71-81.
- Sedilesu, S. (2013) *Il costume tradizionale sardo - Storia, significato e tradizione*. Roma.
- Smith, W. (1854) *Dictionary of Greek and Roman Geography*. London.
- Smith, W. L., Wayte, W. & Marindin, G. E. (eds.) (1890) *A Dictionary of Greek and Roman Antiquities*. London.
- Sroka, P. (1995) Kostbarer Faserstoff aus der Antike. Handelt es sich beim biblischen Byssus um Muschelseide? *Restauro* 5, 338-342.
- Treccani (ed.) (1930) *Enciclopedia Italiana Treccani*, Milano.
- Trevor-Roper H. (1983) The invention of tradition: the Highland tradition of Scotland. In E. Hobsbawm & T. Ranger (eds.), *The invention of tradition*, 15-42. Cambridge.
- van den Hövel, M. (2013) *Der Manoppello-Code: Veronica Manipuli*. Norderstedt.
- van der Feen, P. J. (1949) Byssus, *Basteria* 13(4), 66-71.
- Veiga, P. (2012) Studying Mummies and Human Remains: Some Current Developments and Issues, *Washington Academy of Sciences WAS*, 1-22.
- Vial, G. (1983) A propos d'une soierie façonnée, dite de "Byssus", *Bulletin du Centre International d'Etude des Textiles Ancien CIETA* 5758, 50-60.
- Vigo, M. (2010) Linen in Hittite Inventory Texts. In C. Michel & M.-L. Nosch (eds.) *Textile Terminologies in the Ancient Near East and Mediterranean from the 3rd to the 1st Millennia BC*, 290-322. Ancient Textiles Series 8. Oxford.
- Villani, G. B. (1947-48) *La pinna nobilis con particolare riferimento alla lavorazione del bisso e sua possibile rinascita industriale*. Bari.
- Villard, P. (2010) Les textiles néo-assyriens et leurs couleurs. In C. Michel & M.-L. Nosch (eds.) *Textile Terminologies in the Ancient Near East and the Mediterranean from the 3rd to the 1st Millennia BC*, 388-399. Ancient Textiles Series 8. Oxford.
- Viviani, D. (1836) Del Bisso degli antichi del professore cav. Domenico Viviani. In *Biblioteca italiana, o sia Giornale di letteratura, scienze ed arti compilato da varj letterati*. Vol. 81, 94-109. Milano.
- Vogelsang-Eastwood, G. (1993) *Pharaonic Egyptian clothing*. Leiden.
- Vogelsang-Eastwood, G. (2001) Textiles. In P. T. Nicholson & J. Shaw (eds.) *Ancient Egyptian Materials and Technology*, 268-298. Cambridge.
- Wadischat, E. (2008) *Expert-Praxislexikon Textilkunde*. Renningen.
- Wild, J. P. (2007) Methodological introduction. In C. Gillis & M.-L. B. Nosch (eds.) *Ancient Textiles. Production, Craft and Society*, 1-6. Ancient Textiles Series 1. Oxford.
- Williams, W. H. A. (2010) *Creating Irish Tourism: The First Century, 1750-1850*. London.
- Winlock, H. E. (1940) The Mummy of Wah Unwrapped, *The Metropolitan Museum of Art Bulletin* 35(12), 253-259.
- Wipszycka, E. (1965) *L'industrie textile dans l'Egypte romaine*. Warschau-Krakau.
- Yates, J. (1843) *Textrinum Antiquorum: An Account of the Art of Weaving Among the Ancients ...* Part 1, London.
- Zanetti, G. B. (1964) Un'antica industria sarda: il tessuto d'arte per i paramenti sacri, *Archivio Storico Sardo* 29, 193-273.

## Conceptualizing Greek Textile Terminologies: A Databased System<sup>1</sup>

Kalliope Sarri

One of the major challenges in costume and textile research is dealing with the vast number of terms related to textiles and garments, especially because similar terms are found in different languages and dialects, in various regions and over long periods of time, where they have survived in a complicated network of linguistic and cultural interrelations. There have been many attempts to collect textile terms in glossaries as parts of costume studies or as parts of museum archival projects. These glossaries however are usually limited to specific topics, geographical areas, languages, and time periods.

Creating a diachronic and global costume term base in the Greek language is of considerable value for textile terminology, since the earliest textile terms in the Greek language go back to the second millennium BC, retrieved from the clay tablet archives of the Mycenaean palaces.<sup>2</sup> These early textile terms can be also traced in the vocabularies of other ancient

languages, such as the word *khiton* (Greek: χιτών), which appears as *ki-to* in Linear B coming from the Semitic *ktn*.<sup>3</sup>

An effort to systematize Greek textile terms in a databased system was initiated as a pilot program between the years 2000-2003 and it was first presented at the conference on *Textile Terminologies from the Orient to the Mediterranean and Europe 1000 BC – AD 1000* and at the *Euroscience Open Forum* meeting (Copenhagen 2014). This study is now included in the present volume. The project took place during the recording of a costume collection, which was a joint project of the Peloponnesian Folklore Foundation, the Museum of Greek costumes and the Foundation of the Hellenic World. The term collection was initially focused on Greek traditional costumes of the 19th century. Soon after its first steps it became clear that the collection had to be extended to other periods, languages and areas adjacent to the modern

1. I owe many thanks to Ioanna Papantoniou, Xenia Politou, Nadia Maha-Bizoumi and Angeliki Roumeliotou for their valuable advice and encouragement during the compilation of the terms collection at the Peloponnesian Folklore Foundation and the Museum of the History of the Greek Costume of the Lyceum Club of Greek Women between the years 1999-2002. I am very grateful to Marie-Louise Nosch and Susanna Lervad for discussions on the concept and usefulness of the database and for reviewing this paper. I also owe many thanks to Cécile Michel and Salvatore Gaspa for accepting this paper in the conference volume.

2. For the Mycenaean textile vocabulary see Del Freo, Rougement & Nosch 2010.

3. Michel & Nosch 2010, xi.

Greek state in order to enlighten the etymology and the alterations of the terms. Moreover, through this linguistic pathway it is possible to trace a wide range of historical and cultural contacts between various ethnic communities within and outside these borders. Thus, costume terms from the oldest historical periods and from areas outside the current political and cultural boundaries of Greece have been included in this project.

The textile term collection, the structure of which is presented here, contains approximately 6000 terms directly related to clothing items but also to raw materials, treatments, implements and stages of manufacture, and also related to the physical conceptual environment of clothing production, *e.g.* *fõrema* (Greek: φόρεμα): dress and *nyphikó* (Greek: νυφικό): wedding dress, their use by specific social or professional groups, *e.g.* *diadema* (Greek: διάδημα): diadem, as well as special pragmatic and linguistic definitions linked to them, *i.e.* *ghyaloméno* (Greek: γυαλωμένο: textile finishing through applying glass pressure; from γυαλί: glass). At the same time, the collection includes terms concerning ancient garments, textiles and textile implements seen as archaeological finds, exhibition objects and as objects under conservation and research.

While compiling textile terms from various historical periods, we noticed that a high number of words derive from other languages, some of which reached Greek as loans or as results of mutual loans, while the origin of many other terms remains unclear. Alternative etymologies have been included with the main entries, and thus the dictionary, apart from being a place for collecting and explaining the meaning of the textile concepts, can also be used as an etymological tool for monitoring a perpetual traffic of textile related words in space and time.

### The concept

The multi-thematic and diachronic collection of textile terms presented here aims – through a systematization of the terminology – at acquiring direct knowledge of as many diverse aspects of the historical

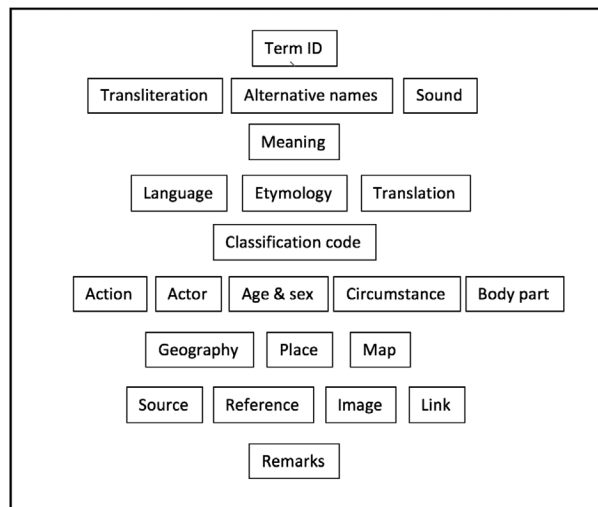


Fig. 1

costumes as possible. In a thesaurus in the form of a dictionary or encyclopaedia it is possible by a simple query to reach the meaning as well as side information about all compiled entries.<sup>4</sup> The major advantage of a databased system such as the one suggested here is that the search can also be operated in a reverse direction, that is, starting from a survey on a special field of interest one is able to discover many more related words, focused on specific topics and taking into consideration various chronological and geographic parameters (fig. 1). This can be achieved a) through a system of classification fields and b) through a system of keywords directed towards specific thematic units. Thus, a simple lexicographical research can be turned into a search-engine extending beyond time or space limitations. The experience with this kind of structure so far has showed that a search system based on key fields and keywords leads to many more unexpected findings about the origin, the history, and the distribution of clothing items and related terms than those initially targeted.

### Terminological sources

The sources of the term collection are of different nature, depending on the periods from which they come. For the prehistoric and proto-historic periods

4. An example of this kind is the online terminology collection *Textilnet*. See Engelhardt Mathiassen & Ringbøl Bitsch 2016 and Lervad & Engelhardt Mathiassen in this volume.

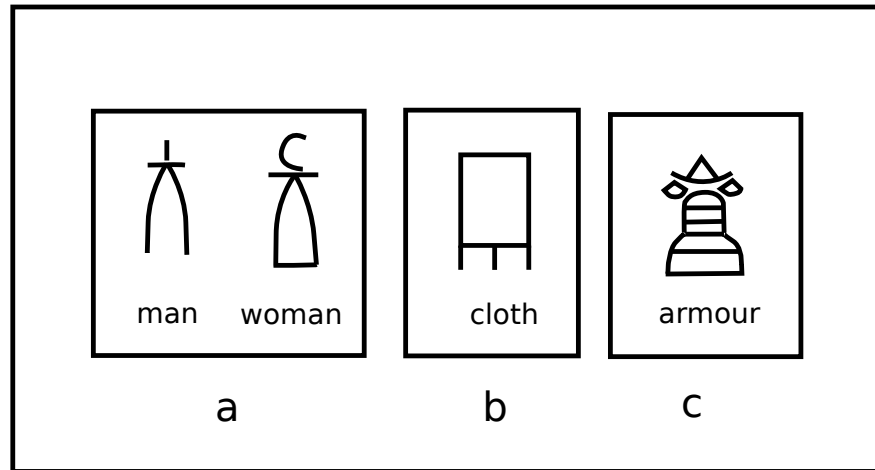


Fig. 2

there is not a verbal terminology, yet archaeological terms referring to a rich imagery or to the use of textile related objects and connotations can suggest visual or linguistic comparisons with later historical terms, revealing the origins of clothing production before they appear in any deciphered language.<sup>5</sup> An example is the term ‘Minoan dress’, which despite its obvious onomasiological convention, is a definition that shows the pattern of the hieratic garment of the Minoan period and can be compared to costume patterns of other cultures.<sup>6</sup> In some cases, the archaeological record seems able to indirectly support the terminology and can even lead to the meaning of words and symbols, *i.e.* the prehistoric loom weights explain in reality the shape of ideograms TELA of Linear B script (fig. 2b) but they also clarify the etymology of the ancient Greek word for loom *histos* as this means a standing or vertical loom.<sup>7</sup> At the transition from prehistory to history during the Late Bronze Age, the first, fragmentary texts in the Linear B script contain the oldest Greek words denoting clothing. Here, pictograms, if compared with their contemporary illustrations and other archaeological evidence, can help link images with words, *i.e.* the different symbols for women and men show that they

wore different clothes and that women’s clothes were long wide dresses while men wore short garments. A characteristic example of linking texts and objects is the symbol of armour, which can be verified by means of Mycenaean items known from the archaeological record (fig. 2c).

### *Historic textile terms*

In the Greek and Latin texts of history and philosophy, poetry and in the texts referring to nature, *i.e.* the works of Pliny, there is a large amount of costume and textile terms, most of which have been already recorded in the classical language dictionaries. So, it is possible to search and find exactly, meanwhile on the web as well, in which ancient text certain terms occur and how their meanings are differentiated by diverse authors.<sup>8</sup> At this point, it is worth mentioning that ancient writers and modern translators – especially those who were not particularly interested in giving very precise descriptions of nature or technicalities – do not always give accurate information in the fields of textile production and costumes and sometimes they even give confusing or misleading information. Classical examples are the Greek words

5. For aspects of nonverbal terminology see Lervad, Flemestad & Weilgaard Christiansen 2016.

6. Jones 2015, 27-55.

7. See the different versions of the logograms in Nosch 2016, fig. 17.2, table B.

8. See, *e.g.*, the Perseus Digital Library: <http://www.perseus.tufts.edu/hopper/>.

*byssos* and *mitos*, discussed in the present volume,<sup>9</sup> as well as the word *diplox* in the translations of Homer.<sup>10</sup> In such cases the search and comparison between alternative meanings and descriptions can lead to corrections or altered interpretations of the primary information. Numerous depictions of people in ancient art, *i.e.* in sculpture, vase painting and architecture, sometimes show with many details how ancient clothing was made and how it was worn, so that we can easily compare pictures with words.<sup>11</sup>

For the term collection from Late Antiquity, Byzantium, and the Medieval period we have used similar historical and literary sources, which are supported by a rapidly growing number of –in the areas of the east Orthodox church Greece’s mostly religious – iconographic data. Mutual loans during these historical periods can be traced more accurately with knowledge of other languages and through the increasing amount of information saved in the literature and other written sources.<sup>12</sup>

Encyclopaedias and lexica, especially of an older date and concept, bridge the linguistic distance to our modern era<sup>13</sup> while when approaching our time, the number of special costume studies increases and these are very often accompanied by term glossaries, which can be included in the database. Museums and textile research centres have also accumulated large numbers of textile terms in archives, publications, exhibition and educational material, which can be further systematized and used as direct information sources.<sup>14</sup> In the modern era of media and multimedia environments, journalistic texts, documentary films, interviews, ethnographic photography and blogs presented on the Web have been also proven a valuable pathway for discovering unknown or laboriously accessible textile terms.

### The structure of the database

The textile term database consists of two kinds of fields: fields to be filled out with textual information and fields planned as multiple choice lists based on preselected categories (fig. 3). All entries can be classified by the users in order to form queries based on certain groups of criteria. In this way, users can collect and study comparatively terms from specific areas, historical periods and languages, as well as terms related to special research fields and terms referred by certain authors or in special kinds of publications.

Close to the term ID, the etymology of this word is given as the first, second or third language of attestation. Here various authors and sources can give diverse information or their personal view on the derivation of the terms, which can be compared and evaluated by the database users and researchers. For a better tracking of the terms’ *mobility*, it is also very useful to supply a phonetic transcription as well as a sonic performance of the terms. In this way, it is easier to compare terms, which may offer a weak phonological but a stronger sound relation, maybe altered by local dialects and language loans.

One of the crucial features of this database is a field containing classification codes, which makes it easier to approach, detect and categorize the semantic and functional environment of the terms. The codes appear as acronyms consisting of three letters and function as key words leading to information asked with a query. Through this, users can reach information on the conceptual or functional environment of the term, *i.e.* to find if entries denote textile fibres, dyes, weaving implements, workshops, clothes, decorations, accessories or parts of accessories. For example: a chemical substance for cleaning or fixing

9. See for example the contribution by Felicitas Maeder.

10. Kolonas *et al.* 2017.

11. For an updated study of ancient Greek clothing see Spantidaki 2016.

12. A crucial source of nonverbal information about the costumes of the Ottoman period are the illustrations based on travellers’ reports, *i.e.* Stackelberg *c.* 1828. This publication has been recently accessible online at the webpage of the Sylvia Ioannou Foundation: <http://www.sylviaioannoufoundation.org/digital-library.html?view=book&id=32>

13. A very useful source for terms of the medieval period is the 19 volumes *Dictionary of Medieval Vulgar Greek Literature* (1100-1669) by E. Kriaras, See Kriaras 1968/2014 and Kazazis 2001/2003.

14. A large number of studies on the traditional Greek costumes are published by the Peloponnesian Folklore Foundation. See Papantoniou 1996.

<b>Name of field / field group</b>	<b>Description &amp; Function</b>	<b>Field type</b>
Name	Term ID	Text
Sound	Acoustic value	Button
Transliteration	Phonetic value	Text
Alternative name/s	Alternative name/s	Text
Meaning	Description of the term	Text
Language	Greek, Italian, Arabic, Turkish, Albanian, etc.	Check field Yes/No
Original Language	Intermediate	Text
Translation to other languages (if applicable)	European languages / English plus Turkish, Arabic, Hebrew	Text
Action	e.g. Spinning, Weaving, sewing, dyeing, pleating, wearing etc.	Multiple Choice
Classification code	e.g. Textile, dress, shoe, hat, weapon etc.	Multiple Choice
Body part	e.g. Head, hand, foot, neck, bodice, lower part	Multiple Choice
Age & sex	e.g. Man, woman, child, baby, old person	Multiple Choice
Actor	e.g. worker, warrior, bride, priest, royalty, not defined	Multiple Choice
Circumstance	e.g. Everyday dress, work, wedding, funeral, dance, sport, war	Multiple Choice
Geography (three fields)	Continent, country & region	Multiple Choice Multiple Choice Text
Place	Name of the place (town or village)	Text
Map	Coordinates and & map	Text & GPS map
Source	e.g. Ancient archive, historiography, literature, lexicon, research, modern archive, internet, visual art, sound art	Multiple Choice
Reference (five fields)	Author, Title, Year, Page & figure number	Alphanumeric
Image	Visual evidence	Image
Remarks	Special observations related to the entry	Text field
Internet citation	External document where information is given	Hyperlink

Fig. 3

textiles would belong to the category ‘conservation’, a coloring plant to the ‘dyes’, a pattern to decoration, a clothing item to ‘part of costume’. The more specific codes are, the easier it is for the database user to discover new terms and evidence in particular fields of interest.

Apart from this main classification code, a series of other fields are aimed at yielding classified information. The field ‘activity’ *e.g.* leads to a certain stage of textile and costume manufacture or use (*i.e.* weaving, sewing, dyeing, pleating, wearing); the field ‘body part’ tells us which part of the body the clothing item covers (head, legs, feet, hands, shoulder, *etc.*) The field ‘age/sex’ shows that the item was worn or used by a man or a woman, a young child or an older person or it was a unisex or universal garment worn by everyone. The field ‘actor’ informs us more precisely – whenever possible – about the identity or the social role of the user (worker, warrior, bride, priest, royalty or undefined). The field ‘circumstance’ shows in which case a clothing item or tool was used (work, wedding, celebration, performance, battle, funeral).

A group of geography specifying fields informs about the places, where costumes, textiles and textile related items, dressed people or actions have been localized. Here the geographical names of regions, countries, towns or villages can be entered, so that the database users will be able to make their research on specific geographical areas. If the users’ search focuses in areas of special interest, it is possible to make targeted queries with a combination of many pre-classified fields, *i.e.* on the kind and names of head covers abundant in a certain area or during a special chronological period, used by a certain social class or under certain circumstances.

Queries can also be made based on bibliographical sources, since entries are accompanied with a full citation leading to the authors or other information sources. A special field informs us about the kind of the source used, *i.e.* lexicon, museum archive, ancient literature, individual research work, so as to enable comparisons, cross references and evaluations.

An ideal terminology collection should contain **pictures**, which illustrate and explain visually the compiled terms. This is unfortunately not possible for many periods in Greek textile history since the

majority of written sources are not illustrated. However, the dictionary should include pictures and visual examples whenever available. This is much easier for archaeological and museological terms and for terms coming from iconographic sources.

### **Application fields**

The term-collection aims at offering knowledge about historical clothing to anyone interested in this topic. There are some areas of historical and technological research though, where it is particularly valuable to use a textile dictionary. The most important among these are the history of costumes, the archaeological research, ethnology, the conservation of historical fabrics and museology.

### **Historical research**

The collection of textile terms can shed light on many aspects of historical research concerning the regional history of clothing production but also on population movements, trading and cultural relations between regions. Through a comparison of terms in different languages, we can trace word movements from one region to another which signify trade and contacts between those countries (*e.g.* fez). Generally speaking words and terms occur in certain places where they remain until they are replaced by new ones coming from new local traditions or via distant influences. In contrast, other textile terms remained unchanged for thousands of years in the Greek language such as the word for loom (*histos*, Greek: ἱστός), wool (*erion*, Greek: ἔριον), flax (*lino*, Greek: λινό) and distaff (Greek: ἡλακάτη).

### **History of arts and crafts**

In the ancient and modern figurative arts we can find images of costumes represented with clarity, sometimes even with many details. These comprise valuable evidence for historical fashion, clothing technology and for the raw materials used but they are also valuable for giving us information about the wearer in his or her historical background. In Greek-speaking regions the main source of information about ancient



costumes can be found on vase painting, sculpture and later in religious iconography and in the fine arts. In all these cases we have images of clothing elements, but not their names, since both ancient and modern iconography have usually only an ideological or decorative character and do not aim at describing the material culture in much detail. Terms fill here the role of imaginary captions missing from the pictorial representations. The search for textile terms based on iconography is a very effective approach for textile research because it makes it possible to compare and verify data (materials, structure, design) by combining names, verbal descriptions and pictures. For example, if we search the name of a male headdress seen on a picture from a historical period and if we know the area of the persons' activity, we can search in the database for male headdresses from this particular period and region and eventually find this word from a textual source.

### Archaeology

The use of accurate textile and costume terminology is of great value for the archaeological record. In the case of ancient civilizations for which we have only limited information, it helps to standardize the terminology of raw materials, manufacturing methods, tools and techniques but also the terminology of fashionable choices and dress codes of the periods under investigation. As the costume design and the fabric technology have not yet been included in academic archaeological training,<sup>15</sup> a common and technical language is needed for descriptions of tools and manufacturing techniques of historical textiles.

### Ethnology

Textile terminology in the field of ethnological studies can illuminate aspects of manufacture and the use of fabrics and garments in various lesser known cultural communities. The nomenclature of clothing often links these activities with other related tasks such as dyeing, tools, the selection of raw materials and the

manufacture of utilitarian objects. Ethnological terms derive from relatively recent periods from which there is ample illustrative and historical evidence, thus through a systematic collection, it is possible to detect and rescue large numbers of textile terms which are becoming extinct or forgotten.

### Conservation

From the perspective of the rescuing strategies of historical and archaeological textiles, both traditional and modern conservation tools and methods can be tried and marked with a special classification code (e.g. COM: conservation material). Moreover, knowledge of ancient or traditional methods supplies ideas for the conservation of old natural materials, which causes less damage to the fibers. By selecting relevant terms, textile conservators may find a wide range of information on the appropriate materials required at every work stage. In the group of terms concerning conservation materials and methods we have so far included so far are also terms for traditional methods for cleaning, treating and repairing of clothing and fabrics.

### Museology

With the aid of a textile term dictionary, museum objects can be recorded by using their authentic names (e.g. we can use the word *ependýtis* and not coat for the traditional overcoat of the Ottoman period or *peplos* and not dress for the specific female dress of the classical period), preferably the original names used during their time and place of use, with a standardised terminology. In this way, costume collections can be supported with the use of accurate information, while they will be, at the same time, able to save old terms. In addition, by using standardized terms, museum recordings can also be operated also by non-fully specialized staff or trainees. During exhibitions, museum curators can use correct and unified terms for the legends and accompanying texts, and in this way they will be able to disseminate accurate information to the public.

15. I would like to mention here the exceptional work of Marina Vrelli Zachou (University of Ioannina) in gathering information on traditional Greek costumes and textile terms in collaboration with the students in the framework of the seminars. Vrelli-Zachou, <http://users.uoi.gr/mvrelli/ergasies/xeirografa-endyamtologikis-laografias.pdf>

## Conclusions

The aim of this ongoing project is to collect Greek costume, textile and related terms from all periods and regions including terms from other languages, which have been integrated into Greek. Beyond the technological and the linguistic part, a textile term dictionary, by tracing the human and social conditions behind the terms, aims to illuminate social aspects of clothing manufacture and dress codes, providing understanding of the society and economy of former periods and cultures in the Eastern Mediterranean. The collection of entries can be a tedious task when terms are scattered in various texts and different kinds of sources, while it becomes much easier and effective when they are grouped together in lists and indexes. This makes the existence of glossaries in every costume publication a valuable vehicle for collecting and evaluating textile related terms.

## Bibliography

- Anstey, H. & T. Weston (1999) *The Anstey Weston Guide to textile Terms*. Frome-London. (2<sup>nd</sup> ed.).
- Burnham, D. (1980) *Warp and weft. Adapted and expanded from the Vocabulary of Technical Terms, 1964, with permission of the Centre International d'Étude des Textiles Anciens*. Toronto.
- Del Freo M., F. Rougement & M.-L. Nosch (2010) The terminology of textiles in the Linear B Tablets, including some considerations on Linear A Logograms and Abbreviations. In C. Michel and M.-L. Nosch (eds.) *Textile Terminologies in the Ancient Near East and Mediterranean from the Third to the First Millennia BC*, 338-373. Ancient Textile Series 8. Oxford.
- Desrosier, S. (2010) Textile Terminologies and Classifications: Some methodological and chronological aspects. In C. Michel & M.-L. Nosch (eds.) *Textile Terminologies in the Ancient Near East and Mediterranean from the Third to the First Millennia BC*, 23-51. Ancient Textile Series 8. Oxford.
- Engelhardt Mathiassen, T. & B. Ringbøl Bitsch (2016) A New Danish Project in Textile Terminology: textilnet.dk. In: S. Lervad, P. Flemestad, L. Weilgaard Christensen (eds.) *Verbal and Nonverbal Representation in Terminology. Proceedings of the TOTh (Theorie et Ontologie: Théories et applications) Workshop 2013, Copenhagen 8 November 2013*, 171-175. Copenhagen.
- Jones, B. (2015) *Ariadne's Threads. The Construction and Significance of clothes in the Aegean Bronze Age*. Aegeum 38. Leuven-Liège.
- Kolonas, L., K. Sarri, Chr. Margariti, I. Vanden Berghe, I. Skals & M.-L. Nosch (in print) Heirs of the Loom: Funerary textiles from Stamna (Aitolia, Greece). A preliminary analysis. In M. Fotiadis, R. Laffineur, Y. Lolos & A. Vlachopoulos (eds.) *Hesperos. The Aegean seen from the West. 6<sup>th</sup> International Aegean Conference, Ioannina, 18-21 May 2016*.
- Kriaras, E. (1968 - 2014) *Dictionary of Medieval Vulgar Greek Literature (1100-1669), I-XIX* (19 Volumes). Online publication: [http://www.greek-language.gr/greekLang/medieval\\_greek/kriaras/index.html](http://www.greek-language.gr/greekLang/medieval_greek/kriaras/index.html)
- Kazazis, I. (ed.) (2001/2003) *Επιτομή του Λεξικού της Μεσαιωνικής Ελληνικής Δημόδους Γραμματείας, 1100-1669 του Εμμανουήλ Κριαρά*.
- Epitome of the Kriaras Dictionary. *The concise Dictionary of Medieval Vulgar Greek Literature (1100-1669), Vol. I-XIV*: [http://www.greek-language.gr/greekLang/medieval\\_greek/kriaras/index.html](http://www.greek-language.gr/greekLang/medieval_greek/kriaras/index.html)
- Nosch, M.-L. (2016) What's in a Name? What's in a Sign? Writing Wool, Scripting Shirts, Lettering Linen, Word-ing Wool, Phrasing Pants, Typing Tunics. In S. Lervad, P. Flemestad, L. Weilgaard Christensen (eds.) *Verbal and Nonverbal Representation in Terminology. Proceedings of the TOTh (Theorie et Ontologie: Théories et applications) 2013 Workshop, Copenhagen 8 November 2013*. 93-115, Copenhagen. Online publication: <https://hal.archives-ouvertes.fr/hal-01354950/document>
- Palmer, T. F. (1929) *Dictionary of technical textile terms (Tri-lingual). Vol. I. English, French, Spanish*, London. <https://archive.org/details/dictionaryoftech00palmrich>
- Papantoniou, I. (1996) *Greek Regional Costumes*. Nafplion.
- Stackelberg, O. M. von. (c. 1828) *Costumes & Usages des Peuples de la Grèce Moderne dessinés sur les lieux par Le Baron O. M. De Stackelberg, Lithographiés par Levilly & Publiés par P. Marino, Editeur de la Collection des Costumes de l'Italie, Rue Montmorency, N<sup>o</sup>. 13. Paris*. Online Publication: Sylvia Ioannou Foundation. Digital library (2016): <http://www.sylviaioannou-foundation.org/digital-library.html?view=book&id=32>
- Vrelli M. (1964/1992) Χειρόγραφα ενδυματολογικής Λαογραφίας Πανεπιστημίου Ιωαννίνων. Συλλογή φοιτητών. Online: <http://users.uoi.gr/mvrelli/ergasies/xei로그ραφα-endyamtologikis-laografias.pdf>

## textilnet.dk – A Toolkit for Terminology Research and Presentation

Susanne Lervad and Tove Engelhardt Mathiassen

Since February 2015, the digital dictionary or term database, [textilnet.dk](http://textilnet.dk), has been accessible on the Internet.<sup>1</sup> The purpose of this paper is to present the background and methods of this pilot project. Since 2010, the project has collaborated with The Danish National Research Foundation's Centre for Textile Research (CTR), University of Copenhagen, and has gained moral support from Sabine Kirchmeier-Andersen, director of *Dansk Sprognavn*, the Danish National Language Advisory Committee.<sup>2</sup> From 2011 to 2015, we have been working with generous funding from the Danish Ministry of Culture. The objective of [textilnet.dk](http://textilnet.dk) is to preserve and communicate the cultural heritage of words and expressions for clothing and textiles in the Danish language. The unique starting points of the project include the collections of handwritten and typewritten files of terms compiled by the Danish textile researchers Erna Lorenzen and Ellen Andersen, quotations from all types of literature from

textile conservator Else Østergård, and photographic slides of 1980s textile samples by textile scholar and ethnologist Ingeborg Cock-Clausen, which provide great illustrative assistance.

### The files of Erna Lorenzen and Ellen Andersen

Dr Erna Lorenzen (1909-2006)<sup>3</sup> was the keeper and curator of the collection of historical dress and textiles in *Den Gamle By* (The Old Town), Danish Open Air Museum of Urban History and Culture<sup>4</sup> from 1959 to 1979. After she passed away in 2006, her files, which were probably collected while she was researching for her doctoral thesis, *Folks Tøj i og omkring Aarhus ca. 1675 - ca. 1850*,<sup>5</sup> were found and brought to *Den Gamle By*. These files have proved to be a true treasure chest for anyone interested in the terminology of different fabrics and textile fibres. Around 900 index cards with words have been thoroughly researched and digitized for [textilnet.dk](http://textilnet.dk).<sup>6</sup>

1. This resource of Danish textile and clothing terminology is available from the address: [www.textilnet.dk](http://www.textilnet.dk)

2. Dansk Sprognavn: <http://www.dsn.dk/> (Accessed December 3, 2014).

3. Erna Lorenzen: <http://www.kvinfo.dk/side/597/bio/1908/> (Accessed December 2, 2014).

4. [www.dengambleby.dk](http://www.dengambleby.dk)

5. Lorenzen, E. (1975) *Folks Tøj i og omkring Aarhus ca. 1675 - ca. 1850*. Aarhus. In English: *Clothes in the Aarhus Area 1675-1850*, it was published with an English summary.

6. The resources used researching the index cards in Erna Lorenzen's files will be placed at the end of this chapter as Appendix 1.



**Fig. 1.** From 2011 to 2014 Birka Ringbøl Bitsch was employed on the *textilnet.dk*-project, starting most of her research with this wooden box containing Erna Lorenzen's collection of terms. Photo: Tove Engelhardt Mathiassen.

From 1936 to 1966, Ellen Andersen (1898-1989)<sup>7</sup> was keeper and curator at the National Museum of Denmark,<sup>8</sup> and, like Erna Lorenzen, had special responsibility for historical dress and textiles. Ellen Andersen's files are kept in the National Museum of Denmark, and her collection is larger (approximately 5,000 index cards) and more diverse than Erna Lorenzen's. Apart from terms for dress and textiles, Ellen Andersen's files contain many index cards with references to literature and other sources, which describe items kept in the National Museum. The index cards, which are not strictly about the definition of concepts, are keyed into Word documents as part of



**Fig. 2.** Dr. Erna Lorenzen. Photo: Karin Munk.

the *textilnet.dk* project but are not currently released in the online version of the database. There is, however, great potential which will hopefully be made available later. The majority of terms for fibres and fabrics in Ellen Andersen's collections are identical with Lorenzen's but Andersen's also focuses on terms for dress and parts of clothing. These number about 150 index cards, which are typed into Word files and made available as quotations in *textilnet.dk*.

### **The history of the ideas behind *textilnet.dk***

In 2004, the project was started by the Danish Costume Group, *Dragtpuljen*,<sup>9</sup> which is a network of researchers into textiles and dress. The core members of the network come from the staff of Danish museums

7. Ellen Dorothea Johanna Andersen: <http://www.kvinfo.dk/side/597/bio/336/origin/170/> (Accessed December 2, 2014).

8. <http://natmus.dk/nationalmuseet/> (Accessed December 3, 2014).

9. Dragtpuljen runs a website: [www.dragt.dk](http://www.dragt.dk). The network was founded in 1985.



**Fig. 3.** Ellen Andersen. Photo: The National Museum of Denmark.

working with collections of dress and textiles, broadly speaking, as keepers, curators, conservators and also keen individuals who, without any formal academic training, have taken special responsibility for collections in smaller museums.<sup>10</sup> The work in *Dragtpuljen* is organized into small groups, each with special interests, and projects that unite the members. The group defining the project, which later became *textilnet.dk*, quickly – and boldly – agreed in 2004 that the future user groups of *textilnet.dk* would be the curators and registrars of museums and researchers who, for various reasons, need more knowledge of textile and clothing concepts/terms, as well as linguists and the general public. Languages change in daily life. Politics and culture change through time. By preserving words in a database, we keep in touch with our own history, craft and art. For instance, we can read the fairytales of H. C. Andersen and all other written sources with terminology about clothing and fabrics

with an improved understanding. Danish serves a small language area but this project is nevertheless founded on the conviction that it is of the greatest importance to preserve terms – particularly those that are no longer in use. The group's work started many discussions about classification. We agreed on four main categories of concepts:

1. Textiles and the different techniques to produce them.
2. Dress and all of their different parts.
3. Decorations and the techniques to produce decoration.
4. Colours, dyes and techniques to produce colour and dye.

Expressions and quotations from Danish literature with connotations of dress and textiles are noted in the database when they prove enlightening. The collection of quotations from 18<sup>th</sup>-century newspapers and 19<sup>th</sup>-century literature by Østergård is a unique resource in this context. These quotations are very helpful in understanding the use of certain textiles and clothing in their specific social environment.<sup>11</sup>

The fifth section is related to terms and expressions of fashions and styles. None of the collections of terms, which are included in *textilnet.dk* at this stage, contain examples of fashion/style which, for instance, would be termed *punk* and *hip hop*. It is hoped that these terms will be included later. At the moment, expressions and idioms with references to terms of dress and textiles are included when present in the sources used. Lorenzen's 900 index cards with terms primarily for fabrics and fibres were methodically researched in the handwritten files of the Danish lexicographer Mathias Moth from the 17<sup>th</sup> century. These were also made available online during the work of *textilnet.dk*.<sup>12</sup> These terms for fabrics and textile fibres are also researched in a selection of scientific literature, dictionaries and other handbooks – up to 10 sources per concept are listed (*Appendix 1*).

10. From the late 1990s to 2013 the network received financial support from the Danish Ministry of Culture and opened up to members from universities and other research and educational institutions. List of members: <http://www.dragt.dk/medlemmer/> (Accessed December 3, 2014).

11. Else Østergård was appointed conservator at the National Museum of Denmark in 1958.

12. Moth's dictionary available due to another Danish digitalizing project: <https://dsl.dk/sprog/ordbog-og-sprogteknologi/moths-ordbog> (Accessed December 10, 2014).

### Termbase: Media wiki

The group of scholars also undertook a review of database systems before choosing the Media Wiki system. We chose it for several reasons. First, the Wiki data structure format is familiar to everyone using the Internet. Secondly, the Media Wiki system is updated regularly. As mentioned above, the group has good support from the director of the *Dansk Sprognævn*, Sabine Kirchmeier-Andersen, who stresses the importance of regularly updating the systems. It would be inefficient in both research time and funding, if the group used a system, which, after a few years became obsolete. Thirdly, data can be exported into other systems from Media Wiki and be combined in new and informative ways. We also have contact with Professor Bolette Sandford Pedersen<sup>13</sup> at the University of Copenhagen, who in 2004-2008, worked with DanNet, a digital platform for presenting words, terminology and relations between words. In the future, *textilnet.dk* will be a source of concepts/terms for other databases and terminology projects, such as DanNet.

### The conceptual structure of *textilnet.dk*

Textile terminology work is based on an analysis and structuring of concepts and the relations between them.<sup>14</sup> The concept of textile/clothing is the basic element of our work in *textilnet.dk* and the way we order and transfer knowledge. When we think of textile concepts, such as a fibre, we choose a number of properties in order to characterize the concept. The fibre is a material and also used to form a textile structure, such as a basic weave. The properties of the objects are abstractions and characteristics, which form the concepts. In *textilnet.dk* we have concepts connected to single specific objects - individual concepts such as 'siamhamp' and 'bielefelderlærred' and more general concepts as fibre and weave. Characteristics such as form, function, and origin correspond to the properties of the objects, many of which are very

common and are not suitable for identifying a concept. The characteristics that we represent in *textilnet.dk* are the delimiting characteristics that differentiate one concept from others. Concepts are abstractions or mental units and we need definitions and terms to express them. The core of our work – the definitions – are the descriptions of the concept, while the terms are the expressions we use when we refer to the concepts. The terms consist of either verbal elements, such as words, or nonverbal elements such as symbols or drawings.

In order to take the very high number of term variants into account in *textilnet.dk*, each concept is represented by a definition, an explanation, an illustration whenever possible, references, and a link to other languages. Every concept is represented by the following data format: term, variant(s), languages, definition, explanation and bibliographic reference. If the user searches for information about the fibre 'abaca' from the category: material, the following variants appear: 'Abacca', 'abaka', 'banantrævler', 'manila', 'manilahamp', 'menadohamp' and 'siamhamp'.<sup>15</sup>

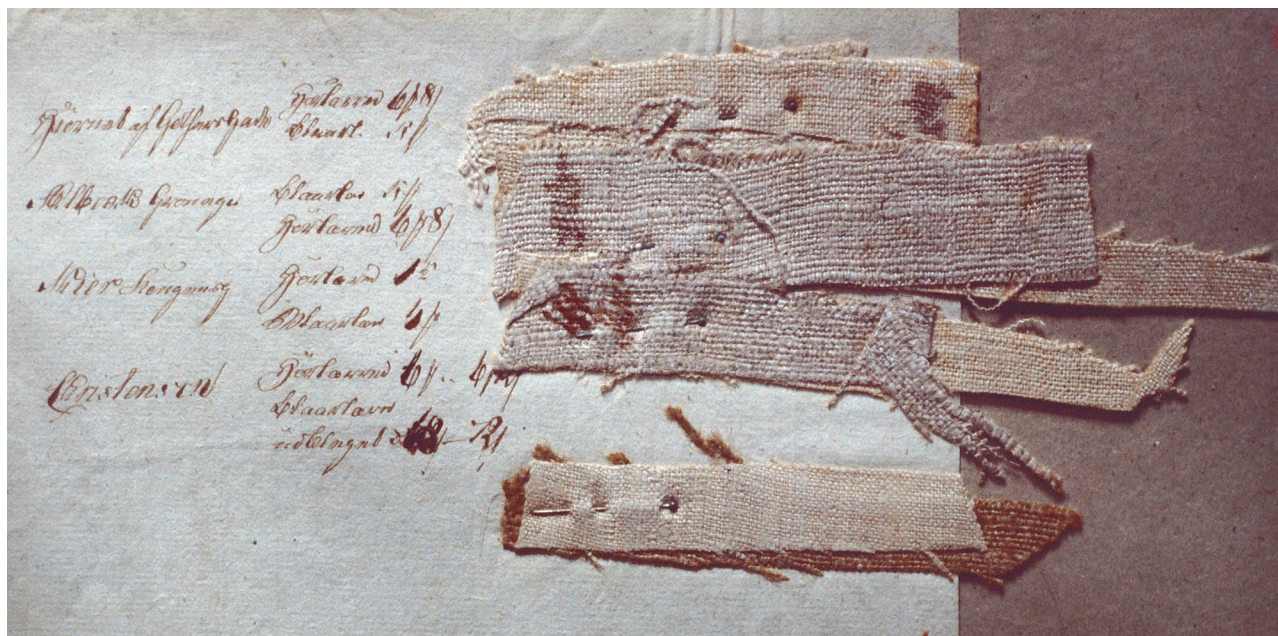
The term variants of 'abaca' are simple orthographic variants such as different spellings of the same term, as well as more specific knowledge about the concept, for example, the origins of the fibre abaca ('siamhamp') and the resemblance of the fibre ('banantrævler'). The characteristics of the concepts such as the form and the geographic origins are thus reflected by different verbal representations, and the knowledge about the generic aspects of the concept of plant fibre (hemp and banana) is transparent for any user of *textilnet.dk* in order to transmit the knowledge of the subject field, which one single standardized term might not give. To give another example: the numerous variants in the term base for the concept of the technique of the basic 'tabby weave' are provided this way: Term: 'lærred' (Tabby) Variants: lærret, læret, lærept, lerredt, læith, lærth, lerudth, lærft, En.: Linen. (Juil 1807, 'Lærred') Germ.: Leinvand. (Juil 1807, 'Lærred') Fr.: Toile. (Juil 1807, 'Lærred'), Definition: Textile .... Basic weave of tabby.<sup>16</sup>

13. Bolette Sandford Pedersen: [http://research.ku.dk/search/?pure=en%2Fpersons%2Fbolette-sandford-pedersen\(d70a3b44-d3ab-4259-a0aa-17d84d3d7de5\).html](http://research.ku.dk/search/?pure=en%2Fpersons%2Fbolette-sandford-pedersen(d70a3b44-d3ab-4259-a0aa-17d84d3d7de5).html) (Accessed December 11, 2014).

14. Guide to terminology, NORDTERM 8 p. 9.

15. Abaca <http://www.textilnet.dk/index.php?title=abaca> (Accessed December 12, 2014).

16. *textilnet.dk* (Accessed December 12, 2014).



**Fig. 4.** Samples of tow and linen tabby woven 1816 in *Trinitatis Sogns Arbejdshus*, an institution established 1794 for poor women. The samples were sent to the Poor-Law authorities. Photo: Ingeborg Cock-Clausen.

Other term variants in the term base such as ‘lærred’ are ‘agenois-lærred’, ‘bengalsklærred’, ‘bielefelderlærred’, ‘bocklærred’ reflect the origins of the fabric, which is produced in Agenois, Bielefeld etc. In this way, we can keep track of different concepts of a weave and a final product of the basic tabby weave, different origins, orthographic variants, and the integration of French and German terms in our material. Researchers in both ancient and modern textile studies need to understand both generic and specific concepts and their relevant terminology in order to share understanding in a common language across times and cultures. Our goal is to share concepts, language and associated cultural ideas, and not to standardize the terms. Another very important concept from our chosen time period is silk, which is represented by the following variants: ‘Silke’, ‘silky’, ‘silchæ’, ‘silki’ and eight variants in *textilnet.dk* if you search the term: ‘floretilsilke’, ‘floretilsilke’, ‘fleuretilsilke’, ‘floktilsilke’, ‘flokssilke’, ‘flossilke’, ‘chappesilke’, ‘schappesilke’.<sup>17</sup>

#### *Examples from [textilnet.dk](http://www.textilnet.dk)*

Three concepts/terms are presented here to exemplify how *textilnet.dk* could be a toolkit for other terminology projects. Every concept in *textilnet.dk* will be worked up in the seven categories mentioned above, whenever possible from the current sources. The first category is variants, which are very important from linguistic and historical perspectives. The next is language, when it is relevant for understanding the concept, and when this information is available in our current sources (Appendix 1). The third and most important category is the definition, which expresses the condensed analysis of the concept. Language and terms change their meanings over time so whenever possible, the relevant date/time from the available sources is the next category. The sources in which the time aspect existed are also listed. The fifth category is explanation. This category is usually somewhat longer than the definition, the latter being the condensed result of our work. The next and very important point is the quotation, which is an excellent way to place terms

17. Floretilsilke :[http://www.textilnet.dk\(index.php?title=Floretilsilke\)](http://www.textilnet.dk(index.php?title=Floretilsilke) (Accessed December 12, 2014).

for fabrics and clothing in their original social setting. Just one example of the quotations will be given here as most of the language is in very old-fashioned Danish, which is difficult to translate into English.<sup>18</sup> The last of the seven categories is the sources, and, as an extra service for the user groups of *textilnet.dk* up till 2017, we have also noted in which of our sources the concept/term is not mentioned.

The first example is the term *angoriskekamelotter*,<sup>19</sup> which is chosen to show the interrelations of the concept variants in *textilnet.dk*. The variants are *angorinsk kamelot* (singular) and *angoriske kamelotter* (plural). The variants illustrate the way *textilnet.dk* links the pages from every concept/term in the main section, where the terms are listed alphabetically. Alternatively, a user can make an open search of a term and will see every mention of it in the entire database. The category for language is empty in this example because it is only used when the relevant information is available in the current sources. This presents great opportunities for collaboration. A goal of the presentation of this toolkit is to inspire the use of the system for other digital dictionaries (for example, a *textilnet.nl*, a *textilnet.uk*, a *textilnet.it*) with all the possibilities of comparative research, which would be the outcome of interrelated databases of terms. The definition of *angoriske kamelotter* is: “Textiles woven of Angora goatshair (see mohair), are described as fine and light, can be moiré (see moiré). Produced in Turkey and especially used for women’s clothes.” This definition gives information about geography (Turkey), textile fibres (Angora goatshair) and fabrication techniques such as the weave (but not the exact method) and finishing, *i.e.* moiré, quality of the fabric (fine and light) and common use of the fabric (women’s clothing). The time category tells us that in addition to its inclusion in Lorenzen’s files, this term

was mentioned in two Danish encyclopedias for merchandise, namely Juul dated 1807 and Rawert dated 1831. The source category tells us that the term was neither mentioned in sources dated before 1807, nor in the sources dated after 1831, and not in any other contemporary sources.

Apart from the references to *mohair* and *moiré*, the category of explanation for *angoriske kamelotter* guides the user further by linking to the term *kamelot*.<sup>20</sup> This concept/term has nine variants: *kamelot*, *camelot*, *kamlot*, *kammelot*, *kamelet*, *kamelotz*, *samelot*, *shamlot* and unsurprisingly, *angoriske kamelotter*. The language category presents the English term *camblet* with reference to Rawert 1831 and the French term *camelot* and its Old French variants: *camel*, *chamel* and *kamel*. The definition says: “Textile, originally woven of camel yarn [this term is blue with underscore which in the Media Wiki system indicates that the user can link directly to *camel yarn*], spun from hair of the Angora goat (*cf.* mohair [blue with underscore]), eventually mixed with silk. Normally woven in a weave with two shafts (see [weaving techniques](#) [this term is red with an underscore showing the user that the term will be incorporated in *textilnet.dk* at a later stage]). Later also woven in different mixtures of camel yarn, cotton yarn, silk yarn and linen yarn. Mixed yarns are also found. From the beginning of the 19<sup>th</sup> century it gradually became more common to use sheep’s wool instead of [camel yarn](#) [blue with underscore]. At first produced in Angora (Ankara, Turkey), and later in many places in Western Europe. *Cf.* [angoriske kamelotter](#) [blue with underscore].”

The definition for *kamelot* is much more comprehensive and precise than the definition for *angoriske kamelotter*, particularly concerning the fibres used for these fabrics. The user has the opportunity to read the explanation category to understand this complexity.

18. This quotation stems from the files collected by Else Østergård: “1795. Kappe. Onsdagen den 5 August, om Morgenen Kl. 9, indsneg sig et Fruentimmer i Gaarden No 56 i Store Kongensgade, var høj og smækker, klæd i lys Kattunstrøie og Skiørt, et trykket Tørklæde om Halsen og en hvid Kappe paa Hovedet, med en liden rød Hue under; ved hendes Bortgang savnes ---- Adresseavisen, Tirsdagen den 11 August 1795.” This passage was printed in the Danish newspaper *Adresseavisen*, August 11, 1795 and it describes the looks and the clothing of a female thief: “1795. Cap. Wednesday August 5 at 9 o’clock in the morning a woman stole into the Yard of No 56 in Store Kongensgade [a street which still exists in Copenhagen], [she] was tall and slim, clad in a light Jacket and Skirt of Calico, a printed Scarf around her Neck and a white Cap on her Head, with a small red Cap underneath; at her Departure [the following] is missing.”

19. Angoriske kamelotter: [http://www.textilnet.dk/index.php?title=Angoriske\\_kamelotter](http://www.textilnet.dk/index.php?title=Angoriske_kamelotter) (Accessed December 12, 2014).

20. Kamelot: <http://www.textilnet.dk/index.php?title=Kamelot> (Accessed December 13, 2014).



The explanation refers to Juul 1807, Rawert 1831 and *Ordbog over det Danske Sprog* 1927. Juul explains that most of these fabrics were purple and of a much higher quality than fabrics produced in what he calls Europe *i.e.* Western Europe at the time. Only a small proportion was originally exported from Turkey. Then, he discusses the first places where these fabrics were copied – in specific towns in France, Belgium and the Netherlands – and how the camel yarn, cotton yarn and silk yarns were mixed for the *kamelots*. He also explains what kind of techniques were used to decorate the fabric after weaving and that producers in 1807 had to compete against English and German producers. In 1831, Rawert explains the use of sheep's wool, specifically good worsted, for the *kamelots*. The best of these were mixed with silk from Piedmont in Italy. Not until 1927 is the use of linen yarn mentioned. In this way, the *textilnet.dk* user is offered a clear understanding of how these fabrics and the term *kamelot* changed over time.

The second short example is the term *amabouck*.<sup>21</sup> The definition is: "Textile, linen [blue with underscore, which indicates that the user can get access to the complexity of the meanings of this concept as both weaving technique and fibres mentioned above]. Described as coarse and half bleached (see bleaching [red with underscore indicating that the term will be incorporated in *textilnet.dk* at a later stage]). Produced in England. Used for clothing and for sacks and wrapping." The explanation gives the user insight into how the same coarse fabric could be used as clothing and wrapping. Juul (1807) explains that *amabouck* was used for clothing slaves and sailors and for the other wrapping purposes. This example shows that textiles are highly illustrative of social history: the same coarse fabric was suitable for protective wrapping and clothing specific people. *Textilnet.dk* provides many such insights into social history.

### *Illustrations of the concepts in textilnet.dk*

Whenever possible relevant illustrations are included too. The non-verbal representation of concepts is an

important contribution to the database. Many elements of the concepts, such as the complexity of a weave, are easier to understand in illustrations than in words. Cock-Clausen's collection of slides from the 1980s are now in the library of the Design Museum Denmark. She photographed textile samples in Danish museums and archives and many of these photographs serve as excellent illustrations for *textilnet.dk*. The best slides show a textile sample with information about terms, dates and places of production. They give users a unique opportunity to understand the quality and social context of the term in question. Other types of illustrations (for example, diagrams and drawings) help the explanation of complex weaves such as satins. Different relationships between concepts can be represented by the illustrations in addition to the hyperlinks between the definition and other explanatory fields. The relations are either part of relations – if the concept is part of a whole as, for instance a heddle is a part of a loom, or generic relations as, for instance 'a type of' relation: twill is a 'type of' a basic weave as is satin and tabby. A *chaîne opératoire* is very important when textile techniques are illustrated, and we need to record and relate the concepts for preparing the loom such as warping, beaming, and heddling. These temporal relations or associative relations are also seen in the production of the yarns by combing, carding and twisting procedures, for instance. The designations and the terms are only verbal translations-transmissions of the meanings shortened forms of the definition, and a possible definition of a fibre might also be a chemical formula as shown in ISO standards, which could be included at a later stage of the project.

### **Perspectives**

With the release of *textilnet.dk*, we hope to have established a useful tool for many different user groups, and *textilnet.dk* could be a stepping-stone to a variety of international and multilingual projects which in tandem with *textilnet.dk* could communicate about the terminology of textiles from different time periods and be the foundation of comparative studies.

21. Amabouck: <http://www.textilnet.dk/index.php?title=Amabouck> (Accessed December 11, 2014).



**Fig. 5.** The group behind the *textilnet.dk*-project in 2013. From left: Else Østergård (conservator at The National Museum of Denmark), Kirsten Toftegaard (curator at Designmuseum Denmark), Birka Ringbøl Bitsch (employed in Den Gamle By at the *textilnet.dk*-project), Tove Engelhardt Mathiassen (curator at Den Gamle By and project leader of the *textilnet.dk* project), Maj Ringgaard (conservator at the National Museum of Denmark), Susanne Lervad (terminologist, visiting scholar, CTR), Anne Hedeager Krag (freelance researcher) and Inge-Margrethe Davidsen (retired registrar). Textile researcher Ingeborg Cock-Clausen was not present at the time.

The use of a wiki model makes it possible to link to other projects in the field of terminology to transfer knowledge and definitions, for instance, by the means of open and linked data in the Semantic Web. Many other classified multilingual cultural heritage databases all over the world are linked together and are accessible in open data forms for very big research

and museum institutions, such as the Getty Museum in Los Angeles, are front-runners who have already presented multilingual thesauri – the Getty vocabularies.<sup>22</sup> As mentioned in this article, XML formats and wikis have been the guidelines for our terminology work of *textilnet.dk* in order to exchange data from other resources. The next phase of *textilnet*.

22. <http://www.getty.edu/research/tools/vocabularies> (Accessed 1-12-2014). *What is cinnabar? What is a rhyton?* The Getty vocabularies contain structured terminology for art, architecture, decorative arts and other material culture, archival materials, visual surrogates, and bibliographic materials. Compliant with international standards, they provide authoritative information for catalogers and researchers, and can be used to enhance access to databases and Web sites. The Getty Vocabularies grow through contributions. The vocabulary data is available for licensing and accessible free of charge below for more limited online use.

dk will need to link data to concepts and have common dynamics tools jointly maintained by the communities of users and not static authorities. We hope to be able to link to multilingual thesauri of this kind in order to transmit knowledge about textile concepts for education and training in the future. Feedback on the current *textilnet.dk* is welcome at [textilnet.dk@dengambleby.dk](mailto:textilnet.dk@dengambleby.dk). This is only the first step – our goal is to provide a worldwide web of interlinked resources for textile terminologies.

### Acknowledgements

The project *textilnet.dk* has been generously funded by:

HM Queen Margrethe's and HRH Prince  
Henrik's Foundation  
HM King Frederik and HRH Queen Ingrid's  
Foundation  
The Augustinus Foundation  
The Farumgaard Foundation  
The Danish Ministry of Culture  
Termplus Aps  
Den Gamle By, The Old Town, Danish Open Air  
Museum of Urban History and Culture

to whom we wish to express our grateful thanks.

### Bibliography

- Bitsch, B. & Mathiasen, T. Engelhardt (2016) A New Danish Project in Textile Terminology . *textilnet.dk*. In S. Lervad *et al.* (eds.) *Verbal and nonverbal representation in terminology, Proceedings from the Toth 2013 workshop*, Centre for Textile Research, Copenhagen, 171-177, 2016-12-18. Digital version: ISBN: 979-10-95973-00-3; <https://hal.archives-ouvertes.fr/hal-01354950v1>
- Dury, P. & Lervad, S. (2010) Synonymic Variation in the Field of Textile Terminology: A study in diachrony. In C. Michel & M.-L. Nosch (eds.) *Textile Terminologies in the Ancient Near East and the Mediterranean Area from the Third to the First millennia BC*, 1-10, Ancient Textiles Series 8, Oxford.
- Dury, P., Lervad, S. & Nosch, M.-L. (2011) Verbal and non-verbal configurations of textiles : a diachronic study. In C. Roche (ed) *Proceedings Toth, Terminologie et Ontologies: Théories et Applications*, 201-220, Annecy 2011.
- Suonuuti, H. (1997) *Guide to Terminology*, NORDTERM 8, Tekniikan SANAstokeskus, Helsinki

### Appendix I

#### *Resources used in researching the terms for textilnet.dk*

- Andersen, Ellen: "Anna Sophies dragter". I *Dronning Anna Sophie. Festskrift til Lehnsbaron H. Berner Schilden Holsten i anledning af hans 70 års dag 18. juli 1951*. Kbh. 1951, s. 131-148, [Andersen 1951].
- Andersen, Ellen: *Danske bønders klædedragt*. Kbh.: Carit Andersens Forlag, 1960, [Andersen 1960].
- Andersen, Ellen: *Danske dragter. Moden i 1700-årene*. Kbh.: Nationalmuseet, 1977, [Andersen 1977].
- Andersen, Ellen: *Danske dragter. Moden 1790-1840*. Kbh.: Nyt Nordisk Forlag Arnold Busck, 1986, [Andersen 1986].
- Andersen, Ellen: Seddelkartotek. Opbevares på Nationalmuseet, [Andersen kartotek].
- Bech, Viben: *Danske dragter. Moden 1840-1890*. Kbh.: Nyt Nordisk Forlag Arnold Busck, 1989, [Bech 1989].
- Berlingske Haandarbejdsbog*. Ellen Andersen, Gertie Wandel og T. Vogel-Jørgensen (eds.). Bd. 1-3. Kbh.: BerlingskeForlag, 1943-44, [BHB].
- Bohn, Gottfried Christian og Gerhard Philipp Heinrich Norrmann: *Waarenlager, oder Wörterbuch der Produkten- und Warenkunde. Des Wohlerfahrenen Kaufmanns zweyte Abtheilung*. Bd. 1-2. Hamburg: C. E. Bohn, 1805-1806. <http://books.google.dk> (accessed August 2012 – June 2013), [Bohn 1805].
- Bonniers Store Håndarbejdsleksikon*. Bd. 1 – 20. Kbh.:BonniersBøger A/S, 1995, [BSHL].
- Christensen, Sigrid Flamand: *Kongedragterne fra 17. Og 18. Århundrede*. Bd. 1-2. Kbh.: Egmont H. Petersens kgl. Hof-Bogtrykkeri, 1940, [Christensen 1940].
- Cock-Clausen, Ingeborg: *Tekstilprøver fra danske arkiver og museer, 1750-1975*. Kbh.: Borgen, 1987, [Cock-Clausen 1987].
- Den Danske Ordbog, Moderne dansk sprog*. <http://ordnet.dk/ddo> (accessed 2014), [DDO].
- Den Store Danske Encyklopædi*. Bd. 1-20. Danmarks Nationalleksikon A/S, 1994-2001, [DSDE].
- Den store danske, Gyldendals åbne encyklopædi*. <http://www.denstoredanske.dk/> (accessed 2014), [DSD].
- Encyclopedia of clothing and fashion*. Valerie Steele (eds.). Bd. 1-3. USA: Thomson Gale, 2005, [ECF].
- Gyldendals røde ordbøger. Dansk-fransk*. 6. udg. Kbh.: Gyldendalske Boghandel, Nordisk Forlag A/S, 1997, [GRO dansk-fransk]
- Henningens, Ingeborg Mule: *Væverens ABC*. Lyngø: Bogans Forlag, 1995, [Henningens 1995].
- Henschen, Ingegerd: *Kattuntryck. Svenskttygtryck 1720-1850*. Laholm: Nordiska Museets Förlag, 1992, [Henschen 1992].

- Jensen, Jørgen: *Danmarks Oldtid*. 2. udg. Bd. 1-4. Kbh.: Gyldendal, 2006, [Jensen 2006].
- Jespersen, Gunnar: *Klæde og kalemanke, på sporet af det glemte rokokotøj*. Herning: Poul Kristensens Forlag, 1979, [Jespersen 1979].
- Juul, Bruun: *Naturhistorisk, oekonomisk og teknologisk Handels- og Varelexikon*. Bd. 1-3. Kbh.: A. og S. Soldsins Forlag, 1807-12, [Juul 1807].
- Kalkar, Otto: *Ordbog til det ældre danske Sprog (1300-1700)*. Bd. 1-4. Kbh. 1881-1907. <http://www.hist.uib.no/kalkar/> (accessed 2011-2013), [OTDS].
- Kulturhistorisk leksikon for nordisk middelalder, fra vikingetid til reformationstid*. Bd. 1- 22. Kbh: Rosenkilde og Bagger, 1956-78, [KLNLM].
- Lorenzen, Erna: *Folks tøj i og omkring Århus 1675-1850*. Aarhus: Universitetsforlaget, 1975, [Lorenzen 1975].
- Lorenzen, Erna: Seddelkartotek. Opbevares i Den Gamle By, [Lorenzen kartotek].
- Lundell, Laila: *Forums store vævebog*. Forum, 1978, [Lundell 1978].
- Meyer, Karl: *Almindeligt, Illustreret Vareleksikon*. 4. udg. Kbh.: H. Aschehoug & Co. 1924, [Meyer 1924].
- Modeleksikon. Fra couture til kaos*. Mads Nørgaard (eds.). Politikens Forlag A/S, 2002, [Modeleks.].
- Montgomery, Florence M.: *Textiles in America 1650-1870*. New York: W. W. Norton & Company, 2007, [Montgomery 2007].
- Moth, Matthias: Håndskrevet ordbog, opbevares på Det Kgl. Bibliotek. Udarbejdet i perioden ca. 1686 -1719. Digitaliseret version: <http://mothsordbog.dk/> (accessed 2013-2014), [Moth].
- Møller, Mogens Birger: *Tekstilhåndbogen*. Borgen, 1983, [THB].
- Nudansk Ordbog*. 11. udg. Kbh.: Politikens Forlag A/S, 1982, [NuO].
- Nyrop, Camillus: *Danske Farvere; En historisk Udsigt ved De Goldschmidtske Fabrikers Hundreedaars Jubilæum*. Kbh. 1900, [Nyrop 1900].
- Ordbog over det danske Sprog, historisk ordbog 1700-1950*. Bd. 1-28, 1919-54; supplementsbind 29-33, 1992 - 2005. <http://ordnet.dk/ods> (accessed 2011-2013), [ODS].
- Østergaard, Else: Seddelkartotek. Opbevares på Nationalmuseets [Østergård kartotek].
- Rawert, Ole Jørgen: *Almindeligt Varelexicon*. Bd. 1-2. Kbh.: V. F. Soldenfeldt, 1831-34, [Rawert 1831].
- Rawert, Ole Jørgen: *Kongeriget Danmarks industrielle forhold: Fra de ældste tider indtil begyndelsen af 1848*. Fotografisk optryk af 1. udg. fra 1850. Forlaget Skippershoved, 1992, [Rawert 1992].
- Retskrivningsordbogen*. Udgivet af Dansk Sprognævn. 3. udg. Kbh.: Alinea – Aschehoug Dansk Forlag A/S, 2001, [Retskrivningsordbogen 2001].
- Riello, Giorgio: *Cotton, The fabric that made the modern world*. Cambridge: Cambridge University Press, 2013, [Riello 2013].
- Salmonsens Konversationsleksikon*. Chr. Blangstrup (eds.). 2. udg. Bd. 1-26. Kbh.: A/S J. H. Schultz Forlagsboghandel, 1915-1930, [Salmonsens].
- Sandberg, Gösta: *Purpur koschenillkrapp. En bok om rödatextilier*. Stockholm: Tidens förlag, 1994, [Sandberg 1994].
- Skougaard, Mette og Helle Thordur Hansen: *Uld og hør: Tekstilfremstilling i 1800-tallets bondesamfund*. Kbh.: Nationalmuseet, 1992, [Skougaard 1992].
- Sterm, Poul: *Textil, praktisk varekundskab: metervarer*. Kbh.: Jul. Gjellerups Forlag, 1937, [Sterm 1937].
- Suonuuti, Heidi: *Guide to Terminology*, Helsinki, NORD-TERM 8, TekniikanSANAstokeskus, 1997
- 1700-tals tekstil. Anders Berchs samling i Nordiska Museet*. Elisabet Stavenow-Hidemark. Stockholm: Nordiska Museets förlag, 1990. [Berchs samling]
- Textilbogen, Haandbog i textil varekundskab*. Poul Sterm (eds.). Bd. 1-2. Kbh.: Westermanns Forlag, 1946, [Textilbogen 1946].
- Textilbogen, Haandbog i textil varekundskab*. Poul Sterm (eds.). Bd. 1-2. Kbh.: Martins Forlag, 1961, [Textilbogen 1961].
- Textile Terminologies in the Ancient Near East and Mediterranean Area from the third to the first millennia BC*, Edited by C. Michel and M.-L. Nosch, Ancient Textile Series 8, Oxford.
- Wikipedia (de.), <http://dewikipedia.org> (anvendt 25-08-2014), [Wikipedia de.]

