



**HAL**  
open science

## Hull structure

Giulia Boetto, Sabrina Marlier, Irena Radic Rossi

► **To cite this version:**

Giulia Boetto, Sabrina Marlier, Irena Radic Rossi. Hull structure. I. Radic Rossi; G. Boetto. PAKOŠ-TANE VELI SKOLI - Kasnoantički brodolom u geološko-geografskom i kulturnopovijesnom kontekstu / The Late Roman shipwreck in its geological-geographic and culturalhistorical context, Sveuciliste u Zadru; Institut za pomorsku bastinu ARS NAUTICA, pp.47-68, 2018, 987-953-331-190-6. halshs-01978904

**HAL Id: halshs-01978904**

**<https://shs.hal.science/halshs-01978904>**

Submitted on 23 Jan 2019

**HAL** is a multi-disciplinary open access archive for the deposit and dissemination of scientific research documents, whether they are published or not. The documents may come from teaching and research institutions in France or abroad, or from public or private research centers.

L'archive ouverte pluridisciplinaire **HAL**, est destinée au dépôt et à la diffusion de documents scientifiques de niveau recherche, publiés ou non, émanant des établissements d'enseignement et de recherche français ou étrangers, des laboratoires publics ou privés.

Uredile / Edited by  
Irena Radić Rossi – Giulia Boetto

# PAKOŠTANE VELI ŠKOLJ

---

Kasnoantički brodolom u geološko-geografskom  
i kulturno-povijesnom kontekstu

The Late Roman shipwreck in its geological-geographic  
and cultural-historical context



·ARS·  
NAUTICA  
INSTITUTE FOR  
MARITIME HERITAGE

IZDAVAČ / PUBLISHER  
Sveučilište u Zadru  
Institut za pomorsku baštinu ARS NAUTICA

ZA IZDAVAČE / FOR THE PUBLISHERS  
Dijana Vican  
Mirko Čepo

Biblioteka: Arheologija jadranske plovidbe i brodogradnje  
Series: Archaeology of Adriatic Shipbuilding and Seafaring

Knjiga 1 / Book 1

UREDILE / EDITED BY  
Irena Radić Rossi  
Giulia Boetto

LEKTURA HRVATSKOG TEKSTA / COPY-EDITING OF THE TEXT IN CROATIAN  
Ivana Šavuk, Lidija Vešligaj

PRIJEVOD NA ENGLISKI JEZIK / TRANSLATION INTO ENGLISH  
Tanja Tomaš  
Edo Bosnar  
Koraljka Bakrač (tekst / text by V. Andrieu-Ponel)

RECENZENTI / REVIEWERS  
Nenad Cambi  
Marie-Brigitte Carre  
Damir Magaš

GRAFIČKO OBLIKOVANJE / GRAPHIC DESIGN  
Gordana Žagar  
Ante Filipović Grčić (korice / cover)

TISAK / PRINT  
Tiskara Zelina d.d.

NAKLADA / PRINT RUN  
500

IZDAVANJE OVE KNJIGE NOVČANO SU POMOGLI /  
PUBLICATION OF THIS BOOK WAS FINANCIALLY SUPPORTED BY  
Hrvatska zaklada za znanost / Croatian Science Foundation (Projekt / Project AdriaS, IP-09-2014-8211)  
Općina Pakoštane / Municipality of Pakoštane  
Aix Marseille Univ, CNRS, Minist Culture, CCJ, Centre Camille Jullian, Aix-en-Provence, France

CIP-Katalogizacija u publikaciji / CIP-Cataloging in Publication  
Znanstvena knjižnica Zadar / The Scientific Library of Zadar  
CIP zapis dostupan u računalnom katalogu Znanstvene knjižnice Zadar pod brojem 150926092.  
ISBN 1: 978-953-331-190-6  
ISBN 2: 978-953-59782-1-3

## BRODSKA KONSTRUKCIJA

### HULL STRUCTURE

#### OBLIK BRODA I STANJE OČUVANOSTI

Brod se očuvao u duljini od oko 11 m i najvećoj širini od oko 7 m. U sredini se nalazi pukotina širine 0,3 m u južnom do 1 m u sjevernom dijelu, koja odgovara položaju kobilice i orijentirana je u pravcu sjeverozapad – jugoistok. Očuvani dio broda zapadno od osi kobilice dug je 9 m i širok 2,7 m, a dio istočno od osi kobilice slomljen je u dva dijela, najveće duljine 7 m i sveukupne širine 3,5 m (Sl. 46).

Kao što je rečeno, ostatci broda leže izravno na matičnoj stijeni, potpuno raspadnuti i spljošteni, bez traga originalnog zakrivljenja. Brodski je trup bio vjerojatno zaravnjenoga dna s blagim uzvojem ispod donje bokoštitnice (Sl. 47).

Među očuvanim dijelovima broskog korita ne nalazi se niti jedan element koji pripada uzdužnoj osi broda (kobilica, pramčana i krmena statva, pete pramčane i krmene statve).

#### SHAPE OF THE SHIP AND ITS CONDITION

The ship has been preserved in a length of approximately 11 m and a maximum width of approximately 7 m. There is a gap in the middle that is 0.3 m wide in the southern, and 1 m wide in the northern section. It corresponds to the position of the keel, and it has a north-west/south-east orientation. The preserved part of the ship west of the keel axis is 9 m long and 2.7 m wide. The eastern section is broken into two parts of the maximum length of 7 m, and a total width of 3.5 m (Fig. 46).

As stated, the hull remains lie directly on the bedrock, entirely broken apart and flattened, without traces of the original curvature. The hull probably had a flat bottom with a gentle turn of the bilge perceivable from the shape of a frame on the eastern side, below the lower wale (Fig. 47).



Sl. 48 Dijelovi rebara i ulomak unutrašnje oplate izmaknuti iz originalnog položaja, u jugoistočnom dijelu nalazišta (foto: Ph. Groscaux).

Fig. 48 Displaced fragments of frames and ceiling in the south-eastern area (photo: Ph. Groscaux).





Sl. 49 Rebra oštećena djelovanjem brodskog crva, u sjeveroistočnom dijelu nalazišta (photo: Ph. Groscaux).

Fig. 49 Frames damaged by shipworms in the north-eastern area (photo: Ph. Groscaux).

Očuvani dio brodske oplate sastoji se od 109 platica u 34 voja, od kojih se 56 platica u 14 vojeva nalazi u zapadnom dijelu, a 53 platice u 20 vojeva u istočnom dijelu brodske konstrukcije. Voj 19 odgovara niskoj bokoštini<sup>24</sup>.

Elementi poprečne čvrstoće broda sastoje se od 33 rebra sastavljena od 99 elemenata<sup>25</sup>. Dvije rebrenice iz pramčanog ili krmenog dijela broda uočene su 2004. godine nekoliko metara južno od nalazišta (Sl. 8, 46). Većoj, nažalost, tijekom istraživačke kampanje 2007. više nije bilo moguće ući u trag<sup>26</sup>, dok je manja pronađena na mjestu na kojem je ostavljena (Sl. 48). S obzirom na prisutnost tih elemenata bilo je jasno kako je riječ o pramčanom ili krmenom završetku broda.



Sl. 50 Rupa u oplati, između rebara i rebrenih nastavaka, u visini rebara F123W i F125W (foto: Ph. Groscaux).

Fig. 50 Hole in planking, between the frames and futtocks, at the level of frames F123W and F125W (photo: Ph. Groscaux).

Among the preserved parts of the ship's hull there are no elements belonging to its longitudinal axis (keel, stem- and sternpost, forefoot and stern knee). The preserved parts of the ship's planking consist of 109 planks in 34 strakes, of which 56 planks in 14 strakes are in the western section, while 53 planks in 20 strakes are in the eastern section of the hull. Strake 19 corresponds to the low wale.<sup>24</sup>

The transversal elements of the ship's structure consisted of 33 frames composed of 99 elements.<sup>25</sup> Two V-shaped floor-timbers, one larger and one smaller, were observed several meters south of the site in 2004 (Fig. 8, 46). The larger one could not, unfortunately, be located any more during the excavation campaign in 2007,<sup>26</sup> while the smaller was found where it was left (Fig. 48). Given the presence and shape of these elements, it was clear that they were located in the bow or stern part of the hull.

Several pieces of the ceiling and floor planks were found in their original position in the eastern section of the ship, excavated in 2008. The pieces noticed in 2004 in the western section were not preserved, and their former existence may be perceived from the visible dark traces on the upper surface of the frames. In the northern section of the site, between the eastern and western sections of the ship, the lower part of a stanchion was also found (Fig. 42).

With regard to the state of preservation of wood, it is noteworthy that the ends of the frames were rather damaged by the aggressive activity of a marine mollusc known as

Nekoliko ulomaka platica unutrašnje oplata i dasaka podnice pronađeno je u izvornom položaju u istočnom dijelu broda, istraženom 2008. Ulomci primijećeni 2004. godine u zapadnom dijelu broda nisu se očuvali, a njihovo se nekadašnje postojanje moglo naslutiti iz vidljivih tragova na gornjoj površini rebara. U sjevernom dijelu nalazišta, između istočnog i zapadnog dijela broda pronađen je također i donji dio upore (Sl. 42).

U pogledu stanja očuvanosti drvene građe vrijedi napomenuti kako su krajevi rebara bili prilično oštećeni agresivnim djelovanjem crvotočca ili broskog crva (*Teredo navalis*), (Sl. 49). I platice su također bile prilično oštećene pa je, primjerice, sjeverni kraj platice P45E pronađen odignut od dna i savijen pod kutom od 45°. Osim toga, na više su mjesta zabilježene pukotine u oplati, a velika ih je većina primijećena u zapadnom dijelu broda, između rebrenica i rebrenih nastavaka koji odgovaraju rebrima F123W i F125W (Sl. 50) te u istočnom dijelu na kraju rebra F127E.

## UZDUŽNA OS BRODA

Iako se kobilica nije očuvala, njezina širina može se približno rekonstruirati na osnovi dimenzija donjeg dijela rebrenica iz pramčanog ili krmenog dijela broda pronađenih 2004. godine, a potom i međusobne udaljenosti slivnica na ulomku rebrenice PK07/F2. Sukladno tome može se pretpostaviti da je širina kobilice u južnom dijelu broda iznosila oko 7,5 do 10 cm, a u središnjem dijelu do 13 cm, a možda i više (Sl. 59). Ipak, mjere preuzete s elemenata koji se više nisu nalazili u svome izvornom položaju, upućuju na oprez pri donošenju dalekosežnijih zaključaka.

## OPLATA I SPOJEVI OPLATE

Oplata broda bila je realizirana stičnim spajanjem platica (Sl. 29). U bočnim su stranicama platica bili izvedeni utori u koje su bili ubačeni drveni jezičci, spojeni za platice uz pomoć drvenih čavlića (Sl. 53, 54).

Dokobilične platice (P1E i P1W) bile su izrađene od daske jednostavnog pravokutnog presjeka, prosječne debljine 3,65 cm (od 3,1 do 4,4 cm), bez dijagonalno izvedenih spojeva na očuvanim dijelovima (Sl. 51). Zapadna dokobilična platica (P1W) u južnom je dijelu široka 17 cm, ali njena se širina prema sjeveru smanjuje (3 cm) i šiljato završava (Sl. 41, 52). Ostale platice prosječne su debljine 2,8 cm (od 2,1 do 3,1 cm), a najveće širine od 6 (P33E) do 22 cm (P8W, P11W i P29E).

Duž istočnog perimetra broskog trupa zamijećeni su tragovi niske bokoštutnice, kojoj su pripadala tri ulomka označena P37E, P46E i P53E (Sl. 51). Element P37E širok je 15 cm i debeo 8,3 cm (Sl. 55). Element P46E, preokrenut i pomaknut s izvornog mjesta, očuvao se u duljini od 1,28 m. Taj ulomak bokoštutnice, širine 13,5 cm i debljine 10,2 cm, na vanjskome licu nosi tragove zaštitne obloge od olovnog lima koja je vjerojatno bila postavljena prilikom jednoga od

shipworms (*Teredo navalis*), (Fig. 49). The planks were also rather damaged, so, for example, the northern end of plank P45E was found jutting from the bottom and bent at a 45° angle. Additionally, cracks were recorded at a number of places on the planking, and by far the majority was noted in the western section of the ship, between the floor timbers and futtocks which correspond to frames F123W and F125W (Fig. 50), and in the eastern section at the end of frame F127E.

## SHIP'S AXIAL CARPENTRY

Even though the keel has not been preserved, its width can be approximately reconstructed on the basis of the dimensions of the lower section of the smaller floor-timber from the bow or stern area, found in 2004, and on the distance between the limber holes on fragment of floor-timber PK07/F2. In this regard, it may be assumed that the width of the keel in the southern section of the ship was roughly 7.5 to 10 cm, up to 13 cm in its middle section, and perhaps even greater (Fig. 59). Nonetheless, the measures assumed from elements no longer resting at their original positions indicate the need for caution when drawing far-reaching conclusions.

## PLANKING AND PLANK JOINTS

The ship has flush-laid or carvel planking (Fig. 29). Mortises were rendered in the thickness of the planks, into which tenons were inserted, fastened to the planks with the help of small wooden pegs (Fig. 53, 54).

The garboard planks (P1E and P1W) were made of boards of simple rectangular cross-sections, with an average thickness of 3.65 cm (from 3.1 to 4.4 cm). The garboard strakes seem to be made of single planks, as no oblique joints were noticed on the preserved parts (Fig. 51). The western garboard plank (P1W) is 17 cm wide in its southern section, but its width narrows toward the north (3 cm) and it tapers at its end (Fig. 41, 52). The remaining planks have an average thickness of 2.8 cm (from 2.1 to 3.1 cm), and maximum widths from 6 (P33E) to 22 cm (P8W, P11W and P29E).

All along the eastern perimeter of the ship's hull, traces of the lower wale were noticed which belonged to three pieces designated P37E, P46E and P53E (Fig. 51). Element P37E is 15 cm wide and 8.3 cm thick (Fig. 55). Element P46E, overturned and shifted from its original location, has been preserved at a length of 1.28 m. This wale fragment, 13.5 cm wide and 10.2 cm thick, bears traces of protective lining made of a piece of lead sheet on its external face, probably installed during one of the many repairs. The lead sheeting was fastened with small copper nails, of which two heads can still be seen 77.5 cm apart from one another. The sheet metal plate L27, found north of plank P36E, near the aforementioned P46E, probably served to repair a part of the wale<sup>27</sup> (Fig. 56). As to traces of shipbuilders' tools used to make the elements



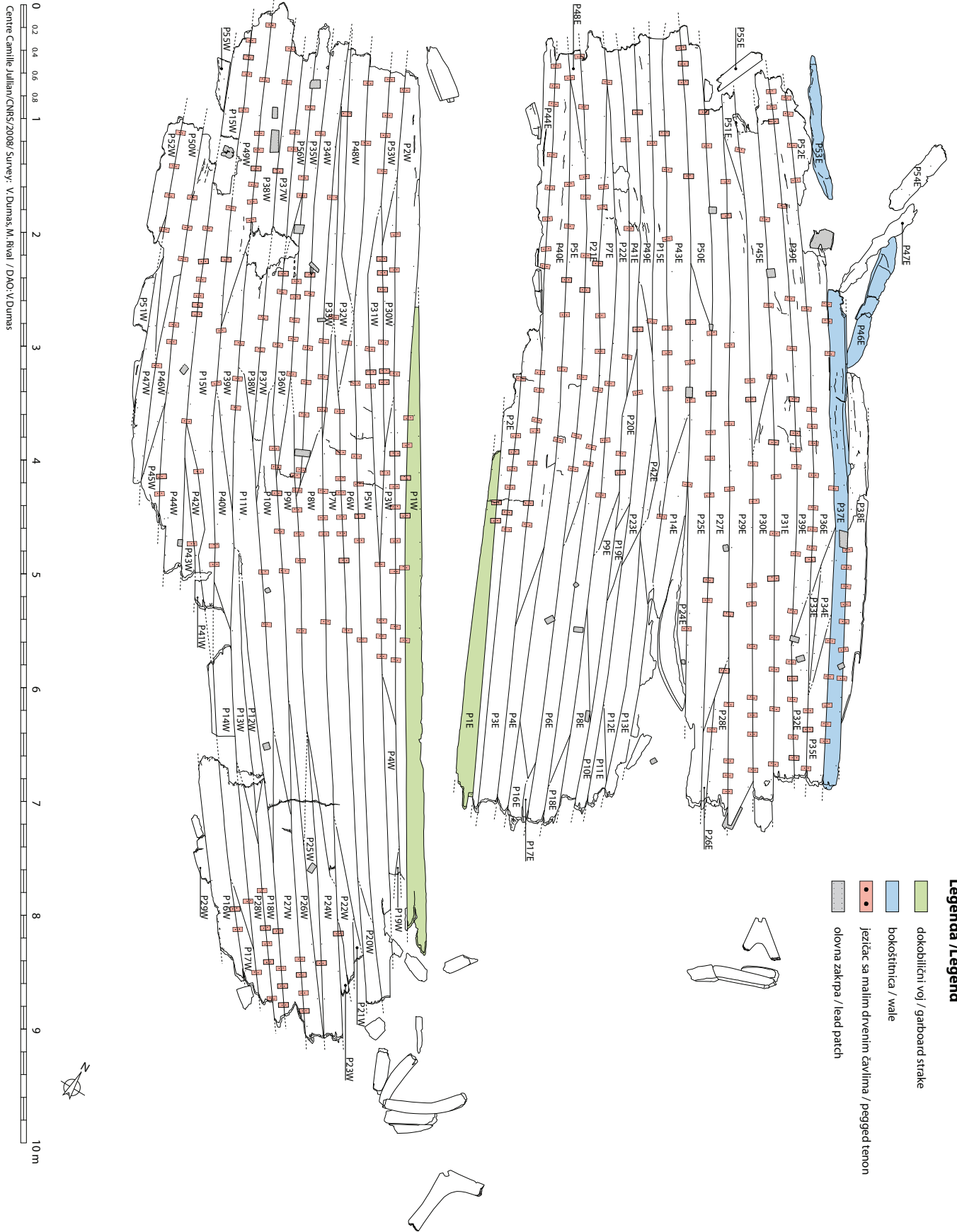

Sl. 51 Plan oplate (M. Rival, V. Dumas).

Fig. 51 Schematic of the planking (M. Rival, V. Dumas).



Sl. 52 Pogled s jugoistoka na dokobiličnu platicu P1W (foto: Ph. Groscaux).

Fig. 52 View of the garboard P1W from the south-east (photo: Ph. Groscaux).

brojnih popravaka. Olovni je lim bio pričvršćen bakrenim čavlicima, od kojih se dvije glavice još uvijek vide na međusobnoj udaljenosti od 77,5 cm. Ploča metalnog lima L27, pronađena sjeverno od platice P36E, u blizini spomenutog ulomka P46E, vjerojatno je poslužila za popravak jednog dijela bokoštitnice<sup>27</sup> (Sl. 56). Glede tragova brodograđevnog alata korištenoga za izradu elemenata brodske konstrukcije, na mnogim platicama vanjske oplata primijećeni su tragovi pile.

Platice vanjske oplata bile su međusobno spojene sistemom utora i jezičaca. Većina jezičaca bila je učvršćena drvenim čavlicima, ali su duž ruba dokobilične platice P1W (prema kobilici), u visini rebrenica F118W i F123W,

of the hull, on many planks of the planking traces of a saw were observed.

The planks of the planking were connected by mortise and tenon joints. Most of the tenons were fastened by small wooden pegs, but along the edge of garboard plank P1W (toward the keel), at the level of frames F118W and F123W, few unfastened tenons were also noticed. It would appear that this was an oversight on the part of the shipbuilders, rather than some specific purpose. The system of mortises on both sides of the plank was conceived according to a scheme (alternating the joints from one side and the other of the keel) that would cause the least possible weakening of the wood (Fig. 51).



Sl. 53 Detalj spajanja platica na dislociranom ulomku platice PK07/P11 (foto: Ph. Groscaux).

Fig. 53 Internal assemblage of the planking, on dislocated plank fragment PK07/P11 (photo: Ph. Groscaux).

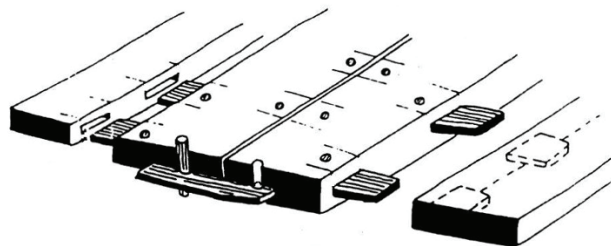

Sl. 54 Shematski prikaz spajanja platica sistemom utora i jezičaca (iz Pomey, Rieth 2005).

Fig. 54 Schematic representation of planks with mortise and tenon joints (after Pomey, Rieth 2005).





Sl. 55 Pogled na bokoštitnicu P37E i platicu P38E sa sjeveroistoka (foto: Ph. Groscaux).

Fig. 55 View of wale P37E and plank P38E from the north-east (photo: Ph. Groscaux).

primijećeni i jezičci koji su ostali nepričvršćeni. Čini se da je riječ o previdu od strane brodograditelja, a ne o nekoj posebnoj namjeri. Sustav utora s jedne i druge strane platice bio je zamišljen po shemi koja je na najmanji način utjecala na slabljenje drvene građe (Sl. 51).

Utori na bočnim stranama dokobiličnih platice, prema kobilici, prosječno su široki 8,26 cm (od 7 do 9,5 cm); debljina im varira od 0,5 do 0,8 cm, a dubina od 5 do 5,5 cm. Udaljenost među utorima iznosi prosječno 6,8 cm (Sl. 52). Jedini jezičac dokobilične platice kojega je bilo moguće izmjeriti bio je dug 4,5 cm i debeo 0,5 cm. Čavlići kojima su jezičci bili pričvršćeni za platice u prosjeku su međusobno udaljeni 15,25 cm.

Dimenzije spojnih elemenata s ostalih platice moglo se izmjeriti samo na ponekom ulomku koji se nije nalazio *in situ* pa je stoga bio izvađen iz mora i pomno pregledan (Sl. 53). Širina utora u tim je slučajevima u prosjeku iznosila 5,9 cm (od 4,5 do 6,4 cm). Širina jezičaca iznosila je 4,7 cm, a njihova debljina 0,4 cm.

Prosječna udaljenost među utorima iznosila je 8,7 cm (od 8,1 do 10,2 cm), a udaljenost među drvenim čavličima, izmjerena izravno *in situ*, iznosila je prosječno 16 cm (od 10 do 24,5 cm)<sup>28</sup>. Može se stoga zaključiti da je udaljenost među spojnim elementima bila prilično ujednačena.

Ako se na osnovi navedenih vrijednosti izračuna odnos između srednje međusobne udaljenosti utora i srednje širine samoga utora na dokobiličnim platicama, dobiva se omjer 1:0,823, a u slučaju ostalih platice on iznosi 1:1,47<sup>29</sup>. Navedeni omjeri pokazuju da je raspored utora na dokobiličnim platicama bio dvostruko gušći negoli na ostatku oplate<sup>30</sup>, ali se i raspored na ostalim platicama može smatrati razmjerno gustim.

Drveni čavlići iskorišćeni za fiksiranje jezičaca stožastog su oblika i prizmatičnog presjeka<sup>31</sup>. Sustavno mjerenje njihova unutrašnjeg i vanjskog promjera nije bilo moguće provesti jer se oplata nije rastavljala ni vadila<sup>32</sup>. Unatoč tome, na mjestima na kojima je bilo moguće izmjeriti unutrašnji promjer, on je



Sl. 56 Pogled sa sjeveroistoka na olovnu ploču L27, iskorišćenu za popravak oplate (foto: Ph. Groscaux).

Fig. 56 View of lead plate L27 used to repair the hull, from the north-east (photo: Ph. Groscaux).

The mortises on the lateral sides of the garboard planks, toward the keel, have an average width of 8.26 cm (from 7 to 9.5 cm); their thickness varies from 0.5 to 0.8 cm, while their depth varies from 5 to 5.5 cm. The distance between the mortises is an average of 6.8 cm (Fig. 52). The only tenon on the garboard plank that could be measured was 4.5 cm long and 0.5 cm thick. The pegs used to fasten the tenons to the plank were 15.25 cm apart on average.

The dimensions of the joining elements from the remaining planks could be measured only on displaced pieces, so they were removed from the sea and carefully inspected (Fig. 53). The width of the mortises in these cases was 5.9 cm on average (from 4.5 to 6.4 cm); the width of the tenons was 4.7 cm, while their thickness was 0.4 cm.

The average distance between the mortises was 8.7 cm (from 8.1 to 10.2 cm), while the distance between the wooden pegs, measured directly *in situ*, was an average of 16 cm (from 10 to 24.5 cm)<sup>28</sup>. It may therefore be concluded that the distance between the joining elements was rather uniform.

If, using these values, the ratio between the mean mutual distance between the mortises and the mean width of the mortises on the garboard planks is calculated, then 0.823 is obtained, while in the case of the remaining planks it is 1.47.<sup>29</sup> These ratios show that the distribution of mortises on the garboard planks was twice as dense as on the other planks,<sup>30</sup> even though their distribution on the other planks may still be deemed relatively dense.

The small wooden pegs used to fasten the tenons have a conical shape and a prismatic cross-section.<sup>31</sup> Systematic measurement of their internal and external diameter could not be done because the planking was neither disassembled nor extracted.<sup>32</sup> Despite this, at those places where it was possible to measure the internal diameter, it was 0.92 cm on average (from 0.7 to 1.2 cm). During the inspection of removed pegs on pieces of wood materials that were not *in*

u prosjeku iznosio 0,92 cm (od 0,7 do 1,2 cm). Prilikom pregleda izvađenih čavlića na ulomcima drvene građe koja se nije nalazila *in situ* bilo je moguće zamijetiti mali utor na mjestima njihova dodira s jezičcima<sup>33</sup>.

Na mjestima na kojima se platice spajaju u voj nije bilo moguće utvrditi jesu li jezičci bili postavljeni okomito ili pod kutem na dijagonalne spojeve te jesu li i oni bili učvršćeni drvenim čavlicima.

I na kraju, vodoravno postavljeni čavli poslužili su kako bi se pričvrstili zašiljeni krajevi platica. Ta je značajka primijećena na platici P38E na kojoj su tri horizontalno zabijena metalna čavla bila iskorištena kako bi se vrh platice pričvrstio za bokoštitnicu P37E (Sl. 32). Ne treba sumnjati da su i drugi metalni čavli mogli biti korišteni na krajevima ostalih platica, no ni taj podatak nije bilo moguće provjeriti bez rastavljanja elemenata brodske konstrukcije.

## ELEMENTI POPREČNE ČVRSTOĆE BRODA I SPOJEVI NA KOBILICU I OPLATU

Očuvani elementi poprečne čvrstoće broda uključuju 33 rebra (od F99W do F132E)<sup>34</sup> u 99 komada, koja su većinom polomljena na krajevima (Sl. 57). Među rebriima moglo se raspoznati 8 rebrenica<sup>35</sup> i 7 polurebrenica<sup>36</sup> u zapadnom dijelu broda. Tijekom proučavanja nalaza *in situ*, činilo se da se na čitavoj površini broda može razaznati 24 rebrena nastavka i 10 dijelova rebara koji su umetnuti prilikom popravaka. Po završetku obrade dokumentacije čini se, međutim, kako za takvu tvrdnju nema pravih temelja jer, usprkos činjenici da su popravci bili brojni, nema prave osnove za razlikovanje naknadno umetnutih od originalnih dijelova rebara<sup>37</sup>. U svakom slučaju, različiti elementi koji su sastavni dio jednog rebra međusobno su u pravilu udaljeni od 1 do 5 cm. U nekim slučajevima shema orebrenja donekle odstupa od osnovnog primijenjenog sustava: krajevi takvih rebara pomaknuti su s pravca, a na nekim se mjestima preklapaju pa je spoj među dijelovima izveden uz pomoć utora (Sl. 58). I na kraju, elementima poprečne čvrstoće broda pripadaju već spomenute dvije rebrenice iz pramčanog ili krmenog dijela broda (Sl. 48, 57).

Sva su rebra četvrtastog presjeka, a u nekim slučajevima gornji su im rubovi zaobljeni. Prosječna širina rebara iznosi 9,4 cm (od 7 do 14 cm), a prosječna visina 9,8 cm (od 5 do 14 cm), (Sl. 47). Tragovi pile i bradve uočeni su na bočnim stranama gotovo svih elemenata poprečne čvrstoće broda (Sl. 60).

Prosječni razmak između rebara iznosi 17,3 cm (od 10 do 23 cm), (Sl. 57). S obzirom na to da je razmak manji od dvije širine rebra, što pokazuje omjer prosječne širine rebara i prosječne širine njihova međusobnog razmaka koji iznosi 1:1,84, može se zaključiti da je riječ o razmjerno gusto raspoređenim rebriima.

Na rebrenicama se nalaze slivnice (kaljužni otvori) pravokutnog oblika (šir. 4 – 5 cm i vis. 2 – 3,5 cm na rebrenicama

*situ*, it was possible to note a small groove at the places at which they touched the tenons.<sup>33</sup>

At the places where the planks connect in the strake, it was impossible to ascertain whether the tenons were set vertically or at an angle to the oblique joint, and whether they were also fastened with wooden pegs.

And finally, horizontally set nails were used to fasten the tapered ends of planks. This feature was observed on plank P38E on which three horizontally pounded metal nails were used to fasten the tip of the plank to wale P37E (Fig. 32). There should be no doubt that the other metal nails may have been used at the ends of the remaining planks, but even this could not be verified without dismantling the elements of the hull.

## TRANSVERSAL ELEMENTS AND JOINTS TO THE KEEL AND PLANKING

The preserved transversal elements include 33 frames (from F99W to F132E)<sup>34</sup> in 99 pieces, which are mostly broken at their ends (Fig. 57). Among the frames, 8 floor timbers<sup>35</sup> and 7 half-frames<sup>36</sup> could be discerned in the western section of the ship. During study of the finds *in situ*, it seemed that 24 futtocks and 10 various pieces of frames were inserted during repairs. Upon completion of the documentation, however, it would appear that there are no valid grounds for this assertion, for despite the fact that repairs were numerous, there are no genuine grounds to distinguish between subsequently inserted and original parts of the frames.<sup>37</sup> In any case, the different elements, which are components of a frame were set on the same line (or centred) generally 1 to 5 cm away from each other. In some cases, the framing scheme deviates somewhat from the basic applied system: the ends of these frames have been moved from their original direction, and at some places they overlap, so the link between the parts was rendered with the help of a recess but always without any assembly by nails or treenails (Fig. 58). And finally, the already mentioned two floor-timbers from the ship's stem and stern (Fig. 48, 57) also belong to this group of finds.

All of the frames have a rectangular cross-section, and in some cases the upper edges are rounded. The average width of the frames is 9.4 cm (from 7 to 14 cm), while the average height is 9.8 cm (from 5 to 14 cm), (Fig. 47). Traces of a saw and hatchet were observed on the lateral sides of almost all transversal elements (Fig. 60).

The average distance between frames is 17.3 cm (from 10 to 23 cm), (Fig. 57). Given that this gap is less than two widths of a frame, showing the ratio between the average width of a frame and the average width of the gap between them is 1.84, it may be concluded that these are relatively densely distributed frames.





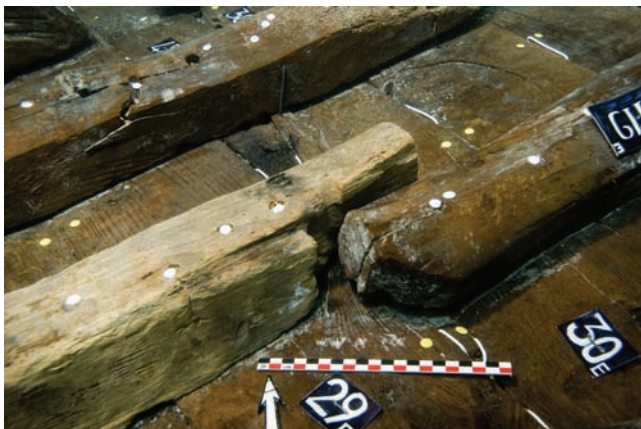

Sl. 58 Pogled sa sjeverozapada na spoj između dvaju dijelova rebra F119E (foto: Ph. Groscaux).

Fig. 58 View of the recess fitting between the two parts of frame F119E, from the north-west (photo: Ph. Groscaux).

iz središnjeg dijela broda; šir. 5 cm i vis. 4 cm na rebrenicama iz pramčanog ili krmenog dijela broda) koje su omogućavale protok vode<sup>38</sup> u kaljužnici. U središnjem dijelu broda, na rebrenicama i polurebrenicama izvedena su po dva otvora smještена s jedne i druge strane kobilice (Sl. 59.3, 61), a na rebrenicama iz pramčanog ili krmenog dijela broda prisutan je samo jedan otvor (Sl. 59.1-2).

Nekoliko rebrenica<sup>39</sup> bilo je pričvršćeno za kobilicu pomoću željeznih svornjaka. Takav je spoj detaljno proučen na rebrenici F119W. Svornjak promjera 1,9 cm bio je zabijen s vanjske strane kobilice, a s gornje strane rebrenice bio je fiksiran pomoću okrugle pločice koja je počivala u kvadratnom utoru dimenzija 4,7 x 4,7 x 1,0 cm, (Sl. 62-65). Takav detalj primijećen je, na primjer, na brodolomu iz Monaka (kraj 2. – sred. 3. st. po Kr.; Mouchot 1968-1969). Na ulomku rebrenice, pronađenom izvan originalnog položaja i označenom kao PK07/F2, između dvije slivnice također se nalaze tragovi sličnog spoja s kobilicom (Sl. 57.3)<sup>40</sup>. U tome slučaju promjer svornjaka iznosio je 1,7 cm.

Spojevi rebara i oplata bili su izvedeni pomoću brojnih drvenih čavala prosječnog promjera 1,3 cm (od 0,7 do 1,9 cm,



Sl. 60 Tragovi pile na bočnoj strani rebra (foto: Ph. Groscaux).

Fig. 60 Sawing marks on the side of the frame (photo: Ph. Groscaux).

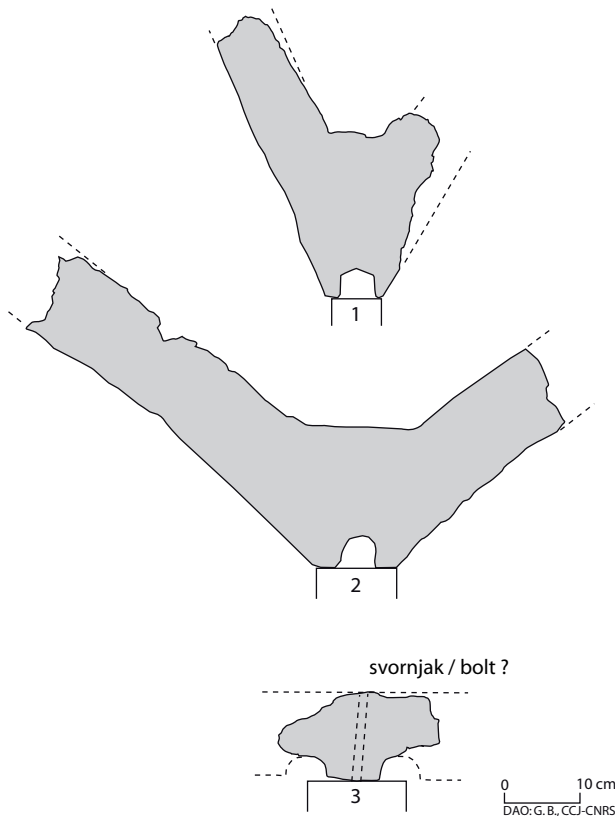

Sl. 59 Slivnice na rebrenicama iz pramčanog ili krmenog dijela broda i ulomku rebrenice PK07/F2 (crtež: G. Boetto).

Fig. 59 The limber holes on the floor-timbers from bow or stern, and on the fragment of floor-timber PK07/F2 (drawing: G. Boetto).

The floor timbers have rectangular limber holes (wid. 4-5 cm and ht. 2-3.5 cm on the floor timbers; wid. 5 cm and ht. 4 cm on floor-timbers from the bow or stern area), which facilitated the flow of water<sup>38</sup> into the bilge. In the ship's central section, two holes situated on each side of the keel were made on the floor-timbers and half-frames (Fig. 59.3, 61), while there is only a single hole, directly above the keel, on the floor-timbers from the bow or stern area (Fig. 59.1-2).



Sl. 61 Pogled s jugoistoka na kraj polurebrenice F112W (foto: Ph. Groscaux).

Fig. 61 View of the extremity of half frame F112W, from the south-east (photo: Ph. Groscaux).

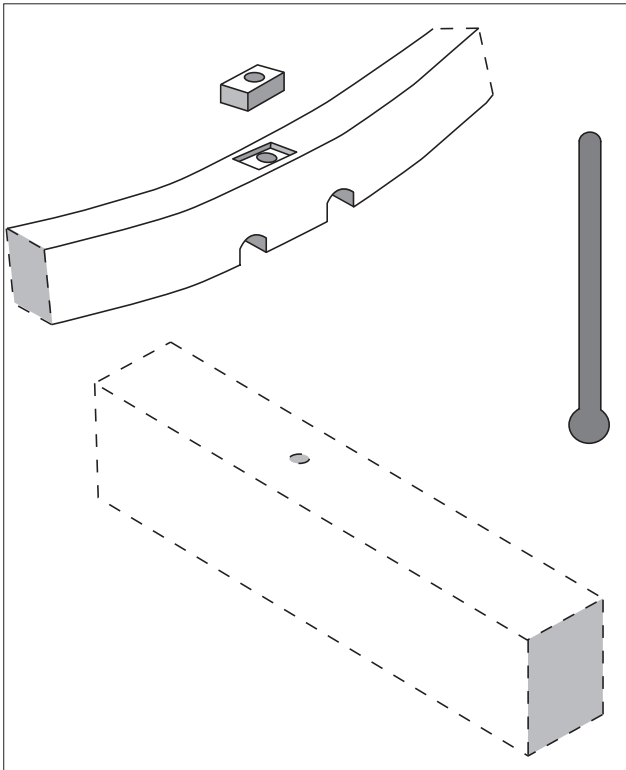

Sl. 62 Shematski prikaz učvršćenja kobilice i rebrenice uz pomoć svornjaka (crtež: G. Boetto).

Fig. 62 Schematic representation of bolting the floor-timbers to the keel (drawing: G. Boetto).

mjereno s unutrašnje strane broda) te bakrenih i željeznih čavala<sup>41</sup> zabijenih s vanjske strane broda (Sl. 65, 67). S gornje strane rebara vrhovi čavala nisu bili savinuti radi dodatnog učvršćenja. Valja istaknuti kako su na nekim mjestima drveni čavli izrazito brojni (do četrdesetak na dijelovima rebara dugim preko 2 m), što se s velikom vjerojatnošću može povezati s popravcima broda (Sl. 47).



Sl. 64 Slomljen kraj rebrenice F119W s korodiranim svornjakom *in situ* (foto: Ph. Groscaux).

Fig. 64 Broken extremity of floor-timber F119W with the corroded bolt *in situ* (photo: Ph. Groscaux).



Sl. 63 Četvrtasti utor na gornjoj strani rebrenice F119W (foto: Ph. Groscaux).

Fig. 63 Quadrangular recess on the upper surface of the floor-timber F119W (photo: Ph. Groscaux).

Several floor timbers<sup>39</sup> were fastened to the keel with metal bolts. Such a connection was thoroughly studied on floor timber F119W. A bolt with 1.9 cm diameter was inserted from the external side of the keel, and it was fastened from the upper side of the floor timber with the help of a square plate that rested in a square hole with dimensions of 4.7 x 4.7 x 1 cm (Fig. 62-65). Such a detail was noted, for example, on a shipwreck from Monaco (end of 2<sup>nd</sup>/mid-3<sup>rd</sup> cent. AD; Mouchot 1968-1969). There is also a similar connection to the keel between two limber holes on a floor timber piece found away from its original position and marked as PK07/F2 (Fig. 57.3).<sup>40</sup> In this case, the bolt's diameter was 1.7 cm.

The joints connecting the frames to the planking were rendered with the help of treenails having an average diameter of 1.3 cm (from 0.7 to 1.9 cm, measured from the inside of the ship) and copper and iron nails<sup>41</sup> inserted from the ship's exterior (Fig. 65, 67). On the upper sides of the frames, the tops of nails were not clenched for greater reinforcement. It is noteworthy that in some places the wooden nails are exceptionally numerous (up to roughly forty on the parts of frames longer than 2 m), which very likely may be linked to hull repairs (Fig. 47).



Sl. 65 Ostatci svornjaka (foto: Ph. Groscaux).

Fig. 65 Bolt remains (photo: Ph. Groscaux).





Sl. 66 Metalni čavli raznih veličina iskorišteni za gradnju i popravak broda (foto: Ph. Groscaux).

Fig. 66 Nails of various sizes, used for building and repairing the hull (photo: Ph. Groscaux).

### UNUTRAŠNJI UZDUŽNI ELEMENTI BRODSKE KONSTRUKCIJE

Unutrašnji elementi uzdužne čvrstoće i ostali unutrašnji uzdužni elementi brodske konstrukcije sastoje se od nekoliko ulomaka proveza i mobilnih dasaka podnice. Budući da se kobilica nije očuvala, nisu pronađeni nikakvi tragovi niti hrptenice niti temeljnice jarbola.

Na nekoliko rebara u zapadnom dijelu broda (F121W i F123W)<sup>42</sup> bilo je, međutim, moguće primijetiti utore širine od 7,5 do 8,5 cm i dubine 1 do 2 cm. Ti su utori bili smješteni duž iste osi, na razini spoja prve i druge dokobilične platice (P1W i P2W), s laganim odmakom prema onoj drugoj (Sl. 68). Moglo bi se pretpostaviti da je riječ o dosjedima za



Sl. 67 Metalni čavao u ulomku drveta (foto: Ph. Groscaux).

Fig. 67 Metal nail in a fragment of wood (photo: Ph. Groscaux).

### INTERNAL LONGITUDINAL ELEMENTS OF THE HULL

The internal longitudinal elements of the hull consist of several fragments of stringers and mobile limber boards. Since the keel has not been preserved, no traces of the keelson nor mast step were found.

It is, however, possible to notice on several frames in the ship's western section (F121W and F123W)<sup>42</sup> recesses with widths ranging from 7.5 to 8.5 cm and depths of 1 to 2 cm. These recesses were situated along the same axis, at the level of the joint between the first and second garboard planks (P1W and P2W), slightly closer to the second one (Fig. 68). It may be assumed that these are fittings for one of the bilge

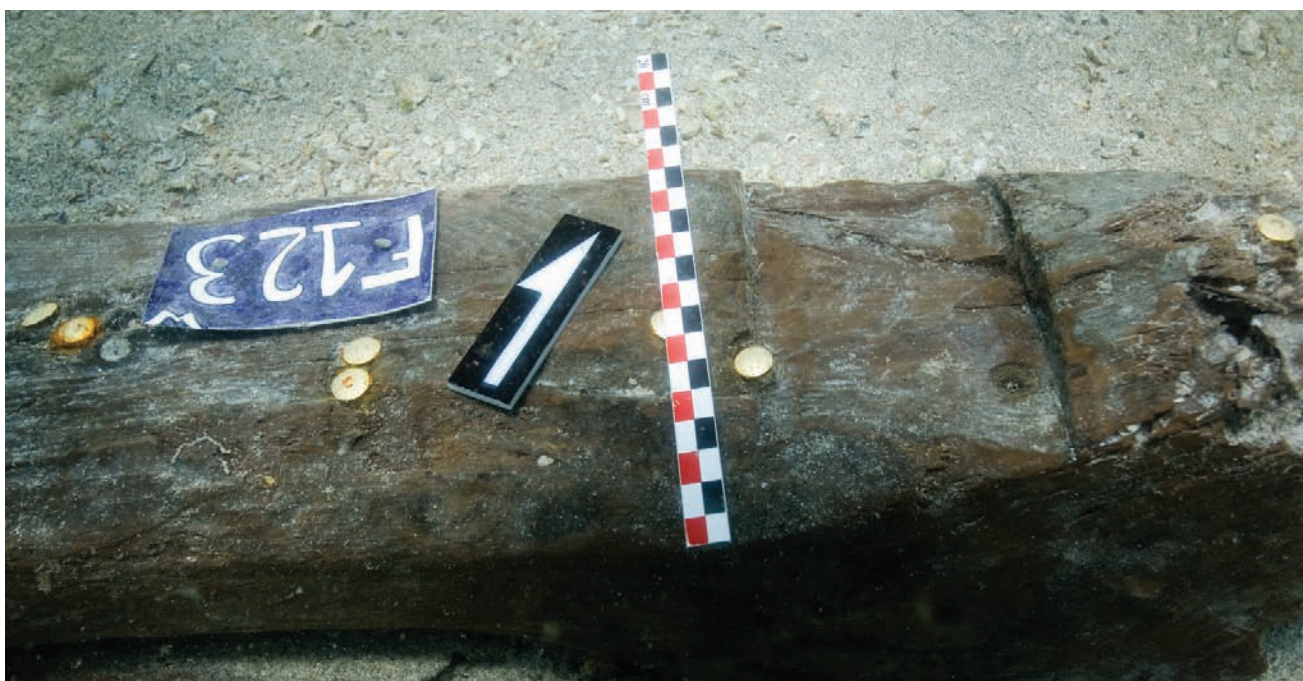

Sl. 68 Utor za dosjed dohrptenice (foto: Ph. Groscaux).

Fig. 68 Recesses for sister (bilge) keelson (photo: Ph. Groscaux).



dohrptenicu (Sl. 69), kakva se, ukoliko je postojala, morala nalaziti i na odgovarajućem mjestu s druge strane kobilice. Na te je dohrptenice mogla biti pričvršćena temeljna jarbola, kao što je to slučaj na već spomenutom brodu na lokalitetu *Burza (Bourse)* u Marseilleu (Francuska, 190. – 220. g. po Kr.), (Gassend 1982: 82-83)<sup>43</sup>, ili brodolomu *Laurons 2* (Francuska, kraj 2. st. po Kr.), (Gassend, Liou, Ximénès 1984: 100 i 97, Sl. 17c)<sup>44</sup>.

Tijekom istraživanja pronađena su samo dva mala ulomka unutrašnje oplate (Sl. 47), ali se iz brojnih tamnijih otisaka i tragova spojeva primijećenih na rebrima (Sl. 70) može zaključiti da je ona prekrivala gotovo čitavu unutrašnjost broda<sup>45</sup>.

Osim toga uočeno je šest ulomaka proveza, ali samo su dva još uvijek bila *in situ* (C4E i C5E), pričvršćena za rebra F122E i F125E (Sl. 71, Tab. 1). Ulomak C3E pronađen je između južnog kraja broda i rebrenica izmaknutih iz izvornog položaja (Sl. 46 i 48). Sljedeća dva ulomka (PK08/C5 i PK08/C57) pronađena su u istočnom, a samo jedan (C5W) u zapadnom dijelu broda. Točan položaj posljednjeg navedenog ulomka nije poznat. Širina nabrojanih ulomaka iznosi od 11 (C5E i PK08/C5) do 21 cm (C4E), a prosječna debljina iznosi im 3 cm. Na svim se primjercima zamjećuju tragovi korozije metalnih čavala ili rupa za prihvat drvenih čavala uz pomoć kojih su elementi bili pričvršćeni za rebra.

Sedam ulomaka interpretirano je kao ostatci pomičnih dasaka podnice (Tab. 1). Riječ je o malim daskama (od 17,6 do 70 cm duljine) smještenima među uzvojnim provezama i bez ikakvih fiksnih spojeva na rebra (Sl. 71). Rubovi tih dasaka (C4W i PK08/C61) u nekim su slučajevima koso rezani kako bi se daske bolje uglavile između fiksnih proveza. U istočnom dijelu broda dvije su se daske (C6E i C7E) očuvale u izvornom položaju, dok se treća (C8E) izmaknula u prostor

keelsons (Fig. 69). The second bilge keelson had to have been situated at the proper place on the other side of the keel. The mast step may have been settled over the bilge keelsons, as is the case on the already mentioned ship at the Bourse site in Marseille (France, 190-220 AD; Gassend 1982: 82-83),<sup>43</sup> or the Laurons 2 shipwreck (France, end of 2<sup>nd</sup> cent. AD; Gassend, Liou, Ximénès 1984: 100 and 97, Fig. 17c).<sup>44</sup>

During the excavations, only two small pieces of ceiling planks were found (Fig. 47), but based on the numerous darker imprints and traces of joints observed on the frames (Fig. 70) it may be concluded that it covered almost the entire ship's bottom.<sup>45</sup>

Moreover, six fragments of stringers were observed, although only two were still *in situ* (C4E and C5E), fastened to frames F122E and F125E (Fig. 71, Tab. 1). Fragment C3E was found between the southern end of the ship and the smaller floor-timber from the bow or stern area, shifted from its original position (Fig. 46 and 48). The next two fragments (PK08/C5 and PK08/C57) were found in the eastern, and only one (C5W) in the western section of the ship. The precise position of the last noted fragment is not known. The width of these fragments runs from 11 (C5E and PK08/C5) to 21 cm (C4E), and their average thickness is 3 cm. Traces of corrosion from metal nails or holes to hold treenails, used to fasten these elements to the frames, were observed on all examples.

Seven fragments were interpreted as the remains of movable limber boards (Tab. 1). These are small planks (from 17.6 to 70 cm in length) set between the bilge stringers and without fixed joints on the frames (Fig. 71). The edges of these planks (C4W and PK08/C61) were in some cases bevelled so that they could be better set between the fixed stringers. In

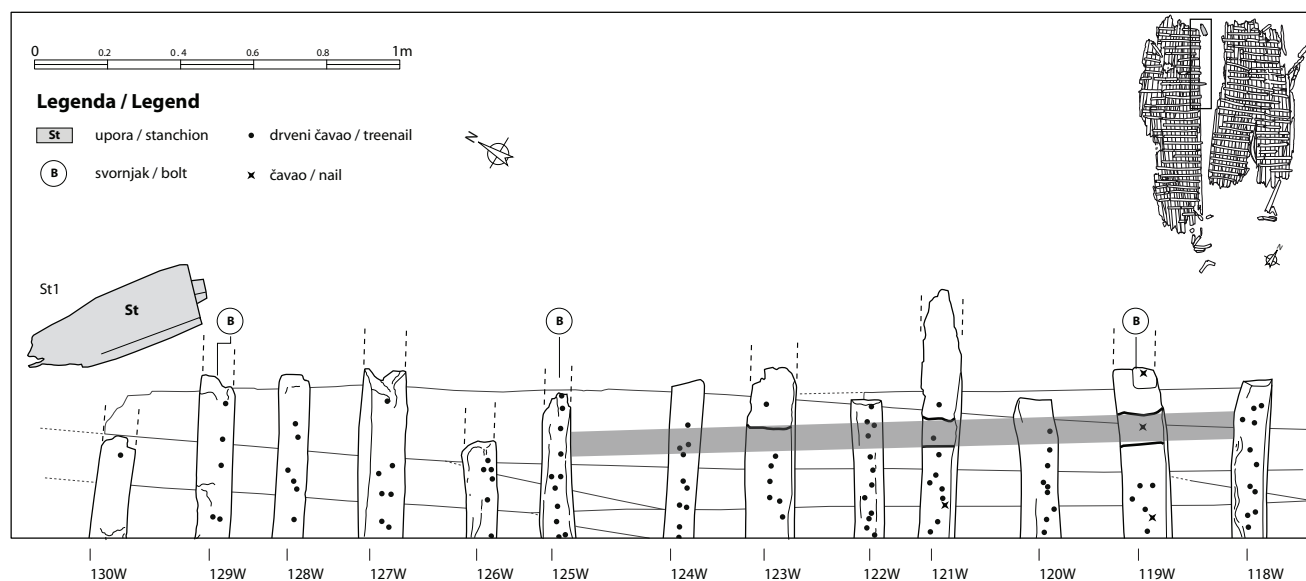

Sl. 69 Shematski prikaz očuvanih utora za zapadnu dohrptenicu i njen hipotetski položaj (drawing: V. Dumas).

Fig. 69 Schematic representation of the preserved recesses for the western bilge keelson, and its hypothetical position (drawing: V. Dumas).



Sl. 70 Tamni otisak na gornjoj strani rebra (foto: Ph. Groscaux).

Fig. 70 Dark imprint on the upper surface of a frame (photo: Ph. Groscaux).

između rebara F127E i F128E (Sl. 46). Još jedan ulomak pomične podnice (PK08/C61) pronađen je uz dasku C6E, ali njegov točan položaj nije zabilježen. Još tri ulomka dasaka pronađena su u zapadnom dijelu broda (PK07/C1, PK07/C2 i C4W). Širina dasaka iznosila je 7,4 (C6E) i 13,2 cm (C7E), a prosječna debljina 2,3 cm.

## UPORA

Tijekom istraživačke kampanje 2008., u sjevernom dijelu nalazišta, između dva istočna dijela brodske konstrukcije, pronađen je obrađeni komad drveta koji je protumačen kao donji dio upore (St1), (Sl. 46), koja je služila za upiranje sponja na kojima je počivala paluba (Sl. 71, 73). Riječ je o elementu pravokutnog presjeka, dimenzija 14 x 7 cm, očuvanom u visini od 47 cm, koji na donjoj strani ima istaku širine 5 cm, debljine 3 cm i visine 3,5 cm (Sl. 74). Istaka je služila za učvršćenje upore u utor koji se nalazio na gornjoj površini hrptenice ili rebra.

## ZAŠTITA BRODSKOG TRUPA

Kao što je već u nekoliko navrata spomenuto, unutrašnjost broda bila je prekrivena debelim zaštitnim slojem smole. Tragovi smole primijećeni su i na vanjskoj strani trupa, npr. na ulomku bokoštitnice P37E i na ulomcima platica koji su pronađeni izvan izvornog položaja, pa su stoga izvađeni iz mora i zasebno proučeni.

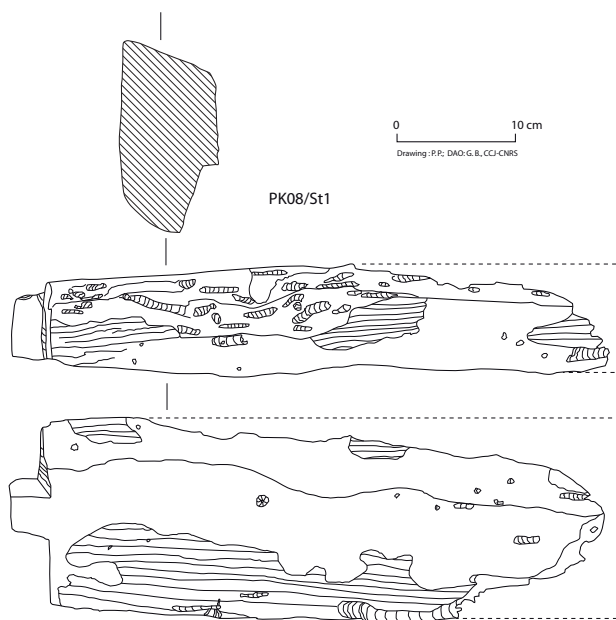

Sl. 71 Očuvani dio upore St1 (crtež: G. Boetto).

Fig. 71 Preserved fragment of stanchion St1 (drawing: G. Boetto).

the eastern section of the hull, two planks (C6E and C7E) were preserved in their original position, while the third (C8E) was shifted to the space between frames F127E and F128E (Fig. 46). Still another piece of the movable limber board (PK08/C61) was found next to plank C6E, but its precise position was not recorded. Another three fragments were found in the ship's western section (PK07/C1, PK07/C2 and C4W). They are 7.4 (C6E) and 13.2 cm (C7E) wide, and in average 2.3 cm thick.

## STANCHION

During the 2008 excavation campaign, a worked wooden element was found in the northern part of the site, between two eastern sections of the hull. It was identified as the lower part of the stanchion (St1), (Fig. 46) that supported the deck beams on which the deck rested (Fig. 71, 73). This is an element of rectangular cross-section, measuring 14 x 7 cm, preserved to the height of 47 cm, which has a tenon on its base, 5 cm wide, 3 cm thick, and 3.5 cm high (Fig. 74). The tenon was set into a notch on the upper surface of the keelson or stringer.

## PROTECTION OF THE SHIP'S HULL

As already noted at several points, the ship's interior was covered with a thick layer of pitch. Traces of pitch were also



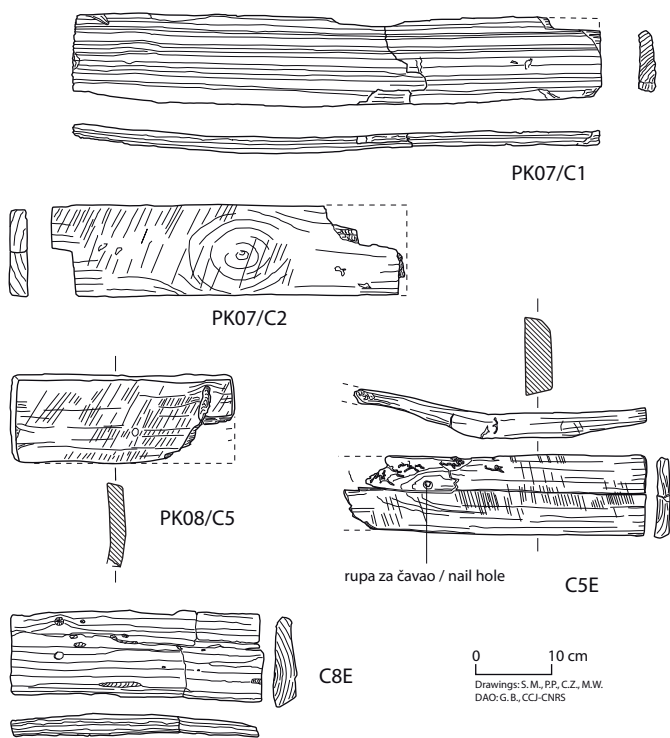

Sl. 72 Ulomci proveza i dasaka podnice (crtež: G. Boetto).  
 Fig. 72 Fragments of stringers and limber boards (drawing: G. Boetto).



Sl. 73-74 Očuvani dio upore St1 (foto: Ph. Groscaux).  
 Fig. 73-74 Preserved fragment of stanchion St1 (photo: Ph. Groscaux).

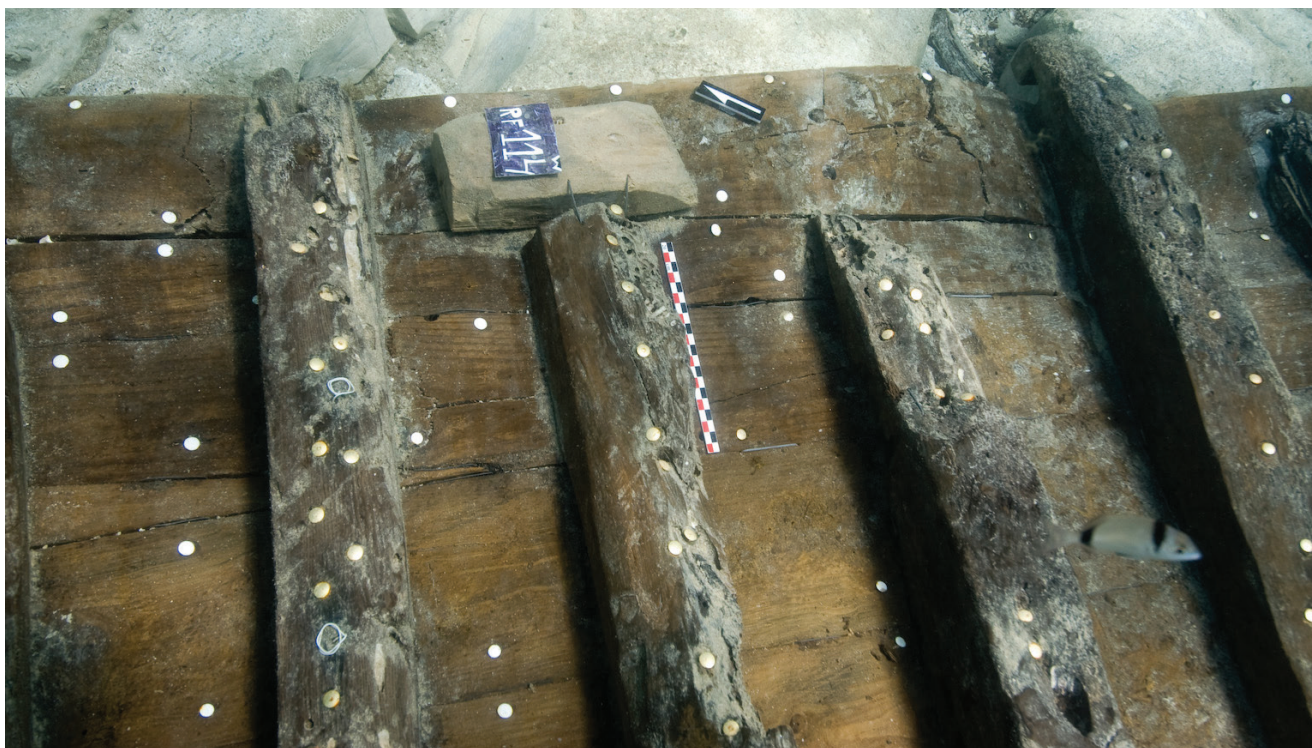

Sl. 75 Pogled s jugozapada na popravak rebra RF114W (foto: Ph. Groscaux).  
 Fig. 75 View from the south-west of the frame repair RF114W (photo: Ph. Groscaux).



## POPRAVCI

Analiza ostataka brodske konstrukcije omogućila je identifikaciju velikog broja popravaka izvedenih na oplati. Riječ je o zakrpnim jezičcima i zakrpnim olovnim pločicama, pričvršćenima uz pomoć čavlića na unutrašnju i/ili vanjsku stranu broskog trupa.

Na osnovi mnogih elemenata (raspored rebara, velik broj drvenih čavala koji spajaju rebra i oplatu, raznolikost vrsta drvene građe) moguće je zaključiti da su u vrijeme korištenja broda popravljana i mnoga rebra. Nekim su popravcima bili zahvaćeni tek manji dijelovi, kao što je to slučaj s elementom uzdužno smještenim na kraju rebra F114W, elementom u blizini dokobilične platice P1W (Sl. 75) i elementom ubačenim između rebara F117W e F118W (Sl. 57).

## ZAKRPNI JEZIČCI

Zakrpnj jezičci, korišteni za učvršćenje zamjenskih platice, primijećeni su na ulomcima platice izvan originalnog položaja<sup>46</sup>. Svi su oni bili ubačeni s vanjske strane broskog trupa, što objašnjava činjenicu da tragovi takvih popravaka nisu bili zamijećeni s njegove unutrašnje strane. Zakrpnj jezičci, očuvani u duljini od 6 do 9 cm, prosječnoj širini od 4,8 cm i debljini od 0,75 cm, bili su ubačeni u zamjensku platicu kroz pravokutni utor izveden na njezinoj vanjskoj površini (Sl. 76, 77).

## ZAKRPNJE OLOVNE PLOČICE

Dvije olovne ploče i 28 pločica ili njihovi tragovi *in situ*, evidentirani su na vanjskim i unutrašnjim stranama olupine (Tab. 2). Ploča L17, pravokutnog presjeka (dulj. 25 cm, šir. 13 cm), pronađena je u jugoistočnom dijelu broda (Sl. 46, 48 i 78), ispod platice P28E, a ploča L27 u njegovom sjeveroistočnom dijelu, u blizini ulomka bokoštitnice P46E (Sl. 46, 56, 78). Druga spomenuta ploča bila je savinuta u obliku slova U (dulj. 17 cm; šir. 15,5 cm; vis. 6,5 cm), kako bi čim bolje prijanjala uz bokoštitnicu. Objе su ploče bile fiksirane za drvo nizom čavlića fiksiranih uz rubove.

Olovne pločice nešto manjih dimenzija pravokutnog su ili kvadratnog oblika. Duljina im iznosi od 5 (L7 i L10) do 18,5 cm (L25), a širina od 3 (L4, L18) do 11 cm (L2). I one su za drvo bile učvršćene nizom metalnih čavlića, visine od 1 do 3 cm i promjera glavice od 0,5 do 0,7 cm), (Sl. 81, 82). Valja napomenuti da se većina pločica nalazila pod nekim dijelom rebra (Tab. 2), što bi značilo da su bile postavljene prije negoli elementi poprečne čvrstoće broda. Riječ je, dakle, o postupku učvršćivanja ili popravka ostvarenom prije negoli su tijekom izgradnje broda postavljena rebra. Druga je mogućnost da je riječ o naknadnim reparacijama, ali se u tom slučaju može s pravom pretpostaviti da su rebra na tim mjestima bila zamijenjena.

Trideset i tri pločice koje nisu bile pričvršćene za oplatu pronađene su tijekom obje istraživačke kampanje, čime se

observed on the external sides of the hull, e.g., on the piece of wale P37E and on plank pieces found away from their original positions, so that they were removed from the seafloor and studied in detail.

## REPAIRS

An analysis of the hull remains has made it possible to identify a high number of repairs applied to the planking. These are patched tenons and lead patches fastened with small nails onto the internal and/or external sides of the hull.

Based on many elements (arrangement of the frames, a high number of treenails connecting the frames to the planking, different types of wood) it may be concluded that during its use many of the ship's frames underwent repairs. Some repairs only encompassed smaller parts, which was the case with the elements longitudinally placed at the end of frame F114W, the element near garboard plank P1W (Fig. 75) and the element inserted between frames F117W and F11W (Fig. 57).

## PATCHED TENONS

Patched tenons, used to fasten repaired planks, were observed on the pieces of planks away from their original positions.<sup>46</sup> All of them were added to the exterior of the ship's hull, which explains the fact that the traces of such repairs were not observed *in situ* in its interior. Patched tenons, preserved at lengths of 6 to 9 cm, an average width of 4.8 cm and thickness of 0.75 cm, were inserted into replacement planks through rectangular mortises made on their external surface (Fig. 76, 77).

## LEAD PATCHES

Two bigger lead plates and 28 smaller patches, or their traces *in situ*, were recorded on the outside and inside of the hull (Tab. 2). Rectangular plate L17 (lng. 25 cm, wid. 13 cm) was found in the ship's south-eastern section (Fig. 46, 48 and 78), below plank P28E, while plate L27 was in its north-eastern section, near wale fragment P46E (Fig. 46, 56, 78). The other aforementioned plate was bent into a U shape (lng. 17 cm; wid. 15.5 cm; ht. 6.5 cm) so that it could rest more snugly against the wale. Both plates were attached to the wood by a row of small nails at their edges.

The lead patches of somewhat smaller dimensions are rectangular or square shaped. Their length runs from 5 (L7 and L10) to 18.5 cm (L25), while their width ranges from 3 (L4, L18) to 11 cm (L2). They were also attached to the wood by a series of small metal nails, from 1 to 3 cm high with the diameter of their heads ranging from 0.5 to 0.7 cm (Fig. 81, 82). It should be noted that most of the patches were below some part of the frames (Tab. 2), which would mean that they

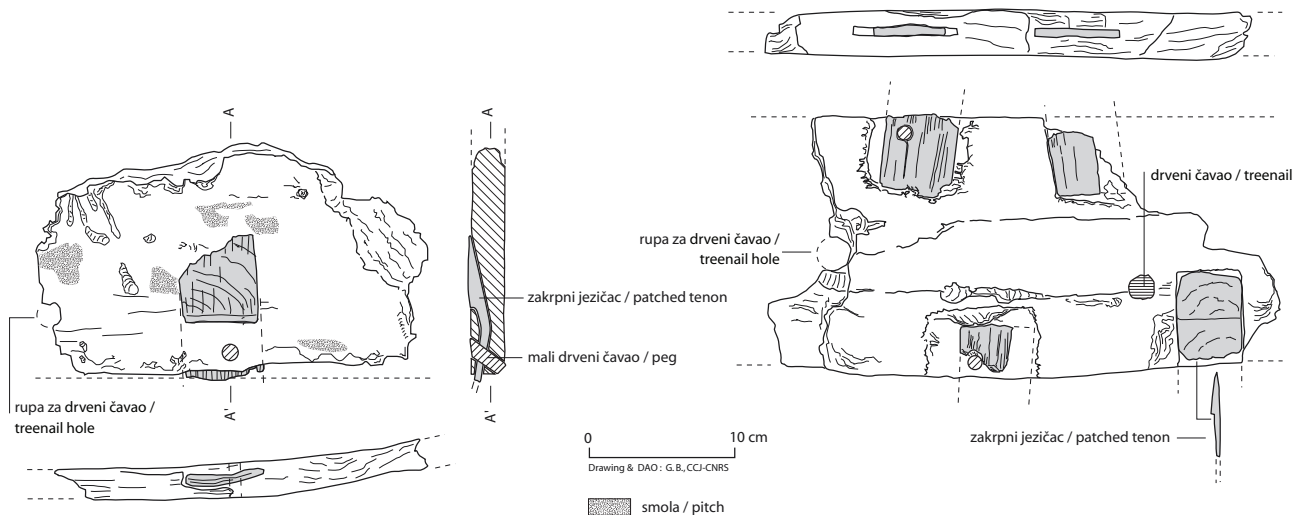

Sl. 76 Izmješteni ulomci platica sa zakrpnim jezićima (crtež: G. Boetto).

Fig. 76 Detached fragments of planks with patched tenons (drawing: G. Boetto).

sveukupan broj pločica popeo na 61 (Tab. 3). Na tri pločice primijećen je urezan mrežasti motiv izveden nekim šiljatim alatom (Sl. 80). Na pločici PK07/5 nije bilo tragova čavliča niti rupica kroz koje su bili probijeni, pa se može zaključiti da pločica nije bila iskorištena, već se nalazila u alatu i priboru za popravak broskog korita u slučaju potrebe.

S ciljem boljeg razumijevanja tog tipa reparacije, pločice L24, L25 i L29 bile su izvađene iz mora 2008. godine zajedno s drvenim dijelovima broda na koje su bile fiksirane (Sl. 83-85). Očigledno je da su se one koristile da bi na osjetljivim mjestima zapriječile prodor vode u brod, koji se mogao dogoditi iz više razloga. Pločice L24 i L25 pokrivala su, na primjer, prirodni čvor u drvetu, dok je pločica L29 bila korištena da bi se zatvorila pukotina.

Na oplati su proučeni čvorovi pokriveni olovnim pločicama. Oni su velik problem samo u slučaju kad se nalaze na mjestu na kojem je i utor za jezić, kojega prisutnost izaziva njihovo pomicanje. Stoga se na takvim mjestima, s ciljem povećanja čvrstoće, primjenjivao sistem zaštite izveden pomoću ljepljive mase na bazi smole, same smole, drvenih čavliča i pločice (Sl. 84, 85). Isti je sistem bio primijenjen na pukotinama u oplati<sup>47</sup>.

Popravci trupa izvedeni uz pomoć olovnih ploča i pločica uočeni su i na drugim sredozemnim brodolomima iz vremena kasne antike. Na brodolomu *Port-Vendres I* (Francuska, kraj 4. / poč. 5. st. po Kr.) jedna je olovna ploča štitila spoj kobilice i pete statve (Liou 1974: 417), a na brodolomu *Yassi Ada II* (Turska, 4. st. po Kr.) olovne su zakrpe bile korištene da bi se osnažili oštećeni dijelovi broda (Van Doorninck 1976: 128-129). U novije vrijeme, popravci uz pomoć olovnih pločica primijećeni su na brodolomu *Posticcio* (Korzika, 3. st. po Kr.; Alfonsi 2010).

were installed prior to the ship's transversal elements. This was, therefore, a reinforcement or repair procedure done during the ship's construction prior to installation of the frames. Another possibility is that these were subsequent repairs, but in this case, it may be rightfully assumed that the frames at these places had also been replaced (and perhaps substituted).

Thirty-three patches not fastened to the planking were found during both excavation campaigns, so that the total number grew to 61 (Tab. 3). A crosshatched pattern created with some sort of pointed tool could be observed on three patches (Fig. 80). There were no traces of nails on sheet PK07/5, nor the holes through which they had been pierced, so it may be concluded that this patch had not been used but was rather held among the tools and accessories to repair the hull when necessary.

With the aim of gaining greater insight into this type of repair, patches L24, L25 and L29 were removed from the sea in 2008, together with the wooden parts of the ship to which



Sl. 77 Zakrpnj jezić (foto: Ph. Groscaux).

Fig. 77 Patch tenon (photo: Ph. Groscaux).

**Legenda / Legend**

- olovna zakrpa / lead patch
- mali drveni čavili / pegs

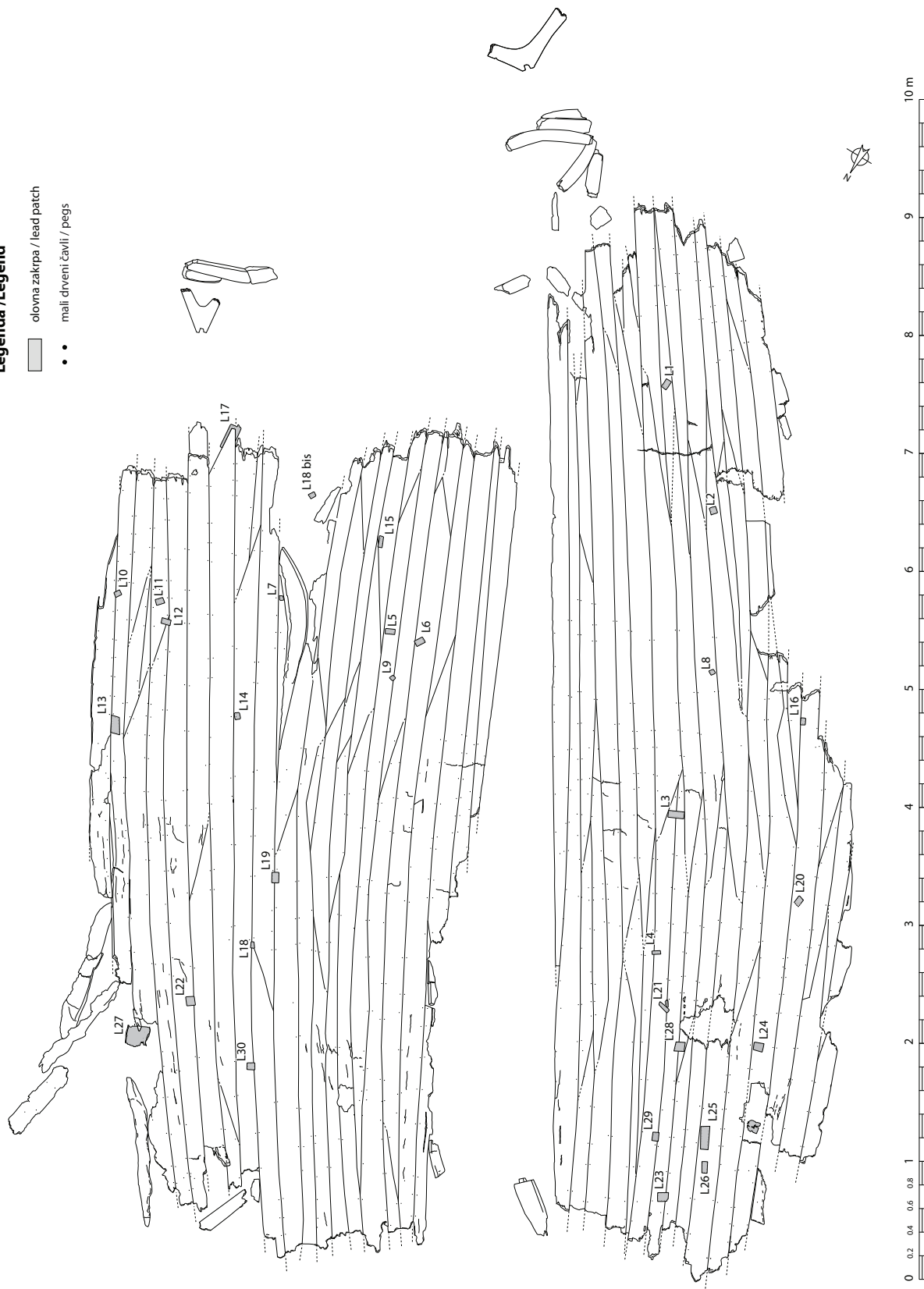

Sl. 78 Raspored olovnih ploča i pločica (M. Rival, V. Dumas).

Fig. 78 Distribution plan of lead patches (M. Rival, V. Dumas).



## ZAKRPNE OLOVNE PLOČICE L24 I L25

Rastavljanjem i analizom pločice L24 (od koje se očuvao samo sivkasti trag na osnovi kojeg se može reći da joj je izvorna duljina iznosila 7,2 cm, a širina 6,5 cm) utvrđeno je da se čvor u drvetu nalazio u visini utora izvedenog na platici P15W (Sl. 83, 85). Čvor koji je imao tendenciju izmicanja u smjeru unutrašnjosti oplata uzrokovao je pukotinu na platici. Kako bi se izbjeglo dodatno slabljenje oplata i, povrh svega, zapriječio prodor vode na toj točki, majstor je izradio svojevrstu zakrpu.

Na unutrašnju stranu platice P15W, preko čvora i okolnog drveta nanesen je sloj smole smeđesive boje, koja je stvorila nepropusni sloj. Preko nje pričvršćena je olovna pločica L24 kako bi zaštitila smolu i zapriječila drvenom čvoru potpuni izlazak iz ležišta. Pločicu je fiksiralo 8 metalnih čavlića koji su se očuvali samo u tragovima. Na istome mjestu, ali s vanjske strane platice nalazi se također trag olovne pločice fiksirane metalnim čavličima postavljanim u kutevima i po sredini svake stranice pločice (Sl. 79).

Ovaj tip reparacije primijenjen je i na platici P37W na kojoj se s unutrašnje strane nalazi pločica L25, a odgovarajuća pločica nalazi se i s njezine vanjske strane. Za razliku od pločice L24, u ovom je slučaju i prije postavljanja vanjske pločice na oplatu također bila nanescena smola. Na platici P37W, izrađenoj od drveta izrazito loše kvalitete, ispiljenog pri samom rubu trupca, olovna pločica bila je postavljena preko utora koji je bio urezan u čvor (Sl. 85). Fiksiranje pločice L26, ostavljene *in situ*, također je izvedeno na mjestu čvora koji se poklopio s mjestom na kojem se nalazi utora.

I na kraju, platice P15W i P37W bile su u toliko lošem stanju da im je prijetilo pucanje i prodor vode. Stoga je majstor pokušao popraviti stanje pomoću slojeva smole i olovnih pločica istovremeno na unutrašnjoj i vanjskoj strani u „sendvič” stilu.

they were attached (Fig. 83-85). It is obvious that they were used to prevent water leakage into the hull at sensitive places, which could have happened for a number of reasons. Patches L24 and L25 covered, for example, a natural knot in the wood, while patch L29 was used to close a crack.

It was possible to study the knots covered by lead patches on the planking *in situ*. Knots are a considerable problem only when they are at a place at which there is a mortise, as the presence of the former necessitates movement of the latter. Thus, in the interest of increasing strength at these points, a protective system was rendered with the help of a pitch-based glue, pitch alone, wooden pegs and patch itself (Fig. 84, 85). The same system was also applied to cracks.<sup>47</sup>

Hull repairs done with the help of larger and smaller lead patches have been confirmed at other Mediterranean shipwrecks dated to Late Antiquity. At the Port-Vendres I shipwreck (France, end of 4<sup>th</sup>/early 5<sup>th</sup> cent. AD) one lead patch protected the joint between the keel and gripe (Liou 1974: 417), while at the Yassi Ada II shipwreck (Turkey, 4<sup>th</sup> cent. AD), lead patches were used to reinforce damaged parts of the ship (Van Doorninck 1976: 128-129). More recently, repairs done with lead patches have been observed on the Porticcio shipwreck (Corsica, 3<sup>rd</sup> cent. AD; Alfonsi 2010).

## LEAD PATCHES L24 AND L25

Based on the removal and analysis of sample L24 (of which only a greyish trace of the original lead patch remains, it may be said that the original patch measured 7.2 x 6.5 cm. It was determined that the knot in the wood was at the level of the mortise made on plank P15W (Fig. 83, 85). The knot, which had a tendency to move inward on the planking, caused the plank to crack. In order to avoid additional weakening of the planking and, most importantly, prevent leakage at this point, the shipwright solved the situation with a repair.



Sl. 79 Primjer zakrpe olovne pločice (PK07/03), pričvršćene malim metalnim čavličima (foto: F. Groscaux).

Fig. 79 Example of lead patch (PK07/03), fixed with small metal nails (photo: Ph. Groscaux).



Sl. 80 Ulomak zakrpe olovne pločice (PK07/06), s uzorkom rombova postignutim urezivanjem prekrštenih kosih linija (foto: Ph. Groscaux).

Fig. 80 Fragment of lead patch (PK07/06), with the inner surface incised with a crosshatched pattern (photo: Ph. Groscaux).

## ZAKRPNNA OLOVNA PLOČICA L29

Treća izvađena pločica, L29, nije bila postavljena na mjestu čvora, već je riječ o stvarnom zatvaranju pukotine koja je mogla uzrokovati ulazak vode u brod. Ta pločica (dulj. 9,5; šir. 5,5 cm) bila je postavljena preko sljuba platica P34W i P35W, na mjestu na kojem se nalazio jezičac (Sl. 84, 85).

Analizom je utvrđeno da je jedna pukotina bila začepljena žutim vlaknima biljnog podrijetla, ubačenima s unutrašnje strane oplata. Preko njih bili su postavljeni jedan ili dva komada drveta, koji su se poslije raspali u četiri do pet manjih komadića. Pretpostavka je da su imali ulogu čepova za zaštitu pukotine, ali su po svoj prilici bili korišteni i za uguravanje materijala za šuperenje u prostor između dviju platica. Potom su premazani smeđežutom smolom i prekriveni olovnom pločicom (Sl. 85).

S vanjske strane na mjestu opisanoga popravka nisu bili postavljeni nikakvi slojevi ljepljive mase niti olovna pločica, ali je čitava pukotina bila zamazana debelim slojem zaštitne smole. Uzrok stvaranja pukotine upravo na tome mjestu bio je čvor koji se našao na samom rubu platice još prilikom njezinog rezanja.

A layer of grey-brown resin was applied to the internal side of plank P15W over the knot and the surrounding wood, which created an impermeable layer. Lead patch L24 was fastened on top of it to protect the resin and prevent the knot from entirely coming out of its slot. The patch was attached with 8 metal nails that have been preserved in traces. At the same place, but on the external side of the plank, there is also a trace of a lead patch attached by metal nails at its corners and in the middle of each of its sides (Fig. 79).

This type of repair was also applied to plank P37W, on which patch L25 is attached from the inside, with a corresponding patch on its external side as well. As opposed to plate L24, in this case pitch was applied to the planking even prior to attachment of the external patch. The lead patch was placed over a mortise cut into a knot on plank P37W, made of a very low quality wood cut from the very edge of a trunk (Fig. 85). The attachment of patch L26 (left *in situ*) was also done at the site of the knot, which corresponded to the place at which there is a mortise.

And finally, planks P15W and P37W were in such poor condition that they were at risk of cracking and leaking. The

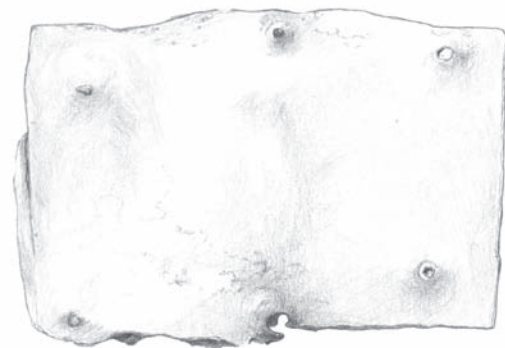
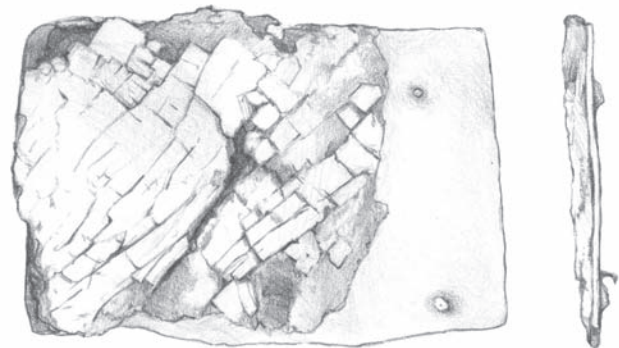

Sl. 81 Zakrpnna olovna pločica PK08/152: a) sloj smole na vanjskoj strani pločice; b) unutrašnja strana pločice (u kontaktu s drvom), (photo: Ph. Groscaux; drawing: N. Lete).

Fig. 81 Lead patch PK08/152: a) layer of pitch on the outer side of the patch; b) inner side of the patch (in contact with wood), (photo: Ph. Groscaux, drawing: N. Lete).





Sl. 82 Zakrpnna olovna pločica PK08/147 (ptoto: Ph. Groscaux).

Fig. 82 Lead patch PK08/147 (photo: Ph. Groscaux).

## BRODOGRAĐEVNA NAČELA I METODE

U slučaju broda nasukanoga kod otočića Velog Školja riječ je o longitudinalnoj konstrukciji zasnovanoj na oplati, kod koje je oblik određen vojevima oplata, a rebra igraju tek sekundarnu ulogu (Pomey 1988; 1998; 2004; Pomey, Rieth, 2005: 30-31). Spojevi platica uz pomoć utora i jezičaca poveznica su među vojevima i osiguravaju unutarnju koheziju brodske konstrukcije koja ne ovisi o elementima poprečne čvrstoće broda. Iako rebrenice i polurebrenice imaju funkciju učvršćenja trupa, one ni na koji način nisu povezane s rebrenim nastavcima.

Glede brodograđevnih faza, na osnovi proučavanja ostataka broda *in situ* moguće je pretpostaviti da je u prvome času tehnikom „prvo ljuska” bila izrađena oplata zasnovana na središnjim uzdužnim elementima (kobilica i statve), a potom su u nju dodani poprečni elementi. Ipak, budući da se nije pristupilo rastavljanju i vađenju broda, nema zasad dovoljno podataka na osnovi kojih bi se s preciznošću moglo rekonstruirati sve brodograđevne faze. Valja svakako naglasiti da su rebrenice F199W, F125W i F129W bile učvršćene za kobilicu pomoću svornjaka, što je uobičajeni postupak za vrijeme iz kojeg potječe nalaz. S obzirom na već višestruko spomenutu ograničenu količinu raspoloživih podataka, nije moguće pretpostaviti jesu li ti spojevi imali aktivnu ili pasivnu ulogu prilikom izgradnje broda.<sup>48</sup>

craftsman thus attempted to remedy the situation with the use of layers of pitch and lead patches on the inside and outside at the same time in a “sandwich” style.

## LEAD PATCH L29

The third lead patch to be extracted, L29, was not placed over a knot, rather it actually closed a crack that may have caused water to leak into the hull. This patch (lng. 9.5, wid. 5.5 cm) was placed over the joint between planks P34W and P35W, at the place where the tenon was located (Fig. 84, 85).

An analysis established that one crack was plugged with the yellow plant fibres, inserted from the inside of the planking. One or two pieces of wood were placed over them, but they later broke apart into five smaller pieces. It is assumed that these were plugs to protect the crack, but they were also used to stuff caulking material into the space between the two planks. Then they were coated with brown-yellow pitch and covered with a lead patch (Fig. 85).

No layers of glue nor lead patches were installed on the external side at the spot of the repairs, but the entire crack was coated with a thick layer of protective pitch. The crack was in fact caused by a knot placed at the very edge of the plank.

## SHIPBUILDING PRINCIPLES AND METHODS

The ship at the islet of Veli Školj is a longitudinal structure based on planking, in which the form was determined by strakes, while the frames played only a secondary role (Pomey 1988; 1998; 2004; Pomey, Rieth, 2005: 30-31). The mortise-and-tenon joints between the planks connected the strakes and ensured the internal cohesion of the hull, which did not depend on the transversal elements. Even though the floor-timbers and half-frames served to reinforce the shell, they were not connected to the futtocks in any way whatsoever.

With regard to the shipbuilding phases, based on a study of the hull remains *in situ*, it may be assumed that the planking based around the axial longitudinal elements (keel and posts) was initially assembled according to the shell-first technique, and then the transversal elements were added to it. However, since the ship was not taken apart and recovered, there are thus far insufficient data that could serve as the basis for a reconstruction of all shipbuilding phases. It should certainly be stressed that floor timbers F199W, F125W and F129W were fastened to the keel by bolts, which was the standard procedure during the period to which the shipwreck has been dated. Given the limited amount of available data – stressed repeatedly herein – it is impossible to speculate as to whether these joints played an active or passive role in the assembly of the ship.<sup>48</sup>





Sl. 83 Uzorkovani dio oplate s prirodnim čvorom, pod zakrpnom olovnom pločicom L24 (foto: Ph. Groscaux).

Fig. 83 Sampled part of planking with natural knot, under lead patch L24 (photo: Ph. Groscaux).



Sl. 84 Uzorkovani dio oplate pod zakrpnom olovnom pločicom L29; drvene strugotine iskorištene za popunu praznina oko čvora (foto: Ph. Groscaux).

Fig. 84 Sample of planking under lead patch L29; wood shavings used to fill the gap around the knot (photo: Ph. Groscaux).

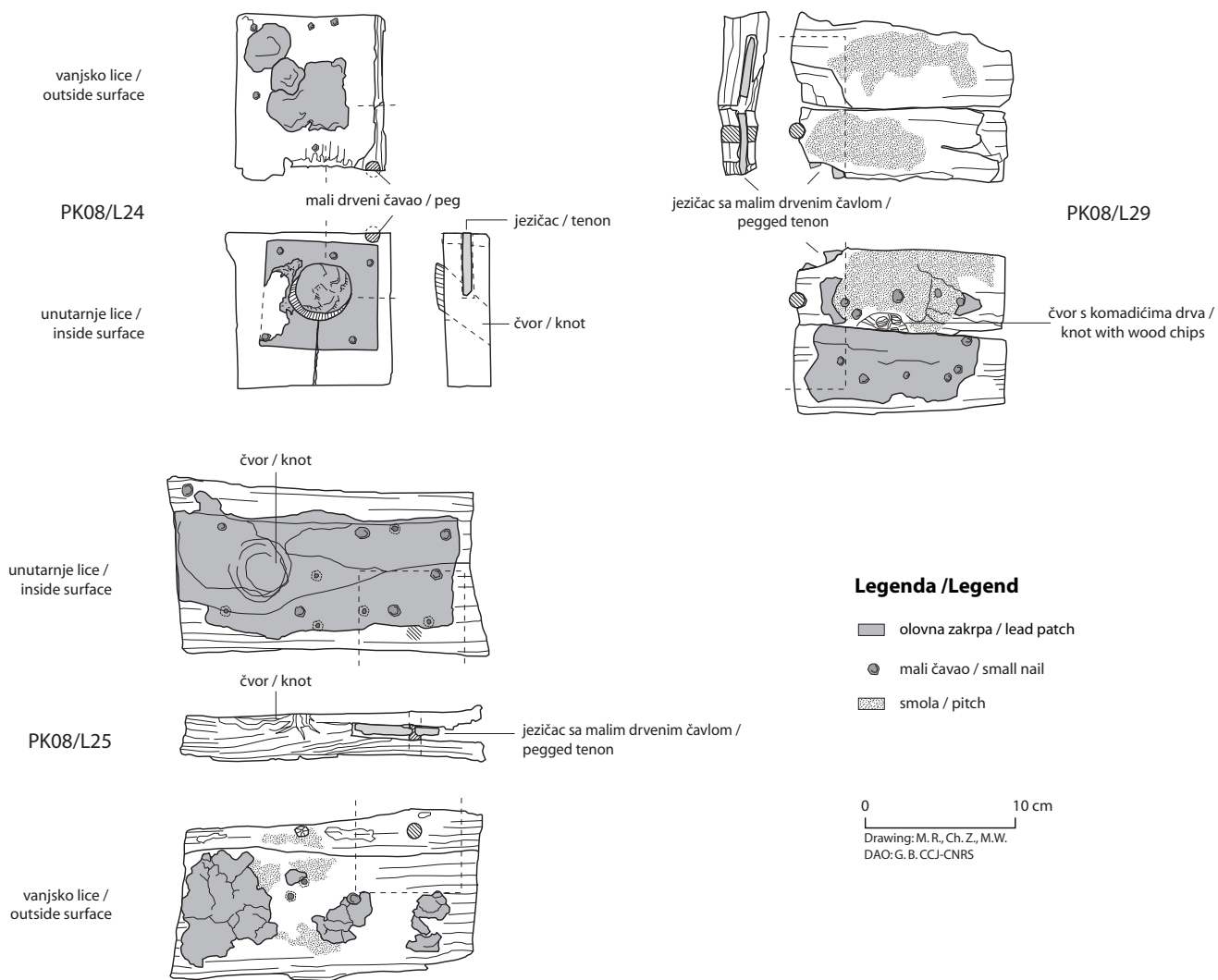

Sl. 85 Zakrpane olovne pločice L24, L29 i L25 (crtež: G. Boetto).

Fig. 85 Lead patches L24, L29 and L25 (drawing: G. Boetto).

## PROCJENA VELIČINE, TIPA I FUNKCIJE BRODA

Na osnovi prikupljenih podataka, prije svega na osnovi dimenzija sastavnih dijelova oplata i rebara, duljinu broda potonulog kod otočića Velog Školja moguće je procijeniti na oko 15 do 20 m. Riječ je o tipu broda karakterističnom za rimsko carsko doba, koji se prema definiciji koju je formulirao Patrice Pomey (1998: 68; Pomey, Rieth, 2005: 166-167) odlikuje sljedećim elementima:

- kobilica s jednostavnim dokobiličnim platicama na koje se nadovezuje zaravnjeno dno broda;
- jednostavna oplata izrađena stičnim spajanjem platica, međusobno povezanim sistemom utora i jezičaca, bez vanjske zaštitne olovne obloge;
- sustav kompozitnih rebara u kojem su svi elementi samostalni, u kojem se izmjenjuju rebrenice i polurebrenice, ali se među njih ubacuju rebrenice nejednakih krakova, a određene rebrenice pričvršćene su svornjacima za kobilicu;
- unutrašnji uzdužni elementi brodske konstrukcije među kojima je temeljnica jarbola položena na dohrptenice nad rebrima.

S izuzetkom rebrenica nejednakih krakova koje u slučaju ovog broda nisu prisutne, brod kod otočića Velog Školja odlikuje se svim nabrojenim elementima, uključivo i dohrptenicama koje se nisu očuvale, ali se njihovo postojanje može pretpostaviti na osnovi utora zamijećenih na rebrima. Oni upućuju i na temeljnicu jarbola koja je morala postojati na brodu, ali je nestala zajedno s kobilicom.

I na kraju, opisani brod, pokretan poglavito snagom vjetrova, najvjerojatnije se koristio za pomorski prijevoz robe, čemu u prilog idu značajke brodske konstrukcije, ali i moguća prisutnost tereta u trenutku brodoloma.

## ESTIMATE OF THE SHIP'S SIZE, TYPE AND FUNCTION

Based on the gathered data, and above all based on the dimensions of the integral components of the planking and frames, the length of the sunken ship at the islet of Veli Školj may be estimated to have been roughly 15 to 20 m. This was a typical vessel of the Roman era, which according to the definition formulated by Patrice Pomey (1998: 68; Pomey, Rieth, 2005: 166-167) was characterized by the following elements:

- a keel with simple garboard planks on which the ship's flattened bottom rested;
- simple flush-laid carvel planking, mutually connected by a system of mortises and tenons, without outer protective lead sheathing;
- a system of composite frames in which all elements are independent, in which floor-timbers and half-frames alternate, but with asymmetrical floor-timbers inserted between them, while certain floor timbers are bolted to the keel;
- internal longitudinal elements of the hull, and a mast step, set on the bilge keelsons above the frames.

With the exception of the asymmetrical floor timbers, which were not observed here, the ship at the islet of Veli Školj is characterized by all of these elements, including the bilge keelsons that were not preserved, but whose existence may be supposed on the basis of the recesses present on the frames. They also point to the mast step which had to have existed on the ship but were gone together with the keel.

And finally, the described ship, propelled primarily by the wind, was most likely used to transport goods by sea, which is backed by the features of the hull structure, as well as the possible presence of cargo at the time of the wreck.

- <sup>1</sup> *Cf. supra* (M. Parica). Istraživanje u organizaciji Odjela za arheologiju Sveučilišta u Zadru provedeno je pod vodstvom Zdenka Brusića, uz sudjelovanje Mate Ilkića iz istog Odjela te tadašnjih studenata arheologije Mate Parice i Marka Meštrova.
- <sup>2</sup> Istraživačkoj ekipi, s ciljem logističke podrške i izrade nacrtne, fotografske i videodokumentacije nalazišta, pridružili su se Irena Radić Rossi i Krunoslav Zubčić iz Odjela za podvodnu arheologiju Hrvatskog restauratorskog zavoda te podvodni snimatelj Marino Brzac.
- <sup>3</sup> Analiza je provedena u Laboratoriju za mjerenje niskih aktivnosti Zavoda za eksperimentalnu fiziku Instituta Ruđer Bošković u Zagrebu.
- <sup>4</sup> Godine 2007. sporazum o suradnji potpisali su Hrvatski restauratorski zavod, Centre Camille Jullian (Aix-en-Provence, Francuska) i udruga Arkaeos (Marseille, Francuska), a 2008. godine u ime hrvatskog partnera u sporazumu je nastupio Odjel za arheologiju Sveučilišta u Zadru. Na temelju sklopljenog ugovora međunarodna suradnja u području arheologije broda i arheologije pomorstva nastavila se do danas.
- <sup>5</sup> Projekt su financijski i organizacijski podržali Ministarstvo kulture RH, Centre Camille Jullian (Aix-en-Provence, Francuska) i Općina Pakoštane. Prethodna izvješća o tijeku i rezultatima podmorskog istraživanja objavljena su u više navrata: Radić Rossi, 2008a; 2008b; 2009; Boetto, Marlier, Radić Rossi, 2008; 2012; 2015; Boetto *et al.*, 2012.
- <sup>6</sup> *Cf. infra* (C. Huguet).
- <sup>7</sup> *Cf. infra* (F. Guibal *et al.*).
- <sup>8</sup> *Cf. infra* (C. Zazzaro).
- <sup>9</sup> *Cf. infra* (C. Huguet).
- <sup>10</sup> Keramički žeton (PK08/119: promjer 1,7 cm; debljina 0,4 cm, Sl. 23) i dva komada nečitkog novca (PK08/65 i PK08/135) u kvadratu F2 (Sl. 28, 29); ulomak staklene posude neidentificiranog oblika (PK08/105) u kvadratu E2 i ulomak drva s utorima (PK08/2) u kvadratu F3.
- <sup>11</sup> *Cf. infra* (F. Guibal *et al.*).
- <sup>12</sup> *Cf. infra* (C. Huguet).
- <sup>13</sup> Faunalne ostatke proučila je Audrey Renaud, tada doktorandica na Sveučilištu Paul-Valery, Montpellier (UMR 5140, Lattes), kojoj zahvaljujemo na suradnji i trudu. Riječ je o ulomku dijafize metakarpalne kosti odrasle jedinke iz roda *Ovis* ili *Capra* (ovca ili koza) i jednom ulomku kralješka malog biljojeda (*Ovis*, *Capra*, *Capreolus*).
- <sup>14</sup> PK08/79, pronađen u kvadratu G2.
- <sup>15</sup> PK08/74 i PK08/160.
- <sup>16</sup> Druga slična rješenja mogu se ostvariti uz pomoć drugih tipova linoleuma ili plastičnih materijala crne ili sive boje, na koje se oznake nanose vodootpornim flomasterima bijele ili žute boje.
- <sup>17</sup> Navedene elemente nije u svim slučajevima bilo moguće razlikovati, pa se zbog toga u trenutku istraživanja odlučilo primijeniti zajedničku oznaku, a konačne zaključke o vrsti konstruktivnog elementa donijeti tek nakon naknadne analize brodske konstrukcije.
- <sup>18</sup> Usp. npr. brodolom broda tipa *navis lapidaria* na nalazištu Kizilburun (Turska, 1. st. po Kr.): Carlson, 2006 i Higgins, 2007.
- <sup>19</sup> Na francuskim nalazištima stereo fotogrametrija počela se primjenjivati sedamdesetih godina prošloga stoljeća (usp. npr. brodolome *Planier 3*, Liou, 1973, i *Madrague de Giens*, Tchernia *et al.*, 1978). Fotogrametrija je poslije primijenjena i na nalazištu *Grand-Ribaud D* kako bi se skratilo vrijeme podmorskog dokumentiranja (Blaustein, Hesnard, 1988).
- <sup>20</sup> *Cf. supra*.

- <sup>1</sup> *Cf. supra* (M. Parica). Research organized by the Archaeology Department of the University of Zadar was conducted under the direction of Zdenko Brusić, with the participation of Mate Ilkić from the same department and Mate Parica and Marko Meštrov, both archaeology students at the time.
- <sup>2</sup> In order to provide logistical support and to draft sketches and compile photographic and video documentation of the site, the research team was complemented by Irena Radić Rossi and Krunoslav Zubčić from the Underwater Archaeology Department of the Croatian Conservation Institute, and underwater cameraman Marino Brzac.
- <sup>3</sup> The analysis was conducted in the Laboratory for Low-level Radioactivities of the Experimental Physics Division at the Ruđer Bošković Institute in Zagreb.
- <sup>4</sup> In 2007, the cooperation agreement was signed by the Croatian Conservation Institute, the Centre Camille Jullian (Aix-en-Provence, France) and the association Arkaeos (Marseille, France), while in 2008, the agreement was joined on behalf of the Croatian partner by the Archaeology Department of the University of Zadar. Based on the concluded agreement, international cooperation in the field of nautical archaeology and maritime archaeology continues to the present.
- <sup>5</sup> The project has received financial and organizational support from the Croatian Ministry of Culture, the Centre Camille Jullian (Aix-en-Provence, France), the Pakoštane Municipality and the region Provence-Alpes-Côte d'Azur. Prior reports on the course and results of the underwater research have been published in: Radić Rossi, 2008a; 2008b; 2009; Boetto, Marlier, Radić Rossi, 2008; 2012; 2015; Boetto *et al.*, 2012.
- <sup>6</sup> *Cf. infra* (C. Huguet).
- <sup>7</sup> *Cf. infra* (F. Guibal *et al.*).
- <sup>8</sup> *Cf. infra* (C. Zazzaro, S. Wicha).
- <sup>9</sup> *Cf. infra* (C. Huguet).
- <sup>10</sup> A ceramic token (PK08/119: diameter 1.7 cm; thickness 0.4 cm, Fig. 23) and two illegible coins (PK08/65 and PK08/135) in square F2 (Fig. 28, 29); shard of a glass vessel of unidentifiable shape (PK08/105) in square E2 and fragment of wood with grooves (PK08/2) in square F3.
- <sup>11</sup> *Cf. infra* (F. Guibal *et al.*).
- <sup>12</sup> *Cf. infra* (C. Huguet).
- <sup>13</sup> The faunal remains were studied by Audrey Renaud, then a doctoral student at Paul-Valery University, Montpellier (UMR 5140, Lattes), whom we thank for her cooperation and efforts. This is a piece of the diaphysis of the metacarpal bone of an adult individual from genus *Ovis* or *Capra* (sheep or goat) and one vertebral fragment from a small ruminant (*Ovis*, *Capra*, *Capreolus*).
- <sup>14</sup> PK08/79, found in grid square G2.
- <sup>15</sup> PK08/74 and PK08/160.
- <sup>16</sup> Another, similar solution may be implemented with the help of other types of linoleum or black or grey plastic materials, to which marks are applied with water-resistant white- or yellow-ink markers.
- <sup>17</sup> These elements could not be distinguished in all cases, so the decision was made to use a common designation during excavations, while the final conclusion on the type of constructive element will be made only after subsequent analysis of the ship's construction.
- <sup>18</sup> See for example, the wreck of a *navis lapidaria* type ship at the Kizilburun site (Turkey, 1<sup>st</sup> cent. AD). Carlson, 2006 and Higgins, 2007.



- <sup>21</sup> Fotograf Centra Camille Jullian, Philippe Groscaux, snimio je ostatke broda fotoaparatom Nikon D70s, s objektivom od 20 mm.
- <sup>22</sup> U trenutku pisanja ovog teksta navedeni program više nije bio dostupan.
- <sup>23</sup> Geodetsko snimanje brodoloma obavio je geodet Marijan Radović.
- <sup>24</sup> Bokoštitnici pripadaju tri ulomka P37E, P46E i P53E.
- <sup>25</sup> Položaj ostalih rebrenica utvrđen je na osnovi tragova veznih elemenata na oplati.
- <sup>26</sup> Srećom, godine 2004. napravljen je crtež u mjerilu 1:1 (Sl. 57.2). Riječ je o značajnom dokumentu koji je očuvao ne samo oblik elementa, već i važne mjere poput širine gornje površine kobilice koja se nije očuvala.
- <sup>27</sup> *Cfr. infra.*
- <sup>28</sup> Udaljenost među drvenim čavlicima za učvršćenje jezičaca bila je izmjerena na mjestima koja nisu bila prekrivena debelim zaštitnim slojem smole. Zbog takve situacije, na planu oplata (Sl. 51) spojevi uz pomoć jezičaca pričvršćenih drvenim čavlicima nisu prikazani na svim mjestima, što je posljedica nemogućnosti dokumentiranja, a ne nepostojanja takvih spojeva.
- <sup>29</sup> Izračun za raspored utora na dokobiličnim platicama izveden je na osnovi iznosa 6,8 cm (udaljenost među utorima) podijeljenog s 8,26 cm (širina utora). Izračun za raspored utora na ostalim platicama dobiven je dijeljenjem iznosa 8,7 cm (razmak među utorima) s 5,9 cm (širina utora).
- <sup>30</sup> Rezultati pokazuju da su na dokobiličnim platicama utori za spoj na kobilicu izvedeni tako da u slobodan prostor koji ostaje među njima nije moguće ubaciti još jedan utor (preciznije, ostaje prostora za 0,821 dio utora), dok je u slučaju ostalih platica u slobodan prostor među utorima moguće ubaciti još gotovo jedan i pol utor (preciznije, ostaje prostora za 1,47 utora).
- <sup>31</sup> Za objašnjenje stožastog oblika čavlića vidi Rival, 1991: 202.
- <sup>32</sup> Na brodolomima na kojima su sustavno izmjereni unutrašnji i vanjski promjeri svih drvenih čavlića, nakon što su s oplata uklonjeni elementi uzdužne čvrstoće, pokazalo se kako su oni uglavnom ubačeni s unutrašnje strane broda, uključivo i mjesta koja su poslije pokrivena rebriima. Riječ je o jednom od jasnih pokazatelja da je brod bio izgrađen tehnikom „prvo ljuska“. Suprotan smjer ubacivanja drvenih čavlića može se interpretirati kao pokazatelj prijelaza na tehniku „prvo kostur“ samo u slučaju kad su čavlići ubačeni na mjestima na kojima se s unutrašnje strane nalaze rebrenice. U slučaju brodoloma na lokalitetu *Bourse (Burza)* u Marseilleu (Francuska, 190. – 200. g. po Kr.), ubacivanje drvenih čavlića s vanjske strane broda primijećeno je tek ispod nekoliko rebrenica i u gornjem dijelu broda (Gassend, Cuomo, 1982a; 1982b; 1985). Taj detalj naveo je autore na pretpostavku da je riječ o kombinaciji dviju tehnika, što je poslije doveo u pitanje P. Pomey (1988; 2004). Vidi također Pomey, Rieth, 2005: 169-171.
- <sup>33</sup> Usp. čavliće s brodoloma *Madrague de Giens* (Rival, 1991: 195, tav. 54 e 95) i *Dramont E* (Santamaria, 1995: 145, tav. XVI); za objašnjenje malog utora na mjestu dodira s jezičcem vidi Rival, 1991: 195.
- <sup>34</sup> Rebro F99W nije se očuvalo, ali je moguće rekonstruirati njegov položaj na osnovi drvenih čavala uz pomoć kojih je bilo pričvršćeno na oplatu. Na isti način, nizovi drvenih čavala omogućuju rekonstrukciju položaja još nekih neočuvanih dijelova rebara.
- <sup>35</sup> F115W, F117W, F119W, F121W, F123W, F125W, F127W i F129W.
- <sup>36</sup> F112W, F118W, F120W, F122W, F124W, F126W i F128W.
- <sup>37</sup> Analize vrsta drvene građe ukazale su na veliku heterogenost vrsta iskorištenih za gradnju broda, ne upućujući na neke posebne vrste kojima se davala prednost prilikom popravaka; *cfr. infra.*
- <sup>38</sup> Slivnice su primijećene i na ulomku rebrenice pronađenom izvan
- <sup>19</sup> At French sites, stereo photogrammetry began to be used in the 1970s (cf., for example, shipwrecks such as the Planier 3, Liou, 1973, and Madrague de Giens, Tchernia *et al.*, 1978). Photogrammetry was later also applied to the Grand-Ribaud D site, in order to reduce the time needed for underwater documentation (Blaustein, Hesnard, 1988).
- <sup>20</sup> *Cf. supra.*
- <sup>21</sup> A photographer from the Centre Camille Jullian, Philippe Groscaux, shot the remains of the ship with a Nikon D70s camera with a 20 mm lens.
- <sup>22</sup> At the time when this text was written, this programme was no longer available.
- <sup>23</sup> The geodetic survey of the shipwreck was done by surveyor Marijan Radović.
- <sup>24</sup> Three pieces, P37E, P46E and P53E, belong to the wale.
- <sup>25</sup> The position of the remaining floor timbers was ascertained on the basis of traces of connective elements on the planking.
- <sup>26</sup> Fortunately, in 2004 a sketch at 1:1 scale was drawn (Fig. 57.2). This is a vital document, which preserved not only the shape of the elements, but also important measures such as the width of the upper surface of the keel, which had not been preserved.
- <sup>27</sup> *Cfr. infra.*
- <sup>28</sup> The distance between the wooden pegs to fasten the tenons was measured at places that were not covered with a thick protective layer of resin. Because of this, the map of the planking (Fig. 51) does not show the joints with the tenons fastened by wooden pegs at all places, which was a result of the impossibility of documentation rather than the absence of such joints.
- <sup>29</sup> The calculation for the distribution of mortises on the garboard planks was done on the basis of the value of 6.8 cm (the average distance between the mortises) divided by 8.26 cm (average width of mortises). The calculation of the distribution of mortises on the remaining plans was obtained by dividing 8.7 cm (the average interval between mortises) by 5.9 cm (average width of mortises).
- <sup>30</sup> The results show that on the garboard planks, the mortises to connect to the keel were rendered so that one more mortise could not be inserted into the free space that remained between them (to be precise, space for a 0.821 share of a mortise remained), while in the case of the remaining planks, almost one and a half mortise can be inserted in the free spaces among the mortises (to be exact, space for 1.47 mortises remained).
- <sup>31</sup> For an explanation of the conical shape of the pegs, see Rival, 1991: 202.
- <sup>32</sup> At shipwrecks where the internal and external diameters of all wooden pegs were systematically measured, after the frames were removed from the planking, it was found that they were generally inserted from the inside of the ship, including those places that were subsequently covered by frames. This is one of the clear indicators that the ship was constructed by the shell-first technique. The opposite direction of inserting wooden pegs may be interpreted as an indicator of the transition to the frame-first technique only in cases in which the pegs were inserted at places at which there are frames from the inside. In the case of the shipwreck at the Bourse site in Marseille (France, 190-200 AD), the insertion of wooden pegs from the outside of the ship was observed only under some frames and in the upper section of the ship (Gassend, Cuomo, 1982a; 1982b; 1985). This detail led the authors to assume that this entailed a combination of the two techniques (shell first and skeleton first), which was later challenged by P. Pomey (1988; 2004). See also Pomey, Rieth, 2005: 169-171. See recently Pomey, Kahanov, Rieth 2012.
- <sup>33</sup> Cf. the pegs from the Madrague de Giens shipwreck (Rival, 1991: 195, tab. 54 and 95) and Dramont E (Santamaria, 1995: 145, tab. XVI); for an

- izvornog položaja (PK07/F2) i na rebrima u zapadnom dijelu broda (rebrnice F115W, F117W, F119W, F121W, F123W, F125W, F127W i F129W; polurebrnice F112W, F118W, F124W, F126W i F128W).
- <sup>39</sup> F119W, F125W i F19W.
- <sup>40</sup> Iako metalni čavli nisu analizirani, dvije vrste metala sugerirane su na osnovi boje (crna za željezo i zelenkasto-plava za bakar).
- <sup>41</sup> Velik broj čavala, visine od 8,6 do 11 cm i promjera glavice od 1,5 do 2 cm, pronađen je u sloju oko brodoloma.
- <sup>42</sup> F119W, F121W, F122W i F123W.
- <sup>43</sup> Po pitanju datiranja vidi Bonifay *et al.*, 1998: 101.
- <sup>44</sup> Po pitanju datiranja vidi Bonifay, 2004: 105.
- <sup>45</sup> Zbog vremenskih ograničenja uzrokovanih, prije svega, raspoloživim financijskim sredstvima, nije bilo moguće sustavno dokumentirati sve spomenute indikatore prisutnosti unutrašnje oplate.
- <sup>46</sup> Ulomci platica PK07/P9 i PK07/P10; zakrpnj jezičac PK08/P80.
- <sup>47</sup> Prema informaciji dobivenoj od Marka Meštrova i danas se u Hrvatskoj neki vlasnici drvenih brodova koriste smjesom od smokava, osušenom na suncu, za zatvaranje pukotina na drvenoj građi, jer ju šećer koji sadrži čini učinkovitim ljepilom.
- <sup>48</sup> Više o elementima koji ukazuju na primjenu tehnike „prvo ljuska” na tehniku „prvo kostur” vidi u Pomey, Kahanov, Rieth, 2012 i 2013, gdje je navedena ostala relevantna literatura.
- <sup>49</sup> Tehnika dokumentiranja konopa preuzeta je iz Wendrich, 1994.
- <sup>50</sup> Analize je provela Stéphanie Wicha u Mediteranskom institutu za morsku i kontinentalnu bioraznolikost i ekologiju (Institut Méditerranéen de Biodiversité et d'Ecologie marine et continentale – IMBE) 2013. godine, zahvaljujući sredstvima francuskog Ministarstva vanjskih poslova i međunarodnog razvoja ((Ministère de l'Europe et des affaires étrangères - MEAE). Autorica zahvaljuje Régine Verlaque za pomoć pri određivanju vrste vlakana.
- <sup>51</sup> Mala dubina i sastav sedimenta na nalazištu (rastresiti pijesak s ulomcima školjaka) upućuju na mogućnost kontaminacije skupine nalaza predmetima koji ne pripadaju cjelini brodoloma. U tom smislu mogu se interpretirati tri velika ulomka amfore kampanskoga podrijetla. Preostala skupina keramičkih ulomaka homogena je po pitanju podrijetla i datiranja.
- <sup>52</sup> Zahvaljujem Michelu Bonifayu, istraživaču u institutu Camille Jullian (Aix Marseille Univ, CNRS, Minist Culture) na dragocjenim savjetima prilikom obrade keramičkih nalaza.
- <sup>53</sup> O razlikovanju broskog tereta i opreme broda vidi Beltrame, 2002: 6-8 i 42.
- <sup>54</sup> Kao što je to slučaj na mnogim brodolomima u Sredozemlju. Vidi npr. *Madrague de Giens* (Francuska, 75. – 60. g. pr. Kr.); Tchernia *et al.*, 1978: 20-21.
- <sup>55</sup> Na ulomku uljanice ne vide se tragovi gorenja, što je siguran pokazatelj korištenja uljanice na brodu (Beltrame, 2002). Moguće je, međutim, pretpostaviti kako su tragovi gorenja nestali zbog dugotrajnog djelovanja morske vode.
- <sup>56</sup> O predmetima koji potvrđuju prisutnost igara na brodu vidi Beltrame, 2002.
- <sup>57</sup> Oko 1 cm<sup>3</sup> drvene građe bio je uzet na mjestima na kojima je drvo bilo najkompaktnije i najbolje očuvano. Posebna pozornost posvećena je izbjegavanju mjesta na kojima su bili prisutni kanali nastali djelovanjem crvotočca ili broskog crva (*Teredo navalis*).
- <sup>58</sup> Danas Institut Méditerranéen de Biodiversité et d'Ecologie marine et continentale.
- explanation of the small narrowing at the point of contact with the tenon, see Rival, 1991: 195.
- <sup>34</sup> Frame F99W was not preserved, but it is possible to reconstruct its position on the basis of the treenails that helped fasten it to the planking. In the same way, rows of treenails allow for the reconstruction of the position of certain other unpreserved parts of the frames.
- <sup>35</sup> F115W, F117W, F119W, F121W, F123W, F125W, F127W, and F129W.
- <sup>36</sup> F112W, F118W, F120W, F122W, F124W, F126W, and F128W.
- <sup>37</sup> Analyses of the wood have underscored the great heterogeneity of the types used to build the ship, without giving an indication of any specific type that was preferred during repairs; cf. *infra*.
- <sup>38</sup> Limber holes were also observed on the floor timber piece found away from its original position (PK07/F2) and on the frames in the ship's western section (futtocks F115W, F117W, F119W, F121W, F123W, F125W, F127W, and F129W; half-frames F112W, F118W, F124W, F126W, and F128W).
- <sup>39</sup> F119W, F125W and F19W.
- <sup>40</sup> Even though the metal nails have not undergone analysis, the two types of metal are indicated on the basis of colour (black for iron and greenish-blue for copper).
- <sup>41</sup> A high number of nails, 8.6 to 11 cm high and head diameters from 1.5 to 2 cm, were found in the layer around the shipwreck.
- <sup>42</sup> F119W, F121W, F122W, and F123W.
- <sup>43</sup> On the question of dating, see Bonifay *et al.*, 1998: 101.
- <sup>44</sup> On the question of dating, see Bonifay, 2004: 105.
- <sup>45</sup> Due to the time constraints caused by, above all, available funding, it was not possible to systematically document all of these indicators of the presence of internal planking.
- <sup>46</sup> Plank fragments PK07/P9 and PK07/P10; patched tenon PK08/P80.
- <sup>47</sup> According to information obtained from Marko Meštrov, even today some owners of wooden boats in Croatia use a mixture of figs dried in the sun to fill cracks on wood, because the sugar they contain is an effective glue.
- <sup>48</sup> For more on the elements that indicate application of the shell-first technique and frame-first technique, see Pomey, Kahanov, Rieth, 2012 and 2013, in which the remaining relevant sources are cited.
- <sup>49</sup> The technique for documenting rope was taken from Wendrich, 1994.
- <sup>50</sup> The analysis was conducted by Stéphanie Wicha in the Mediterranean Institute of Marine and Terrestrial Biodiversity and Ecology (Institut Méditerranéen de Biodiversité et d'Ecologie marine et continentale – IMBE) in Aix-en-Provence in 2013, thanks to funding provided by the French Ministry of Foreign Affairs and International Development (Ministère des affaires étrangères et du développement international – MAEDI). The author would like to thank Régine Verlaque for her assistance in determining the type of fibre.
- <sup>51</sup> The modest all depth and composition of the sediment at the site (loose sand with pieces of seashells) point to the possibility of contamination of the set of finds with items that do not belong to the wreckage site. In this sense, they may be interpreted as three large fragments of Campanian amphorae. The remaining group of ceramic fragments is homogenous in terms of origin and dating.
- <sup>52</sup> The author is grateful to Michel Bonifay, director of Research at the Camille Jullian Institute (Aix Marseille Univ, CNRS, Minist Culture) for his valuable advice during the analysis of ceramic finds.
- <sup>53</sup> On the distinction between a ship's cargo and accessories, see Beltrame, 2002: 6-8 and 42.

- <sup>59</sup> Valja napomenuti kako je samo šest elemenata poprečne čvrstoće broda ostalo neanalizirano.
- <sup>60</sup> Podatci dobiveni iz polena izdvojenog iz smole iskorištene za zaštitu riječnog galo-rimskog broda *Arles-Rhône 3* upućuju na njezino lokalno podrijetlo: vidi Andrieu-Ponel, 2011 i Marlier, 2014.
- <sup>61</sup> Mali brod za lokalnu plovidbu (Caska, otok Pag, Hrvatska) i riječni brodovi (Lion i Arles, Francuska).
- <sup>62</sup> Korištenje ove vrste dokazano je također na nekim dijelovima rebara brodoloma *Pisa C* (Italija, poč. 1. st. po Kr.): Giachi *et al.*, 2003.
- <sup>63</sup> Kao primjer može nam poslužiti podatak da je prilikom istraživanja brodoloma YK 11 (MRY 5) iz 7. st. po Kr., otkrivenog na nalazištu Yenikapı, gdje se nalazila bizantska i srednjovjekovna luka Carigrada, istraživački tim Sveučilišta Texas A&M primijetio kako je hrptenica u pramčanom dijelu broda bila izrađena sekundarnom uporabom dijela kobilice drugog broda (osobno priopćenje C. Pulak, prosinac 2010.).
- <sup>54</sup> As was the case of many shipwrecks in the Mediterranean. See, e.g., *Madrague de Giens* (France, 75-60 BC); Tchernia *et al.*, 1978: 20-21.
- <sup>55</sup> No traces of burning can be seen on the oil-lamp, which is a certain indicator of its use on the ship (Beltrame, 2002). It is possible, however, to assume that the traces of burning disappeared due to the long-term effects of seawater.
- <sup>56</sup> On the items that confirm the presence of games played on board, see Beltrame, 2002.
- <sup>57</sup> Approximately 1 cm<sup>3</sup> of wooden material was taken at places where the wood was the most compact and best preserved. Particular attention was accorded to the avoidance of places where there are holes made by the boring of shipworms (*Teredo navalis*).
- <sup>58</sup> Now called the Institut Méditerranéen de Biodiversité et d'Ecologie marine et continentale.
- <sup>59</sup> It should be noted that only six elements of the ship's transversal carpentry remain unanalysed.
- <sup>60</sup> The data from the pollen extracted from the pitch used for the Gallo-Roman river ship, Arles-Rhône 3, indicate a local origin: see Andrieu-Ponel 2011 and Marlier 2014.
- <sup>61</sup> Small boat for local traffic (Caska, island of Pag, Croatia), river boats (Lyon and Arles, France).
- <sup>62</sup> The use of this wood type has also been proven on some parts of the frames at the Pisa C shipwreck (Italy, beg. 1<sup>st</sup> cent. AD): Giachi *et al.*, 2003.
- <sup>63</sup> A useful example here may be the fact that during exploration of the YK11 (MRY 5) shipwreck from the 7<sup>th</sup> cent. AD discovered at the Yenikapı site, the location of the Byzantine and medieval harbour of Constantinople, a research team from Texas A&M University noticed that the sternson of the ship had been made from the keel of another ship in secondary use (Pulak, Ingram, Jones, 2015).



## LITERATURA/ REFERENCES

- Alfonsi, H., 2010. Lépave de Porticcio. *Bilan scientifique du DRASSM 2008*. Ministère de la Culture et de la Communication, Paris, 95.
- Andrieu-Ponel, V., 2010. Le contenu pollinique de la poix de protection du bateau et des sédiments. In: Navires et navigation en Dalmatie romaine: Recherches d'archéologie maritime et navale à Caska (île de Pag, Croatie). Rapport des opérations 2010. Centre Camille Jullian, Aix-en-Provence, 62-67 (excavation report, not published).
- Andrieu-Ponel, V., 2011. Le pollen fossile des poix d'étanchéité d'Arles-Rhône 3: un paysage agricole diversifié, cultivé et parcouru par des troupeaux. In: D. Djaoui, S. Greck, S. Marlier (eds), *Arles Rhône 3. Le naufrage d'un chaland antique dans le Rhône, enquête pluridisciplinaire*. Éditions Actes Sud, Arles, 170-171.
- Andrieu-Ponel, V., 2012. Le contenu pollinique de la poix de protection de la coque. In: Boetto et al., 2012, 140-142.
- Andrieu-Ponel, V., Ponel, P., Bruneton, H., Leveau, P., 2000. Palaeoenvironments and cultural landscape of the last 2000 years reconstructed from pollen and coleopteran records in the lower Rhône valley, southern France. *The Holocene* 10, 3, 341-355.
- Argant, J., 2010. Apport de l'analyse pollinique à la connaissance du lieu d'approvisionnement en matériaux de calfatage des épaves du Parc Saint-Georges (Lyon). *Archaeonautica* 16, 230-235.
- Barišić, I., Ferenčak, M., Horvat, B., Kasum, J. (eds), 2003. *Peljar za male brodove, II. dio*. Hrvatski hidrografski institut, Split.
- Batović, Š., 1965. Rad Arheološkog muzeja u Zadru od 1960. do 1964. *Diadora* 3, 274-297.
- Batović, Š., 1973. Prapovijesni ostatci na Zadarskom otočju. *Diadora* 6, 5-139.
- Beltrame, C., 2002. *La vita di bordo in età romana*. Libreria dello Stato, Istituto Poligrafico e Zecca dello Stato, Roma.
- Beug, H. J., 1967. On the forest history of the dalmatian coast. *Review of Palaeobotany and Palynology* 2, 271-279.
- Beug, H. J., 1975. Changes of climate and vegetation belts in the mountains of Mediterranean Europe during the Holocene. *Biuletyn Geologiczny* 19, 101-110.
- Blaustein, M., Hesnard, A., 1988. Annexe 1 – Photogrammétrie, technique de prise de vue et précision de la restitution. In: A. Hesnard A., M.-B. Carre, M. Rival, B. Dangréaux, Lépave romaine Grand Ribaud D (Hyères, Var). *Archaeonautica* 8, 157-164.
- Boetto, G., 2008. Lépave de l'Antiquité tardive Fiumicino 1: analyse de la structure et étude fonctionnelle. *Archaeonautica* 15, 29-62.
- Boetto, G., Marlier, S., Radić Rossi, I., 2008. Late Roman shipwreck at Pakoštane: a preliminary report. In: I. Radić Rossi, A. Gaspari, A. Pydyn (eds), *Proceedings of the 13<sup>th</sup> Annual Meeting of the European Association of Archaeologists, Zadar, Croatia, 18-23 September 2007*. Hrvatsko arheološko društvo, Zagreb, 222-234.
- Boetto, G., Marlier, S., Radić Rossi, I., 2012. Lépave: la fouille et l'étude de la coque. In: Boetto et al., 2012, p. 109-128.
- Boetto, G., Marlier, S., Radić Rossi, I., 2015. Il relitto romano di Pakoštane (Croatia): la campagna di scavo 2007. In: D. Leone, M. Turchiano, G. Volpe (eds), *Atti del III convegno di archeologia subacquea, Manfredonia, 2007*. Edipuglia, Bari, 313-322.
- Boetto, G., Radić Rossi, I., Marlier, S., Brusić, Z. (eds), 2012. Lépave de Pakoštane, Croatie (fin IV<sup>e</sup> – début V<sup>e</sup> siècle apr. J.-C.). Résultats d'un projet de recherche franco-croate. *Archaeonautica* 17, 105-151.
- Boetto, G., Radić Rossi, I., 2017. Ancient ships from the bay of Caska (Island of Pag, Croatia). In: J. Litwin (ed.), *Baltic and Beyond. Change and continuity in shipbuilding*. Proceedings of the 14th International Symposium on Boat and Ship Archaeology (Gdansk 2015). National Maritime Museum, Gdansk, 279-288.
- Bonifay, M., 2004. *Études sur la céramique romaine tardive d'Afrique*, [BAR International Series 1301]. Archaeopress, Oxford.
- Bonifay, M., 2007. Que transportaient donc les amphores africaines?. In: Papi E. (ed.), *Supplying Rome and the Empire*. *Journal of Roman Archaeology Supplement* 69. 8-31.
- Bonifay, M., Capelli, C., Long, L., 2002. Recherches sur l'origine des cargaisons africaines de quelques épaves du littoral français. In: L. Rivet, M. Sciallano (eds), *Vivre, produire et échanger: reflets méditerranéens. Mélanges offerts à Bernard Liou*. Éditions Monique Mergoil, Montagnac, 195-200.

- Bonifay, M., Carre, M.-B., Rigoir, Y. (eds), 1998. *Fouilles à Marseille. Les mobiliers (Ier-VIIe siècles ap. J.-C., [Collection Études Massaliètes 5; Travaux du CCJ 22]. Éditions Errance-A.D.A.M., Paris-Lattes.*
- Brusić, Z., 1976. Gradinska utvrđenja u šibenskom kraju. *Materijali* 12, 113-123.
- Brusić, Z., 1977. Prehistorijski podmorski nalazi na području južne Liburnije. *Radovi Centra JAZU u Zadru* 24, 53-60.
- Brusić, Z., 2005. Luka Pakoštane – Jamica i položaj između otočića Sv. Justine i Velog Školja. *Hrvatski arheološki godišnjak* 1/2004, 191-192.
- Brusić, Z., 2005. *Tragovi prošlosti pakoštanskog kraja*, katalog izložbe. Općina Pakoštane, Pakoštane.
- Brusić, Z., 2006. Luka Pakoštane – Janice. *Hrvatski arheološki godišnjak* 2/2005, 306-307.
- Brusić, Z., 2007. Pakoštanska luka i druga priobalna liburnska naselja u Pašmanskome kanalu u odnosu na gradinska naselja u zaleđu i Aseriju / The port of Pakoštane and other coastal liburnian settlements in the Pašman Channel in relation to hill-fort settlements in the hinterland and Asseria. *Asseria* 5, 11-37.
- Capelli, C., 2012. Analyses archéométriques en lame mince des céramiques. In: Boetto et al., 2012, 132-134.
- Capelli, C., Bonifay, M., 2007. Archéométrie et archéologie des céramiques africaines: une approche multidisciplinaire. In: M. Bonifay, J.-C. Treglia (eds), *LRCW2. Late Roman Coarse Wares, Cooking Wares and Amphorae in the Mediterranean: Archaeology and Archaeometry* II, [BAR International Series 1662]. Archaeopress, Oxford, 551-568.
- Carlson, D. N., 2006. A monumental Cargo: The Roman Column Werck at Kizilburun, Turkey. *The INA Quarterly* 33.1, 3-9.
- Charrié-Duhaut, A., Connan, J., Darnell, M., Spangenberg, J., Szymczyk, E., Bissada, A., Albrecht, P., 2009. Molecular and isotopic characterization of organic samples from the wreck of the Saint-Etienne merchant ship (XVIIIth century): identification of pitch, fat, hair and sulfur. *Organic Geochemistry* 40, 647-665.
- D'Ambrosio, B., Mannoni, T., Sfrecola, S., 1994. La provenienza delle anfore romane di alcuni contesti italiani: possibilità e limiti del metodo mineralogico. In: *Amphores romaines et histoire économique, Actes du colloque de Sienne, 1986*, [Collection de l'École Française de Rome, 114]. École française de Rome, Roma, 269-284.
- Demesticha, S., 2011. The 4th-Century-BC Mazotos Shipwreck, Cyprus: a preliminary report. *International Journal of Nautical Archeology* 40. 1, 39-59.
- De Vos, M., 2001. *Rus Africum: Terra, acqua, olio nell'Africa settentrionale. Scavo e ricognizione nei dintorni di Dougga (Alto Tell tunisino)*, [Labirinti 50]. Università degli studi di Trento and Institut National du Patrimoine de Tunis, Trento.
- Drap, P., Long, L., 2005. Photogrammétrie et archéologie sous-marine profonde. Le cas de l'épave étrusque Grand Ribaud F. *Revue XYZ* 104.3, 25-34.
- Dore, J., 1989. The coarse pottery. In: J. Dore, N. Keay (eds), *Excavations at Sabratha 1948-1951. Vol. II. The finds*. Society for Libyan Studies, Tripoli, 87-248.
- Dumas, V., 2012. Annexe: la photogrammétrie numérique appliquée à l'architecture navale: le cas de l'épave de Pakostane. In: Boetto et al., 2012, 143-145.
- Fadić, I., 2003. *Asseria, 5 godina istraživanja (1998.-2002.)*. Arheološki muzej u Zadru, Arheološki muzej u Zagrebu i Filozofski fakultet u Zagrebu, Zadar, Zagreb.
- Fouache, E., Faivre, S., Gluščević, S., Kovačić, V., Tassaux, F., Dufaure, J.-J., 2005. Evolution of the Croatian shore line between Poreč and Split over the past 2000 years. *Archaeologia Maritima Mediterranea* 2, 115-134.
- Gassend, J.-M. (ed.), 1982. *Le navire antique du Lacydon*. Musée d'Histoire, Marseille.
- Gassend, J.-M., Cuomo, J.-P., 1982a. Construction de type alternée. In: J.-M. Gassend, J.-P. Cuomo, La construction alternée des navires antiques et de l'épave de la Bourse à Marseille. *Revue Archeologique de Narbonnaise* 15, 113-119.
- Gassend, J.-M., Cuomo, J.-P., 1982b. La construction alternée des navires antiques et de l'épave de la Bourse à Marseille. *Revue Archeologique de Narbonnaise* 15, 263-272.
- Gassend, J.-M., Cuomo, J.-P., 1985. Un acquis récent des recherches d'architecture navale: la "construction alternée" des navires antiques. In: *VI Congreso Internacional de Arqueología Submarina, Cartagena, 1982*. Ministerio de Cultura, Dirección General de Bella Artes y Archivos, Madrid, 343-350.

- Gassend, J.-M., Liou, B., Ximénès, S., 1984. Lépave 2 de l'anse des Laurons (Martigues, Bouches-du-Rhône). *Archaeonautica* 4, 75-105.
- Giachi, G., Lezzeri, S., Mariotti Lippi, M., Pacchioni, N., Paci, S., 2003. The wood of "C" and "F" Roman ships found in the ancien harbour of Pisa (Tuscany, Italy): the utilisation of different timbers and the probable geographical area which supplied them. *Journal of Cultural Heritage* 4, 269-283.
- Gianfrotta, P. A., Pomey, P., 1981. *Archeologia subacquea: storia, tecnica, scoperte e relitti*, Arnoldo Mondadori, Milano.
- Girard, M., 1978. Résultats préliminaires de l'analyse pollinique. In: A. Tchernia, P. Pomey, A. Hesnard, *Lépave romaine de la Madrague de Giens (Var). Campagnes 1972-1975, [XXXIVe Supplément à Gallia]*. CNRS, Paris, 112-116.
- Glušćević, S., 2001. Hidroarheološke i arheološke aktivnosti na zadarskom području. *Obavijesti Hrvatskog arheološkog društva* 33/1, 43-47.
- Green, J., 1991. Hull recording methods used at Mombasa. *The INA Quarterly* 18.2, 8-13.
- Green, J., Matthews, S., Turanli, T., 2002. Underwater archaeological surveying using PhotoModeler Virtual Mapper: different applications for different problems. *International Journal of Nautical Archaeology* 31.2, 283-292.
- Guibal, F., Pomey, P., 2003. Timber Supply and Ancient Naval Architecture. In: C. Beltrame (ed.), *Boats, Ships and Shipyards, Proceedings of the IX International Symposium on Boat and Ship Archaeology (ISBSA 9), Venice, 2000*. Oxbow books, Oxford, 35-41.
- Guibal, F., Greck, S., Cenzon-Salvayre, C., 2012. Analyse xylogologique de la coque et du fardage. In: Boetto *et al.*, 2012, 134-140.
- Hattler, C. (ed.), 2009. *Erben des Imperiums in Nordafrika. Das Königreich der Vandalen*, katalog izložbe. Badisches Landesmuseum Karlsruhe, Karlsruhe.
- Hayes, J. W., 1972. *Late Roman Pottery*. British School at Rome, London.
- Heim, J., 1970. *Les relations entre les spectres polliniques récents et la végétation actuelle en Europe occidentale*, diss. Université de Louvain, Louvain-la-Neuve.
- Higgins, C. R., 2007. Learning How to Map a 70-Ton Ship. *The INA Quarterly* 34.1, 11-12.
- Huguet, C., 2012. La céramique et les matériaux de construction en terre cuite. In: Boetto *et al.*, 2012, 128-132.
- Ilkić, M., Meštrov, M., 2007. Nalazi rimskog novca iz Pakoštana. *Vjesnik Arheološkog muzeja u Zagrebu* 40, 339-346.
- Ilkić, M., Parica, M., Meštrov, M., 2008. Ancient port complex in Pakoštane near Zadar. In: I. Radić Rossi, A. Gaspari, A. Pydyn (eds), *Proceedings of the 13<sup>th</sup> Annual Meeting of the European Association of Archaeologists, Zadar, Croatia, 18-23 September 2007*. Hrvatsko arheološko društvo, Zagreb, 212-221.
- Iveković, Ć., 1932. Istraživanje starina u Biogradu na Moru i njegovoj okolini. *Ljetopis JAZU* 44, 146-157.
- Jacquot, C., 1955. *Atlas d'anatomie des bois des conifères*, 1-2. Centre technique du bois, Paris.
- Jacquot C., Trenard Y., Dirol D., 1973. *Atlas d'anatomie des bois d'angiospermes (Essences feuillues)*. 1-2. Centre technique du bois, Paris.
- Jelić, L., 1898. Povijesno-topografske crtice o biogradskom primorju. *Vjesnik za arheologiju i historiju dalmatinsku* 3, 33-126.
- Joncheray, J.-P., 1974. Étude de l'épave Dramont D, dite "des pelvis". *Cahiers d'Archéologie Subaquatique* 3, 21-44.
- Joncheray, J.-P., 1975. *Lépave "C" de la Chrétienne* [Ier supplément aux Cahiers d'Archéologie Subaquatique]. Cahiers d'Archéologie Subaquatique, Gap.
- Katzev, M., 1972. The Kyrenia Ship. In: G. F. Bass (ed.), *History of Seafaring; Based on Underwater Archaeology*. Thames and Hudson, London.
- Kocabaş, I. Ö., 2008. Documentation: Reading the timber. In: U. Kocabaş (ed.), *The 'Old Ships' of the 'New gate' / Yenikapı'nın Eski Gemileri İstanbul, vol. 1*. Ege Yayınları, İstanbul, 37-72.
- Liou, B., 1973. Informations Archéologiques; Recherches sous-marines. *Gallia* 31, 571-608.
- Liou, B., 1974. Lépave romaine de l'anse Gerbal à Port-Vendres. *Comptes rendus des séances de l'Académie des Inscriptions et Belles-Lettres*, 414-433.
- Long, L., 1997. Inventaire des épaves de Camargue, de l'Espiguette au Grand Rhône. Des cargaisons de fer antiques aux gisements du XIXe s. Leur contribution à l'étude du paléorivage. In: M. Baudat (ed.), *Crau, Alpilles, Camargue. Histoire et archéologie, Actes du colloque, Arles, 1995*. Groupe archéologique arlésien, Arles, 65-68.
- Magaš, D., 1990. Osnovna geografska obilježja biogradske mikroregije. In: Š. Batović (ed.), *Biograd i njegova okolica u prošlosti: zbornik radova sa znanstvenoga skupa održanog u Biogradu od 11. do 13. studenoga 1988. godine*, [Biogradski zbornik 1]. Filozofski fakultet Zadar, Zadar, 39-84.



- Marlier, S., Greck, S., Guibal, F., Andrieu-Ponel, V., 2012. Arles-Rhône 3: Architectural and Paleobotanical Study of a Gallo-Roman Barge from the 1<sup>st</sup> Century in the Rhône River. In: Günsenin N. (ed.), *Between Continents, Proceedings of the XII International Symposium on Boat and Ship Archaeology (ISBSA 12), Istanbul, 2010*. Ege Yayinlari, Istanbul, 203-210.
- Marlier, S. (ed.), 2014. *Arles-Rhône 3. Un chaland gallo-romain du 1<sup>er</sup> siècle ap. J.-C.* Editions du CNRS, Musée départemental Arles antique, Paris.
- Mouchot, D., 1968.-1969. Épave romaine A du port de Monaco. *Bulletin du Musée d'anthropologie préhistorique de Monaco* 15, 159-200.
- Muller, S. D., 2004. Palynological study of Antique shipwrecks from the western Mediterranean Sea, France. *Journal of Archaeological Science* 31, 343-349.
- Nieto, X., Jover, J., Izquierdo, P., Puig, A. M., Alaminos, A., Martin, A., Pujol, M., Palou, H., Colomer, S., 1989. *Excavacions arqueològiques subaquàtiques a Cala Culip, I*, [Sèrie Monogràfica del Centre d'Investigacions Arqueològiques 9]. Centre d'Investigacions Arqueològiques, Gérone.
- Parica, M., 2008. Istočnomediterranska keramika iz antičke luke u Pakoštanima. *Prilozi Instituta za arheologiju u Zagrebu* 25, 81-96.
- Perićić, Š., 1990. Prilog poznavanju gospodarstva biogradskog kraja u drugoj polovici XIX. stoljeća. In: Š. Batović (ed.), *Biograd i njegova okolica u prošlosti: zbornik radova sa znanstvenoga skupa održanog u Biogradu od 11. do 13. studenoga 1988. godine*, [Biogradski zbornik 1]. Filozofski fakultet Zadar, Zadar, 477-488.
- Pešić, M., 2013. Research of the Waters of the Islet of Babuljaš near pakoštane / Istraživanja podmorja otočića Babuljaša kod Pakoštana. *Submerged Heritage / Potopljena baština* 3, 33-37.
- Pešić, M., 2016. New Results from Babuljaš Investigation / Novi rezultati istraživanja podmorja Babuljaša. *Submerged Heritage / Potopljena baština* 6, 17-21.
- Pomey, P., 1988. Principes et méthodes de construction en architecture navale antique. In: *Navires et commerces de la Méditerranée antique: hommage à Jean Rougé*. *Cahiers d'Histoire* 33, 3-4, 397-412.
- Pomey, P., 1998. Conception et réalisation des navires de l'Antiquité méditerranéenne. In: Rieth E. (ed.), *Concevoir et construire les navires. De la trière au picoteux*. *Technologies, Idéologies, Pratiques*, [Technologies/Idéologies/Pratiques, Revue d'anthropologie des Connaissances, XIII, 1]. Éditions Erès, Ramonville, 49-72.
- Pomey, P., 2002. Remarque sur la faiblesse des quilles des navires antiques à retour de galbord. In: L. Rivet, M. Sciallano (eds), *Vivre, produire et échanger. Reflets méditerranéens. Mélanges offerts à B. Liou*, [Archéologie et Histoire Romaine 8]. Éditions Monique Mergoïl, Montagnac, 11-19.
- Pomey, P., 2004. Principles and Methods of construction in ancient naval architecture. In: F. M. Hocker, C. A. Ward (eds), *The Philosophy of shipbuilding. Conceptual approaches to the study of wooden ships*. Texas A & M University Press, College Station, 25-36.
- Pomey, P., Rieth, É., 2005. *L'archéologie navale*, [Collection "Archéologiques"]. Errance, Paris.
- Pradell, T., Vendrell-Saz, M., Krumbein, W., Picon, M., 1996. Altérations de céramiques en milieu marin: Les amphores de l'épave romaine de la Madrague de Giens (Var). *Revue d'Archéométrie* 20, 47-56.
- Pulak, C., Ingram, R., Jones, M., 2015. Eight Byzantine Shipwrecks from the Theodosian Harbour Excavations at Yenikapi in Istanbul, Turkey: An Introduction. *International Journal of Nautical Archaeology* 44.1, 39-73.
- Quézel, P., Médail, F., 2003. *Écologie et biogéographie des forêts du bassin méditerranéen*, [Collection Environnement]. Elsevier, Paris.
- Radić Rossi, I., 2008. Pakoštane – Veli Školj. *Hrvatski arheološki godišnjak* 4/2007, 398-400.
- Radić Rossi, I., 2008. Pakoštane 2007. – 2008.: istraživanje kasnoantičkog brodoloma i stručno usavršavanje u području nautičke arheologije. *Obavijesti Hrvatskog arheološkog društva* 40/3, 60-71.
- Radić Rossi, I., 2009. Pakoštane – Veli Školj, *Hrvatski arheološki godišnjak* 5/2008, 492-495.
- Radić Rossi, I., 2012. Podvodna/podmorska arheologija, arheologija pomorstva i arheologija broda: razmatranje terminoloških pitanja. *Archaeologia Adriatica* 6.1, 207-230.
- Radić Rossi, I., 2017. Osnovna terminologija za potrebe arheologije broda / Basic nautical archaeology terminology. *Archaeologia Adriatica* 9 (2015), 415-453.
- Radić Rossi I., Antonioli F., 2008. Preliminary considerations on the ancient port of Pakoštane (Croatia) based on archaeological and geomorphologic research. In: *Book of abstracts, 14th Annual Meeting of the European Association of*

- Archaeologists, Valetta, Malta, 2008. European Association of Archaeologists, Valetta, 98-99.*
- Radić Rossi, I., Boetto, G., 2010. Arheologija broda i plovidbe – Šivani brod u uvali Caski na Pagu, Istraživačka kampanja 2009. *Histria Antiqua* 19, 299-307.
- Reille, M., 1992. *Pollen et spores d'Europe et d'Afrique du Nord*. Éditions du Laboratoire de Botanique Historique et Palynologie, Marseille.
- Reille, M., 1995. *Pollen et spores d'Europe et d'Afrique du Nord. Supplément 1*. Éditions du Laboratoire de Botanique Historique et Palynologie, Marseille.
- Reille, M., 1998. *Pollen et spores d'Europe et d'Afrique du Nord. Supplément 2*. Éditions du Laboratoire de Botanique Historique et Palynologie, Marseille.
- Rival, M., 1991. *La charpenterie navale romaine. Matériaux, méthodes, moyens*, [Travaux du Centre Camille Jullian 4]. Éditions du CNRS, Paris.
- Santamaria, C., 1995. *L'épave Dramont E à Saint-Raphaël (Ve siècle ap. J.-C.)*, [Archaeonautica 13]. Éditions du CNRS, Paris.
- Santoro Bianchi, S., 2005. Ceramica di Pantelleria („Pantelleria ware“). U: Gandolfi D. ur. La ceramica e i materiali di età romana. Classi, produzioni, commerci e consumi. *Quaderni della Scuola Interdisciplinare delle Metodologie Archeologiche* 2, 339-348.
- Schweingruber, F. H., 1978. *Mikroskopische Holzanatomie*. Eidg. Anst. Forstl. Versuchswes, Birmensdorf.
- Schweingruber F. H., 1990. *Anatomie europäischer Hölzer. Anatomy of European woods*. Eidgenössische Forschungsanstalt für Wald, Schnee und Landschaft, Birmensdorf (Hrsg.), Haupt, Bern und Stuttgart
- Sciallano, M., Marlier, S., 2008. L'épave à *dolia* de l'île de la Giraglia (Haute-Corse). *Archaeonautica* 15, 113-151.
- Suić, M., 1981. *Prošlost Zadra I*. Filozofski fakultet u Zadru, Zadar.
- Šoštarić, R., 2005. The development of postglacial vegetation in coastal Croatia. *Acta Botanica Croatica* 64.2, 383-390.
- Tchernia, A., Pomey, P., Hesnard, A., 1978. *L'épave romaine de la Madrague de Giens (Var), Campagnes 1972-1975*, [XXXIV Supplément à Gallia]. Éditions du CNRS, Paris.
- Tutin T. G., Burges N. A., Chater A. O., Edmondson J. R., Heywood V. H., Moore D. M., Valentine D. H., Walters S. M., Webb, D. A., 1993. *Flora Europaea, Volume 1, Psilotaceae to Platanaceae*. Cambridge University Press, Cambridge.
- Tutin, T. G., Heywood, V. H., Burges, N. A., Moore, D. M., Valentine, D. H., Walters, S. M., Webb, D. A., 1968. *Flora Europaea, Volume 2, Rosaceae to Umbelliferae*. University Press, Cambridge.
- Van Doorninck, F. H. 1976. The 4th century wreck at Yassi Ada. An interim report on the hull. *International Journal of Nautical Archaeology* 5.2, 115-131.
- Van Doorninck, F. H. 1982. The galley. In: G. F. Bass, F. H. Van Doorninck (eds), *Yassi ada. Volume I. A Seventh Century Byzantine Shipwreck*. Texas A&M University Press, College Station, 87-120.
- Venet, J. 1986. *Identification et classement des bois français*. E.N.G.R.E.F., Nancy.
- Vernet, J.-L., Ogereau, P., Figueiral, I., Machado Yanes, C., Uzquiano, P. 2001. *Guide d'identification des charbons de bois préhistoriques et récents, Sud-ouest de l'Europe: France, Péninsule ibérique et îles Canaries*. Editions du CNRS, Paris.
- Vrsalović, D. 1974. *Istraživanja i zaštita podmorskih arheoloških spomenika u SR Hrvatskoj*. Republički zavod za zaštitu spomenika kulture, Zagreb.
- Vrsalović, D. 1979. *Arheološka istraživanja u podmorju istočnog Jadrana; Prilog poznavanju trgovačkih plovni putova i gospodarskih prilika na Jadranu u antici, diss.*, Sveučilište u Zagrebu. Republički zavod za zaštitu spomenika kulture, Zagreb.
- Vrsalović, D. 1981. Neki primjeri gradnje antičkih lučkih objekata u podmorju istočnog Jadrana. *Godišnjak zaštite spomenika kulture Hrvatske* 6-7, 107-118.
- Weinstein-Evron, M.; Chaim, S. 2003. Palynological investigations. In: E. Black (ed.), *The Ma'agan Mikhael Ship. The Recovery of a 2400-Year-Old Merchantman, Final Report, Volume 1*. Israël Exploration Society and University of Haifa, Haifa, 221-229.
- Wendrich W. 1994. *Who is Afraid of Basketry. A guide to recording basketry and cordage for archaeologists and for ethnographers*. CNWS Leiden University, Leiden.
- Wicha, S.; Girard, M. 2006. Archaeobotanical characterisation of three ancient sewn Mediterranean shipwrecks. In: L. Blue L., F. Hocker F., A. Englert A. (eds), *Connected to the sea, Proceedings of the 10th International symposium on Boat and ship archaeology (ISBSA 10), Roskilde, 2003*. Oxbow books, Oxford, 111-116.