



**HAL**  
open science

## Ancient Mediterranean Sewn-Boat Traditions

Patrice Pomey, Giulia Boetto

► **To cite this version:**

Patrice Pomey, Giulia Boetto. Ancient Mediterranean Sewn-Boat Traditions. *International Journal of Nautical Archaeology*, 2019, 48 (1), pp.5-51. 10.1111/1095-9270.12337 . halshs-02059329v1

**HAL Id: halshs-02059329**

**<https://shs.hal.science/halshs-02059329v1>**

Submitted on 30 Dec 2019 (v1), last revised 8 Feb 2022 (v2)

**HAL** is a multi-disciplinary open access archive for the deposit and dissemination of scientific research documents, whether they are published or not. The documents may come from teaching and research institutions in France or abroad, or from public or private research centers.

L'archive ouverte pluridisciplinaire **HAL**, est destinée au dépôt et à la diffusion de documents scientifiques de niveau recherche, publiés ou non, émanant des établissements d'enseignement et de recherche français ou étrangers, des laboratoires publics ou privés.

## Ancient Mediterranean Sewn-Boat Traditions

Patrice Pomey and Giulia Boetto

*Aix Marseille Univ, CNRS, CCJ, Centre Camille Jullian, F-13100, Aix-en-Provence, France, pomey@msh.univ-aix.fr, boetto@msh.univ-aix.fr*

This article provides a summary and analysis of current knowledge of the archaeological remains of the 64 sewn boats that have been excavated in the Mediterranean region, dating from the Bronze Age to the Medieval periods. A detailed examination of the construction techniques, particularly the methods used to assemble and seal sewn planks and the systems used for lashing frames to the planking, has enabled six distinct construction traditions to be distinguished within the sewn-boat assemblage. Phases within these traditions are examined, alongside transitions to mortise-and-tenon fasteners, and explanations for the longevity of sewn techniques in specific regions are suggested.

© 2019 The Authors

*Key words:* sewn boats, lashed frames, shipbuilding, technology, Ancient Mediterranean.

The existence of ancient Mediterranean sewn boats has long been recognized thanks to numerous well-attested texts that refer directly to assembly by ligatures (Casson, 1963, 1971: 9–10; Pomey, 1981, 1985). In addition, iconographic data—which is often difficult to interpret—appears to confirm the use of this technique in the Mediterranean from at least the Bronze Age. For example, Basch (1987: 70–73) interpreted the painted motifs and alignments of holes seen on several Cypriot boat models as elements indicating skins sewn on to a frame. He also interpreted the zigzag pattern seen on the boats incised on the terracotta ‘frying pans’ of Syros as schematic ligatures (Basch, 1987: 86). Moreover, Bonino (1985) considered that the zoomorphic figureheads of the Sardinian Nuragic votive bronze boat models are lashed to the sternposts and that the models represent fully sewn boats.

Elsewhere, in Egypt, ligatures are well attested in Pharaonic-era shipbuilding, as illustrated by several boats including the famous Cheops’ ship (Landström, 1970; Lipke, 1984; Ward, 2000). But, according to current data, the Egyptian tradition, mainly based on transversal lashings (rail to rail lashings) or independent ligatures, is specific to ancient Egypt, and no Mediterranean parallel has been identified to date (Marlier, 2005, 2007: 17, fig. 9; Pomey, 2011a).

Before presenting the ancient Mediterranean sewn boats, it seems important to summarize previous research in this field, from the early work of Casson in 1963 onwards. Here we consider studies of vessels that use any type of ligatures, either to assemble the whole hull or parts of it: these are designated by the authors as ‘sewn boats’.

It was long considered that the testimonies of Greek and Latin authors, such as Homer (*Iliad*, 135), Aeschylus (*Suppliants*, 134–135), Pacuvius (quoted by Verrius Flaccus in Festus, 508, 33), Varro (quoted by Aulus Gellius, XVII, 3, 4), Virgil (*Aeneid*, 6, 413–414), Strabo (7, 4, 1), Pliny (*N. H.*, XXIV, 65) and even later St Jerome (*Epistolae*, 128, 3), referred mainly to the mythological context of a bygone heroic past (Casson, 1963), or perhaps to an archaic technique, and certainly a primitive one. Indeed, the absence of iconographic evidence clearly depicting sewn boats from more recent times and the predominance of the mortise-and-tenon joint in Greco-Roman and Punico-Phoenician shipbuilding, attested by the ancient shipwrecks known in the early 1960s, seemed to confirm the absence of a real and widespread tradition of sewn boats in the Mediterranean.

However, from the end of the 1960s until the mid 1980s, the discovery of archaeological remains of sewn boats, or the re-evaluation of previously excavated remains—as has been the case for the wrecks of: Cervia and Pomposa (Bonino, 1968, 1971), Zaton (also named Nin, Brusić, 1968; Brusić and Domjan, 1985), Laidbach (now named the Lipe wreck, discovered in 1890, Müllner, 1892, reconsidered by Salemke, 1973); Bon-Porté 1 (discovered 1976, interpreted by Pomey, 1981); Comacchio (Boccaccini *et al.*, 1983; Bonino, 1985), and Giglio (Bound, 1985)—has gradually revealed the importance of sewing and lashing techniques within Mediterranean shipbuilding (Pomey, 1985).

These discoveries encouraged scholars to reconsider the problem of Mediterranean sewn boats at a conference dedicated to ‘Sewn Plank Boats’ held in

Greenwich in 1984 (McGrail and Kentley, 1985) and led to the reinterpretation of some of the ancient texts. In particular the construction of Odysseus' boat (Homer, *Odyssey*, 5, 244–257) was interpreted by Mark as a sewn boat (Mark, 1991; 1996; 2005; Tchernia, 2001), rather than a mortise-and-tenon built boat as previously proposed by Casson (1964, 1971: 217–219; 1992). In 1993 the discovery of two Archaic Greek shipwrecks in Marseilles, Jules-Verne 7 and 9, enabled the existence of a genuine Mediterranean sewn-boat tradition to be confirmed, as attested by several other wrecks, and allowed its development within a Greek context to be examined (Pomey, 1995, 1997, 2010, 2016, 2017b).

In the 1990s, excavation of the Mazarrón 1 and 2 wrecks revealed another system of shipbuilding using lashings found on the Iberian coast (Negueruela *et al.*, 1995; Negueruela and Ortiz, 2004; Negueruela, 2000, 2005). Subsequently, new data concerning the Binisafúller wreck (De Juan *et al.*, 2010) and the re-evaluation of the Golo wreck led to the boats being considered not as Phoenician, as proposed by Negueruela, but rather as belonging to an Iberian tradition influenced by Punic contacts and colonization (Pomey, 2012).

Also in the 1990s, Beltrame started collating data on sewn wrecks from the Northern Adriatic coasts of Italy, showing the persistence and widespread use of sewing techniques in this area (Beltrame, 1996, 2000, 2001, 2002a, 2002b, Beltrame and Gaddi, 2013).

At the beginning of the 2000s, another technical solution using frames assembled by internal lashing was identified (Pomey, 2002). By this point, the importance of sewing and lashing techniques in Mediterranean shipbuilding had been largely recognized (McGrail, 2001: 134–138; Marlier, 2005; Polzer, 2010, 2011: 364–368).

Finally, over the past 15 years research in the Adriatic has continued to produce new data. In 2004, as a result of the discovery of a third sewn boat in Zaton (Glušćević, 2004) and the excavation of several other sewn shipwrecks in Dalmatia (Čelhar, 2008; Radić Rossi, 2008, 2010, 2011; Radić Rossi and Boetto, 2010, 2011; Boetto and Radić Rossi, 2014, 2017) and in Istria (Koncani Uhač and Uhač, 2012, 2014; Boetto *et al.*, 2014, 2017; Koncani Uhač *et al.*, 2017a), a distinct, local sewn-boat tradition in the north-eastern Adriatic has been confirmed (Boetto and Rousse, 2011, 2012; Boetto, 2016). Moreover, evident differences in the sewing patterns and types of vessels allowing the delineation of two distinct sewn-boat traditions in the Adriatic Sea to be tentatively proposed (Boetto in Boetto and Rousse, 2011, 2012). The first, defined as 'Romano-Illyrian', included the wrecks discovered in Istria and Dalmatia, focused not on the ethnic notion of Illyrians, but rather the geographical dimensions of Illyria as defined by Strabo (*Geography*, VII, 5); that is a territory from the Danube to the border of the

province of Macedonia, including the whole eastern coast of the Adriatic from the north-eastern part of Istria and Dalmatia to southern Albania. The second tradition, defined as 'Romano-Paduan', included the wrecks discovered from the edges of the Po river delta to the Gulf of Aquileia. Two continental traditions of flat-bottomed vessels in south-eastern Europe have also been distinguished: one characterized by sewing with an Adriatic influence and the second one characterized by the use of metal clamps typical of the inland environment (Boetto and Rousse, 2011, 2012; Boetto, 2016).

At the current state of research, a corpus of 64 sewn boats are now known, dating from the Bronze Age onwards. These boats provide evidence of the use of sewing and lashing techniques in different geographical, historical, and cultural contexts (Fig. 1), and reveal the existence of a variety of Mediterranean sewn-plank boat traditions and the widespread use of this technique, which has long been underestimated.

Before reviewing these different traditions, we have three preliminary comments. Firstly, the terminology used for the various sewn and lashed assembly systems and their typology has already been discussed (Coates, 1985; Marlier, 2007; Dell'Amico, 2009). For our part, we will adopt the following terminology: in accordance with the vocabulary generally adopted by ethnologists, archaeologists, and historians (Hornell, 1946; Greenhill, 1976; McGrail and Kentley, 1985: 11; Casson, 1963, 1971), we use 'sewn boat' as a generic expression for any boat that uses—totally, partially, or simultaneously—different assembly techniques using ligatures (sewing, lacing, lashing, stitching...). The expression is the direct translation of the Latin *sutilis navis* employed by the authors mentioned above. In addition to its generic meaning, the term 'sewing' is used to refer to a continuous longitudinal assembly using ligatures with stitches sewn through the wood (as for lacing) but that require the use of a needle. The term 'lashing' refers to single, independent stitches. In the Mediterranean, the term is generally used for lashed frames. These are usually attached using a number of stitches going around the frame (external lashing) and through one or two pairs of holes made in the planking only. In some vessels a second technique is seen where the ligatures are threaded through channels drilled through both the frames and planks, termed 'internal lashing' (see Fig. 37b).

Secondly, following the notion of architectural types and the concepts of principles and methods of construction (Pomey, 2004; Pomey and Rieth, 2005: 29–33; Pomey *et al.* 2012, 2013) all the wrecks considered belong to two architectural types defined by considering both their hull shape and structure. The first concerns keeled vessels with flush-laid carvel planking. Their construction principle is based on a shell concept for the hull structure, and on a longitudinal strake-oriented concept for their shape, while the building process is shell first. Indeed, this

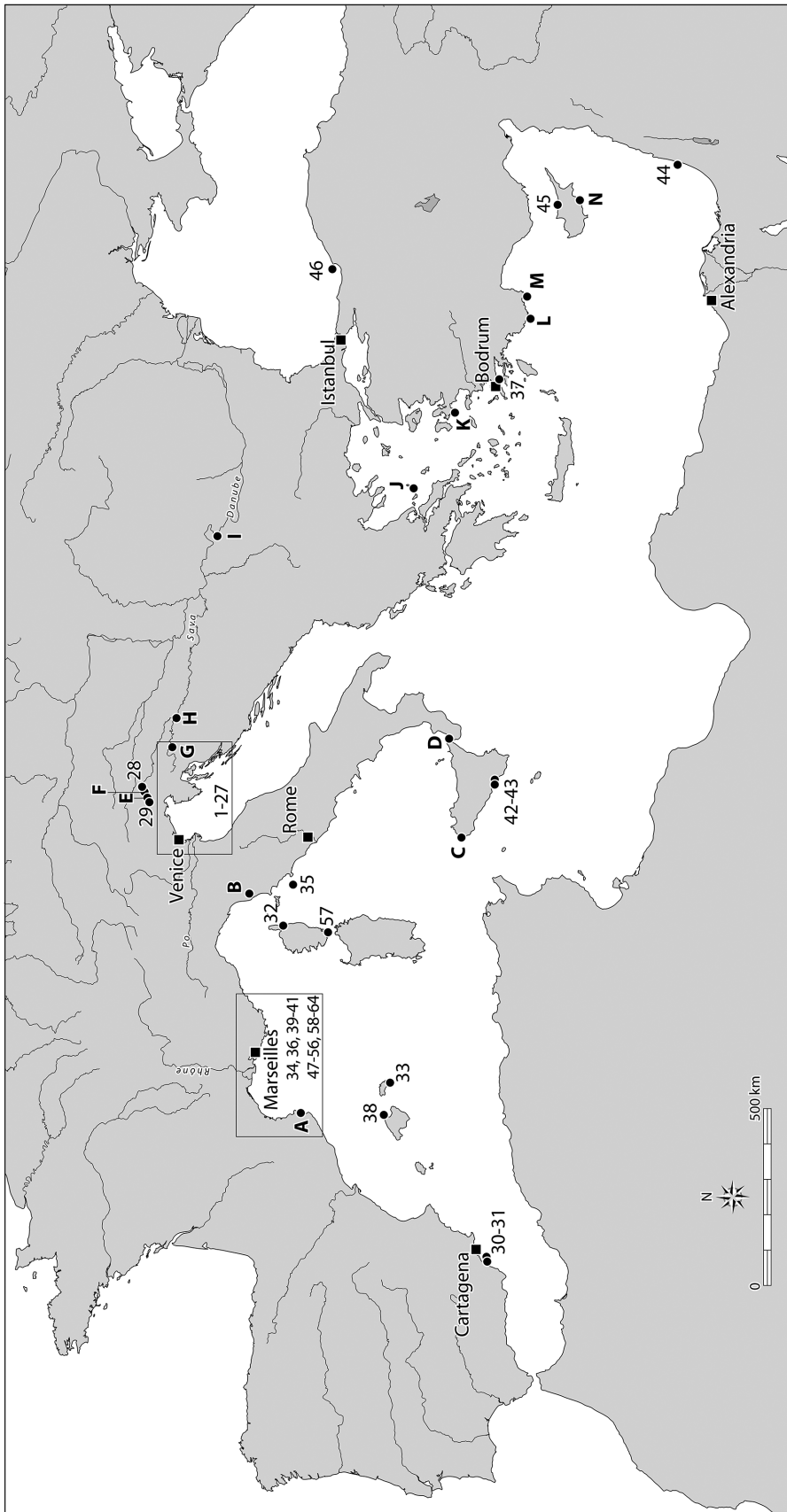

**Figure 1.** The ancient Mediterranean shipwrecks cited in the article. Sewn boats: 1) Zambratija; 2) Pula 1; 3) Pula 2; 4) Zaton 1; 5) Zaton 2; 6) Zaton 3; 7) Caska 1; 8) Caska 3; 9) Caska 4; 10) Barena del Vigno; 11) Cavanella d'Adige; 12) Comacchio; 13) Stella 1; 14) Lido di Venezia 1; 15) Lido di Venezia 2; 16) Lido di Venezia 3; 17) S. Francesco del Deserto; 18) Marcon; 19) Meolo 1; 20) Corte Cavanella 1; 21) Corte Cavanella 2; 22) Padua; 23) Aquileia 1; 24) Aquileia 2; 25) Santa Maria in Padovetere; 26) Cervia; 27) Pomposa; 28) Lipe; 29) Vrhnika 2; 30) Mazarrón 1; 31) Mazarrón 2; 32) Golo; 33) Binisafüller; 34) Bon-Porté; 35) Giglio; 36) Jules Verne 9; 37) Pabuç Burnu; 38) Cala Sant Vicenç; 39) Jules-Verne 7; 40) Villeneuve-Bargemon 1/César 1; 41) Grand-Ribaud F; 42) Gela 1; 43) Gela 2; 44) Ma'agan Mikhael; 45) Kyrenia; 46) Ereğli E; 47) Cap Béar 3; 48) La Tour-Fondue; 49) Cavalière; 50) La Roche-Fouras; 51) Médès 6; 52) Dramont C; 53) Palamos; 54) Plane 1; 55) Barthélémy B; 56) Jeau-me-Garde B; 57) Perduto 1; 58) Cap del Vol; 59) Saintes-Maries 2; 60) Saintes-Maries 24; 61) Baie de l'Amitié; 62) Cala Cativa 1; 63) Port-Vendres 3; 64) Port La Nautique. Other shipwrecks: A) Los Ullastres; B) Pisa C; C) Marsala; D) Porticello; E) Vrhnika 1; F) Sinja Gorica; G) Kamensko; H) Sisak; I) Kuşjak; J) Alonessos; K) Tetktaş Burnu; L) Uluburun; M) Cape Gelidonya; N) Mazotos (drawing V. Dumas, G. Boetto, P. Pomey, AMU, CNRS, CCJ).



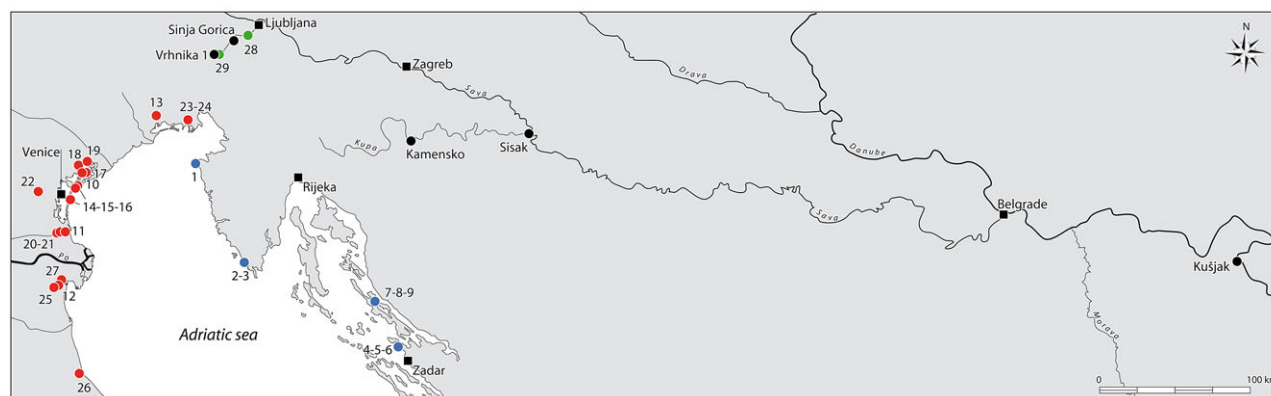

**Figure 2.** Ancient sewn boats from the Northern Adriatic zone (blue and red) and from the Danube river basin (green). In blue, the north-eastern Adriatic tradition or Istro-Liburnian tradition: 1) Zambratija; 2) Pula 1; 3) Pula 2; 4) Zaton 1; 5) Zaton 2; 6) Zaton 3; 7) Caska 1; 8) Caska 3; 9) Caska 4. In red, the northern and north-western Adriatic tradition: 10) Barena del Vigno; 11) Cavanella d'Adige; 12) Comacchio; 13) Stella 1; 14) Lido di Venezia 1; 15) Lido di Venezia 2; 16) Lido di Venezia 3; 17) S. Francesco del Deserto; 18) Marcon; 19) Meolo 1; 20) Corte Cavanella 1; 21) Corte Cavanella 2; 22) Padua; 23) Aquileia 1; 24) Aquileia 2; 25) Santa Maria in Padovetere; 26) Cervia; 27) Pomposa. In green, the continental tradition of the Danube River basin: 28) Lipce; 29) Vrhnika 2 (drawing V. Dumas, G. Boetto, P. Pomey, AMU, CNRS, CCJ).

process is the only one compatible with longitudinally sewn planking, which is one of the main characteristics of the Mediterranean sewn-plank boats. The second architectural type concerns boats built according to a flat-bottom principle with a construction process in which the shape and the structure are dictated by and organized around the flat bottom, which is laid first, with or without carved bilge planks (or carved transition strakes). These boats have flush-laid carvel planking with just one exception; in the Santa Maria in Padovetere wreck the topmost side strakes are clinker built (see below).

Thirdly, within the range of types of sewn Mediterranean boats and ships used in different geographical transport zones for varied functions, we can differentiate shipbuilding traditions based on the characteristics of the systems used to assemble the component parts. The traditions defined here correspond to groups of vessels that share the same technical characteristics of the sewn or lashed assembly systems. Each tradition corresponds to a particular cultural context, which is most often linked to a geographical area that could correspond to a specific geographical transport zone. Within a single tradition, the ligature system can be applied to different types of boats with different functions. It is also possible to observe in the course of time developments in the use of the assembly systems, attested by the adoption of other fasteners, for example the progressive disappearance of longitudinal sewn planking in favour of the adoption of mortise-and-tenon joints. However, in our opinion, in this case, membership of a defined sewn-boat tradition can still be recognized. Such developments may or may not be accompanied by modifications in the architectural type of the boat.

## The north-eastern Adriatic tradition

In recent years, new archaeological research in Istria and Dalmatia, some conducted as part of a bilateral collaboration between Croatian and French institutions,<sup>1</sup> has highlighted the wealth of the north-eastern Adriatic coasts, which have delivered nine sewn-plank boats (Figs 1 and 2).

### *Zambratija (Fig. 2.1)*

The earliest evidence is provided by the Zambratija wreck, which was reported to the Archaeological Museum of Istria in 2008, assessed in 2008–2010, and excavated in 2011 and 2013 (Koncani Uhač, 2009; Koncani Uhač and Uhač, 2012, 2014; Boetto *et al.*, 2014, 2017; Boetto, 2016: 1402–1405; Koncani Uhač *et al.*, 2017a). The wreck lies in shallow water in Zambratija Cove (Umag, Istria), not far from a submerged settlement mostly frequented in the early Chalcolithic period. The wreck, found empty and without cargo, is dated between the last quarter of the 12th and the last quarter of the 10th centuries BC by AMS radiocarbon analysis (Koncani Uhač and Uhač, 2012: 534; Boetto *et al.*, 2017: 189–190). This period of the Late Bronze Age corresponds to the initial phase of the Istrian culture group (phases Ia and Ib) as defined by K. Mihovilić (2013: 117–157).

The preserved part of the boat is 6.7 m long and 1.6 m wide, with a reconstructed length of 9.11m (Koncani Uhač *et al.*, 2017a: 56). It has a keel-like timber carved from an elm log so that its thickness goes from 30mm amidships to 200mm toward the one preserved end (Fig. 3a). The planking strakes, also elm, are sewn. The sewing is irregular and is made up of simple overedge vegetal stitches (/// pattern) through oblique channels (in section) set diagonally (in plan view),

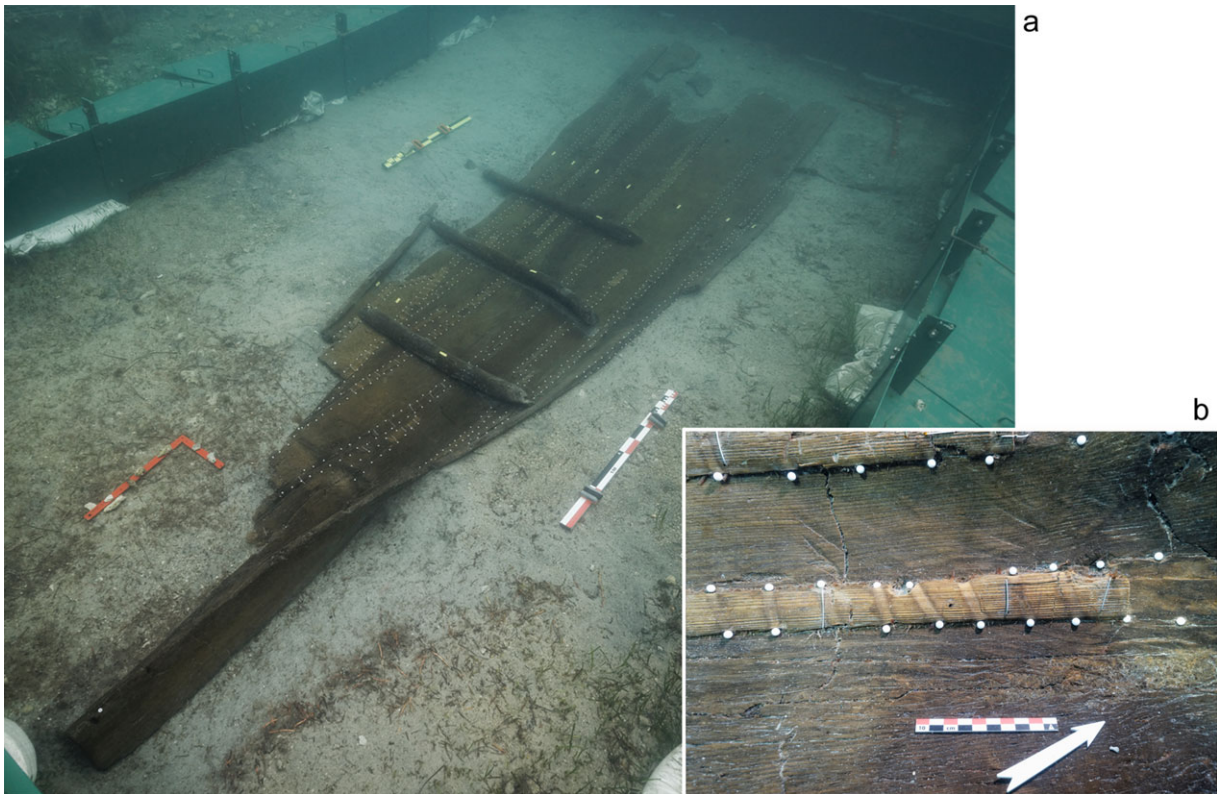

Figure 3. Zambratija shipwreck: a) general view of the hull during the 2013 excavation (photo Ph. Groscaux, AMU, CNRS, CCJ); b) detail view of the sewing pattern (photo Ph. Groscaux, AMU, CNRS, CCJ).

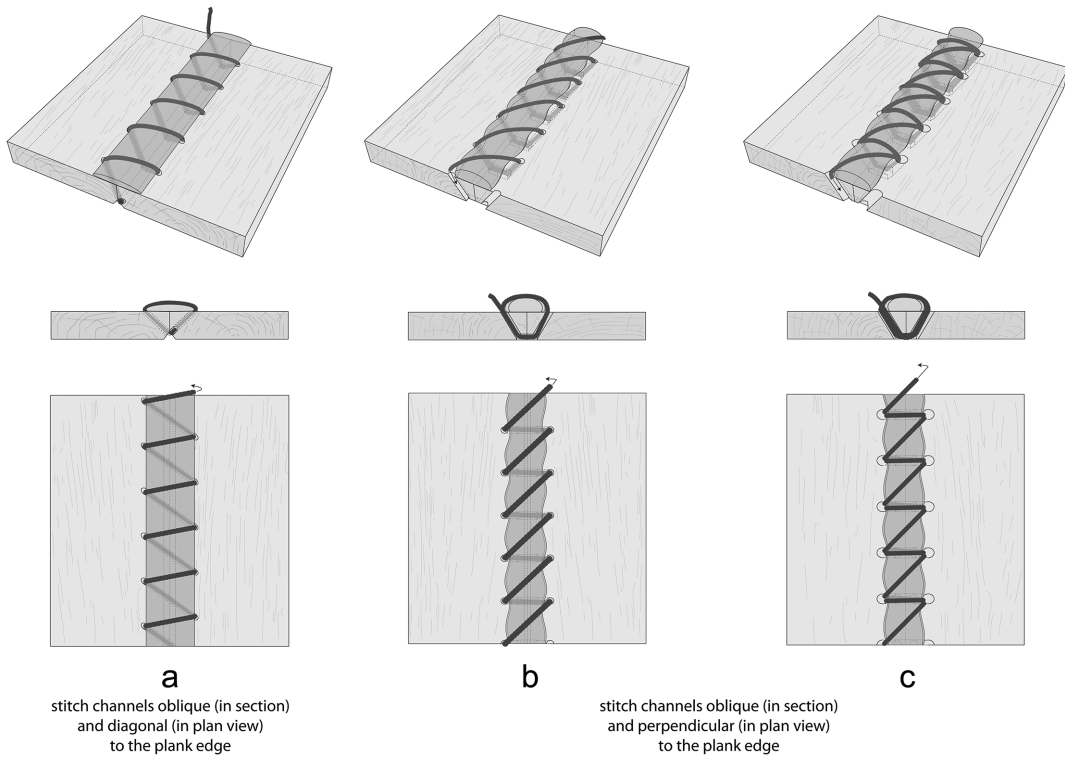

Figure 4. Axonometric illustrations of the sewing systems of: a) the Zambratija shipwreck; b) Pula 2; and c) Pula 1 (drawing P. Poveda, AMU, CNRS, CCJ).





Figure 5. Pula shipwrecks: a) general view of the hulls during the 2013 excavation (photo T. Braiković, Archaeological Museum of Istria, Pula); b) Pula 2, detail view of the sewing system (photo T. Braiković, Archaeological Museum of Istria, Pula); c) Pula 1, detail view of the sewing system (photo T. Braiković, Archaeological Museum of Istria, Pula).

rather than perpendicular, to the plank edges (Figs 3b and 4a). These channels reach the plank edges, which are chamfered so the ligature does not protrude. Small pegs lock the stitches. Fir laths holding wadding made of a layer of vegetal fibres, were placed over the seams prior to sewing. Finally, an internal coat of pitch ensured water tightness and was probably used on the external surface too but the excavators have not yet been able to observe the outboard. The frames are lashed to the planking. They have a round back and a narrow foot for stronger clamping. The foot is not crenellated over the seams but has rectangular limber holes.

#### **Pula 1 and 2 (Fig. 2.2–3)**

Two Roman wrecks were found in an urban rescue excavation within the ancient harbour basin of Pula (Istria) in 2013 (Fig. 5a). Excavated by the Archaeological Museum of Istria in collaboration with the Centre Camille Jullian, the two wrecks were retrieved. Pula 2 has been conserved (Koncani Uhač *et al.*, 2017b), while Pula 1 is awaiting treatment. They are dated according to the stratigraphy and a series of 14C AMS dates between the 1st century and the first half of the 3rd century AD (Boetto, 2016: 1410–1412; Boetto *et al.*, 2014, 2017).

Pula 1 is a sailing ship, as indicated by recesses carved on certain frames to house a mast-step timber (not present), about 15m long. Pula 2 is a coastal craft of about 10m, probably propelled by oars and sail. In both vessels the keel is made of holly oak and the frames are oak. The planking, made of elm in Pula 1 and of beech in Pula 2, is sewn but in two different ways. Pula 2 has simple overedge stitches (/// pattern)

going through oblique channels set perpendicular to the plank edges (Figs 4b and 5b). On Pula 1, the sewing is more elaborate and made of overedge stitches with a clamping turn (IIII/I pattern) (Figs 4c and 5c). In both cases, the stitches are formed with a flat braid of three strands of twisted vegetal fibres. The stitches pass over a wadding pad made of the same type of vegetal fibres placed over the seam. Little pegs lock the stitches in the channels. The channels end at the corner of the face of the plank in a rectangular or trapezoidal notch. Sometimes, the hole is slightly removed from the plank edge, in which case a little groove is carved to lodge the stitch on the outer face of the plank, in which case the channels are more vertical than oblique. An internal and external coat of pitch seals the hull.

Sewing is used only for the planking seams; the frames of Pula 1 and 2 are treenailed to the planking, and the use of a few copper nails is attested on Pula 2. The frames have a rectangular section and their base is crenellated to avoid damage to the sewn-plank seams.

#### **Zaton (Fig. 2.4–6) and Caska (Fig. 2.7–9)**

Also in the Adriatic, in Dalmatia, the region north of Zadar, several sewn-plank boats dated to the Roman period have been found with similar characteristics to the Pula ships. In 1966 and 1982, two sewn-plank boats were found in Zaton, some 15km north of Zadar, where the ancient harbour of *Aenona* (today Nin) was situated (Brusić, 1968, 1987; Brusić and Domjan, 1985). The preserved parts of the boats, dated to the 1st century AD, are respectively 6.50m and 8m in length. In 2002–2003, part of a third sewn wreck was discovered and partially uncovered, measuring 5m in length with

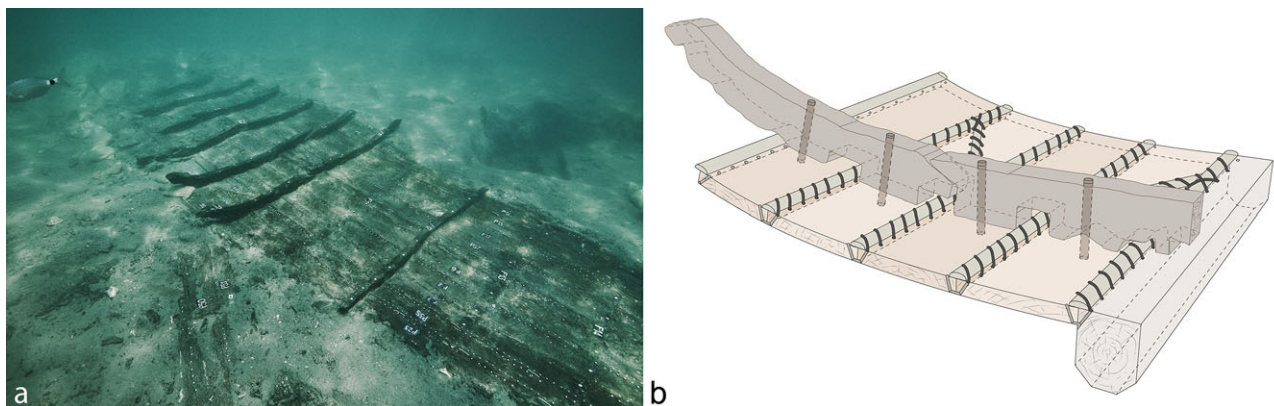

Figure 6. Caska 1: *a*) general view of the hull during the 2010 excavation (photo L. Damelet, AMU, CNRS, CCJ; Cissantiqua Project, University of Zadar); *b*) axonometric illustration of the sewing system (drawing P. Poveda, AMU, CNRS, CCJ; Cissantiqua Project, University of Zadar).

a mast-step timber found in place, but it has not been fully excavated or published in detail (Glušević, 2004).

In 2007, a sewn-plank boat was found in Caska Cove (Novalja, Island of Pag) by a team from the University of Zadar (Čelhar, 2008; Radić Rossi, 2008). Caska 1, excavated 2009–2010, of which an 8m-long and 1.7m-wide section was preserved, was found filled with stones, reused as a foundation for a pier-like structure (Fig. 6a). The craft is dated by AMS radiocarbon synchronized to the 14C calibration curve using wiggle-matching to between AD 42 and 107 (Radić Rossi, 2010, 2011; Radić Rossi and Boetto, 2010, 2011; Boetto and Radić Rossi, 2014, 2017; Boetto, 2016: 1406–1408). A fragment of the planking of another sewn boat, Caska 3, was recognized in 2014 within a huge quantity of discarded timbers found in the infill of Caska 2 (a sailing vessel characterized by a tenon-and-mortise assembly of the planking) (Boetto and Radić Rossi, 2014, 2017; Boetto, 2016: 1410). Finally, the remains of a third sewn boat, Caska 4, reused as a foundation for another harbour structure were excavated in 2016 and 2017 (Boetto, 2016: 1410; Boetto and Radić Rossi 2017; Ruff, 2017). The keels of Caska 1 and 4 are made of holly oak, while the planking of the three sewn boats from Caska is made of beech. The frames of Caska 1 and 3 are made of oak and are attached with treenails to the planking (Fig. 6b). In contrast, the framing of Caska 4, is made of oak and holly oak and is lashed to the planking. The waterproofing wadding pads and the cord used for the sewing and lashing are similar to those observed in both the Pula wrecks (flat braids made of three twisted strands). The fibre used for the stitching is currently being analysed both for the Pula and the Caska sewn wrecks.

### Discussion

According to the remains of these nine vessels, a series of characteristics common to the vessels found in the north-eastern Adriatic can be defined:

- no (or slight) evidence of pre-assembly dowels (coaks); the observation of the planks edges is rarely possible and could be done extensively only if the shipwrecks were dismantled. In Pula 2 and Caska 4 only three very small, square-section pegs were observed in the thickness of the planks and their function as pre-assembly elements is not clearly established at this stage of the research;
- oblique channels cut diagonally to the plank edges ending in a chamfer, replaced in the Roman period by oblique channels cut perpendicularly to the plank edges that end in a notch, and a groove is carved to lodge the stitch in the outer face of the planking (Fig. 4);
- simple overedge sewing (///), or overedge sewing with a clamping turn (IIII) of vegetal braids (Caska, Zaton, and Pula) (Fig. 4);
- a wooden lath used to hold vegetal fibres to render the seams watertight (Figs 3b and 4a), replaced during the Roman period by a vegetal roll (wadding pad) (Figs 4b, 4c, 5b, 5d, and 6b);
- pegs are used to lock the ligatures in the channels;
- frames lashed, and then predominantly treenailed frames in the Roman period, with sections that change from trapezoidal to rectangular over time; lashing is only attested in Zambratija and Caska 4;
- a coat of pitch covers the hull.

All of these boats are keeled. They are structurally and technically very similar but they also have significant differences in terms of dimensions, shape, propulsion systems, and the selection of wood species used. These differences could be ascribed to diverse ship types within the same tradition of construction. The vessels in this tradition are characterized by a very simple overedge plank seams (/// pattern) with stitches passing through oblique channels, diagonal (Zambratija) or perpendicular (Caska, Zaton, and Pula) to the plank edges (Fig. 4). Pegs lock the ligatures, and, for Caska, Zaton and Pula, a wadding pad served



to seal the seams before the sewing. Pula 1, which is a bigger sailing vessel than the others in this group presents a stronger sewing pattern of overedge stitches with a clamping turn (II/II pattern) (Fig. 5a) than that seen on other vessels in this group; however, the type of cord (a flat braid) and the wadding pad are similar to those observed in the contemporaneous Pula 2 (Fig. 5b) and the Caska wrecks. Finally, in all but the Zambratija wreck, the frames are rectangular in section and their bases are crenellated to avoid damaging the sewn seams. Only Zambratija and Caska 4 have frames lashed to the planking, all the others are treenailed (with Pula 2 also having a few copper nails). A coat of pitch covers the inside and, probably, the outside of the hulls.

If the Zambratija wreck testifies to the antiquity of the north-eastern Adriatic or Istro-Liburnian sewn-boat tradition, as defined here, dating back at least to the Late Bronze Age, the Pula, Zaton, and Caska wrecks attest the survival and vibrancy of this tradition into Roman times. Even if we have no evidence for the long period between the Bronze Age and the Roman Empire, it seems likely that this sewn-boat tradition was continuous. Some Latin texts, such as Varro (quoted by Aulus Gellius, XVII, 3, 4) and Verrius Flaccus (in Festus, 508, 33), explicitly refer to the *serilia naves* ('rush-rope boats') of the Istrians and Liburnians.

### Northern and north-western Adriatic tradition

On the northern and north-eastern part of the Adriatic another group of sewn boats has been identified in an area from the Gulf of Aquilea to Ravenna through the Po river delta, in the coastal, lagoon, and inland waters of the present Friuli-Venezia-Giulia, Veneto, and Emilia-Romagna regions of Italy (Fig. 2). The remains up to 18 boats have been found, dating from the Republican period to the end of the Roman Empire, with some possibly earlier, and continuing to the Early Medieval and Medieval period. Several of these remains are fragments and chance discoveries, and the published data for many of them is incomplete or lacking (Beltrame, 2000, 2001, 2002a, 2002b; Boetto and Rousse, 2011, 2012; Beltrame and Gaddi, 2013).

#### *Barena del Vigno (Fig. 2.10)*

In the northern lagoon of Venice, in the locality Barena del Vigno, a plank fragment of a probable sewn boat was found in 1968 (Beltrame, 2000: 92) or 1971 (Beltrame, 2002a: 365, fig. 16). It has been radiocarbon dated to around the 6th century BC ( $530 \pm 30$ ). The sewing goes through oblique channels in which some little pegs have been preserved.

#### *Cavanella d'Adige (Fig. 2.11)*

In Motta di Cavanella d'Adige (Rovigo), not far from the Adige River mouth, a portion of a sewn boat, probably reused as an embankment, was discovered and excavated in 2008 (Tiboni, 2009, 2017). This hull

fragment has been dated stratigraphically to the 2nd–1st century BC. The planks have been attributed to the side of a bottom-based vessel without carved bilge strake. The presence of a carved bilge strake as asserted by Tiboni (2014, 2017) now seems unlikely. The sewing passes through oblique holes perpendicular to the plank edges and is locked by pegs. The sewing pattern used was a cross stitch with clamping turns (IXIXIX) (Tiboni, 2017: 292). It enlaced a wadding pad to render the hull watertight. The stitches are lodged in grooves carved in the external side of the plank (Tiboni, 2017: 293, fig. 4). Small rectangular frames were fastened to the planks with internal lashings locked with wooden pegs.

#### *Comacchio (Fig. 2.12)*

Discovered in 1980 in an inland channel of the Po river delta, the Comacchio wreck corresponds to a flat-bottomed, fluvio-maritime barge, 23m long and 5.5m wide, with a plank-keel, a massive stempost, and a round turn of the bilge (Fig. 7a). According to its cargo, the wreck dates to the beginning of the Augustan period at the end of the 1st century BC (Berti, 1986, 1990). The boat is an example of mixed construction with sewn planks up to the first wale and mortise-and-tenon joints used for the upper strakes (Bonino, 1985, 1990).

The sewing uses oblique channels perpendicular to the plank edges that end in trapezoidal recesses on the inside of the lower plank edge. The sewing pattern is a cross stitch with clamping turns (IXIXIX) (Fig. 7b). Little pegs lock the vegetal stitches in the channels. A wadding pad, made of vegetal fibres covered with a woollen fabric, was placed over the seams prior to stitching, and a coat of pitch covers the whole inside of the hull to ensure it was watertight. The frames (floor-timbers and top-timbers) are rectangular in section, crenellated to avoid damage to the seams, and are both treenailed and firmly lashed to the planking (Fig. 7c).

#### *Stella 1 (Fig. 2.13)*

The wreck was found in 1981 in the Stella River (Palazzo dello Stella, Udine) and excavated 1998–1999 and 2011. It was loaded with a main cargo of roof tiles. The remains are partially preserved over  $5 \times 2$  m and are dated to the beginning of the 1st century AD (Vitri *et al.*, 2003; Castro and Capulli, 2016, 2017). The boat is a flat-bottomed river barge without keel or carved bilge strakes (Fig. 8).

The planking is sewn with vegetal ligatures going through oblique channels perpendicular to the plank edges in a cross-stitch pattern with clamping turns (IXIXIX type). Some of the channels do not exit at the exterior edge of the plank, but are slightly removed from the edge, in which case a little groove is carved to lodge the stitches on the outboard face of the plank (Castro and Capulli, 2017: 35, fig. 6f). A wadding pad is placed over the seam before sewing, and pegs are used to lock the ligatures. A couple of holes for dowels along the



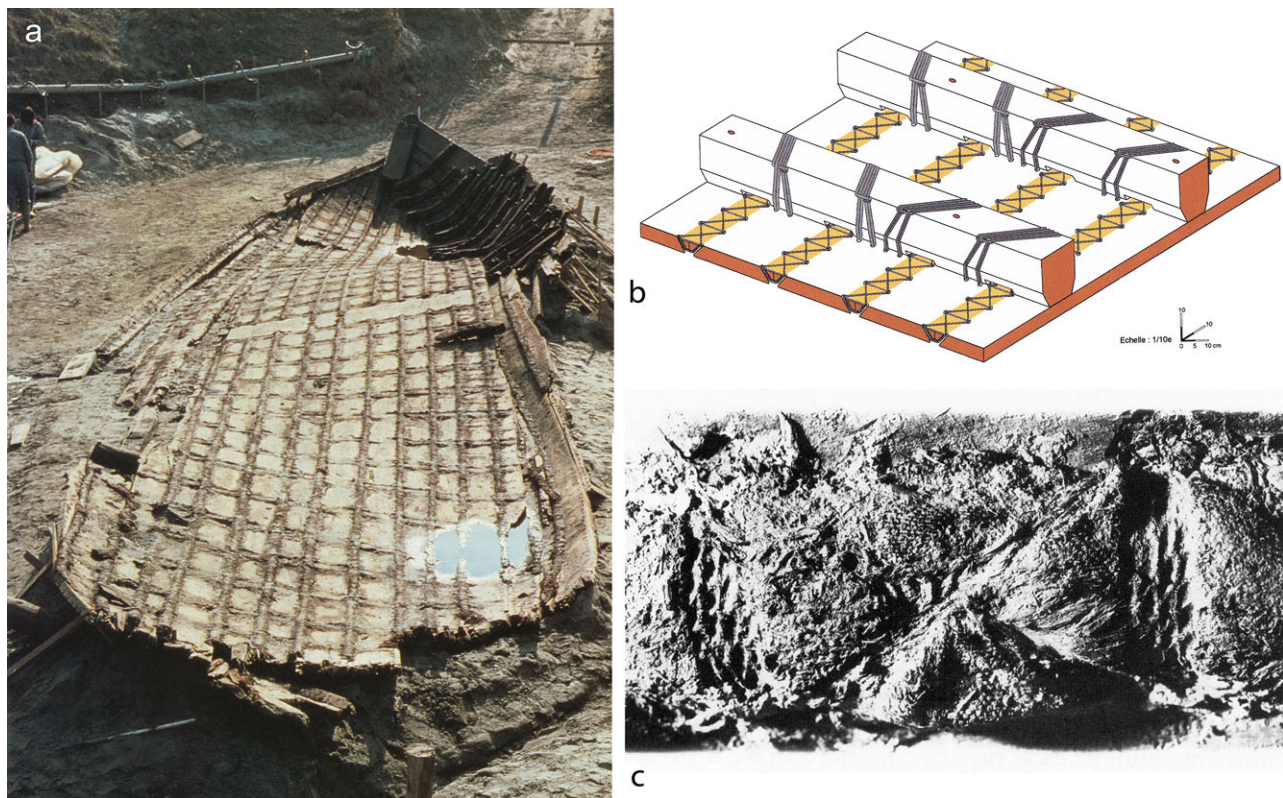

Figure 7. Comacchio shipwreck: *a)* general view of the hull after dismantling the frames for recovery, with the stem visible at the far end (from Berti, 1990: 25); *b)* axonometric illustration of the sewing systems (drawing S. Marlier; Marlier, 2005: fig. 135a); *c)* detail view of the sewing system (from Berti, 1990: 30, fig. 4).

plank edges have been observed around the turn of the bilge, possibly used to reinforce the connection between the bottom and first side plank or, more probably, with a pre-assembly function. The frames have a rectangular section and crenellated base and are treenailed to the planking. A coat of a resinous substance covers the inside of the hull.

#### **Lido di Venezia 1, 2, and 3 (Fig. 2.14–16)**

A group of plank remains and a frame probably belonging to a single sewn boat (Lido di Venezia 1) of the 1st–2nd century AD were found in 1993, 1997, and again in 2003, washed ashore near Alberoni in the Lido of Venice at the entrance of the Malamocco harbour (Beltrame, 1996; 2000; 2001; 2002a; 2002b; Beltrame and Gaddi, 2013: 302). The sewing characteristics are similar to the Comacchio remains, with trapezoidal recesses at the end of obliquely cut channels (Fig. 9). A possible pre-assembly dowel was also observed (Beltrame, 2002a: fig. 30).

In 1997, 2000, and 2012 small fragments of a second plank assemblage, Lido di Venezia 2, were recovered from the beach of S. Nicoletto, in front of the Ospedale al Mare of the Lido of Venice (Beltrame, 2002a: 368; Beltrame and Gaddi, 2013: 302) some kilometres to the north of Alberoni. The planks have oblique channels perpendicular to the edges of the planks but without

recesses at the lower edge. No pegs to lock the stitches were preserved. A Roman-era date is possible due to the similarities to others finds from the same area (Beltrame and Gaddi, 2013).

In autumn 2012, another group of fragments of a sewn vessel was found 300m south-west of the Lido di Venezia 2 finds. These fragments of planking, have quite similar characteristics to the other Roman sewn shipwrecks from the Lido of Venice (Willis and Capulli, 2014, 2017, 2018a). At the present stage of the research, it is not clear if this third assemblage belongs to Lido di Venezia 2 wreck or to one or more different wrecks; we prefer to separate these three assemblages assigning them to three different wrecks.

#### **S. Francesco del Deserto (Fig. 2.17)**

In the northern lagoon of Venice, near the island of S. Francesco del Deserto, two planks belonging to a dismantled sewn boat were identified in a wooden submerged embankment in 2004 (Capulli and Pellegrini, 2010). The embankment was dated to the Early Middle Ages but these planks have been attributed to the Roman period and are evidence of the reuse of very old timbers. The planks show typical oblique channels for sewing, with some pegs still present. The frames (not conserved) were attached to the planks with treenails. Recently, Capulli advanced

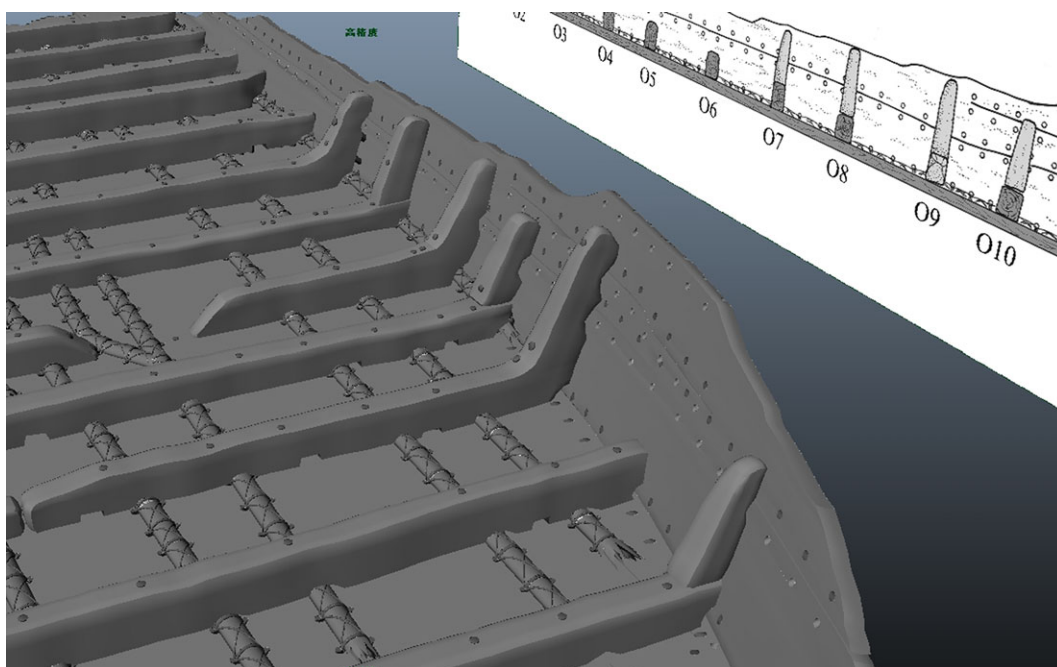

Figure 8. Stella 1: axonometric illustration of the hull remains (drawing K. Yamafune; from Castro and Capulli, 2016: 35, fig. 7).

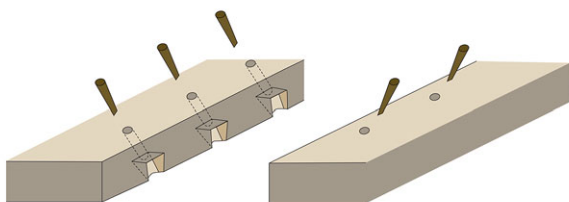

Figure 9. Lido di Venezia 1: axonometric schema of the features in the planking edges (drawing G. Boetto, AMU, CNRS, CCJ; after Beltrame 2002: 372, fig. 29A).

the hypothesis that these planks belonged to a sewn boat of the north-eastern Adriatic tradition on the basis of the short space between pegs fixing the stitching (Willis and Capulli, 2018a: 353).

#### **Marcon (Fig. 2.18)**

A flat-bottomed boat of Roman date with sewn planks and treenailed frames was discovered in 1999 in Marcon (Venice), Tenuta Zuccarello, north-west of the Roman *Altinum* and the via Annia (Cipriano, 2011: 85–86, fig. 7; Beltrame and Gaddi, 2013: 302).

#### **Meolo 1 (Fig. 2.19)**

In a paleo-river situated at La Fossetta di Meolo (Venice), a single frame of a probable sewn vessel was found in 2000 (Beltrame, 2002a: 370–371). The frame is crenellated to sit over wadding pads and had been attached to the planking using treenails.

#### **Corte Cavanella 1 and 2 (Fig. 2.20–21)**

The remains of sewn boats, dated from the end of the 1st or the beginning of the 2nd century AD, were found in 1983 and 1985 within a Roman settlement at Corte Cavanella di Loreo (Rovigo). While Corte Cavanella 1 was left *in situ* and poorly documented, Corte Cavanella 2 was recovered and studied many years later (Beltrame, 2000, 2002a: 360–362, figs 12–15; Willis and Capulli, 2018b) (Fig. 10). Both are flat-bottomed crafts without keels or carved bilge strakes, and are respectively preserved for 7.4m and 4.13m in length. On Corte Cavanella 2, the three preserved planks forming the bottom have diagonal channels, with little pegs to lock the stitches.

#### **Padua (Fig. 2.22)**

Beltrame (2002a: 366, fig. 17) reconsidered the remains of four sewn strakes found in 1991 in Padova that had not been studied. This fragment of the planking of a sewn vessel was reused in the 2nd century AD for the construction of an embankment.

#### **Aquileia 1 and 2 (Fig. 2.23–24)**

Fragments of two sewn boats dated to the Roman period were found in the Canale Anfora, an artificial channel connecting the Roman city of Aquileia with the lagoon (today the Grado Lagoon). Aquileia 1, dated to the 1st century AD, was discovered and retrieved in 1988. The remains, which preserved only a small portion of the vessel, were re-analysed in 2001 (Beltrame, 2002a: 358–359; Beltrame and Gaddi, 2013). Aquileia 2, dated between the end of the 2nd and the



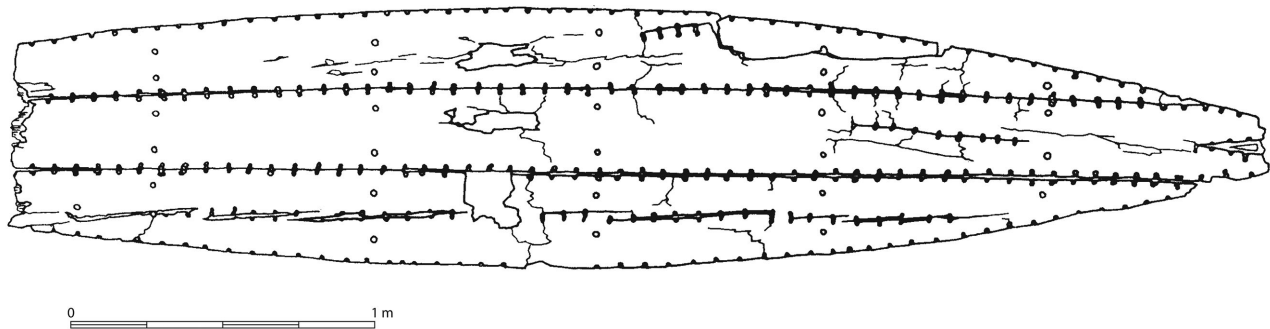

Figure 10. Corte Cavanella 2: plan of the outer face of the planking (drawing G. Boetto, AMU, CNRS, CCJ; after Beltrame 2002: fig. 13).



Figure 11. Aquileia 1: detail view of the sewing system (from Beltrame and Gaddi, 2013: fig. 5).

beginning of the 3rd century AD, came to light in 2004–2005 (Beltrame and Gaddi, 2013). Based on the thickness of the planks, it seems that the first vessel was more than 15m long, while the second one was 8–10m long.

Aquileia 2 (three sewn planks and some fragments of a crenellated frame with treenails) still retains some ligatures on the planking (IXIXIX type). A pre-assembly dowel was also observed (Beltrame and Gaddi, 2013: 299, fig. 14, 301).

For Aquileia 1, Beltrame and Gaddi (2013: 297–298, fig. 5, 7A) recognized on a photograph taken in the 1980s overedge sewing with at least two or three clamping turns over a vegetal wadding pad (Fig. 11). This pattern is defined as ‘Z-type sewing technique’. From the analysis of a fragment of cord found in the channels for the stitching, it is made of eight twisted

strands; the strands are made of two threads each, which have not yet been analysed. From the photograph it is hard to know if this sewing pattern was used for all the planking, or if it was used punctually in a limited area, while the rest of the hull had ligatures of the IXIXIX type.

#### ***Santa Maria in Padovetere (Fig. 2.25)***

Discovered in 2008 and completely excavated in 2014 and 2015 in Santa Maria in Padovetere, a few kilometres west of Comacchio (Ferrara), the wreck is conserved for a length of 20m, and is dated to the 5th century AD (Beltrame and Costa, 2016). The ship is bottom based without carved bilge planks and with a pointed extremity. The sewing pattern is a cross stitch with clamping turns (IXIXIX). The sewing passed over wadding pads and was locked with pegs. The framing system is composed of L-shaped floor-timbers, crenellated to avoid crushing the wadding, and extended by futtocks. In the upper part, the topmost strakes are clinker built. Some unpegged tenons are attested in a limited zone near the conserved extremity.

#### ***Cervia (Fig. 2.26) and Pomposa (Fig. 2.27)***

Several elements of planking and framing belonging to a sewn boat were found in 1956 near Cervia (Ravenna) (Fig. 12). The remains, of which only five fragments of planks and seven fragments of frames were conserved, were originally identified by Bonino (1968, 1985) and re-evaluated by Beltrame (2002a: 559, fig. 10 and 11, 2009: 415). The planks are characterized by oblique channels perpendicular to the edge of the planks ending in trapezoidal recesses. Little pegs locking the stitches were observed in place, but have not now survived. One nail is still visible fastening the end of an oblique scarf joining two planks. The frames were treenailed to the planking. An anchor associated with the remains suggests the wreck is dated to the 7th century AD.

The same year and in the same region, the Pomposa wreck was found and dated to the Medieval period

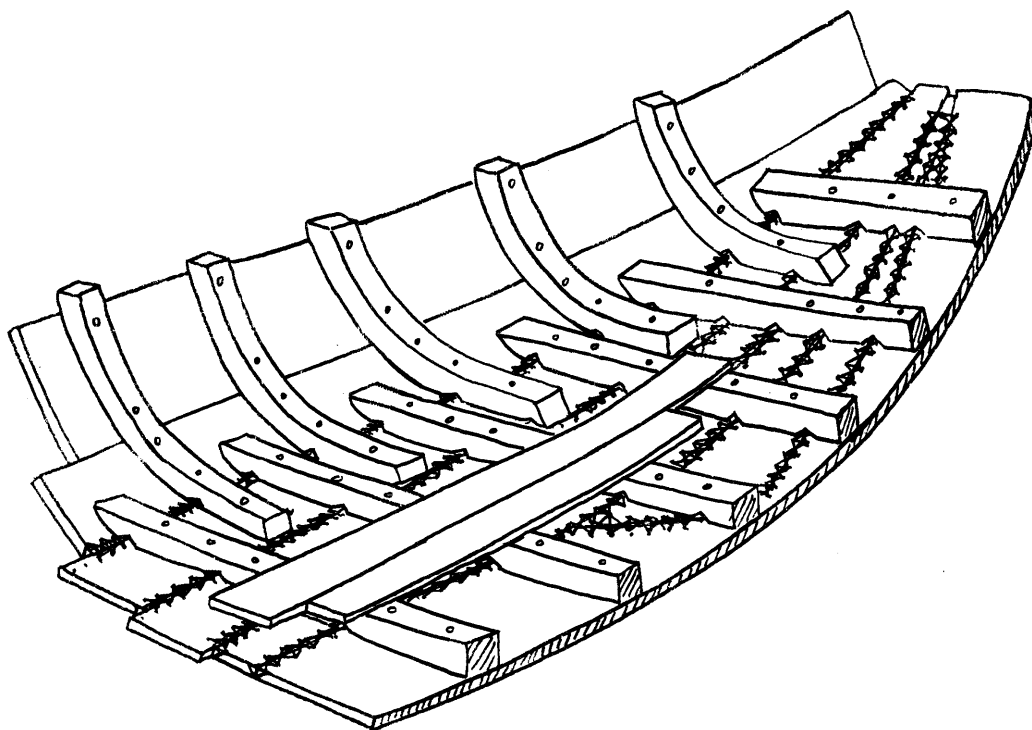

Figure 12. Cervia shipwreck: axonometric reconstruction of the hull (from Bonino, 1985: fig. 7.4).

(11th century) (Bonino, 1968, 1978). The remains correspond to a flat-bottomed boat without keel or carved bilge strakes. These remains have been used by Bonino to interpret the Cervia wreck due to their similar characteristics, and to suggest that both boats belong to the same type. Only a fragment of a wadding pad was recovered from the Pomposa wreck, while the remains were still *in situ* (Beltrame, 2009: 415). This fragment clearly shows the imprint of a cross stitch with clamping turns pattern (IXIXIX) (Beltrame, 2002a: 373, fig. 31). The Early Medieval date for the Pomposa ship has been queried by Beltrame (2009: 415, fig. 11) because no datable finds were associated with the wreck and the 11th-century coastline was far from the site. It is possible that, due to the similar characteristics between the Cervia and Pomposa wrecks, they both date to the 7th century AD.

### Discussion

These 18 wrecks and fragments of sewn boats are from a long period of time, the earliest likely from the 6th century BC, with a majority from the period of the Roman Empire, and continuing until the Middle Ages. The sewing technique is characterized, when it was possible to study it in detail, by:

- no systematic use of pre-assembly dowels;
- a predominance of trapezoidal recesses at the end of the sewing channels to protect the stitches from wear;
- the use of a cross-stitch pattern with clamping turns (IXIXIX type);

- a wadding pad placed over the seams prior to sewing;
- the use of little pegs to lock the stitches;
- the frames are sometimes lashed and treenailed (Comacchio), but more often treenailed (internal lashing is attested only in Cavanella d'Adige);
- a coat of pitch covered the inside of the hull;
- the presence of mixed assembly techniques (with mortise-and-tenon in Comacchio; and clinker and unpegged tenons in Santa Maria in Padovetere) is also attested.

These vessels prove the extent of this 'northern and north-western Adriatic' tradition of local origin. This sewn tradition concerns mainly flat-bottom boats, some with a plank-keel or others without keel and without carved bilge strakes. Nevertheless, these flat-bottom boats were well adapted to the inland waters, or to fluvio-maritime and coastal sailing.

Although the sewing patterns of Aquileia 1 and Pula 1 look similar (I/I/I/I), in our opinion these two vessels did not belong to the same tradition of sewn boats. In Pula 1, the overedge sewing has a single clamping turn and a flat braid composed of three twisted strands (see above). In contrast, in Aquileia 1 the overedge sewing pattern with several clamping turns at each point more closely resembles the cross-stitch pattern characteristic of the northern or north-western Adriatic tradition. The cord used is also different, with Aquileia 1 using cord made of eight twisted strands each made of two yarns, rather than the braid of three strands seen on the other vessels from Pula. Moreover,

we do not know if this type of stitching was used extensively on Aquileia 1 or if it was used only in a limited area of the vessel. Although the information on Aquileia 1 is partial, this vessel is differentiated by its stitch type and the cord used from those found on the north-eastern Adriatic coasts; its affiliation to the northern or north-western Adriatic tradition is probable but not certain.

### Tradition of the Danube River basin

In Slovenia, there is evidence of the use of sewn boats in the inland waters of the Ljubljana River including the Lipe barge and a wreck recently discovered in Vrhnika. If the location is not strictly Mediterranean, these vessels are included due to their proximity to the two previously discussed traditions.

#### *The Lipe wreck (Fig 2.28)*

The Lipe barge (Ljubljana, Slovenia) was found in 1890 near the present-day Ljubljana riverbed (Müllner, 1892), and only a few small fragments remain conserved at the National Museum of Slovenia in Ljubljana (Gaspari, 1998a, 1998b). The boat, originally dated to the beginning of the 1st century BC (Gaspari, 2009), is now dated to between the mid 2nd and the mid 1st centuries BC (Gaspari, 2017: 141), and has been placed within a regional, inland waters, south-eastern European, Romano-Celtic shipbuilding tradition (Boetto and Rousse, 2011, 2012). The vessel was a large flat-bottomed river barge, 30m long and 4.80m wide, without a keel but with carved bilge planks. The planking is sewn with simple vegetal stitches through vertical channels in a zigzag pattern (/I/I) (Fig. 13); but the sewing pattern is not clear (Boetto and Rousse, 2011: 183–184). The channels are oblique but curiously do not end at the lower edge of the planks on Müllner's drawings, and are vertical on the photographs of the remains published by Gaspari (1998b). Little pegs lock the stitches. A vegetal roll was placed over the plank seams prior to sewing. A few dowels were observed by Gaspari (1998b) on two small fragments of the shipwreck. The framing is made of floor-timbers alternated with knees, all have a square section and are crenellated over the seams. All the frames are treenailed, in contrast to the Romano-Celtic tradition where the frames are iron nailed (Arnold, 1999: 34), however the stringers are iron nailed.

#### *Vrhnika 2 wreck (Fig. 2.29)*

In 2015, another sewn boat was discovered in the Ljubljana River in Vrhnika. A 2m length of the upper part of a plank with stitch-channels, probably made from a soft wood, was visible on the riverbank. A detached part of a thick wadding pad made of plant material and the upper part of three frames, placed at 0.6m intervals and fastened with oak treenails to the planking, were also identified. One of the frames has a rectangular notch to fit over the wadding pad.

Radiocarbon analyses of one yew peg (*Taxus baccata*) locking the stitches and one sample from the planking date this sewn boat to the 2nd century BC. This ship find confirms the use of the sewing technique in the Ljubljana River possibly at an earlier date than the Lipe barge (Gaspari, 2017: 87, fig. 85–87). Gaspari has also pointed out that in the 19th century, Müllner reported the presence of an undated logboat found in the Ljubljana marshes near Zeleni Hrib. From the Müllner's report it seems that the logboat had one unidentified piece lashed to the hull (Gaspari, 2017: 117–118).

#### *Discussion*

This inland tradition of sewn vessels echoes the Romano-Celtic tradition of inland-waters barges (McGrail, 1995; Rieth, 1998; Arnold, 1998, 1999; Hocker, 2004; Boetto *et al.* 2011), with which it shares many general structural and shape characteristics. But, due to the sewn-plank assemblage of the flat bottom, it is proposed that this boat can be linked to the Adriatic sewn-boat traditions. The sewn planking shows a strong influence from maritime shipbuilding traditions of the Adriatic Sea (Gaspari, 1998a, 1998b, 2009, 2017). This influence is linked to the particular geography of this part of Slovenia that historically opened toward the gulf of Trieste and Istria through the accessible passes of the Julian Alps (Boetto and Rousse, 2011, 2012; Gaspari, 2017). Moreover, the navigation area of the Lipe barge on the Ljubljana River opens toward the Save River and the Danube hydrographic basin and clearly belongs to the region of south-eastern Europe.

The sewn boats found in Slovenia appear to be at the conjunction of three regions and traditions: the continental Danube, the maritime north-eastern Adriatic, and the northern and north-western Adriatic traditions.

It is important also to underline that the known sewn boats have been found only in the upper part of the Ljubljana River and correspond to a sub group within the Danubian shipbuilding tradition (Boetto and Rousse, 2011: 190, 2012: 436–437; Boetto, 2016: 1416) (Figs 1 and 2). Another sub group has been identified with some vessels that have metal clamps or sintels that keep the vegetal luting in place between strakes (Boetto and Rousse, 2011: 188–190, 2012: 436–437; Boetto, 2016: 1416). This last sub group is attested by the river barges discovered in Serbia at Kušjak (2nd century AD; Figs 1, I and 2) on the Danube (Bockius, 2003), in Slovenia at Sinja Gorica (*terminus post quem* the year 3 AD; Figs 1, F and 2) on the Ljubljana River (Erič *et al.*, 2014; Čufar *et al.*, 2014), in Croatia in the Kupa River at Sisak (2nd–3rd century AD, Gaspari *et al.*, 2006; Figs 1, H and 2) and Kamensko, near Karlovac (1st–2nd century AD, Boetto, 2016: 1413–1416; Figs 1, G and 2). At the present state of research, it is hard to see the clamps as a derivation of sewing technology that permitted



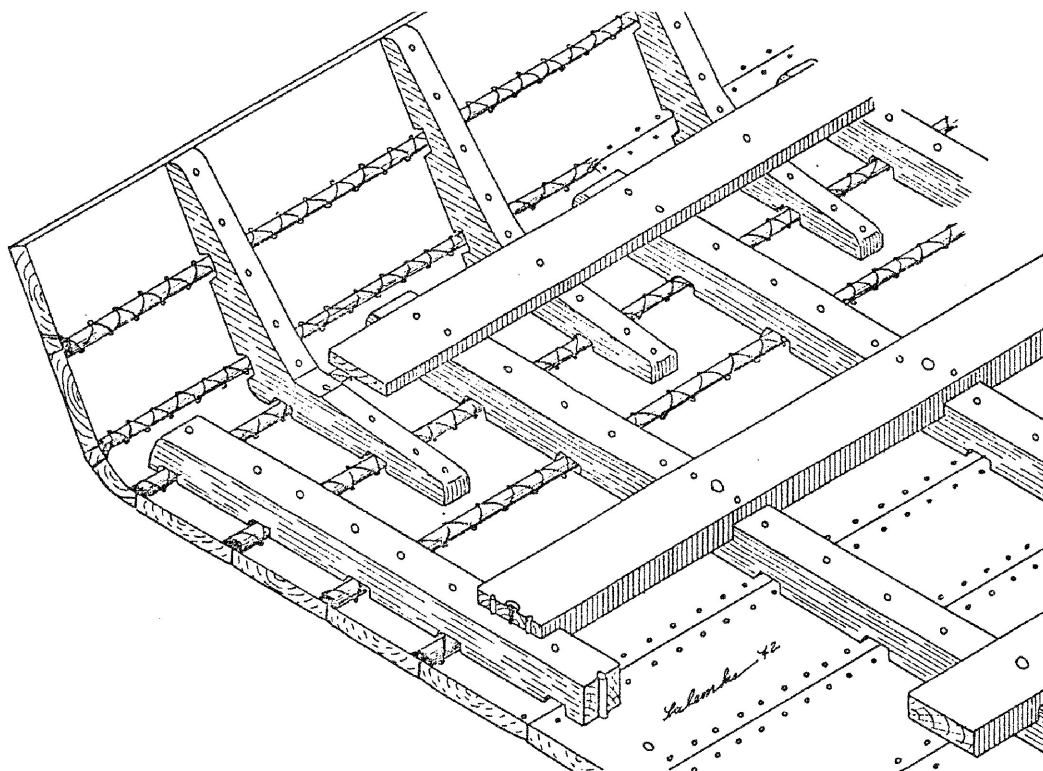

Figure 13. Lipe shipwreck: axonometry of the hull (from Salemke, 1973: 23).

faster construction and easier maintenance, maybe in relationships with the Roman conquest of Illyricum and Pannonia (Gaspari, 2017: 184). The logboat Vrhnika 1 (Fig. 1, E and 2) dated to the end of the 2nd century BC found at Vrhnika, in the Ljubljana River, and recently published (Gaspari, 2017) and the other finds reinterpreted by Gaspari (2017: 184), has large iron clamps and nailed iron strips used mostly for repairs, which confirms that the use of clamps as a technical solution may be of pre-Roman origin. The presence of fabric noted in the repairs of the Vrhnika logboat could be also connected to maritime shipbuilding practices (Gaspari, 2017: 180), supporting the opening of the Ljubljana River area to Mediterranean influences.

#### *The Adriatic traditions*

To summarize, the Northern Adriatic region is particularly rich in sewn-boatbuilding traditions and, according to the available data, offers the earliest evidence of a Mediterranean sewn boat, in the Zambratija wreck, which dates back to the Late Bronze Age. Three main traditions have been identified running from the Late Bronze Age to the Roman and, possibly, Early Medieval period: the north-eastern Adriatic or Istro-Liburnian on the Istrian and Dalmatian coasts; the northern and north-western Adriatic tradition from Ravenna and the Po Delta to the Venetian area to Aquileia; and the continental tradition of the Danube River basin divided into two sub groups (sewn

and clamped craft). These traditions have their own particularities (sewing pattern, framing assembly, wood used) and are distinct. However, Beltrame and Gaddi (2013: 303) consider there are no 'indicative differences' between the ships from the Eastern and Western coasts of Adriatic and object to the identification of distinct traditions; however, the northern and north-western Adriatic is the most elaborate and, in some aspects, recalls the Greek model (see below). Although less sophisticated, it raises the question of Greek influence. In comparison, the north-eastern Adriatic or Istro-Liburnian tradition appears much less sophisticated and simpler, which does not mean less effective.

Due to their number, strength and persistence, the Adriatic traditions are distinct from other sewn traditions, causing some scholars to have investigated why these traditions survived for such a long period in this geographical area (Carre, 1997; Marlier, 2002). The technical explanation proposed by Beltrame (Beltrame and Gaddi, 2013: 303) that 'the use of sewing techniques to build simple and limited boats was simpler and cheaper than the more common mortise-and-tenon technique' is possible but insufficient because it does not explain why the survival occurred specifically in the Adriatic region. In addition to the power of enduring and engrained traditions and to the commonly assumed conservatism of shipbuilders, it is probable that the longevity of the sewing technique in the Adriatic when the 'mortise-and-tenon' technique was predominant in

the Mediterranean, can be explained by the notion of nautical environment or sailing space (Pomey, 1985: 41; Marlier, 2002), as defined by Chapman at the end of the 18th century (Chapman, 1775), then by the Admiral Pâris (1843), and since developed under the name of ‘maritime cultural landscape’ by Christer Westerdahl (2011). According to this concept, there is a strong relationship between, on one hand, the nautical environment and the cultural and socio-economic context of exploitation and, on the other hand, the ship types being used and their system of construction (Pomey and Rieth, 2005: 38–41). Therefore, the more the sailing space is closed the more the nautical traditions are strong and specific.

In the Adriatic, the different traditions that we have encountered correspond to well-defined sailing spaces well known for their peculiarities. In acting as enclosed spaces they served to preserve the local traditions. The archipelagic characteristic of the Eastern Adriatic coast has specific sailing conditions, which are quite different to those of open-sea navigation, creating a defined sea space. Another model of a closed area can be found on the Italian coastal area with its large network of inland waterways linking fluvial and coastal navigation. Moreover, inland waterways (rivers, coastal lagoons, artificial channels) are by definition confined, and therefore conservative, areas. Due to the particular sailing conditions that these closed areas impose, specific shipbuilding traditions have developed in accordance with their socio-economic contexts. These traditions are particularly well adapted to their regional context and endure over long periods without being totally closed to external influence. Moreover, the continued use of sewing in the Adriatic, in a period when mortise-and-tenon joinery was in general use in Mediterranean shipbuilding, is a strong indication of a local indigenous tradition connected with a strong cultural identity. A similar case of survival of a sewn technic in a specific close context is quoted by Strabo (7, 4, 1), who refers to the contemporary existence of sewn boats on the Lake of Maeotis in the Crimean Peninsula.

### The Iberian tradition with Punic influence

Another sewn-boat tradition, or at least a tradition using some ligatures in ship construction, can be found in Iberia during the Archaic and pre-Roman period and has been termed the Iberian tradition with Punic influence (Pomey, 2012: 24–28) (Figs 1 and 14).

#### *Mazarrón 1 and 2 (Fig. 14.30–31)*

The earliest examples in this group are the Mazarrón 1 and 2 wrecks found respectively in 1980 and 1988 in Mazarrón, near Cartagena (Murcia, Spain) and excavated in 1993–1995 and 1999–2001 (Negueruela *et al.*, 1995; Negueruela, 2000; 2005; Negueruela and Ortiz, 2004; Martínez Alcade *et al.*, 2017). The wrecks, found in the same archaeological context, were first dated to the second half of the 7th century BC, but are

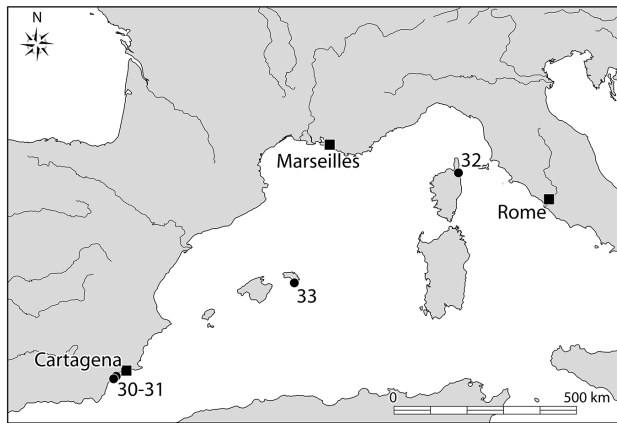

Figure 14. The Iberian tradition with Punic influence: 30) Mazarrón 1; 31) Mazarrón 2; 32) Golo; 33) Binisafüller (drawing V. Dumas, G. Boetto, P. Pomey, AMU, CNRS, CCG).

now dated to the end of the 7th or the beginning of the 6th century BC (625–570 BC) according to a reused Trayamar 1 amphora found on Mazarrón 2 (De Juan, 2014: 30, 2017, 2018: 96; De Juan Fuertes, 2017: 240–242; Cabrera Tejedor, 2018: 319). The remains of Mazarrón 1 include the keel and a part of the planking with some frames (Fig. 15c), but Mazarrón 2 is fully preserved in shape and structure (Fig. 15b). The latter carried a cargo of 2800 kg of lead litharge ingots.

Both boats share numerous common features, but they are not identical. They are of modest size (8.15m long × 2.25m wide for Mazarrón 2) with keeled, round-bottomed hulls and, on Mazarrón 2, a symmetrical longitudinal section. Both are characterized by planking assembled by mortise-and-tenon joints and small cylindrical frames lashed to the planking (Fig. 15a). Each separate lashing goes through four holes drilled through the planking in pairs on each side of a strake seam. However, observation of the lashing system has yet to be completed with respect to the presence or absence of locking pegs and grooves between the holes on the outboard of the hull. On Mazarrón 1, sewing, limited to some planks with internal edges chamfered to accommodate a rope or possibly another waterproofing material, has been observed on the inside of the planking. The pattern and function of the sewing is however not evident and must be clarified, especially for the outboard of the hull and for its general distribution. Different hypotheses have been recently proposed (De Juan Fuertes, 2017: 235 and fig. 5; Cabrera Tejedor, 2017: 218–219 and fig. 10, 2018: 312–316; De Juan 2018: 96), which consider that the function of the sewing is to strengthen the plank seams and to secure a waterproofing material. However, the hypothesis of repairs also seems possible (De Juan 2018: 96), considering the distribution of the sewing that concerns only a limited number of strakes. Note that a loose plank fragment, apparently assigned to the Mazarrón 2 wreck, has the same stitch marks, but in this case, according to the general assembly

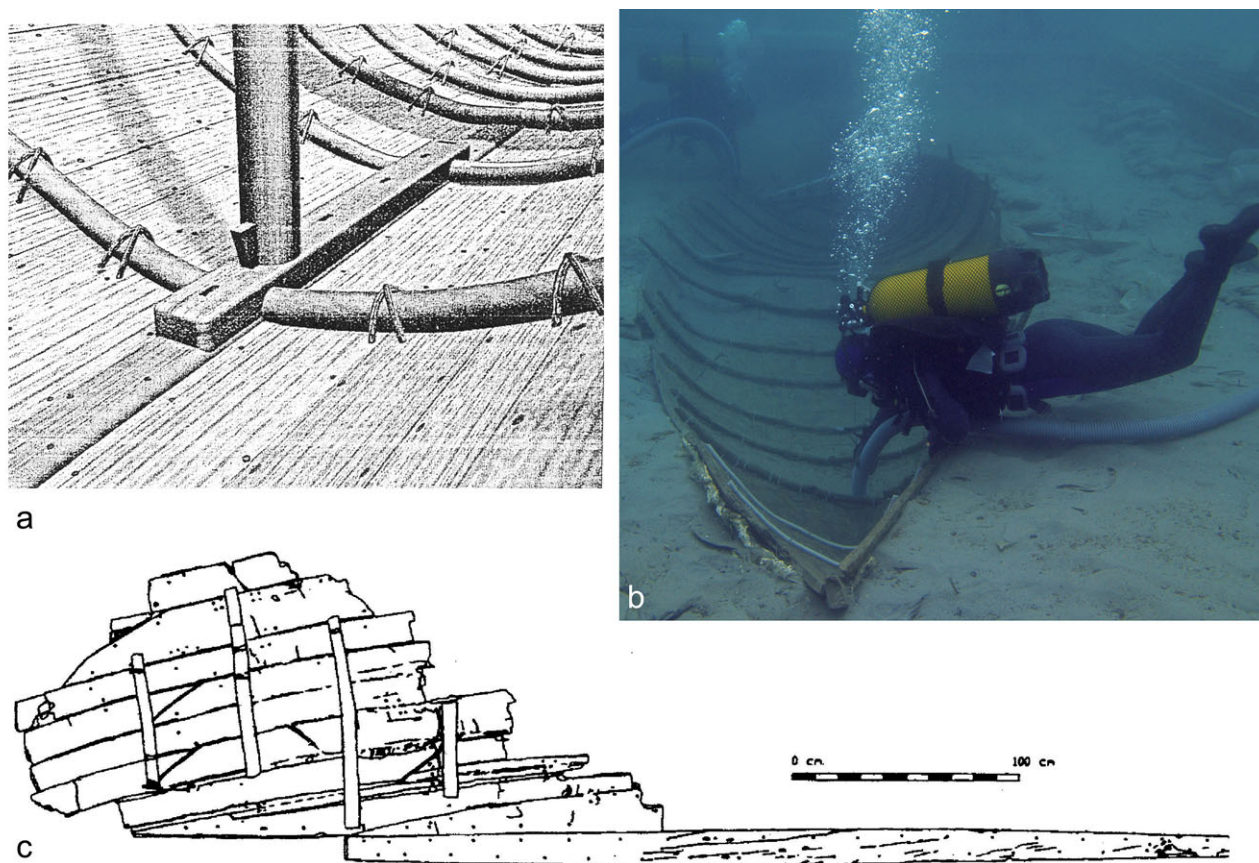

Figure 15. a) Mazarrón 2, drawing of the hull bottom with the lashing of the frames and the mast-step timber (from Negueruela, 2005); b) Mazarrón 2, general view of the hull during the 2008 excavation (photo J.A. Moya); c) Mazarrón 1, plan of the hull remains (from Negueruela *et al.* 1995).

system of the planking by mortise-and-tenon joints of this boat, it is obviously a repair (Cabrera Tejedor, 2018: 306, 312). On Mazarrón 2, a mast-step timber was set over the frames but in contact with the keel between the frames. Several beams were fitted into the side planking using dovetail joints. No sewing on the general planking of Mazarrón 2 has been observed as yet. In both wrecks, a protective waterproof coating has been observed on the inside of the hull.

#### **Golo (Fig. 14.32)**

The wreck was found in 1777 in Corsica at the mouth of the river Golo near Bastia, and was precisely recorded at the time and published by Admiral Pâris (1892: 241). The vessel, preserved in its entirety and more than 14m long (from 14.40m to 14.95m according to different documents), was considered to be ancient but of unknown origin. Reconsidered in the light of recently discovered archival documents and of recent wreck discoveries, it has been suggested that the boat should be included in the same tradition as Mazarrón 2 and dated to the 6th century BC (Pomey, 2012). The general characteristics of the boat are quite similar to Mazarrón 2: it has a similar longitudinal profile

and round transversal section with a keel (Fig. 16); a similar pattern of mortise-and-tenon fasteners for the planking (Fig. 17b); cylindrical frames; and a similar implantation of the mast-step timber. How the frames were attached was not precisely observed, but several clues, such as the absence of any nail or treenail and the remains of cords, indicate that the cylindrical frames were very likely lashed to the planking, as on Mazarrón 1 and 2.

#### **Binisafüller (Fig. 14.33)**

Similar characteristics were recorded in the 4th-century-BC Binisafüller wreck found in Minorca in the Balearic Islands. The wreck, found in the 1960s, first excavated in 1975, and again in 2006–2007, was dated to 375–350 BC by its cargo of Iberian amphoras from the region of Valencia (De Juan *et al.*, 2010; De Juan, 2014, 2017, 2018: 90–95). The planking is assembled with mortise-and-tenons, but in a more sophisticated pattern than that seen on the Mazarrón and Golo wrecks (Fig. 17c). All the frames are lashed to the planking (Fig. 18a). The lashing system is similar to the Mazarrón 1 and 2, but the holes in the planking are slightly angled and pegs locking the stitches have



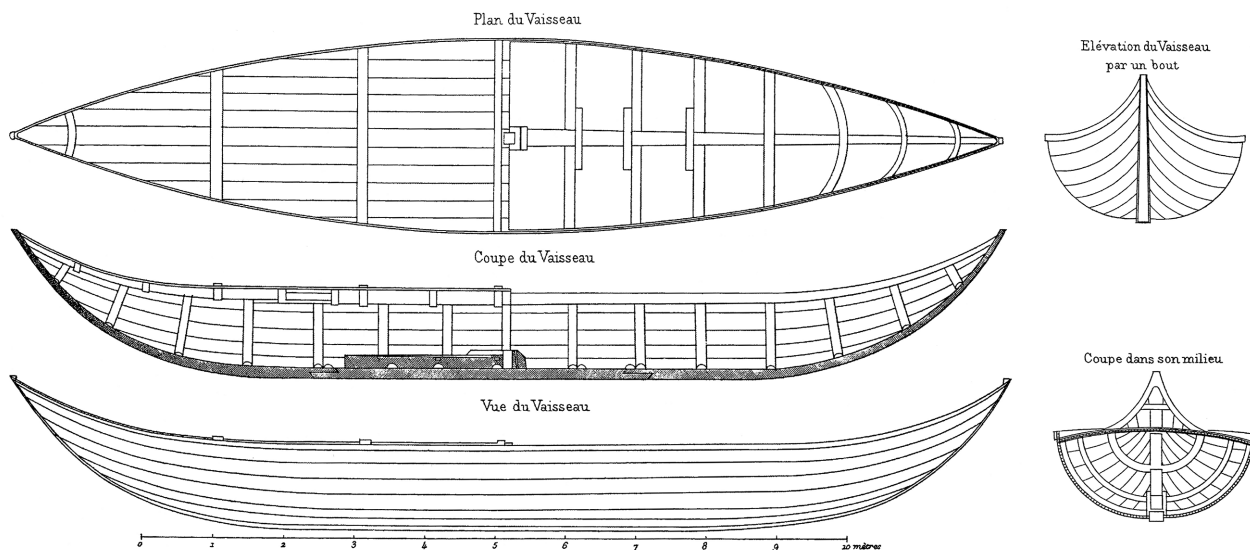

Figure 16. Golo shipwreck: plan, sections and elevations (from Pâris, 1892).

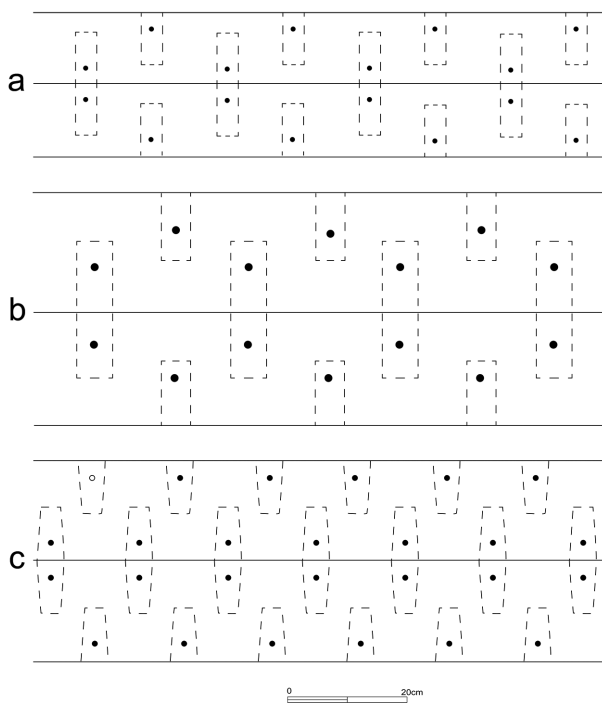

Figure 17. Mortise-and-tenon pattern of: a) Mazarrón 2; b) Golo; and c) Binisafüller (drawing G. Boetto, AMU, CNRS, CCJ; after De Juan, 2014 and Pomey, 2012).

been observed (Fig. 18b). On the outboard face of the planking, a groove, filled with pitch, links pairs of holes to lodge and protect the lashing. The frames have a round back and a narrow foot, rather than being cylindrical, which allows a stronger lashing. A protective coating covers the inside of the hull.

### Discussion

The main characteristics of the four wrecks in this group defined as the Iberian tradition with Punic influence are:

- planking with mortise-and-tenon joints. Some sewing observed on the planking of Mazarrón 1 and probably to a limited extent on Mazarrón 2.
- cylindrical, then trapezoidal, frames lashed to the planking through four vertical or diagonal holes drilled in pairs on each side of strake seams;
- pegs used to lock the ligatures in place (Binisafüller);
- protective and waterproofing coating covering the hull, inside (Mazarrón 1 and 2, Binisafüller) and outside (Mazarrón 2, Binisafüller).

The continued use of lashings for frames in a period when nailing or treenailing the framing was generalized in Mediterranean shipbuilding is a strong indication of a local indigenous tradition. Other evidence of the survival of this tradition can be seen in the similarity between the Mazarrón and the Golo hull shapes, and the hull shape of the small boats depicted on Iberian coins of the Roman period of the 1st century BC (De Juan, 2014: 32–33, 2018: 98–100) (Fig. 19). Indeed, two archetypes, representing a large two-masted merchant ship and a little coastal boat, are depicted on these coins, each with its own symbolic significance. The latter attests to the permanence from the Archaic period to the Roman times of the use of this typical coastal boat.

The Mazarrón boats are coastal crafts of local construction (Guerrero Ayuso, 2008; Pomey, 2012: 24–25; De Juan, 2014, 2018). The continued use of lashed frames several centuries later, and the use of sewing,

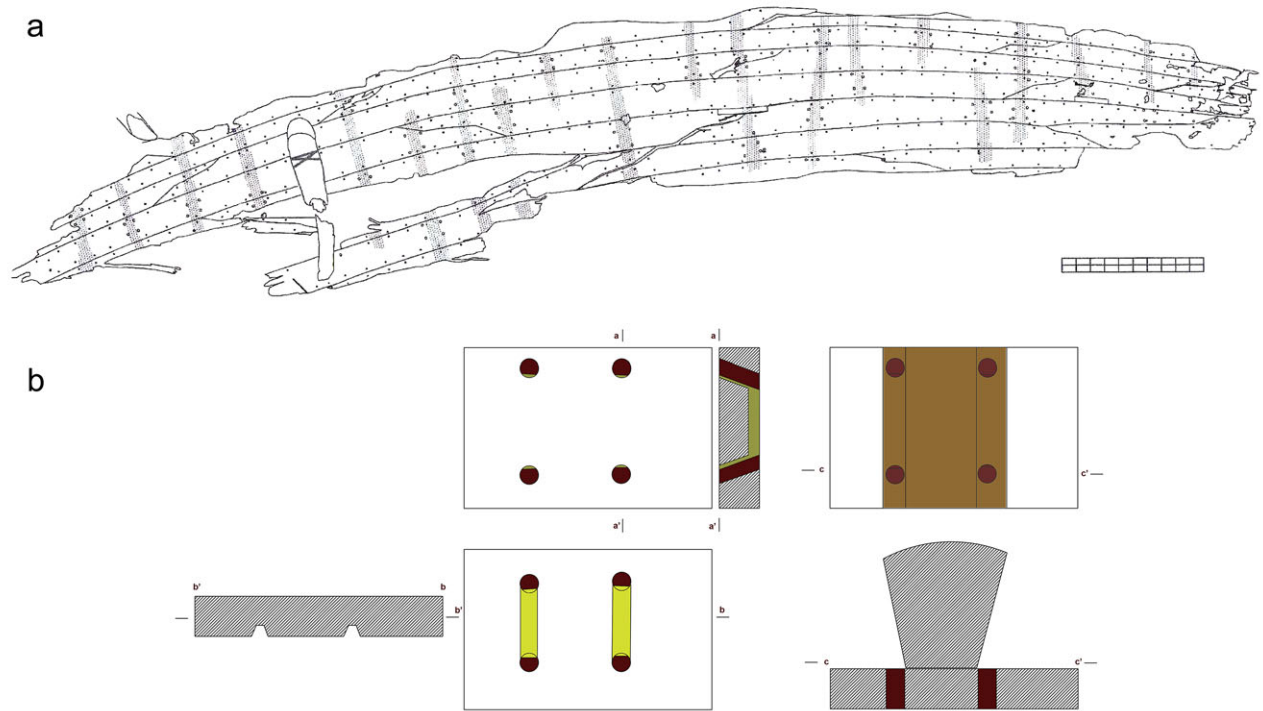

Figure 18. Binisafüller shipwreck: *a*) plan of the hull remains (after De Juan, 2018: fig. 1); *b*) schema of the lashed-frame assembly system (after De Juan, 2018: fig. 7).



Figure 19. Ancient coin from Dertosa and drawing of the boat (after De Juan, 2018: fig. 9).

even if partial, on Mazarrón 1 and probably Mazarrón 2, are very likely evidence of an earlier local tradition of Iberian origin. On the other hand, the use as early as the Archaic period of mortise-and-tenons for the planking, reveals an obvious Punico-Phoenician influence, or, more simply, of the Punic tradition of shipbuilding as a result of the presence of Punic settlements in southern Iberia. We have to remember that pegged mortise-and-tenon fasteners, evidenced in Mediterranean seagoing ships from the Bronze Age in the eastern Mediterranean by the Uluburun wreck (Turkey) dated to the end of the 14th century BC (Fig. 1, L; Bass, 1989; Pulak, 1998, 1999) and the Cape Gelidonya wreck to the end of the 13th century BC (Fig. 1, M; Bass, 1967, 1999),

likely had their origin on the Levantine coast in a Canaanite or proto-Phoenician context (Wachsmann, 1998; Polzer, 2011; De Juan, 2017). During the Roman Republican period, Cato the Elder (*De agr.*, XXI, 18, 9) termed mortise-and-tenon joints '*coagmenta punicana*', underlining their Punico-Phoenician origin.

We don't have knowledge of the local Iberian tradition of shipbuilding prior to this Punic influence. But, as a hypothesis, one could propose that the use of sewing and lashing techniques were much more widespread before the adoption of mortise-and-tenon fasteners, which was an imported technique. The sewing observed on Mazarrón 1, and possibly on Mazarrón 2, and the lashing of the frames used on all the boats in this group are probably a testimony of this past practice. In any case, the memory of this local technique was strong enough to give rise in the pre-Roman period to an Iberian tradition with Punic influence, which remained in use until the Roman period.

### The Greek tradition

The Greek sewn-boat tradition is well attested throughout the Mediterranean. Unlike the previous traditions, where the wrecks are directly linked to the regions they characterize, the Greek wrecks are spread both in the western and eastern Mediterranean and this from the Archaic period due to the phenomenon of colonization (Figs 1 and 20). Despite a more





Figure 20. The Greek tradition: 34) Bon-Porté 1; 35) Giglio; 36) Jules-Verne 9; 37) Pabuç Burnu; 38) Cala Sant Vicenç; 39) Jules-Verne 7; 40) Villeneuve-Bargemon 1/ César 1; 41) Grand-Ribaud F; 42) Gela 1; 43) Gela 2; 44) Ma'agan Mikhael; 45) Kyrenia; 46) Ereğli E (drawing V. Dumas, G. Boetto, P. Pomey, AMU, CNRS, CCJ).

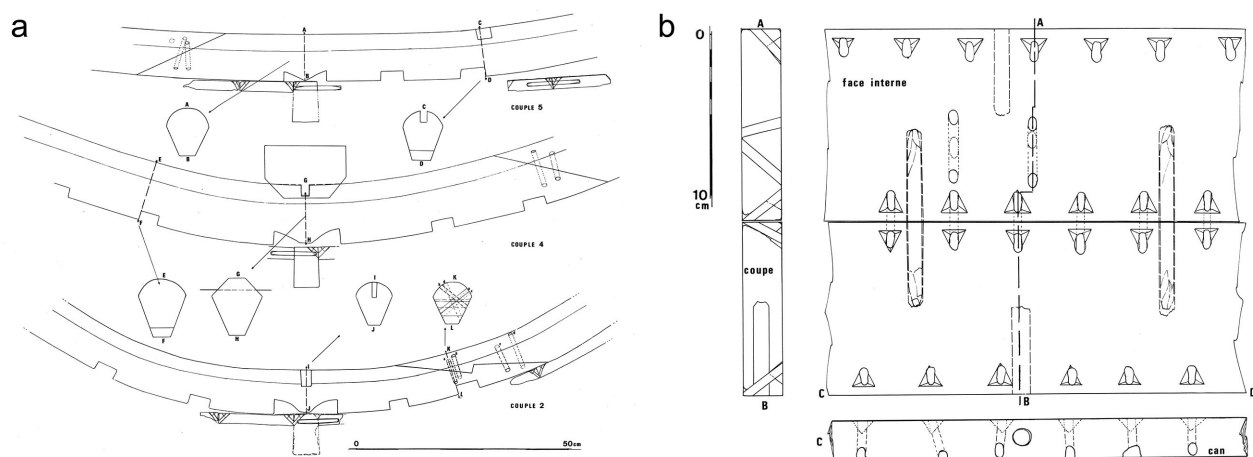

Figure 21. Bon-Porté 1: a) transversal sections of the hull remains (from Joncheray 1976); b) schema of the sewing assembly system of the planking (from Joncheray, 1976).

dispersed distribution, most of these wrecks can be attributed to a well-defined Greek context by their crew artefacts, cargo, or location. If the location of the shipyards in which they were built remains unknown, with the exception of the wrecks of the Place Jules-Verne in Marseilles, their place within a Greek tradition is certain from a typological point of view because of the use, in whole or in part, of a common sewn assembly system. It is characterized, in particular, by the presence of tetrahedral recesses associated with the stitch-channels. These tetrahedral recesses are without equivalent and constitute a true ‘technical signature’ or ‘fingerprint’ (Pomey and Rieth, 2005: 35–38). This particular assembly system is part of a common architectural system characterized by a hull constructed with timbers of similar and distinctive morphologies. This ensemble of characteristics changes, however, from the end of the Archaic era following the introduction of mortise-and-tenon joints to the Greek tradition of assembly by ligature, which led to the gradually diminishing role of ligatures until their final disappearance. At the same time, the structure of the ships changed and it is possible to follow several stages in this development over the centuries (Pomey, 1997; Kahanov and Pomey, 2004; Pomey, 2010, 2016, 2017b). These specificities of the Greek tradition of assembly by ligatures and its developments will now be examined.

#### ***Bon-Porté 1 (Fig. 20.34) and Giglio (Fig. 20.35)***

The first wreck recognized as a Greek Archaic sewn boat was Bon-Porté 1. It was discovered in 1974 near Saint-Tropez (France) (Joncheray, 1976a) and published in 1976 as an Etruscan or Greek boat. It was dated by its cargo of Etruscan and supposed Ionian amphoras to the second half of the 6th century BC, but the assembly system, quite unique at the time, was

not understood (Fig. 21). Basch suspected that it could be a former sewn boat but suggested it would have been reassembled with dowels (Basch, 1976, 1978). It was only in 1981 that it was recognized as a genuine sewn boat though comparison with the Zaton and Lipe boats from the Adriatic, and sewn boats from the Indian Ocean (Pomey, 1981). Only in 1990, following the identification of the Massalian amphoras of the boat’s cargo and the Massalian artefacts belonging to the crew, was it accepted as a Greco-Massalian, rather than an Etruscan boat (Pomey and Long, 1992: 192; Long and Sourisseau, 2002); a hypothesis first made by Liou on its discovery (1975: 597).

Meanwhile, another wreck was discovered in 1985 on Giglio Island (Italy) (Bound, 1985, 1991). The hull remains, quite fragmented and from a larger ship, present the same assembly characteristics as Bon-Porté 1. The boat, first considered as Etruscan or Greco-Etruscan because of its mixed cargo, has since been recognized as of Greco-oriental origin (Cristofani, 1996) following the study of the artefacts (Fig. 22). Finally, the Greek origin of the Bon-Porté 1 and Giglio wrecks and their affiliation to a single sewn-boat tradition was definitively confirmed in 1993 by the excavation of the Jules-Verne 9 wreck. The high degree of similarity of the assembly techniques of these three wrecks—to the point that Bon-Porté 1 and Jules-Verne 9 can be considered as sister ships—and the fact that Jules-Verne 9 was built in a Greco-Massalian shipyard (see below) make it possible to attribute these boats to the same tradition of Greek origin.

#### ***Jules-Verne 9 (Fig. 20.36)***

During excavation of part of the ancient Greek and Roman harbour in Place Jules-Verne, Marseilles, close to the ‘Old Harbour’, the remains of seven boats were found in 1993, of which two are Greek

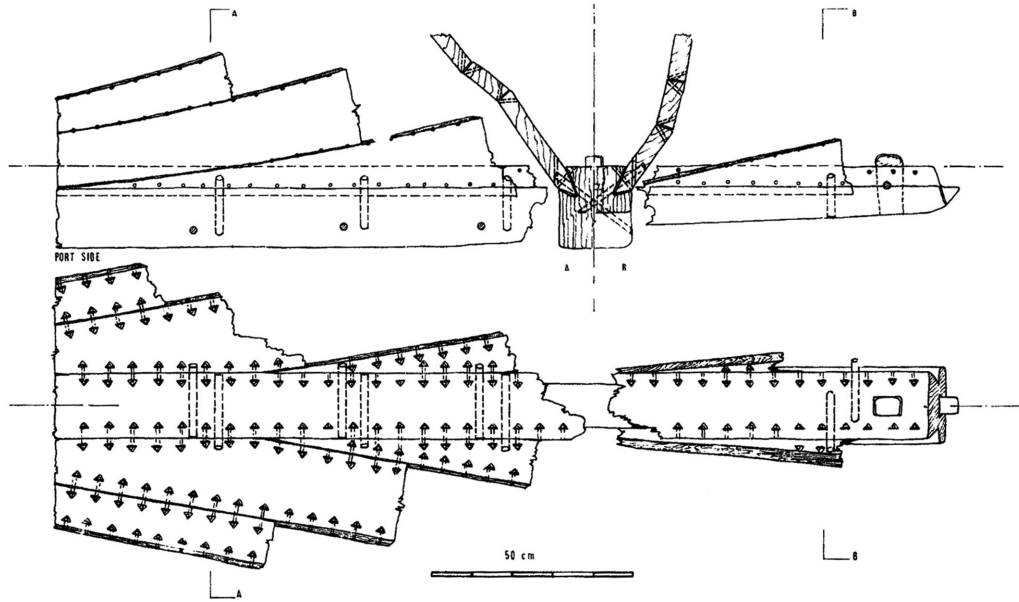

Figure 22. Giglio shipwreck: reconstruction of keel and planking (drawing S. Dobbs, from Linder and Kahanov, 2003).

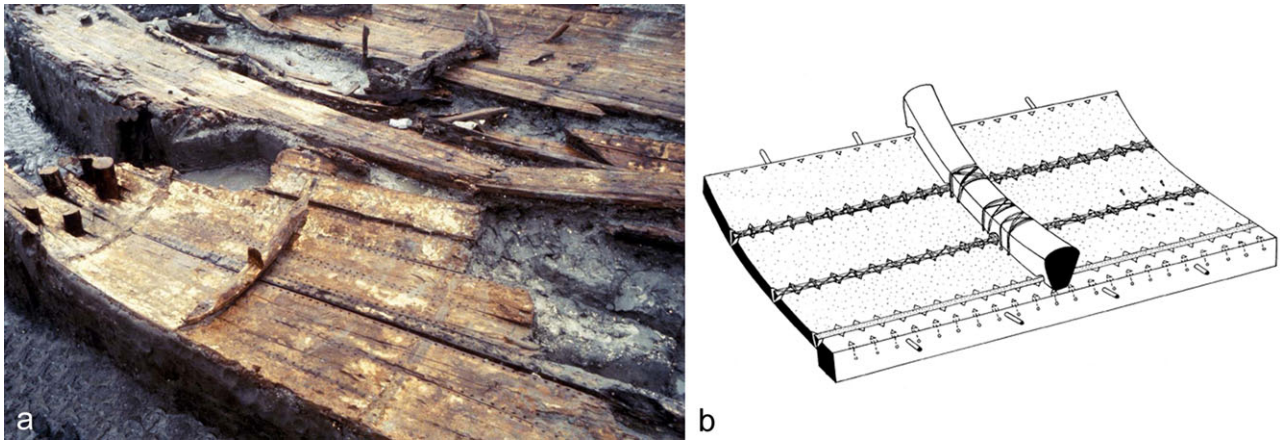

Figure 23. Jules-Verne 7 and 9: a) view of the wrecks *in situ* (photo M. Derain, CNRS, CCJ); b) Jules-Verne 9: axonometric illustration of the sewing and lashing assembly system (drawing M. Rival, AMU, CNRS, CCJ).

Archaic and five are Roman vessels (Pomey, 1995) (Fig. 23a).

The remains of Jules-Verne 9 are 5m long and 1.4m wide and correspond to a small coastal craft, about 10m long, abandoned toward the end of the 6th century BC (Pomey, 1998, 2001). The boat, used locally for fishing and light transport, was, for that reason, built in a Massalian shipyard, probably around the middle of the century. That is, by the second generation of the Greek colonists from the Ionian city of Phocaea, in the Aegean Sea, who founded Marseilles-*Massalia* c.600 BC. The boat is testimony to Greek shipbuilding techniques of the Archaic period being used in the Phocaeian city of *Massalia*. These techniques very likely emanated from the Aegean Sea, as suggested by the

Pabuç Burnu wreck (see below). The main characteristic of Jules-Verne 9 is that it is a sewn boat. Fortunately, the remains were quite homogeneous and the sewing was partly preserved thanks to the coating of wax and pitch that covered the inside of the hull for protection and to render the hull watertight. Thus, it was possible to thoroughly understand the assembly technique and to build a full-scale model of the sewing and lashing systems used for the planking and framing. After the full digital reconstruction of the original boat (Pomey, 2003), a sailing replica, *Gyptis*, was built (Pomey, 2014, 2017a; Pomey and Poveda, 2017, 2018).

Compared to other Mediterranean sewing systems, the Greek system appears very sophisticated. First, pre-assembly dowels are driven into holes pre-drilled in



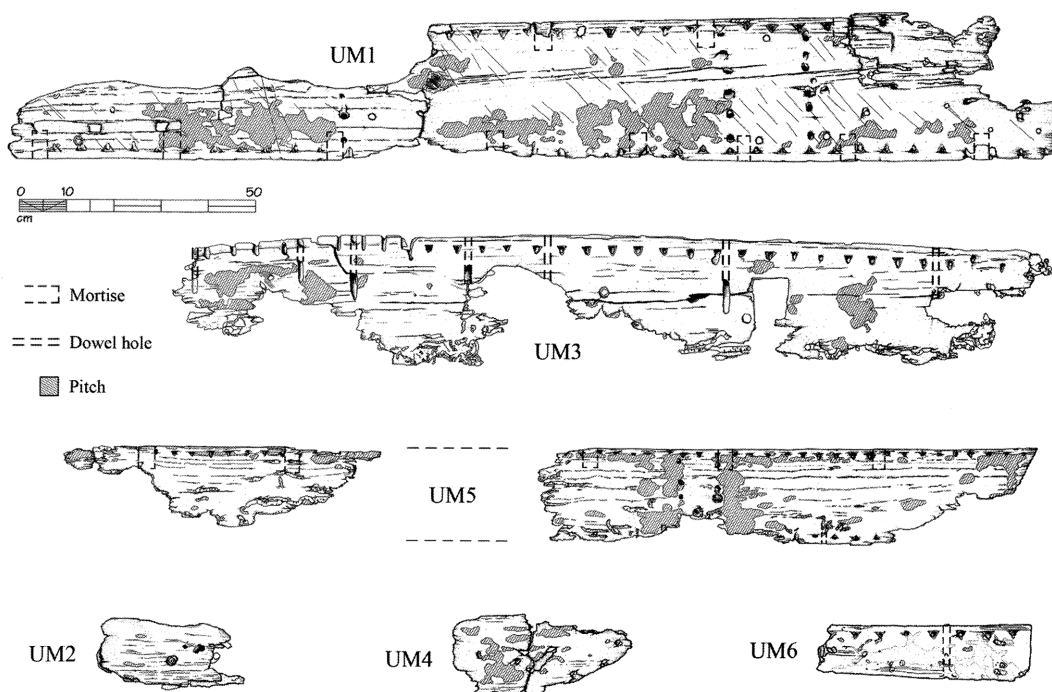

Figure 24. Pabuç Burnu shipwreck: planks remains (from Polzer, 2010).

the thickness of the plank edges in order to keep the planks in place and to prevent shearing (Fig. 23b). Then oblique channels were drilled for the passage of the stitches. They start in from the edge of the inner face of the plank and finish just on the lower corner of the outer plank face. In this way, the stitches remain slightly inside the lower corner of the plank without protruding, thus avoiding chafing. Tetrahedral recesses were cut regularly along the inner edge of the planks around the entry of each oblique channel. During the sewing, the stitches are lodged in the angles of each tetrahedral recess and thus always have the same orientation. In this way the recesses give a great regularity to the sewing and avoid sharp angles that might damage the stitches.

Over the plank seams, prior to sewing, wadding made of a roll of linen fabric was placed for water tightness. The wadding also cushions the ligature. The seams are sewn with three linen threads, in a IXIXIX pattern, corresponding to a double clamping turn with a diagonal passage from one end of the seam to the other forming the first arm of the cross and then back forming the second. Small pegs were then driven into the channels to lock the stitches and to plug the holes.

The positions of all the assembly elements (dowels, tetrahedral recesses, and diagonal channels) were precisely scribed on the wood in advance by the carpenters.

The framing system is made of widely spaced floor-timbers (average space 0.90m) and futtocks. The futtocks are connected to the floor-timbers by a simple

hook scarf locked by several trenails. A disarticulated element was found that corresponds to a top timber and indicates the probable presence of these timbers between the floor-timbers in the upper part of the hull. Frames have a narrow foot, flared sides and a round back to enable stronger clamping. Their base is crenellated to clear the sewing and wadding of the planking seams. The frames are lashed with linen cord that passed through the planking in diagonally cut channels and over the back of the frames. Little pegs locked the cords in place and plugged the channels. Unlike the floor-timbers, the top-timbers were treenailed and lashed with internal lashings.

Finally, a coating of a mixture of beeswax and resinous pitch was applied inside—and probably also outside according to results from the experimental sailing replica *Gyptis* (Pomey and Poveda, 2017: 230–231, 2018: 51–52)—of the hull.

The same assembly characteristics are found on the Giglio and Bon-Porté 1 wrecks.

#### *Pabuç Burnu (Fig. 20.37) and Cala Sant Vicenç (Fig. 20.38)*

The Pabuç Burnu wreck was excavated in 2002–2003 near Bodrum (Turkey), on the Ionian coast (Polzer, 2010) (Fig. 24). It is dated around 570–560 BC by its cargo of Greek Ionian amphoras. The Cala Sant Vicenç wreck was excavated in 2002–2004 on Majorca in the Balearic Islands (Niето and Santos, 2008, 2010). Its cargo suggests the boat is very likely of Massalian origin and can be dated to the last third of the 6th

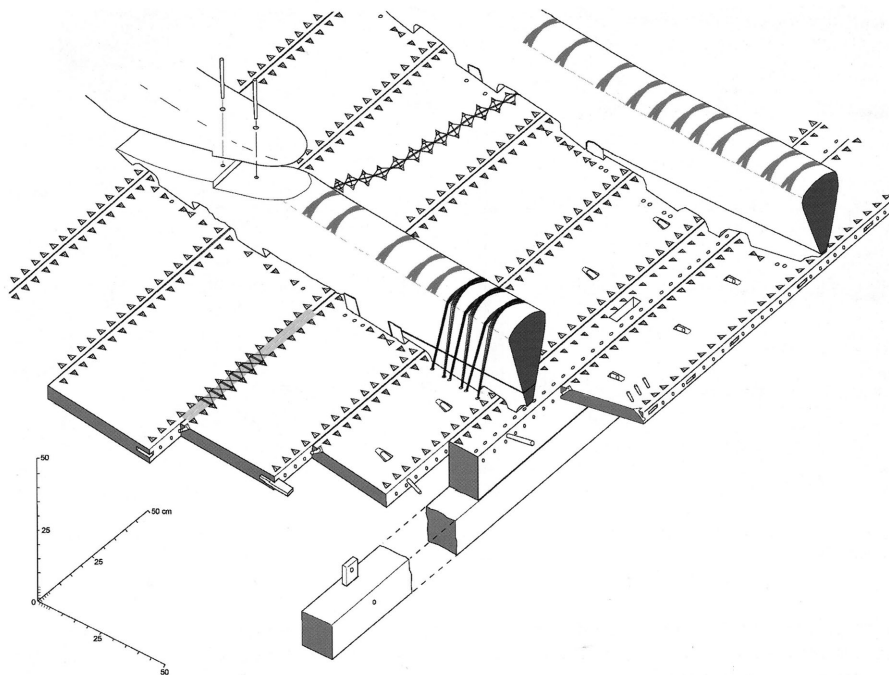

Figure 25. Cala Sant Vicenç shipwreck: reconstruction drawing of the boat structure and assembly system (from Nieto and Santos, 2008).

century BC. However, both wrecks present the same sewing system with tetrahedral recesses and the same particularity of having pre-assembly unpegged tenons and cylindrical dowels. However, for the Pabuç Burnu wreck, it is impossible to know precisely which part of the ship the plank fragments come from and, by consequence, the pattern of tenons and dowels use in the hull. In any case, the dowels appear to have been used for repairs. On Cala Sant Vicenç, the dowels are used to fit the garboard to the keel and also correspond to a repair, and tenons are used for the pre-assembly of the rest of the planking (Fig. 25). The lashed frames found on Cala Sant Vicenç are similar to those found on Jules-Verne 9, but no framing was preserved on Pabuç Burnu.

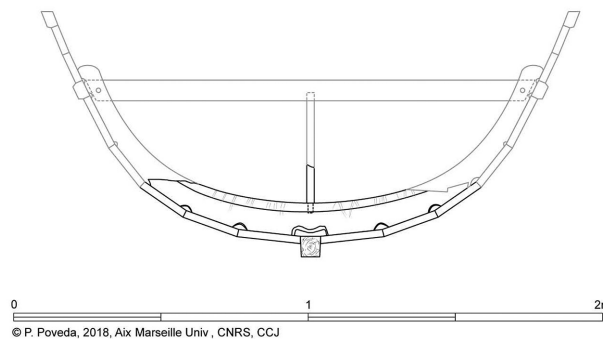

Figure 26. Jules-Verne 9: reconstruction drawing of the transversal main section (drawing P. Poveda, AMU, CNRS, CCJ).

### ***The Greek Tradition: original phase***

All of these wrecks were found in Greek or Massalian contexts of the 6th century BC, whether in the eastern or western Mediterranean. They belong to the same Greek Archaic sewn-boat tradition, and they correspond to large ships, 15–25m long, such as Giglio, Pabuç Burnu and Cala Sant Vicenç, or smaller boats around 10m long, such as Bon-Porté 1 and Jules-Verne 9 (Pomey, 2008).

According to current data, and lacking earlier examples in Greek contexts, this group of wrecks allows us to define a Greek Archaic tradition of sewn boats that can be called the ‘original phase’ of this tradition (Pomey, 2010, 2016, 2017b).

From an architectural point of view this original Greek sewn-boat tradition (five wrecks) is characterized by:

- a round transversal section (Fig. 26);
- a keel without rabbet; the extremities only of the stem and sternpost are rabbeted; the keel, stem and sternpost are assembled by keyed hook scarfs with a vertical wedge (Jules-Verne 9);
- planking is pre-assembled using cylindrical dowels (Giglio, Bon-Porté 1, Jules-Verne 9) or rectangular unpegged tenons and dowels (Pabuç Burnu, Cala Sant Vicenç);
- planking is assembled by sewing; the stitches pass through obliquely cut channels perpendicular to the



plank edge and associated with tetrahedral recesses cut along the inner edge of the planks; the sewing has a cross-stitch pattern with clamping turns (LXIXIX type); the stitches are locked in the channels by little pegs; carpenter's marks ensure the perfect regularity of the sewing (Jules-Verne 9);

- wadding made of a fabric roll is set over the seams before sewing for water tightness;
- framing made of widely spaced floor-timbers connected to futtocks with hook scarfs locked by treenails and probably alternating with top-timbers (Jules-Verne 9); frames are characterized by a narrow base, flared sides and a round back, which allows a strong clamping; the foot is crenellated to avoid the plank seams;
- floor-timbers and futtocks are lashed to the planking with cords going through the planking in diagonal channels and encircling the frames, locked with pegs; top-timbers are treenailed and lashed with internal lashings (Jules-Verne 9);
- a mast-step timber fitted over the floor-timbers (Bon-Porté 1);
- a protective, watertight coating (beeswax and coniferous pitch on Jules-Verne 9) was spread on the inboard surfaces.

The sewing technique used in this group is unique and is characterized by the tetrahedral recesses. It appears very elaborate and sophisticated. Everything works to ensure the efficiency and regularity of the sewing: pre-assembly elements, tetrahedral recesses, carpenter marks, and frame morphology. Obviously, from the point of view of the history of technology, such an elaborate system could not have been conceived from the outset at this level of sophistication. It denotes a maturity that could only be achieved by a long development. In the present absence of Greek archaeological examples prior to the 6th century BC, it can only be conjectured that this tradition very likely originated as far back as the Bronze Age, in accordance with Homer (*Iliad*, 135; *Odyssey*, 5, 244–257; Mark, 2005), who attests the use of sewn boats in the Homeric times. Considering the Massalian origin—and therefore Ionian—of the Jules-Verne 9, Bon-Porté 1, and Cala Sant Vicenç wrecks, and the probable Ionian origin of Pabuç Burnu and the Greco-oriental origin of the Giglio wreck, it is very likely that this Greek sewing technique originated in the Aegean and spread later to the western Mediterranean with Greek colonization, and especially with the Phocaeen move to *Massalia*.

## The Greek tradition: transition phase

### *Jules-Verne 7 (Fig. 20.39)*

A second Greek wreck from Marseilles, Jules-Verne 7, found near Jules-Verne 9 and abandoned at the end of the 6th century BC, is characterized by a mixed system of assembly employing mortise-and-tenon, sewing, and nail fasteners. Due to the presence

of the same carpenter's marks on Jules-Verne 7 and Jules-Verne 9, both boats are very probably the issue of similar Massalian shipyards. The sewing is similar and characteristic of the Greek system with tetrahedral recesses, and the hull structure and the morphology of the components are identical.

The remains are 14m long and 4m large and, according to the reconstruction, correspond to a sailing boat about 15m long (Pomey, 1998, 2003; Poveda, 2012: 383–428).

The main part of the planking is assembled with mortise-and-tenon joints (Figs 27a and 27b). The mortise-and-tenon pattern, with long, narrow tenons (140 × 30mm) spaced at intervals of 6.6 times their width (200mm) is much less dense than the pattern seen on vessels of the Hellenistic and Roman Republican periods. This is a characteristic of the archaic mortise-and-tenon joint, also seen in the Mazarrón and Golo wrecks (see above) (Fig. 17). However, at the extremities, planks were sewn into rabbets on the keel ends, stem, and sternpost as part of the original build (Fig. 27c). Sewing was also used for the numerous repairs: repairs on mortise-and-tenon joints, cracks in planks, and for wooden patches (Fig. 27d). This indicates that repairs using the mortise-and-tenon system were more difficult to carry out than sewn repairs and had not been mastered. Indeed, according to our data, the first example of a repair made using mortise-and-tenon joints is the Kyrenia shipwreck at the end of the 4th century BC (Steffy, 1994: 57, 1999).

Frames were nailed using clenched iron nails, and top frames were treenailed and lashed at their base only. However, the morphology of the frames remains similar to those of the original phase; trapezoidal for a firmer lashing, even though they were no longer lashed in place (Fig. 27e). The framing is made of floor-timbers with futtocks (average space 0.90m) alternated with top-timbers, and there is clear evidence of cross-beams, being treenailed to the side of the upper end of each frame (Fig. 28).

### *Villeneuve-Bargemon 1 (also called César 1) (Fig. 20.40)*

The wreck was found in Marseilles, Place Villeneuve-Bargemon, which is close to Place Jules-Verne, in the same harbour context, and dated to the end of the 6th century BC (Pomey, 2001). The wreck has the same dimensions, shape and structure as Jules-Verne 9, but the assembly technique is similar to Jules-Verne 7.

### *Grand-Ribaud F (Fig. 20.41)*

The wreck, found off the Grand-Ribaud islet in the Hyères Archipelago (France), is dated to the early 5th century BC by its cargo (Long *et al.*, 2006). Despite its cargo of Etruscan amphoras, all the observed hull components (planking, frames, sternpost, keelson ...) present the same characteristics as Jules-Verne 7 (Fig. 29), even if it is much larger with a likely length of 25m (Pomey, 2006).

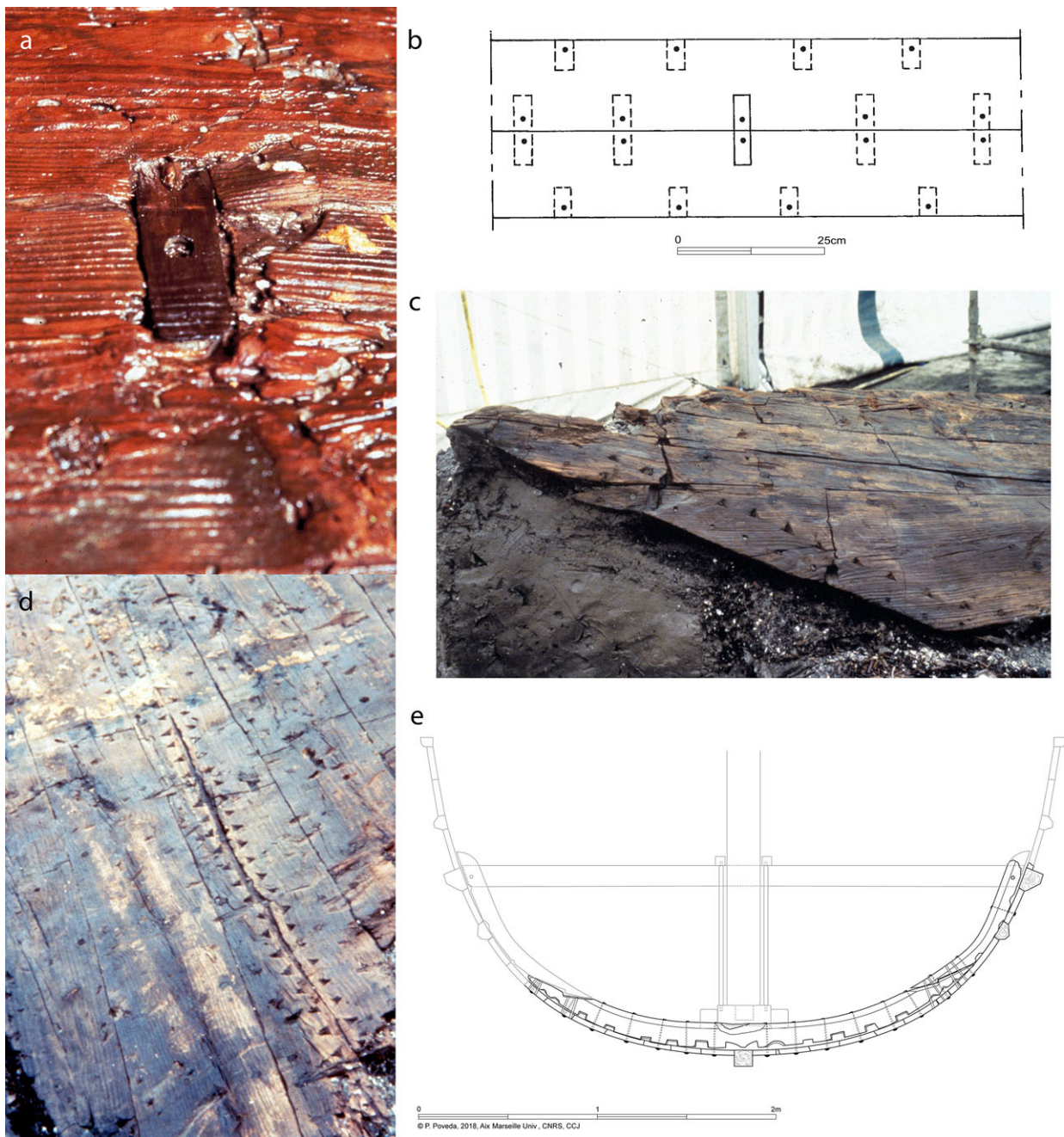

Figure 27. Jules-Verne 7: a) detailed view of a tenon assembly (photo M. Derain, AMU, CNRS, CCJ); b) schema of the mortise-and-tenon joints (drawing M. Rival, AMU, CNRS, CCJ); c) detailed view of the original sewing between the planking and the stempost (photo M. Derain, AMU, CNRS, CCJ); d) detailed view of the sewing on a plank repair (photo M. Derain, AMU, CNRS, CCJ); e) reconstruction drawing of the transversal main section (drawing P. Poveda, AMU, CNRS, CCJ).

Both Villeneuve-Bargemon 1 and Grand-Ribaud F belong, with Jules-Verne 7, to a ‘transition phase’ corresponding to the introduction of the use of mortise-and-tenon joints within the Greek tradition of assembly by ligatures. This transition phase led, over several developmental stages, to the abandon of sewn techniques in favour of mortise-and-tenon joints (Pomey, 2010, 2016, 2017b).

**Gela 1 (Fig. 20.42)**

The boat was found in 1988 on the southern coast of Sicily off the Greek settlement of Gela (Panvini, 2001; Vullo, 2012). According to its cargo and artefacts belonging to the crew, the wreck is dated to the beginning of the 5th century BC and likely came from the Aegean area (Cristofani, 1996; Panvini and Tortorici, 2012). The hull of this large ship,

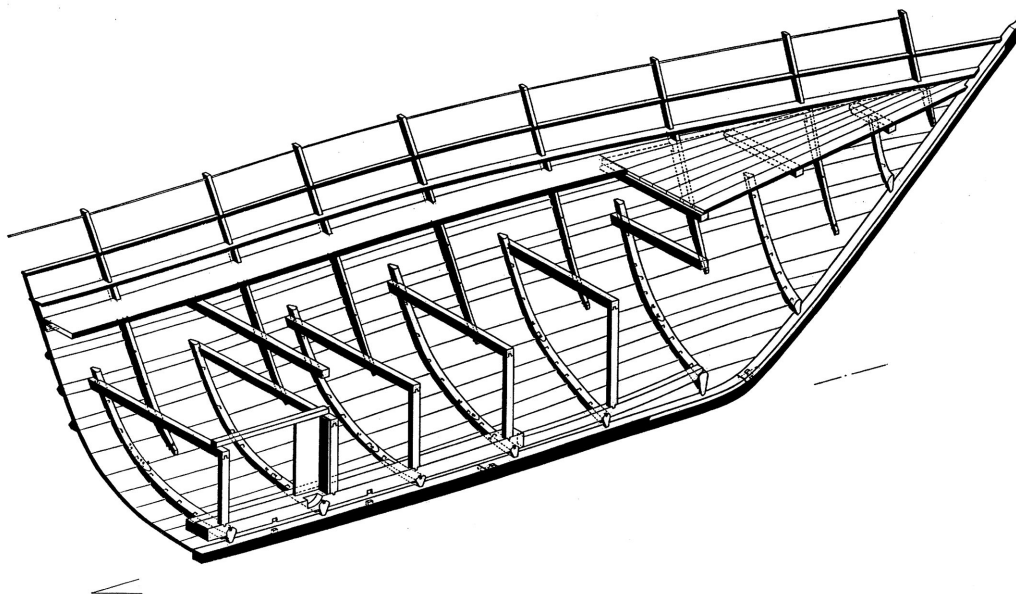

Figure 28. Jules-Verne 7: axonometric reconstruction of the hull structure on the fore part (drawing M. Rival, AMU, CNRS, CCJ).

originally about 22–25m long, preserved over 17m, presents numerous similarities with Jules-Verne 7, but also some differences (Benini, 2012, 2017) (Fig. 30). Sewing is the dominant technique used to assemble the planking, but it presents variants. Moreover, mortise-and-tenon joints are used simultaneously with sewing and were observed only on the extremities, where they regularly alternate with cylindrical dowels. However, the distribution of the mortise-and-tenon joints still needs to be detailed. According to the general characteristics of the sewing, hull structure, and morphology of the components, Gela 1 belongs to this Greek sewn-boat family, but represents another transitional step between the pure sewn tradition and the full mortise-and-tenon technique. Nevertheless, due to the features that distinguish Gela 1 from the Jules-Verne-7 type, the wreck can be seen as evidence of either a specific local construction process, or repairs, or refitting—or both—and may reflect an earlier step in the transition phase in which the use of mortise-and-tenon joints was limited to the ends of the vessels. It is placed provisionally in the same transition group as Jules-Verne 7.

### Discussion

This group (four wrecks) constitutes the first developmental stage—or possibly several steps—that can be identified within the Greek sewn-boat tradition. The general shape and structure of the boats are similar to the previous type, but they present new characteristics:

- the keel extremities and the stem and stern post are rabbeted;

- the planking is mainly assembled by mortise-and-tenon joints, but sewing with pre-assembly cylindrical dowels, similar to the previous sewing system, is still used for the extremities and for repairs (Villeneuve-Bargemon 1, Grand-Ribaud F, Jules-Verne 7); in Gela 1, which is probably an intermediate or specific step in this group, sewing is dominant, but presents some variants, and mortise-and-tenon joints seem to be used only on the ends of the vessel and in addition to sewing; pegged tenons alternate with cylindrical dowels;
- trapezoidal frames are nailed to the planking with clenched nails; the top-timbers are treenailed and lashed (Jules-Verne 7);
- the mast-step timber is fitted over the floor-timbers but also connected to the keel with vertical keys, and is extended fore and aft by a keelson (Gela 1, probably Jules-Verne 7, Grand-Ribaud F);
- a protective, watertight coating was spread over the inboard and, probably, outboard surfaces the hull.

This group concerns large ships (Grand-Ribaud F, Gela 1), medium-sized boats (Jules-Verne 7), and one small boat (Villeneuve-Bargemon 1) (Pomey, 2008). It corresponds to the beginning of the transition from the sewing system of assembly to the mortise-and-tenon joint in the Greek context (Pomey, 1997, 2010, 2016, 2017b). This development has been found in a Massalian context, as well as an Aegean one. Although it is difficult to know the precise location of the shipyards that built Grand-Ribaud F and Gela 1, their origin is certainly Greek according to their general construction and sewing characteristics.



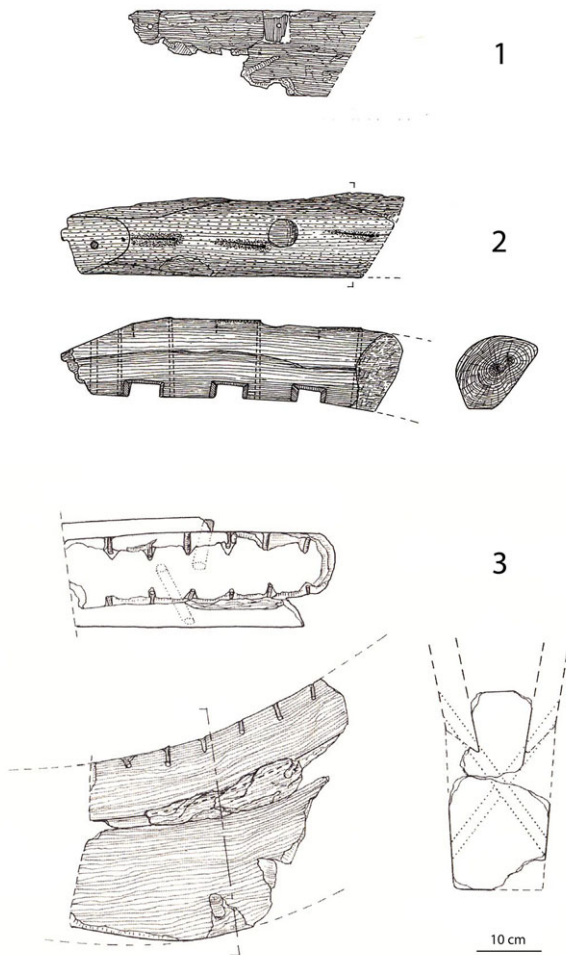

Figure 29. Grand-Ribaud F: elements of the hull remains: 1—planking; 2—frame; 3—sternpost (drawing M. Rival, AMU, CNRS, CCJ, from Long *et al.*, 2006).

### The Greek tradition: development phase

A second phase, called the ‘development phase’ (Pomey, 2010, 2012), within the Greek tradition is attested from the mid 5th century BC to the end of this century by two wrecks.

#### *Gela 2 (Fig. 20.43) and Ma’agan Mikhael wrecks (Fig. 20.44)*

The Gela 2 was found in Sicily in 1995 near the Gela 1. The shipwreck is dated from c.450–425 BC, and its origin, like Gela 1, is, according to the artefacts found with it, very likely Greek from Magna Grecia (Southern Italy) or the Aegean (Panvini, 2001: 79–95; Benini, 2001) (Fig. 31).

The Ma’agan Mikhael, found in 1985 off the Israeli coast south of Haifa, corresponds to a 13.80m-long boat. It is dated about 400 BC and was probably built on the Ionian coast according to the origin of the wood used (Linder and Kahanov, 2003, 2004) (Fig. 32).

Nevertheless, wherever these ships were constructed, which remains largely hypothetical or unknown, their characteristics allow them to be included in the family of Greek sewn boats, even if the use of the ligatures becomes increasingly limited.

In both cases, the use of mortise-and-tenon joints to assemble the hull has increased importance. The tenons are shorter and wider and the space between them is closer than seen during the Archaic period. Sewing is residual and limited to the bow and stern knees at the ends (Ma’agan Mikhael) and for repairs (Gela 2). On Ma’agan Mikhael, the keel hook scarfs with a vertical key and the floor-timber–futtock hook scarfs are similar to those of Jules-Verne 7 and 9. The mast-step timber is similar to that of Gela 1. A mixed coating (esparto, wax, and pine resin) has been observed on the planking.

Several features, such as the keel hook scarf and the mixed coating, the general characteristics of the framing pattern and the use of a sewing technique with tetrahedral recesses (but without pre-assembly dowels) link these two wrecks to the former group, but they also present major changes:

- the hull shape has developed and for the first time has a ‘wine-glass’ transversal section. On Ma’agan Mikhael, where the keel is preserved, the rabbets are still limited to the ends;
- the frames are nailed to the planking with clenched nails (copper nails in Ma’agan Mikhael);
- morphologically, the floor-timbers on *Gela 2* are similar to the former group with a trapezoidal cross section and a crenellated base, while on Ma’agan Mikhael, a little later, the frames are squarer with less slanted sides and their base is smooth with only central limber holes.

For the same period, it has been suggested, as a hypothesis, that the Tetktaş Burnu shipwreck (Fig. 1, K; 440–425 BC), was of the Jules-Verne 7 or Ma’agan Mikhael type based on a detailed study of the nails recovered and despite the lack of wood remains (Van Duivenvoorde, 2014).

### The Greek tradition: final developments

For the very end of the 4th and beginning of the 3rd century BC, the Kyrenia is the only Greek wreck that has been sufficiently excavated for its general characteristics to be understood. Other wrecks dating to the end of the 5th and 4th centuries BC have been discovered, such as Porticello (Fig. 1, D; Eiseman and Ridgway, 1987), Alonessos (Fig. 1, J; Hadjidaki, 1996) or Mazotos (Fig. 1, N; Demesticha, 2011), but they are too fragmentary, or not fully excavated, or still in the course of being studied to be sure of their assembly systems (with or without partial sewn assembly), to be able to fully classify them. With no earlier examples of recognizably Greek boats with full mortise-and-tenon assembly systems for the planking,

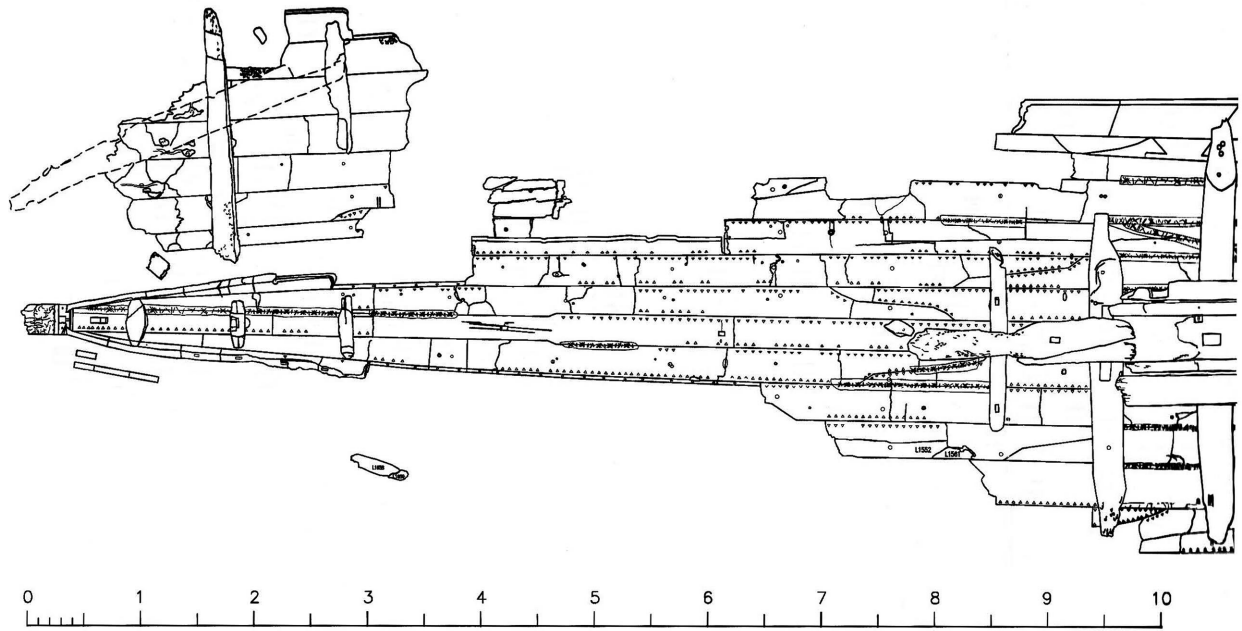

Figure 30. Gela 1: detail of the aft part of the plan of the hull remains with sewing and mortise-and-tenon joint (from Benini, 2012).

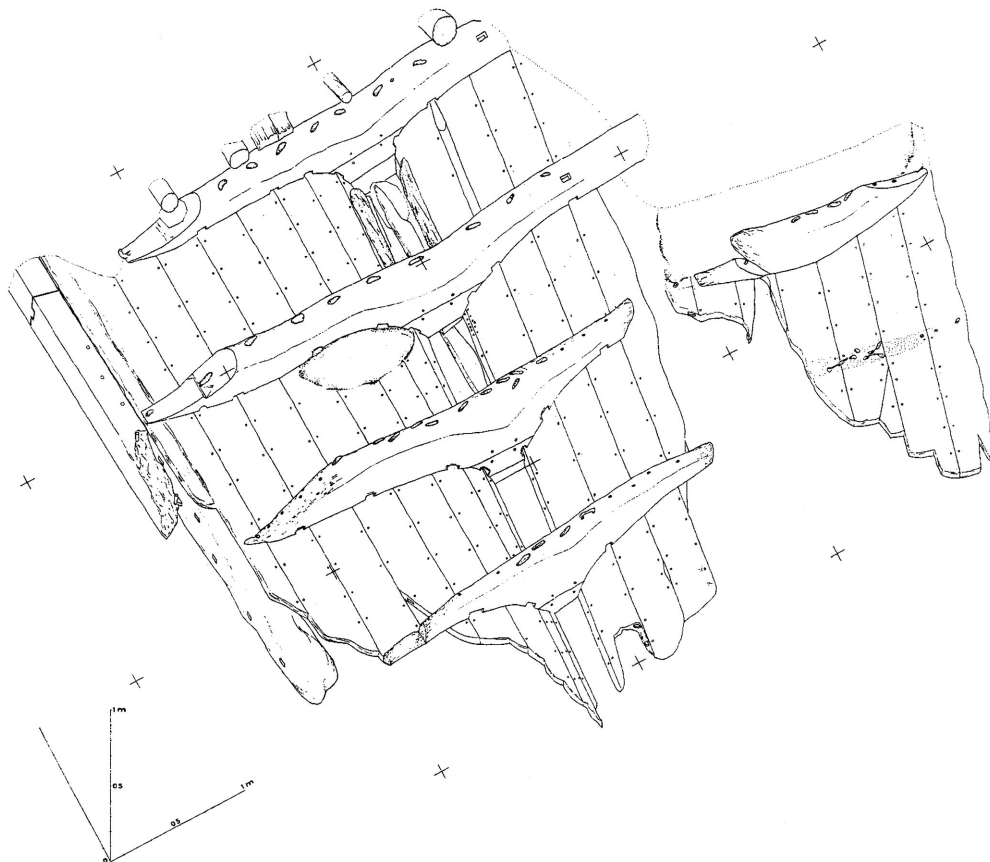

Figure 31. Gela 2: plan of the hull remains (from Benini, 2001).

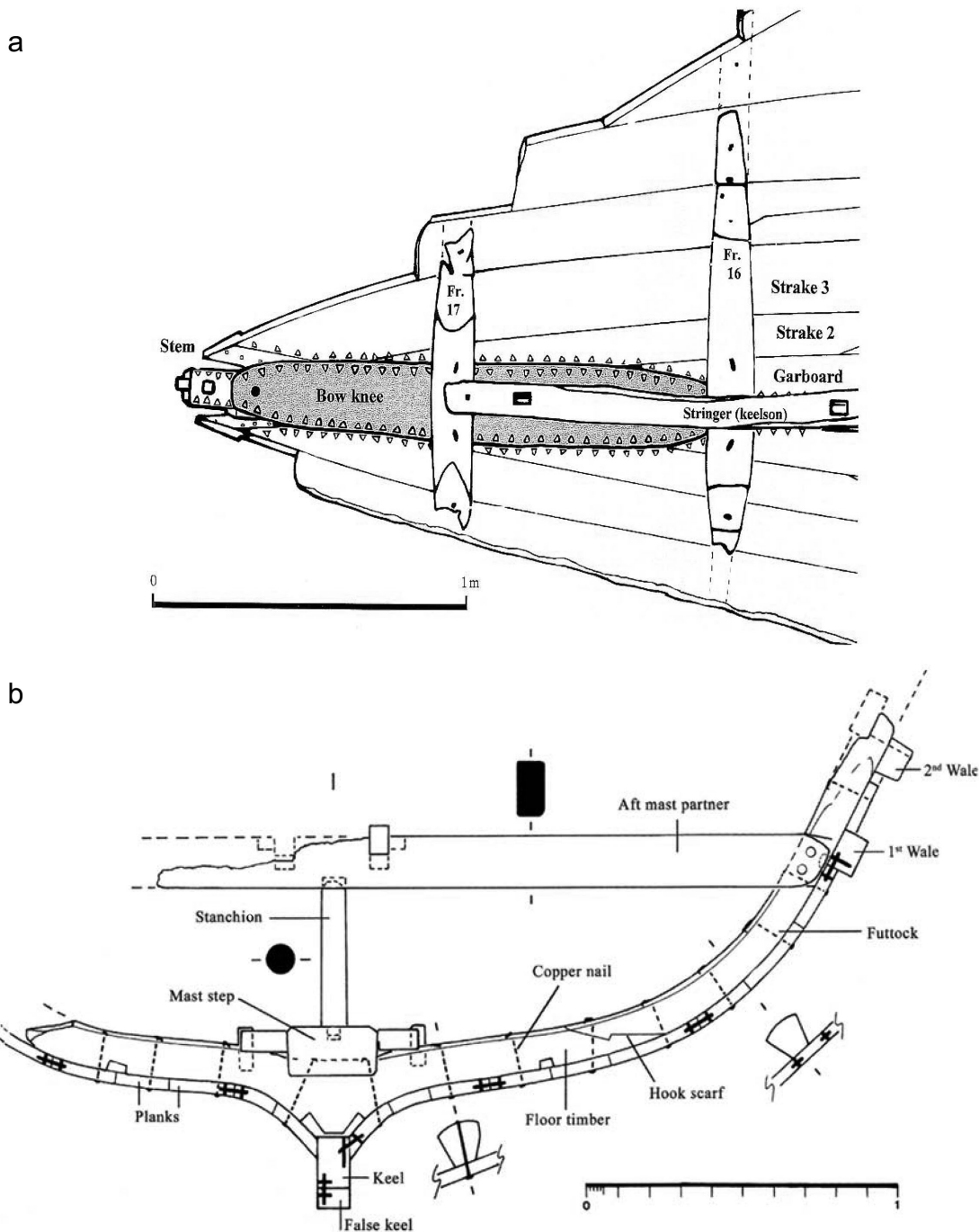

Figure 32. Ma'agan Mikhael shipwreck: top view of the sewing on the bow knee; transversal main section of the hull (from Linder and Kahanov, 2003).

we suggest that the Kyrenia vessel stems from the Greek sewn-boat tradition, and represents the final developmental phase. This final phase includes the total replacement of ligatures by mortise-and-tenon joints in the construction process of the traditional Greek shipyards, originally building sewn boats. Indeed, the reuse of a plank originally from a sewn boat for the ceiling of Kyrenia proves a certain proximity and

familiarity with the Greek sewn-boat tradition (Steffy, 1985: 95 and III. 17).

**Kyrenia (Fig. 20.45)**

Found in 1965 off Kyrenia, on the northern coast of Cyprus, the wreck, loaded with a cargo carried in mainly Rhodian amphoras, was fully excavated in 1968–1969 (Wylde Swiny and Katzev, 1973). The hull,



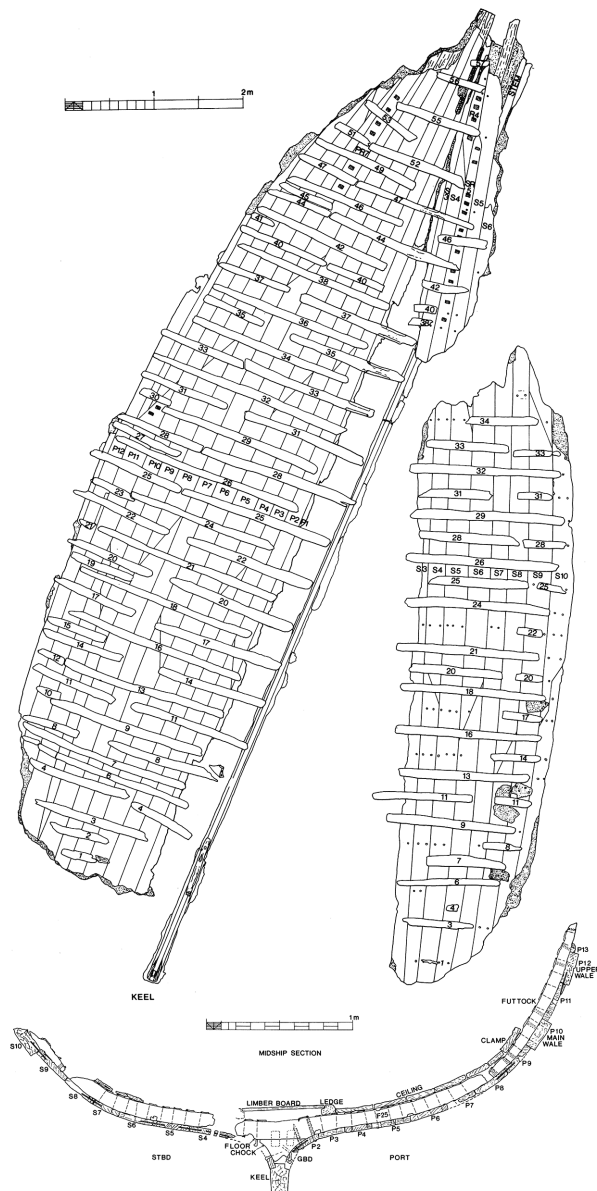

Figure 33. Kyrenia shipwreck: general plan and main cross section of the hull (from Steffy, 1994: figs 3–23, 3–31).

14m long, was recovered and is now displayed at the Kyrenia Castle Museum (Womer Katzev, 2005). The affiliation of the Kyrenia ship to the family of Greek sewn boats tradition is not evident and can be established only through comparison with the former developmental phase and especially with the Ma'agan Mikhael wreck, with which it has several features in common (Kahanov, 1998; Kahanov and Pomey, 2004).

In the light of this heritage the main architectural characteristics of the Kyrenia ship are (Steffy, 1985, 1994: 42–59) (Fig. 33):

- a 'wine-glass' cross section, as seen in the previous group;

- a fully rabbeted keel with a keyed hook scarf with horizontal instead of vertical wedges;
- a bow knee (attested for the first time on Ma'agan Mikhael);
- planking fully assembled with mortise-and-tenon joints; reuse of a sewn plank as ceiling;
- a frame pattern consisting of floor-timbers alternating with half-frames; this system is probably the development of the previous system in which floor-timbers alternate with top-timbers; considering the relationship of continuity that exists between the different phases of development within the family of Greek sewn boats, one can indeed hypothesize that the half-frames are derived by extending top-timbers toward the keel;
- the futtocks are independent, not fastened to the floor-timbers;
- the frames have a rectangular section; the trapezoidal section no longer being necessary as frames are fixed to the planking with clenched copper nails through softwood treenails, and are no longer lashed; the strong conservatism in shipbuilding explains the slow changes identified in frame shape following the abandonment of lashed frames;
- the mast-step timber fitted over the floor-timbers is similar in its design and function to that found on the Ma'agan Mikhael wreck.

### The Greek tradition: a survival

At the start of the 3rd century BC, contemporary to or slightly later than the Kyrenia wreck, the Ereğli E wreck, recently discovered in the Black Sea (Brennan *et al.*, 2013; Davis *et al.*, 2018) shows that the Greek tradition of sewn boats did not suddenly vanish with the final developments evidenced by the Kyrenia wreck.

#### Ereğli E wreck (Fig. 20.46)

Discovered in 2011 at a depth of 101m off the coast of Ereğli (*Heraclea Pontica*) in the Black Sea, the wreck appears similar in dimensions to Kyrenia. It has a cargo of amphoras composed of many types from Pontic and Aegean production centres, which date the wrecking to 300–270 BC. Given its depth, the wreck was submitted in 2011–2012 to a remote *in situ* investigation, allowing the careful observation of several elements of the hull of the ship. The examination of the visible parts of the planking, corresponding to the upper edges of the buried hull, suggest that it was assembled using pegged mortise-and-tenon joints associated with robust frames, the fastening system for which remains unknown. Other fragments, unfortunately corresponding to loose timbers, present characteristic features of the Greek sewing system with tetrahedral recesses and cylindrical dowels. The position of these timbers on the surface of the site suggests that they could belong to the extremities and the upper part of the hull. Alternatively, these sewn planks could have been the result of repairs, or the planks could be old timbers embarked for reuse.

Only a further investigation of the wreck may be able to clarify the role of these ligatures in relation to the construction of the ship.

Where the ship was built remains unknown but, based on the cargo, it belongs to the Greek cultural sphere (Davis *et al.*, 2018: 73) and could have been built in eastern Greece or on the Black Sea. In either case, this wreck proves that both techniques were still in use at the beginning of the 3rd century BC and could have been used concurrently in Greek shipyards. It provides evidence of the survival of the sewn technique in the Greek tradition of shipbuilding after mortise-and-tenon joint construction was adopted. This is unsurprising given the conservative nature of shipbuilding at all times and the many associated examples of survival, as this study has shown. It remains to determine if this longevity is a local phenomenon, which could be linked, for example, to the maintenance of old traditions in some Black Sea shipyards, or a more widespread occurrence. In the latter case, this would indicate that the technical transition from assembly by ligatures to mortise-and-tenons was more complex than one might think (Pomey, 2010). Again, this is not surprising given the complexity of technical transitions in ancient shipbuilding, as demonstrated by the move at the end of antiquity from shell to skeleton construction (Pomey *et al.*, 2012).

### Discussion

If the Kyrenia ship can be considered to reflect the culmination of a long development in the Greek sewn-boat tradition, the systematic use of mortise-and-tenon joints implies not only the adoption by the traditional Greek shipyard of a new system of assembly but also a new system of construction. The implications and consequences of the use of mortise-and-tenon joints are so great in the conception and process of construction that Steffy (1995: 419) proposed calling ships built in this way ‘tenon built’. So, from the point of view of the traditional Greek shipyards, the Kyrenia ship can be considered not only as the final step in a long development in the sewn-boat tradition, but also as the beginning of a new tradition of shipbuilding. Due to the consistency and coherence of this new system of construction, it was adopted by Greek shipbuilders from the end of the Classical period and the beginning of the Hellenistic period. It was also adopted in Roman shipyards and in all Mediterranean shipbuilding and used until the transition toward skeleton construction at the end of antiquity (Steffy, 1994; Pomey *et al.*, 2012). A similar system was also in use in the mid 3rd century BC within the Punic tradition of shipbuilding, as evidenced by the Marsala wreck (Frost, 1976). In all cases, the system appears to be particularly elaborate and seems to be the result of a long process of development.

Due to its Punic origin, the vessel of Marsala is also most likely the result of the long development of the construction system by mortise-and-tenon joints

but in a Punico-Phoenician tradition. Indeed, the first evidence of this assembly system, provided by the Uluburun shipwreck at the end of the 14th century BC, suggests an origin on the Levantine coast in a Canaanite or proto-Phoenician context (see above). However, in the absence of sufficient evidence for the period between the wrecks of Uluburun and Marsala—with the exception of the Mazarrón wrecks assembled with mortise-and-tenon joints, but in a different geographical and cultural context—the different stages of this development, both in terms of the assembly system and structure, totally escape us at present. In the Greek context, we are able to follow the development of the mortise-and-tenon system of construction through the tradition of construction of sewn boats evidenced by the 12 wrecks discussed, in the absence of other Greek shipbuilding traditions known to date. This developmental process, which led to a phenomenon of convergence with the Punico-Phoenician tradition, lasted at least two centuries, from the second half of the 6th century BC, date of its adoption, to the second half of the 4th century BC, date of its final development.

The benefits of a mortise-and-tenon system compared with assembly by ligatures are well known (Pomey, 2011b). Tenons, generally made of hard wood, are much stronger and much more durable than vegetal ligatures, and the tenons together constitute a network inside the planking, like internal framing, which reinforces the hull (Steffy, 1995: 421). The result is that mortise-and-tenon joints allow stronger and larger ships and more elaborate hull shapes to be built than those assembled with ligatures. Shipyards working in the Greek tradition that previously produced sewn assemblies developed new ship types with more elaborate hull shapes, as evidenced by the move from ships with round bottom sections to wine-glass sections. This enabled larger ships to be built with increased tonnage, in line with an expansion in maritime trade, which were more efficient, safer, and of greater longevity. First the development of the Greek trireme during the 6th century BC, then the development of super galleys and super freighters during the Hellenistic period, are a direct consequence of the use of mortise-and-tenon joints and its adoption in traditional Greek shipyards.

If we understand the reasons why mortise-and-tenon assembly was adopted, we have also to explore the process of its adoption by Greek shipbuilders, who traditionally worked using sewn-boat techniques. The discussion is still open (Pomey, 2010) and two different hypotheses can be proposed. The first considers that the mortise-and-tenon joint was adopted by the Greek shipbuilders as a result of Punico-Phoenician influences (Pomey, 1997; Kahanov and Pomey, 2004; Pomey *et al.*, 2012: 295); the second, suggests a slow development within the Greek sewn-boat tradition through an intermediate stage in which pre-assembly dowels were substituted by unpegged tenons (Polzer, 2010, 2011).

On the Pabuç Burnu and Cala Sant Vicenç wrecks, both cylindrical dowels and rectangular unpegged tenons are noted, used like coaks and apparently with the same function, to guide and hold in place the planks, prior to sewing. The use of ‘tenon-coaks’ was considered a first step in the gradual development of the traditional sewn process, foreshadowing the use of pegged tenons (Polzer, 2010, 2011). However, tenons and dowels are used simultaneously in mixed pre-assembly systems. Moreover, when pegged tenons are used in the Greek tradition, dowels continue to be used in preference to tenons for sewn parts of the ship (Jules-Verne 7, Villeneuve-Bargemon, Grand-Ribaud F). Significantly, on the Gela I wreck, the pegged tenons alternate with dowels. On the Ereğli E wreck-site, dowels were observed with sewing at the beginning of the 3rd century BC, at a time when mortise-and-tenon joints were dominant. In fact, we have no clear evidence that unpegged tenons (‘tenon-coaks’) fully replaced dowels in the preliminary developmental stage. Unpegged tenons seem to have been a variant, rather than a substitute for dowels and do not represent a formal step in the development. Unpegged tenons are found both in Aegean (Pabuç Burnu) and Massalian (Cala Sant Vicenç) contexts, and in each case, they are associated with repairs, and can hardly be interpreted as a regional characteristic in the mainstream of the development. If they have played a role in the developmental process, this role is not evident.

Alternatively, the very long period in which mortise-and-tenon joints were used in the Punico-Phoenician tradition may have been a direct influence, providing a decisive impulse for their adoption within the Greek tradition, especially in the particular context of Western Greek colonization and direct contact and confrontation between Greeks and Carthaginians (Pomey, 1997, Kahanov and Pomey, 2004; Pomey *et al.*, 2012: 295). In fact, the hypothesis of a Punico-Phoenician influence is a similar, but not identical, developmental model to that suggested for the Ibero-punic tradition.

### North-West Mediterranean tradition

Despite the dominant use of mortise-and-tenon fasteners in Mediterranean shipbuilding from the end of the 4th century BC, the practice of sewing survived in several circumstances: for example, a strong tradition of sewing continued in specific areas such as the Adriatic, as we have seen. There is also some evidence of the survival of sewing techniques, employed alongside traditional mortise-and-tenon shipbuilding. One example is the Pisa C shipwreck (Fig. 1, B; Pisa, Italy, 1st century AD), a little rowing and sailing boat (11.70m long × 2.80m) in very good state of preservation, where a small sewn repair has been observed on the planking (Camilli, 2002: fig. 7). The structure is of a classical type for the period, and the planking is assembled by mortise-and-tenon

joints; however, no precise architectural study of the hull is available, and details of the sewing used for the ‘fishbone shaped’ repair are not known (Bruni, 2000: 47–48; Camilli, 2002).

More significant is the tradition of frames with internal lashing, which has been observed on many shipwrecks from the northern part of the western Mediterranean. This specific technique, associated with mortise-and-tenon planking fasteners, constitutes a specific technical tradition that can be called the ‘north-western Mediterranean tradition’ according to the geographical distribution of the wrecks (Figs 1 and 34).

### *Cap Béar 3 (Fig. 34.47)*

A system of frames with internal lashings was precisely recorded for the first time during excavation of the Cap Béar 3 wreck in 1985–1986, found lying off the French coast between Port-Vendres and the Spanish border (Pomey, 1987–1988: 2–3). The wreck, dated from the third quarter of the 1st century BC (Liou and Pomey, 1985: 551) is an exemplar of the tradition.

From an architectural point of view, the hull structure of this little boat is characteristic of the Hellenistic or Republican period with a keel, a single layer of planking, and framing made of floor-timbers alternating with half-frames. A mast-step timber is fitted on the floor-timbers, and stringers and ceiling planks complete the internal structure. The planking is fully assembled by classic mortise-and-tenon joints, but the framing, floor-timbers and half-frames, are joined to the planking with single treenails alternating with internal lashings (Fig. 35a). The lashings are made of a vegetal braid that passes through two channels drilled vertically through the frames and the planking. The stitching is locked in the channels by long wooden pegs. Grooves connect the exits of the channels on the inboard surface of the frames, and on the outer surface of the planking, in order to prevent the ligatures protruding, and so protect them from wear. Finally, a coat of pitch fills up the grooves. The alternation of internal lashings and treenails is very regular and presents a pattern of staggered rows from one frame to the next (Fig. 35b).

We can note that this double assembly system has the advantage of locking the frame in position in all directions, horizontally as well as vertically, as shown by Sabrina Marlier (2005: 529–530; 2006). This system of lashing frames in place has been observed on shipwrecks dated between the middle of the 3rd century BC and the middle of the 2nd century AD (Pomey, 2002a; Marlier, 2005; Wicha, 2005) and located on the northern arc of the western Mediterranean from Catalonia to Liguria.

Two architectural families of boats are found within this tradition. The first concerns small coastal boats with a keel and a more-or-less sharp bottom. In addition to the Cap Béar 3 shipwreck, this group includes the following wrecks:



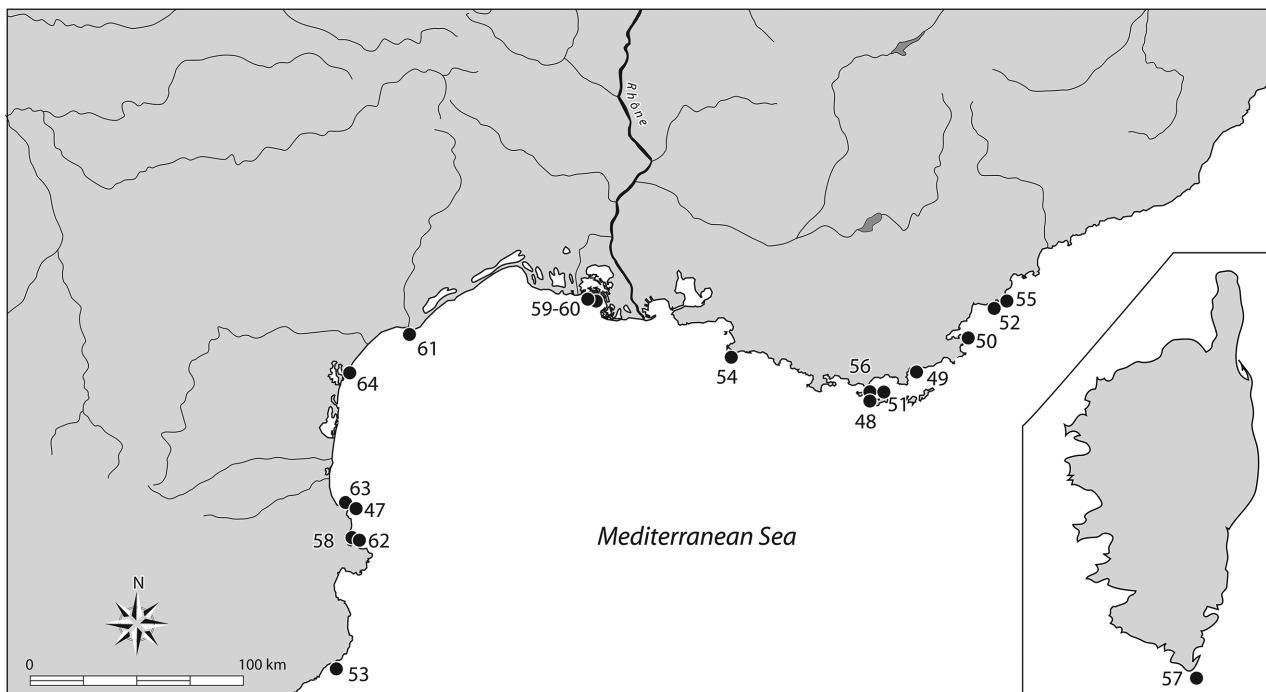

Figure 34. The north-western Mediterranean tradition: 47) Cap Béar 3; 48) La Tour-Fondue; 49) Cavalière; 50) La Roche-Fouras; 51) Mèdes 6; 52) Dramont C; 53) Palamos; 54) Plane 1; 55) Barthélemy B; 56) Jaume-Garde B; 57) Perduto 1; 58) Cap del Vol; 59) Saintes-Maries 2; 60) Saintes-Maries 24; 61) Baie de l’Amitié; 62) Cala Cativa 1; 63) Port-Vendres 3; 64) Port La Nautique (drawing V. Dumas, G. Boetto, P. Pomey, AMU, CNRS, CCJ).

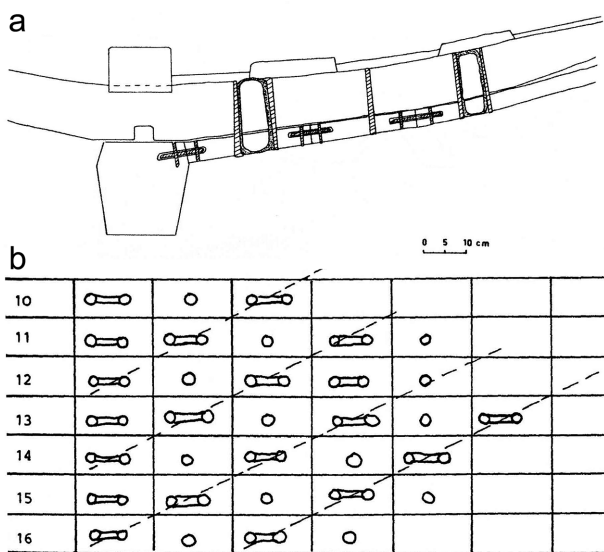

Figure 35. Cap Béar 3: a) cross section of the hull remains (drawing D. Colls, from Liou and Pomey, 1985); b) schema of the frame assembly system (drawing D. Colls, from excavation report 1986).

**La Tour-Fondue wreck (Fig. 34.48)**

Found at the tip of the Presqu’île de Giens (Hyères, France), the wreck was excavated 1994–1997. It is dated to the 2nd half of the 3rd century BC by its cargo,

which was composed of amphoras from Marseilles, Greco-Italic amphora, and Massalian ceramics *à pâte claire* (Dangréaux, 1997; 2001; Dangréaux *et al.*, 2012). The preserved ship remains were 4.45m long, from the central part of the boat including the keel, a dozen planking strakes assembled with mortise-and-tenon joints, and eight frames, alternating floor-timbers and half-frames, joined to the planking with internal lashings (Fig. 36).

**Cavalière (Figs 34.49)**

The wreck lies in 43m of water in the cove of Cavalière (Le Lavandou, France), and was excavated 1974–1977 (Charlin *et al.*, 1998). The remains are 13m long and 3m wide, interpreted as a small cargo vessel loaded with amphoras, a variety of ceramics from the western Mediterranean, and quarters of pork. Coins found came from Numidia, Spain, and Marseilles. The assemblage allowed the wreck to be dated to about 100 BC and suggest that the boat was a coastal cargo vessel, tramping all around the western Mediterranean. The ship remains were well preserved consisting of a keel with the base of the endposts, the sternpost was doubled by a skeg, about 20 hull planking strakes were assembled with mortise-and-tenon joints, and about 40 frames alternating floor-timbers and half-timbers and a mast-step timber were recorded. The frames were joined to the planking using internal lashings (Fig. 37), but, due to a waterproofing coating that covered the joints

and rendered the details difficult to see, this was noted only in 1995 when the site was re-opened to enable a dendrochronological study of the wreck (Pomey, 1996). Analysis of the wood showed the particularly homogenous use of Bosnian pine (*Pinus Leucodermis*) for the hull components (keel, planking, frames, mast-step, and ceiling). This species has a limited distribution in the south of Italy (Campania and Calabria) and in the Balkan areas of the Illyrian coast and Bosnia as its name implies (Guibal and Pomey, 2003: 38; Wicha and Girard, 2006). It is therefore possible, even probable, that the ship was constructed in these regions.

**La Roche-Fouras (Fig. 34.50) and Mèdes 6 (Fig. 34.51)**

The first wreck was found near to Cap Camarat (Saint-Tropez, France; Joncheray, 1976b; Joncheray and

Rochier, 1976) and the second between the Presqu'île de Giens and the island of Porquerolles (Hyères, France; Sabastia and Formentin, 2016, 2017). Both are dated to the end of the 2nd and beginning of the 1st century BC according to the Italic Dressel 1C amphoras found on the site. The remains of the hull measure 6 × 2m for La Roche-Fouras and 4.50 × 2.50m for Mèdes 6, and both consist of keels, strakes of hull planking assembled with mortise-and-tenon joints and framing timbers, consisting of alternating floor-timbers and half-timbers, joined to the planking with internal lashings. On the Roche-Fouras wreck, the lashing system was not recorded until 1995 when the site was re-opened to take wood samples (Pomey, 1996). According to the hull remains and the cargoes, both wrecks represent small coastal traders each about 10m long.

**Dramont C (Fig. 34.52)**

The wreck was found near to Cap Dramont (Saint-Raphaël, France; Joncheray, 1994) and is dated to the end of the 2nd or first half of the 1st century BC by the onboard objects and cargo carried in Dressel 1B amphoras. The cargo also included iron ingots and a consignment of resin. The wreck was excavated over an area measuring 6 × 1.60m, which included the keel, seven strakes of planking assembled with mortise-and-tenon joints, and 28 frame-timbers attached to the planking with internal lashings. The lashing system was observed only in 1998 as above (Pomey and Guibal, 2003). The assemblage indicates a coastal trader estimated at 12–14m long.

**Palamós (Fig. 34.53)**

The wreck is situated near to the isle of Formigues (Girona, Catalonia) (Foerster *et al.*, 1987; Foerster, 1988) and is dated to the first half of the 1st century

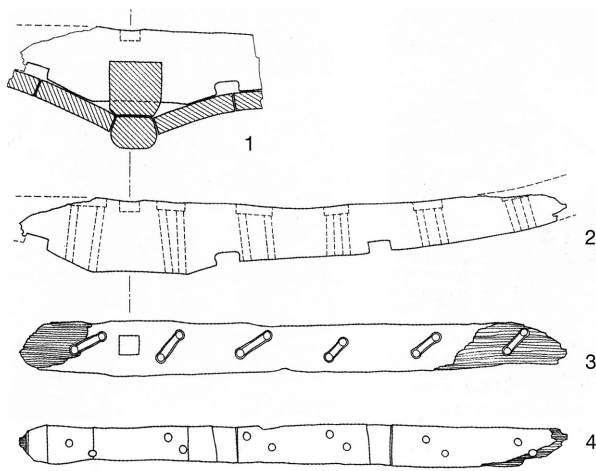

Figure 36. La Tour-Fondue shipwreck: 1. Detail of the cross section with the keel; 2. Floor-timber V3, profil view; 3. V3 top view; 4. V3 bottom view (from Dangréaux *et al.*, 2012).

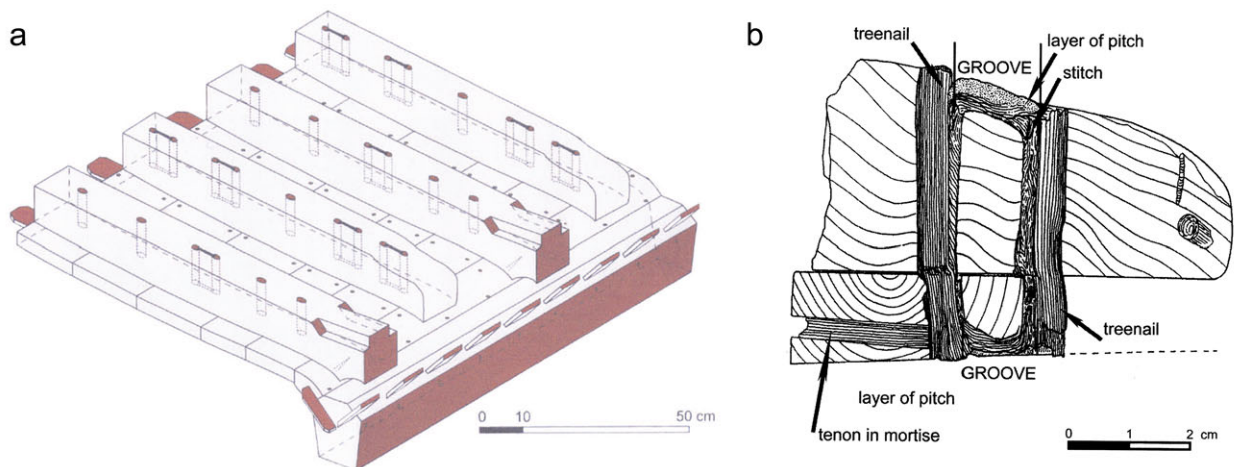

Figure 37. Cavalière shipwreck: a) axonometric illustration of the frame assembly system by internal lashing and treenails (drawing S. Marlier, from Marlier, 2005); b) detail of the the frame assembly system by internal lashing (drawing M. Rival, from Marlier, 2006: fig. 7.3).

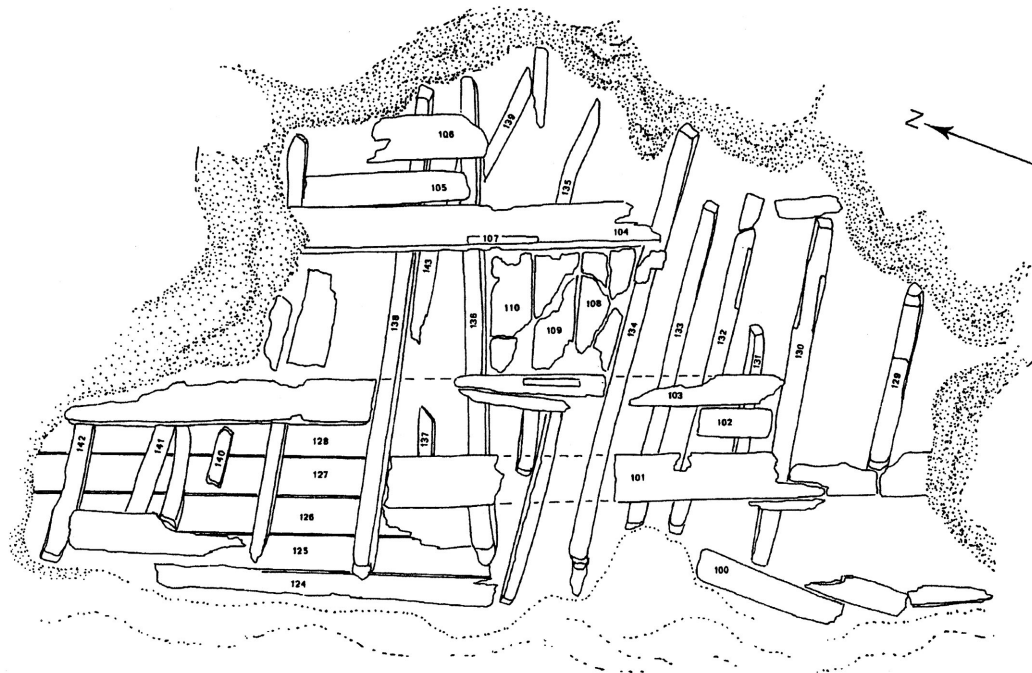

Figure 38. Plane 1: general plan in the centre part. Note the disturbance of the frames in the axial part due to the ripping out of the keel (drawing M. Rival, from Pomey, 2002b).

BC by its cargo carried in Léetanian amphoras. The remains of the hull include a keel, with a preserved length of 12m, the base of the sternpost, and one side of the hull with its frames (floor-timbers and half-timbers) 1.5m wide. The planking is assembled using mortise-and-tenon joints and the frames are attached to the planking using an alternating system of single then double treenails. Only when the ship was re-examined were the double treenail holes seen to house internal lashings also (De Juan, 2013: 238–242).

#### Plane 1 (Fig. 34.54)

Found in the Marseilleveyre archipelago at the entrance of the Bay of Marseilles, the wreck is dated to the middle of the 1st century BC by the presence of Dressel 1B amphoras and pre-Aretine ceramics (Liou and Pomey, 1985: 556–559). The hull was partially recorded over an area  $4.50 \times 3$  m during the dendrochronological study of 1992 (Pomey, 2002b: 12–14). The remains include a mast-step timber, ceiling, planking assembled with mortise-and-tenon joints, and frames alternating floor-timbers and half-floors attached to the planking with internal lashings. It should be noted that the keel and garboards are missing, possibly lost during the sinking.

A lucky coin, an Iberic *As* from Cese-Tarragona, was found in the mast-step (Liou and Pomey, 1985: 556), which suggests a possible Catalonian origin for the boat. However, it sunk off Marseilles, with a cargo from central Italy, indicating it was sailing a route

in the northern part of the western Mediterranean (Fig. 38).

#### Barthélemy B (Fig. 34.55)

Found near Barthélemy Islet, east of Cap Dramont (Saint-Raphaël, France; Joncheray and Joncheray, 2004; Wicha, 2004), this little vessel, loaded with tiles, is dated to the second quarter of the 1st century AD. The hull was preserved over an area of  $5.20 \times 2$  m, and includes a keel, the base of the sternpost and one side assembled with mortise-and-tenon joints and framing consisting of alternating floor-timbers and half-frames. The frames are attached to the planking with internal lashings. This little vessel, 8–10m long, carrying locally produced tiles, used for transport over short-distances, was very probably built locally.

#### Discussion

All of these vessels have the planking assembled with mortise-and-tenon joints and the frames attached to the planking with internal lashings made of a vegetal braid passing through vertical channels drilled through the frames and the planking. Long treenails lock the braid in the channels. Grooves, filled up with pitch, connect the exits of the vertical channels on the inboard face of the frames, and on the outboard surface of the planking, to allow the passage and the protection of the ligatures. On Mèdes 6 these grooves were only seen on the frames. In general, single treenails alternate with



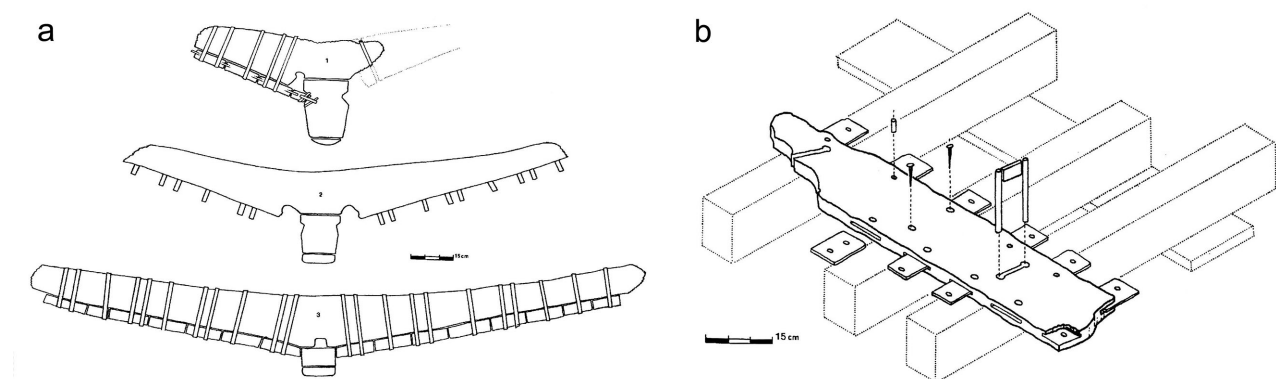

Figure 39. Cap del Vol shipwreck: a) cross section of the hull remains (from Nieto and Foerster, 1980); b) detail of the frame assembly system (from Nieto and Foerster, 1980).

the ligatures, but this pattern is not always regular (for example: Cavalière, Mèdes 6, Barthélemy B).

The Jeaume-Garde B wreck can be added to this group, as it has major repairs to the framing attached using internal lashings.

#### **Jeaume-Garde B (Fig. 34.56)**

Found in Langoustier bay off Porquerolles Island (Hyères, France; Carrazé, 1977; Pomey, 1994), the wreck is dated to the end of the 2nd or beginning of the 2nd century BC by the finds (Greco-Italic amphoras and Campanian wares). A 5m length of the hull fragment was uncovered when the site was re-opened in 1993 for the dendrochronology study (Pomey, 1994). It is part of the side of the vessel with the frames in place. The planking is assembled using mortise-and-tenon joints and the frames are fastened to the planking using clenched nails through treenails. However, two frames are replacements and are attached using lashings using the same system as the wrecks mentioned above. This contradicts the original reconstruction of the ship that suggested the lashings were made using a continuous braided cord (Carrazé, 1977). The lashings alternate with single treenails in a regular pattern. This vessel had evidently undergone repair in a shipyard that practised the internal lashings technique.

The second group concerns fluvio-maritime ships of the same period, characterized by a flat keel and/or a flat bottom. This group include the following wrecks:

#### **Perduto 1 (Fig. 34.57)**

This wreck was found at the entrance of the strait of Bonifacio (Corsica, France), and is dated from the 1st century BC to the 1st century AD by the presence of Dressel 2/4 amphoras from Tarraconensis in the region of Barcelona (Bernard, 2007–2008). Only a small part of the hull was found, 3 × 1m, including the flat bottom and flat keel, one side fastened with mortise-and-tenon joints and several fragments of frames. The frames were

fastened with internal lashings evidenced by regular pairs of treenails used to lock the cords.

#### **Cap del Vol (Fig. 34.58)**

The wreck lies at Cap del Vol near to Cap Creus (Catalonia; Nieto and Foerster, 1980; Pomey, 2002; Vivar *et al.*, 2014) and is dated to the beginning of the 1st century AD by the ceramics and Pascual 1 Spanish amphoras found. The remains were studied over 8.50 × 6m, and include the aft part of the boat with the keel and sternpost, the planking fastened by mortise-and-tenon joints, and a dozen frames made up of floor-timbers regularly alternating with half-frames, and a mast-step timber. The keel is relatively flat with a height of only 60mm for a width of 120mm. The frames are fastened using single treenails or nails more-or-less regularly alternated with pairs of treenails joined by grooves filled with pitch visible on the inboard face of the frames and outboard face of the planks. This pattern clearly indicates the use of internal lashings, which was confirmed when the wreck was re-examined in 2011–2012 (De Juan, 2013: 306–323; Vivar *et al.*, 2014). The structural characteristics of these timbers, particularly its flat keel and bottom, with a reconstructed length of 18–20m, belong to a fluvio-maritime vessel adapted to navigating the coasts of Catalonia and the Narbonne region as suggested by the cargo (Fig. 39).

#### **Saintes-Maries-de-la-Mer 2 (Fig. 34.59) and Saintes-Maries-de-la-Mer 24 (Fig. 34.60)**

These two wrecks were found close to each other in the mouth of the Rhône River in the Camargue (Arles, France). Both vessels carried cargoes of iron bars and ingots from the Montagne Noire, north-west of Narbonne, where it had probably been loaded on board (Long *et al.*, 2009: 284). SM2 is dated to the first quarter of the 1st century AD and SM24 is dated to around the middle of the 1st century AD (Long *et al.*, 2009). SM2 is highly concreted and only a small part of the hull has been studied in the laboratory, enabling

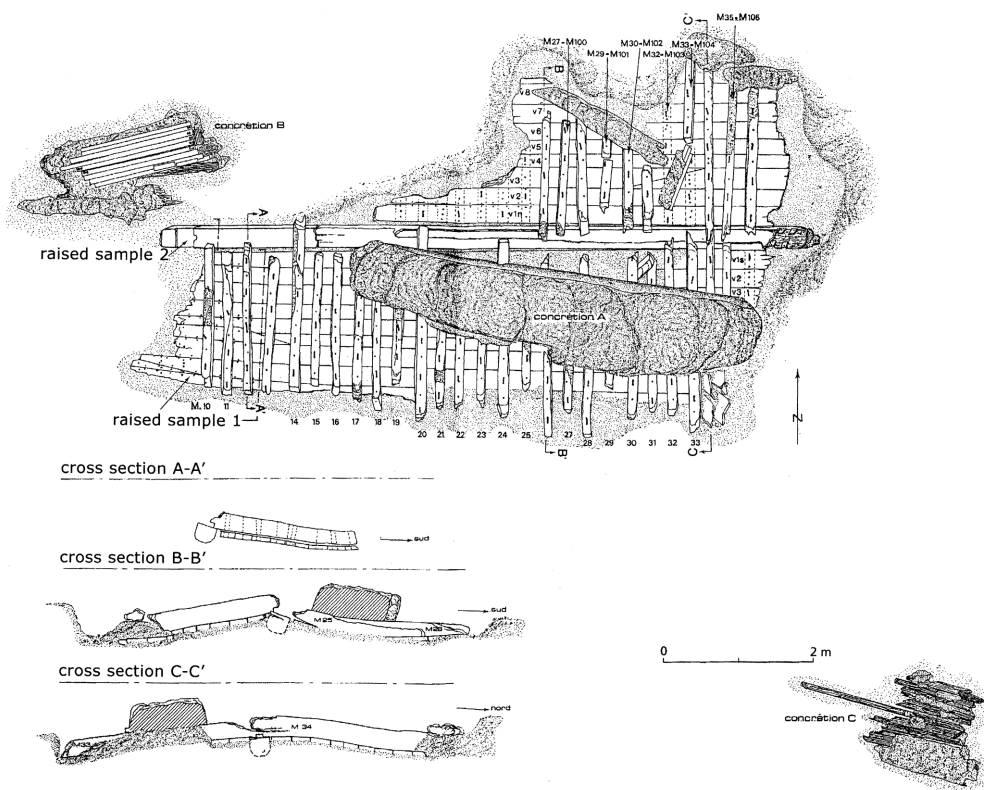

Figure 40. Saintes-Maries-de-la-Mer 24: general plan and cross sections (from Long *et al.*, 2009: fig. 3).

the flat bottom and the fastening system of the frames to be recorded. In contrast, SM24 is better preserved and an area of the hull  $10.2 \times 5\text{m}$  has been studied (Fig. 40). The boat has a keel plank that is wider than it is deep, a flat bottom, 12 planking strakes assembled with mortise-and-tenon joints, and 26 frames made up of floor-timbers and half-frames in no regular pattern. Both wrecks have the frames fastened to the planking using internal lashings. The characteristics of these two boats with their estimated dimensions, 15–18m long for SM2 and 20–25m for SM24, indicate fluvio-maritime vessels suited to navigating the lagoonal coasts of Languedoc and the Rhône delta, which matches both the provenance of the cargo and the site of the wrecks (Fig. 40).

#### **Baie de l'Amitié (Fig. 34.61)**

Found near to Cap d'Agde (Agde, France; Wicha, 2002), the wreck is dated to the second half of the 1st century AD by its cargo of olive oil contained in Dressel 20 amphoras. As well as the amphoras, the ship carried a cargo of lead ingots and Gaulish *terra sigillata*. The hull was preserved over  $9 \times 4.5\text{m}$ , including a flat bottom with a keel plank and the base of the stem, 15 planks, 25 frames with alternating floor-timbers and half-frames, and a stringer. The planking is assembled using mortise-and-tenon joints and the frames are fastened to the planking with internal lashings.

The characteristics of the hull and cargo indicate a fluvio-maritime vessel, estimated at a length of 20m, that navigated the coasts around Narbonne and Catalonia (Fig. 41).

#### **Cala Cativa 1 (Fig. 34.62)**

This wreck was found at Cap del Vol, Cap Creus (Catalonia), it dates to the first half of the 1st century BC. This small boat, *c.* 7m long, with a flat bottom and a flat keel, is very similar to the Cap del Vol wreck, although smaller. It also has internally lashed frames (Gustau Vivar, pers. comm.).

Lastly, according to Foerster Laures (1988), the Los Ullastres wreck (Catalonia, end of the 1st BC–beginning of the 1st century AD; Fig. 1, A) is of the same type and construction as the Cap del Vol and Perduto 1 wrecks, and therefore belongs to the same tradition. However, the means of fastening the frames has not yet been observed directly.

#### **Discussion**

All of these wrecks have planking assembled using mortise-and-tenon joints and frames attached using internal lashings. Where this system has been examined in detail (Cap del Vol, Saintes-Maries 24, Baie de l'Amitié), the lashings consist of braided vegetal cord threaded through two vertical channels drilled through the frame and planking, and locked by long trenails. Grooves connect the channels on the inboard of the

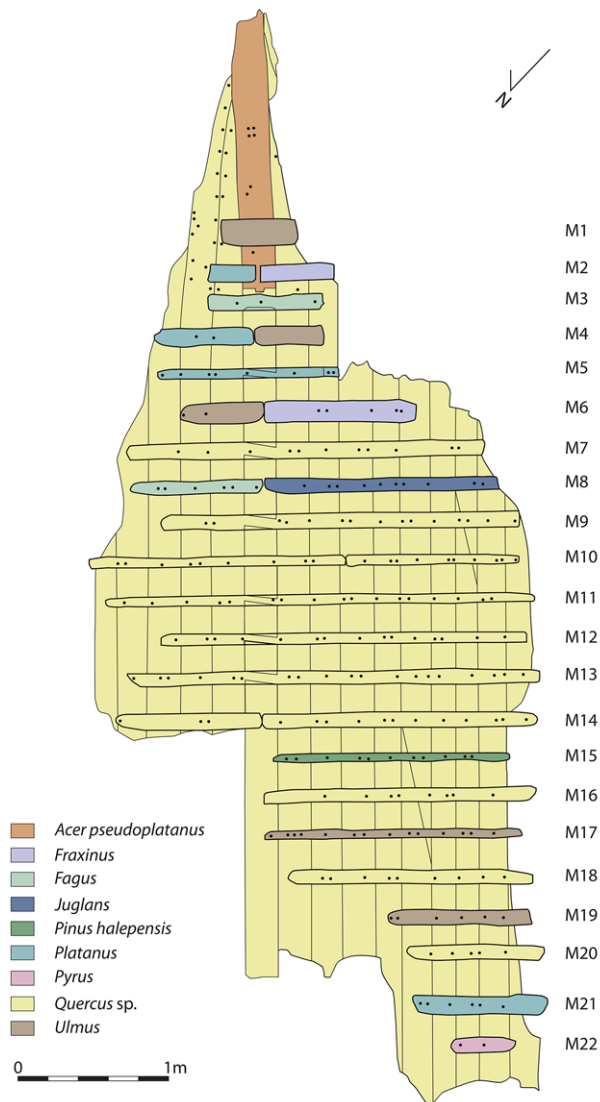

Figure 41. Baie de l'Amitié shipwreck: general plan and wood species distribution (from Wicha, 2002).

frames and on the outboard surface of the planking and are filled up by a coat of pitch. Single treenails, and sometimes nails, complete the system in a more-or-less regular pattern. The boats of this second group sailed in the fluvio-maritime zones of Catalonia and Languedoc, from the Ebro river up to the Rhône River, an area characterized by networks of rivers and coastal lagoons but could also be involved in offshore navigation (Perduto 1). The vessels in this second group are medium-sized sailing vessels, with the exception of the recently discovered Cala Cativa 1 wreck, which is a small boat.

Two other vessels can be discussed with these groups that have frames fastened to the planking with internal lashings, although their remains are too fragmentary to assign them to either definitively: Port-Vendres 3 (mid 2nd century AD; Jézégou, 2007; Fig. 34.63) and

the fragments of a hull found in Port La Nautique (Narbonne, end of the 1st century BC–1st century AD; Falguera and Jézégou, 2002: 42–44; Fig. 34.64). The first is a hull fragment (3 × 1.50m) consisting of nine planking strakes and eight frames. The second is a section of planking with four strakes and two frames. In neither case can the type of the ship be discerned. All the frames, however, are fastened with internal lashings locked by treenails. As a result, these two hull fragments belong to this same broad technical tradition.

It should also be noted that on the Cavalière wreck, this system of internal lashing was also used for an element of the upper works of the boat (Charlin *et al.*, 1978: 57–60).

Although two different architectural ship types have been presented, corresponding to different navigation zones (Long *et al.*, 2009: 285), and without an evident direct connection, all of the 18 vessels of these two groups (ten wrecks in the first one, six in the second, and two undetermined) have been built using the same technical solution of internal lashings to fasten the framing. They all belong therefore to the same north-western Mediterranean technical tradition. The geographical extent of this technique and the diversity of the architectural types concerned prevent the recognition of a specific cultural regional practice or particular shipyard 'fingerprints'. Unlike the traditions described earlier, which are inscribed in a specific cultural context from a geographical, historical, and technical point of view, this technical tradition's origins remain unclear and it appears to have been grafted onto various previous architectural traditions present in the north-western Mediterranean. The modalities of this process also remain to be determined.

Indeed, the distribution of the two architectural types identified within the technical tradition may reflect two geographical areas of origin and sailing. The first gathers shipwrecks found west of the Rhône River, particularly along the coast of Catalonia (NE Spain), and concerns mainly fluvio-maritime ships (Cap del Vol, Baie de l'Amitié, Cala Cativa 1, Port-Vendres 3, Port La Nautique, Saintes-Maries 2, Saintes-Maries 24), but also small coastal boats (Cap Béar 3, Palamos). The Perduto 1 wreck with its cargo of Dressel 2/4 amphoras from Tarraconensis (Catalonia), and the Plane 1 wreck with its lucky coin from Tarragona, might also belong to this geographical group.

The second group gathers small coastal boats east of the Rhône River, along the coast of Provence (La Tour-Fondue, Cavalière, Jaume-Garde B, La Roche-Fouras, Dramont C, Barthélemy B, Médès 6). The earliest example in this *corpus* is La Tour-Fondue wreck, dated to the second half of the 3rd century BC by its cargo of Greco-Italic amphoras, but most of the wrecks cited date between the 1st century BC and 1st century AD, which can be seen as the height of this north-western Mediterranean tradition.

The origin of this tradition is not clear as we don't know precisely where the boats were built,



but all of them were found in a Roman north-western Mediterranean area and belong to regional fluvio-maritime or coastal boats, and were probably built locally according to the wood supply and the architectural type (Wicha, 2004, 2005; Vivar *et al.*, 2014). However, Cavalière very likely originated in southern Italy or the Balkans, and Calabria (South Italy) is also suggested as the origin for the Baie de l'Amitié wreck due to the use of oriental plane (*Platanus orientalis*). Alternatively, the Baie de l'Amitié boat could have been built in a shipyard with imported wood (for example through the major harbour of Narbonne), such as is suggested for the spruce (*Picea abies* Karst) identified on *Cap Béar 3* (Wicha and Girard, 2006: 115).

Some examples of internal lashings locked by treenails are known from other sites and different periods, though they are not used in a systematic way for the frames as has been discussed for the north-western Mediterranean tradition here. For example, this technique was used on the Marsala Punic ship (Fig. 1, C; mid 3rd century BC) for a wooden element from the upper works identified by Honor Frost (1976: 260–262) as a 'shield holder'. This technique was also used on the Greco-Massalian Jules-Verne 9 shipwreck to fasten some of the top-timbers (see above), which is, to date, the earliest evidence of this system of lashing yet found in Mediterranean shipbuilding. Lastly, as we have seen, this technique is also attested in the Adriatic area, in the wreck of Cavanella d'Adige (2nd–1st century BC), but on a probable bottom-based boat and associated with sewn planking.

It appears, then, that this technique must have a very early origin and have been used in differing contexts for various purposes. However, the means by which it came to be used systematically to fasten the framing, to the point of forming a specific north-western Mediterranean technical tradition during the Roman period, remains problematic. One could note, however, that the systematic use of this technique to fasten the framing was adopted in different architectural contexts, that is for both fluvio-maritime vessels and coasters.

In the case of Cala Cativa 1 and Cap del Vol, both flat-bottomed boats found on the Catalan coast in close proximity to one another and presumed to have been used for local navigation and probably of the same local origin and tradition (Vivar *et al.*, 2014), it appears unlikely that there is a direct link between the internal lashed frames used and that of the Iberian tradition where the framing is fastened using external lashings, despite the latter's longevity, because these two systems correspond to two quite different construction principles.

## Conclusion

At the end of this long survey of sewing and lashing techniques used in ancient Mediterranean shipbuilding, evidenced by a corpus of 64 wrecks, it has been possible to distinguish several different traditions, each

characterized and identified, that can be attributed to precise regional and cultural areas. These traditions, found in areas throughout the Mediterranean, testify to the aptness of these techniques. Sewn techniques achieved a very high degree of sophistication, and were well adapted to the needs of shipbuilding at the time. If they are most common during the Archaic period, their origin appears to be much earlier, dating back at least to the Late Bronze Age, if not before.

According to the data discussed here, sewn-boat traditions existed on the northern coasts of the Mediterranean, with particularly active roots in Greece, from the Ionian coast to the western Phocaeen settlements around Marseilles, in the Northern Adriatic, on the Iberian Peninsula, and in the northern arc of the western Mediterranean. By contrast, the eastern and southern coasts seem to be less concerned by sewn-boat traditions, while the technique of mortise-and-tenon joints was diffused toward the south-western Mediterranean via the Phoenician cities and Carthage. It is also true that the archaeological record is less abundant, and sometimes inexistent, in these areas.

We can also distinguish sewing systems that developed in different ways. So, while the Aegean Greek and the Istro-Liburnian traditions both originally used sewn planking with lashed frames, they were developed along different trajectories. In the Greek tradition, the progressive adoption of the mortise-and-tenon joint and rapid abandon of lashed frames in preference for nails or treenails, has been noted. In contrast, in the Istro-Liburnian tradition sewn planking was maintained during the Roman period when the framing was mainly treenailed in place.

On the other hand, within the 'Iberian with Punic influence' tradition, planking assembled by mortise-and-tenon joints was quickly adopted, while lashed frames endure, probably retained from an earlier tradition. A similar technical solution is found in the north-western Mediterranean tradition in which planking is assembled by mortise-and-tenon joints with frames attached with a combination of internal lashings and treenail/nails. The origin of this technical tradition seems to be separate from the others described, and is not yet clear, and the modalities of its adoption must still be clarified.

At the same time and in parallel, the mortise-and-tenon joint system, well attested at the end of the Bronze Age, was gradually adopted throughout the Mediterranean during the Archaic and Classical periods to become the dominant technique of assembling planking in Mediterranean ancient shipbuilding by the end of the 4th century BC. But even when the mortise-and-tenon joint became predominant, sewing traditions did not disappear. Some endured until the end of antiquity and into the Early Medieval period, in particular locations, such as in the Adriatic region, where the tradition was particularly strong and well adapted to the specific environment and sailing area.

It is highly likely that this list of sewn-boat traditions is far from complete. Indeed, there is no data available for many areas, not only on the southern or eastern Mediterranean shores but also in the western Mediterranean. For example, Etruscan shipbuilding remains unknown, or at least unidentified in the record (Long *et al.*, 2002; Pomey, 2006; 2017c). In this respect, MacIntosh Turfa and Steinmeyer (2001) is discounted because they consider the Giglio and Bon-Porté 1 wrecks to be Etruscan rather than Greek and suggest, ignoring the Jules-Verne 7 and 9,

that Greek shipbuilders neither knew nor used sewn techniques. However, the alternative hypothesis that the Etruscans also used ligature assembly techniques (Basch, 1981; Bonino, 1995; Long *et al.*, 2006) is possible but remains to be determined. We hope that future research and discoveries will yield new evidence for other sewn-boat traditions that will refine our understanding of both the adoption of new technological solutions and the preservation of practices within specific cultural contexts.

## Acknowledgements

We would like to especially thank Dan Davis who agreed to share his latest study on the Ereğli E wreck, still unpublished at the time of writing of this paper. We want to thank Gustau Vivar (Centre d'Arqueologia Subaquàtica de Catalunya) who kindly shared the discovery and the information on the Cala Cativa 1 wreck (Cap Creus). Finally, we would like to thank the anonymous reviewers of this article for their comments and suggestions that have permitted us to improve our work.

## Note

1. The research carried out in Caska Cove within the international project *Cissantiqua* are directed by Irena Radić Rossi, Department of Archaeology of the University of Zadar and Giulia Boetto, and are supported by the Ministry of Culture of the Republic of Croatia, the Croatian Science Foundation (AdriaS project), the Novalja municipality, the French Ministry for Foreign Affairs (Adriboats project), the French Embassy in Zagreb, the Aix Marseille University and the CNRS. These French institutions also support collaboration between the Centre Camille Jullian and the Archaeological Museum of Istria (AMI) in Zabrata and Pula, and the Croatian conservation Institute (HRZ) in Kamensko.

## References

- Arnold, B., 1998, Embarcations romano-celtiques et construction sur sole, in E. Rieth (ed.), *Concevoir et construire les navires. De la trière aux picotaux*, 73–90. Ramonville Saint-Agne.
- Arnold, B., 1999, Some remarks on Romano-Celtic boat construction and Bronze Age wood technology. *IJNA* 28.1, 34–44.
- Basch, L., 1976, Le navire cousu de Bon Porté. *Cahiers d'Archéologie Subaquatique* V, 37–42.
- Basch, L., 1978, L'assemblage du navire de Bon Porté. *Dossiers de l'Archéologie* 29, 71–73.
- Basch, L., 1981, Carthage and Rome: tenons and mortises. *The Mariner's Mirror* 67.3, 245–250.
- Basch, L., 1987, *Le musée imaginaire de la marine antique*. Athens.
- Bass, G.F., 1967, *The Cape Gelidonya: A Bronze Age shipwreck*. Philadelphia: Transactions of the American Philosophical Society vol. 57.8.
- Bass, G.F., 1989, The construction of a seagoing vessel of the Late Bronze Age, in H. Tzalas (ed.), *Tropis I. Proceedings of the 1st International Symposium on Ship Construction in Antiquity, Piraeus 1985*, 25–35. Athens.
- Bass, G.F., 1999, The Hull and Anchor of the Cape Gelidonya Ship, in Ph. Betancourt, V. Karageorghis, R. Laffineur and W.D. Niemeier (eds), *Meletmata. Studies in Aegean Archaeology presented to Malcom H. Wiener*, 21–24. Liège-Austin: Aegaeum 20.
- Beltrame, C., 1996, La *sutiles navis* del Lido di Venezia. Nuova testimonianza dell'antica cantieristica 'a cucitura' nell'alto Adriatico, in F. Ciciliot (ed.), *Navalia. Archeologia e storia*, 31–53. Savona.
- Beltrame, C., 2000, *Sutiles naves* of Roman Age. New Evidence and Technological Comparisons with pre-Roman Sewn Boats, in J. Litwin (ed.), *Down the River to the Sea, Proceedings of the Eighth International Symposium on Boat and Ship Archaeology (ISBSA 8)*, Gdańsk 1997, 91–92. Gdańsk.
- Beltrame, C., 2001, Imbarcazioni lungo il litorale altoadriatico occidentale in età romana. Sistema idroviario, tecniche costruttive navali e tipi navali, in C. Zaccaria (ed.), *Strutture portuali e rotte marittime nell'Adriatico in età romana*, 431–449. Trieste-Rome: Antichità Altoadriatiche 46, CERF 280.
- Beltrame, C., 2002a, Le *sutiles naves* romane del litorale alto-adriatico. Nuove testimonianze e considerazioni tecnologiche. *Archeologia Subacquea. Studi, ricerche, documenti* III, 355–358.
- Beltrame, C., 2002b, Sewn plank boats of the Roman era in the Upper Adriatic sea: new evidence, in H. Tzalas (ed.), *Tropis VI, Proceedings of the 7th International Symposium on Ship Construction in Antiquity, Pylos 1999*, 103–113. Athens.
- Beltrame, C., 2009, A New View of the Interpretation of the Presumed Medieval Po Delta Wrecks, Italy. *IJNA* 38.2, 412–417.
- Beltrame, C. and Gaddi, D., 2013, Fragments of Boats from the Canale Anfora of Aquileia, Italy, and Comparison of Sewn-Plank Ships in Roman Era. *IJNA* 42.2, 296–304.
- Beltrame, C. and Costa, E., 2016, A 5th-Century-AD Sewn-Plank River Barge at St. Maria in Padovetere (Comacchio-FE), Italy: an interim report. *IJNA* 45.2, 253–266.

- Benini, A., 2001, Il secondo relitto di Gela: note di architettura navale, in R. Panvini (ed.), *La nave greca arcaica di Gela (e primi dati sul secondo relitto Greco)*, 97–106. Palermo.
- Benini, A., 2012, Lo scafo, in D. Vullo (ed.), *La nave greca arcaica di Gela, dallo scavo al recupero*, 53–103. Palermo.
- Benini, A., 2017, The Archaic Greek sewn boat from Gela (Sicily, Italy). Some notes on the hull construction, in J. Gawronsky, A. van Holk and J. Schokkenbroek (eds), *Ships And Maritime Landscapes, Proceedings of the Thirteenth International Symposium on Boat and Ship Archaeology (ISBSA 13)*, Amsterdam 2012, 409–413. Eelde.
- Bernard, H., 2008, Naval Architecture and New Market—the Perduto 1 Shipwreck—New evidence for the use of stitches for binding timbers. *Skyllis* 8 1–2, 15–18.
- Berti, F., 1986, La nave romana di Valle Ponti (Comacchio). *Revue d'études ligures* 4, 553–570.
- Berti, F. (ed.), 1990, *Fortuna Maris. La nave romana di Comacchio*. Bologna.
- Boccaccini, L., Carli, L. and Gelli, G., 1983, *La nave romana di Comacchio (prime considerazioni)*. Ferrara.
- Bockius, R., 2003, A Roman river barge (?) found in the Danube near Prahovo, Serbia, in C. Beltrame (ed.), *Boats, Ships and Shipyards, Proceedings of the Ninth International Symposium on Boat and Ship Archaeology (ISBSA 9)*, Venice 2000, 169–176. Oxford.
- Boetto, G., 2016, Recherches d'archéologie navale en Adriatique orientale. *Comptes Rendus de l'Académie des Inscriptions et Belles-Lettres*, novembre-décembre, 1401–1422.
- Boetto, G., Koncani Uhač, I. and Uhač, M., 2014, Navires de l'âge du Bronze à l'époque romaine en Istrie, in P. Pomey (ed.), *Ports et Navires dans l'Antiquité et à l'époque byzantine. Dossiers d'Archéologie* 364, 22–25.
- Boetto, G., Koncani Uhač, I. and Uhač, M., 2017, Sewn ships from Istria (Croatia): the shipwrecks of Zambratija and Pula, in J. Litwin (ed.), *Baltic and Beyond, Change and Continuity in Shipbuilding, Proceedings of the Fourteenth International Symposium on Boat and Ship Archaeology (ISBSA 14)*, Gdańsk 2015, 189–198. Gdańsk.
- Boetto, G. and Radić Rossi, I., 2014, Au large de la Dalmatie. Nouvelles recherches d'archéologie navale, in P. Pomey (ed.), *Ports et Navires dans l'Antiquité et à l'époque byzantine. Dossiers d'Archéologie* 364, 52–55.
- Boetto, G. and Radić Rossi, I., 2017, Ancient Ships from the Bay of Caska (Island of Pag, Croatia), in J. Litwin (ed.), *Baltic and Beyond, Change and Continuity in Shipbuilding, Proceedings of the Fourteenth International Symposium on Boat and Ship Archaeology (ISBSA 14)*, Gdańsk 2015, 279–288. Gdańsk.
- Boetto, G. and Rousse, C., 2011, Le chaland de Lipe (Ljubljana, Slovénie) et la tradition de construction « sur sole » de l'Europe sud-orientale : quelles influences méditerranéennes? in G. Boetto, P. Pomey and A. Tchernia (eds), *Batellerie Gallo-romaine. Pratiques régionales et influences maritimes méditerranéennes*, 179–191. Paris, Aix-en-Provence: BiAMA 9.
- Boetto, G. and Rousse, C., 2012, Traditions régionales d'architecture navale en Adriatique à l'époque romaine. *Histria Antiqua* 21, 427–441.
- Boetto, G., Pomey, P. and Tchernia A. (eds), 2012, *Batellerie Gallo-romaine. Pratiques régionales et influences maritimes méditerranéennes*. Paris, Aix-en-Provence: BiAMA 9.
- Bonino, M., 1968, Tecniche costruttive navali insolite nei reperti di Cervia, Pomposa e Pontelagoscuro, *Atti del Convegno Internazionale di Studi sulle Antichità di Classe, Ravenna 1967*, 209–217. Ravenna.
- Bonino, M., 1971, Ricerche sulla nave romana di Cervia, in *Atti del III Congresso Internazionale di Archeologia Sottomarina, Barcelona 1961*, 316–325. Bordighera.
- Bonino, M., 1978, *Archeologia e tradizione navale tra la Romagna e il Po*. Ravenna.
- Bonino, M., 1985, Sewn Boats in Italy: *sutiles naves* and barche cucite, in S. McGrail and E. Kentley (eds), *Sewn Plank Boats*, 87–104. Oxford: BAR Int. Series 276.
- Bonino, M., 1990, Tecnica costruttiva e architettura navale, proposte per la ricostruzione, in F. Berti (ed.), *Fortuna Maris. La nave romana di Comacchio*, 35–42. Bologna.
- Bonino, M., 1995, Sardinian, Villanovian and Etruscan crafts between the Xth and the VIIIth centuries BC from bronze and clay models, in H. Tzalas (ed.), *Tropis III. Proceedings of the 3rd International Symposium on Ship Construction in Antiquity, Athens 1989*, 83–98. Athens.
- Bound, M., 1985, Early observations on the construction of the pre-classical wreck at Campese Bay, island of Giglio: clues to the vessel's nationality, in S. McGrail and E. Kentley (eds), *Sewn Plank Boats*, 49–65. Oxford: BAR Int. Series 276.
- Bound, M., 1991, *The Giglio wreck: A wreck of the Archaic period c.600 BC off the Tuscan Island of Giglio. An account of its discovery and excavation. A review of the main finds*. Athens: Ennalìa sup. 1
- Brennan, M.L., Davis, D., Roman, Ch., Buynevich, I., Catsambis, A., Kofahl, M., Ürkmez, D., Vaughn, J. I., Merrigan, M. and Duman, M., 2013, Ocean dynamics and anthropogenic impacts along the southern Black Sea shelf examined through the preservation of pre-modern shipwrecks. *Continental Shelf Research* 53, 89–101.
- Bruni, S. (ed.), 2000, *Le navi antiche di Pisa. Ad un anno dall'inizio delle ricerche*. Florence.
- Brusić, Z., 1968, Istrazivanje anticke luke kod Nina. *Diadora* 4, 203–210.
- Brusić, Z., 1987, Zaton kod Zadra. Antička luka Aenone. *Arheološki pregled* 28, 121–122.
- Brusić, Z. and Domjan, M., 1985, Liburnian Boats: their construction and form, in S. McGrail and E. Kentley (eds), *Sewn Plank Boats*, 67–85. Oxford: BAR Int. Series 276.
- Cabrera Tejedor, C., 2017, Apuntes sobre el barco de Mazarrón I: estimación de dimensiones, reconstrucción preliminar del casco, cálculos hidrostáticos, función y origen de la nave, in M. Martínez Alcade, J. M. García Cano, J. Blánquez Pérez and Á. Iniesta Sanmartín (eds), *MAZARRÓN II. Contexto, viabilidad y perspectivas del barco B-2 de la bahía de Mazarrón. En homenaje a Julio Mas García*, 187–227, Madrid.
- Cabrera Tejedor, C., 2018, The Mazarrón 1 Shipwreck: an iron-age boat with unique features from the Iberian Peninsula. *IJNA* 47.2, 300–324.
- Camilli, A., 2002, *Cantiere delle navi di Pisa. La nave C 'Giuditta' dallo scavo al laboratorio*. Florence.



- Capulli, M. and Pellegrini, A., 2010, Tavole cucite dall'Isola di San Francesco del Deserto (Venezia), in S. Medas, M. D'Agostino and G. Caniato (eds), *Atti del I convegno nazionale, Archeologia, Storia, Etimologia navale, Cesenatico 2008*, 263–266. Bari: Navis 4.
- Carrazé, F., 1977, Mediterranean hull types compared. 3. The Jeume-Garde B wreck at Porquerolles (France). *IJNA* 6.4, 299–303.
- Carre, M.-B., 1997, La survivance de l'assemblage par ligatures après l'époque archaïque, in D. Garcia and D. Meeks (eds) *Techniques et économie antiques et médiévales 'Le temps de l'innovation', Colloque international, Aix-en-Provence 1996*, 204–205. Paris.
- Casson, L., 1963, Sewn Boats. *The Classical Review* XIII, 3, 257–259.
- Casson, L., 1964, Odysseus' Boat (*Od. V, 244–57*). *American Journal of Philology* 85, 61–64.
- Casson, L., 1971 (2nd edn 1986), *Ships and Seamanship in the Ancient World*. Princeton.
- Casson, L., 1992, Odysseus' boat (*Od. V, 244–53*). *IJNA* 21.1, 73–74.
- Castro, F. and Capulli, M., 2016, A preliminary report of recording the Stella 1 Roman River barge, Italy. *IJNA* 45.1, 29–41.
- Castro, F. and Capulli, M., 2017, The Stella 1 shipwreck. A Roman barge in the upper-Adriatic region (Udine, Italy), in J. Gawronsky, A. van Holk and J. Schokkenbroek (eds), *Ships And Maritime Landscapes, Proceedings of the Thirteenth International Symposium on Boat and Ship Archaeology (ISBSA 13), Amsterdam 2012*, 425–430. Eelde.
- Čelhar, M., 2008, The underwater interdisciplinary project in Caska bay, Pag island, in I. Radić Rossi, A. Gaspari and A. Pydyn (eds), *Proceedings of the Thirteenth Annual Meeting of the European Association of Archaeologists, Session: Underwater Archaeology, Zadar 2007*, 176–186. Zagreb.
- Chapman, F.H., 1775, *Tractat om Skepps-Byggeriet*, Stockholm (French edn, H. S. Vial de Clairbois, *Traité de la construction des vaisseaux...*, Brest, 1781).
- Charlin, G., Gassend, J.-M. and Lequément, R., 1978, L'épave antique de la Baie de Cavalière (Le Lavandou, Var). *Archaeonautica* 2, 9–93.
- Cipriano, S., 2011, La suddivisione agraria del territorio altinate: primi dati archeologici, in G. Cresci Marrone and M. Tirelli (eds), *Altino dal cielo: la città telerivelata. Lineamenti di Forma Urbis. Atti del convegno, Venezia 2009*, 81–94. Rome.
- Coates, J. F., 1985, Some structural models for sewn boats, in S. McGrail and E. Kentley (eds), *Sewn Plank Boats*, 9–18. Oxford: BAR Int. Series 276.
- Cristofani, M., 1996, Un naukleros greco-orientale nel Tirreno. Per un'interpretazione del relitto di Giglio, in M. Cristofani (ed.), *Etruschi e altre genti nell'Italia preromana*, 21–48. Rome.
- Čufar, K., Merela, M. and Erič, M., 2014, A Roman barge in the Ljubianica river (Slovenia): wood identification, dendrochronological and wood preservation research. *Journal of Archaeological Science* 44, 128–135.
- Dangréaux, B., 1997, Var. Au large d'Hyères. Presqu'île de Giens, épave de la Tour-Fondue, in *Bilan scientifique du DRASSM 1996*, 89–90. Paris.
- Dangréaux, B., 2001, Var. Presqu'île de Giens, épave de la Tour-Fondue, in *Bilan scientifique du DRASSM 1997*, 57–59. Paris.
- Dangréaux, B., François, S., Guibal, F., Wicha, S. and Gentric, G., 2012, L'épave de la Tour Fondue (Presqu'île de Giens, Var). Un bâtiment de cabotage dans la seconde moitié du IIIe s. av. J.-C. *Cahiers d'Archéologie Subaquatique* 19, 5–36.
- Davis, D., Brennan, M.L., Opait, A. and Beatrice, J.S., 2018, The Ereğli E Shipwreck, Turkey: an early Hellenistic merchant Ship in the Black Sea. *IJNA* 47.1, 57–80.
- De Juan, C., 2013, Los veleros de comercio romano del Mediterráneo occidental. Análisis de familias y firmas arquitecturales (s. III a. C.–II d. C.). PhD thesis, Universitat de València (unpublished).
- De Juan, C., 2014, Les épaves de Mazarrón et de Bibisafüller. La tradition ibérique d'influence punico-phénicienne, in P. Pomey (ed.), *Ports et Navires dans l'Antiquité et à l'époque byzantine. Dossiers d'Archéologie* 364, 26–33.
- De Juan, C., 2017, Técnicas de arquitectura naval de la cultura fenicia. *SPAL* 26, 59–85.
- De Juan, C., 2018, El pecio de Binisafüller y los barcos en la cultura ibérica, in G. Boetto and E. Rieth (eds), *De re navali: Pérégrinations nautiques entre Méditerranée et océan Indien. Mélanges en l'honneur de Patrice Pomey*, 89–102. Paris: Archaeonautica 20.
- De Juan, C., Aguelo, X., Palomo, A. and Pons, O., 2010, La construcción naval del pecio di Binisafüller (Menorca-Islas Baleares). Análisis de los restos de casco conservados, in P. Pomey (ed.), *Transferts technologiques en architecture navale méditerranéenne de l'Antiquité aux temps modernes: identité technique et identité culturelle, Actes de la Table Ronde, Istanbul 2007*, 59–73. Istanbul: Varia Anatolica XX.
- De Juan Fuertes, C., 2017, Los pecios de Mazarrón y la familia arquitectónica ibérica. Los ejemplos más antiguos de la arquitectura naval indígena en la Península Ibérica, in M. Martínez Alcade, J. M. García Cano, J. Blánquez Perez and Á. Iniesta Sanmartín (eds), *MAZARRÓN II. Contexto, viabilidad y perspectivas del barco B-2 de la bahía de Mazarrón. En homenaje a Julio Mas García*, 229–251, Madrid.
- Dell'Amico, P., 2009, Proposta preliminare per una tipologia delle cuciture nell'ambito della costruzione di natanti. *Archaeologia Maritima Mediterranea* 6, 13–70.
- Demesticha, S., 2011, The 4th-Century BC Mazotos Shipwreck, Cyprus: a preliminary report. *IJNA* 40.1, 39–59.
- Eiseman, C. J. and Ridgway, B. S., 1987, *The Porticello Shipwreck. A Mediterranean Merchant Vessel of 415–385 BC*. College Station, TX.
- Erič, M., Gaspari, A., Čufar, K., Solina, F. and Verbič, T., 2014, Zgodnjerska ladja iz Ljubljane pri Sinji Gorici / Early Roman barge from the Ljubianica River at Sinja Gorica. *Arheološki vestnik* 65, 187–254.
- Falguera, J.-M. and Jézégou, M.-P., 2002, Port La Nautique, in *Bilan scientifique du DRASSM 2000*, 42–46. Paris.
- Foerster Laures, F., 1988, A third ancient ship of the 0<sup>o</sup>-class, with cargo from Catalonia. *IJNA* 17.2, 178–180.
- Foerster, F., Pascual, R. and Barberá, J., 1987, *El pecio romano de Palamós*. Barcelona.

- Frost, H. (ed.), 1976, *Lilybaeum (Marsala). The Punic Ship: final excavation report*, Atti Accademia Nazionale dei Lincei, Notizie degli Scavi di Antichità XXX, suppl. Rome (1981).
- Gaspari, A., 1998a, 'Pontonium' iz Lip na Liubljskem barju. *Arheološki vestnik* **49**, 187–224.
- Gaspari, A., 1998b, Das frachtschiff aus Lipe im Moor von Laibach (Ljubljana). *Jarbuch des Römisch-Germanischen Zentralmuseums Mainz* **45**, 527–550.
- Gaspari, A., 2009, A cargo ship of Mediterranean sewn construction from Lipe, in P. Turk, J. Istenic and T. Knific (eds), *The Ljubljana: a river and its past*, 116–119. Ljubljana.
- Gaspari, A., 2017, *Deblak s konca 2. stoletja pr. n. št. iz Ljubljanice na Vrhniki / The Late 2nd Century BC Logboat from the Ljubljana River at Vrhnika*. Ljubljana.
- Gaspari, A., Erič, M. and Smalcelj, M., 2006, Roman river barge from Sisak (Siscia), Croatia, in L. Blue, F. Hocker and A. Englert (eds), *Connected by the Sea, Proceedings of the Tenth International Symposium on Boat and Ship Archaeology (ISBSA 10)*, Roskilde 2003, 284–289. Oxford.
- Gluščević S., 2004, Hydroarchaeological excavation and the discovery of the third 'sewn' Liburnian ship – *seriliae* – in the roman port of Zaton near Zadar. *Archaeologia Maritima Mediterranea* **1**, 41–52.
- Greenhill, B., 1976, *Archaeology of the Boat*. London.
- Guerrero Ayuso, V. M., 2008, Barcos aborígenes en el estrecho de Gibraltar, in *VIII Jornadas de Historia de Ceuta. Barcos, puertos y navegación en la historia de Ceuta*, 33–65. Ceuta.
- Guibal, F. and Pomey, P., 2003, Timber Supply and Ancient Naval Architecture, in C. Beltrame (ed.), *Boats, Ships and Shipyards. Proceedings of the Ninth International Symposium on Boat and Ship Archaeology (ISBSA 9)*, Venice 2000, 35–41. Oxford.
- Hadjidaki, E., 1996, Underwater Excavations of a Late Fifth Century Merchant Ship at Alonnesos, Greece. *Bulletin de Correspondence Hellenique* **120**, 561–593.
- Hocker, F., 2004, Bottom-based shipbuilding in Northwestern Europe, in F. M. Hocker and C. A. Ward (eds), *The Philosophy of Shipbuilding. Conceptual approaches to the study of wooden ships*, 65–93. College Station, TX.
- Hornell, J., 1946, *Water Transport. Origins and Early Evolution*. Cambridge.
- Jézégou, M.-P., 2007, Littoral du Languedoc-Rousillon. Carte archéologique, in *Bilan scientifique du DRASSM 2005*, 40–44. Paris.
- Joncheray, J.-P., 1976a, L'épave grecque ou étrusque de Bon Porté. *Cahiers d'Archéologie Subaquatique* **V**, 5–36.
- Joncheray, J.-P., 1976b, Mediterranean hull types compared. 1. La Roche-Fouras. *IJNA* **5.2**, 107–114.
- Joncheray, J.-P., and Joncheray, A., 2004, Epave de tuiles romaines en Provence-Côte d'Azur. L'épave Barthélemy B à Saint-Raphael. *Cahiers d'Archéologie Subaquatique* **XV**, 7–72.
- Joncheray, J.-P., and Rochier, R., 1976, L'épave de la Roche Fouras. Coque du navire, estampilles sur amphores. *Cahiers d'Archéologie Subaquatique* **V**, 167–180.
- Kahanov, Y., 1998, The Ma'agan Mikhael Ship (Israel). A Comparative Study on its Hull Construction, in P. Pomey and E. Rieth (eds), *Construction navale maritime et fluviale. Approches archéologique, historique et ethnologique*, in *Actes du 7e Colloque International d'Archéologie Navale—Proceedings of the Seventh International Symposium on Boat and Ship Archaeology (ISBSA 7)*, ile Tatihou 1994, 155–160. Paris: Archaeonautica 14.
- Kahanov, Y. and Pomey, P., 2004, The Greek Sewn Shipbuilding Tradition and the *Ma'agan Mikhael* Ship: A Comparison with Mediterranean Parallels from the Sixth to the Fourth centuries BC. *The Mariner's Mirror* **90.1**, 6–28.
- Koncani Uhač, I., 2009, Podvodna arheološka istraživanja u uvali Zambratija. *Histria Antiqua* **17**, 263–268.
- Koncani Uhač, I. and Uhač, M., 2012, Prapovijesni brod iz uvale Zambratija—Prva kampanja istraživanja / Prehistoric Boat from Zambratija Cove—The First Campaign of Exploration. *Histria Antiqua* **21**, 533–538.
- Koncani Uhač, I. and Uhač, M., 2014, La barca protostorica di Zambratija/Zambratia in Istria: risultati preliminari della prima campagna di scavo, in A. Asta, G. Caniato, D. Gnola and S. Medas (eds), *Archeologia, Storia e Etnografia navale, Atti del II Convegno Nazionale, Cesenatico 2008*, 29–33. Padova: Navis 5.
- Koncani Uhač, I., Boetto, G. and Uhač, M., 2017a, *Zambratija. Prapovijesni šivani brod/Prehistoric sewn boat/Una barca cucita preistorical/Un bateau cousu préhistorique*. Pula: Katalog 85.
- Koncani Uhač, I., Petrović, M. and Sardoz, A., 2017b, Projekt zaštite rimskog šivanog broda Pula 2: od mulja do ponovnog sjaja / Protection project of the Roman sewn boat Pula 2: from sludge to its former splendour. *Histria Archaeological* **48**, 151–168.
- Landström, B., 1970, *Ships of the Pharaohs*. London.
- Linder, E. and Kahanov, Y., 2003, *The Ma'agan Mikhael ship. The Recovery of a 2400-year-old Merchantman. Final Report*, Vol. I. Jerusalem-Haifa.
- Linder E. and Kahanov, Y., 2004, *The Ma'agan Mikhael ship. The Recovery of a 2400-year-old Merchantman. Final Report*, Vol. II. Jerusalem-Haifa.
- Liou, B., 1975, Informations archéologiques. Recherches sous-marines. *Gallia* **33.2**, 571–605.
- Liou, B. and Pomey, P., 1985, Informations archéologiques, Recherches sous-marines. *Gallia* **43.2**, 547–576.
- Lipke, P., 1984, *Royal Ship of Cheops*. Oxford: BAR S225.
- Long, L., 1997, Carte archéologique. Au large de la Camargue. L'épave Sainte-Marie-de-la-Mer 2, in *Bilan scientifique du DRASSM 1996*, 73. Paris.
- Long, L., 2003, Carte archéologique. Au large de la Camargue. L'épave Sainte-Marie 24, in *Bilan scientifique du DRASSM 2002*, 53–54. Paris.
- Long, L., Marlier, S. and Rival, M., 2009, The Saintes-Mairies-de-la-Mer 24 (SM24) Shipwreck (France, AD 40–75): a Sea-River Cargo Vessel with Stitched Frames, in R. Bockius (ed.), *Between the Seas. Transfer and Exchange in Nautical Technology*,

- Proceedings of the Eleventh International Symposium on Boat and Ship Archaeology (ISBSA 11)*, Mainz 2006, 277–287. Mainz: RGZM-Tagungen 3.
- Long, L. and Sourisseau J.-Ch., 2002, Épave de Bon-Porté 1 (Ramatuelle), in L. Long, P. Pomey, and J.-Ch. Sourisseau (eds), *Les Etrusques en mer. Épaves d'Antibes à Marseille*, 43–47. Aix-en-Provence, Marseille.
- Long, L., Pomey, P. and Sourisseau, J.-Ch. (eds), 2002, *Les Etrusques en mer. Épaves d'Antibes à Marseille*. Aix-en-Provence, Marseille.
- Long, L., Gantès, L.-F. and Rival, M., 2006, L'épave Grand-Ribaud F. Un chargement de produits étrusques du début du Ve siècle avant J.-C., in *Gli Etruschi da Genova ad Ampurias, Atti XXIV Convegno di Studi Etruschi ed Italici, Marseille-Lattes 2002*, 455–495. Pisa-Rome.
- McGrail, S., 1995, Romano-Celtic Boats and Ships: Characteristic Features. *IJNA* 24, 139–145.
- McGrail, S., 2001, *Boats of the World. From the Stone Age to Medieval Times*. Oxford.
- McGrail, S. and Kentley, E. (eds), 1985, *Sewn Plank Boats*. Oxford: BAR Int. Series 276.
- MacIntosh Turfa, J. and Steinmeyer Jr., A.G., 2001, Sewn hulls and self-defense. *IJNA* 30.1, 122–127.
- Mark, S., 1991, Odyssey 5.234–53 and Homeric Ship Construction: A Reappraisal. *AJA* 95.3, 441–445.
- Mark, S., 1996, Odyssey 5.234–53 and Homeric Ship Construction: A Clarification. *IJNA* 25.1, 46–48.
- Mark, S., 2005, *Homeric Seafaring*. College Station, TX.
- Marlier, S., 2002, La question de la survivance des bateaux cousus de l'Adriatique, in L. Rivet and M. Sciallano (eds), *Vivre, produire et échanger: reflets méditerranéens, Mélanges offerts à Bernard Liou*, 21–32. Montagnac.
- Marlier, S., 2005, *Systèmes et techniques d'assemblage par ligatures dans la construction navale antique méditerranéenne*, PhD thesis (dir. P. Pomey), Aix Marseille University, Aix-en-Provence (unpublished).
- Marlier, S., 2006, An example of experimental archaeology and the construction of a full-scale research model of the Cavalière ship's hull, in L. Blue, F. Hocker and A. Englert (eds), *Connected by the Sea. Proceedings of the Tenth International Symposium on Boat and Ship Archaeology (ISBSA 10)*, Roskilde 2003. Oxford, 43–49.
- Marlier, S., 2007, Les bateaux cousus et les assemblages par ligatures dans la construction navale antique méditerranéenne: une question de terminologie. *Empurios* 55, 9–25.
- Martinez Alcade, M., Garcia Cano, J. M., Blánquez Perez, J. and Iniesta Sanmartin, Á. (eds), 2017, *MAZARRÓN II. Contexto, viabilidad y perspectivas del barco B-2 de la bahía de Mazarrón. En homenaje a Julio Mas García*. Madrid.
- Mihovilić, K., 2013, *Histri u Istri. Željezno doba Istre / Gli Istri in Istria. L'età del ferro in Istria / The Histri in Istria. The Iron Age in Istria*. Pula: Monografije i katalozi 23.
- Müllner, A., 1892, Ein Schiff im Laibascher Moore. *Argo* I, 1–7.
- Negueruela, I., 2000, Descubrimientos de dos barcos fenicios, in M. Barthélemy and M.E. Aubet Semmler (eds), *IV Congreso Internacional de Estudios Fenicios y Púnicos, Cádiz 1995*, vol. IV, 1671–1679. Cádiz.
- Negueruela, I., 2005, 'Coagmenta punicana' e bagli. La costruzione navale a fasciame portante tra i Fenici del VII sec. a. C., in B.M. Giannattasio, C. Canepa, L. Grasso and E. Piccardi (eds), *Aequora, pontos, jam, mare... Mare, uomini e merci nel Mediterraneo antico, Atti del Convegno Internazionale, Genova 2004*, 22–41. Florence.
- Negueruela, I. and Ortiz, P., 2004, Hacia la comprensión de la construcción naval fenicia según el barco de Mazarrón 2 del siglo VII a. C., in V. Peña, A. Mederos and C. Wagner (eds), *La navegación fenicia. Tecnología naval y derroteros*, 227–278. Madrid.
- Negueruela, I., Pinedo, J., Gómez, M., Miñano, A., Arellano, L. and Barba, J.S., 1995, Seventh-century BC Phoenician vessel discovered at Playa de la Isla, Mazarrón, Spain. *IJNA* 24.3, 189–197.
- Nieto, X. and Foerster, F., 1980, El pecio romano del Cap del Vol (campañas de 1978 y 1979). *Cypsela* III, 163–177.
- Nieto, X. and Santos, M., 2008, *El vaixell grec arcaic de Cala Sant Vicenç*. Girona: Monografies del CASC 7.
- Nieto, X. and Santos, M., 2010, El barco griego arcaico de Cala Sant Vicenç, in P. Pomey (ed.), *Transferts technologiques en architecture navale méditerranéenne de l'Antiquité aux temps modernes: identité technique et identité culturelle, Actes de la Table Ronde, Istanbul 2007*, 45–55. Istanbul: Varia Anatolica XX.
- Panvini, R. (ed.), 2001, *La nave greca arcaica di Gela (e primi dati sul secondo relitto greco)*. Palermo.
- Panvini, R. and Tortorici, E., 2012, La rotta ed il carico, in D. Vullo (ed.), *La nave greca arcaica di Gela, dallo scavo al recupero*, 121–132. Palermo.
- Pâris, F.E., 1843, *Essai sur la construction navale des peuples extra-européens*. Paris.
- Pâris, F.E., 1892 (new edn 1990), *Souvenirs de marine conservés*, vol. 5. Paris.
- Polzer, M.E., 2010, The VIth-century B.C. shipwreck at Pabuç Burnu, Turkey: Evidence for transition from lacing to mortise-and-tenon joinery in late Archaic Greek shipbuilding, in P. Pomey (ed.), *Transferts technologiques en architecture navale méditerranéenne de l'Antiquité aux temps modernes: identité technique et identité culturelle, Actes de la Table Ronde, Istanbul 2007*, 27–44. Istanbul: Varia Anatolica XX.
- Polzer, M.E., 2011, Early shipbuilding in the Eastern Mediterranean, in A. Catsambis, B. Ford and D. Hamilton (eds), *The Oxford Handbook of Maritime Archaeology*, 349–378. New York.
- Pomey, P., 1981, L'épave de Bon-Porté et les bateaux cousus de Méditerranée. *The Mariner's Mirror* 67.3, 225–244.
- Pomey, P., 1985, Mediterranean Sewn Boats in Antiquity, in S. McGrail and E. Kentley (eds), *Sewn Plank Boats*, 35–47. Oxford: BAR Int. Series 276.
- Pomey, P. (ed.), 1987–1988, Recherches sous-marines. *Gallia Informations* 1, 2–78.
- Pomey, P., 1994, Prospection thématique, l'épave de la Jeaume-Garde B, in *Bilan scientifique du DRASSM 1993*, 44. Paris.
- Pomey, P., 1995, Les épaves grecques et romaines de la Place Jules-Verne à Marseille. *Comptes Rendus Académie des Inscriptions et Belles-Lettres*, avril-juin, 459–484.
- Pomey, P., 1996, Dendrochronologie des épaves antiques de Méditerranée. Épaves de la Roche-Fouras, de Cavalière, in *Bilan scientifique du DRASSM 1995*, 56–57. Paris.



- Pomey, P., 1997, Un exemple d'évolution des techniques de construction navale antique: de l'assemblage par ligatures à l'assemblage par tenons et mortaises, in D. Garcia and D. Meeks (eds) *Techniques et économie antiques et médiévales 'Le temps de l'innovation', Colloque international, Aix-en-Provence 1996*, 195–203. Paris.
- Pomey, P., 1998, Les épaves grecques du VI<sup>e</sup> siècle av. J.-C. de la Place Jules-Verne à Marseille, in P. Pomey and E. Rieth (eds), *Construction navale maritime et fluviale. Approches archéologique, historique et ethnologique, Actes du 7<sup>e</sup> Colloque International d'Archéologie Navale—Proceedings of the Seventh International Symposium on Boat and Ship Archaeology (ISBSA 7), ile Tatihou 1994*, 147–154. Paris, *Archaeonautica* 14.
- Pomey, P., 2001, Les épaves grecques archaïques du VI<sup>e</sup> s. av. J.-C. de Marseille: épaves Jules-Verne 7 et 9 et César I, in H. Tzalas (ed.), *Tropis VI. Proceedings of the 6th International Symposium on Ship Construction in Antiquity, Lamia 1996*, 425–437. Athens.
- Pomey, P., 2002a, Une nouvelle tradition technique d'assemblage antique: l'assemblage de la membrure par ligatures et chevilles, in H. Tzalas (ed.), *Tropis VII. Proceedings of the 7th International Symposium on Ship Construction in Antiquity, Pylos 1999*, vol. II-A, 597–604. Athens.
- Pomey, P., 2002b, Remarque sur la faiblesse des quilles des navires antiques à retour de galbord, in L. Rivet, M. Sciallano (eds), *Vivre, produire et échanger: reflets méditerranéens. Mélanges offerts à Bernard Liou*, 11–19. Montagnac.
- Pomey, P., 2003, Reconstruction of Marseilles 6th century BC Greek ships, in C. Beltrame (ed.), *Boats, Ships and Shipyards. Proceedings of the Ninth International Symposium on Boat and Ship Archaeology (ISBSA 9), Venice 2000*, 57–65. Oxford.
- Pomey, P., 2004, Principles and methods of construction in ancient naval architecture, in F.M. Hocker and C.A. Ward (eds), *The Philosophy of Shipbuilding. Conceptual approaches to the study of wooden ships*, 25–36. College Station, TX.
- Pomey, P., 2006, Les navires étrusques: mythe ou réalité? in *Gli Etruschi da Genova ad Ampurias, Atti XXIV Convegno di Studi Etruschi ed Italici, Marseille-Lattes 2002*, 423–434. Pisa-Rome.
- Pomey, P., 2008, Dimensions et tonnage, in X. Nieto and M. Santos (eds), *El vaixell grec arcaic de Cala Sant Vicenç*, 60–64. Girona: Monografies del CASC 7.
- Pomey, P., 2010, De l'assemblage par ligatures à l'assemblage par tenons et mortaises. Introduction, in P. Pomey (ed.), *Transferts technologiques en architecture navale méditerranéenne de l'Antiquité aux temps modernes: identité technique et identité culturelle, Actes de la Table Ronde, Istanbul 2007*, 15–26. Istanbul: Varia Anatolica XX.
- Pomey, P., 2011a, A Comparative Study of Sewn Boats from the Mediterranean, the Red Sea and the Indian Ocean. The question of Gujarat, in L. Varadarajan (ed.), *Gujarat and the Sea*, 133–146. Vadodara, Gujarat.
- Pomey, P., 2011b, Les conséquences de l'évolution des techniques de construction navale sur l'économie maritime: quelques exemples, in W.V. Harris and K. Iara (eds), *Maritime Technology in the Ancient Economy: Ship-design and Navigation*, 39–55. Rhodes Island: Journal of Roman Archaeology suppl. 84.
- Pomey, P., 2012, Le dossier de l'épave du Golo (Mariana, Haute-Corse). Nouvelles considérations sur l'interprétation et l'origine de l'épave. *Archaeonautica* 17, 11–30.
- Pomey, P., 2014, Le projet Prôtis. Construction de la réplique navigante d'un bateau grec du VI<sup>e</sup> siècle av. J.-C. *Comptes Rendus de l'Académie des Inscriptions et Belles-Lettres*, juillet–octobre, 1333–1357.
- Pomey, P., 2016, Determining an Architectural Family and its Evolution: The Example of the Greek Tradition of Sewn Shipbuilding in the Ancient Mediterranean, in *Studies of Underwater Archaeology* 2, 329–340. Beijing.
- Pomey, P., 2017a, The Prôtis project (Marseille, France). The construction of a sailing replica of an Archaic Greek Boat, in J. Gawronsky, A. van Holk and J. Schokkenbroek (eds), *Ships And Maritime Landscapes, Proceedings of the Thirteenth International Symposium on Boat and Ship Archaeology (ISBSA 13), Amsterdam 2012*, 484–489. Eelde.
- Pomey, P., 2017b, The Greco-Massaliot Shipwrecks in the Place Jules-Verne in Marseilles and the Evolution of Greek Ship Construction from the Sixth to the Fourth Century BC, in S. Bouffier and D. Garcia (eds), *Greek Marseilles and Mediterranean Celtic Region*, 263–279. New York.
- Pomey, P. 2017c, Ships and Shipping, in A. Naso (ed.), *Etruscology*, vol 1., 371–389. Boston, Berlin.
- Pomey, P. and Guibal, F., 2003, Dendrochronologie et dendromorphologie des épaves antiques de Méditerranée. Épave Dramont C, in *Bilan scientifique du DRASSM 1998*, 52–53. Paris.
- Pomey, P. and Long, L., 1992, Les premiers échanges maritimes du midi de la Gaule du VI<sup>e</sup> au III<sup>e</sup> s. av. J.-C. à travers les épaves, in *Marseille grecque et la Gaule, Actes du Colloque international d'Histoire et d'Archéologie et du Ve Congrès archéologique de Gaule méridionale, Marseille 1990*, 189–198. Aix-en-Provence: Etudes Massaliètes 3.
- Pomey, P. and Poveda, P., 2017, The Prôtis Project: the *Gyptis* sailing trials, in J. Litwin (ed.), *Baltic and beyond. Change and Continuity in Shipbuilding, Proceedings of the Fourteenth International Symposium on Boat and Ship Archaeology (ISBSA 14), Gdańsk, 2015*, 229–236. Gdańsk.
- Pomey, P. and Poveda, P., 2018, *Gyptis*: Sailing Replica of a 6th-century-BC Archaic Greek Sewn Boat. *IJNA* 47.1, 45–56.
- Pomey, P. and Rieth, E., 2005, *L'archéologie navale*. Paris.
- Pomey, P., Kahanov, Y. and Rieth, E., 2012, Transition from Shell to Skeleton in Ancient Mediterranean Ship-Construction: analysis, problems, and future research. *IJNA* 41.2, 235–314.
- Pomey, P., Kahanov, Y. and Rieth, E., 2013, On the transition from Shell to Skeleton. *IJNA* 42.2, 434–438.
- Poveda, P., 2012, *Le navire antique comme instrument du commerce maritime: restitution 3D, tonnages, qualités nautiques et calculs hydrostatiques des épaves Napoli A, Napoli C, Dramont E et Jules-Verne 7*, PhD thesis (dir. P. Pomey), Aix Marseille University, Aix-en-Provence (unpublished).
- Pulak, C., 1998, The Uluburun shipwreck: an overview. *IJNA* 27.3, 188–224.

- Pulak, C., 1999, The Late bronze Age shipwreck at Uluburun: Aspect of hull construction, in W. Phelps, Y. Lolos and Y. Vichos (eds), *The Point Iria wreck: Inter connections in the Mediterranean ca. 1200 BCE. Proceedings of the International Conference, Island of Spetses 1998*, 209–238. Athens.
- Radić Rossi, I., 2008, Caska–podmorje. *Hrvatski arheološki godišnjak/Croatian Archaeological Yearbook* **4/2007**, 371–373.
- Radić Rossi, I., 2010, Caska–podmorje. *Hrvatski arheološki godišnjak/Croatian Archaeological Yearbook* **6/2009**, 467–469.
- Radić Rossi, I., 2011, Caska–podmorje. *Hrvatski arheološki godišnjak/Croatian Archaeological Yearbook* **7/2010**, 483–487.
- Radić Rossi, I., and Boetto, G., 2010, Arheologija broda i plovidbe: šivani brod u uvali Caski na Pagu–Istraživačka kampanja 2009. / Archeologia navale: il relitto cucito nella baia di Caska sull'isola di Pag – Campagna di scavo 2009. *Histria Antiqua* **19**, 299–304.
- Radić Rossi, I. and Boetto, G., 2011, Šivani brod u uvali Caska na Pagu–Istraživačka kampanja 2010. / Il relitto cucito nella baia di Caska sull'isola di Pag – Campagna di scavo 2010. *Histria Antiqua* **20**, 505–513.
- Rieth, E., 1998, *Des bateaux et des fleuves. Archéologie de la batellerie du Néolithique aux Temps modernes en France*. Paris.
- Ruff, D., 2017, An Ancient Laced Boat in the Shadow of a Senatorial Estate. 2017 excavation of a Roman-era vessel in Croatia. *INA Quarterly* **44.1–2**, 18–23.
- Sabastia, A. and Formentin J.-Y., 2016, Note préliminaire sur l'architecture de l'épave Mèdes 6 (Hyères, Var, fin 2ème-début 1er siècle BCE). *Scientific Reports of Port-Cros National Park* **30**, 221–228.
- Sabastia, A. and Formentin J.-Y., 2017, Un premier bilan des recherches sur l'épave Mèdes 6 (Var, Hyères, 2ème-1er siècle BCE), un exemple de navire à membrures ligaturées du nord-ouest de la Méditerranée. *Scientific Reports of Port-Cros National Park* **31**, 289–297.
- Salemke, G., 1973, Die Ausgrabung eines Binnensee Transportschiffes. *Schiffsarchaeologia von 1890 aus Laidbach, Österreich (jetzt Ljubljana in Jugoslawia)*. *Das Logbuch* **9**, 1, 21–24.
- Steffy, J.R., 1985, The Kyrenia Ship: An Interim Report on its Hull Construction. *AJA* **89**, 71–101.
- Steffy, J.R., 1994, *Wooden Ship Building and the Interpretation of Shipwrecks*. College Station, TX.
- Steffy, J.R., 1995, Ancient Scantlings: The Projection and Control of Mediterranean hull-shapes, in H. Tzalas (ed.), *Tropis III. Proceedings of the 3rd International Symposium on Ship Construction in Antiquity, Athens 1989*, 417–428. Athens.
- Steffy, J.R., 1999, Ancient ship repairs, in H. Tzalas (ed.), *Tropis V. Proceedings of the 5th International Symposium on Ship Construction in Antiquity, Nauplia 1993*, 395–408. Athens.
- Tchernia, A., 2001, Eustathe et le rafirot d'Ulysse (*Od.* V), in J.-P. Brun and Ph. Jockey (eds), *Techniques et sociétés en Méditerranée. Hommage à M.-Cl. Amouretti*, 625–631. Paris.
- Tiboni, F., 2009, Chioggia. Località di Motta di Cavanella d'Adige. Le operazioni di scavo e primo studio di un relitto del II-I secolo a.C. *Quaderni di Archeologia del Veneto* **25**, 82–84.
- Tiboni, F., 2014, Letter to Editor. *IJNA* **43.1**, 198.
- Tiboni, F., 2017, The sewn boat from Cavanella d'Adige (Veneto, Italy). Excavation and first analysis, in J. Gawronsky, A. van Holk and J. Schokkenbroek (eds), *Ships and Maritime Landscapes, Proceedings of the Thirteenth International Symposium on Boat and Ship Archaeology (ISBSA 13), Amsterdam 2012*, 290–295. Eelde.
- Van Duivenvoorde, W., 2014, The 5th-century BC Shipwreck at Tetktaş Burnu, Turkey: evidence for the ship's hull from nail concretions. *IJNA* **43.1**, 10–26.
- Vitri, S., Bressan, F., Maggi, P., Dell'Amico, P., Martinelli, N., Pignatelli, O. and Rottoli M., 2003, Il relitto romano del fiume Stella (UD), in F. Lenzi (ed.), *L'Archeologia dell'Adriatico della Preistoria al Medioevo, Atti del Convegno Internazionale, Ravenna 2001*, 324–338. Florence.
- Vivar, G., de Juan, C. and Geli, R., 2014, Cap del Vol. Un producte, un barco y un comercio del *Conventus-Tarraconensis* en época de Augusto, in X. Nieto Prieto and M. Bethancourt Núñez (eds) *Arqueologia subacuática española. Actas del I Congreso de Arqueología Náutica y Subacuática Española, Cartagena 2013*, vol. I, 97–108. Cádiz.
- Vullo, D. (ed.), 2012, *La nave greca arcaica di Gela, dallo scavo al recupero*. Palermo.
- Wachsmann, S., 1998, *Seagoing ships and seamanship in the Bronze Age Levant*. College Station, TX.
- Ward, C., 2000, *Sacred and Secular: Ancient Egyptian Ships and Boats*. Philadelphia.
- Westerdahl, C., 2011, The maritime cultural landscape, in B. Ford, A. Catsambis, and D. Hamilton (eds), *The Oxford Handbook of Maritime Archaeology*. Oxford, 735–762.
- Wicha, S., 2002, Hérault. Au large d'Agade. Épave Baie de l'Amitié, in *Bulletin scientifique du DRASSM 2001*, 43–44. Paris.
- Wicha, S., 2004, Barthélemy B: un bateau antique détenant un assemblage original par ligatures végétales chevillées. Une tradition technique dont l'origine reste à déterminer. *Cahiers d'Archéologie Subaquatique* **XV**, 135–143.
- Wicha, S., 2005, Caractérisation d'un groupe d'épaves antiques de Méditerranée présentant un assemblage des membrures par ligatures végétales: Approche architecturale et paléobotanique. PhD thesis (dir. P. Pomey), Aix Marseille University, Aix-en-Provence (unpublished).
- Wicha, S. and Girard, M., 2006, Archaeological characterisation of three ancient, sewn, Mediterranean shipwrecks, in L. Blue, F. Hocker and A. Englert (eds), *Connected by the Sea, Proceedings of the Tenth International Symposium on Boat and Ship Archaeology (ISBSA 10), Roskilde 2003*, 111–116. Oxford.
- Willis, S. and Capulli, M., 2014, Putting the Pieces Together. The Laced Timbers of the Venice Lido III assemblage. *INA Quarterly* **41.4**, 10–13.
- Willis, S. and Capulli, M., 2017, The *Sutiles* Project: an investigation of Roman-era laced Vessels of the Upper Adriatic, the first two years of research, in J. Litwin (ed.), *Baltic and Beyond, Change and Continuity in Shipbuilding, Proceedings of the Fourteenth International Symposium on Boat and Ship Archaeology (ISBSA 14), Gdańsk 2015*, 147–150. Gdańsk.
- Willis, S. and Capulli, M., 2018a, A Report on the late 1st–2nd-century-AD Venice Lido III Sewn Timber Assemblage. *IJNA* **47.2**, 343–356.

- Willis, S. and Capulli, M., 2018b, Bottom up! The Corte Cavanella II boat and the laced boatbuilding tradition in the Northwestern Adriatic. *INA Quarterly* 45.1/2, 9–13.
- Womer Katzev, S., 2005, Resurrecting an Ancient Greek Ship: Kyrenia, Cyprus, in G.F. Bass (ed.), *Beneath the Seven Seas*, 72–79. London.
- Wylde Swiny, H. and Katzev, M.L., 1973, The Kyrenia shipwreck: a fourth-century BC Greek merchant ship, in D.J. Blackman (ed.), *Marine Archaeology*, 339–359. London: Colston Papers 23.