



HAL
open science

Long-term growth impact of climate change and policies: the Advanced Climate Change Long-term (ACCL) scenario building model

Claire Alestra, Gilbert Cette, Valérie Chouard, Rémy Lecat

► To cite this version:

Claire Alestra, Gilbert Cette, Valérie Chouard, Rémy Lecat. Long-term growth impact of climate change and policies: the Advanced Climate Change Long-term (ACCL) scenario building model. 2020. halshs-02505088

HAL Id: halshs-02505088

<https://shs.hal.science/halshs-02505088>

Preprint submitted on 11 Mar 2020

HAL is a multi-disciplinary open access archive for the deposit and dissemination of scientific research documents, whether they are published or not. The documents may come from teaching and research institutions in France or abroad, or from public or private research centers.

L'archive ouverte pluridisciplinaire **HAL**, est destinée au dépôt et à la diffusion de documents scientifiques de niveau recherche, publiés ou non, émanant des établissements d'enseignement et de recherche français ou étrangers, des laboratoires publics ou privés.

Long-term growth impact of climate change and policies: the Advanced Climate Change Long-term (ACCL) scenario building model

Claire Alestra
Gilbert Cette
Valérie Chouard
Rémy Lecat

WP 2020 - Nr 07

Long-term growth impact of climate change and policies: the Advanced Climate Change Long-term (ACCL) scenario building model¹

C. Alestra (Aix-Marseille University, CNRS, EHESS, Centrale Marseille, AMSE), G. Cette (Banque de France and AMSE), V. Chouard (Banque de France), R. Lecat (Banque de France)

10 March 2020

Abstract

This paper provides a tool to build climate change scenarios to forecast Gross Domestic Product (GDP), modelling both GDP damage due to climate change and the GDP impact of mitigating measures. It adopts a supply-side, long-term view, with 2060 and 2100 horizons. It is a global projection tool (30 countries / regions), with assumptions and results both at the world and the country / regional level. Five different types of energy inputs are taken into account according to their CO₂ emission factors. Full calibration is possible at each stage, with estimated or literature-based default parameters. In particular, Total Factor Productivity (TFP), which is a major source of uncertainty on future growth and hence on CO₂ emissions, is endogenously determined, with a rich modeling encompassing energy prices, investment prices, education, structural reforms and decreasing return to the employment rate. We present four scenarios: Business As Usual (BAU), with stable energy prices relative to GDP price; Decrease of Renewable Energy relative Price (DREP), with the relative price of non CO₂ emitting electricity decreasing by 2% a year; Low Carbon Tax (LCT) scenario with CO₂ emitting energy relative prices increasing by 1% per year; High Carbon Tax (HCT) scenario with CO₂ emitting energy relative prices increasing by 3% per year. At the 2100 horizon, global GDP incurs a loss of 12% in the BAU, 10% in the DREP, 8% in the Low Carbon Tax scenario and 7% in the High Carbon Tax scenario. This scenario exercise illustrates both the “tragedy of the horizon”, as gains from avoided climate change damage net of damage from mitigating policies are negative in the medium-term and positive in the long-term, and the “tragedy of the commons”, as climate change damage is widely dispersed and particularly severe in developing economies, while mitigating policies should be implemented in all countries, especially in advanced countries modestly affected by climate change but with large CO₂ emission contributions.

Keywords: Climate, Global warming, Energy prices, Government policy, Growth, Productivity, Long-term projections

JEL codes: H23, Q54, E23, E37, O11, O47, O57, Q43, Q48

¹ We would like to thank, without implicating, Katheline Schubert and participants of the “Economic models and tools against climate change” TSE-Banque de France-ACPR conference for their advice on the paper. We would like to warmly thank Thomas Laboureau for his preparatory work on the model. This paper does not necessarily represent the opinions of the Banque de France or the Eurosystem.

1. Introduction

The economic literature on climate change is currently undergoing substantial developments, from academics or government agencies, think tanks and supranational institutions.² Among the latter, the consequences of a global warming are analysed by the Intergovernmental Panel on Climate Change (IPCC) (see Masson-Delmotte et al., 2018) or for Europe by the European Commission (see Cescar, 2018). Indeed, climate change was recognised as a worldwide priority for the century, in particular with the ratification of the Paris Agreement (written at the COP 21, the 2015 United Nations Climate Change Conference) by no fewer than 185 parties (United Nations, 2015). This crucial issue thus presents strong implications for policy-making, notably regarding the carbon pricing strategy in terms of efficiency, equity or political acceptance for instance. A pigouvian tax on CO₂ emissions is often presented as the simplest and most efficient policy to reduce CO₂ emissions (see the synthesis from Gillingham and Stock, 2018). But if it is often considered as the first best to reduce CO₂ emissions, the first best from a welfare point of view could be the mix of such pigouvian tax and other policies as for instance regulation and norm setting (on these aspects, see Stiglitz, 2019).

Yet, the economic literature reveals a lack of consensus among economists and policy-makers concerning the impacts of climate change and the appropriate policies to face this risk. This lack of consensus partly explains the lack of coordinated ambitious policies. As underlined by Nordhaus (2019), *“Humans clearly have succeeded in harnessing new technologies. But humans are clearly failing, so far, to address climate change”*. This is why applied work is important to understand better the different mechanisms behind climate change and carbon taxation, along with the key area of disagreement among experts. Indeed, this field involves many challenges, as climate change is mainly considered as a macroeconomic and long-term concern (Schubert, 2018) with multiple spillover effects over space and time and regional disparities (in terms of emissions, exposure to global warming and climate risks, or political responses undertaken). Moreover, the environmental mechanisms are complex (with significant uncertainty, non-linearity or irreversibility) and the consequences of both the environmental policies and the climate phenomena are numerous.

The literature linking the environment and economic growth has undergone a noteworthy revival with the rising concerns about climate change and its potential adverse long-term consequences for the economy. Hence, the focus of environmental macroeconomics has shifted from the scarcity of natural resources to the negative consequences resulting from their use: the CO₂ accumulation in the atmosphere (Schubert, 2018). According to IPCC (2014), this accumulation accounts for three-quarter of global GHG emissions. Appropriate macroeconomic modelling framework have thus emerged to quantify the economic impacts of climate change, breaking down the different mechanisms at play from fuel use to final damage. Amongst them, the Integrated Assessment Models (IAMs, first and second generations), the Computable General Equilibrium (CGE) models, the Input-Output models, Agent-based models and the Macroeconometric models (for a recent overview of these models see the NGFS Technical Supplement, 2019 and Bolton et al., 2020).

The IAMs describe not only relationships between human activities and environmental processes but also between socio-economic systems and environmental systems. Thanks to their high level of aggregation, they are quite normative, simple and transparent. Consequently, they have aroused policy-makers' interest, as exemplified by the Quinet Commission (Centre d'analyse stratégique, 2008) or the Environmental Protection Agency and Change Division Council (2016) for respectively the French and the US governments. Indeed, they all aim at finding the optimal carbon taxation via the endogenous measure of the Social Cost of Carbon (SCC), using inter-temporal utility maximisation. Tol (2018) defined the SCC as the *“incremental impact of emitting an additional ton of carbon dioxide, or*

² In particular, a coalition of central banks, the Network for Greening the Financial System, is producing a vast array of documents supporting climate risk impact on financial stability.

the benefit of slightly reducing emissions". When it is estimated along an optimal emissions path, SCC is equivalent to the pigouvian tax (Pigou, 1920), namely the tax on CO₂ emissions that would maximise global welfare.

The most renowned IAM is Nordhaus' Dynamic Integrated Climate and Economy (DICE) model (1991, 1994, 2007, 2013, 2018). It consists of a macroeconomic module, modelling the relationship between the economic activity, the GHG emissions and the costs of their reduction (through an abatement curve) and a climate module, which links the rise in concentration of GHG emissions to the increase in world temperatures (that is, the climate sensitivity). The first module additionally translates temperature growth into economic damage (thanks to a damage function). It is extremely simple, with a unique consumer-producer at the world scale who has to choose between consumption, investment and decrease in CO₂ emissions. Nordhaus & Yang (1996) and Nordhaus & Boyer (2000) developed the RICE, a regional version of the DICE model with different inputs endowments (in labour, capital and energy) by geographic areas. Other examples of IAMs are the models DART (Deke et al., 2001) with a general equilibrium framework and the inclusion of agricultural productivity and sea level rise, WITCH (Bosetti et al., 2006, 2007, 2009) that considers non-cooperative behaviour between different regions, MERGE (Manne et al., 1995), PAGE (Hope, 2006) and FUND (Tol, 2005; Waldhoff et al., 2014).

The main criticisms of IAMs, as discussed by Pindyck (2013, 2017) are i) the climate sensitivity, which results from the link between GHG and temperature, ii) the welfare representation, and in particular its discount rate, iii) an exogenous rate of economic growth and iv) the specification of the damage function. According to Pindyck (2017), the selection of parameter values and functional forms for the damage functions used in IAMs can be misleading for policy-makers. In his view, some parameters and functional forms are arbitrarily calibrated (they lack of solid empirical foundations), although they are crucial for the model's properties and estimates. He thus highlighted our ignorance regarding the actual discount rate, the climate sensitivity and the damage function. Indeed, Golosov et al. (2014) show that a discount rate equal to 1.5% (Nordhaus, 1993) leads to a SCC of \$56.90 per ton of carbon, against a SCC of \$496 per ton of carbon with a discount rate of 0.1% indicating a high degree of solidarity with future generations (Stern, 2007).

On the contrary, CGE models are dynamic general equilibrium models that describe the economy as a system of monetary flows across sectors and agents, solving numerically combination of supply and demand quantities, as well as relative prices to clear the commodity and labour market simultaneously (NGFS technical Supplement, 2019). They are relatively large, complex, and follow a positive approach. They are based on input-output data from national accounts, as their representation is sectoral. They are not intended to find the optimal economic and environmental policy, but to comprehend and measure the outcomes of different policy choices. Hence, they do not use inter-temporal optimisation techniques but define an objective exogenously, as well as an emissions trajectory consistent with this target and finally, they infer the costs associated with the policy tool used to reach it. The OECD ENV-Linkages multi country by Chateau et al. (2014), the successor of the OECD GREEN model, is one example of a recursive dynamic neo-classical CGE model. It is linked to climate or environmental model to conduct an integrated assessment of the biophysical consequences of environmental pressure.

Another class of models are macroeconometric models (such as E3ME macroeconometric model by Cambridge Econometrics), which seek to identify dynamic relationship between economy supply and demand of energy.

Most of these models nonetheless face criticisms for their lack of transparency, as exposed by Landa Rivera and co-authors (2018) and require a careful trade-off between exhaustiveness, complexity and coherence.

Our contribution is to propose fully transparent and free-access model, the Advanced Climate Change Long-term model (ACCL), with a rich and endogenous modelling of the GDP growth dynamics. It could be classified in the Macroeconometric models family. It is a user-friendly projection tool, designed with R-Shiny, which allows the user to run scenario-analysis to identify and quantify the consequences of energy price shocks on TFP. The user can change at will all the hypotheses and parameters. For example, for the climate change analysis, we chose a default damage function derived from the meta-analysis of Nordhaus and Moffat (2017), but the user can easily change this function into another one. Thus, a sensitivity analysis can be carried out, in order to test, on a long-term horizon, the dependence of the results to each parameter and for different specifications. Besides, it also helps to understand the main economic and environmental mechanisms of both climate change and carbon taxation, as well as the reasons behind the current lack of consensus among economists. It can also be used in the context of stress test exercises by financial institutions.

In this model, we assess the long-run effects of carbon taxation on economic growth through two opposite channels. First, the negative consequences of carbon tax, or any other regulation increasing prices of CO₂-emitting energies, on growth via the impact of higher energy prices on Total Factor productivity (TFP). Then, the positive economic impact of limiting climate change consequences, through the abatement of carbon dioxide (CO₂) emissions (as the increase in the prices of CO₂-emitting energies has a deterrent effect on their consumption). As the net impact is most likely to be context dependent, it is also interesting to study the structural conditions under which one effect dominates the other.

To address this question, we build an original and extensive database that enables us to estimate or calibrate most of the relationships of the model. It gathers panel data for 19 developed countries and six emerging countries among the world greatest polluters, plus six regions to cover the rest of the world on many economic, energy and environmental variables (such as the employment rate, the average years of education, the market regulations, the relative price of energy or the CO₂ emissions...). We then use these empirical findings to implement-global and local projections for the whole world, decomposed in 30 countries and regions at the 2060 and 2100 horizons, allowing for user-designed scenarios of both climate change and carbon taxation.

This tool is based on a supply-side approach. Its main added value lies notably in the endogenous modelling of TFP, capital and Gross Domestic Product (GDP), together with the estimation and calibration of most of the relationships on an extensive panel of data. TFP, which is a major source of uncertainty on future growth, is determined by relative energy prices, investment prices, education, structural reforms and decreasing returns to the employment rate. The comparison of two distinct and broad time horizons (2060 and 2100), as well as the worldwide scale of the analysis enables us to examine the role played by both the time horizon and international coordination in the outcome of the climate policy. The climate policy assessed in this paper corresponds to a pigouvian tax on CO₂ emissions.

Indeed, differences in the results can be expected between 2060 and 2100, as climate change repercussions are more likely to occur in the long run, while the effects of the tax on prices are fairly immediate. Our results illustrate this “tragedy of the horizon” with net GDP losses induced by climate policies in the medium term, but a favourable net impact in the long term, thanks to the avoidance of greater climate damage. Similarly, we can presume that international coordination is of significant importance since pollution and the resulting climate change are global issues. A collective reduction of greenhouse gases (GHG) emissions would actually benefit a vast majority of countries. Yet, these social benefits can be neglected by national governments facing high individual costs to implement such a policy and fearing inaction by other emitters. Our simulations do show that for each country, the best individual strategy is a “Business As Usual” (BAU) one and stringent climate policies for others. Hence, the global best collective strategy would be the implementation of stringent climate policies

simultaneously in all countries. This coordination problem comes from the fact that a climate policy has a detrimental impact on GDP through TFP decrease in the country which implements it, but a favourable GDP impact through lower environmental damage for all countries. It means that the collective interest is the implementation of coordinated stringent policy, but that each country has interest to free-ride (for an analysis of the climate-related negotiation issues in the context of this free-riding problem, see Gollier and Tirole, 2015).

The rest of our paper is organized as follows. Section 2 describes the general framework of the ACCL tool. Section 3 presents the evaluation of the GDP before climate damage. Section 4 presents the endogenous evaluation of the global warming and of GDP damage from climate change. Section 5 proposes several climate scenarios, corresponding to business as usual country behavior or to the implementation of climate policies. Section 6 concludes.

2. Global framework for analysis

In this paper, we describe the ACCL flexible projection tool to simulate the impact of climate and structural policies on GDP. Climate or structural policies and their GDP impacts can be modelled at the country or regional level (see table A-1 country and region list in appendix). We adopt a supply-side approach and a long-term view. Indeed, at the 2060 and 2100 horizons which we chose, we can take into account solely a production function approach to GDP, assuming full capacity utilization and full adjustment of production factors to their optimum values. Short- and medium-term transition costs are only partly taken into account, as the consequences of climate policies are based on long-term estimates of the impact of energy prices on total factor productivity (TFP) and on energy consumption. Scenarios are only considering GDP damage, excluding quantification of other types of damage such as the deterioration of environmental assets (biodiversity...) and human health or welfare losses, apart from their indirect impact on GDP.

The projection tool is user-friendly and highly flexible, as both the underlying series and most parameters or even functional forms can be easily modified in the scenario building process. For instance, the price changes for each of the five types of energy, the substitution elasticities between these different types of energy or the functional form of the CO₂ sequestration equation can be designed by the user. Baseline specifications and scenarios are however proposed, based on estimated relationships, documented parameters and possible paths of the series.

Diagram 1 presents the overall scheme of the projection tool, which will be detailed in the following sections. The series (cf. table 1) defined in the scenario are in dark and resulting series are in blue. The main scenario inputs are the prices of the different types of energy relative to the GDP price. These series are meant to represent the policies that will impact the relative price of energy sources in order to curb energy consumption towards the least CO₂-emitting energy types. Scenarios are expressed relative to a baseline which may include fluctuations in energy price from non-regulatory sources. Typically, these policies would correspond to carbon taxes, which can be levied at any stage of their production process, but other types of regulation, such as sequestration constraints or quotas, can also increase the price of CO₂-emitting energy types.

The other inputs are directly and mainly related to the determination of TFP. Investment prices relative to GDP price are a proxy for technological change, and they impact GDP growth through two channels: a capital deepening process and a direct link with TFP. Average education years of the working age population both capture a quality dimension of human capital and the ability of the working force to incorporate new technologies; it is hence considered as a determinant of TFP. The employment rate is used both in the TFP equation and to compute the contribution of labour in the production function. In the TFP equation, it takes into account potential decreasing return to employment rates. Labour

contribution is computed on the basis of total hours worked in the economy, which is the product of hours worked per employee by the number of employees. Regulation, proxied by employment protection legislation and product market regulation, are a significant long-term determinant of TFP. Finally, capacity utilization rates are used in the short-term relationship of the TFP equation, but are not an input in the scenarios, which focus on long-term relationships.

The resulting series stem either from estimated or calibrated relationships. GDP is based on a Cobb-Douglas production function with two factors: capital and labour. As described above, TFP is estimated based on its structural determinants as well as on relative energy prices: relationship 1 of diagram 1 is the long-term estimates of TFP on all the series defined in the scenario mentioned above but regulations, which are used in relationship 2 as determinants of the country fixed effects estimated in relationship 1, and capacity utilization rate, which are used in short-run relationship 3. Labour is directly determined by the hypotheses on employment rates and hours worked. Assuming a long-run constant nominal ratio between the capital stock and GDP, as observed in the past, we can endogenise the dynamics of the capital stock from the path of TFP, labour and relative investment prices. Relationship 5 relates total energy consumption to relative energy prices and GDP. The decomposition of total energy consumption into consumption of the different energy types is based on the substitution elasticities between energy types, which are set as parameters of the scenarios (relationship 4 and 6). The lag structure of the estimation, based on the theoretical relationship between our series, allows the identification of our variables of interest at each of these stages. As energy prices influence the TFP level, our production function indirectly corresponds to one with three production factors, with an implicit substitution elasticity between energy and the other two factors not necessarily equal to one.

Consumption by energy types and by country/regions yields a path of the global CO₂ emissions and stock (relationship 7). As GHG emissions do not stem solely from energy consumption³, the path of GHG emissions assumes that non-energy greenhouse gas emissions change in the same proportion as energy GHG emissions. This assumes that mitigating policies similar to the carbon tax for fossil fuels are applied to all GHG emitting activities such as livestock farming. The relationship between the GHG stock and global temperature increase compared to the pre-industrial era (relationship 8) is calibrated on the Representative Concentration Pathway of the IPCC (2014). GDP damage from temperature increase is calibrated on Nordhaus (2017)' meta-analysis of studies and derived at the country/region level using OECD (2015) estimates as a distribution key. GDP damage is assumed to be non-linearly related with temperature increases (relationship 9). This encompasses many sources of non-linearity across our analysis, e.g. the risk that increases in GHG emissions beyond a threshold accelerates due to the melting of the permafrost. We assume that GDP damage from temperature increases does not affect the energy consumption stemming from GDP, as it results from it. Indeed, this damage may appear non-linearly through time and hence may not slow down energy consumption. This is one reason why we present our results in 2060 and 2100 solely, as the GDP path may be difficult to forecast, due to the uncertain timing of damage.

Relationships (1, 2, 3 and 5) are estimated on a sub-sample of advanced countries. They are used for other countries/regions, for which no existing or sufficiently long time-series are available. This may create a bias for emerging countries, which are further from the productivity frontier and for which some coefficients may be, compared to those estimated for advanced countries, higher (e.g. education) or lower (e.g. regulations).

³ According to FAO, total emissions from global livestock represent 14.5 percent of all anthropogenic GHG emissions, of which 80% is not related to fossil fuel consumption, and hence are not taken into account in our estimates of CO₂ emissions.

Diagram 1
Overall scheme of the projection tool

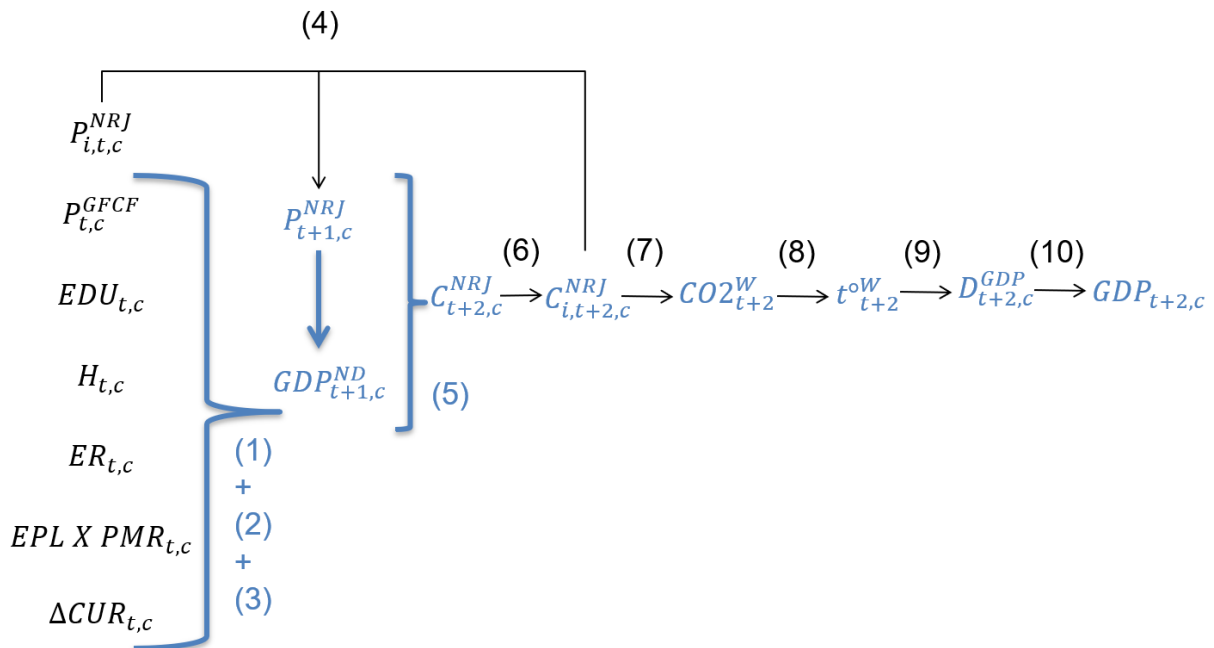

Subscript i energy, t for year and c for country; series defined in the scenario in dark and resulting series in blue; estimated relationship numbers in blue and calibrated or accounting ones in dark.

Table 1
Main series used in the scenario tool

Scenarios hypotheses

- $P_{i,t,c}^{NRJ}$: Relative energy prices
- $P_{t,c}^{GFCF}$: Relative investment price
- $EDU_{t,c}$: Mean years of education
- $H_{t,c}$: Average hours worked per employee
- $ER_{t,c}$: Employment rate
- $EPL * PMR_{t,c}$: Regulation index
- $\Delta CUR_{t,c}$: Change in Capacity utilization rates

Results from estimated, calibrated or accounting relationships

- $GDP_{t,c}$: Gross Domestic Product in volume and PPP 2010
- $C_{t,c}^{NRJ}$: Energy Final Consumption
- $CO2_t^W$: World CO₂ emissions
- t_t^{oW} : Increase in world temperature from pre-industrial era
- $D_{t,c}^{GDP}$: Damage to GDP from global warming in country c

3. Estimating GDP before damage

In our approach, energy consumption depends on GDP and on energy prices relative to GDP price. So, we need to simulate GDP level in the future to be able to evaluate the corresponding energy consumption.

3.1. Estimating GDP

The GDP evaluation is based on a supply-side model, at the country level. We assume a usual two-factor (capital and labour) Cobb-Douglas production function, with constant returns to scale, as in a large part of the literature (and for instance the DICE model from Nordhaus, 2017, 2018):

$$(1) \quad Q_{c,t} = TFP_{c,t} \cdot K_{c,t-1}^\alpha \cdot (N_{c,t} \cdot H_{c,t})^{1-\alpha}$$

Where c and t variable indexes indicate for which country c and which year t the variable is considered. Q is the volume of GDP, TFP the total factor productivity, K the volume of capital installed at the end of the year, N the employment, i.e. the number of workers, and H the average number of hours worked per year and per worker. α is the elasticity of output Q to capital K and we assume constant elasticity over time for all countries with the calibration: $\alpha = 0.3$ as in other studies (see for example Bergeaud *et al.*, 2016, or Fouré *et al.*, 2013, among others).

Relation (1) can be expressed in logs and growth rate terms:

$$(1') \quad \Delta q_{c,t} = \Delta tfp_{c,t} + \alpha \cdot \Delta k_{c,t-1} + (1 - \alpha) \cdot (\Delta n_{c,t} + \Delta h_{c,t})$$

where x corresponds to the logarithm of the variable X ($x = \log(X)$), and Δx is the usual approximation for the growth rate of X . ($\Delta k_{c,t-1} - \Delta n_{c,t} - \Delta h_{c,t}$) is the change of the capital intensity, which corresponds to the capital deepening mechanism.

To build a future long-term scenario, for each country c , employment N and working hours H are exogenous. The quantification of the volume of capital K and of the TFP is based on specific assumptions and relations.

3.2. Estimating the capital stock

Concerning K , the volume of capital, we assume that in the long term, at the potential path, the capital coefficient (ratio of capital divided by GDP) remains constant in nominal terms (cf. Cette, Kocoglu and Mairesse, 2005):

$$(2) \quad \Delta pq_{c,t} + \Delta q_{c,t} = \Delta pk_{c,t} + \Delta k_{c,t-1}$$

Where P_Q is the GDP price ($pq = \log(P_Q)$) and P_K the price of investment in fixed productive capital ($pk = \log(P_K)$).

As in Cette, Kocoglu and Mairesse (2005), we observe in nominal terms in the US a notable stability in the capital coefficient over the last few decades (Chart 1). The stability assumption, thus, seems realistic.

Chart 1

Capital coefficient, at current prices, in the US
(Ratio of capital stock to GDP in current prices)

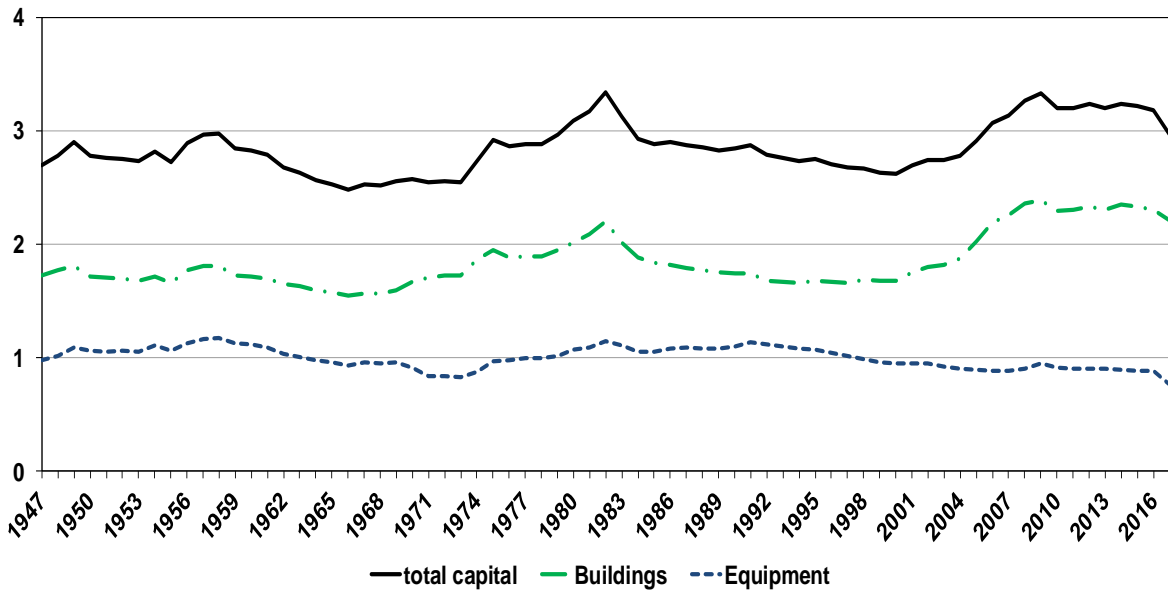

Source: Authors' calculation, from capital volume data (source: Bergeaud, Cette and Lecat, 2016, see www.longtermproductivity.com) and GDP volume and GDP and investment prices (source: US national accounts, BEA).

From relation (2), we obtain the relation (2'), which is used to build long-term capital scenarios:

$$(2') \quad \Delta k_{c,t-1} = \Delta pq_{c,t} + \Delta q_{c,t} - \Delta pk_{c,t}$$

We could assume a short-term over-decommissioning of capital due to the faster capital obsolescence triggered by environmental policy implementation. Such environmental policy could make obsolete some capital components quicker than previously expected without policy. Due to this short-term capital over-decommissioning, the capital growth rate could be lower than the growth rate given by relation (2'), for some time. But in our supply approach, the appropriate level of capital would not be changed in the long-term, which means that the transitory lower capital growth rate would be followed by an equivalent transitory higher capital growth rate, without any change in the long-term capital volume level. For this reason, as we consider climate policy impacts at a long-term horizon, we do not take into account the possible short-term impact of climate policy on the decommissioning rate.

3.3. Estimating *TFP*

Total factor productivity (*TFP*), estimated in log level, depends on several variables. We estimate in two steps the long-term relation and we add a short-term relation estimate.

In a first long-term step, the log of *TFP* is assumed to depend on the following variables:

- The log of the price of energy relative to the price of GDP. This corresponds to a substitution effect: if this relative price increases (resp. decreases), firms decrease (resp. increase) their intermediate consumption of energy and increase (resp. decrease) their use of labour and capital production factors, per unit of GDP. Everything else being equal, this corresponds to a decrease (resp. increase) of the *TFP*. Then, we expect a negative coefficient for this variable. Our choice of specification

corresponds to that included in several models (and for instance the DICE model, see Nordhaus, 2018, for a recent presentation). An alternative could have been to specify a three-factor production function (as Fouré *et al.*, 2013, among numerous others, see this paper for a survey). Implicitly, our specification is equivalent to such a three-factor production function: the coefficient of the relative price of energy can be considered as equivalent (in absolute value) to an implicit substitution elasticity between energy and the combination of the two other factors (labour and capital). This impact on TFP, which relies on a substitution effect within the production function, is estimated on past energy price hikes, which did not involve any redistribution of the proceed of the increase. Carbon tax levies may be redistributed and give rise to supply-side effects. Yet, these effects can be entered in the projection through other hypotheses or at other stages.

- The log of investment price relative to GDP price. This corresponds to a technical progress effect: if this relative price decreases (resp. increases), it means that the same capital value corresponds to higher (resp. smaller) volume and production capacity, which could go with technical progress implying at the same time *TFP* improvement (resp. deterioration). The underlying idea is that quality improvements in investment in terms of productive performance are at least partly incorporated into the measurement of investment prices in national accounts through hedonic or matching methods. This is mainly done for ICT since this investment benefits more than others from performance improvements (for a summary on these aspects, see Cette, Kocoglu and Mairesse, 2005; Byrne, Oliner and Sichel, 2013; and Byrne, Fernald and Reinsdorf, 2016). So, the gains in capital performance impact both investment prices and *TFP*. This means that technical progress decreasing the relative investment price impacts *GDP* level and growth through two channels. First, a capital deepening channel, the same capital nominal value corresponding to a higher capital volume and then to a higher production capacity. This channel is taken into account by the previous relation (2'). Second, a *TFP* improvement channel, which is taken into account by *TFP* relation (3). The respective shares of these two channels depend mainly on how much the productive performance gains of investment are incorporated in the investment price indexes by national accounts. Thus, we expect a negative coefficient for this relative investment price variable in the *TFP* relation, which corresponds to the second mentioned channel.
- The average years of schooling in the working age population, to take into account the contribution of education to the quality of labour input. This contribution is calibrated at a 5% return by year of schooling, estimated in Bergeaud, Cette and Lecat (2018) on the same database. This return falls within the range of estimates of “Macro-Mincer” equations such as Soto (2002), Cohen and Soto (2007) and Barro and Lee (2010).
- The employment rate that displays decreasing returns because less productive workers are more than others recruited (resp. fired) as the employment rate increases (resp. decreases). This impact is estimated in other studies (see Boursès and Cette, 2007, or Aghion *et al.*, 2009, for surveys and estimates) and the related coefficient is expected to fall within the range -0.75 to -0.25.

Thus, the estimated relation is the following:

$$(3) \quad tfp_{c,t} = \alpha_1 \cdot [pen - pgdp]_{c,t-1} + \alpha_2 \cdot [pinv - pgdp]_{c,t-1} + 0.05 \cdot EDUC_{c,t-1} + \alpha_4 \cdot ER_{c,t-1} + FE_c + \alpha_T \cdot I_{T,t} + \alpha_0 + \varepsilon_{c,t}$$

Where *pen*, *pgdp* and *pinv* correspond to the log of energy, *GDP* and investment price indexes, *EDUC* is the average years of schooling, *ER* is the employment rate. The indexes *c* and *t* (or *t-1*) indicate the country and the year. FE_c is a country fixed effect. As there is a general intercept (α_0), there is no fixed effect for one of the countries, which is here the US. $I_{T,t} = \text{Max}(0; t-T)$ are variables which allow us to take into account some possible *tfp* common trend breaks for all countries in our sample starting from different years *T*.

This relation (3) is estimated using the OLS method on a panel of 19 developed countries⁴ over the period 1980-2017. Table 2 and chart 2 present the estimate results.

Table 2
Long-run Regression of the Log Total Factor Productivity

	(1)	(2)	(3)	(4)	(5)	(6)
	1980 2017	Different breaks	Without break nor country FE	Without country FE	Without ER	With education not constrained
Log Relative Price of Energy (t-1)	-0.023* (0.011)	-0.027* (0.012)	-0.017 (0.029)	-0.263*** (0.025)	-0.009 (0.011)	-0.088*** (0.010)
Log Relative Price of Investment (t-1)	-0.370*** (0.041)	-0.394*** (0.041)	-0.442*** (0.070)	0.762*** (0.073)	-0.392*** (0.042)	-0.222*** (0.034)
Education (t-1) (constrained)	0.050 (.)	0.050 (.)	0.050 (.)	0.050 (.)	0.050 (.)	-0.057*** (0.006)
Employment Rate (t-1)	-0.401*** (0.073)	-0.393*** (0.074)	-0.552*** (0.107)	-1.088*** (0.083)		-0.489*** (0.060)
Log Average Hours Worked (t-1)						
Break in 1985	0.007*** (0.000)			0.017*** (0.001)	0.006*** (0.000)	0.014*** (0.001)
Break in 1987		0.007*** (0.000)				
Break in 2011		-0.009*** (0.002)				
Break in 2012	-0.011*** (0.003)			-0.014 (0.007)	-0.009** (0.003)	-0.015*** (0.002)
Country FE	Yes	Yes	No	No	Yes	Yes
Observations	672	672	672	672	672	672
R^2						0.9622
Adjusted R^2						0.9608

Standard errors in parentheses

All regressions are weighted by countries' Gross Domestic Product

Constant included but not reported

ER: Employment Rate

Country FE: Country Fixed Effects (with respect to the United States)

* $p < 0.05$, ** $p < 0.01$, *** $p < 0.001$

⁴ These countries are Australia, Austria, Belgium, Canada, Switzerland, Germany, Denmark, Spain, Finland, France, United Kingdom, Italy, Japan, The Netherlands, New-Zealand, Portugal, Sweden, the United States.

Chart 2

Country Fixed Effects of the Long-Run Estimate (column 1 of table 2)

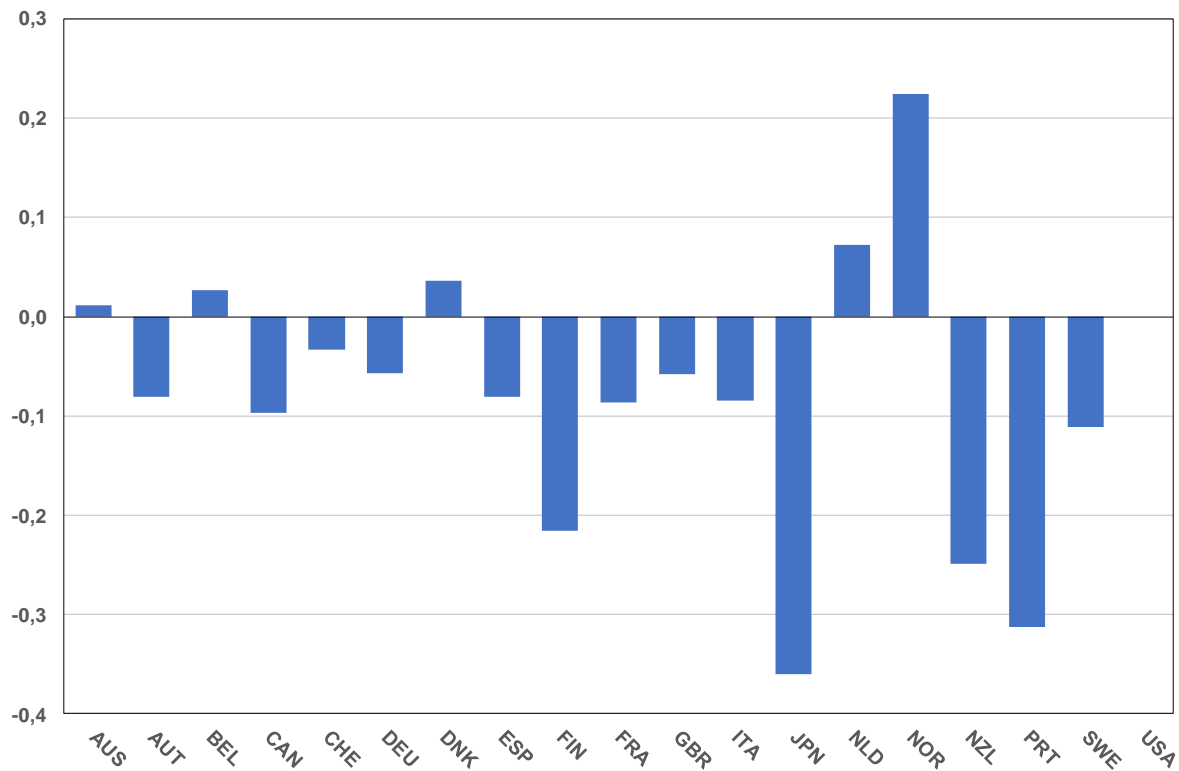

Our favourite estimate corresponds to column 1 of Table 2. All coefficients have the expected sign. A decrease by one percent of the relative price of energy or of investment would decrease the *TFP* by, respectively, 0.02% and 0.37%. Two global *TFP* trend breaks are estimated, a positive one in 1985 just at the starting point of a largely synchronised global growth recovery, and a negative one in 2012 after the financial crisis. The country fixed effects are non-significantly different from 0 in Australia, Belgium, Switzerland and Denmark, which means that in these four countries, everything else being equal, the *TFP* level is about the same as the US one. In the other 14 countries, the fixed effects are negative and significant which means that in these countries, the *TFP* levels are, everything else being equal, inferior to the US one.

Slight changes in the dates of the *TFP* trend breaks (column 2) have limited impacts on the estimate results but increase the impact of investment relative price on *TFP*. Without *TFP* global trend breaks (column 3), the sign of the relative price of energy changes and becomes non-plausible. Constraining the coefficients of the employment rate only raises the impact of the relative price of investment on *TFP*. Dropping employment rate from the explanatory variables (column 4) makes the estimate of the relative price of energy non-significant and has only a slight impact on the other estimated coefficients. Dropping the country fixed effects (column 5) changes the sign of the estimated coefficient of the relative investment price, which becomes non-plausible, as their average levels may capture country unobserved fixed effects. To estimate and not to constrain the coefficient of education (column 6) only impacts the magnitude of the other estimated coefficients, but the estimated education coefficient appears positive and so, non-plausible compared to what we get from the literature.

In a second long-term step, we estimate the impact of regulations on labour and product market on the *TFP* level. A large body of literature investigates the productivity impact of product and labour market imperfections, and of the anti-competitive regulations establishing and supporting them (see Aghion and Howitt, 2009, and Cetto, Lopez and Mairesse, 2018, for surveys). As shown in numerous

papers, this impact could be large (see for instance Cette, Lopez and Mairesse, 2016, 2018). Country fixed effects estimated in the previous relation capture all the factors that may structurally impact *TFP* and are not explicitly taken into account in relation (3), for instance regulation, the quality of management, corruption, etc. For simulations on a long-term horizon, it seems important to take into account the possible impact of structural reforms aiming at decreasing labour and product market regulations, in particular in countries where they are the most stringent.

The estimated relation is the following simple one:

$$(4) FE_c = \beta_1 \cdot REGUL_c + \beta_0 + \varepsilon_c$$

Where $REGUL_c$ corresponds to the chosen regulation indicator. A negative sign is expected for the coefficient β_1 .

Several types of regulation indicators built by the OECD have been tried. As there is no time dimension in the estimates, and taking into account the availability period of the OECD indicators, we have used the average level of the regulation indicators over the period 1998-2013. These indicators are based on detailed information on laws, rules and market settings. The OECD product market indicators (here *PMR* for Product Market Regulations) aim to measure to what extent competition and firm choices are restricted when there is no *a priori* reason for government interference (see Koske et al., 2015). They take into account different domains, as state control or barriers to entry. The OECD EPL (Employment Protection Legislation) indicator aims to measure the procedures and costs involved in dismissing individual workers with regular contracts and workers on temporary contracts (see OECD, 2013, for more information).

The best results have been obtained on crossed product and labour regulation indicators, which correspond to the idea of a possible complementarity between the *TFP* impacts of these two types of indicators. Some estimate results are presented in Table 3. As expected, regulations have a negative impact on *TFP* through the estimated fixed effects. Our favourite estimate is presented in column 1. Concerning *PMR*, it focuses on barriers to trade and investment, and concerning *EPL* it takes into account only regulations on individual dismissals. This estimate was preferred to the others because the fields of its regulation indicators are larger than the ones of the other estimates. This makes it easier to build some structural reform scenarios over a long period from these results. Moreover, the relationship appears non-significant when concentrating only on the Energy, Transport and Communication Regulations (*ETCR*) for the product market regulations.

Table 3

Regression of the Country Fixed Effects on Average Regulations

	(1) Country FE on EPL and PMR	(2) Country FE on EPL and PMR	(3) Country FE on EPL and ETCR	(4) Country FE on EPL and ETCR
EPL_ID × PMR_BTI	-0.108* (0.042)			
EPL_IDTC × PMR_BTI		-0.130* (0.055)		
EPL_ID × ETCR_ABPO			-0.009 (0.007)	
EPL_ID × ETCR_EB				-0.010 (0.007)
Observations	18	18	18	18
R^2	0.2902	0.2605	0.0890	0.1006
Adjusted R^2	0.2459	0.2143	0.0320	0.0444

Standard errors in parentheses

Average regulations computed for the time period 1998-2013

Constant included but not reported

Country FE: Country Fixed Effects (With respect to the United States)

EPL: Employment Protection Legislation

ETCR: Energy, Transport and Communication Regulations

PMR: Product Market Regulations

EPL_ID: EPL (individual dismissals), EPL_IDTC: EPL (individual dismissals temporary contracts)

ETCR_EB: ETCR (entry barriers), ETCR_ABPO: ETCR (all but public ownership)

PMR_BTI: PMR (barriers to trade and investment)

* $p < 0.05$, ** $p < 0.01$, *** $p < 0.001$

Finally, a short-term error correction model (ECM) relation has been estimated, based on residuals coming from the long-term estimate. Several estimates were tried, corresponding to the following relation:

$$(5) \quad \Delta t f p_{c,t} = \mu_1 \cdot LTR_{c,t} + \mu_2 \cdot \Delta t f p_{i,t-1} + \mu_3 \cdot \Delta CUR_{i,t} + FE_c + \varepsilon_{c,t}$$

where LTR corresponds to the residuals which come from the two long-term step estimates and CUR to the capacity utilization rate. We expect a negative value for μ_1 and positive ones for μ_2 and μ_3 .

Some estimate results are presented in Table 4. Our favorite estimate is in column 1. It indicates that each year about 3% of the residual of the previous year is corrected. Some inertia appears in TFP growth, as indicated by the significant coefficient of the auto-regressive term. Variations of the capacity utilization rate impact the TFP short term growth almost one for one. Fixed effects do not appear to be significant (column 2).

Table 4

Short-run Regression of the Log Total Factor Productivity

	(1)	(2)	(3)	(4)	(5)	(6)
	1980 2017	With country FE	With employment rate	Without autoregressive term	Without CUR	Without CUR nor autoregressive term
Long-run Regression Residuals (t-1)	-0.034*** (0.009)	-0.029** (0.009)	-0.029*** (0.009)	-0.031*** (0.009)	-0.044*** (0.009)	-0.042*** (0.010)
Delta Log Total Factor Productivity (t-1)	0.157*** (0.033)	0.129*** (0.033)	0.200*** (0.034)		0.233*** (0.036)	
Delta Capacity Utilisation Rate	0.834*** (0.060)	0.849*** (0.060)	0.934*** (0.063)	0.886*** (0.060)		
Delta Employment Rate			-0.265*** (0.058)			
Country FE	No	Yes	No	No	No	No
Observations	675	675	675	675	709	709
R^2	0.2894	0.3099	0.3105	0.2647	0.0812	0.0254
Adjusted R^2	0.2862	0.2877	0.3064	0.2625	0.0786	0.0240

Standard errors in parentheses

Constant included but not reported

country FE: country Fixed Effects (with respect to the United States)

CUR: Capacity Utilisation Rate

* $p < 0.05$, ** $p < 0.01$, *** $p < 0.001$

As our simulation will be built over a very long period (with a horizon of 2060 or 2100), this short-term relation will not be used and simulations will be based only on the two long-term relations presented above.

4. From GDP without damage to global warming and GDP climate damage

In the previous section 3, we have depicted our methodology to estimate the Gross Domestic Product (*GDP*) relationship for our countries and regions of interest, used to calculate the *GDP* projections over the 2060 and 2100 time horizons. This section 4 will now detail the different steps of the computation of our simulations to assess the economic damage consequences induced by climate change, around the world for these time horizons.

We first derive the Total Final Consumption (*TFC*) of energy, at the national and regional levels, from the projections of *GDP* and Relative Prices of Energy (*RPE*) calculated beforehand. Then, we break down this consumption by energy type, which enabled us to translate it into aggregate carbon dioxide emissions. These emissions increase the world stock of cumulative CO_2 emissions, from which we finally obtain the global temperature change and its adverse consequences on *GDP* until 2060 and 2100 for our countries and regions of interest.

4.1. Calculation of the Total Final Consumption of energy

To compute the *TFC* of energy of each country or region until 2060 and 2100 (*i.e.* the area's aggregate energy consumed by end users for all types of energy), we start by estimating the relationship between the *TFC* and the previous *GDP* and *RPE*, on historical data for the most developed countries. Here, the *TFC* is thus considered as a proxy for energy use. Again, we chose to conduct the regression on these

countries, as we need relatively long time series for the estimate, while we only need a few data points for the rest of the world on which we apply the estimated coefficients to uptake the projections.

We thus build a panel database from 1980 to 2015 for 18 countries, using past data on the *TFC* of energy, in thousand tons of oil equivalent (*ktoe*) on a net calorific value basis, drawn from the IEA (International Energy Agency) Headline Global Energy Data (2017). We conduct the logarithmic regression detailed in the equation 6. The results are summarised in the Table 5. The first column displays our main estimates, while the three others are robustness checks, which demonstrate that our relationship holds (the price coefficient only slightly changes) when adding a trend variable or constraining the GDP elasticity to be equal to one.

$$(6) \quad tfc_{c,t} = \mu_1 \cdot gdp_{c,t-1} + \mu_2 \cdot rpe_{c,t-1} + \mu_0 + \varepsilon_{c,t}$$

Where *tfc* is the log of the total final consumption of energy, *gdp* the log of the Gross Domestic Product, *rpe* the log of the relative prices of energy, and ε the error term, for countries (or regions) *c* and year *t*.

Table 5
Regression of the Log of Total Final Consumption of energy

	(1)	(2)	(3)	(4)
	1980-2015	With trend	With unitary GDP elasticity	With unitary GDP elasticity, with trend
Log Gross Domestic Product (t-1)	0.965*** (0.009)	0.979*** (0.009)	1.000 (.)	1.000 (.)
Log Relative Price of Energy (t-1)	-0.670*** (0.058)	-0.544*** (0.057)	-0.681*** (0.058)	-0.543*** (0.057)
Trend		-0.009*** (0.001)		-0.010*** (0.001)
Observations	636	636	636	636
R^2	0.9481	0.9534		
Adjusted R^2	0.9480	0.9532		

Standard errors in parentheses

Constant included but not reported

GDP: Gross Domestic Product

country FE: country Fixed Effects (with respect to the United States)

* $p < 0.05$, ** $p < 0.01$, *** $p < 0.001$

Corroborating our expectations, we find a positive relationship of the log of the total final consumption of energy with the log of the lagged *GDP* and a negative one with the log of the lagged relative prices of energy, both with an elasticity less than unity. Hence, an increase of the past *GDP* by 1% should raise energy final consumption by 0.97%, while a similar growth of the energy relative prices should reduce energy final consumption by 0.67%, all other things being equal. The sign and magnitude of this first coefficient are similar to what can be found in the literature, for instance Csereklyei, Rubio-Varas and

Stern's paper (2016), which estimates the logarithmic relation between energy consumption and *GDP per capita*. The negative elasticity of energy consumption to its price reflects efficiency gains in energy consumption due to substitution of products with high energy content to products with low energy content or energy saving technologies. In the past decades, following the two oil shocks of the 1970s, energy efficiency significantly increased, in particular thanks to energy-saving technological innovation.⁵

Applying these coefficients to our projections of *GDP* (computed following the methodology described in the previous section) and of Relative Price of Energy enabled us to derive the TFC of energy for our 18 countries, as well as for the rest of the world, at the 2060 and 2100 time horizons.

4.2. Computation of the Relative Price of Energy

The Relative Price of Energy (*RPE*) is derived from the relative prices of each types of energy weighted by their respective shares in the total consumption of energy.

$$RPE_{c,t} = \sum_i [RPE_{c,i,t} \times \Omega_{c,i,t}] \text{ where } \Omega_{c,i,t} = \frac{TFC_{c,i,t}}{TFC_{c,t}}$$

Where Ω_i is the share of the energy of type i in the total volume of the final consumption of energy. Data on energy prices come from the IEA Energy Prices and Taxes database, second quarter 2018: we chose a nominal index of total energy end-use prices (taxation included) for both industry and households, covering all types of energy, with the base year 2010. To calculate the relative prices of energy, we divide these data by the *GDP* deflator (index base 2010) from the OECD Economic Outlook (2018) database. The next subsection details how the different Ω_i are obtained.

4.3. Determining the shares of energy consumption by energy types

We distinguish five distinct types of energy: coal, oil, natural gas and electricity that is derived from both "dirty" (CO₂ emitting) and "clean" (non- CO₂ emitting) energy inputs.⁶ Their respective shares in the total final consumption of energy are computed using the equation (7).

$$(7) \quad \Delta\Omega_{c,i,t} = \Omega_{c,i,t-1} \cdot \sum_j [\Omega_{c,j,t-1} \cdot \sigma_{i,j} \cdot (\Delta rpe_{c,j,t} - \Delta rpe_{c,i,t})]$$

Where Δ is the variation within the time interval considered and $\sigma_{i,j}$ the pairwise elasticities of substitution between energy types, for all the various energy sources $i \neq j$ (see table A-2 in appendix).

We select estimates of the pairwise substitution elasticities between coal, oil, natural gas and electricity from David Stern's meta-analysis (2009), along with Papageorgiou *et al.* (2017) appraisal for the elasticity of substitution between "clean" and "dirty" electricity inputs. Therefore, knowing the projections of the *TFC* of energy, the past shares of each energy type in the final consumption, the substitution elasticities between energy types and the average annual growth rates of the projected relative prices of each energy type, we found the amount consumed for each energy source, until 2100, at the national and regional scales.

⁵ Since the onset of the commercial aircraft business, the consumption of fuel by passenger-kilometre has been reduced by half, in particular through the improvement of the energy efficiency of engines.

⁶ As dirty means here CO₂ emitting, we consider the nuclear electricity production as a clean one, which could of course be contested from other dimensions.

4.4. Converting energy consumption in CO₂ emissions

The next step presents the breakdown of the *TFC* by energy types, in order to obtain the quantities consumed for each of them: coal, oil, natural gas and electricity that is derived from both “CO₂-emitting” and “non CO₂-emitting” energy inputs. To do so, we apply the shares Ω_i calculated with equation (7) to the *TFC* resulting from equation (6).

In order to consider the economic consequences of climate change, this final consumption of energy has to be translated into global carbon dioxide emissions (according to the equation 8), that will, in turn, be expressed in a worldwide stock of cumulative CO₂ emissions (see equation 9).

$$(8) \quad CO2_t = \sum_{i,c} TFC_{i,t,c} \cdot \gamma_i$$

Where *CO2* is the world carbon dioxide emissions (in tonnes of CO₂) and γ_i the default emissions factors for the energy of type *i* (see table A-3 in appendix).

Projected emissions have thus been computed based on the past levels of total emissions from all sources adjusted by the yearly change in energy emissions, computed as the sum, across countries and energy sources, of the energy consumptions by energy type, weighted by their corresponding emissions factor. This implies that emissions stemming from non-energy sources such as animal husbandry are supposed to increase in a similar proportion as emissions from energy consumption and hence, that regulations preventing greenhouse gas emissions evolve in a similar way across sectors. Historical data on total CO₂ emissions arisen from fuel combustion, in million tons of carbon dioxide (Mt of CO₂), have been drawn from the *IEA Headline Global Energy Data* (2017). Default emission factors for fossil fuels and - both “CO₂-emitting” and “non-CO₂-emitting” - electricity have been collected from the *CoM* (Covenant of Mayors for Climate and Energy) report (2017).

4.5. The assessment of a global stock of cumulative CO₂ emissions

In this section, we use a simplified carbon cycle constituted by using the Permanent Inventory Method (PIM) to model the increase of the worldwide stock of carbon dioxide by the aggregate CO₂ emissions previously computed. This approach is a reduced picture of the complexity of the carbon cycle but the flexibility of our tool offers the user the possibility to take account other climate-experts modelling of the carbon cycle.⁷ Our PIM is depicted by the accounting relation (9):

$$(9) \quad StockCO2_t = (1 - \rho_1) \cdot StockCO2_{t-1} + (1 - \rho_2) \cdot CO2_t - \rho_3_t$$

Where *StockCO2* represents the aggregate cumulative carbon dioxide emissions (in giga tonnes of CO₂), *CO2* the world carbon dioxide emissions (converted in giga tonnes of CO₂), whereas ρ_1 and ρ_2 are the coefficients of CO₂ sequestration by the carbon sinks of the planet (*i.e.*, natural or artificial reservoirs capturing atmospheric CO₂) as a fix proportion of the stock or of the emissions and ρ_3 another type of possible CO₂ sequestration independent to both emissions and stock of CO₂. This parameter allows also the user of our software to introduce some non-linearity in CO₂ emissions, coming from specific shocks. For instance, the large possible CO₂ emissions from permafrost if the temperature increase exceeds some threshold. Historical data for the stock of carbon dioxide are obtained from the world cumulative 1751–2014 gigatonnes of CO₂ in Boden, Marland and Andres (2017). It appears to be no consensus in the scientific literature on the optimal way to model carbon

⁷ For a comprehensive review of the carbon cycle see Joos et al. (2013) for IPCC (2014).

dioxide sequestration, as well as on the precise value of its estimate. Therefore, we offer the user the possibility to choose and modify as will the coefficients of these three widespread specifications. By default, ρ_1 and ρ_2 are null as we set a fixed amount of annual CO₂ sequestration that is equals to a third of the 2016 carbon dioxide emissions.

4.6. Translating the stock of carbon dioxide in temperature rise

In the next step, we convert the resulting projections of CO₂ emissions stock in a global warming of the Earth. Literature is not consensual concerning this relation, as shown by the large surveys from Matthews *et al.* (2018) or Hsiang and Kopp (2018). We adopt the linear relationship reported below. This relationship between global temperature changes and carbon dioxide cumulative emissions has been calibrated using the RCP (Representative Concentration Pathway) 8.5 scenario (IPCC, 2014).

$$(10) \quad Temp_t = \eta_1 \cdot StockCO2_t$$

Where $Temp$ is the increase in world temperatures from the pre-industrial era (in degree Celsius) and $\eta_1 = 0.0008$.

4.7. Global and regional climate-induced GDP damage

Different types of damage can result from higher temperatures (see for instance Hsiang and Kopp, 2018, for a presentation of these different types of damage and their different country impact). Evaluation of damage from climate change suffer from large uncertainties (see for a synthesis Auffhammer, 2018). We consider them only in their direct or indirect GDP dimension. In the ACCL tool, uncertainties concerning this GDP damage are taken into account by allowing the user to change the coefficient linking temperature changes to GDP damage.

Equation (11) describes how we finally obtain the economic damage generated by climate change, defined as “the fractional loss in annual economic output at a given level of warming compared to output in the same economy with no warming” (see Covington & Thamotheram, 2015).

$$(11) \quad D_{c,t}^{GDP} = D_t^{GDP} \cdot \frac{\omega_c}{\omega}$$

With $D_t^{GDP} = \theta_1 \cdot Temp_t + \theta_2 \cdot Temp_t^2 + \theta_3 \cdot Temp_t^4$

Where D^{GDP} are the climate-induced damage as a percent of GDP , ω_c and ω respectively the OECD (2015) regional and aggregate coefficients of climate induced damage (see table A-4 in appendix).

The world damage hence follows a fourth degree equation with the temperature rise. Following the DICE model from Nordhaus, 2017, 2018, we use a quadratic relationship ($\theta_3 = 0$), but the user can model tipping points in the damage function through θ_3 , by assuming $\theta_3 < 0$ ⁸. Our default estimates ($\theta_1 = 0.38$ and $\theta_2 = -0.48$) are based on Nordhaus and Moffat’s survey (2017). They reviewed 36 estimates from 27 papers and concluded, using a statistical method, that a 3°C temperature increase (in comparison with pre-industrial levels) would diminish income (computed as a percentage of global aggregate GDP) by 2.04% (+ or - 2.21), while a 6°C warming scenario would imply a reduction of GDP by 8.06% (+ or - 2.43), with respect to a scenario without global warming. This worldwide damage is then broken down into local damages using the share of the OECD (2015) regional coefficients of

⁸ In the DICE 2016 version, the convexity of this damage relation is in fact assumed to be slightly higher than a quadratic function, the power of the variable $Temp$ being equal to 2.6 (see Nordhaus, 2018).

climate-damage (ω_c) in the OECD (2015) aggregate coefficient of climate induced damage (ω)– both at the 2060 horizon of the OECD study-, as a distribution key.

The next section of this paper will present the projection tool we developed as a user-friendly web application, along with the simulation of four contrasted climate change scenarios.

5. Global warming scenarios

The ACCL tool which main relations and general scheme have been presented above allows to perform simulations of climate change scenarios. It is a free-access web application with the objective to provide an interactive tool with a user-friendly graphical interface (designed with R Shiny) to enable both experts and non-experts to enter their own scenario assumptions and obtain the resulting projections of the long-term economic consequences of carbon taxation, at the 2060 and 2100 horizons. This possibility to carry out sensitivity analysis can help understand the main economic and environmental mechanisms of both climate change and carbon taxation, as well as the reasons behind the current lack of consensus among economists. We first present the tool before building and commenting some scenarios.

5.1. Tool description

The ACCL model is a highly flexible projection tool that evaluates both the negative and positive impacts of carbon taxation on the economy at the country and regional level, for two distinct horizons: 2060 and 2100. For each country and region of interest, all the economic, energy and environmental hypotheses proposed by default can be modified by the user, in particular the parameters, series and functional forms whose definitions are fraught with controversy, such as climate sensitivity or the damage function. Baseline specifications and scenarios are systematically offered, based on the relationships previously estimated, as well as the parameters and series paths documented beforehand.

Hence, default values may vary according to the area of interest or the chosen policy scenario. Indeed, the model assumptions can be viewed and modified for 30 countries or regions of the world independently, as well as for the climate policy scenarios. It is possible to simulate a fine-tuning of carbon taxation policies, by altering directly the average annual growth rate of the relative price of each energy type (coal, oil, natural gas, CO₂-emitting and non-CO₂-emitting electricity), at the country or regional scale. In the scenarios below, we will consider for each type of energy the same change in relative price in all countries/regions, assuming a coordinated climate policy (but leading to different carbon taxes expressed in volume). Other climate and technological policies can be implemented, through changes of the carbon sequestration relation parameters. In the scenarios below, we will keep the parameters proposed by default and assume a time fixed sequestration of one third of the 2016 emissions.

The default values are summarised in the table 6 below.

Table 6

Default values of the scenario hypotheses

	Developed Countries	Emerging countries & regions
$P_{i,t,c}^{NRJ}$	Depends on the choice of scenario	
$P_{t,c}^{GFCF}$	-1.2%	
$EDU_{t,c}$	Convergence towards the Australian's 2016 level in 2060 (the country of our panel with the highest level of education)	
$H_{t,c}$	The national 2016 average annual hours worked per worker	No change
$ER_{t,c}$	The national 2016 employment rate	No change
$EPL_{t,c}$	The national 2016 Employment Protection Legislation index value	No change
$PMR_{t,c}$	The national 2016 Product Market Regulations index value	No change

The user of the tool can replace these default hypotheses by any others she/he deems appropriate.

5.2. Four climate scenarios

Four analytical scenarios are simulated: no climate policy (i.e. "Business As Usual" scenario), decrease of non-CO₂-emitting energy relative price (thanks to technological progress or subsidy), low carbon taxation (with a global warming reaching about 4°C above pre-industrial era levels) and high carbon taxation (for which temperature rise is maintained at approximately 2°C).

In the BAU (for Business As Usual) scenario, we assume no carbon taxation and so, we set the annual evolution of the relative price of each energy type to zero for the whole world from 2017 to 2100. The DREP (for Decrease of Renewable Energy relative Price) scenario is identical regarding all the different CO₂-emitting energy sources, but it displays an average annual decrease of -2% for the relative price of non-CO₂-emitting electricity in the entire world and over the whole time period. This decrease in the relative price of renewable energies may correspond to the effect of a subsidy or of technological progress, which reduces their production costs. With the LCT (for Low Carbon Tax) or HCT (for High Carbon Tax) scenarios, we introduce a climate policy that raises annually the relative price of coal, oil, natural gas and CO₂-emitting electricity by 1% for LCT and 3% for HCT, in each country / region, for the whole period. On the contrary, the "clean" electricity relative price does not change in these two scenarios. A mixed scenario combining both a decrease in the price of renewable energies and a carbon tax weighing on the CO₂-emitting energy prices would result from the redistribution of the carbon tax through renewable energy subsidies (direct price subsidies or R&D subsidies); it is easily implementable in the online projection tool. The four considered scenarios are analytical and cannot pretend to correspond to realistic ones. They help appreciating the properties of the ACCL tool and considering very contrasted climate situations.

The economic hypotheses do not depend on the chosen climate policy scenario. The -1.2% average annual growth rate of the relative price of investment, applied to the whole world and the entire simulation period, is based on the US historical evolution of the variable, according to our data. This reduction in the relative price of investment is the main driving force of our TFP growth, alongside the improvement in the average education level of the population. Indeed, we define by default and for all countries / regions, a convergence of the average education level towards the Australian's current value (about 13 years of schooling), thus reached in 2060 and then, a stagnation for the remaining period (2061-2100). We chose Australia as it is the country, in our database, with the highest level of education, implying an upward convergence (catch-up effect) for all countries / regions, with different magnitudes depending on how distant their respective starting points were. Regarding the hours worked per employee, the employment rate or the regulation index, we suppose no variation as these effects are not among the ones we want to test. However, we let the possibility for the user to modify any of these assumptions in the projection tool.

Chart 3 presents the simulated World CO₂ net emissions in the four scenarios. It appears that, at the 2100 horizon, the annual CO₂ emissions are, compared to their 2016 level, multiplied by a factor 5 in the BAU scenario, 4.5 in the DREP scenario and 2.5 in the LCT scenario. Net emissions are nil in 2100 in the HCT scenario, which means that such goal of nil net emissions corresponds to very ambitious climate policies, as also emphasised by both the IPCC's (2018) or the France Stratégie's (2019) latest special reports.

Chart 3
World CO₂ emissions (in giga tonnes of CO₂)

From fuel combustion

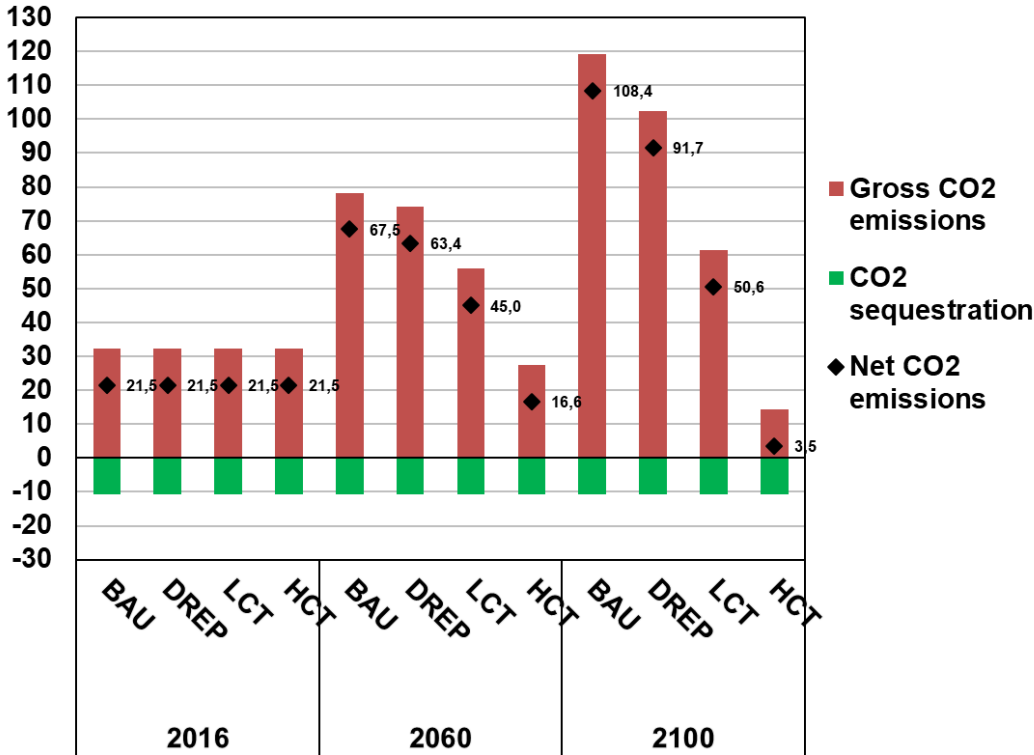

Chart 4 presents the global change in temperature (with respect to the pre-industrial era) of our four climate scenarios. At the 2100 horizon, the temperature increase would be 5.5°C in the BAU scenario, 5.2°C in the DREP scenario, and 3.9°C in the LCT scenario. The goal of an increase by 2°C of the

temperature would be reached in the HCT scenario, which means here again that such goal corresponds to very ambitious climate policies.

Chart 4
Global change in temperature (in °C)
 With respect to pre-industrial era

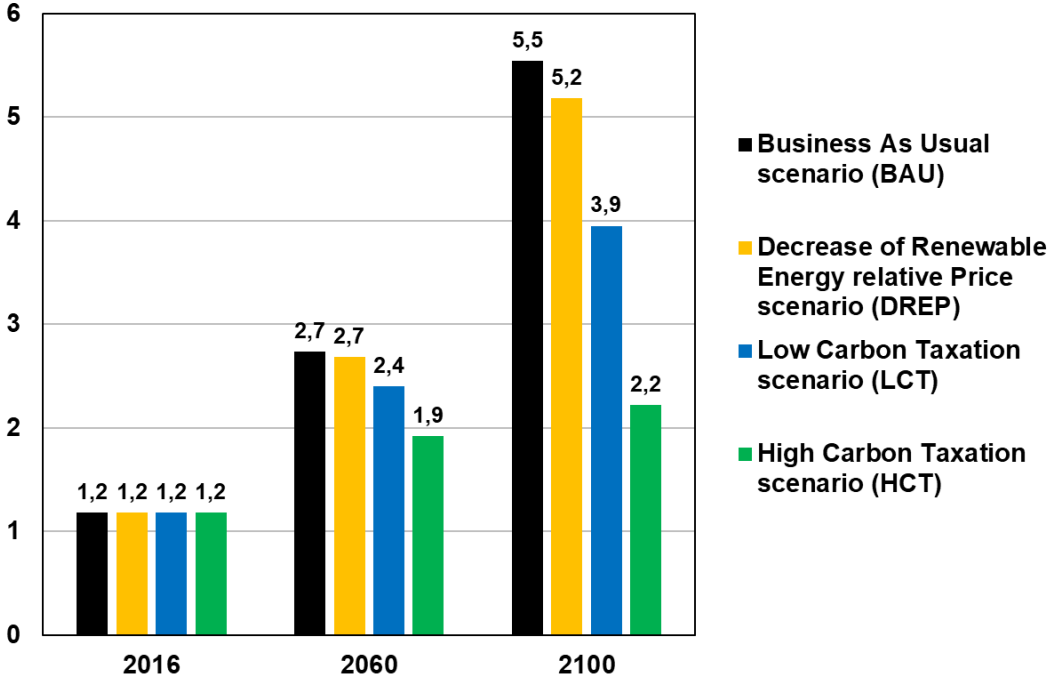

Chart 5 presents the impacts on Global GDP level of our four scenarios, compared to a situation without climate damage and climate policies. In the BAU scenario, this impact corresponds to the climate damage and, at the 2100 horizon, the GDP loss is about 12%. In the three other scenarios, the net GDP impact corresponds to the sum of three components: the BAU damage, the TFP losses from climate policy, the avoided damage from a lower temperature increase than in the BAU scenario. In the DREP scenario, losses from climate policy are in fact gains, as energy price decreases. On the opposite, they are effective losses in the two carbon tax scenarios (LTC and HTC). Adding these three components, the net GDP impact at the 2100 horizon would be a loss of 10% in the DREP scenario, 8% in the LTC scenario and 7% in the HCT scenario. The gap in net GDP losses between the two carbon tax scenarios is small, as the higher price increase of the CO₂ emitting energies in the HCT scenario compared to the LTC one results both in higher avoided damage and higher losses from the climate policy.

The BAU scenario and the two carbon tax scenarios illustrate what has been named the “tragedy of the horizon” by M. Carney (2015). At the 2060 horizon, the net GDP impact is more detrimental in the LCT scenario than in the BAU one, and in the HCT scenario than in the LCT or the BAU ones. Indeed, losses from climate policies are higher than the avoided damage at this horizon. At the longer 2100 horizon, on the opposite, the net GDP negative impact is lower in the LCT scenario than in the BAU one, and in the HCT scenario than in the LCT and the BAU ones, losses from climate policies being themselves lower than avoided damage. This result is very important: it implies that the sign of the actual net value of intertemporal GDP impact of climate policy implementation could depend on the discount rate. For very high values of the discount rate, climate policy implementation aiming at avoiding climate GDP impact could become irrelevant. Of course, for plausible values of the discount rate, the implementation of climate policies is highly relevant.

The “tragedy of the horizon” would be lowered (but would not disappear) from an increase of the convexity of the damage relation (11). We assume here that this relation is quadratic ($\theta_3 = 0$). If we assume that this convexity is more than quadratic ($\theta_3 < 0$) then the net GDP impact of the climate policies corresponding to scenarios LCT and HCT could become positive and not more detrimental than in the BAU scenario before the 2060 horizon.

Chart 5
Impacts on Global GDP level (in % of GDP)

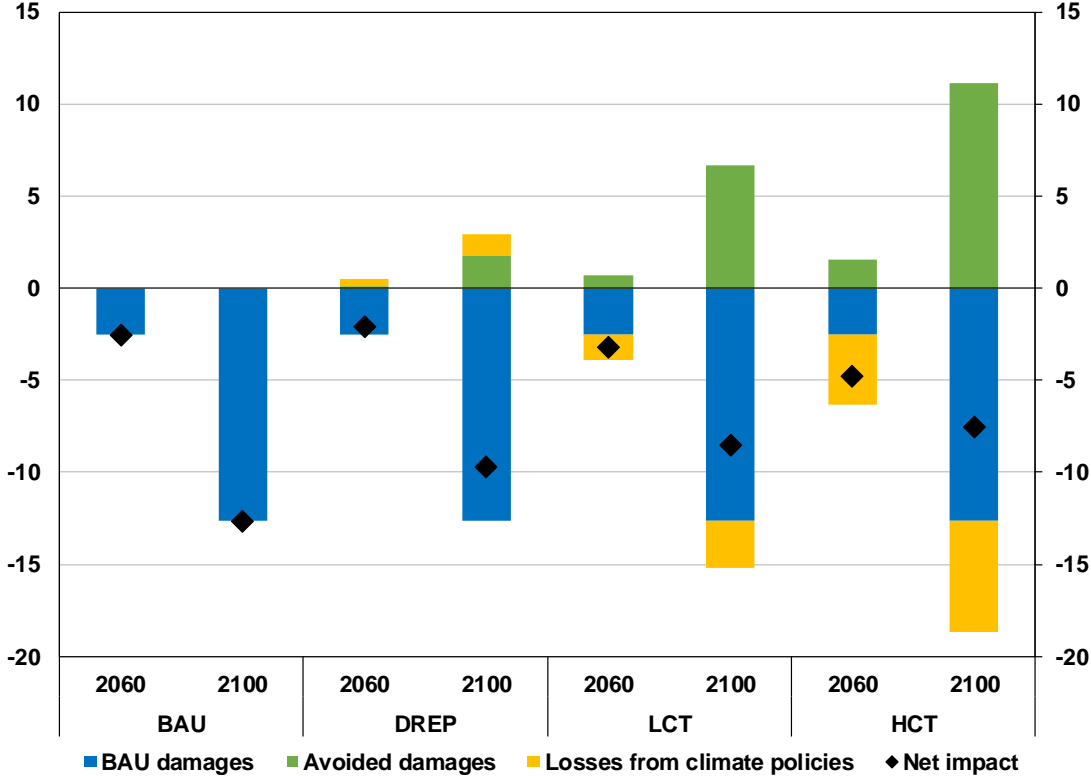

Chart 6 presents the impacts on GDP at the country/regional level for the BAU scenario. We observe a wide dispersion of these impacts. For two specific countries (Canada and Russia), the impact is even positive, as the temperature increase creates a supply-side gain from the extension of arable land. The impact is negative in the other countries, with GDP losses in 2100 higher than 15% in five countries/regions: -27% in India, -23% in Africa, -20% in Mexico, -16% in China and in the rest of Asia. Developing countries are the most hurt by these losses.

Chart 6

Business As Usual scenario (BAU) - Country / region warming damage on GDP (in % of GDP)

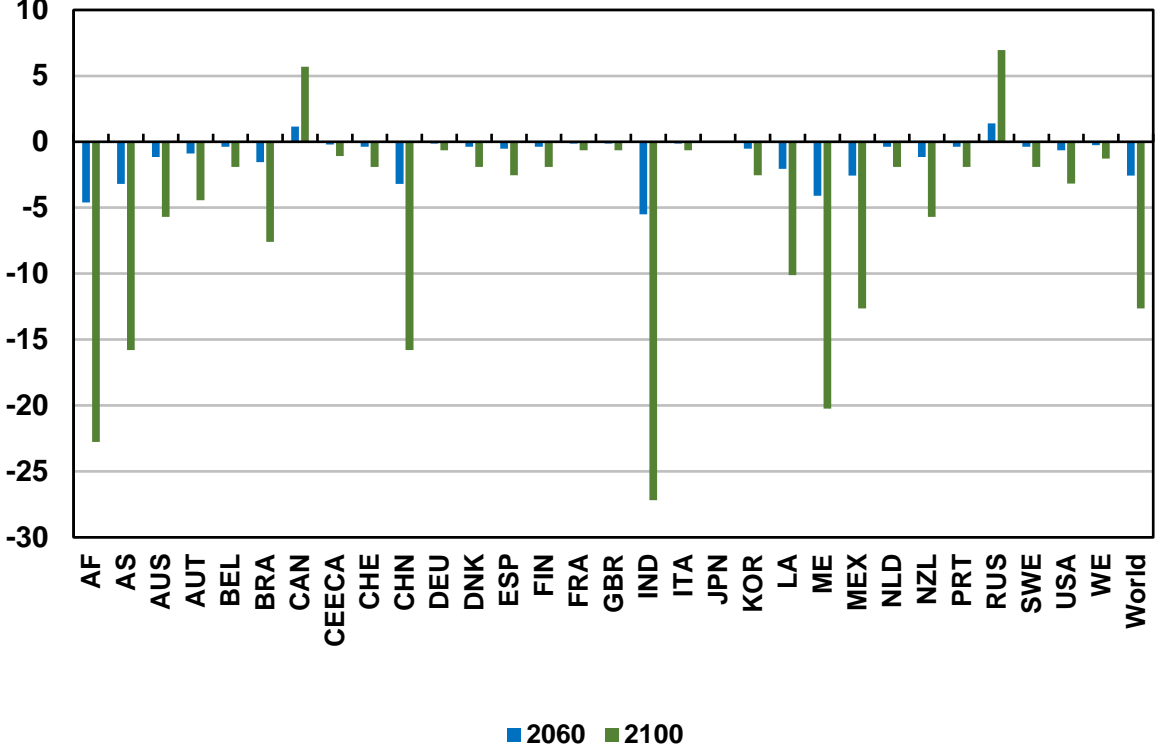
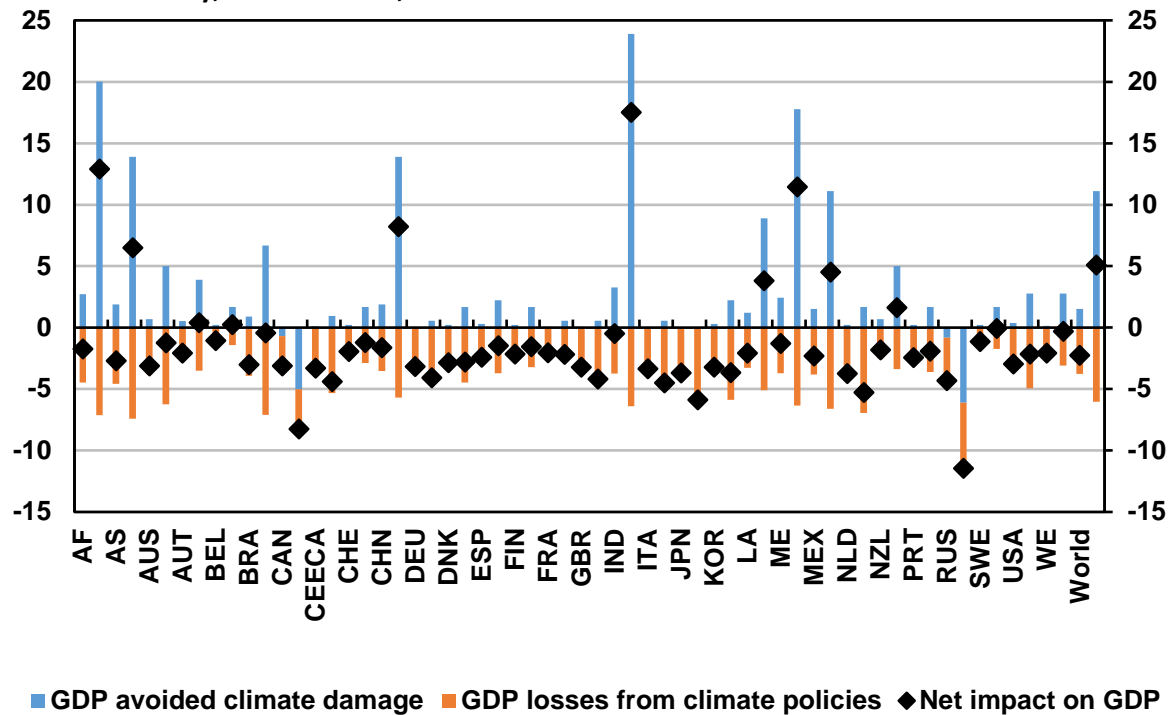

Chart 7 presents the impacts on GDP at the country/regional level of the HCT scenario compared to the BAU scenario. It appears that the countries/regions that would benefit the most from the implementation of an ambitious climate policy would be those which are the most damaged in the BAU scenario. The gain is even slightly negative (more precisely non-significant) for numerous developed countries. This illustrates what is usually called the “tragedy of the commons”: to avoid high losses from global warming in some countries, mainly developing ones, climate policies have to be implemented in all countries and even countries where the gain from these policies could be small. It means that, in order to be efficient, climate policies need coordination and solidarity between countries.

Chart 7

High Carbon Tax scenario (HCT) - Consequences on GDP (in % of GDP) compared to BAU scenario
For each country, first bar: 2060, second bar: 2100



This second tragedy can be particularly highlighted with two specifications of our HCT scenario. In the first case, we consider that the stringent carbon tax (3% annual increase in the relative price of the CO₂-emitting energies) is only implemented in the country with the greatest potential gains from the policy, while the rest of the world keeps all the relative energy prices constant (as in the BAU scenario). According to our previous simulations, India would be the country the most affected by climate change and so, the one with the highest incentive to enact a carbon tax on this criterion. The world outcome of this scenario is very similar to the BAU one, with only a slight downward effect on the temperature increase (5.3°C with respect to the pre-industrial era in 2100, instead of 5.5°C in the BAU situation) and a small avoidance of the BAU climate damage (only 1.3% of the 2100 global GDP). Hence, India would bear alone the entire economic cost of this policy (which represents a GDP loss of 6.4% in 2100) without really being able to limit the damage caused by global warming on its economy (24.4% of the national GDP, compared to 27.2% in the full BAU case). On the opposite, most of the developed countries that are not amongst the most affected by climate change (the “free-riders”) appear to be better-off in this scenario than in both the full BAU and the full HCT scenario, as they benefit from the small CO₂ emissions reduction from Indian taxation, while avoiding the costs associated with the policy implementation. Our second specification assumes compliance to the Paris agreement for the whole world (our HCT scenario) except for the USA that continues “Business As Usual”. In this case, the USA would be the free-rider, enjoying the global containment of the temperature rise (only 2.8°C with respect to the pre-industrial era in 2100) without suffering from the GDP losses implied by carbon taxation as the other countries do. It would then be the only country better-off than in the full HCT set-up. Thus, we clearly see that none of these two specifications is collectively optimal and that they both illustrate the fact that each country best individual strategy is a “Business As Usual” one, highlighting the crucial need of international coordination and solidarity for climate policies. Gollier and Tirole (2015) present a roadmap for the negotiation process and put forward an enforcement scheme to induce all countries to participate and comply with an agreement. This proposed roadmap would hence implement an effective coordination and overcome the “tragedy of the commons”.

6. Conclusion

This paper provides a fully parametrisable tool to forecast the impact of climate change and of mitigation policies in a long-run, supply-side perspective. It emphasizes the effectiveness of energy price signals, which reduce the consumption of CO₂ emitting energies and, hence, could prevent major damage from climate change. As pointed by Gillingham and Stock (2018), a pigouvian tax on CO₂ emissions is the simplest and most efficient policy to reduce CO₂ emissions. The ACCL tool allows to evaluate the impact of such policies.

The proposed simulations illustrate the two tragedies of these mitigating policies. First, the “tragedy of the horizon” is reflected by the negative impact of mitigating policies in the medium run, even when accounting for the climate change damage avoided thanks to these policies. Hence, climate change requires a policy framework that adequately takes into account the long run, through a low-enough discount rate and an effective intergenerational solidarity. Second, the “tragedy of the commons” is reflected by the wide dispersion of climate change damage. Developing countries are among the most affected, while mitigating policies have to be implemented by all countries and especially by developed countries, with low climate change damage but high contribution to CO₂ emissions.

These scenarios remain conservative, as there are large uncertainties, with mostly downside risks listed in the scientific literature. In particular, the relationship between CO₂ and temperature may not be linear, with several sources of tipping point, such as thawing permafrost, disruption of the thermohaline circulation, shift in El Niño–Southern Oscillation... On the positive side, we can mainly list potential technological improvement in CO₂ sequestration, not only at emissions but also for the existing atmospheric stock.

Moreover, we mainly concentrated here on GDP damage, but non-market damage (migration, conflicts, biodiversity loss...) should also be considered, as most of them are outside the scope of our supply-side, long-run GDP approach, although constituting some of the most significant consequences of global warming. In particular, Gonand (2015) pointed out that several facets of climate change such as energy security, air pollution, or extreme weather events are still often overlooked, resulting in an incomplete impact assessment and a significant underestimation of the SCC. He argues that the likelihood and consequences of extreme weather events alone justify the immediate recourse to costly policies against climate change.

Consequently, Burke et al. (2016) suggested avenues for future research on climate catastrophes: modelling endogenous tipping points in the climate and taking into account the mutual dependency of these catastrophic events. Thus, global warming damage would be non-linear (for instance through the existence of feedback loops in the climate and economic systems), which is the case in our ACCL tool. Climate change effects have profound and long-lasting consequences on the economy because they impact growth through labour productivity, TFP and the value of the capital stock and so, they permanently affect the economic output (Letta & Tol, 2019).

For all of these reasons, many environmental economists believe that contemporary values of the SCC are lower bounds of the true ones and so, that public policies are not bold enough. Through the choice of parameters, the ACCL tool can be helpful in this spirit to evaluate more pessimistic scenarios than those presented above and we have to consider that such highly pessimistic scenarios could be realistic...

References

- Auffhammer, M. (2018). "Quantifying Economic Damage from Climate Change", *Journal of Economic Perspectives*, Vol. 32, N° 4, pp. 33-52.
- Aghion, P., P. Askenazy, R. Brouillette, G. Clette and N. Dromel (2009). « Education, Market Rigidities and Growth », *Economics Letters*, n° 102, 2009, pp. 62-65.
- Barro, R. and Jong-Wha Lee (2010). "A new data set of educational attainment in the world, 1950-2010", *NBER Working Papers* 15902, National Bureau of Economic Research, Inc.
- Bergeaud, A., G. Clette and R. Lecat (2016). « Productivity Trends in Advanced Countries Between 1980 and 2012 », *The Review of Income and Wealth*, Vol. 62(3), September 2016, pp. 420-444.
- Bergeaud, A., G. Clette and R. Lecat (2018). « The Role of Production Factor Quality and Technology Diffusion in the 20th Century Productivity Growth », *Cliometrica*, Vol. 12, Issue 1, 2018, January, pp. 61-97.
- Bolton, P., Despres, M. Pereira Da Silva, L., Samama, F. and Svartzman R. (2020). "The Green Swan: Central Banking and Financial Stability in the Age of Climate Change ", BIS and Banque de France joint paper.
- Bosetti, V., C. Carraro, M. Galeotti, E. Massetti, and M. Tavoni (2006). "WITCH: A World Induced Technical Change Hybrid Model". In: *The Energy Journal*. Special Issue on Hybrid Modeling of Energy-Environment Policies: Reconciling Bottom-up and Top-down, pp. 13-38.
- Bosetti, V., E. Massetti and M. Tavoni (2007). "The WITCH Model. Structure, Baseline, Solutions". In: FEEM Working Paper 10-2007.
- Bosetti, V., E. De Cian, A. Sgobbi and M. Tavoni (2009). "The 2008 WITCH Model: New Model Features and Baseline". In: FEEM Working Paper 085.2009.
- Brouillette, R. and G. Clette (2007). « Trends in 'Structural' Productivity Levels in the Major Industrialized Countries », *Economics Letters*, n° 95, 2007, pp. 151-156.
- Brandsma, A., A. Kancs, P. Monfort and A. Rillaers (2015). "RHOMOLO: A dynamic spatial general equilibrium model for assessing the impact of cohesion policy". In: *Papers in Regional Science* 94.51, pp. 197-221.
- Byrne, D., J. Fernald and M. Reinsdorf (2016). "Does the United States Have a Productivity Slowdown or a Measurement Problem?", *Brookings Papers on Economic Activity*, March 2016, pp. 109-157.
- Byrne, D., S. Oliner and D. Sichel (2013). "Is the Information Technology Revolution Over?", *International Productivity Monitor*, No. 25, Spring, pp. 20-36.
- Capros, P., D. Van Regemorter, L. Paroussos and P. Karkatsoulis (2013). "GEM-E3 Model Documentation". In: JRC Working Papers JRC83177, Joint Research Centre (Seville site).
- Centre d'analyse stratégique (2008). « La Valeur tutélaire du carbone », rapport de la commission

présidée par Alain Quinet, Paris, La Documentation française.

Cette, G., Y. Kocoglu and J. Mairesse (2005). « ICT and Potential Output Growth », *Economics Letters*, vol. 87, Issue 2, 2005, pp. 231-234.

Cette, G., Lecat, R. and Ly-Marin, C. (2017). « Long term growth and productivity projections in advanced countries », *OECD Journal: Economic Studies*, OECD Publishing, vol. 2016(1), pages 71-90.

Cette, G., J. Lopez and J. Mairesse (2016). « Market Regulations, Prices and Productivity », *American Economic Review, Papers and Proceedings*, 106(5), 2016, pp. 104-108.

Cette, G., J. Lopez and J. Mairesse (2018). “Rent creation and rent sharing: new measures and impacts on productivity”, *Economic Inquiry*, Wiley, 57(4), pp. 1915-1938.

Chateau J., R. Dellink and E. Lanzi (2014). “An Overview of the OECD ENVLinkages Model: Version 3”. In: *OECD Environment Working Papers* 65.

Ciscar, J.C., L. Feyen, D. Ibarreta and A. Soria (2018). “Climate impacts in Europe: Final report of the JRC PESETA III project”. In: *Publications Office of the European Union EUR 29427 EN*. ISBN 978-92-79-97218-8, doi:10.2760/93257, JRC112769.

Cohen, D. and M. Soto (2007). “Growth and Human Capital: Good Data, Good Results”, *Journal of Economic Growth*, 12(1):51-76.

Conway, P. and G. Nicoletti (2007). “Product Market Regulation and Productivity Convergence: OECD Evidence and Implications for Canada”, *International Productivity Monitor*, 15, pp. 3-24.

Covenant of Mayors for Climate and Energy (2017). “Default emission factors for local emission inventories”. url: http://publications.jrc.ec.europa.eu/repository/bitstream/JRC107518/jrc_technical_reports_com_de_fault_emission_factors-2017.pdf. (accessed: 24.05.2019). Publications Office of the European Union.

Covington H. and R. Thamotheram (2015). “The Case for Forceful Stewardship (Part 2). Managing Climate Risk”. In: Available at SSRN: <http://ssrn.com/abstract=2551478>.

Csereklyei Z., M. d. Mar Rubio-Varas, and D. I. Stern (2016). “Energy and Economic Growth: The Stylized Facts”, *The Energy Journal*, Volume 37, issue Number 2.

Deke, O., K.G. Hooss, C. Kasten, G. Klepper, and K. Springer (2001). “Economic Impact of Climate Change: Simulations with a Regionalized Climate-Economy Model”. In: *Kiel Institute of World Economics, Working Paper* 1065.

Econometrics, Cambridge (2014). “E3ME Technical Manual, Version 6. 0”. url: <https://www.camecon.com/wp-content/uploads/2016/09/E3ME-Manual.pdf>.

Environmental Protection Agency and Change Division Council (2016). “Technical Support Document: -Technical Update of the Social Cost of Carbon for Regulatory Impact Analysis”. In: *Under Executive Order 12866 - Interagency Working Group on Social Cost of Greenhouse Gases*, United States Government.

Fouré, J., A. Bénassy-Quéré and L. Fontagné (2013). "Modelling the world economy at the 2050 horizon", *Economics of Transition*, Wiley-Blackwell, 21(4), pp. 617-654.

France Stratégie (2019). "The Value for Climate Action A shadow price of carbon for evaluation of investments and public policies", Report by the Commission chaired by Alain Quinet.

Gillingham, K. and J. H. Stock (2018). "The Cost of Reducing Greenhouse Gas Emissions", *Journal of Economic Perspectives*, Vol. 32, N° 4, pp. 53-72.

Global Trade Analysis - GTAP, Center for (2014). "GTAP Models: Current GTAP Model".

Gollier, C., and J.Tirole (2015). "Negotiating effective institutions against climate change," *Economics of Energy & Environmental Policy*, International Association for Energy Economics, vol. 0(Number 2).

Golosov, M., Hassler, J., Krusell, P. and Tsyvinski, A. (2014). "Optimal Taxes on Fossil Fuel in General Equilibrium", *Econometrica* 82(1), 41-88.

Hope C. (2006). "The Marginal Impact of CO₂ from PAGE2002: An Integrated Assessment Model Incorporating the IPCC's Five Reasons for Concern". In: *The Integrated Assessment Journal* 6.1, pp. 16-56.

Hsiang, S. and R. Kopp (2018). "An Economist's Guide to Climate Change", *Journal of Economic Perspectives*, Vol. 32, Number 4, Fall 2018, pp. 3-32.

IEA (International Energy Agency) (2018). "Energy Prices and Taxes database". In: (2nd Quarter).

IEA (International Energy Agency) (2017). "Headline Global Energy Data".

IPCC (Intergovernmental Panel on Climate Change) (2014). "Climate Change 2014: Impacts, Adaptation, and Vulnerability." In: *Contribution of Working Group II to the Fifth Assessment Report of the Intergovernmental Panel on Climate Change (2014)*.

IPCC (2018). *Special Report on Global Warming of 1.5°C*.

Joos, F., R. Roth, J. S. Fuglestedt, G. P. Peters, I. G. Enting, W. von Bloh, V. Brovkin, E. J. Burke, M. Eby, N. R. Edwards, T. Friedrich, T. L. Frölicher, P. R. Halloran, P. B. Holden, C. Jones, T. Kleinen, F. T. Mackenzie, K. Matsumoto, M. Meinshausen, G.-K. Plattner, A. Reisinger, J. Segschneider, G. Shaffer, M. Steinacher, K. Strassmann, K. Tanaka, A. Timmermann, and A. J. Weaver (2013). "Carbon dioxide and climate impulse response functions for the computation of greenhouse gas metrics: a multi-model analysis"

Koske, I., I. Wanner, R. Bitetti and O. Barbiero (2015). "The 2013 update of the OECD product market regulation indicators: policy insights for OECD and non-OECD countries", *OECD Economics Department Working Papers*, No. 1200.

Landa Rivera, G. (2018). "The State of Applied Environmental Macroeconomics". In: *Whither the economy?* *Revue de l'OFCE* 157, pp.133-150.

Lutz C., B. Meyer and M. I. Wolter (2010). "The global multisector/multicountry 3-E model GINFORS. A description of the model and a baseline forecast for global energy demand and CO₂ emissions". In: *International Journal of Global Environmental Issue* 10.1/2, p. 25.

Manne A., R. Mendelsohn and R. Richels (1995). "MERGE: A model for evaluating regional and global effects of GHG reduction policies". In: *Energy Policy* 23, pp. 17-34.

Marland G., T. Boden and R. J. Andres (2017). "Global, Regional, and National Fossil-Fuel CO₂ Emissions (1751–2014) (V. 2017)." Oak Ridge, TN: Carbon Dioxide Information Analysis Center (CDIAC), Oak Ridge National Laboratory (ORNL). url: http://dx.doi.org/10.3334/CDIAC/00001_V2017. (accessed: 27.05.2019).

Masson-Delmotte, V., P. Zhai, H.-O. Pörtner and D. Roberts (2018). "Global Warming of 1.5°C. An IPCC Special Report on the impacts of global warming of 1.5°C above pre-industrial levels and related global greenhouse gas emission pathways, in the context of strengthening the global response to the threat of climate change, sustainable development, and efforts to eradicate poverty". In: Intergovernmental Panel on Climate Change (IPCC).

Matthews, D., K. Zickfeld, R. Knutti and M. Allen (2018). "Focus on cumulative emissions, global carbon budgets and the implications for climate mitigation targets", *Environmental Research Letters*, 13 (2018) 010201.

NGFS Technical Supplement (2019).

Nordhaus, W. D. (1993). "Rolling the DICE. An Optimal Transition Path for Controlling Greenhouse Gases", In: *Resource and Energy Economics* 15.1, pp. 27-50.

Nordhaus, W. D. (1992). "Lethal Model 2: The Limits to Growth Revisited", In: *Brookings Papers on Economic Activity*, 1992.2, pp. 1-59.

Nordhaus, W. D. (2017). "Projections and Uncertainties About Climate Change in an Era of Minimal Climate Policies", In: NBER (National Bureau of Economic Research) Working Paper N° 22933.

Nordhaus, W. D. (2018). "Projections and Uncertainties about Climate Change in an Era of Minimal Climate Policies", *American Economic Journal, Economic Policy*, 10(3), pp. 333-360.

Nordhaus, W. D. (2019). "Climate Change: The Ultimate Challenge for Economics", *American Economic Review*, 109(6), pp. 1991-2014.

Nordhaus, W. D. and Boyer J. (2000). "Warming the World: Economic Models of Global Warming", In: MIT Press, Cambridge.

Nordhaus, W. D. and A. Moffat (2017). "A survey of global impacts of climate change: Replication, survey methods, and a statistical analysis", In: NBER (National Bureau of Economic Research) Working Paper N° 23646.

Nordhaus, W. D. and Yang Z. (1996). "A Regional Dynamic General-Equilibrium Model of Alternative Climate-Change Strategies", In: *American Economic Review* 86.4, pp. 741-765.

OECD (2013). "Employment Outlook".

OECD (Organisation for Economic Co-operation and Development) (2015). "The Economic Consequences of Climate Change", In: OECD Publishing, November, Paris.

OECD (Organisation for Economic Co-operation and Development) (2018). "Economic Outlook", May.

- Pigou, A. C. (1920). "The Economics of Welfare", Macmillan, London.
- Pindyck, R.S. (2017). "The Use and Misuse of Models for Climate Policy", In: Review of Environmental Economics and Policy, 11.1, pp. 100-114.
- Revesz, R.L., P.H. Howard, K. Arrow, L.H. Goulder and R.E Kopp (2014). "Global warming: Improve economic models of climate change". In: Nature 508, pp. 173-175.
- Saam, M., C. Papageorgiou and P. Schulte (2017). "Substitution between Clean and Dirty Energy Inputs: A Macroeconomic Perspective", In: The Review of Economics and Statistics 99 (2017), pp. 281–290.
- Schubert, K. (2018). "Macroeconomics and the environment", In: "Whither the economy?", Revue de l'OFCE, N° 157, pp.117-132.
- Soto, M. (2002). "Rediscovering Education in Growth Regressions", *OECD Development Centre Working Papers* 202, OECD Publishing.
- Stern, N. (2007). "The economics of Climate Change: The Stern Review", In: Cambridge Univ. Press.
- Stern, D. I. (2009). "Interfuel Substitution: A Meta-Analysis", In: Departmental Working Papers, The Australian National University, Arndt-Corden Department of Economics.
- Stiglitz, J. (2019). "Addressing climate change through price and non-price interventions", *European Economic Review*, 119, pp. 594-612.
- Tol, R. S. (2005). "Emission Abatement versus Development as Strategies to Reduce Vulnerability to Climate Change: An Application of FUND", In: *Environment and Development Economics* 10, pp. 615-629.
- Tol, R. S. (2018). "The Economic Impacts of Climate Change", In: Review of Environmental Economics and Policy, 12.1, pp. 4-25.
- Waldho, S., D.Antho, S. Rose and R.S. Tol (2014). "The marginal damage costs of different greenhouse gases: An application of FUND", In: *Economics* 8.
- Weyant, J. (2017). "Some contributions of Integrated assessment Models of Global Climate Change", *Review of Environmental Economics and Policy*, Oxford University Press, Vol. 11(1), pp. 115-137.

Appendix

Table A-1

Countries and regions of interest

Abbreviations	Countries and regions
AF	Africa
AS	Rest of Asia
AUS	Australia
AUT	Austria
BEL	Belgium
BRA	Brazil
CAN	Canada
CEECA	Rest of Central and Eastern Europe and Central Asia
CHE	Switzerland
CHN	China
DEU	Germany
DNK	Denmark
ESP	Spain
FIN	Finland
FRA	France
GBR	United Kingdom
IND	India
ITA	Italy
JPN	Japan
KOR	South Korea
LA	Rest of Latin America
ME	Middle East
MEX	Mexico
NLD	Netherlands
NZL	New Zealand
PRT	Portugal
RUS	Russia
SWE	Sweden
USA	United States
WE	Rest of Western Europe

Table A-2

Interfuel substitution elasticities

Energy types		CO ₂ -emitting				Non-CO ₂ -emitting
		Coal	Oil	Natural Gas	Electricity – CO ₂ -emitting inputs	Electricity – non-CO ₂ -emitting inputs
CO ₂ -emitting	Coal		1	1.5	1	1
	Oil	1		2	1	1
	Natural Gas	1.5	2		1.5	1.5
	Electricity – CO ₂ -emitting inputs	1	1	1.5		2
Non-CO ₂ -emitting	Electricity – non-CO ₂ -emitting inputs	1	1	1.5	2	

Derived from David Stern's meta-analysis (2009) and Papageorgiou et al. (2017)

Table A-3
Coefficient of CO₂ emissions per energy type

Energy types	Default emission factors (tCO ₂ -eq/MWh)
Coal	0.359
Oil	0.307
Natural Gas	0.240
Electricity – CO ₂ -emitting inputs	0.321
Electricity – non-CO ₂ -emitting inputs	0.017

Derived from the Covenant of Mayors for Climate and Energy report (2017)

Table A-4
Damage from climate change impacts

Countries & Regions	Damages (GDP % compared to baseline)
Africa	-3.6
Asia	-2.5
China	-2.5
India	-4.3
Japan	0.0
South Korea	-0.4
Central & Eastern Europe & Central Asia	-0.17
Russia	1.1
Latin America	-1.6
Brazil	-1.2
Mexico	-2.0
Middle East	-3.2
North America	-0.4
Canada	0.9
United States	-0.5
Oceania	-0.9
Australia	-0.9
New-Zealand	-0.9
Western Europe	-0.2
France	-0.1
Germany	-0.1
Italy	-0.1
Spain	-0.4
United Kingdom	-0.1
Other	-0.3

Derived from the OECD (2015)