



HAL
open science

Report on the 2019 Season of the Madâ'in Sâlih Archaeological Project

Laïla Nehmé, Nathalie Delhopital, Caroline Durand, Florent Egal, Zbigniew T. Fiema, Damien Gazagne, Ahmad S Al-Huwaytî, Maha Al-Juhanî, Saad A Al-Muqbil, Mâher Al-Mûsa, et al.

► **To cite this version:**

Laïla Nehmé, Nathalie Delhopital, Caroline Durand, Florent Egal, Zbigniew T. Fiema, et al.. Report on the 2019 Season of the Madâ'in Sâlih Archaeological Project. [Research Report] CNRS. 2019. halshs-02514028

HAL Id: halshs-02514028

<https://shs.hal.science/halshs-02514028>

Submitted on 21 Mar 2020

HAL is a multi-disciplinary open access archive for the deposit and dissemination of scientific research documents, whether they are published or not. The documents may come from teaching and research institutions in France or abroad, or from public or private research centers.

L'archive ouverte pluridisciplinaire **HAL**, est destinée au dépôt et à la diffusion de documents scientifiques de niveau recherche, publiés ou non, émanant des établissements d'enseignement et de recherche français ou étrangers, des laboratoires publics ou privés.

Report on the 2019 Season

of the **Madâ'in Sâlih**

Archaeological Project

Edited by Laïla Nehmé

With contributions by

Nathalie Delhopital, Caroline Durand, Florent Egal, Zbigniew T. Fiema, Damien Gazagne, Ahmad S. Al-Huwaytî, Maha Al-Juhanî, Saad A. Al-Muqbil, Maher K. Al-Mûsa, Samar M. Al Nawfal, Laïla Nehmé, Jérôme Norris, Marie Peillet, Ibrahim N. Al-Sabhân, Jacqueline Studer, Daifallah M. Al-Talhi

And the drawings of Ariadni Ilioglou and Jean Humbert



October 2019

Cover page photograph, L. Nehmé: *Group of Nabataean inscriptions at as-Sij*.

Next page photograph, L. Nehmé: *Ariadni Ilioglou digging a fully preserved pot which became visible after the rains*.

Page set up: P. and M. Balty art'air-éd



Report on the 2019 Season

of the **Madâ'in Sâlih**

Archaeological Project



October 2019

TABLE OF CONTENTS

Year 2019: Summary of Actions	
LAÏLA NEHMÉ	7
The Roman Fort in Hegra. Summary of the First Four Seasons of Fieldwork.	
ZBIGNIEW T. FIEMA	19
La fouille du grand sanctuaire (IGN 132)	
DAMIEN GAZAGNE	31
Preliminary Report on the excavation of Areas 64300 and 64400 South of IGN 132	
MAHER K. AL-MÛSA, AHMAD S. AL-HUWAYTÎ, SAAD A. AL-MUQBIL, SAMAR M. AL-NAWFAL, IBRAHÎM N. AL-SABHÂN, DAIFALLAH M. AL-TALHI	61
Pottery Report	
CAROLINE DURAND	73
Étude anthropologique	
NATHALIE DELHOPITAL	81
Analyse archéozoologique : priorités et perspectives	
JACQUELINE STUDER	87
Conservation and Care of artefacts	
MARIE PEILLET	91

Year 2019: Summary of Actions

Laïla NEHMÉ (CNRS, UMR 8167, Orient & Méditerranée)

Year 2019 has been a particularly rich one for the Madâ'in Sâlih Archaeological Project for the following reasons:

- it was the first year of a **new five years research programme**, the contract of which was signed by both parties, the Saudi Commission for Tourism and National Heritage (SCTH) and the CNRS, in the spring of 2019;
- it was the first season of the **survey between Madâ'in Sâlih and Medina**, during which a strategy and methodology had to be set up;
- it was the first year of the **Al-'Ulâ Tantoora festival**, which led many tourists and visitors, including VIP ones, to visit the site;
- an important part of the year was devoted to the preparation of the Arab World Institute/Royal Commission for AlUla (RCU)¹ **exhibition entitled "AlUla, wonder of Arabia. The oasis with 7000 thousand years of history"**, due to open on October 9th, 2019.
- 2019 saw the completion of the 264 pages volume entitled *Archéologie au pays des Nabatéens d'Arabie. Guide de Hégra*, which came out of press on September 6th, 2019.
- 2019 was the first year of **cooperation with the French Agency for the Development of Al-'Ulâ (Afalula)**. The project's director was appointed "Special advisor to the President". This included many meetings and presentations, mainly in Paris but also in Riyad and London. Besides, advice was given to Royal Commission for AlUla, Ferrandi School of Culinary Art, Iconem, Setec, Ateliers Jean Nouvel, Institut d'aménagement et d'urbanisme d'Île-de-France, etc.

WEBSITES:

RCU: <https://www.rcu.gov.sa/#!/home>

Afalula: <https://www.afalula.com/>

Al-'Ulâ IMA exhibition: <https://www.imarabe.org/fr/expositions/alula-merveille-d-arabie>

Winter at Tantora festival: <https://www.winterattantora.com/en/Pages/WinterPublic.aspx>

1. AlUla is the orthography chosen by RCU for al-'Ulâ, but we have decided to keep here the "correct" orthography based on the usually accepted transcription from Arabic.

List of participants to the 2019 season (fig. 1)

The project had the pleasure to welcome, for the very first time since 2002, three female students in archaeology from King Saud University.

	Name	Function	Nationality	Affiliation
1	DELHOPITAL Nathalie	Anthropologist	French	Private company
2	DURAND Caroline	Pottery specialist	French	CNRS, HiSoMa
3	EGAL Florent	Expedition advisor	French	Airbus Helicopter, Riyadh
4	FIEMA Zbigniew	Archaeologist	Polish	University of Helsinki, Finland
5	GAZAGNE Damien	Archaeologist	French	EVEHA
6	AL-HUWAYTÎ Ahmad	Archaeologist	Saudi	SCTH
7	HUMBERT Jean	Draughtsman	French	Self-employed
8	ILIOGLOU Ariadni	Draughtswoman	Greek	Self-employed, student
9	AL-JUHANÎ Maha	Archaeologist	Saudi	KSU student ²
10	AL-MUQBIL Saad	Archaeologist	Saudi	SCTH
11	AL-MÛSA Maher	Archaeologist	Saudi	SCTH
12	AL-NAJM Zâhir	Driver	Saudi	SCTH
13	AL-NAWFAL Samar	Archaeologist	Saudi	KSU student ³
14	NEHMÉ Laïla	Archaeologist & epigraphist	French	CNRS, Orient & Méditerranée
15	NORRIS Jérôme	Epigraphist	French	PhD Student, University of Lorraine
16	PEILET Marie	Restorer	French	Self-employed
17	PIERRE Alain	Intendant	French	Retired person
18	AL-QUNAYBIT 'Awâtif	Student	Saudi	Postdoctoral researcher ⁴
19	AL-SABHAN Ibrâhîm	Archaeologist	Saudi	SCTH
20	STUDER Jacqueline	Archaeozoologist	Swiss	Geneva National Museum of Natural History
21	AL-TALHI Daifallah	Archaeologist	Saudi	University of Hâ'il

There were thus nine **Saudi Arabian** members, three female and six male, nine **French**, one **Swiss**, one **Polish**, and one **Greek**.

To these were added two cooks, one **Indian** and one **Sudanese**, as well as one **Bangladeshi** handyman. The workmen were all **Egyptian**. Nine nationalities were therefore represented in 2019.

The 2019 season was not only the first one to which participated three female students. It is also the first season during which the female members of the team were allowed to **drive**. They had never done so before, except in the desert.

The team stayed in the buildings of the **Hijâz railway station** but moved southwards because of the installation, in some of the buildings it had previously been accommodated in, of the Special Forces for Security and Protection (SSFP) created by the Saudi government to accompany the touristic development of the al-'Ulâ region.

2. Master student at King Saud University working on prehistoric lithic material.

3. PhD student at King Saud University working on the decoration of the Taymâ' pottery.

4. She has done a PhD in 2016 on the traditional pottery from Jîzân.



Fig. 1. The 2019 team. From left to right and from top to bottom: I. al-Sabhân, J. Humbert, D. Gazagne, A. Al-Qunaybit, A. Pierre, A. Ilioglou, J. Studer, C. Durand, Z.T. Fiema, S. al-Muqbil, L. Nehmé, Shahâbeddine, M. al-Mûsa, N. Delhopital, A. Al-Huwaytî, Râjô.

On a completely different register, it was decided, in 2019, to proceed to the **sorting of waste** in order to reduce the impact of the team on the environment. Plastic bottles were replaced by **metallic reusable flasks**, 12 units of which were distributed to the team members. Finally, in order to increase the group cohesion, special long-sleeve T-Shirts were produced with a **Madâ'in Sâlih project logo** made by I. Prieto⁵ (**fig. 2**).

2019 was unfortunately a year marked by severe **rains and floods** which disturbed the excavations and caused quite a lot of damage to the tracks (**fig. 3**).



Fig. 2. Madâ'in Sâlih project logo created in 2019.



Fig. 3. Sounding in Area 6 a few days after heavy rains. Some of the sections and walls collapsed.

5. CNRS Orient & Méditerranée Communication officer.

The 2019 fieldwork season

Excavations

Three areas only were excavated in 2019, following the decision to refocus on the residential part of the site and to give priority to the **two major buildings** excavated in the last few years : the **Nabataean sanctuary** and its immediate surroundings (see the reports by D. Gazagne and M. al-Mûsa *et alii*) and the **Roman fort** (see the report of Z.T. Fiema) ;

The Nabataean sanctuary

Considering that the extensive scraping of the temenos wall is now achieved, only limited cleaning and scraping had to be undertaken in 2019 in areas where the outline of the wall was not clear yet: at the point, west of outcrop IGN 132, where the wall connects with it, and in the southern central part, where the wall was probably built in mudbrick. The connection between the wall and IGN 132 was clearly evidenced (Gazagne fig. 3).

Apart from the operations on the temenos wall, sounding 7, in the northwestern corner of the sanctuary, was extended in order to put to light one **entrance to the sanctuary** in its entirety. Besides, two rooms outside the northern temenos wall were emptied and one large sounding was excavated down to the bedrock in the central part of the platform where the lower temple stood. Preserved levels from the Nabataean down to the late Roman periods (first to last phases of occupation, 1st to 4th/5th centuries AD) were put to light, along with a very nice series of five preserved small ovens, probably **kitchen ovens** (fig. 4) used by the people who occupied the area of the temple in the Roman period to undertake handicraft activities of some sort which are still to be defined (some hypotheses have already been put forward but need to be checked).

South of outcrop IGN 132, a large sounding was opened under the responsibility of Maher al-Musa and it yielded very interesting structures: a **Nabataean one**, which unfortunately extends south of the 2019 baulk; an architectural unit dated to the Roman period which reuses a Nabataean wall, and finally a **street**, which was later blocked, probably when it was decided to install a room leaning on the southern flank of the outcrop through wooden beams inserted in holes carved several meters above the ground.



Fig. 4. 3D view of the Roman period ovens put to light on the lower terrace of the Nabataean sanctuary.

The Roman fort

The investigation of the Roman fort at Hegra started in 2015 and four fieldwork seasons already took place (2018 was a study season). The report provided by Z.T. Fiema in this volume, rather than being a full report on the 2019 season, offers a synthesis on the first four excavation seasons. The reason for this choice is that the *2019 fieldwork season yielded very large quantities of material which need to be fully studied before being presented*.

In 2019, the work focused on the area immediately north of the so-called “citadel”, i.e. Hill B, the rocky outcrop which flanks the fort to the east and which was probably used as a stronghold in both the Nabataean and Roman periods. Several rooms were uncovered, one of which (XVII), rather large, yielded a lot of pottery material, part of which probably came from the citadel above it (Fiema fig. 8). It also yielded two water pipes, suspensura tiles and square pilae which are evidence for the probable use of the room as part of a **bath installation**. In another room (XV), evidence was found of a “post-bath” heated installation, with a well preserved *praefurnium* (Fiema fig. 9).

Finally, west of the rooms which extend on the northern slope of Hill B, a long and narrow area flanked by north-south walls was cleared and the remains of a **broad gate** to the fort were uncovered, flanked on the west by a massive tower-like structure. A few slabs represent the pavement of the passageway (Fiema fig. 11).

The excavation of the fort will continue in 2021.⁶

Survey

The 2019 season was the first season of the Al-‘Ulâ-Medina survey and although it was initially planned to write a full preliminary report on the survey, it was finally decided to postpone this to after the second (2020) season. The main reason is that the team, who explored one of the possible roads in 2019, was not convinced, through the results obtained, that the route it followed was indeed the ancient one. Only the pottery collected during the survey is the object of a report by C. Durand in this volume.

The first season of the survey was undertaken with two cars, one from the French side and one from the Saudi side. The team was composed of Ahmad al-Huwaytî and Ahmad Humud al-Juhany (the latter from the al-‘Ulâ museum) on the Saudi side, and Florent Egal (expedition advisor), Jérôme Norris (PhD student in Semitic epigraphy) and Laïla Nehmé on the French side. The survey first concentrated on the road as described by Drs Abdallah an-Nasif, Ali al-Ghabban (2011) and A. De Maigret (1997), along Wadi al-Jizl and Wadi al-Ḥamd. It then visited the site of Şuwaydrah, east-northeast of Medina, already published by Saad al-Rashid in 2009. This is because one Nabataean inscription from there published in S. al-Rashid’s book, mentions a *strategos*, that is a Nabataean “governor” (fig. 5). A second Nabataean inscription mentioning a governor, previously unpublished, was discovered in 2019 alongside other new Nabataean inscriptions.

After this first road, the survey moved to another road, east of the Hijaz railway and going east-southeast from Madâ’in Sâlih. A few inscriptions were found along this road, but the team

6. Z.T. Fiema being at Princeton (Institute for Advanced Studies) in 2020, the next season will take place only in 2021. Two or three more seasons are necessary in order to get a rather complete image of the fort.



Fig. 5. Nabataean inscription from Şuwaydrah published by S. al-Rashid in 2009 (“May Damasî son of Hanî’at the governor be safe”).

did not go very far this year for lack of time and will continue in 2020, hopefully camping one or two nights on the way in order to avoid coming back to al-‘Ulâ every evening.

Laboratory work

Apart from the field activities, the work in the laboratory went on, with a focus given this year to the study of the **animal bones** by Jacqueline Studer and to that of the **pottery** by Caroline Durand, in view of the preparation of the volume on the Madâ’in Sâlih pottery by the latter and Yvonne Gerber, the two project’s ceramicists. Besides, the study of the **human bones** from previously unlooted tomb IGN 116.1, excavated in 2015, where 27 skeletons were put to light was also completed by Nathalie Delhopital. One should also note the cooperation between Nathalie Delhopital (anthropologist) and Jacqueline Studer (archaeozoologist) for the examination of a supposedly decapitated skull discovered in 2017 in a recessed refuse dump, against the inner rampart, south of wall 35008 which belongs to tower no. 12 (see F. Villeneuve in the 2017 report, p. 60 and fig. 15 p. 67).⁷ Nathalie Delhopital examined the skull from the anthropological point of view while Jacqueline Studer confirmed that the individual has indeed been decapitated and also that he had, prior to that, been wounded in the eye by a projectile (see Delhopital’s report in this volume).

Ariadni Ilioglou **drew** the pottery and the objects and initiated to this technique the King Saud University students. Marie Peillet continued her patient work on the **cleaning and restoration of the metallic** and other objects (see her report).

Finally, the team started to prepare the artefacts to be exposed for the **AIUla exhibition** (see below) due to start in the Arab World Institute in Paris on October 9th, 2019.

Other activities

As is always the case, the team took the opportunity of its presence on the field to undertake small operations. Two of them can be mentioned.

7. A publication is planned on the skull and its context.



Fig. 6. 3D view of the watch tower on top of Jabal Ithlib.

Photogrammetry

It was decided to take photographs in view of a photogrammetric restitution of three features from Madâ'in Sâlih:

- the seven **Roman ovens** put to light in 2019 by Damien Gazagne in area 61 (*loci* numbers 61939, 61940, 61941, 61942, 61943, 61938 and 61961) (see **fig. 4**);
- the **Dadanitic/Lihyanite tomb** discovered on top of Jabal Ithlib in 2016;
- the **Dadanitic/Lihyanite watch tower** located close to the above mentioned tomb (**fig. 6**).

A C¹⁴ date is now available for the human bone retrieved in the tomb and it will be published along with the inscriptions and the watch tower when the latter two are excavated, hopefully in 2020.

Facial restitution of a Nabataean “family”

In the framework of a project of restitution of a Nabataean “family”, Nathalie Delhopital, the project’s anthropologist, took the opportunity of her presence in Madâ'in Sâlih to select **three Nabataean skulls** among those which have been put to light during the excavations of the Nabataean tombs at Madâ'in Sâlih: one male, one female and one immature (under 19 years old). Nathalie Delhopital also examined, while she was on site, the proposals made by firms specialised in this kind of technology in order to help the Royal Commission for AlUla choose the most adequate one. The selected firm is **Visual Forensic**, associated with the **Batabat** film company, which will do a documentary movie on the project. A launching meeting of the project was held in the British Academy in London on September 17th, 2019, in the presence of all the persons involved and of several scholars specialised in Nabataean archaeology (C. Durand, L. Nehmé, C. Tuttle, L. Wadeson).

Visits

All visitors were welcomed by the project director and taken for a visit the length of which varied from a couple of hours to a full day.

- Hadrien Rozier (**French Embassy**) and Sophie Rozier (Business France): January 25th.
- Zeghidour Slimane (**editor-in-chief, TV5**): January 25th.
- Gérard Mestrallet, Afalula CEO (**Afalula**) and Joëlle Mestrallet (**La Morsanglière stud farm**), accompanied by Laura Kwiatowski, General secretary (**Afalula**): February 1st.
- Olivier Klein (vice president of **French Equestrian federation**) and Luc Archambeaud (Business Development Manager of **French firm Cultures espaces**);



Fig. 7. Group of French museum directors and others visiting Madá'in Sâlih.



Fig. 8. Laïla Nehmé showing around to Jean Nouvel and Hala Warde.

- Group of French **museum directors**, Afalula and Total employees, personalities:⁸ Februray 8th (**fig. 7**);
 - Architects **Jean Nouvel and Hala Warde** (**fig. 8**), February 9th.
- Other VIP visits are not mentioned in this report.

8. Frank Barbaro (Afalula), Benoît Chague (Total), Régis Dantaux (Afalula), Renaud Donnedieu de Vabres (former French Ministry of culture), Jean-François Hebert (Fontainebleau castle), Marie-Christine Labourdette (Cité de l'architecture et du patrimoine), Laurent Le Bon (Picasso museum), Nicolas Lefèvre (Afalula), Charles Støeng (Total), Hervé Lemoine (Mobilier national et manufactures), Alberto Vial (Louvre Museum).



Fig. 9. Installation of the Dadan monumental statues in the IMA exhibition, September 26th, 2019

Preparation of the “AlUla, wonder of Arabia” exhibition

The end of 2018 and the whole of 2019 were very busy with the organisation of the exhibition entitled in French “**AlUla, merveille d’Arabie. L’oasis aux 7000 ans d’histoire**”, due to open on October 9th, 2019, in the Arab World Institute (IMA) in Paris, for which see:

<https://www.imarabe.org/fr/expositions/alula-merveille-d-arabie>

This exhibition is organised jointly by IMA and the Royal Commission for AlUla and it aims at presenting the region of al-‘Ulâ (preferred academic spelling) from a historical and archaeological point of view, from the first traces of occupation, ca. 5000 BC, to the contemporary period. As **co-curator** of the exhibition with Abdulrahman Alsuhaibani, Laïla Nehmé followed all the elaboration process of the exhibition from A to Z, and this includes all the very many steps though which an exhibition has to go before the invitations can be sent for the opening (**fig. 9**). This exhibition being an “immersive” one, many large screen videos, interviews, 3D animations, restitutions, etc. are proposed, each of which required elaboration, following and validation.

Medias

TV documentaries and reporting

– From the Madâ’in Sâlih point of view, the main reporting was the one done by Patricia Alémonière (**fig. 10**) for the **8 pm television news on TF1** (French TV1, TF1). It is a 5’46’’ reporting and was broadcasted in early March 2019. It is available on request.

– **Abu Dhabi Television**, January 31st;

– **Heritage Valley (wâdî al-turâth)** Youtube channel, May 2019:

https://www.youtube.com/watch?feature=youtu.be&v=up-t0BfG_uE&app=desktop

Press

– A four page portrait of L. Nehmé was published in **Le Point magazine** on **May 3rd, 2019** (<https://www.orient-mediterranee.com/spip.php?article4117>).



Fig. 10. Laïla Nehmé and Patricia Alémonière at Madâ’in Sâlih in February 2019.

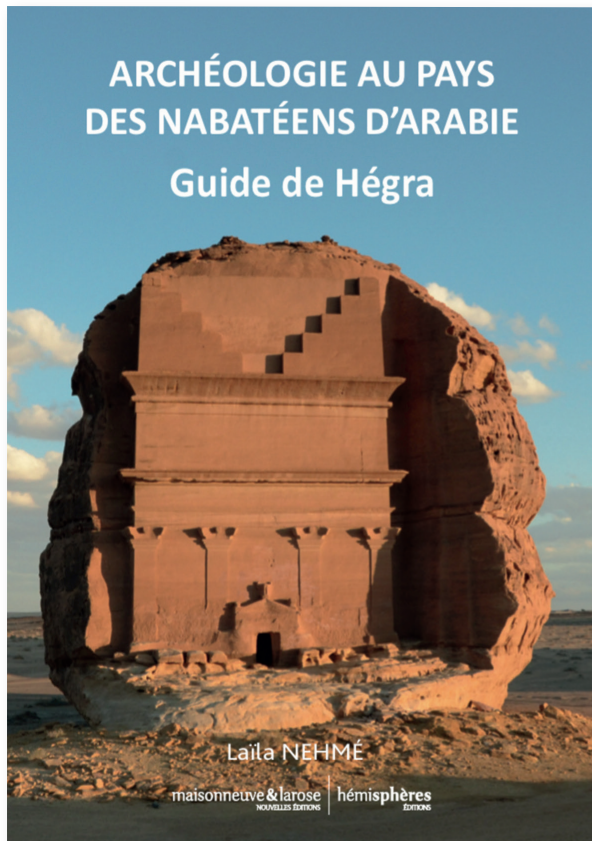

Publications and conferences

Guide of Hegra

The volume entitled *Archéologie au pays des Nabatéens d'Arabie. Guide de Hégra*, by Laila Nehmé, published by Maisonneuve&Larose | Hémisphères has come out late September 2019 (fig. 11). It is a 264 pages volume, half of which contains general chapters on the Nabataeans, their history, religion, funerary rituals, etc. whereas the other half is a detailed visit of the site (fig. 12). It also has focuses, a glossary, a bibliography, an index and at least 250 illustrations.

Fig. 11. Cover page of the Guide de Hégra book.





SOMMAIRE		
	Remerciements	7
	Pourquoi un tel guide ?	11
	Transcriptions	12
	De l'arabe	12
	Du nabatéen	13
	1. Préambule	15
	Les différents noms du site	17
	Hégra et al-Hijr dans les sources grecques et latines, dans le Coran et chez les auteurs arabes	18
	Une brève histoire des recherches	23
	Géographie et environnement	29
	La géographie	29
	Le climat	31
	La végétation	35
	La faune	36
	Les ressources en eau	38
	2. Jalons historiques	43
	Qui sont les Nabatéens ?	47
	Madâ'in Sâlih dans l'histoire	55
	L'âge du Bronze	55
	Hégra avant l'arrivée des Nabatéens	57
	Les Nabatéens à Hégra	60
	Hégra à l'époque romaine	64
	3. Langue et écriture nabatéennes	71
	4. La religion des Nabatéens à Hégra	81
	5. Les tombeaux de Hégra	93
	L'architecture et le décor architectural	95
	Les techniques de taille	109
	Les rites funéraires nabatéens	121
	6. La visite du site	129
	La gare du Hijâz et le fort ottoman	131
	Le puits n° 21 et les tombeaux du Jabal al-Khraymât	137
	Le « puits nabatéen » et le Jabal al-Mahjar (nécropole A)	153
	Le Jabal Ithlib et les monuments religieux	163
	Le Qaṣr al-Bint, une nécropole de prestige (nécropole B) ..	179
	Le Qaṣr al-Farîd, ou le tombeau d'un ambitieux	195
	Le Jabal al-Aḥmar (nécropole C)	199
	Quelques tombeaux éparpillés	203
	Vestiges laissés par les derniers occupants du site	207
	Mais où étaient les habitants dans l'Antiquité ?	213
	Glossaire	227
	Pour aller plus loin	233
	Index	247
	Crédits photos	255
	Les focus	
	Petite chronologie des Nabatéens	44
	Extrait du texte de Diodore de Sicile	52
	Extrait de la <i>Géographie</i> de Strabon	53
	Les occupations les plus anciennes	58
	Deux inscriptions latines	67
	Une inscription nabatéenne	78
	Le chemin de fer du Hijâz	133

Fig. 12. Table of contents of the Guide de Hégra.

Other

The year 2019 was also devoted to the preparation of the **exhibition catalogue** of the “Alula, wonder of Arabia” exhibition, published in September 2019 in three languages (French, English, Arabic).

Finally, after a long elaboration process, the article on the **Latin and Greek inscriptions** from Hegra, written by Z.T. Fiema, F. Villeneuve and Th. Bauzou is in the press in the *Zeitschrift für Papyrologie und Epigraphik*.

Several other contributions were produced by members of the team but the list of references is not available yet.

Contributions to the Red Sea IX conference, Lyon, July 2019

Three members of the Madâ'in Sâlih team offered lectures related to Madâ'in Sâlih during the **Red Sea IX conference**:

- Opening lecture by Laïla Nehmé: “Land (and maritime ?) routes in and between the Egyptian and Arabian shores of the northern Red Sea in the Roman period”;
- Caroline Durand and Francelin Tourtet: “North-West Arabian trade networks in the 1st millennium BCE”;
- Juliette Milon *et alii*: “Diffusion of Cotton in Northeastern Africa and Arabia: New Morphometric and Chronological Data”.

References

- Al-Ghabban A.I. 2011: *Les deux routes syrienne et égyptienne de pèlerinage au nord-ouest de l'Arabie Saoudite*, Le Caire, IFAO (coll. Textes arabes et études islamiques), 2 volumes.
- de Maigret A. 1997: « The Frankincense Road from Najrān to Ma'ān: a Hypothetical itinerary », in AVANZINI A. (DIR.), *Profumi d'Arabia. Atti del convegno*, Roma, p. 315331.
- Al-Rashid S. 2009: *Aṣ-Ṣuwaydirah (aṭ-ṭarf qadīman). 'Āṭāruhā wa nuqūshā al-'islāmiyyah, ar-riyāḍ*.

The Roman Fort in Hegra

Summary of the First Four Seasons of Fieldwork

Zbigniew T. Fiema (University of Helsinki)

The Saudi-French Mission which, since 2008, investigates the Nabataean-Roman town of Hegra (modern Madā'in Šāliḥ), provided significant information on the nature of the Roman military presence there. This information includes epigraphic data collected at the so-called south-east gate, in Area 35, and the archaeological data retrieved through the excavations of a Roman fort in Area 34 (Fiema and Villeneuve 2018). During the four seasons (2015, 2016, 2017, and 2019), the excavations at the site of the fort were carried out in five large trenches (A–E) and the entire interior of the fort was subjected to surface clearance and material collection. The following text provides a convenient summary of the data recovered during the fieldwork.

Short description and finds

The landscape of the archaeological site at Madā'in Šāliḥ is generally featureless but two hills, A and B, at the southern limits of the site, are significant landmarks. The Roman fort is located directly west of Hill B. On the top of that hill there was once a large citadel but its use as a quarry in the 20th century has obliterated any meaningful remains (**fig. 1**). The fort, located on the stony plateau extending westward from Hill B, is ca. 85 m (E-W) and over 65 m (N-S) and is limited by three perimeter walls and the slope of the hill (**fig. 2**).

The complex is a quadrangle consisting of the perimeter walls and series of rooms surrounding an irregular central courtyard (**fig. 3**). The bedrock rises everywhere to the central point in the fort where poorly preserved remains (including some column drums) have been found. The best preserved structural element of the fort is the southern perimeter wall, ca. 65 m long and running the WNW-ESE course, which joins on the eastern end with remains of a poorly preserved stone wall, ca. 18 m long. That wall runs the ENE-WSW direction and it represents pre-Roman (Nabataean) remains in Area 34 (*infra*). At the western end of the southern perimeter wall there is the SW corner tower integrated in the corner formed by the main southern and western walls. While the plateau ends in the area of that tower, another wall continues beyond the tower and westwards, on the same line as the southern perimeter wall, to the place where yet another square corner tower with projecting sides was excavated.

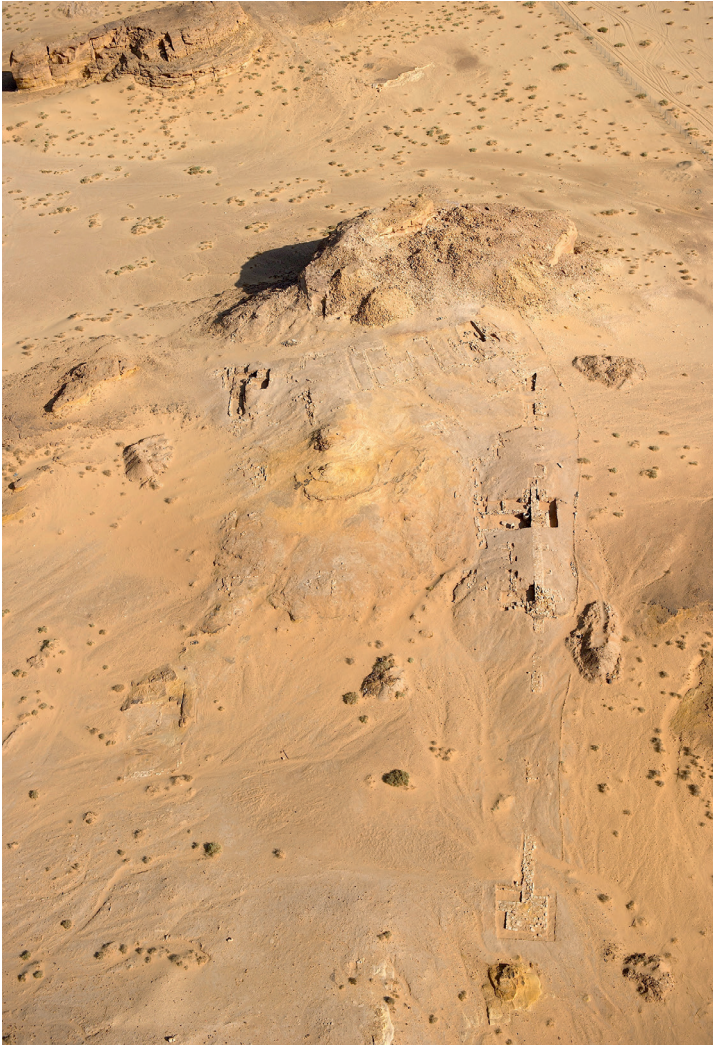

Fig. 1. Area 34. The fort and the citadel (by D. Kennedy/APAAME).



Fig. 2. The Roman fort in Madā'in Šāliḥ (by FalconViz).

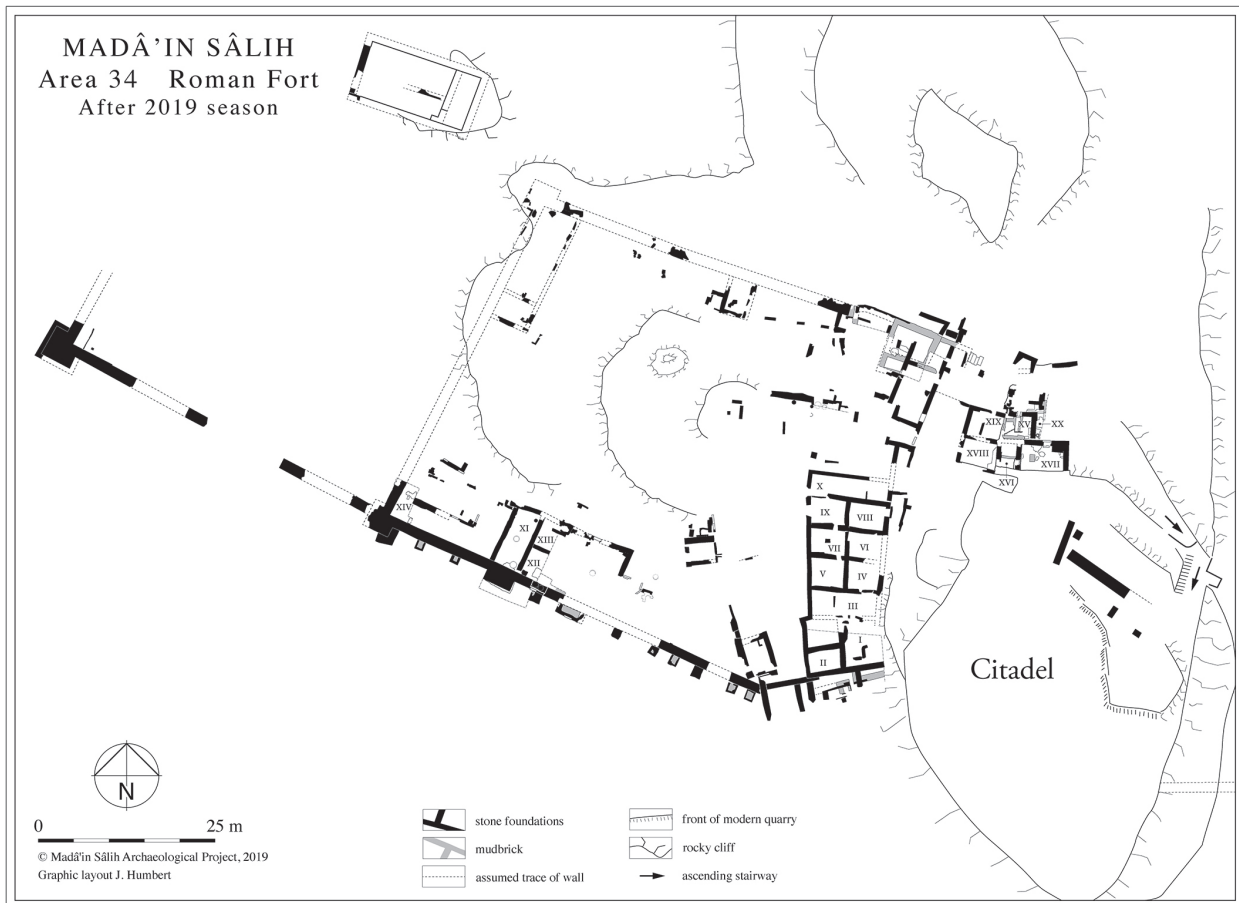

Fig. 3. The plan of the fort in Madā'in Sālih following the 2019 fieldwork season (by J. Humbert).

Ca. 23 m east of the SW tower is a small gate, ca. 2.10 m wide, flanked by two solid, rectangular towers or large buttresses ca. 4.00 x 1.70 m each (**fig. 4**). The foundation deposit of the gate-flanking towers yielded late 1st-early 2nd century–dated sherds. A room (No. XI) adjacent to the gate on the NW side was occupied in the 2nd–3rd centuries, but by the mid-3rd, most of the floor's flagstones were removed, the gate was blocked by inserting two stone basins and the stacks of flagstones, and a small buttress was built outside, in front of the blocking. This buttress is one of nine small buttresses, roughly square, varying from ca. 1.30 x to ca. 1.60 m, which must be later in date than the southern perimeter wall (see figs 2 and 3).

Some internal walls, perpendicular to the perimeter walls, imply the presence of rooms but the interior of the fort is currently relatively empty. The exception is the eastern part, located at the foot of Hill B, where a wing of rooms has been found. (see figs 2 and 3). Apparently, the walls of these rooms followed the contours of the terrain there as well as the orientation of pre-existent structures incorporated into the Roman fort. The wing features units which are two-room deep (Rooms III-X), 3.6 m wide and 5 m deep, resembling *contubernia* in Roman forts.

The excavations provided very large quantities of ceramics, mostly of the 1st BC/AD–3rd centuries date but 4th century types were also present. Imported material included Kapitān II amphoras, Eastern *terra sigillata* and African Red Slip ware. More than 150 coins, including Nabataean, Roman and probably local (the so-called "Athena/owl" type) were found. Numerous bronze objects included fragmentary hooks, binders, plates, metal straps/bands, buckle rings and faste-

ners, and strap-junctions and terminals, many presumably parts of specialized military horse harness. For example, of interest is the openwork baldric fastener of sword belt (fig. 5), which finds good 2nd–3rd century parallels from Dura Europos (James 2004: 52, 62, 74–75, nos 18–20). Several bronze plates feature series of punched holes, perhaps scales of *lorica squamata* but since none have patterned holes for vertical and horizontal stitching, these might be local repairs,



Fig. 4. The southern gate and the flanking towers (by Z.T. Fiema).



Fig. 5. The openwork baldric fastener of sword belt (Madā'in Šāliḥ Archaeological Project).

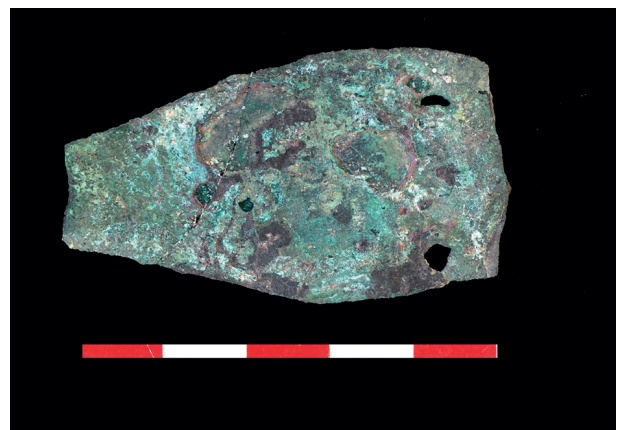

Fig. 6. Possible bronze armor scale (Madā'in Šāliḥ Archaeological Project).



Fig. 7. Bronze objects from Room XI (Madā'in Šāliḥ Archaeological Project).

replacements, or segments of horse armor (fig. 6). Other bronze objects include a female head which is part of a vessel's handle, a Roman fibula, an oversized finger of a statue, a hind leg of a bull statuette and a small figurine of the Egyptian deity Bes. Iron objects were rare but included an axe or pickaxe of type often found in Roman contexts. Of interest was the deposit of bronze figurines found under the overturned bottom of a basin in Room XI, which included a figurine of domestic male goat, a tree-trunk-shaped lamp-stand, a male figurine of Satyr emerging from a flower, and a figurine probably representing the Greek-Egyptian deity Harpocrates (fig. 7). The dating of this deposit – end of the 3rd/early 4th c. – may imply a ritual burial of artifacts either at the end of the military use of the fort or at the beginning of the subsequent civilian re-occupation of the space. Additionally, the excavations provided one inscription written in Ancient South Arabian script and one written in Ancient North Arabian script. A Latin inscription, also found in the fort and dated to AD 213–217, mentions an imperial freedman (Fiema, Villeneuve and Bauzou, forthcoming).

The area of the fort also provided large number of broken basalt millstones, including large Pompeian-type hourglass mills (both *catilli* and *metae*) as well as smaller querns and rotary hand-mills. Finally, the archaeozoological evidence indicates that the nature of habitation in the fort is clearly different from that attested in other excavated areas in Madā'in Šāliḥ. Consumed species included large mammals – cattle, camel, donkey, horse. Sheep and goat, while more common elsewhere in Hegra, were also present although represented by adults only and with no extremities preserved. These aspects reflect a overall policy of wholesale purchase, butchering and redistribution, just like in the context governed by a military commissariat.



Fig. 8. The NW sector of the fort. The tower in Trench D, the northern gate, the passage, and the rooms excavated on the northern slope of Hill B (by Z.T. Fiema).

The 2019 fieldwork Season

The 2019 fieldwork season yielded very large quantities of material, including pottery and coins, which will require further studies. Therefore, full report will be provided at a later date. Here, only a short summary of results is presented. The work concentrated on the northern slope of Hill B, which continues northwards as a stony spur. This sector, which topographically may appear somewhat external to the fort, was definitely a part of it from the functional standpoint. The uncovered spaces included a large, well constructed room (No. XVII) which abuts the cliff of Hill B, and other rooms located further north and west of Room XVII (**fig. 8**, see **fig. 3**). Large quantities of ceramics, some of which probably originated from the citadel, were found there. The finds also included two water pipes, two large rectangular *suspensura* tiles as well as few square *pilae* used in hypocaust system. Quantities of ash found in this sector imply the existence of some kind of heating installation. To the NW of Room XVII, remains of what appears to be a “post-bath” phase of a small heated room (No. XV) were uncovered (**fig. 9**). The *praefurnium* is well preserved, and the clear depressions in the bedrock indicate the bottom of heated air ducts but all other elements had been removed already in antiquity. What currently remains is a long ceramic pipe which provided water/air (?) to the center of the room, apparently no longer related to the original function of the room (**fig. 10**).



Fig. 9. ROOM XV, the heated room (by Z.T. Fiema).



Fig. 10. The disassembled ceramic pipe from Room XV (by Z.T. Fiema).



Fig. 11. *The remains of the northern gate of the fort (by Z.T. Fiema).*

Directly west of the complex of rooms on the northern slope of Hill B, there is a long and narrow area, flanked by N-S walls (see figs 3 and 8). It was long suspected that there was a way leading from the fort into the town of Hegra. During the 2019 season, remains of a broad gate have been uncovered. Large slabs there represent the pavement of the passageway, surrounded by the remains of the gate's structure (**fig. 11**). The gate was flanked on the western side by a massive tower-like structure. Apparently, the ground there rapidly slopes northwards and the construction of the tower flanking the gate required the presence of a massive levelling substructure made of mudbrick walls with spaces in-between filled in.

Phases of occupation

By the 1st century AD, the Nabataean town of Hegra was surrounded by the mudbrick-built rampart (Villeneuve 2014). The circuit was continuous, including Area 34 where a stone wall was built on the steep western slope of Hill B. The lowermost deposits in Room I, which is adjacent to the Nabataean stone wall, yielded 1st century AD ceramics and a double burial (male and female). That Nabataean stone wall could have continued westwards in the form of a mudbrick-built rampart but if so, it would have been completely demolished by the Romans when the fort was constructed. Generally, the nature of the Nabataean-period occupation in Area 34, while attested, is not clear but it is highly probable that the top of Hill B was already utilized then as a citadel.

During the early period, following the annexation of the Nabataean Kingdom by Trajan in AD 106, major cities, such as Bostra, Gerasa, Gadara and Philadelphia were garrisoned by the army units (e.g., Freeman 1996: 101, 105–107). Some urban garrisons might have utilized civilian billeting but in the Nabataean settlement of Hawara/Hauarra (Humayma in southern Jordan), a fort was constructed in the early 2nd century (Oleson 2009). Probably soon after the annexation the army base was also established in Hegra. The presence of Roman army units or their personnel, including *legio III Cyrenaica* – the main military unit in Roman Arabia, *ala I Ulpia drome(dariorum) Palmyr(enorum) (milliaria)* and *ala Gaetulorum veterana* is attested by several inscriptions and graffiti found in the environs of the town (Speidel 1977: 703–706; al-Talhi and al-Daire 2005; Gatier 2018). Area 34, including the citadel on top of Hill B, occupies a superb tactical location with all-round visibility and offers an excellent vantage observation point, particularly suitable for monitoring the town. Such dominance of Area 34 must have been easily recognized by the Roman occupation forces tasked with overseeing of activities in the conquered town and defending it from a potential external foe. The use of the modular system based on Roman feet, well attested in Humayma (Oleson 2017), is also evidenced in Hegra, clearly implying the planning by Roman engineers. Admittedly, and as opposed to the traditional layout of Roman forts, the eastern part of the fort at Hegra was irregular because the integration with Hill B offered definite tactical advantage, and thus the incorporation of the Nabataean stone wall and its adjacent structures was inevitable. The central and western parts of the plateau allowed the imposition of a more regular quadrangular plan, featuring all three perimeter walls and corner towers (see figs 2 and 3).

The fort in Area 34 should be dated to the early–mid-2nd century and thus it is probably one of the earliest military structures in Roman Arabia. The fort at Humayma provides the closest temporal and the meaningful structural parallels for the Hegra fort, especially with regard to the corner and curtain towers and the squared-off angles. In addition to the gates, flanking and corner towers, the earliest phase of the Hegra fort presumably also included inner structures, such as the presumed small bathhouse, and the eastern barracks. While other barracks or service rooms might have been built against the inner faces of the perimeter walls. Good parallels exist for barracks built against fort's circuit wall in smaller fortifications located in Africa and the East in the 2nd–3rd centuries (see Fiema and Villeneuve 2018: 710) as well as in Roman *praesidia* of the Eastern desert of Egypt, dated to the later 1st–3rd century (see Reddé 2006: 244–247 for presentation).

Sometime in the later 2nd century AD, the Nabataean wall was substantially reinforced by the addition of the casemate space, the mudbrick wall with the stone revetment, the cross-walls, and the “*glacis*”. That activity reflects perhaps the information from the Latin inscription of AD 175–177 found in Hegra (al-Talhi and al-Daire 2005) which implies the restoration of an “old wall” with the technical assistance of Roman officers. Whether or not in response to a potential threat, this reinforcement was probably a practical measure applied to a relatively weak and “ageing” Nabataean wall. It also might have been an element in a major overall bolstering of Hegra's fortifications in the later 2nd century. For example, the towers along the town circuit are later in date than the Nabataean mudbrick rampart. Since the distance between the towers is ca. 35 m, undoubtedly 120 p.M. was intended, equalling one *actus*, a standard module in use by Roman engineers.

These defences were apparently meant as a formidable deterrent and to strengthen the Roman prestige in the region. Yet, sometime by the mid-3rd century, the southern gate of the fort was blocked and nine small buttresses were built against the curtain wall. A massive robbing out of convenient reinforcement material (mainly large flagstones) from everywhere at the site indicates somewhat desperate measures in response to some kind of potential threat. The later 3rd century occupation was probably still military. But the abandonment of the fort in Hegra must have happened by the end of that century. Subsequently, the fort seems to have been reoccupied by civilian population of Hegra, and that occupation might have continued throughout the 4th century.

Function and Significance

With the dominant location of Area 34 in Hegra and the towering citadel which, according to the ceramics, must have been occupied throughout the Roman period, it is reasonable to assume that the complex consisting of the citadel and the adjacent fort functioned as the headquarters of all Roman military units in the area. Evidently, the fort in Hegra is too small (only a little over half a hectare in size) to accommodate any army unit larger than infantry *centuria* or cavalry *turma*. Thus, the soldiers of the two cavalry *alae*, who left inscriptions in the environs of Hegra were either billeted in the town or elsewhere in the environs of Hegra.

Further information on the function of the fort in Hegra is provided through the corpus of 14 Latin and Greek inscriptions found in Area 35 and mainly reused in the structure of the south-east gate of Hegra located there (Villeneuve 2014; Fiema, Villeneuve, and Bauzou, forthcoming). Five from among seven Latin inscriptions mention personnel from *legio III Cyrenaica* and two other mention soldiers who were probably legionaries. Additionally, one inscription mentions a *vexillatio* of the same legion. The dedicants, usually in pairs, often describe themselves as *stationarii (ad portam)*. Generally, *stationarii* were soldiers detached for this duty from their parental units, who monitored travellers' traffic, maintained road security and occasionally served as law enforcers in cities. They were also charged with verifying travel documents either at city gates or during the road patrols (see Petraccia 2001; and contributions in France and Nelis Clément 2014). Thanksgiving testimonies of *stationarii* at Hegra indicate satisfaction with a mission accomplished or return from a difficult patrol. One can infer from the presence of *stationarii* in Hegra that the town was a *statio* i.e., a road stop related to the imperial postal and transport system. But *statio* may also refer to urban army barracks with soldiers specifically charged with the protection of the population from any criminal activity (Petraccia 2015). At any rate, the fort in Hegra would make an excellent base for small detachments of *stationarii* posted at the nearby gate of the town.

The function of the fort in Hegra must also relate to the history of Hegra in the 2nd–4th centuries since it is reasonable to assume that the actual limit of Roman Arabia, i.e., the furthest extent of direct Roman administration ends just south of Hegra. It has been argued that the political-military and economic hegemony of Rome over the Red Sea region during the 1st and the 2nd centuries was effective through the network of dependent kings and allies on both sides of the Red Sea, the activities of the Roman fleet, and the presence of military outposts in strategic locations (for discussion, see e.g., Speidel 2007). Some Hijâz oases within Roman Arabia, such as al-Bad', Hegra and Dûmat al-Jandal would have been such bases of direct Roman military control.

Material culture remains recovered in Madā'in Šāliḥ imply stronger links with the Mediterranean than with South Arabia. Yet, besides the fort, the architectural remains of the Roman period are relatively modest (for discussion, see Villeneuve 2011). A revival of the Roman interest in the region dates to the Antonine period, exemplified by the Roman remains and inscriptions from the Farasan Islands (Villeneuve, Phillips, Facey 2004). As far as the currently available evidence indicates, which, however, may be selective and accidental, a revival was also briefly felt in Hegra between the reign of Marcus Aurelius and Caracalla, where the inscriptions imply various activities of Roman army personnel and archaeological record indicates the strengthening of the fort's defences. Yet the evidence related to the 3rd century indicates some unknown emergency marked by hastily undertaken further reinforcement of the fort. The military occupation of the fort is not attested beyond the end of the 3rd century. This may well correspond with the lack of historical information confirming the presence of Roman garrisons in NW Hijāz after the 3rd century (Fiema and Nehmé 2015). Nevertheless, the fort and the epigraphic material firmly establish the important position of Hegra in the Roman military history.

References

- Fiema Z.T. and Nehmé L. 2015: "Petra and Hegra between the Roman Annexation and the Coming of Islam", in G. Fisher (ed), *Arabs and Empires before Islam*. Oxford: 373–395.
- Fiema, Z.T. and Villeneuve F. 2018: "The Roman Military Camp in Ancient Hegra", in S. Sommer and S. Matesic (eds), *Limes XXIII. Proceedings of the 23rd International Congress of Roman Frontier Studies*, Ingolstadt, 2015. Mainz: 702–711.
- Fiema Z.T., Villeneuve F., and Bauzou Th.: "New Latin and Greek Inscriptions from Ancient Hegra", forthcoming in *ZPE*.
- France J. and Nelis-Clément J. (eds) 2014. *La statio. Archéologie d'un lieu de pouvoir dans l'empire romain*. Bordeaux.
- Freeman P. 1996: "The Annexation of Arabia and Imperial Grand Strategy", in D. Kennedy (ed), *The Roman Army in the East*. Ann Arbor: 91–118.
- Gatier P.-L. 2018: "Graffites rupestres des troupes auxiliaires romaines à Hégra", in L. Nehmé (ed), *Mission archéologique de Mada'in Salih. Rapport de la campagne 2018*. Paris: 23-37. > <https://hal.archives-ouvertes.fr/hal-02096625>
- James S. 2004. *Excavations at Dura-Europos 1928–1937*. Final Report VII. The Arms and Armour and other Military Equipment. London.
- Oleson J.P. 2009: Trajan's Engineers and the Roman Fort at al-Humayma (ancient Hawara, Jordan)", *Studies in the History and Archaeology of Jordan* X. Amman: 535–547.
- Oleson J.P. 2017: "The Modular Planning of Roman Fortifications in the Near East: Principles and Process", in W.D. Ward (ed), *The Socio-Economic History and Material Culture of the Roman and Byzantine East*. Piscataway: 237–272
- Petraccia M.F. 2001: *Gli stationarii in età imperiale*. Roma.
- Petraccia M.F. 2015: "Statio, Stationarii: Late Empire", in Y. Le Bohec (ed), *The Encyclopedia of the Roman Army*. Chichester.

- Reddé M. 2006: “Les fortins du désert Oriental d’Égypte et l’architecture militaire romaine”, in H. Cuvigny (ed), *La route de Myos Hormos*. Le Caire, 235–252.
- Speidel M.A. 2007: “Ausserhalb des Reiches? Zu neuen lateinischen Inschriften aus Saudi-Arabien und zur Ausdehnung der römischen Herrschaft am Roten Meer”, *Zeitschrift für Papyrologie und Epigraphik* 163: 296–306.
- Speidel M.P. 1977: “Roman Army in Arabia”, *ANRW* II.8. Berlin: 687–730.
- al-Talhi D. and al-Daire M. 2005: “Roman Presence in the Desert. A New Inscription from Hegra”, *Chiron* 35: 205–217.
- Villeneuve F. 2011: *Hégra en Arabie. Monumentalité et démonumentalisation: reflets directs du rôle de l’aristocratie urbaine?* Journée “Monumentalité urbaine”, 4 novembre 2011, INHA, Composante Mondes romains et médiévaux, Equipe Histoire Culturelle et Sociale de l’Art, Université Paris 1. > http://hicsa.univ-paris1.fr/documents/pdf/MondeRomainMedieval/Hegra_monumentalite_urbaine_n_vers.pdf
- Villeneuve F. 2014: “The Rampart and the South-East Gate (Area 35). Survey and Excavation Seasons 2011 and 2014”, in L. Nehmé (ed), *Report on the Fifth Season (2014) of the Madâ’in Sâlih Archaeological Project*. Paris: 17–73 <https://halshs.archives-ouvertes.fr/halshs-01122002>
- Villeneuve F., Phillips C., and Facey W. 2004: “Une inscription latine de l’archipel Farasan (sud de la Mer Rouge) et son contexte archéologique et historique”, *Arabia* 2: 143–190.

La fouille du grand sanctuaire (IGN 132)

Damien GAZAGNE (EVEHA) et Maha AL-JUHANY (King Saud University)

Les travaux récents (2016 et 2017) autour du sanctuaire ont été réalisés sous la supervision de Laïla Nehmé et de Damien Gazagne. Les résultats de ces deux campagnes ont permis de mettre au jour la majeure partie du mur de téménos et de cerner ainsi l'assiette complète du sanctuaire. Dans le même temps, plusieurs sondages ont été réalisés afin d'élaborer une première séquence chrono-stratigraphique de l'établissement cultuel. La campagne de fouilles 2019 s'inscrit dans la continuité de ce long travail de terrain. Trois objectifs lui ont été assignés :

1/ **Travaux sur le mur de téménos** : le décapage extensif du mur de téménos étant terminé, il restait à effectuer des travaux ponctuels de nettoyage et de décapage dans des secteurs où son tracé demeure incertain. Au moins deux endroits problématiques ont ainsi été identifiés : au nord-ouest d'une part, au niveau du raccordement du mur de téménos au rocher IGN 132 ; au sud d'autre part, où la partie centrale du mur, probablement en brique crue, n'est toujours pas visible.

2/ **Travaux sur la porte nord** : le sondage n° 7 a été étendu au nord pour mettre entièrement au jour le système d'entrée. Une coupe stratigraphique a été réalisée dans l'axe de la porte (NNO-SSE) afin de compléter sa séquence chrono-stratigraphique.

3/ **Travaux sur la terrasse basse du sanctuaire** : le périmètre du sanctuaire étant désormais connu, des fouilles extensives doivent être réalisées pour comprendre l'architecture et l'organisation interne de la terrasse basse. Dans la mesure où celle-ci est occupée par deux niveaux de bâti en brique crue, l'implantation d'un carroyage s'est imposée. Il a été constitué de carrés d'environ 5 m de côté entrecoupés de bermes avec pour objectif de permettre l'élaboration d'une séquence chrono-stratigraphique générale de la terrasse basse.

Pour atteindre ces objectifs, un nettoyage du secteur situé au nord-ouest du rocher IGN 132 a été effectué (objectif 1) et la fouille de la porte nord a été poursuivie (objectif 2). Par ailleurs, deux sondages ponctuels ont été réalisés dans les pièces périphériques du mur de téménos et deux grands sondages ont été ouverts à l'extrémité orientale de la terrasse basse (objectif 3) (**fig. 1**).

1. Travaux de décapage

1.1. Le tracé du mur de téménos

Le nettoyage du secteur situé au nord-ouest du rocher IGN 132 a permis de retrouver des traces ténues du mur de téménos (*locus* 60882, **fig. 2**). Son tracé à l'est se matérialise surtout par une saignée qui entoure la base du socle gréseux (**fig. 3A**). Une partie de cette saignée est d'origine

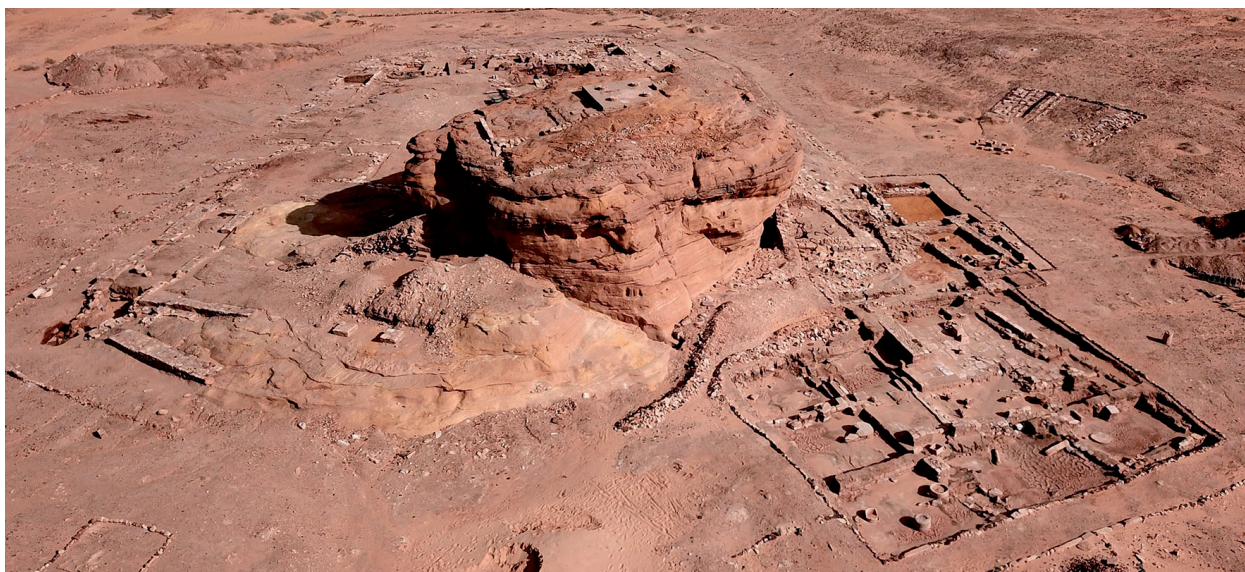

Fig. 1. Vue générale du sanctuaire depuis le nord-ouest (J. Bervillié, 2019).

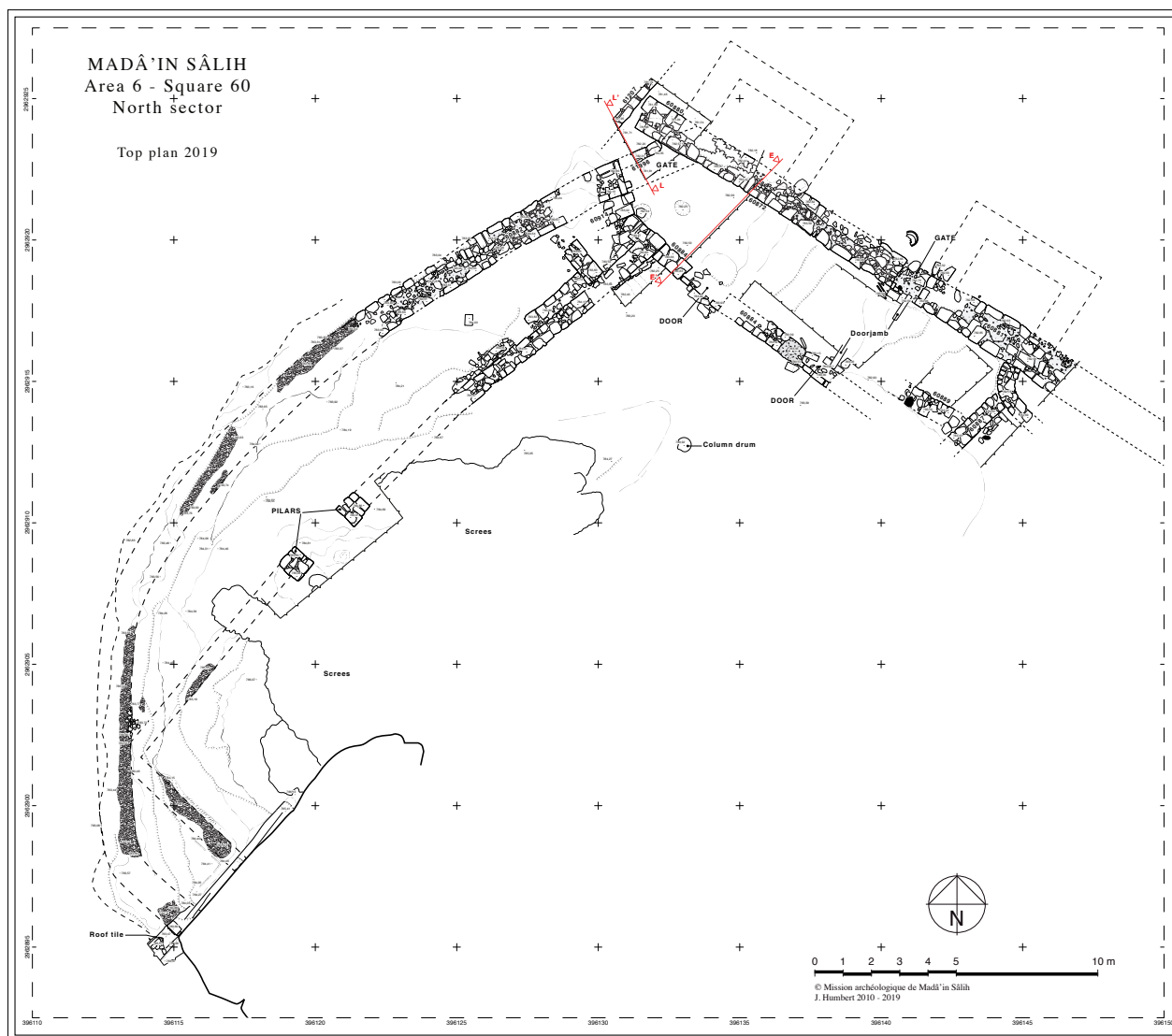

Fig. 2. Plan du secteur situé au nord-ouest de IGN 132.

naturelle. Le mur vient se raccorder à l'extrémité nord-ouest du rocher IGN 132 (**fig. 3B**). La niche à bétyles IGN 132c devait donc se trouver à l'intérieur de l'espace sacré, ce qui n'est pas surprenant. La fouille de la fissure naturelle située au pied d'IGN 132 a permis de mettre au jour un bloc en place appartenant au parement extérieur du mur 60882 (**figs 3C et 3D**). Le mur 60882 s'interrompt donc au pied du rocher IGN 132, la suite étant assurée par le rocher lui-même.

1.2. De nouveaux murs situés au nord-est d'IGN 132 : la porte d'entrée du sanctuaire ?

Dans le secteur situé au nord-est du rocher IGN 132, trois nouveaux murs ont fait l'objet d'un décapage de surface (**fig. 4**). Ces travaux permettent de comprendre un peu mieux l'architecture de la zone : les murs 61044 et 61990 forment un couloir qui assure la circulation depuis le mur de téménos jusqu'au centre de la terrasse basse (**fig. 5A**). À l'intérieur de ce couloir, la découverte d'un linteau en chute marque la présence d'une porte. Au sud, le couloir débouche sur le contrefort nord-est du rocher IGN 132. Sur la pente, le rocher, un grès jaune, est à nu. Il a gardé la trace d'une forte usure de 2 m de large sur 10 cm de profondeur (**figs 5B et 5C**). Cette large saignée dans le grès est probablement la trace du piétinement des pèlerins pour atteindre la rampe d'accès en terre qui mène au sommet de IGN 132. Le mur 61992, qui barre l'accès au rocher IGN 132, est postérieur à ce système de circulation. De facture et d'orientation différentes du bâti préexistant (murs 61044, 61990 et 61991), il pourrait marquer le découpage tardif du sanctuaire en deux secteurs distincts¹. Si l'on fait abstraction du mur tardif 61992, les éléments mis au jour dans ce secteur appartiennent à un système d'accès au sommet d'IGN 132 (**fig. 5D**). On peut supposer qu'il est relié à la porte d'entrée du sanctuaire, qui serait située au milieu du mur de téménos nord.

2. La porte nord

Le sondage n° 7 a fait l'objet d'une petite extension au nord-ouest (2,5 x 3 m) pour mettre au jour la porte dans son intégralité (**figs 6 et 7**). Les niveaux conservés sont de faible amplitude (0,7 m) (**fig. 8A**).

Le mur de téménos 60880 occupe quasiment l'intégralité de la surface du sondage. Orienté NNO-SSE, il mesure 1,2 m et n'est conservé que sur une assise (**fig. 8C**). Lors du sondage réalisé en 2017, il a été daté de la période nabatéenne (I^{er} siècle ap. J.-C). Il est associé au niveau 61206 et peut-être 61205 (?). Ces deux niveaux, qui reposent sur le substrat gréseux de couleur jaune, contiennent de nombreux éclats de pierres. On peut les interpréter comme le niveau de chantier contemporain de la construction du mur 60880.

Le mur 60880 est ensuite coupé à son extrémité nord par le mur 61207 (**fig. 8D**). Perpendiculaire au mur de téménos 60880, il est orienté NNE-SSO et a été mis au jour de manière partielle. Sa tranchée de fondation (61211), visible dans la coupe nord-est, est large de 0,8 m (**fig. 8F**). On ne sait pas à quel état architectural il se rattache et on ne connaît pas son tracé.

L'installation de la porte dans l'angle nord-ouest du sanctuaire se fait en arasant le mur 60880 sur 1,2 m de longueur afin de permettre le passage à l'intérieur du sanctuaire. On peut supposer

1. Voir *infra*.

Fig. 3. Traces du raccordement du mur 60882 au rocher IGN 132.



C. Block in place of the wall 60882, view from the west.

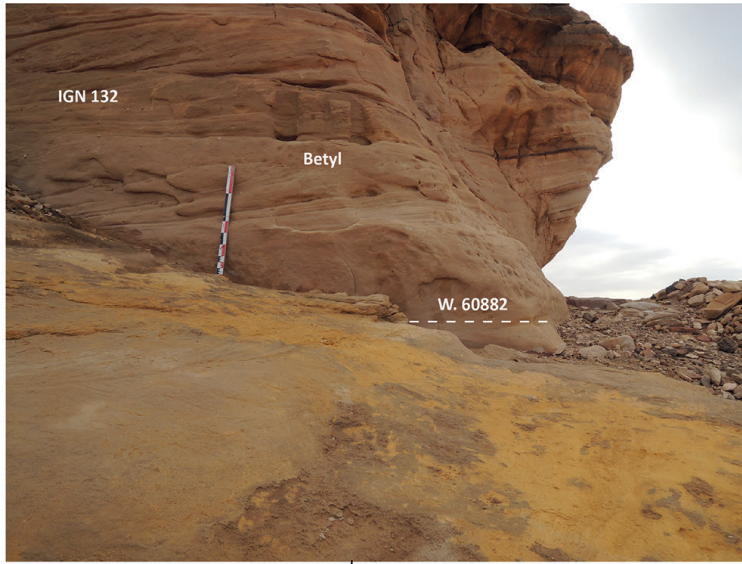

B. Connection of the wall 60882 on the rock IGN 132, view from the north.

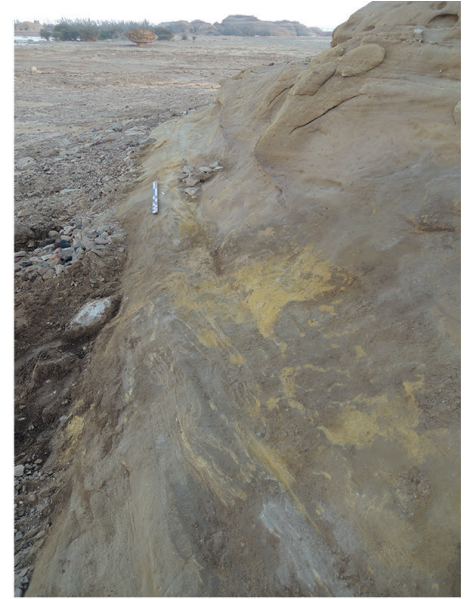

A. Course of the wall 60882, view from the south.



D. Wall 60882 : detail of the block in place, view from the west.



W. 60882

IGN
132



Fig. 4. Plan du secteur au sud-est de IGN 132.



Fig. 5. Photos du secteur au sud-est de IGN 132.

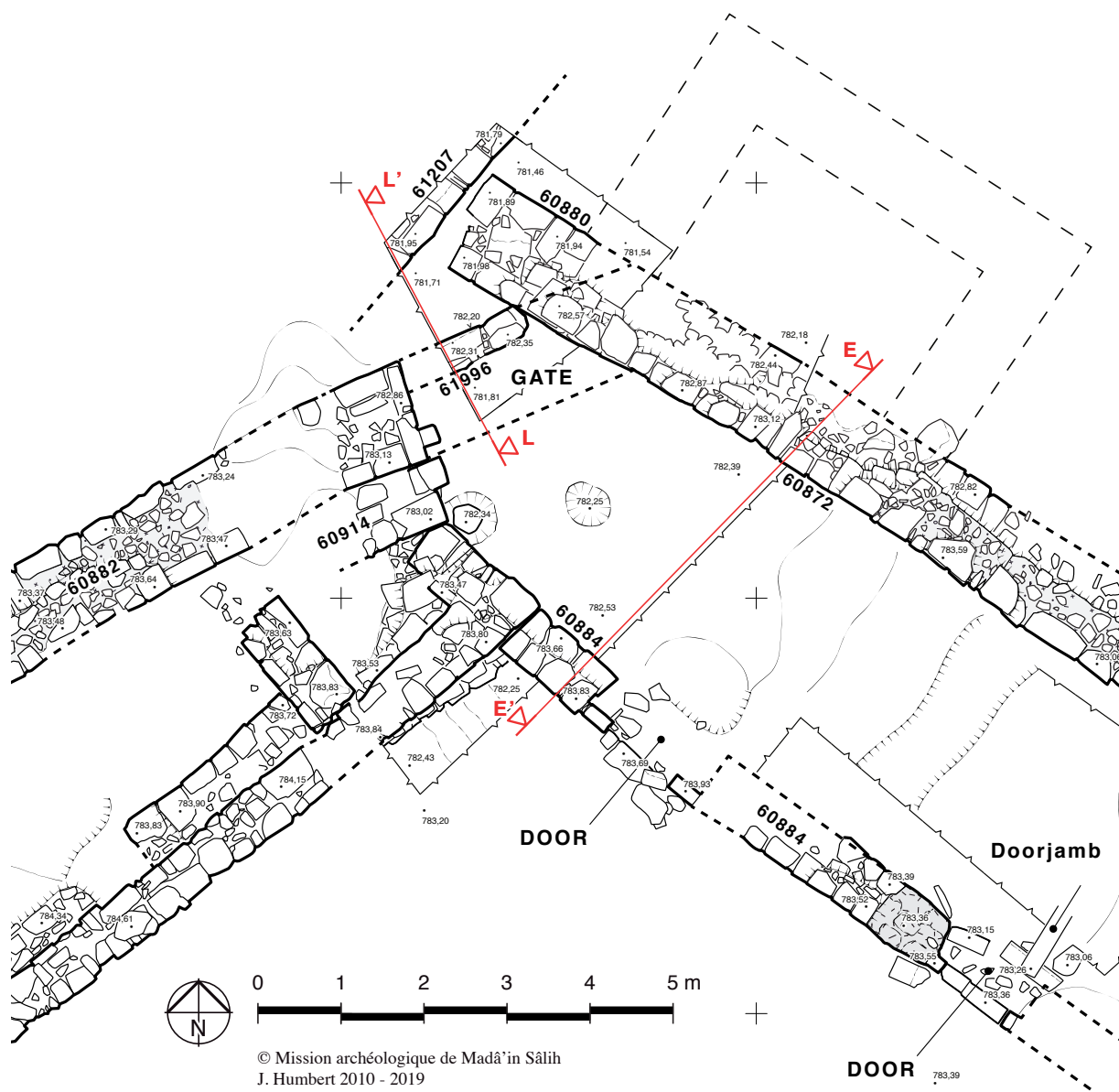

Fig. 6. Plan du sondage n° 7, au nord du sanctuaire.

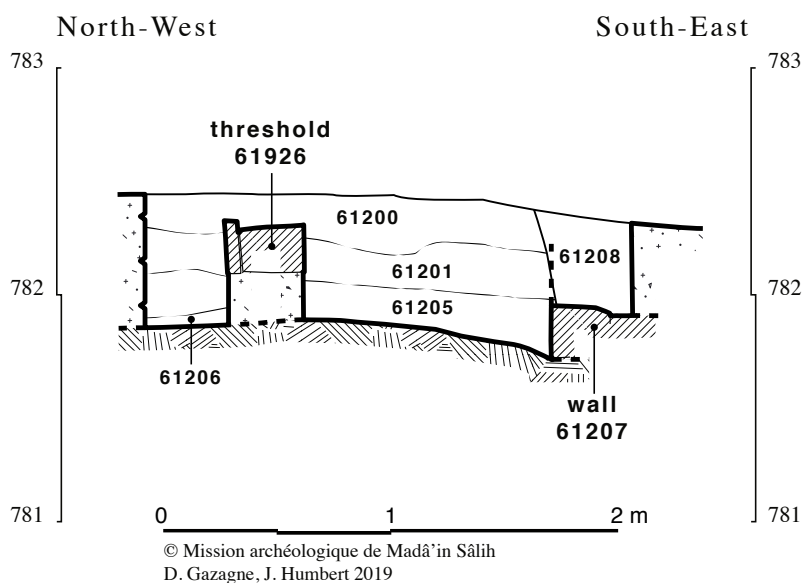

Fig. 7. Coupe stratigraphique L-L' du sondage n° 7.



A. Aerial view of the northern gate.



B. Circulation level associated with the door.



C. Temenos wall 60880 and treshold 61996. View from the west.



D. Temenos wall 60880, wall 61207 and treshold 61996. View from the south.

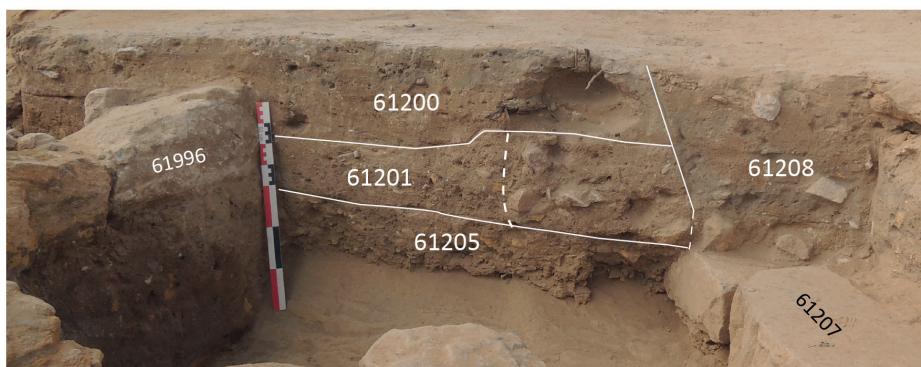

E. Southern section of the sounding 7.

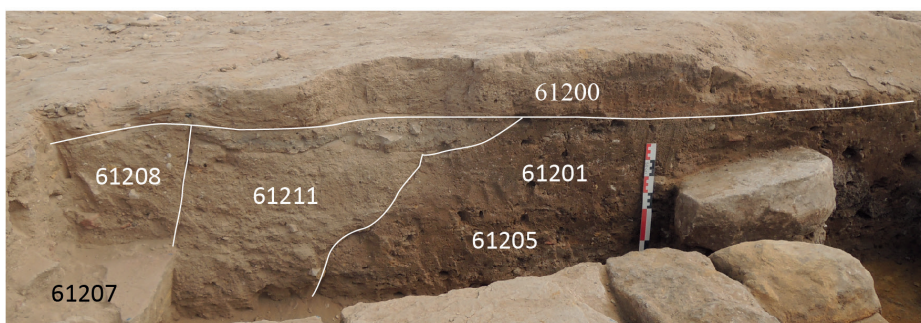

F. Northern section of the sounding 7.

Fig. 8. Vues du sondage n° 7.

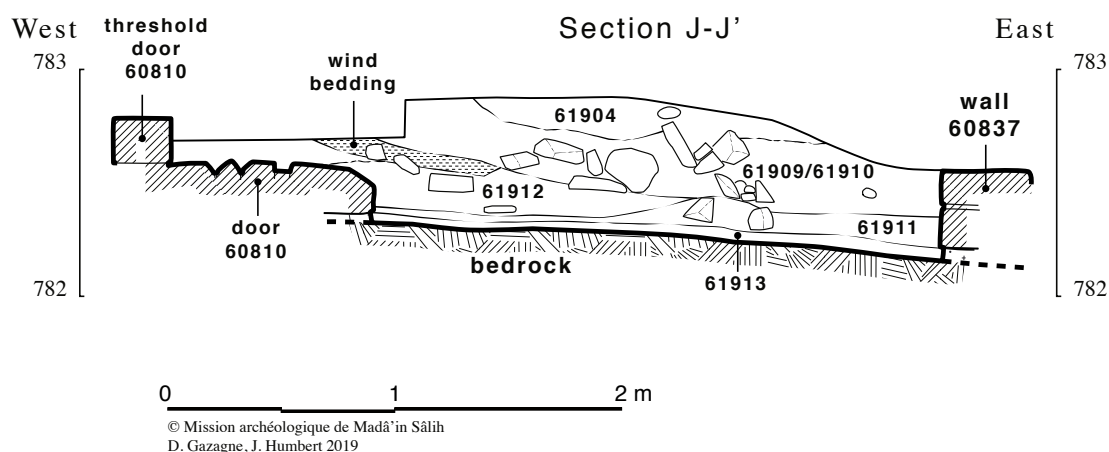

Fig. 9. Sondage n° 5 : coupe stratigraphique de la salle périphérique nabatéenne (coupe J-J', voir fig. 4).

que l'arase du mur 61207 est contemporaine de cette phase, même si cette hypothèse demande confirmation par la fouille (fig. 8E). Cette étape est matérialisée par la tranchée de récupération 61208 qui traverse les niveaux 61201 et 61200. La tranchée 61208 contient des éclats de pierres qui sont caractéristiques d'une activité de récupération.

La porte elle-même n'est plus matérialisée que par le seuil 61996. Celui-ci fonctionne avec le niveau de sol ou de circulation 61201, qui pourrait aussi lui être antérieur (fig. 8B)². Du point de vue altimétrique, l'arase des murs 60880 et 61207 coïncide avec le niveau de fonctionnement de la porte 61996 et avec le niveau de circulation 61201. Les vestiges liés à la réfection de la porte, fouillée en 2017, ont été emportés par des pluies torrentielles. Ce deuxième état était matérialisé par un rehaussement du seuil et un rétrécissement de la largeur de la porte. Les pierres appartenant à cet état ont été conservées en vue d'une éventuelle restauration.

3. L'extrémité orientale de la terrasse basse

3.1. Sondage n° 5 : la salle périphérique nabatéenne

La salle périphérique, entourée par les murs 60850, 60837, 60838 et 60810, a fait l'objet d'une fouille à 50 % (2,5 x 2 m de côté). Une coupe a été réalisée dans l'axe de la porte qui la relie avec l'intérieur du sanctuaire (fig. 9). La stratigraphie atteint une amplitude de 0,6 m à l'intérieur de la pièce (fig. 10G). Le comblement supérieur est constitué d'un niveau d'abandon de 0,4 m d'épaisseur (niveaux 61904, 61909 et 1910). Ces couches sont composées d'un mélange de sable et d'argile provenant de la dissolution des briques crues et témoignent du long processus de ruine du bâtiment. Elles scellent l'éboulis n° 61906 qui occupe la moitié sud-ouest de la pièce (fig. 10B). Ce dernier est composé pour une bonne part de blocs taillés qui proviennent de l'effondrement de l'élévation des murs 60810 et 60850. L'éboulis 61906 scelle à son tour les niveaux 61912 et 61911. Épais de 0,1 à 0,15 m, ces derniers sont constitués d'un mélange de sable et d'argile de couleur brun clair. La partie supérieure de 61912 présente des litages de sables fins provenant de

2. Une datation C¹⁴ du niveau 61201/61205 est en cours afin de dater les niveaux de fonctionnement contemporains de la porte.



A. Zenith view of the sounding 5.



B. Pile of stones in the peripheral room.



C. The sounding 5 at the end of the excavation.



D. North facing of the wall 60850.



E. Zenith view of the wall 60850.



F. Corner of the walls 60850 and 60810.



G. View of the section of the sounding 5.

Fig. 10. Sondage n° 5 : différentes vues de la salle périphérique nabatéenne.



Fig. 11. Sondage n° 5 : fragment de statuare retrouvé à l'angle des tranchées de récupération des murs 60837 et 60838.

dépôts éoliens. On peut en déduire que la zone est abandonnée à ce moment-là. L'interprétation des niveaux 61911 et 61912 est difficile. En altimétrie, on constate qu'ils fonctionnent avec le seuil de la porte du mur 61810 (**fig. 9**). Il est par conséquent possible qu'il s'agisse de vestiges de niveaux de sols tardifs qui correspondraient au dernier état de fonctionnement du bâtiment. Plus bas, on trouve le niveau de construction 61913. Il forme une couche de 5 à 15 cm d'épaisseur qui repose directement sur le substrat de grès jaune et passe sous les murs 60810 et 60850 (**fig. 10F**). Il s'agit d'un remblai de nivellement qui a permis de combler les irrégularités naturelles du socle rocheux et de gommer un peu la pente en direction de l'est. Il est composé de sable et de graviers de provenance locale. Les tessons retrouvés dans cette couche – qui peuvent avoir été apportés avec le remblai – sont très érodés et très fragmentés. Elle correspond de fait aux *loci* 61041 et 61025, datés du I^{er} siècle ap. J.-C., fouillés lors de la campagne 2017 (**fig. 10C**). Les murs de la pièce, 60850 et 60838, s'appuient contre le mur de téménos 60810 (**fig. 10F**) mais les trois murs appartiennent sans doute à la même phase de construction. La pièce est d'ailleurs accessible depuis l'intérieur du sanctuaire par une porte large de 2 m installée dès l'origine dans le mur de téménos 60810 (**fig. 10A**). Peu d'aménagements internes ont été retrouvés à l'intérieur de la pièce. On peut signaler l'existence énigmatique de petits blocs disposés en épis sur la troisième assise du parement interne du mur 60850 (**figs 10D et 10E**). En raison de la faible élévation du mur, il est difficile de dire s'il s'agit d'un procédé de construction ou du bouchage d'une niche. Un élément de statuare a été retrouvé à l'angle de la tranchée de récupération des murs 60837 et 60838 (**fig. 11**). Il présente un décor de chevelure et de torsade. Il ne s'agit vraisemblablement pas d'un remploi utilisé dans 60837/60838, mais d'un rejet ultérieur dans la tranchée de récupération.

3.2. Sondage n° 6 : la salle périphérique « romaine »

La salle périphérique est composée des murs 61034 et 61021, qui appartiennent à la phase architecturale précédente, nabatéenne (I^{er} siècle ap. J.-C.). L'ajout du mur 61033 sur le côté nord a permis de créer, dans un second temps, une pièce de 5 x 3,2 m de côté. Bien que le mur 61033 n'ait pas été dégagé sur toute sa longueur (21 m actuellement), on constate qu'il appartient à une deuxième grande phase architecturale du sanctuaire. Celle-ci consiste en l'adjonction, sur les côtés nord et est, d'un mur parallèle au mur de téménos nabatéen afin de doubler le nombre de salles périphériques. La pièce a fait l'objet d'une fouille à 50 % (2,5 x 3,2 m de côté). Une coupe

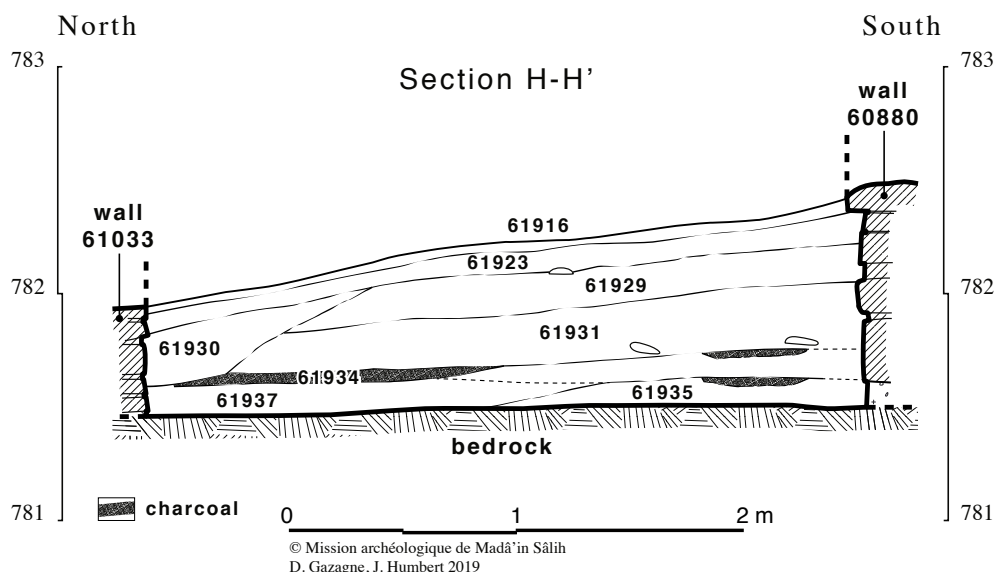

Fig. 12. Sondage n° 6 : coupe stratigraphique de la salle périphérique « romaine » (coupe H-H', voir fig. 4).

stratigraphique a été réalisée dans l'axe NNE-SSO (**fig. 12**). La stratigraphie atteint une amplitude de 0,5 à 0,9 m à l'intérieur de la pièce. Elle est entièrement composée d'une succession homogène de niveaux de sol en terre battue associés à des petits foyers qui témoignent d'une occupation humaine continue.

Le comblement supérieur de la pièce (contextes 61916 et 61923) est un niveau d'abandon et d'ensablement naturel (**fig. 13E**). Il est composé d'un sédiment à matrice sableuse de couleur brun clair qui contient quelques éclats de grès et de calcaire. La séquence stratigraphique se poursuit avec le creusement 61930 le long du mur 61033. Ce creusement de 0,4 m de profondeur coupe les niveaux 61929, 61931 ainsi que la couche charbonneuse 61934. Il est peu probable qu'il s'agisse de la tranchée de fondation du mur 61033 car elle serait anormalement large (0,9 m) et elle n'atteint pas les premières assises du mur. Un petit foyer (61920), découvert dans l'angle sud-ouest de la pièce, témoigne d'une occupation sporadique du lieu (**fig. 13B**). Un prélèvement de charbon y a été prélevé en vue d'une datation C¹⁴.

Le niveau 61929 est constitué d'un mélange de sable et de limon à matrice sableuse, de couleur beige foncé. D'une épaisseur de 15 cm, il est associé à une couche charbonneuse (niveau 61926) qui n'a pas la forme d'un foyer.

Le niveau 61931 est un remblai de 20 cm d'épaisseur. De couleur beige, il est composé d'un sédiment compact à matrice argileuse. Ce niveau scelle les foyers 61934 et 61935 (**fig. 13D**). Comme il s'agit des premières traces d'occupation de la pièce, un prélèvement de charbon a été effectué sur le foyer 61934 en vue d'une datation C¹⁴. Dans la moitié sud du sondage, le niveau 61935 est un remblai de chantier sur lequel est construit le mur de *téménos* 60880. Au milieu de la pièce, le remblai se termine « en sifflet » et laisse la place au niveau 61937 qui vient se poser contre le mur 61033.

L'appareillage des maçonneries est fruste : les blocs sont assisés mais les assises sont irrégulières et présentent de nombreux bouchons de calage (**figs 14A-C**). Le mur 61033, construit tardivement, possède un piédroit de porte en remploi sur son parement sud (**fig. 14A**). Il vient s'appuyer



A. Aerial view of the trench 6.



B. Hearth 61920



C. Hearth 61926 and level 61929.



D. Hearth 61934 and level 61933.



E. Section of the trench 6.

Fig. 13. Sondage n° 6 : différentes vues de la salle périphérique « romaine » en cours de fouille.



A. Southern facing of the wall 61033.



B. Eastern facing of the wall 61034.



C. Northern facing of the wall 60880.

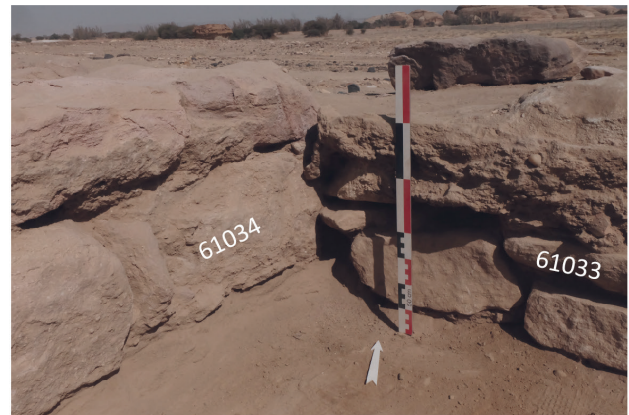

D. Corner of the walls 61034 and 61033.



E. Corner of the walls 60880 and 61034

Fig. 14. Sondage n° 6 : les parements des murs de la salle périphérique « romaine ».

contre le mur 61034 (**fig. 14D**). La maçonnerie 61034 s'appuie contre le mur de 60880 mais ces deux ouvrages appartiennent à la même phase (**fig. 14E**).

3.3. Le sondage n° 4

Le sondage n° 4 mesure 7,5 x 7 m de côté. Il a été implanté le long du mur de téménos 60811/60879 afin de mettre au jour les maçonneries en brique crue de ce secteur (**fig. 15**). Les niveaux fouillés atteignent 1,2 m d'amplitude (**fig. 16**).

Les niveaux d'abandon atteignent une amplitude maximale de 0,4 m. Numérotés 61907, 61921, 61922, 61924 selon les secteurs de fouille, ils présentent tous les mêmes caractéristiques. De couleur beige à brun clair, ils sont composés d'un sédiment à matrice sablo-argileuse homogène et induré, qui témoignent de la dissolution de briques crues. Ces niveaux témoignent du long processus de destruction du bâtiment après l'abandon du secteur.

Ils scellent un état tardif, daté du IV^e siècle ap. J.-C., qui occupe la majeure partie du sondage. Le sondage n° 4 se scinde en deux parties distinctes : la moitié sud est occupée par l'arrière d'une maison tardive comprenant un couloir, un espace pour faire la cuisine et un escalier. La maison tardive est circonscrite par les murs 60811, 60868 et 61952. À l'intérieur de cet espace, les pièces annexes sont connectées aux deux pièces principales (qui sont situées plus au sud et qui ont fait l'objet de sondages en 2016 et 2017) par la porte 60819 (**fig. 19E**). L'espace de la maison est ensuite compartimenté en deux petits ensembles distincts (**figs 17C-E**). La porte donne tout d'abord accès, à l'ouest, à une petite pièce allongée de 2,5 x 0,9 m, au fond de laquelle se trouvent les tannours 61914 et 61957. Le premier tannour, 61957, est construit contre les murs 60868, 61953 et 60813 (**fig. 18E**). Il est ensuite partiellement détruit par la réalisation du nouveau tannour 61914, qui mesure 0,35 m de diamètre. Des charbons ont été prélevés à l'intérieur de ce dernier pour réaliser une datation C¹⁴. Le mur en briques crues 61953 sépare cette petite cuisine d'une autre pièce située juste au nord. Cette pièce est essentiellement occupée par l'escalier 61954 qui menait à l'étage de la maison (**fig. 17E**). Celui-ci est installé sur une banquette en brique crue de 2 x 0,5 m de côté. Sur son côté oriental se trouvent les quatre premières marches en pierre qui constituent l'amorce de l'escalier (**fig. 18A**). Le reste de l'escalier, aujourd'hui disparu, était en bois. L'escalier s'installe contre le mur en brique crue 61952 qui marque la limite nord de la maison tardive.

C'est probablement à cette époque tardive que le mur 60813 a été construit (**fig. 18C**). On peut en effet supposer que le percement de la porte 60819 dans le mur 60806 a entraîné sa fragilisation. Il aurait alors été flanqué sur son côté nord du mur 60813 afin de le stabiliser.

Le niveau de sol contemporain de cette maison tardive est très homogène (contextes 61908, 61915, 61983). Ce sol en terre battue, de couleur brun foncé avec des nuances ocres, a livré un lot important d'artefacts (céramique et faune) témoignant d'une activité domestique intense.

La moitié nord du sondage n° 4 a livré des vestiges de l'époque tardive d'une autre nature. La zone a simplement fait l'objet d'un terrassement important afin de ménager un nouvel accès à la terrasse basse depuis l'est. Les murs plus anciens (60811, 60868 et 60867) ont fait l'objet d'un arasement à des niveaux variables afin de permettre l'accès à la terrasse basse. C'est ce qui explique la moins bonne conservation du mur de téménos 60811 dans ce secteur (par rapport à l'angle sud-est du sanctuaire). Il n'est conservé que sur deux assises et il a été entièrement récupéré à certains endroits (tranchée de récupération 61950) (**figs 15 et 18D**). L'accès à la terrasse basse se fait donc depuis l'est au moyen d'un petit escalier en quart de cercle (*locus* 61955) installé contre les murs 60868 et 61952 (**figs 17F et 18B**). Cette structure est entièrement construite en blocs de remploi. Les murs 60867 et 60868 ont eux aussi été arasés, mais moins que le mur de téménos 60811 (0,4 m de différence) afin d'assurer un accès progressif à la terrasse basse. Il est encore difficile d'estimer sur quelle longueur les murs 60868 et 60867 ont été arasés. Sur le côté sud, ces murs n'ont en revanche pas été arasés car ils appartiennent à la maison tardive. Au nord, on ne sait pas encore.

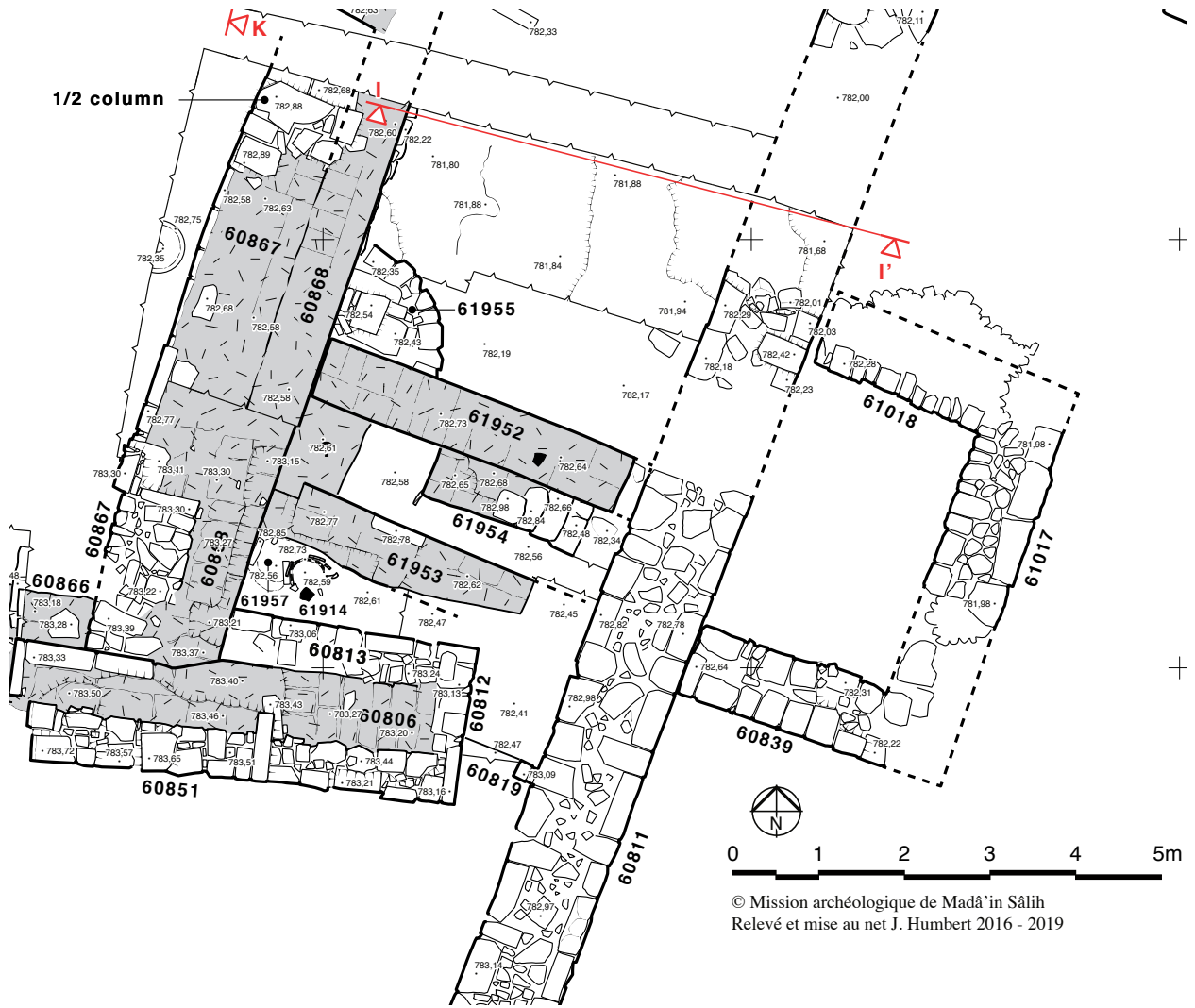

Fig. 15. Plan du sondage n° 4.

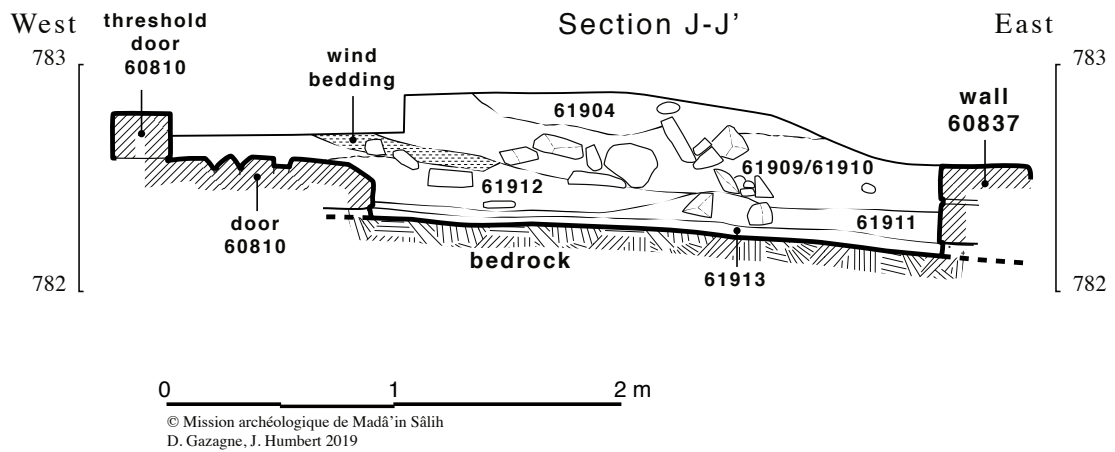

Fig. 16. Coupe stratigraphique E-O du sondage n° 4 (coupe I-I', voir fig. 15).



A. Aerial view of trench 4 and 8.



B. View of trench 4 at the end of the excavations.
From north-east.



C. Zenith view of trench 4.
From west.



D. Interpretation of trench 4.



E. Mudbrick house. View from south.



F. Staircase 61955. View from north-east.

Fig. 17. *Vues générales du sondage n° 4.*



A. View of the staircase 61954 from the south-east.



B. View of the staircase 61955 from the north-east.



C. Walls 60806 and 60813. View from the north-east.



D. The wall 60811. View from the north.



E. Tannour 61914 and 61957. View from the north.



F. Engaged half-column in re-use in the wall 60867.

Fig. 18. vues de détail du sondage n° 4.



A. E-W section of trench 4.
View from the south.

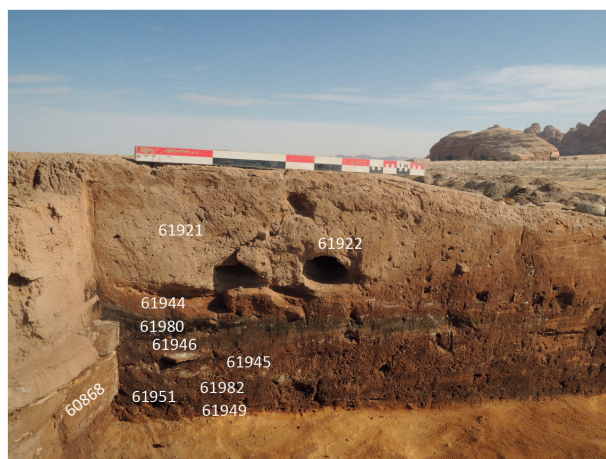

B. Detail of the E-W section of trench 4.



C. Eastern facing of the wall 60868.



D. Section under the stairs 61955.



E. Door 60819. View from the north.

Fig. 19. Sondage n° 4 : vues des coupes et des maçonneries.

Les niveaux mis au jour sont faiblement anthropisés (*locus* 61948), ce qui contraste fortement avec les niveaux contemporains mis au jour dans la moitié sud du sondage n° 4 (maison tardive) et dans le sondage n° 8. Une telle différence invite à voir dans ce secteur un espace de passage situé en extérieur, et probablement un accès à la terrasse basse (interprétation sous réserve).

Un plot en pierres a été conservé à l'extrémité nord des murs 60868/60867. Un fragment de demi-colonne engagée y a été utilisé en remploi (**fig. 18F**). Il témoigne d'une architecture monumentale appartenant à des phases antérieures.

Un sondage stratigraphique a été réalisé dans le quart nord du sondage n° 4 car il est vierge de bâti tardif et il a donc permis de documenter toute la séquence stratigraphique. Les niveaux les plus anciens sont conservés le long du mur 60868, le reste ayant été détruit par les remaniements tardifs qui touchent le mur de téménos (contextes 61948 et tranchée 61950) (**figs 16 et 19A**). On y retrouve deux niveaux d'occupation charbonneux (**fig. 19B-C**) : le niveau 61951 est le premier niveau d'occupation associé au mur 61968. Un prélèvement de charbon y a été réalisé en vue d'une datation C¹⁴. Il est suivi par une recharge en terre (contexte 61946) et par un nouveau niveau d'occupation charbonneux (*locus* 61980) qui vient s'appuyer contre le sommet de la fondation en pierre du mur 60868. Ce niveau est ensuite scellé par la construction de l'escalier en quart de cercle 61955 (**fig. 19D**).

3.4. Le sondage n° 8

Le sondage 8, situé juste au nord du sondage n° 4, forme un quadrilatère de 7 x 6 m de côté. La séquence stratigraphique complète atteint 1,2 m d'amplitude (**fig. 21**).

Les niveaux d'occupation tardifs sont recouverts d'un dépôt de sédiments sablo-argileux de 0,2 à 0,3 m d'épaisseur. Ces contextes (*loci* 61985 et 61927) sont constitués selon les endroits de dépôts sableux ou de dépôts argileux indurés qui résultent de la dissolution de briques crues.

Suivent les niveaux d'abandon 61932 et 61936 : composés d'une couche sableuse très meuble, de couleur brun ocre, ils marquent la transition entre les niveaux de comblement naturel (61985 et 61924) et la dernière phase d'utilisation des fours. Ils contiennent donc, en position résiduelle, de nombreux artefacts provenant de la phase antérieure liée au fonctionnement des fours (**fig. 22A**). C'est notamment dans ces contextes qu'ont été retrouvés de nombreux éléments de broyage et de mouture (**fig. 25**), ainsi que des éléments de porte effondrés (**fig. 22D et 24 A, B, E et G**).

La phase précédente concerne l'utilisation proprement dite des fours : elle est matérialisée par une succession de trois niveaux de 0,3 m d'épaisseur au total (contextes 61947, 61963 et 61964). On peut ajouter à cette phase les niveaux charbonneux 61209, 61988, 61987 et 61210 situés dans l'angle nord-ouest du sondage n° 8, qui sont associés au four 61961. Ces niveaux cendreaux constituent la dernière phase d'utilisation des fours puisqu'ils n'ont pas fait l'objet d'un curage. Une dizaine de prélèvements de 10 litres ont été réalisés dans les fours et dans les rejets de fours en vue d'une analyse carpologique. Un échantillon de charbons a aussi été prélevé dans le four 61939 en vue d'une datation C¹⁴.

Les fours sont partiellement installés dans le mur en brique crue 61959, qui a été recreusé à cette fin (**fig. 22E**). Cinq fours sont installés sur son côté ouest (61939, 61940, 61941, 61942 et 61943) et un sur son flanc sud (61938). Un septième four (61961) a été découvert le long du mur de téménos 60880. Certains d'entre eux possèdent des parois en céramique de mauvaise qualité et appartiennent à la catégorie traditionnelle des tannours (61938, 61939 et 61961). Les autres

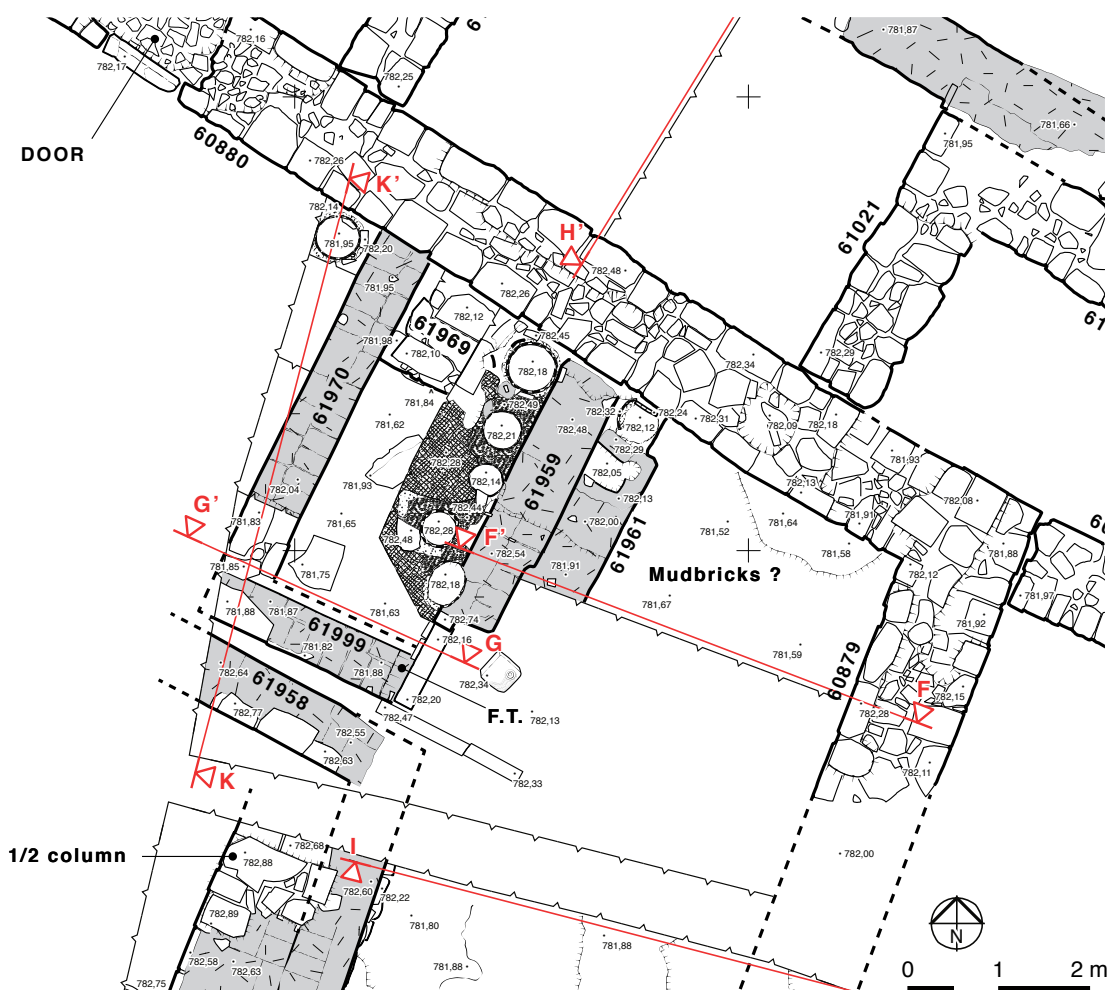

Fig. 20. Plan du sondage n° 8.

sont de facture plus fruste (61940, 61941, 61942 et 61943) et présentent des parois constituées de sédiment argileux induré sous l'effet de la chaleur produite par feu. Les foyers ont un diamètre modeste qui oscille entre 0,35 et 0,5 m et une profondeur d'environ 0,2 m. À l'extrémité nord, le sol est recouvert par le dallage 61969 qui est constitué de longues dalles de calcaire blanc. Au sud, la pièce est délimitée par le mur 61958, qui fonctionne avec le mur 61959.

La séquence stratigraphique suivante, composée des niveaux 61965, 61972 et 61973, est une étape de transition qui marque le remaniement du secteur (fig. 23E). Le niveau 61965 est un remblai de 10 à 15 cm d'épaisseur composé essentiellement de briques crues fondues. On peut supposer qu'il s'agit du remblai de nivellement après l'arasement des murs 61970 et 61999.

Le *locus* 61972 est un niveau d'effondrement qui contient de nombreux blocs de pierres en chute mélangés à des morceaux de brique crue. Il est surmonté du niveau 61973, un brun foncé et épais de 3 cm.

La première séquence stratigraphique comprend le niveau 61976 et le foyer 61977 auxquels sont associés les murs 61970 et 61999 (fig. 22F). Un prélèvement de charbon a été effectué dans le foyer 61977 afin de réaliser une datation C¹⁴.

La moitié orientale du sondage n° 8 n'a pas livré d'aménagements particuliers en dehors du four 61938 (fig. 23B). La coupe réalisée au milieu de la pièce, dans l'axe est-ouest, révèle une séquence

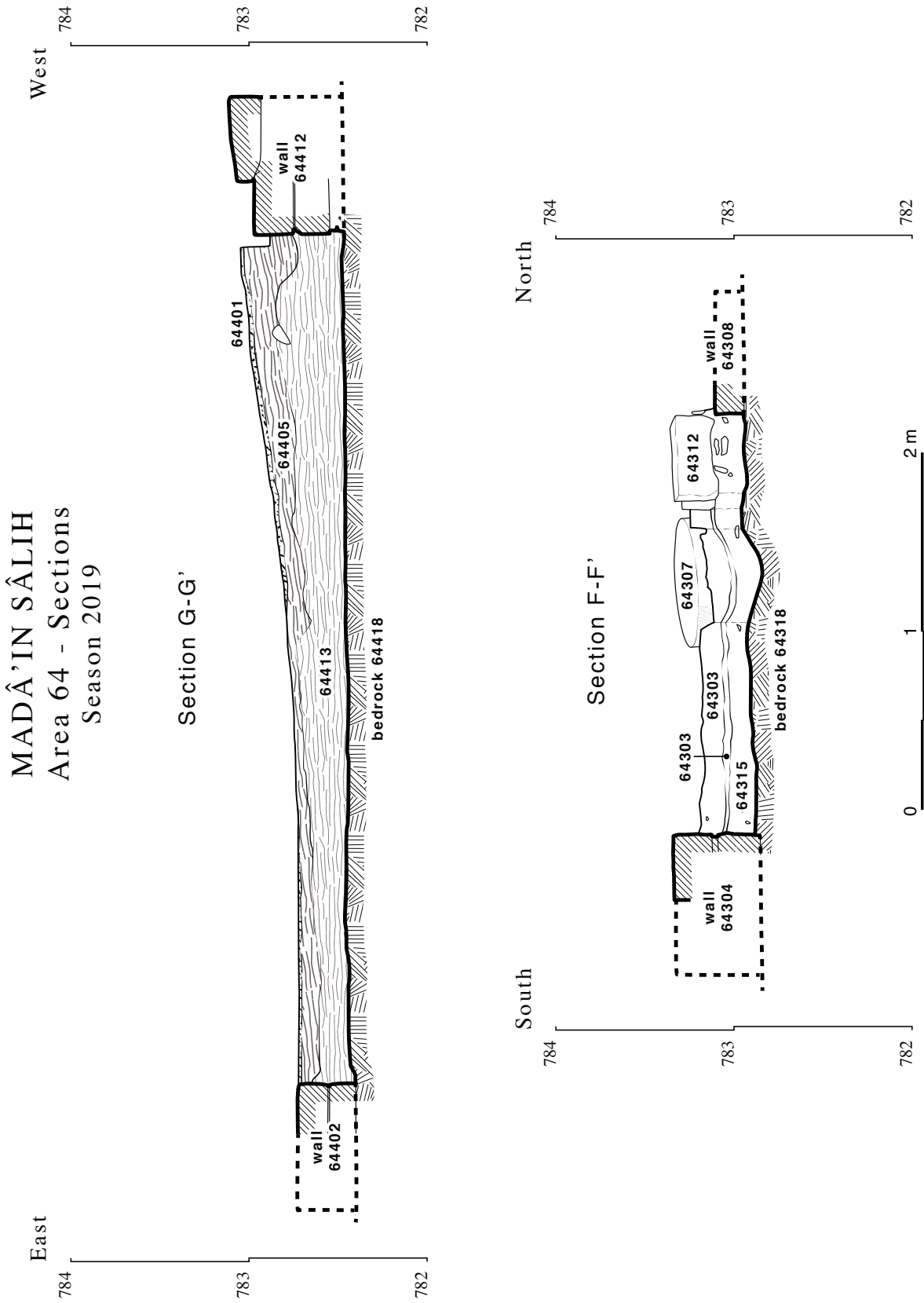

Fig. 21. Coupes stratigraphiques du sondage n° 8 (coupes F-F', G-G', voir fig. 20).



A. Hearth being cleared.



B. Hearth and their last level of operation.



C. Zenith view of the hearth.



D. View from the east.



E. Western part of trench 8.



F. Trench 8 : hearth 61977 on the bedrock.

Fig. 22. Différentes vues du sondage n° 8.



A. zenith view of the western part of trench 8 at the end of the excavation.



B. zenith view of the eastern part of trench 8 at the end of the excavation.



C. General view of trench 8 at the end of the excavation. View from south-west.



D. Section AA'.



E. Section BB'.

Fig. 23. Sondage n° 8 : vues des coupes et du sondage à la fin de la fouille.



A. Lintel.



B. Doorjamb



C. Door pedestal



D. Stone plate.



E. Doorjamb.



F. Stone vessel



G. Treshold with engraved game.



H. Stone block with preparatory drawing.

Fig. 24. *Le lapidaire découvert dans le sondage n° 8.*

stratigraphique analogue à celle qui a été décrite pour la moitié ouest du sondage, bien qu'elle soit moins complexe et moins lisible (**fig. 23D**).

Sous le niveau d'abandon 61936 se trouve le niveau de sol 61962, qui est contemporain de l'utilisation des fours et de la porte. Cette séquence est suivie des niveaux de remblai 61979 et 61966, puis du niveau de sol 61968 et du rejet cendreuse 61967 qui correspondent stratigraphiquement aux niveaux 61976 et 61977. Un piédroit de porte en chute a été découvert sur le niveau 61967 (**fig. 24C**).

4. Conclusion

Le plan du sanctuaire tel qu'il commence à se révéler permet de faire des comparaisons avec des sites fouillés dans la péninsule Arabique. La comparaison est particulièrement valable avec le sanctuaire dit de Almaḡah à Ṣirwāḡ qui présente plusieurs points communs avec le sanctuaire de Hegra (**fig. 26**) : un mur de tēmēnos de forme ovale, des pièces annexes installées à la périphérie du mur de tēmēnos ainsi qu'un deuxième mur d'enclos. D'après Solène Marion de Procé³ : « Plusieurs pièces dont la fonction est énigmatique avoisinent le temple : des tours (à vocation défensive et probablement postérieures à l'utilisation du bâtiment comme lieu de culte), des lieux d'habitat pour le personnel du temple ? des lieux de production alimentaire ? Une pièce bâtie contre la paroi nord de l'enceinte du temple a peut-être eu vocation à abriter le trésor du temple. Au nord de la zone des banquettes, une pièce abritant un autel, destinée à recevoir des offrandes combustibles, a été mise au jour... ».

Pour la période nabatéenne (I^{er} siècle ap. J.-C.), les données concernant le sanctuaire ont évolué : la porte nord (sondage n° 7) est une création tardive, d'époque romaine. La poursuite du mur de tēmēnos vers l'ouest et la découverte d'un nouveau mur (61207) posent de nouvelles questions sur l'architecture de l'angle nord du sanctuaire. Le sondage n° 7 mérite donc d'être étendu pour répondre à ces questions.

Plusieurs indices ténus arguent en faveur d'une porte installée sur le côté nord du sanctuaire, au milieu du mur de tēmēnos 60880 (**fig. 27A**). Un accès par là permettait de desservir à la fois le temple haut et la terrasse basse.

Au IV^e siècle, le sanctuaire semble être découpé en deux secteurs distincts (**fig. 27B**). La séparation semble se faire à l'est de IGN 132, au niveau du mur 61992. À l'ouest, le temple haut reste probablement une aire sacrée, à laquelle on accède par la porte nord, ouverte à l'époque romaine. La terrasse basse est totalement investie par les activités profanes : dans l'angle sud-est, une partie du sanctuaire est réutilisée en maison. Dans l'angle nord-est, la découverte de nombreux fours et d'un important lot de meules et de broyeur plaide en faveur d'une activité artisanale tournée vers la production d'aliments, peut-être une boulangerie (?). À l'est, au pied du rocher IGN 132, une batterie de bassins en pierre attestent d'une activité artisanale qui reste à définir.

Entre ces deux grandes phases, la période romaine (II^e-III^e siècles de notre ère) est difficile à cerner. Le statut de la terrasse basse est notamment problématique : conserve-t-elle une fonction

3. Marion de Procé S. 2016 : *Le phénomène culturel en Arabie du Sud-Ouest du VIII^e s. av. J.-C. au IV^e s. apr. J.-C.*, Thèse de Doctorat de l'Université Paris 1 Panthéon-Sorbonne.



A. Column elements reused in crusher.



B. Basalt mortar.



C. Manual grinding mill.



D. Manual grinding mill.



E. Manual grinding mill.



F. Manual grinding mill.



G. Fragment of grinding mill.



H. Fragment of grinding mill.

Fig. 25. *Les instruments de broyage et de mouture découverts dans le sondage n° 8.*

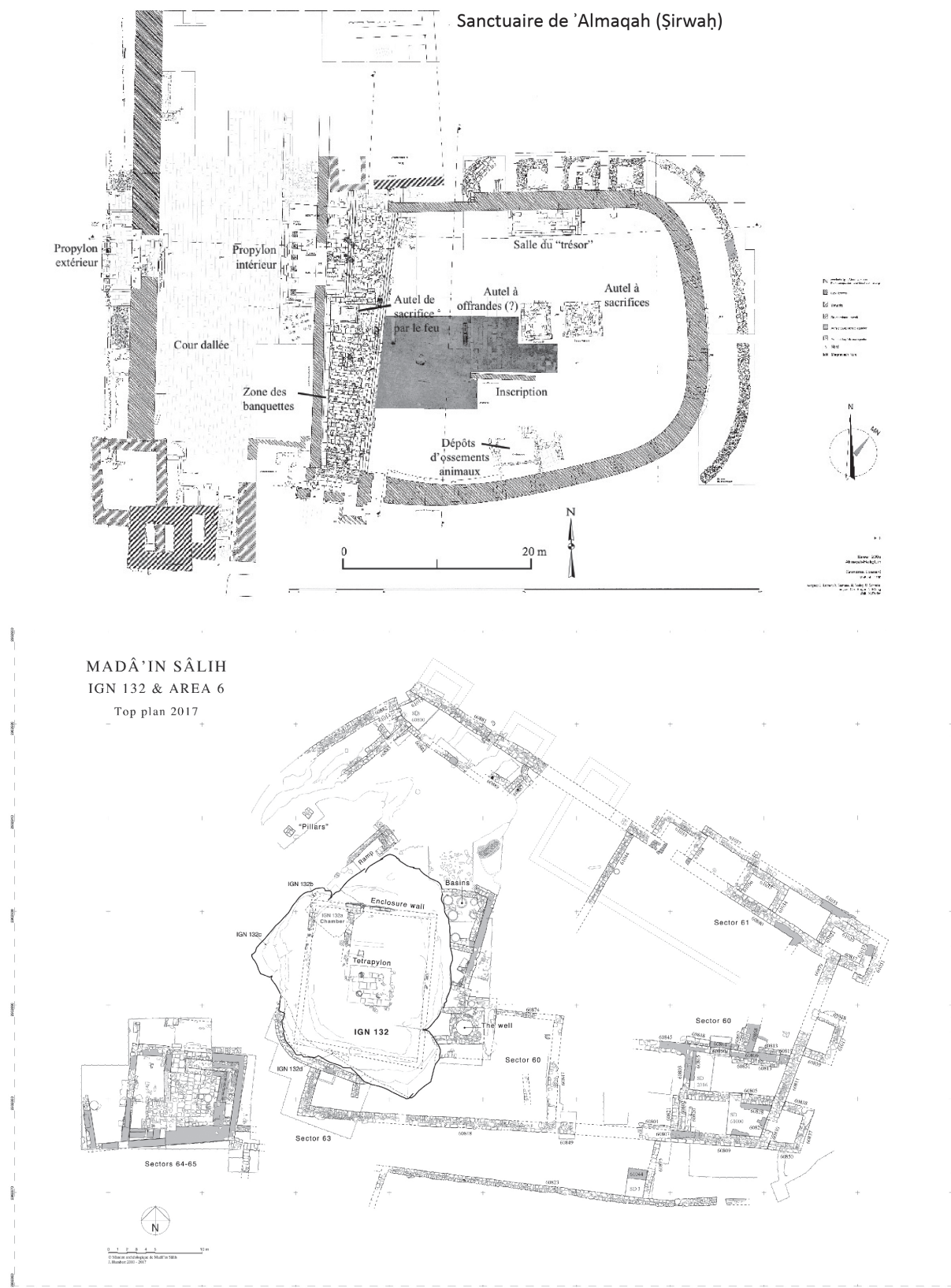

Fig. 26. Plans comparés des sanctuaires de Almaqah (Şirwāh) (d'après Röring 2007*, pl. 5) et de Hégra (* N. Röring, *Bauhistorische Untersuchungen am Almaqah-Heiligtum von Sirwah. Im Land der Königin von Saba. Vom Kultplatz zum Heiligtum*, PhD dissertation, Brandenburgischen Technischen Universität Cottbus.



Fig. 27. Le sanctuaire de la période du 1^{er} au 4^{ème} siècle de l'ère chrétienne.

MADÂ'IN SÂLIH
IGN 132 & AREA 6
Top plan 2017

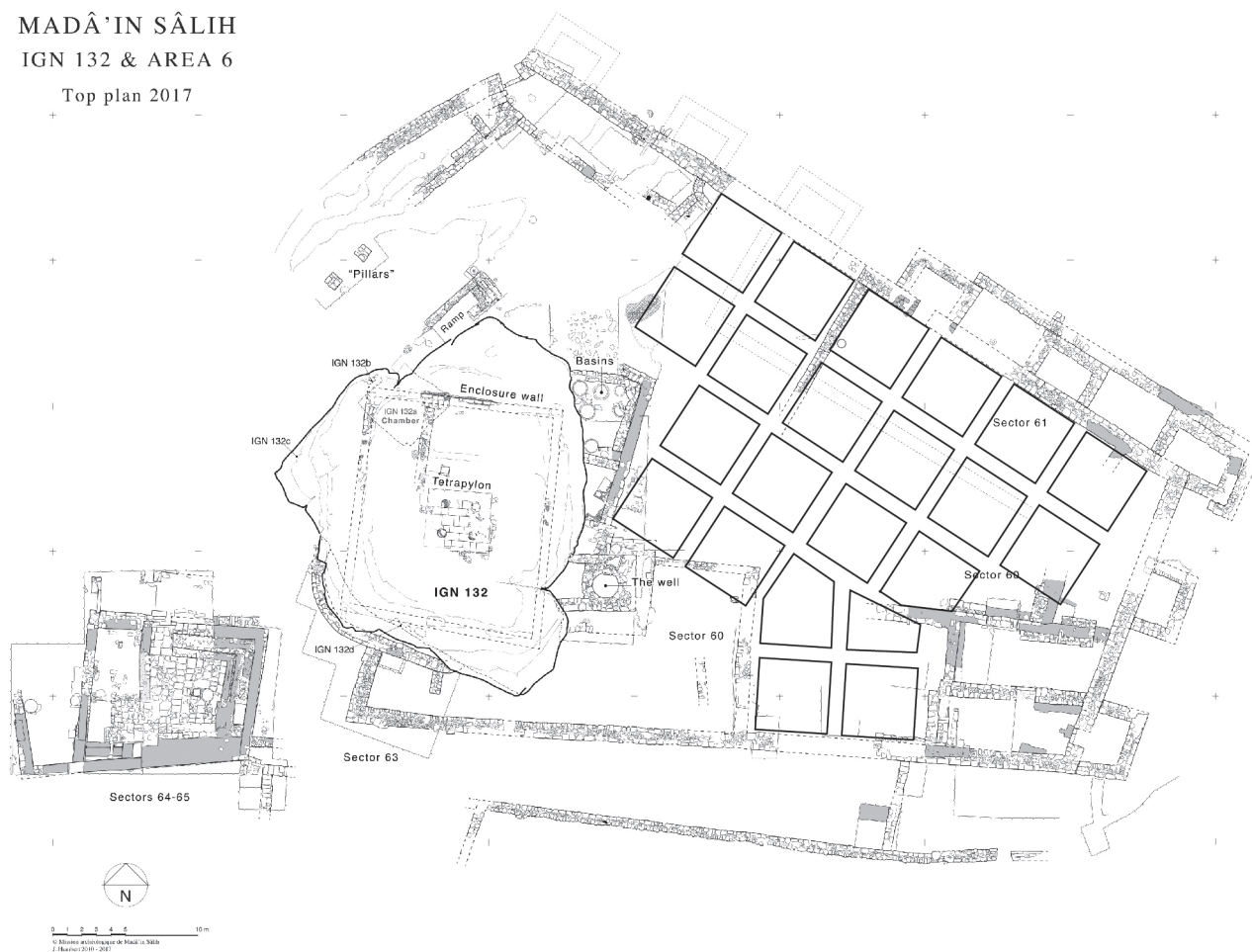

Fig. 28. Proposition d'implantation de carroyage sur la terrasse basse : carrés de 5 m de côté et bermes d'1 m.

culturelle ou est-elle investie par des activités profanes, de nature domestique ou artisanale ? Il est trop tôt pour trancher la question en l'état actuel des connaissances.

Sur la terrasse basse, l'amplitude de la séquence stratigraphique (1,5 m) et la présence de deux niveaux superposés de maçonneries en brique crue incitent à changer de stratégie de fouille. La phase de décapage extensif associé à des sondages ponctuels a livré de bons résultats jusqu'ici et atteint désormais ses limites. Un carroyage régulier de 5 m de côtés, entrecoupé de bermes d'1 m d'épaisseur, sera installé sur la terrasse basse du sanctuaire (**fig. 28**). Le but n'est pas forcément de tout fouiller mais plutôt de conserver des bermes afin d'obtenir les coupes stratigraphiques N-S et E-O les plus longues possibles à l'intérieur du sanctuaire. Son implantation reste à définir.

Preliminary Report on Areas 64300 and 64400, South of IGN 132

Maher K. AL-MÛSA, Ahmad S. AL-HUWAYTÎ, Saad A. AL-MUQBIL,
Samar M. AL-NAWFAL, Ibrahim N. AL-SABHAN, Dhaifallah M. AL-TALHI¹

Introduction

Areas 64300 and 64400 lay at the foot of the southern flank of hill IGN 132 and the so-called Nabataean temple. Their northern limit borders areas 64200 and 63000, while area 60000 borders them on the east, and area 64100 borders them on the west. The excavation of Areas 64300 and 64400 during the 2019 season is a continuation of the archaeological operations undertaken in the area of IGN 132. Its preliminary results complement what has been uncovered in the area since 2003 CE.

Excavation in areas 64300 and 64400 has been decided in order to reach three main objectives:

1/ The position of these areas, set between areas excavated during previous seasons, makes their uncovering a continuation of archaeological work and completes the studies accomplished therein;

2/ Excavating there gave a chance to uncover the architectural features uncovered in area 64100, namely walls 64120 and 64129, identified in 2016 and 2017. It would also allow to continue exposing features such as E-W wall 60823, check whether it continues west and whether it connects with wall 64129. It would finally allow to check the relationship of this part of the temple with area 63000 excavated immediately north by Laurent Tholbecq in 2015.

3/ Connect this area with what was uncovered since 2003 in order to try to precise the function and chronology of the structures.

This report is a collective work pertaining to all archaeological activities in areas 64300 and 64400. They are grouped together because they form one single space united by contiguities and by the resemblance of most of their architectural and archaeological characteristics, which allows interpreting them altogether (**fig. 1**).

1. PhD candidate at King Saud University, specializing in pottery studies, who joined the Saudi-French expedition to Madâin Sâlih in 2019 as part of her training.



Fig. 1. Drone view of excavation area south of IGN 132 (J. Bervillié).

Archaeological work in both areas

Area 64300

The dimensions of trench 64300 are irregular because it lays between areas 64100 and 64200 to the north–north-west, area 63000 to the north and area 64400 to the east. The north baulk is 7.80 m long, the south baulk is 5.20 m, the east baulk is 6.30 m long, and the west baulk is 7.20 m. In a later phase of the work, the excavated zone has been enlarged to reach 7.80 m for the north baulk, 7.20 m for the south baulk, 8.30 m for the east baulk and 8.25 m for the west baulk. This was done in order to uncover completely *loci* 64304, 64306, 64310 and 64322 in the southern part of the square as well as the the connection between walls 64304 and 64308 with walls 64120 and 64129 the latter two uncovered during the 2016 season.

The excavations uncovered twenty-three features, among which eight architectural elements, the uncovering of which went through fifteen layers which include: the surface layer, three layers of backfill containing architectural elements and clayish earth, five layers of clayish earth which vary in depth and composition according to their location in the square, two layers of ash and charcoal, finally four different places where the underlying bedrock (virgin soil) is visible.

Area 64400

The dimensions of area 64400 vary because of its position between areas 60000 and 63000. Its north baulk borders the southern flank of IGN 132, where is to be found a thick scree of

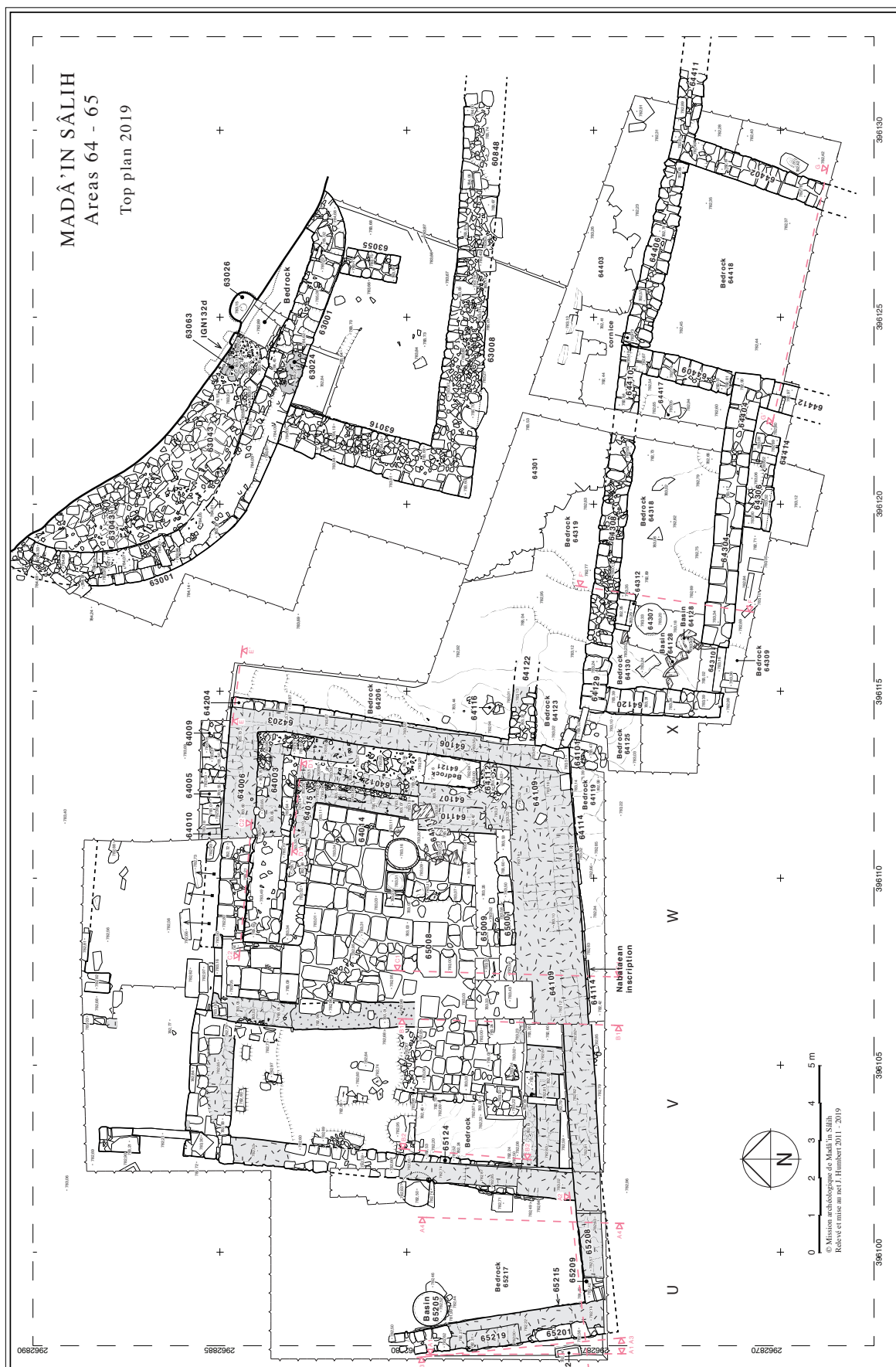

Fig. 2. General plan of areas 64300 and 64400.

architectural stones fallen from architectural elements located in areas 60000 and 63000. To that must be added the extension in the southeastern corner of the trench (2.10 x 1.65 m), which was decided in order to uncover the whole of wall 64404 and staircase 64414. The actual dimensions of the trench are 8.50 m on the north, 8.10 m on the south, 5.65 m on the east and 7 m on the west.

The excavation operations uncovered nineteen features, among which nine architectural elements, the uncovering of which went through ten layers which include: the surface layer, a layer of fallen stones, seven layers of clayish earth, and finally the bedrock (**fig. 2**)

Architectural Phases in both areas

The architectural features present in areas 64300 and 64400 belong to two main architectural phases. These are determined by the building techniques of their architectural elements, by the way the latter are connected to each other and to the other parts of IGN 132 and by their function. These features are listed below, presented from the earliest to the latest:

1. The first phase

This phase dates back to the Nabatean Period. Its architectural features stand on the bedrock (numbered this year 64309, 64318, 64319 in area 64300 and 64418 in area 64400). The bedrock's surface slopes from west to east. Its highest point above sea level is at 783.04 m, west of *locus* 64312 in area 64300, while its lowest point is at 782.37m east of *locus* 64402 in area 64400.

This phase is represented by the following architectural features:

- **Loci 64404/64304**

East-west sandstone wall which runs through both areas. It was uncovered after the removal of surface layers 64401/64300. The wall comprises two courses. It is 0.80 m high and 7.40 m long. The lower course contains thirteen stones while the upper course contains fourteen. Its northern face is partly covered with plaster (**fig. 3**).

Wall 64404/64304 connects with wall 64412 to form the northeastern corner of a unit which extends beyond the south baulk and the plan of which is therefore not determined yet. The staircase 64414/64306 is built against the eastern end of 64404/64304's southern face. At the west end of the wall one finds door 64310 which was used as the southern entrance to the architectural unit made of walls 64404/64304, 64409, 64120, and 64308/64129 (**figs 2, 4**).

- **Locus 64412**

North-south sandstone wall, in the southwestern corner of area 64400, connected to wall 64404/64304 to form with it the northeastern corner of a unit which extends beyond the south baulk and the plan of which is therefore not determined yet. The wall has been uncovered after the removal of the surface layer 64401 in area 64400. Its clearance continued southwards for 0.50 m only in order to uncover it a bit more. The wall is made of two courses of stone, each one containing three stones. The wall is 1 m long, 0.50 high and 0.60 m wide (**fig. 5**)

- **Loci 64414/64306**

These two *loci* correspond to the base of a staircase built against wall 64404/64304 at the eastern end of its southern face. The staircase led probably to the first floor of the architectural unit which extended beyond the southern baulk (see above). The staircase is 2.85 m long, 0.55 m high and 0.75 m wide. It includes three steps which reach the maximal height of the feature, each step being made of two stones, a square one on the north and a rectangular one on the south. On the



Fig. 3. Remains of plaster on wall 64304.



Fig. 4. South face of wall 64304.



Fig. 5. Walls 64412, 64304 and 64404 with the staircase 64414.



Fig. 6. The staircase 64414 south of wall 64304/64404.

bedrock, there is a single stone, possibly fallen because it is different, in form and dimensions, from the other stones of the staircase. The average length of the steps is 0.64 m, and both their width and height 0.20 m (**fig. 6**)

• *Locus 64101*

Locus 64101 belongs to area 64100, excavated in 2016. We supposed that the feature was the entrance to an architectural unit which originally extended to the west. Considering the objectives of the 2019 excavation season, the necessity to link architectural features to each other, and taking into consideration their phase and function, this locus was cleaned and a stratigraphic section was drawn in order to understand its structure and its relation to other features discovered around it. It became clear that the course of stones is laid upon a layer of clayish earth and that it is connected with wall 64114. One of its stones bears a Nabatean inscription and it dates probably to the Nabatean Period because. Some of the stones belonging to this locus may have fallen from other structures, especially the stones found on wall 64129 during the same season. Therefore, considering these indications and the results of this year's season, the space between *loci* 64101 and 64129 was interpreted as passage pertaining to the Nabatean Period and connecting architectural units which functioned at that time. It has been in use until the Roman Period (**fig. 2**).

2. Second Phase

This phase is dated to the Roman Period and its features are related to wall 60823, which runs around the temple *temenos*. It is represented by the following features:

• Walls 64409, 64410/64308/64129, 64120:

These three walls, along with wall 64404/64304 which has been assigned to this phase, form a complete architectural unit with clearly identified characteristics. North-south wall 64409 is the east wall of the unit. It clearly abuts wall 64304/64404 and both form the southeast corner of the unit. The three walls belong to one single building phase, as shown by the fact that their masonry is interconnected. Together, they form three sides of a rectangle. Wall 64409 is 2.50 m long, 0.23 m high and 0.70 m wide. It is made of one single course.



Fig. 7. General view of areas 64300 and 64400.

Loci 64410/64308/64129² form the north wall of the unit, the west end of which, made of two courses, started to appear during the 2016 season. It was then believed that it formed a single feature with wall 64120. In area 64400, wall 64410/64308/64129 is made of two courses, it is 1.75 m long, between 0.75 m and 0.35 m high, and 0.65 m wide. In area 64300, the wall is made of one single course of stones. It is 5.75 m long, between 0.25 and 0.30 m high and 0.65 m wide. The entire length of the wall in all three areas (64100, 64300, and 64400) reaches 9.75 m.

Wall 64120 was put to light during the 2016 season. It represents the western wall of the unit. The southern end of this wall was cleared in 2019, when the trench was extended on this side in order to reveal its southern end. However, all that appeared at the southern end is a single large sandstone block laid upon a clayish layer. It is thus clearly different from the rest of the wall, which is made of two courses of stone. Wall 64120 forms, together with wall 64129, the northwest corner of the architectural unit, and it forms, with door 64310, the southwest corner of the unit. Wall 64120 is 3 m long, 0.35 m high and 0.65 m wide (fig. 7)

• Locus 64310

The door leading into the unit formed by walls 64409, 64129/64308/64410), 64120, 64304/64404, located in the southwest corner of the unit, is made of a single well cut sandstone ashlar threshold. Its upper surface is slightly curved and traces left by stone cutting tools, possibly a spindle, are still visible. South of wall 64304, and therefore not far from door 64310, a group of white rectangular sandstones were possibly used as doorjambes. At both ends of the threshold, traces attest the former presence of door panels. The threshold is 1.25 m long, 0.24 m high, 0.23 m thick (fig. 8)

• Loci and Architectural features inside the unit

Some features were put to light inside the architectural unit, laid on the unit's floor which is numbered 64417/64321. The unit's floor was uncovered after the removal of locus 64303 in the east part of trench 64300, between walls 64304 and 64308, and after the removal of surface layer

2. The numbers given to the wall depend on the season and the area. 64129 is the number for the wall in area 64100 during season 2017; 64410 is the number for the wall in area 64400 in 2019, as 64308 is the number in area 64300 in 2019 as well.



Fig. 8. Door 64310.

64401 in trench 64400. The floor layer is marked sandstone blocks laid flat at the same level. The level of the bedrock is different in both areas. It changes between 783.16 m, 783.04 m and 782.32 m above sea level.

The archaeological layers were removed but the stones forming the floor were left *in situ*, in particular in order to be able to get a section clarifying the sequence of layers in area 64300. Starting from the bedrock 64318, it is as follows : it starts with a stratum of friable clayish earth containing some ashes (*locus* 64315), followed by the floor of the architectural unit (*locus* 64321), followed by a consistent clayish layer mixed with a backfill of medium and large building stones (*locus* 64303), followed lastly by the surface layer (*locus* 64300).

In the stratigraphic section of area 64400, obtained from the the baulk which separates areas 64300 and 64400, the stratigraphic sequence begins with the bedrock (*locus* 64418), followed by a layer of medium resistance clayish earth mixed with small gravel (*locus* 64419), followed by a layer of friable clayish earth (*locus* 64416), then by the floor of the architectural unit (*locus* 64417), followed finally by the surface layer (*locus* 64401) (figs 9-10).

In area 64300, standing on floor 64321, the following architectural elements were uncovered:

- Fragments of a circular basin (*locus* 64302), put to light in the southwest part of the area. They belong to the same stone basin parts of which were uncovered during the 2017 season in the south-east corner of area 64100. They had then been numbered 64128.
- Near *locus* 64302, the basis of a stone basin (*locus* 64307) was uncovered. Its diameter is 0.75 m. Close to its northern edge, there is a small circular opening, 0.07 m in diameter.
- North of the stone basin's base, an architectural element made of three stones was put to light (*locus* 64312). Two of these stones face each other, their northern ends abutting the southern face of wall 64308, while the third stone is laid between the two facing ones and abuts their southern ends. All three form a rectangular structure, the upper side of which remains open. The structure is 1 m long, its width varies between 0.45 and 0.50 m and it is 0.26 m high. We supposed that it was used as a receptacle for ashes because there is no trace of fire on its inner stone surfaces. Indeed, inside was found a thick layer of ashes mixed with clayish earth and a backfill of building stones, some stones with traces of fire (fig. 11)

• Wall 64402

North-south sandstone wall located in the east part of area 64400. Its northern end forms an L shape with the western end of wall 64411. It seems to extend beyond the south baulk. The wall is

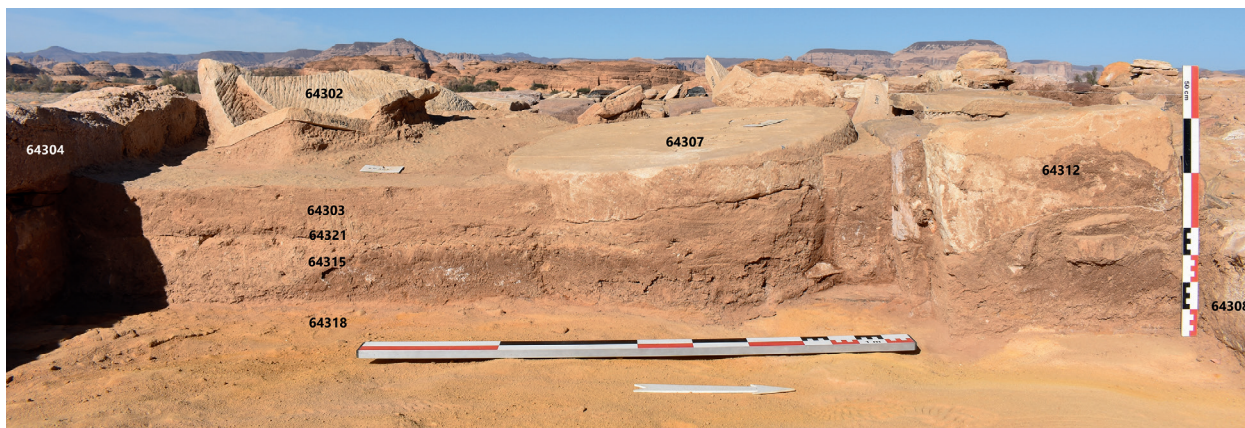

Fig. 9. North-south section of area 64300.

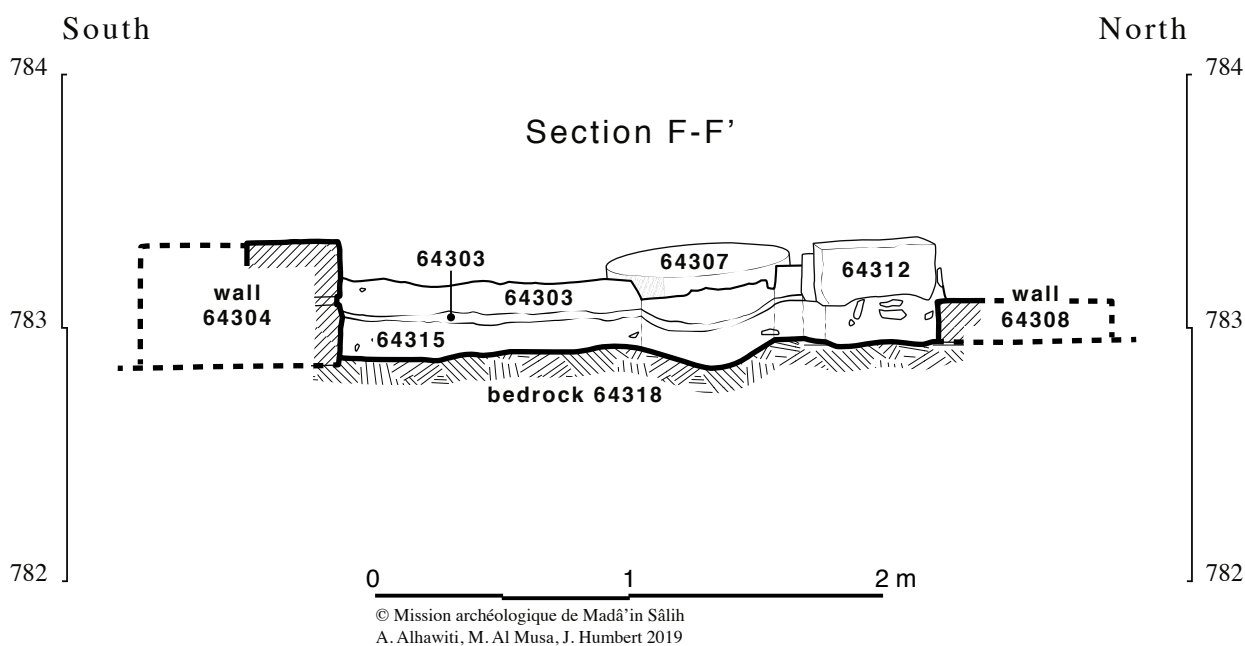

Fig. 10. Drawing of north-south of area 64300.



Fig. 11. Structure 64312 south of wall 64308.

two courses high. It is 4.35 m long, its height varies between 0.30 m on its east face and 0.43 m at its west face. Its thickness is 0.75 m (figs 2, 7)

- **Wall 64411**

East-west sandstone wall located in the northeast part of area 64400. Its western end forms an L shape with the northern end of wall 64402. The eastern end of this wall was uncovered during the 2016 season in area 60000, east of trench 64400, and a sounding was made along it in 2017. It is clearly an extension of wall 60823, which represents simply a 2nd or 3rd century AD enclosure which thus postdates the temenos of the Nabataean phase (see the contribution of D. Gazagne in the report of the 2017 season). Wall 64411 is made of two courses of stones. It is 0.70 m long, 0.78 m high, and 0.70 m wide (figs 2, 7).

- **Wall 64406**

East-west sandstone wall the ends of which abut the corners formed by walls 64410-64409 on the west and by walls 64402-64411 on the east. 64406 is therefore clearly later than the architectural units formed by the walls described above and its *terminus post quem* is the date of wall 64411/60823, i.e. 2nd/3rd century AD (all we can say for the moment is that it is probably Roman, and probably not late Roman). Note that it contains some reused Nabataean stones. Concerning its function, it seems that this wall aims at closing, in the north, the passage formed by walls 64402 and 64409, which was most likely a street. Wall 64406 is made of two courses of stones. It is 5.10 m long, 0.50 m high and 0.70 wide (figs 2, 7).

Findings

The findings of areas 64300 and 64400 show similarities with the material uncovered in the neighbouring trenches. They include:

- Pottery: the excavations yielded a lot of pottery, and the dominant ware is both coarse and semi-coarse, with colors ranging from dark brown to light brown, dark green, light green, and grey. The majority of the sherds are body sherds. A quick examination of the pottery, which was not thoroughly studied yet, shows that *loci* 64301 and 64403 can be paralleled, from the pottery perspective, with *loci* 63041, 63051, and 63056 (from area 63000 to the north of the 2019 trenches). Considering that most layers are made of backfill materials, where later period elements are mixed with earlier period ones, the majority of pottery pertains to the period between the first century BC and the fifth century CE.



Fig. 12. Roman coin.



Fig. 13. Fragment of decorated pottery lamp.



Fig. 14. *Fragment of Latin inscription showing three letters.*



Fig. 15. *Lid of a stone vessel.*

- Coins and metal objects: some Nabatean and Roman coins were discovered, as well as many bronze and copper objects (**fig. 12**)
- Other artefacts:
 - a fragment of pottery oil lamp dating back to the Roman Period (**fig. 13**) ;
 - fragment of a stone bearing Latin characters where letters LE can be read (possibly with A before) (**fig. 14**) ;
 - the circular lid of a stone vessel (**Fig. 15**)
 - many other findings, including glass, sea shells, ostrich eggshells, bones.

Conclusion

As previously stated, the architectural features identified in areas 64300 and 64400 belong to two building phases. The results of the 2019 season complement what was uncovered during the previous seasons, establish the connection between several architectural elements, and confirm the existence of parallels between the stratigraphic sequences obtained in various areas around IGN 132. They also shed light on the function of the various structures put to light.

The first architectural phase, which dates back to the Nabatean period, is represented by the following features: wall 64404/64304, wall 64412, staircase 64414/64306. They belong to an architectural unit which extends beyond the south baulk, the function of which is still undetermined. Wall 64404/64304 was definitely used during the subsequent periods. This can be clearly observed through floor 64321, which is Roman in date, and which is laid over the gypsous plaster covering the north face of wall 64404/64304. This indicates that the wall is earlier than the preparation of the floor, and of course earlier than the architectural elements which go with it. The passageway 64101, uncovered in 2016, belongs also to this phase, as well as wall 64114. The latter contains a block bearing a Nabataean inscription, probably reused. Some of the stones of this feature may have fallen, especially considering what was found on top of wall 64129, also in 2016. Therefore, considering the above, we consider the space between 64101 and 64129 as being a passage dating back to the Nabatean Period. It connected architectural units pertaining to the same phase and was in use until the Roman Period.

The second architectural phase, dating to the Roman Period, is represented by the following architectural features: walls 64409, 64410/64308/64129, 64120, with wall 64404/64304 which dates back to the Nabataean period but which was reused in the Roman phase as the southern wall of an architectural unit, with the addition of door 64310. It seems that this door did not exist initially in the Nabataean wall 64304 and was added later to provide access to the room created in the Roman period. It is even possible that the threshold is a reused stone. The structures put



Fig. 16. The south flank of IGN 132 showing the row of rock-cut holes (before excavation).

to light inside this unit (64302 = 64128, 64307, 64312), point to it having been used either for domestic or craft activities. The space between walls 64402 and 64411 – that have an L shape on the east – and walls 64409, 64308/64410 – that have an L shape on the west, was clearly a street/passageway which may have existed already in the Nabataean period but which functioned certainly as such in the Roman period. At some point during the Roman period as well (although it

is difficult to be more precise for the moment), the street was closed by wall 64406, either in order to close the outer perimeter wall 60823, of which 64411 is the continuation, or it was built in association with the row of rock-cut holes which were cut high up on the southern flank of IGN 132, exactly above 64411 (figs 2, 7). The stratigraphic sequence in the street differs from the stratigraphic sequence elsewhere in the area (fig. 16, compare with fig. 10). In the street, the sequence is the following from bottom to top: bedrock 64418, overlaid with a thick layer of clayish earth of medium consistence mixed with some ash and fallen stones (64413), followed by a layer of consistent clayish earth mixed with some building stones (64405), and at the top the surface layer (64401) made of a thin layer of clayish earth mixed with small stones and pottery sherds.

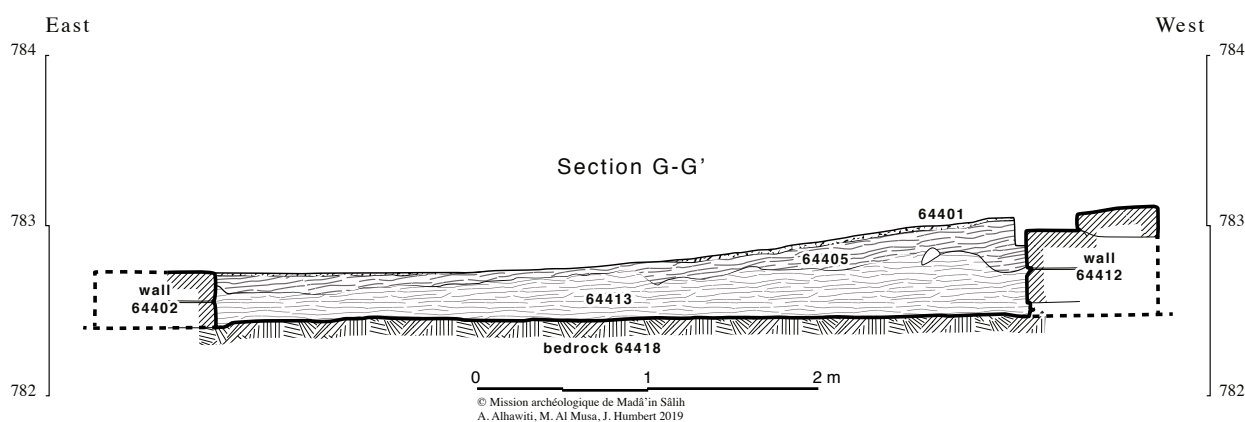

Fig. 17. East-west section of area 64400.

Bibliography

الطحي، ضيف الله، «تقرير مبدئي عن اعمال التنقيب في مدائن صالح (الحجر) الموسم الخامس». اطلال 20، (2003م)، ص 15-29.

Nehmé L. (ed.). *Reports on the 2015, 2016 and 2017 seasons of the Madâin Sâlih archaeological Project.*

2015: <https://halshs.archives-ouvertes.fr/halshs-01311865>

2016: <https://hal.archives-ouvertes.fr/hal-01518460>

2017: <https://hal.archives-ouvertes.fr/hal-01804965>

Pottery Report

Caroline DURAND (HiSoMa, Lyon)

In 2019, the pottery reading took place from February 2nd to February 21st. Three areas were excavated during this season: the Roman fort (Area 34, *loci* 34500), the sanctuary IGN 132 (Area 61, *loci* 61900) and the outskirts of this same sanctuary, Area 64 (*loci* 64300 & 64400). Besides, an epigraphical and archaeological survey between al-'Ulâ and Medina (UM 2019) was undertaken by Laïla Nehmé and two other team members, during which some pottery sherds were collected. The pottery material from Areas 61 and 64 was only partly studied. In Area 61, the material associated to the kilns/tannurs which were put to light in Sounding 4 (see the report by D. Gazagne and M. al-Juhany) is composed mainly of jars and cooking-pots and can be dated to the last occupation phase of the site (probably late 4th–early 5th century AD). This is also the case in the upper layers (*loci* 61910–61913) in Sounding 5. The pottery from Soundings 6, 7 and 8 will be recorded in priority in 2020. In Area 64, the important *loci* 64305, 64314, 64315, and 64316 contained a mix of Nabataean pottery and later material from the last occupation phase (not many diagnostic sherds).

The main part of the study season was devoted to the study of the pottery material from the Roman fort and from the al-'Ulâ–Medina survey. Preliminary results are presented below.

Pottery from the Roman fort (Area 34500)

The Roman fort area yielded a huge quantity of pottery. The material from the upper layers (*loci* 34505, 34506, 34508, and 34509) can be dated to the last occupation phase of the site (late 4th to early 5th century AD). The very important amount of pottery unearthed from these layers suggests that this area was used as a dump during this period. It seems that the same observation was made regarding the archeozoological remains, to be confirmed when the study of the latter is finished. The main part of the pottery from this dump belongs to the local common ware category. It includes *pithoi*/storage jars, four-handled jars (**fig. 1**, 34509_P20), as well as numerous cooking-pots, especially many carinated cooking-pots, sometimes decorated on the shoulder. These cooking-pots show the typical fabric and profile of the last phase of Hegra (see a selection fig. 1). Many imports were also recorded, including fine wares such as African sigillata (34505_P07), Eastern Sigillata (34508_P07, residual?) and Mesopotamian green glazed ware (34505_P08; 34506_P01). Several fragments of Mediterranean amphorae were also identified: amphora type Kapitän 2 (34505_P12; 34508_P09 & 34509_P26), probably from the Aegean area and mainly diffused in the 3rd–4th century AD; other Aegean types which may belong to earlier

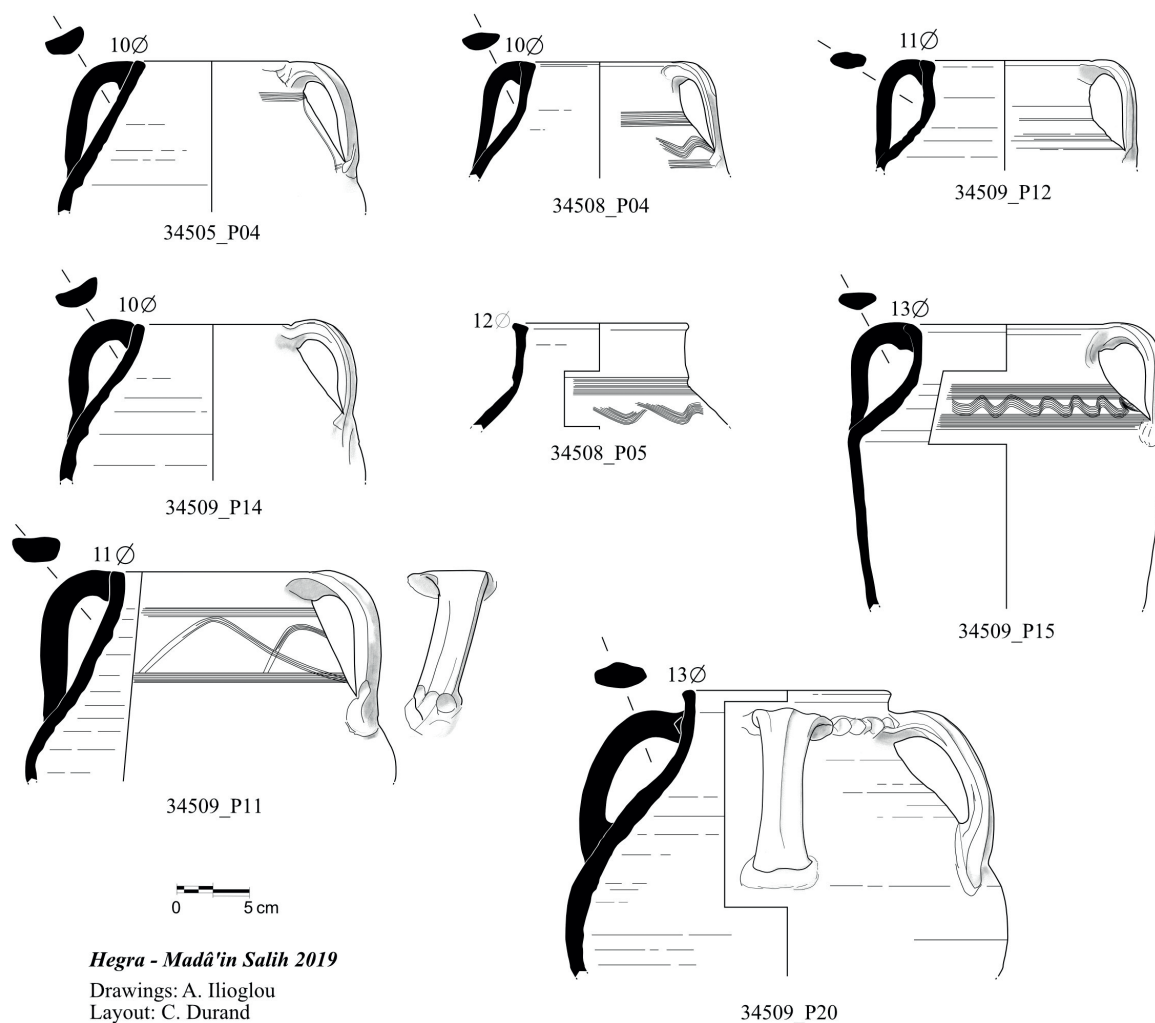

Fig. 1. Area 34, selection of pottery from the late dump.

periods (34505_P13; 34508_P08, possibly Rhodian), as well as a possible sherd of Dressel 2–4 (34505_P11), produced in Campania and widely diffused during the Roman period.

A complete lamp, most probably residual, was found in *locus* 34519 (**fig. 2**, 34519_P01). It has exact parallels in Petra and Khirbat Dharih which can be dated to the end of the 1st century AD (see Durand 2011: 47 & fig. 1-D, no. 11 with bibliography). *Locus* 34530 (not illustrated) can probably be dated to the 3rd–early 4th century AD. It contained several fragments of green glazed ware (34530_P01; 34530_P02), as well as a *tubulus* fragment with remains of plaster on the exterior (34530_P03). This fragment suggests the presence in the immediate vicinity (or in the building itself?) of a Roman bath with a heating system (hypocaust), this hypothesis being strengthened by the architecture (see the report by Z. Fiema). Below these upper disturbed layers, several occupation layers were found (*loci* 34531, 34533, and 34544), possibly dating from the



Fig. 2. Lamp 34519_P01.

Roman/Late Roman period, ca. 2nd–3rd century AD (**fig. 3**). An unusual pottery type, bearing a decoration in relief, was discovered in *locus* 34531 (**fig. 3**, 34531_P01). The pattern remains undetermined, possibly an animal figure (?). Among the significative finds, one can mention the presence of a decorated green glazed sherd (**fig. 3**, 34531_P08) and of a fragment of so-called “Nabataean painted common ware” probably imported from Petra (**fig. 3**, 34544_P07). In Petra, this type of painted pottery is clearly dated from the 2nd to the 3rd century AD (Gerber and Durand 2014: 275, 285-286, figs 25–27). Lastly, in the lower layers, a Nabataean/1st century AD phase of occupation phase seems indicated by *locus* 34551 (not illustrated).

Pottery from the Al-‘Ulâ – Medina Survey (UM 2019)

Pottery sherds were sampled on sites visited during the survey undertaken between al-‘Ulâ and Medina by Laïla Nehmé and other members of the team (see the report by L. Nehmé *et alii*) (**fig. 4–6**). The pottery from al-‘Amâ’ir (AA 1–2), aḍ-Ḍulay’ah (AD), al-Khuraym (AK), al-Raḥba (AR), Khurayyit Yanbu’ (KY), Qaşr Wādī Ḥarb (QWH) and Umm al-Ārāk (UA) suggests, as can be expected, that these sites are dated to the Islamic period. The majority of the pottery material presents a creamy/greenish fabric covered with a whitish slip, among which many fragments bear an incised decoration consisting most of the time of strips of horizontal lines alternating with strips of wavy lines, sometimes superimposed. Many large basins (**fig. 4**, AA2_P05, P06, P08; **fig. 5**, AD_P01; AR_P01, P02, P03; **fig. 6**, QWH_P01, P02) with incised decoration could be dated to the Umayyad period. Fine ware sherds with very thin wall and incised decoration (**fig. 4**, AA2_P17; **fig. 6**, KY_P04; QWH_P03) are comparable with the pottery from al-Ḥīra produced in the region of Baṣra in Southern Iraq (Rousset 2001, in particular 225, fig. 1). This pottery production is dated to the 8th–9th century AD (Umayyad/early Abbasid period). Lastly, we can mention the presence in these sites of a few small glazed pottery sherds (**fig. 4**, AA2_P18; **fig. 6**, UA_P09). It should however be remembered that the author of this report is not a specialist of the pottery from the Islamic period and the conclusions need therefore to be confirmed.

Two sites present a pottery material which differs strongly from that of the others and is clearly not dated to the Islamic period: al-Muṣanna’ah and Umm Hidim. Umm Hidim is located southwest of al-‘Ulâ, close to the embranchment of Wadi Jizzl. The pottery from this site (not illustrated) is composed of many *pithoi*, among which one made in the fabric labelled “Hegra 9”, some large bowls and cooking-pots, but no fine ware. The fabrics, mainly reddish to reddish-brown with vegetal temper, as well as the profiles of the vessels, are very similar to the pottery observed at Umm Daraj, currently under study (Durand and Gerber 2018: 143). Therefore, it is possible that site was occupied from the Lihyanite to the early Nabataean period. The fort of al-Muṣanna’ah (AM 1 and 2) yielded unfortunately only nine small and very eroded body sherds. Without any information on the profile, we can only rely on the fabric in order to determine the chronology. The sherds present mostly a reddish-brown to brownish fabric and no cream/greenish fabric has been observed. One sherd corresponds to the fabric known as “Hegra 9”. These observations, as well as the location and plan of this fort (see Nehmé *et alii*) suggest that its date, thought to be Islamic, should be reassessed. It is possible that this fort was an earlier building, possibly from the (Late Nabataean?)/Roman period. Of course, this hypothesis should be checked through a proper study and excavation.

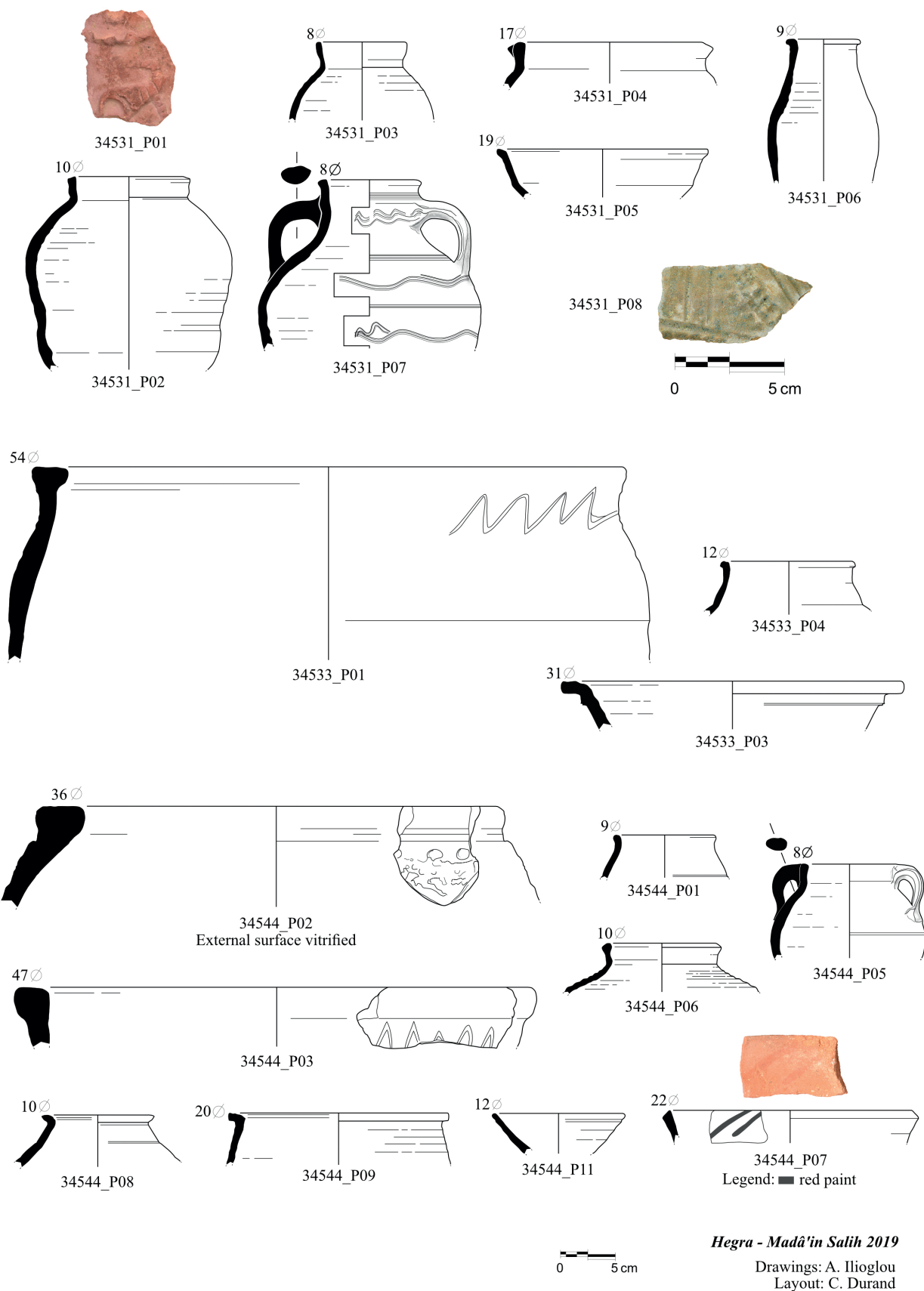
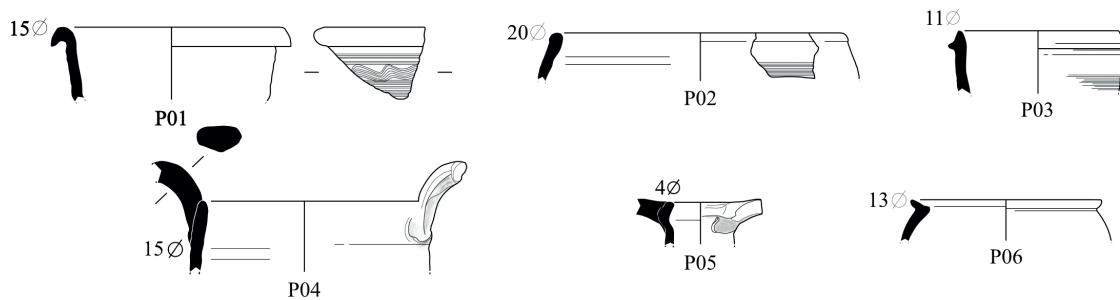
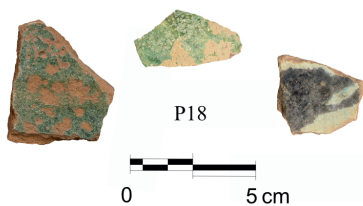
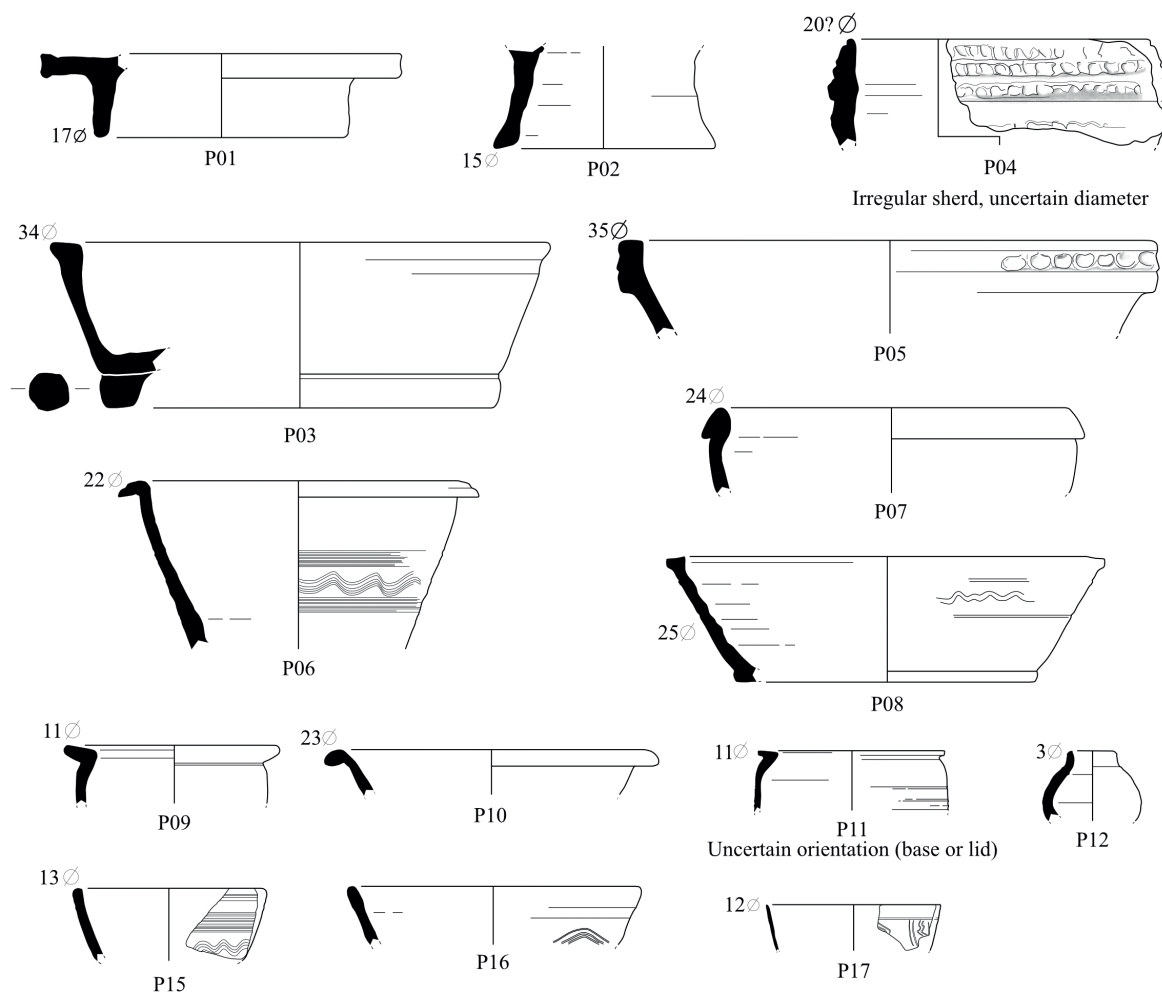

Fig. 3. Area 34, pottery from the Roman period.

al-'Amā'ir 1



al-'Amā'ir 2



Survey UM 2019
 Drawings: A.Ilioglou
 Layout: C. Durand

Fig. 4. Pottery from the UM Survey: al-'Amā'ir.

aḏ-Ḍulay‘ah

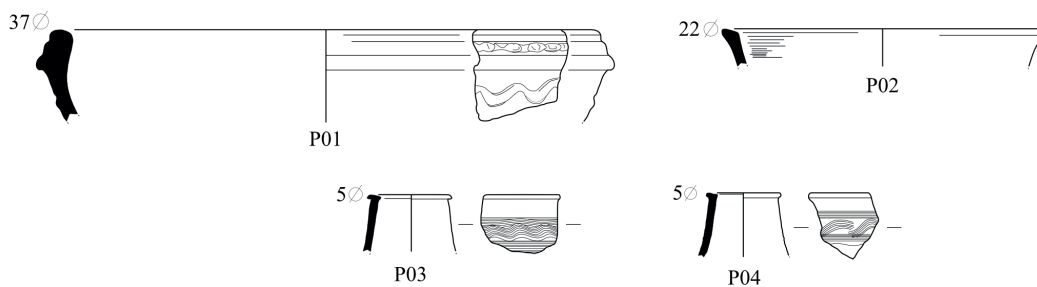

al-Khuraym 1

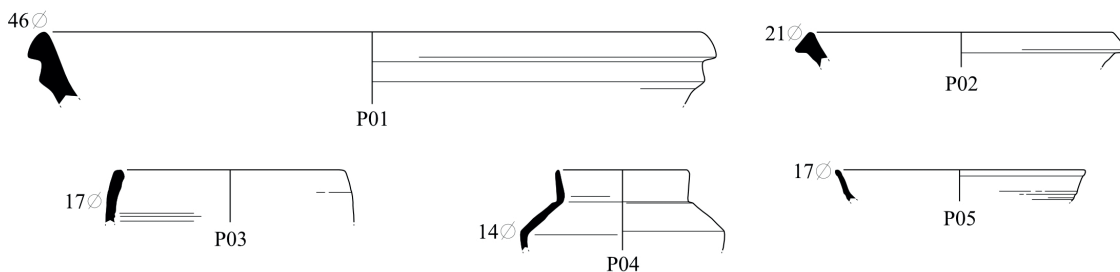

al-Raḥbah

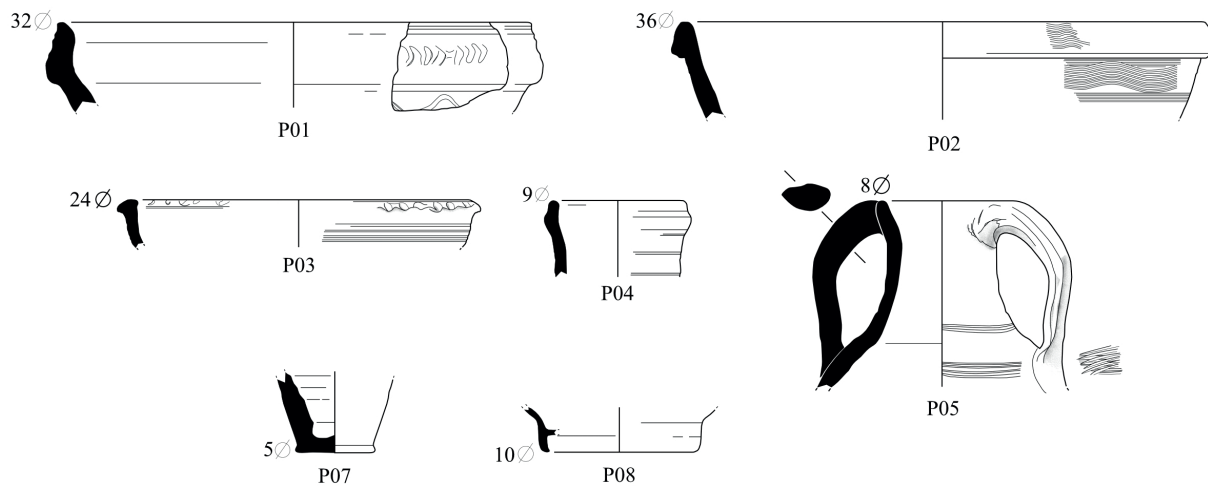

Survey UM 2019
Drawings: A.Ilioglou
Layout: C. Durand

Fig. 5. Pottery from the UM Survey: aḏ-Ḍulay‘ah, al-Khuraym, al-Raḥbah.

Khurayyit Yanbu'

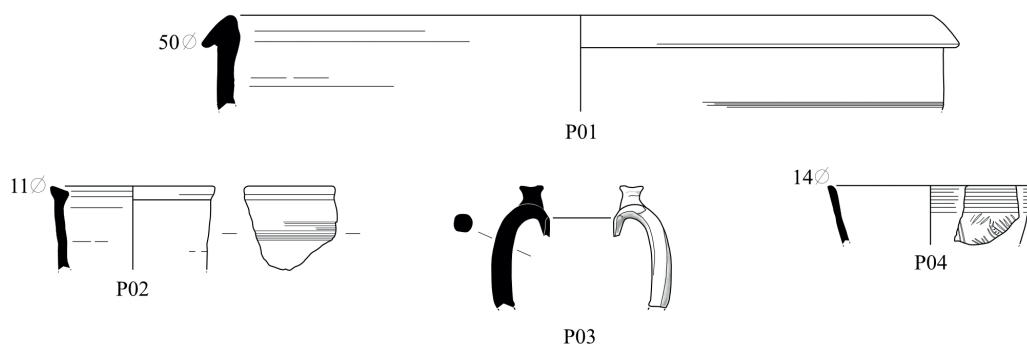

Qaşr Wādī Ḥarb

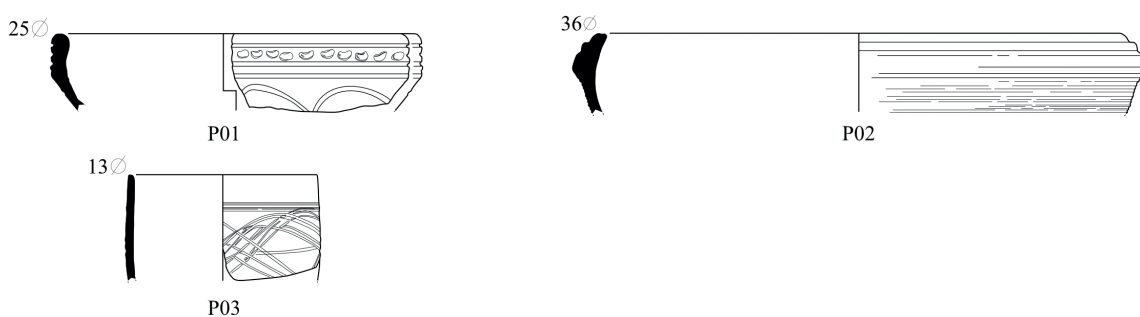

Umm al-Ārāk

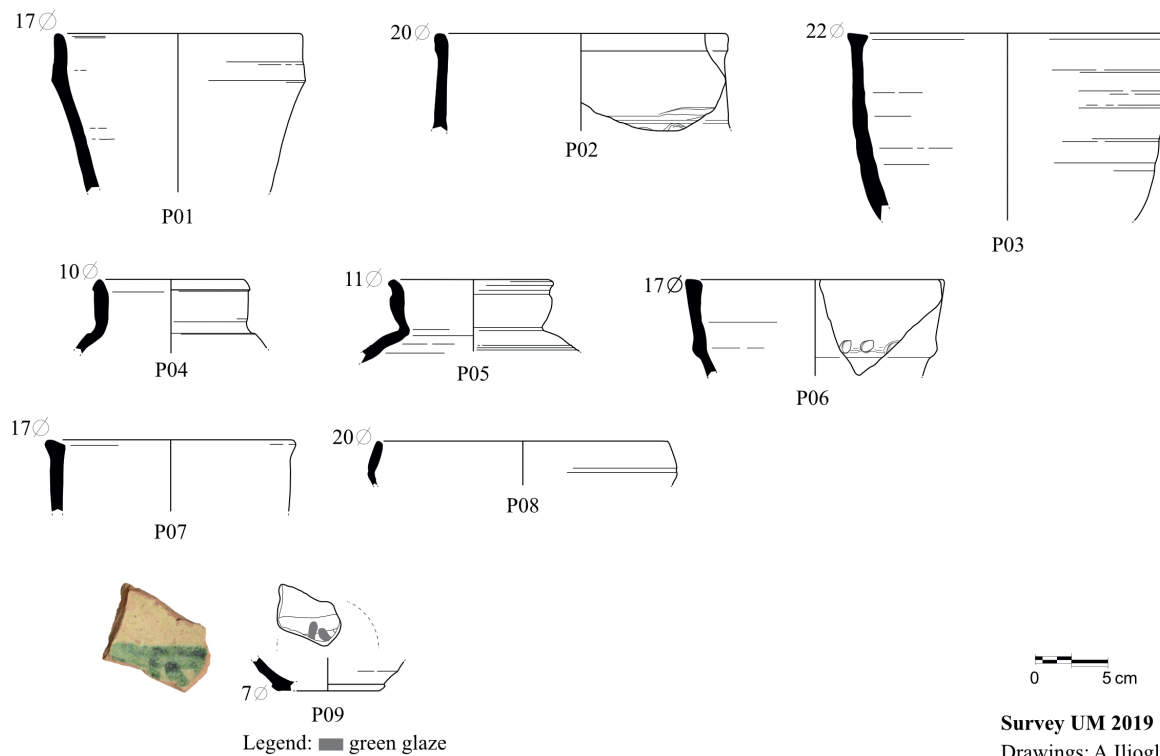

Survey UM 2019
 Drawings: A.Ilioglou
 Layout: C. Durand

Fig. 6. Pottery from the UM Survey: Khurayyit Yanbu', Qaşr Wādī Ḥarb and Umm al-Ārāk.

Exports for residues analysis

A selection of base sherds from the jars found in 2015 in front of tomb IGN 116.1, as well as an alabaster fragment put to light during the 2019 season have been exported to France for the analysis of the residues of organic material they may contain. The aim of this analysis is to determine what was the contents of the characteristic 1st century AD local jars (so-called “jars with pinched rim”). Ten or so complete or almost complete jars of this type, which were probably part of the ritual deposits, were discovered in front of tomb IGN 116.1. The analysis will be carried out by the Laboratory Nicolas Garnier, with the financial support of the French Agency for the development of AIUla (Afalula), in collaboration with Elisabeth Dodinet.

List of samples exported:

- 34512_S01: small base of alabaster pot; provenance Roman fort;
- 50502_1: base sherd of jar; provenance tomb IGN 116.1;
- 50502_2: base sherd of jar; provenance tomb IGN 116.1;
- 50504_1: base sherd of jar; provenance tomb IGN 116.1;
- 50504_2: base sherd of jar; provenance tomb IGN 116.1 (taken from the jar 50504_P05);
- 50506_1: base sherd of jar; provenance tomb IGN 116.1 (taken from the jar 50506_P04);
- 50507_1: base sherd of jar; provenance tomb IGN 116.1.

References

- Durand C. 2011. “Les lampes nabatéennes et romaines de Khirbet edh-Dharih (Jordanie). I^{er}-IV^e siècles apr. J.-C.” in D. Frangié and J.-F. Salles (eds), *Ancient Lamps of the Bilad esh-Sham, actes du colloque d’Amman, 6-13 novembre 2005*. Paris: De Boccard: 43–73.
- Durand C. and Gerber Y. 2018. “Pottery Report, with an appendix on alabaster vessels”, in L. Nehmé (ed.), *Mission archéologique de Madā’in Šāliḥ. Rapport de la campagne 2018*. Paris: 141–146. <https://hal.archives-ouvertes.fr/hal-02096625>
- Gerber Y. and Durand C. 2014. “Pottery Study”, in L. Nehmé, D. al-Talhi, and F. Villeneuve (eds), *Report on the Second Season of the Madā’in Šāliḥ Archaeological Project, 2009, Saudi Arabia. (A Series of Archaeological Refereed Studies, 13)*. Riyadh: SCTA: 273–297. <http://halshs.archives-ouvertes.fr/halshs-00548747/fr>
- Rousset M.-O. 2001. “La céramique de Hira à décor moulé, incisé ou appliqué. Techniques de fabrication et aperçu de la diffusion”, in E. Villeneuve and P.M. Watson (eds), *La céramique byzantine et proto-islamique en Syrie-Jordanie (IV^e-VIII^e siècles apr. J.-C.)*. Beirut: IFPO: 221–230.

Étude anthropologique

Nathalie DELHOPITAL

L'étude anthropologique des ossements mis au jour dans les tombeaux fouillés à Madâin Sâlih n'ayant pas pu être terminée au cours de ma dernière mission sur le terrain en 2015, j'ai consacré deux semaines, en 2019, à la poursuite de cette étude ainsi qu'à des expertises réalisées dans le cadre d'un projet de restitution faciale de sujets nabatéens lancé par la Royal Commission for AlUla. Il s'agissait d'identifier les crânes permettant une telle restitution (un de femme, un d'homme et un d'enfant) et d'évaluer les propositions envoyées à la Commission suite au lancement de l'appel d'offres.

L'étude anthropologique proprement dite a porté sur le matériel contenu dans les tombeaux IGN 116.1 et IGN 97 ainsi que sur les deux individus mis au jour dans la zone 34, celle du camp romain.

IGN 116.1

L'étude anthropologique, commencée en 2015, avait permis d'établir que vingt-sept individus avaient été inhumés dans ce tombeau, dont onze dans la partie centrale de la chambre funéraire et huit dans chacun des deux coffrages. Au total, vingt adultes parmi lesquels on compte deux femmes et quatre hommes, avaient été identifiés. Ils s'ajoutent à sept immatures (deux périnatales, trois individus âgés de 1 à 4 ans, un âgé de 5 à 9 ans et une adolescente). Les caractères discrets observés au cours de la fouille et de l'étude avaient indiqué qu'il s'agissait probablement des membres d'une même famille. Nous avons également conclu qu'il n'y avait pas eu de sélection démographique (**fig. 1**).

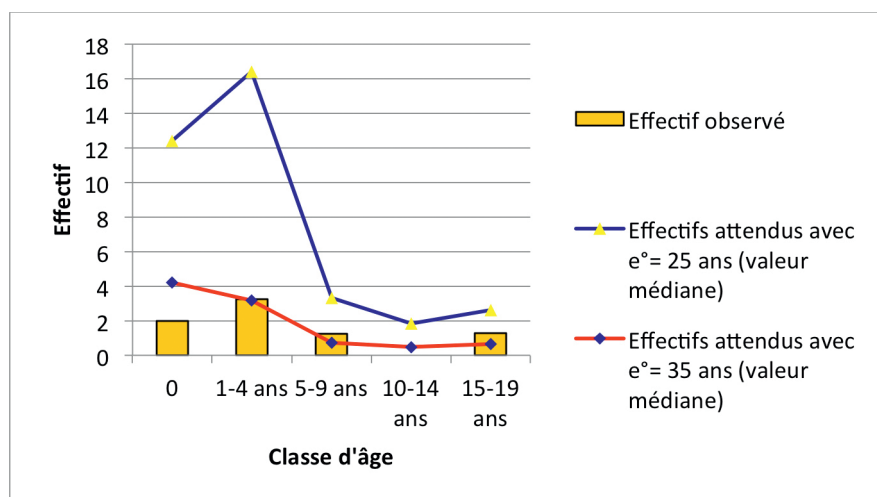

Fig. 1. Représentation graphique de l'étude anthropologique pour le tombeau IGN 116.1.

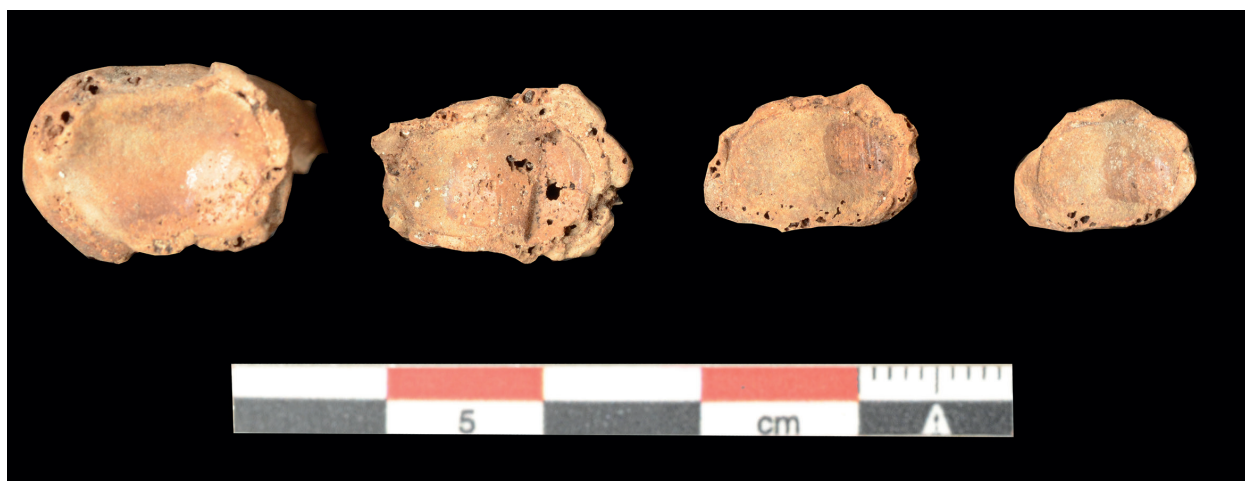

Fig. 2. 50533_B02, ossements du carpe présentant de l'arthrose.

En 2019, nous avons terminé l'étude des ossements « isolés » des cercueils 50521 et 50533. Il s'agit d'ossements que nous n'avons pas réussi à attribuer à un individu en cours de fouille.

Pour rappel, le cercueil 50533 contenait huit individus parmi lesquels :

Squelette 50555 : il s'agit peut-être d'un individu mort en couches. Données biologiques : stature 1,65 m (\pm 5,03 cm).

Squelette 50550 : individu adulte de sexe masculin. Données biologiques : stature 1,70 m (\pm 4,14 cm).

Squelette 50556 : individu âgé de 20 à 30 ans. Données biologiques : stature : 1,59 m (\pm 4,14 cm).

Squelette 50557 : individu adulte.

Nous avons également observé cette année de l'arthrose sur les ossements isolés appartenant à au moins à un des individus adulte. Elle se situe : au niveau des mains (des phalanges de mains) avec de l'arthrose au stade 1 et au stade 3 (**fig. 2**) ; au niveau des pieds (phalange / talus / calcaneus) ; au niveau des genoux (patella / fémur).

Le cercueil 50521 contenait huit individus, dont 6 adultes :

Squelette 50538 : adulte 1,62 m (\pm 4,20 cm).

Squelette 50534 : adulte 1,63 m.

Squelette 50535 : adulte 1,47 m.

Les individus adultes mesurent entre 1,47 et 1,63 m.

L'étude réalisée a permis d'observer un crâne avec des *cribra orbitalia*.

De l'arthrose était présente sur les vertèbres cervicales. Nous avons aussi noté, sur une vertèbre thoracique, l'écrasement du corps et de l'arthrose sur les vertèbres lombaires. Nous n'avons pas pu attribuer ces ossements à un individu en particulier.

La stature des individus de ce tombeau varie de 1,47 à 1,80 m. Les dents, non étudiées, n'ont pas pu fournir d'informations sur les indicateurs de stress et les pathologies dentaires. Les pathologies articulaires semblent quant à elles plus liées à la vieillesse qu'à des activités physiquement difficiles. Les fractures repérées sont probablement liées à des chutes.



Fig. 3. 50432_B01, patellas provenant de IGN 97 et présentant de l'arthrose. À gauche celles de gauche, à droite celles de droite.

IGN 97

Au cours de la mission d'étude 2015, nous n'avons étudié que les blocs crânio-faciaux. À partir du décompte des mandibules, nous avons ainsi pu déterminer le nombre minimum d'individus, à savoir cinquante, dont trente-deux adultes et dix-huit immatures. Parmi les immatures, deux sont âgés de 5 à 9 ans, deux de 1 à 4 ans, deux de 6 à 9 mois et douze enfin ont moins de 6 mois. L'étude reste partielle mais nous notons cependant une absence de sélection des très jeunes enfants.

En 2019, nous avons réalisé uniquement l'étude des patellas : trente-six patellas droites appartenant à des adultes dont quatre comportant des stades d'arthrose 2 (**fig. 3**), avec des indices patellaires compris entre 82 à 105. Pour les patellas gauches, trente et une patellas ont été dénombrées, dont deux avec un stade 2 d'arthrose et une avec un stade 1, avec des indices patellaires compris entre 84 et 102 (**fig. 3**).

Le crâne 35538

En 2017, un crâne, sa mandibule, et ses deux premières vertèbres cervicales (atlas et axis) ont été découverts lors de la fouille de la porte dite du sud-est du rempart de la ville (**fig. 4**) (voir le rapport 2017, rapport de F. Villeneuve, <https://hal.archives-ouvertes.fr/hal-01804965>). Il a été établi par Jacqueline Studer que ce crâne a été effectivement décapité, comme cela avait été suggéré par le fouilleur (les traces de la décapitation font ou feront l'objet d'une description par Jacqueline Studer). Une blessure guérie est visible au niveau de l'œil (**fig. 5**) ; un projectile a probablement pénétré dans l'œil et nous constatons une reconstruction osseuse là où il a pénétré (**fig. 6**).

Description biologique du crâne : il s'agit d'un crâne hyper-brachicrâne. Nous n'avons noté aucun caractère discret. Toutes les dents étaient présentes hormis la troisième molaire droite et gauche (probablement une agénésie). Nous n'avons pas observé de carie mais nous avons noté la présence de tartre au niveau des canines et incisives inférieures. Une usure importante des dents inférieures a été observée. Il s'agit d'une usure bucco-linguale qui est plus importante côté lingual. Pour les dents supérieures, nous constatons l'inverse, à savoir une usure plus importante au niveau buccal, surtout au niveau des secondes prémolaires et des premières et secondes



Fig. 4. Le crâne 35538 vu de côté.



Fig. 5. Orbite gauche du crâne 35538.



Fig. 6. Reconstruction osseuse là où le projectile a pénétré dans l'orbite du crâne 35538.

molaires. Nous avons enfin noté des hypoplasies de l'émail dentaire. Il s'agit d'hypoplasie au stade 1 à 2 ayant eu lieu entre 2 et 4 ans.

Les squelettes de la zone 34

Les ossements étaient assez mal conservés, ce qui a limité l'étude biologique.

Individu 34133-1

Il s'agit d'un individu adulte (plus de 30 ans), robuste. Nous n'avons pas observé d'arthrose mais nous avons noté la présence d'enthésopathie sur les vertèbres. Les dents présentaient une usure assez importante (stade 4 à 5) : trois molaires inférieures au stade 4, deux prémolaires supérieures au stade 5 ainsi que les deux incisives centrales.

Individu 34133-2

Le second individu, de plus de 30 ans, est une femme. Nous n'avons pas observé d'arthrose. Les dents n'étaient pas étudiables.

Analyse archéozoologique : priorités et perspectives

Jacqueline STUDER (Muséum d'histoire naturelle de la Ville de Genève)

À la suite des huit missions archéozoologiques entreprises depuis 2010, qui ont duré de deux à quatre semaines chacune, la faune sauvage et domestique exploitée par les habitants de la ville antique de Hégra compte plus de 30 000 vestiges analysés. S'y ajoutent quelques milliers d'ossements de rongeurs et de reptiles découverts dans les tombes nabatéennes, qui composent d'anciennes pelotes de réjections d'oiseaux de proies. Dans l'enceinte de la ville antique, le matériel faunique provient de tous les quartiers d'habitation fouillés par les archéologues, des niveaux pré-nabatéens aux niveaux post-romains. L'importante quantité d'ossements déjà étudiés correspond aux niveaux chronologiques et aux structures les mieux documentés par l'archéologie. Elle ne représente cependant que 20 à 30 % de l'ensemble du matériel faunique collecté à ce jour. De plus, certains aspects de la faune sont encore mal documentés. J'ai donc mené une réflexion visant à définir des objectifs de recherche permettant de mieux cerner la place de l'animal dans une société qui a évolué sur plus de six siècles à Madâ'in Sâlih. Les points suivants ont été considérés comme prioritaires :

- 1) Il est impératif de poursuivre la documentation des fouilles en cours. En accord avec les archéologues, il est ainsi prévu d'étudier avant tout les *loci in situ* qui ont bénéficié d'une collecte de matériel osseux à l'aide du tamisage des sédiments ;
- 2) L'assemblage faunique est pauvre en restes de poissons et d'oiseaux. Avec 300 fragments, l'ichtyofaune représente à peine 1 % du nombre total de restes. L'avifaune n'est guère plus nombreuse, avec 250 vestiges d'oiseaux dont une centaine de coquilles d'œufs d'autruche et seulement 45 os de poulets. S'il semble évident que les produits de la mer Rouge et la chair de volaille n'étaient pas consommés régulièrement à Hegra, quelle que soit la période considérée ou le quartier d'habitation et autres lieux d'activités, il serait intéressant de compléter ces lots dans la mesure du possible. Le contrôle des centaines de lots non étudiés entreposés au Musée d'archéologie d'al-'Ulâ permettrait l'extraction des pièces convoitées et l'établissement d'un inventaire sommaire de chaque *locus*.
- 3) Manipuler l'ensemble des cartons et sachets serait alors l'occasion d'isoler toutes les espèces peu fréquentes (les équidés, les gazelles etc) et les éléments anatomiques exceptionnels (par exemple des os longs entiers de chèvres ou de moutons).
- 4) Longtemps négligés car peu nombreux et récoltés sans l'aide de tamisage, les os prélevés dans les sondages excavés le long du mur d'enceinte pourraient fournir des informations absentes des quartiers de la ville antique et du camp militaire. Leur analyse est en cours.

HEGRA		Area	34	34	34	6	6	6	6	6	6	6	TOTAL
		Locus	34509	34525	Total	60885	61015	61016	61022	61026	61902	Total	
		Period	pRom	pRom		LRom					pRom		
DOMESTIC MAMMAL													
Dromedary	<i>Camelus</i> <i>cf. dromedarius</i>		54	40	94	7	4	3	1	-	-	15	109
Donkey	<i>Equus asinus</i>		1	-	1	2	-	-	-	-	-	2	3
Donkey/horse			1		1	1	--	-	-	-	-	1	2
Pig	<i>Sus domesticus</i>		6	5	11	-		-	-	-	-	-	11
Sheep/Goat	<i>Ovis aries/</i> <i>Capra hircus</i>		205	78	283	356	21	5	32	-	25	439	722
Cattle	<i>Bos taurus</i>		3		3	-		-	-	-	-	-	3
WILD MAMMAL													
Rodents			-	1	1	-	-	-	-	-	2	2	3
Cape hare	<i>Lepus capensis</i>		2	6	8	1	--	-	-	-	-	1	9
Red fox	<i>Vulpes vulpes</i>		-	-	0	2		-	-	-	-	2	2
Arabian oryx	<i>Oryx leucoryx</i>		2	-	2	-	-	-	-	-	-	-	2
Gazelle	<i>Gazella spp.</i>		4	1	5	52	-	-	-	-	-	52	57
DOMESTIC BIRD													
Chicken	<i>Gallus domesticus</i>		12	7	19	3	-	-	-	-	-	3	22
WILD BIRD													
cf. Raptor			19	1	20	7	-	-	-	-	-	7	27
Mollusc				1	1	4	-	-	-	-	-	4	5
Fish			1		1	1	-	-	-	-	-	1	2
Mammal indet.			215	146	361	1426	14	4	115	2	546	2107	2468
Bird indet.			-	-	-	1	-	-	-	-	-	1	1
Total	Total		521	285	806	1810	39	12	148	2	573	2585	3391

Tableau 1. Hégra. Faune identifiée en 2019.



Fig. 1. Hégra. Zone 34, locus 34525. Les niveaux post-romains de la zone 34 ont fourni de nombreux vestiges de dromadaires.



Fig. 2. Hégra. Zone 34, locus 34509. Fragment d'un noyau osseux de la corne d'un oryx d'Arabie (*Oryx leucoryx*).



Fig. 3. Tri de lots d'ossements récoltés à l'aide du tamisage des sédiments. Zone 6, locus 61902.

Ce sont donc ces axes prioritaires qui ont marqué la campagne archéozoologique de la mission 2019. La campagne s'est déroulée du 24 janvier au 14 février. Elle a permis l'analyse d'un total de 3 391 vestiges fauniques provenant de deux zones en cours de fouille (tableau 1). La première est le camp militaire romain (zone 34, loci 34509 et 34525) dont 806 restes d'animaux ont été analysés. Les lots sont ici composés d'une grande quantité d'ossements appartenant à des animaux de grande taille, principalement du dromadaire, accompagné de quelques os d'âne et de bœuf (**tableau 1, fig. 1**). Les vestiges des trois espèces présentent des traces de boucherie caractéristiques d'un traitement des carcasses exploitées pour la consommation de viande. Notons encore deux fragments de chevilles osseuses d'un oryx d'Arabie (*Oryx leucoryx*) (**fig. 2**). Ces noyaux de cornes témoignent, pour la première fois, de la présence de cette antilope dans la zone du camp romain (locus 34509, phase 6). L'importance quantitative des déchets alimentaires provenant d'animaux de grande taille pourrait signaler des zones de rejets propices aux grands déchets, mais aussi une consommation de viande de dromadaire plus fréquente ici qu'ailleurs. Ce problème est délicat à résoudre et nécessite l'étude d'autres loci avant d'entamer des analyses plus pointues comme celle de la répartition spatiale et chrono-

logique. Notons encore que ces lots sont datés de la période post-romaine d'après l'étude de la céramique (phase 6, voir le rapport de Caroline Durand).

La seconde zone étudiée cette année est la zone 6 de la ville antique, celle du sanctuaire nabatéen (loci 60885, 61015, 61016, 61022, 61026 et 61902). Elle a bénéficié de l'étude de 2585 vestiges fauniques (tableau 1). Ce matériel est composé de nombreux résidus de mammifères récoltés dans des niveaux cendres (**fig. 3, tableau 1**). Notons aussi 52 os de gazelles dans le locus 60885, soit un nombre relativement élevé. Considérant la répartition squelettique ainsi que les traces anthropiques observées sur ces ossements, il semblerait que ce matériel reflète une chasse fructueuse suivit d'un bon repas.

Lors de cette campagne, j'ai également passé quelques jours au Musée d'archéologie et de tradition populaire d'al-'Ulâ afin de commencer le tri du matériel collecté au cours des précédentes campagnes de fouille. J'ai enfin participé à l'étude d'un crâne humain.

Références

Rapports annuels de la mission depuis 2010 :

Rapport 2018 : <https://hal.archives-ouvertes.fr/hal-02096625>

Report 2017 : <https://hal.archives-ouvertes.fr/hal-01804965>

Report 2016: <https://hal.archives-ouvertes.fr/hal-01518460>

Report 2015: <https://halshs.archives-ouvertes.fr/halshs-01311865>

Report 2014: <https://halshs.archives-ouvertes.fr/halshs-01122002>

Report 2011: <http://halshs.archives-ouvertes.fr/halshs-00671451>

Report 2010: <http://halshs.archives-ouvertes.fr/halshs-00542793/fr/>

Conservation and Care of Artefacts

Marie PEILLET

During the 2019 season, the conservation work focused as usual on the metallic artefacts, specially the coins, and on the restoration of artefacts for exhibition.

1. Coins

The 2019 excavations yielded an exceptional amount of coins from each of the three excavated areas. More than 100 coins or parts of coins were treated in the conservation laboratory, among which several silver coins from the Nabatean and Roman periods. For this, usual conservation techniques were used : mechanical and chemical treatments, mostly scalpel and Dremel © under binocular, as well and citric acid baths (fig. 1). The results of the treatment were good enough to identify many types of Nabatean and Roman coins, as well as coins which belong to the so-called “owl type” (fig. 2-6).

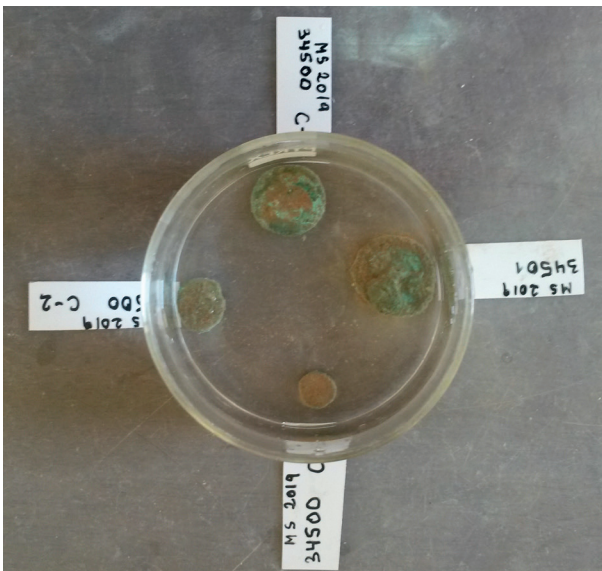

Fig. 1. Coins under chemical treatment.



Fig. 2. Low quality copper alloy coin 34500_C05, bad condition.



Fig. 3. Copper alloy coin 34088_C36 before treatment.



Fig. 4. Copper alloy coin 34088_C36 after treatment. The details of the surface have become legible.



Fig. 5. Silver coin 64301_C01 before treatment.



Fig. 6. Silver coin 64301_C01 after treatment: it shows a bactrian camel on one side.

2. Metallic artefacts

The beginning of the 2019 season was marked by the exceptional find of two copper alloy figurines in Area 34. One of the figurines, representing a kind of satyre, is very well preserved but the other is badly damaged. One can however still identify a human shape (fig. 7-10).

Another remarkable copper alloy object was found on the surface of Area 61: an armour scale which showed, after cleaning, a nice chiselled decorative pattern (fig. 11).

As usual, among the undetermined metallic pieces, some *instrumentum*, rings, plates, etc. were treated in the conservation laboratory with the usual mechanical and chemical techniques. Some broken objects were also put back together with cyanoacrylate glue and acrylic resins (Paraloid® B72 and B44) (fig. 12-14).



Fig. 7. *Figurine 34502_M02 representing a human figure, very damaged. It may be some kind of putto in a dynamic posture. The core of the figurine swelled and the corroded surface exploded.*



Fig. 8. *Figurine 34502_M01 before treatment.*



Fig. 9. *Figurine 34502_M01 under treatment.*

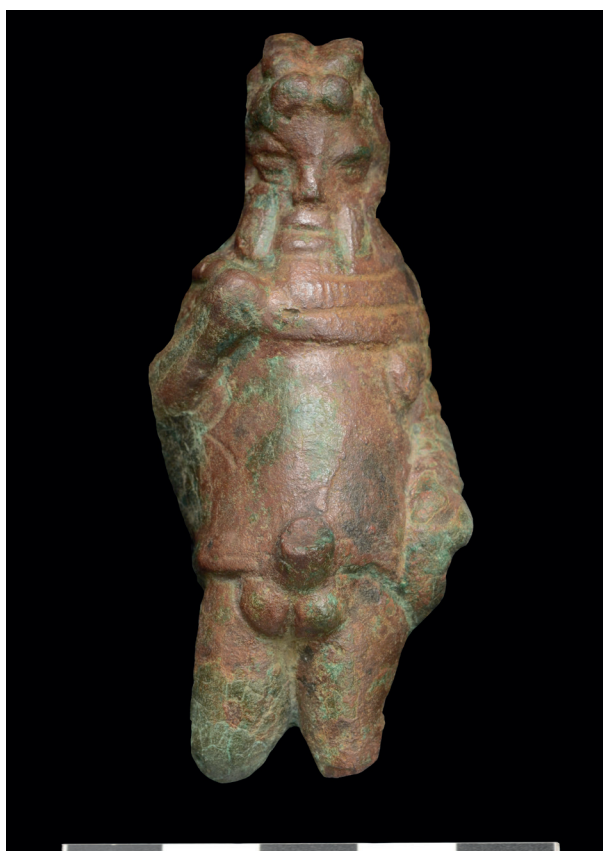

Fig. 10. *Figurine 34502_M01 after treatment. It represents a kind of satyre.*



Fig. 11. Copper alloy decorated armour scale (from a lorica squamata), Surface_M279, after treatment. The chiselled and stamped patterns were made before the perforations.



Fig. 12. Copper alloy instrumentum 34088_M03 after treatment. It may be a hygiene tool for ears or nails.



Fig. 13. Copper alloy engraved signet ring 34531_M01 after treatment. Unfortunately, the engraved pattern is too worn to be legible.



Fig. 14. Copper alloy small pendant 34509_M01, attached to an iron ring, after treatment. It may have been part of a necklace or an earring.

3. Pottery

This year, the work on the pottery was a little less important than during the previous seasons because there were fewer complete shapes. A couple of well preserved, almost unbroken, jars were unearthed and consolidated at the lab.

4. Other works

Bone, stone, glass and shell objects were also treated in the lab, mostly for cleaning. The glass objects usually deserve more attention because this category of artefact suffers damage due to

the composition of the soil of the site. It must therefore be systematically consolidated. After they are dried, the glass fragments are plunged in a 15% concentration solution of acrylic resins (Paraloid© B72 and B44) (**fig. 15**). The 2019 excavations have yielded more glass objects than usual, mostly beads for necklaces of various sizes and shapes. One of them showed after cleaning the very fine representation of a human face in the millefiori technique (**fig. 16-17**).

The work in the conservation lab during the 2019 excavations was also devoted to the preparation of the objects selected for the AlUla exhibition due to open on October 9th, 2019, in the World Arab Institute in Paris (see (<https://www.imarabe.org/fr/expositions/alula-merveille-d-arabie>)). About fifty objects were isolated, cleaned, protected and restored to stand the manipulations,



Fig. 15. Fragment of a glass vessel, 34506_G01, after treatment. The size of this artefact is unusual since the excavations have yielded mostly small sherds, the soil of Madâin Sâlih being corrosive for glass vessels.



Fig. 17. Part of glass bead 34088_G02 before and after treatment. A simple water cleaning revealed a good quality multi-layered glass bead with a 4 mm high human face made in the millefiori technique.



Fig. 16. Part of glass bead 34088_G02 before treatment.



Fig. 18. *Work in progress for the restoration of two big jars from tomb IGN 116.1.*

transportation and change of environment involved by the exhibition. The most important work was performed on two big jars from tomb IGN 116.1 which needed to be filled with plaster since large gaps did not allow us to handle it properly (**fig. 18**).

Finally, it is interesting to note that during the 2019 excavations, a complete reorganization of the drawers in the storerooms of the Al-'Ulâ museum was undertaken in order to save space for the newly found artefacts and to make the research of specific objects easier.