



**HAL**  
open science

## The Zambratija boat in the context of ancient Mediterranean sewn-boat traditions

Giulia Boetto, Patrice Pomey

► **To cite this version:**

Giulia Boetto, Patrice Pomey. The Zambratija boat in the context of ancient Mediterranean sewn-boat traditions. I. Koncani Uhač; G. Boetto; M. Uhač. Zambratija. Prapovijesni šivani brod. Rezultati arheološkog istraživanja, analiza i studija / Prehistoric sewn boat. Results of the Archaeological Research, Analysis and Study, 33, Arheološki muzej Istre, pp.158-178, 2020, Monographs and catalogues, 978-953-8082-50-4. halshs-02986156

**HAL Id: halshs-02986156**

**<https://shs.hal.science/halshs-02986156v1>**

Submitted on 4 Nov 2020

**HAL** is a multi-disciplinary open access archive for the deposit and dissemination of scientific research documents, whether they are published or not. The documents may come from teaching and research institutions in France or abroad, or from public or private research centers.

L'archive ouverte pluridisciplinaire **HAL**, est destinée au dépôt et à la diffusion de documents scientifiques de niveau recherche, publiés ou non, émanant des établissements d'enseignement et de recherche français ou étrangers, des laboratoires publics ou privés.

# Brod Zambratija u kontekstu drevnih tradicija šivanih brodova na Mediteranu

## The Zambratija boat in the context of ancient Mediterranean sewn-boat traditions

*Giulia Boetto, Patrice Pomey*

Postojanje drevnih šivanih brodova na Mediteranu odavno je prepoznato zahvaljujući brojnim dobro dokumentiranim tekstualnim dokazima koji se izravno odnose na tehniku gradnje šivanjem (Casson 1963; 1971; Pomey 1981; 1985). Uz tekstualne izvore postoje i ikonografski podaci koji izgledno potvrđuju korištenje ove tehnike na Mediteranu od prapovijesti, tj. od brončanog doba (Bonino 1985; Basch 1987). S druge strane, u Egiptu je ova tehnika dobro posvjedočena na nekim brodovima još od faraonskog doba, uključujući poznati Keopsov brod (Landström 1970; Lipke 1984; Ward 2000; Pomey 2012b). Iako je ova brodograditeljska tradicija temeljena na poprečnom povezivanju, ona je jedinstvena i pojavljuje se isključivo u starom Egiptu te nema paralela na Mediteranu (Marlier 2005; 2007, 17, Sl. 9; Pomey 1997, 200; 2011a).

Od kraja šezdesetih do sredine osamdesetih godina, pronalaskom brodova građenih tehnikom šivanja kao i

The existence of ancient Mediterranean sewn boats has long been recognized thanks to numerous well-attested examples of textual evidence referring directly to sewn assembly techniques (Casson 1963, 1971; Pomey 1981, 1985). Supporting this literary evidence, iconographical data seems to confirm the use of this technique in the Mediterranean in very ancient times, dating back to the Bronze Age (Bonino 1985; Basch 1987). This technique was also used in the shipbuilding of the Pharaonic era in Egypt (Landström 1970; Lipke 1984; Ward 2000; Pomey 2012b), but the Egyptian tradition, based on transversal lashings or punctual ligatures, is quite specific and has no Mediterranean parallels (Pomey 1997, 200, 2011a; Marlier 2005, 2007, 17, fig. 9).

Since the end of the sixties until the mid eighties, the discovery of ancient wrecks of sewn-plank boats, or the reinterpretation of known remains, revealed the extent of the use of sewing and lashing techniques

njihovom reinterpetacijom, postupno je uočena važnost fenomena korištenja šivanja i vezivanja u mediteranskoj brodogradnji (Pomey 1985)<sup>1</sup>. Ova otkrića navela su istraživače da na prvom kongresu „Sewn Plank Boats“, koji je održan u Greenwichu 1984. godine, ponovno razmotre problematiku šivanih brodova (McGrail, Kentley 1985). Slijedom toga došlo je do reinterpetacije nekih važnih antičkih tekstova, npr. o konstrukciji Odisejeva broda (Homer, *Odiseja*, 5, 244-257), koji je vjerojatno također bio šivan (Mark 1991, 1996, 2005; Tchernia 2001), suprotno interpretaciji L. Cassona (Casson 1964, 1971, 217-219, 1992) koji je predlagao teoriju po kojoj je brod bio izrađen tehnikom utora i jezičaca.

Godine 1993., otkrićem arhajskih grčkih brodova na trgu Jules-Verne (Marseille, Francuska, datiranih na kraj 6. st. pr. Kr.), nazvanih Jules-Verne 7 i 9, potvrđeno je postojanje izvorno mediteranske tehnike gradnje brodova šivanjem, koja je otad potvrđena i na nekoliko drugih lokaliteta, omogućavajući razumijevanje evolucije ove tehnike u kontekstu grčke tradicije šivanih brodova (Pomey 1995, 1997, 2010). U drugoj polovici devedesetih godina, C. Beltrame započeo je dugotrajan projekt katalogizacije novih, ali i starih dotad neobjavljenih podataka o šivanim brodovima na sjeverozapadnom Jadranu, obrađujući razvoj, dugotrajnost i rasprostranjenost tehnike šivanja brodova na ovom području (Beltrame 1996, 2000, 2001, 2002a, 2002b; Beltrame, Gaddi 2013).

U isto je vrijeme I. Negueruela istraživao brodove Mazarrón 1 i 2 (Murcia, Španjolska). Prva razmatranja, koja su ukazala da se radi o feničkim brodovima (Negueruela *et al.* 1995; Negueruela, Ortiz 2004; Negueruela 2000, 2005), pružila su dokaz o još jednoj tehnici gradnje šivanjem, prisutnoj na iberskoj obali (Pomey 2012a; De Juan 2014). Ovi brodovi su tada datirani u drugu polovicu 7. st. pr. Kr., dok se u novije vrijeme datiraju na početak 6. st. pr. Kr. (De Juan 2014, 30).

Upotreba tehnike šivanja i vezivanja pri izgradnji brodova postala je široko prepoznata u mediteranskoj brodogradnji (McGrail 2001, 134-138; Marlier 2005; Pomey 1997, 2010; Polzer 2010, 2011, 364-368).

Sve veći broj pronađenih brodova svjedoči o korištenju tehnika šivanja i vezivanja u različitim povijesnim i kulturološkim kontekstima. Recentno je objavljena sinteza koja ukazuje na postojanje nekoliko različitih mediteranskih tradicija gradnje šivanjem te rasprostranjenost i važnost ove tehnike. Ovaj prilog predstavlja smanjenu verziju tog članka, kako bi se brod Zambratija mogao smjestiti u kontekst mediteranske tradicije šivanih brodova (Pomey, Boetto 2019) (Sl. V.4, V.5).

in Mediterranean shipbuilding (Pomey 1985)<sup>1</sup>. These discoveries encouraged scholars to reconsider this topic at the seminal conference *Sewn Plank Boats* held in Greenwich in 1984 (McGrail, Kentley 1985). Consequently, some important ancient texts were reinterpreted, such as the narrative of the construction of Odysseus' boat (Homer, *Odyssey*, 5, 244-257), which might have been a sewn boat (Mark 1991, 1996, 2005; Tchernia 2001), contrary to the interpretation previously proposed by L. Casson (Casson 1964, 1971, 217-219, 1992) who considered that the boat was built with mortise-and-tenon joints.

In 1993 the discovery of two Archaic Greek wrecks in Place Jules-Verne, Jules-Verne 7 and 9 (Marseilles, France, end of the 6<sup>th</sup> century BCE), has confirmed the existence of a genuine Mediterranean sewn-plank-boat tradition, well attested by several other wrecks, and has allowed us to comprehend its evolution in the context of the Greek tradition of sewing ships (Pomey 1995, 1997, 2010). In the second half of the nineties, C. Beltrame started a long-term project to collate new and known but unpublished data on the sewn wrecks of the Northwestern Adriatic, revealing the early development, the persistence, and the widespread use of the sewing technique in this area (Beltrame 1996, 2000, 2001, 2002a, 2002b; Beltrame, Gaddi 2013).

At the same time, I. Negueruela excavated the Mazarrón 1 and 2 wrecks (Murcia, Spain). First considerations, which indicated that these were Phoenician ships (Negueruela *et al.* 1995; Negueruela, Ortiz 2004; Negueruela 2000, 2005), provided evidence of another sewing tradition on the Iberic coast (Pomey 2012a; De Juan 2014). These wrecks were initially dated to the second half of the 7<sup>th</sup> century BCE, but, recently, a new very early 6<sup>th</sup> century BCE date has been suggested (De Juan 2014, 30).

The widespread use of sewing and lashing technique in Mediterranean shipbuilding is now generally recognized (McGrail 2001, 134-138; Marlier 2005; Pomey 1997, 2010; Polzer 2010, 2011, 364-368).

Finally, an increasing number of wrecks are being discovered that provide evidence of sewing and lashing techniques in a variety of historical and cultural contexts. Recently, we published a synthesis (Pomey, Boetto 2019) showing the existence of various original Mediterranean traditions and the widespread use of this technique. This chapter repropose a reduced version of this article to situate the Zambratija sewn boat within the Mediterranean sewn-boat traditions (Figs V.4, V.5).

<sup>1</sup> Brodolomi su: Cervia (Ravenna, Italija, 7. st., Bonino 1968, 1971) i Pomposa (Ferrara, Italija, vjerojatno 11. st., Bonino 1968, 1971); Zaton 1 i 2 (Nin, Hrvatska, 1. st., Brusić 1968; Brusić, Domjan 1985); Lipe (Slovenija, otkriven 1890, Müllner 1892, ponovno istražen od Salemke 1973); Bon-Porté 1 (Francuska, druga polovica 6. st., otkriven 1976, Joncheray 1976, reinterpetiran od Pomey 1981); Comacchio (Ferrara, Italija, 1. st. pr. Kr., Boccaccini *et al.* 1983; Bonino 1985); Giglio (Giglio Island, toskanski arhipelag, Italija, 580 god. pr. Kr., Bound 1985).

<sup>1</sup> The wrecks are: Cervia (Ravenna, Italy, 7<sup>th</sup> c. CE, Bonino 1968, 1971) and Pomposa (Ferrara, Italy, possibly 11<sup>th</sup> c. CE, Bonino 1968, 1971); Zaton 1 and 2 (Nin, Croatia, 1<sup>st</sup> c. CE, Brusić 1968; Brusić, Domjan 1985); Lipe (Slovenija, discovered in 1890, Müllner 1892, reconsidered by Salemke 1973); Bon-Porté 1 (France, second half of the 6<sup>th</sup> c. BCE, discovered in 1976, Joncheray 1976, and interpreted by Pomey 1981); Comacchio (Ferrara, Italy, 1<sup>st</sup> c. BCE, Boccaccini *et al.* 1983; Bonino 1985), Giglio (Giglio Island, Tuscan archipelago, Italy, 580 BCE, Bound 1985).



## Jadranska tradicija

Brod Zambratija je izuzetno važan arheološki nalaz koji osvjetljava brodograditeljsku tehnologiju na prijelazu iz kasnog brončanog u željezno doba na prostoru sjevernog Jadrana. Zahvaljujući njegovim posebnim arhitektonskim karakteristikama i ranoj dataciji, ovaj šivani brod nema analogija ne samo na Mediteranu, nego i na Jadranu, koji predstavlja geografsko područje na kojem je tehnika šivanja i vezivanja preživjela i u rimskom te post-rimskom razdoblju.

Brod Zambratija je tehnološki derivat izveden iz monoksila, primitivnog oblika plovila, što dokazuje kobilični element oblikovan od brijestovog trupca. Iako još nije sigurno je li brijestov trupac bio prvo proširen, činjenica da su vojevi spojeni sistemom uzdužnog šivanja, kao i

## The Adriatic traditions

The Zambratija boat is an extremely important archaeological find that sheds light on the shipbuilding technology of the Late Bronze Age/Early Iron Age in the northern Adriatic Sea. Due to its specific architectural features and its early date, this sewn boat is without parallels, not only in the Mediterranean but also in the Adriatic, which is one of the geographic areas where sewing and lashing techniques survived in the Roman and post Roman periods.

The Zambratija boat is a technological derivation of a logboat, a primitive vessel type, as evidenced by the keel-like timber that is shaped from an elm trunk. Although it is not yet certain if the elm trunk was first expanded, the strakes assembled with a system of



#### V.4

##### Brodolomi na Mediteranu koji se spominju u tekstu.

**Šivani brodovi:** 1-27, šivani brodovi sa sjevernog Jadrana; 28, Lipe; 29, Vrhnika 2; 30, Mazarrón 1; 31, Mazarrón 2; 32, Golo; 33, Binisafüller; 34, Bon Porté; 35, Giglio; 36, Jules-Verne 9; 37, Pabuç Burnu; 38, Cala Sant Vicenç; 39, Jules-Verne 7; 40, Villeneuve-Bargemon 1/César 1; 41, Grand-Ribaud F; 42, Gela 1; 43, Gela 2; 44, Ma'agan Mikhael; 45, Kyrenia; 46, Ereğli E; 47, Cap Béar; 48, La Tour Fondue; 49, Cavalière; 50, La Roche-Fouras; 51, Mèdes 6; 52, Dramont C; 53, Palamos; 54, Plane 1; 55, Barthélémy B; 56, Jeaume-Garde B; 57, Perduto 1; 58, Cap del Vol; 59, Saintes-Maries 2; 60, Saintes-Maries 24; 61, Baie de l'Amitié; 62, Cala Cativa 1; 63, Port-Vendres 3; 64, Port La Nautique.

**Ostali brodolomi:** A, Pisa C; B, Vrhnika 1; C, Sinja Gorica; D, Kamensko; E, Sisak; F, Kušjak; G, Uluburun; H, Cape Gelidonya.

##### The ancient Mediterranean shipwrecks cited in the text.

**The ancient sewn boats:** 1-27, sewn boats from the Northern Adriatic zone; 28, Lipe; 29, Vrhnika 2; 30, Mazarrón 1; 31, Mazarrón 2; 32, Golo; 33, Binisafüller; 34, Bon Porté; 35, Giglio; 36, Jules-Verne 9; 37, Pabuç Burnu; 38, Cala Sant Vicenç; 39, Jules-Verne 7; 40, Villeneuve-Bargemon 1/César 1; 41, Grand-Ribaud F; 42, Gela 1; 43, Gela 2; 44, Ma'agan Mikhael; 45, Kyrenia; 46, Ereğli E; 47, Cap Béar; 48, La Tour Fondue; 49, Cavalière; 50, La Roche-Fouras; 51, Mèdes 6; 52, Dramont C; 53, Palamos; 54, Plane 1; 55, Barthélémy B; 56, Jeaume-Garde B; 57, Perduto 1; 58, Cap del Vol; 59, Saintes-Maries 2; 60, Saintes-Maries 24; 61, Baie de l'Amitié; 62, Cala Cativa 1; 63, Port-Vendres 3; 64, Port La Nautique.

**The other shipwrecks:** A, Pisa C; B, Vrhnika 1; C, Sinja Gorica; D, Kamensko; E, Sisak; F, Kušjak; G, Uluburun; H, Cape Gelidonya. (crtež / drawing by V. Dumas, G. Boetto, P. Pomey)

#### V.5

**Šivani brodovi** s područja sjevernog Jadrana (u plavoj i crvenoj boji) te s područja dunavskog sliva (u zelenoj boji). U plavoj boji, sjeveroistočna jadranska tradicija ili Histro-liburnska tradicija: 1, Zambratija; 2, Pula 1; 3, Pula 2; 4, Zaton 1; 5, Zaton 2; 6, Zaton 3; 7, Caska 1; 8, Caska 3; 9, Caska 4. U crvenoj boji, sjeverno jadranska i sjeverozapadna jadranska tradicija: 10, Barena del Vigno; 11, Cavanella d'Adige; 12, Comacchio; 13, Stella 1; 14, Lido di Venezia 1; 15, Lido di Venezia 2; 16, Lido di Venezia 3; 17, S. Francesco del Deserto; 18, Marcon; 19, Meolo 1; 20, Corte Cavanella 1; 21, Corte Cavanella 2; 22, Padua; 23, Aquileia 1; 24, Aquileia 2; 25, Santa Maria in Padovetere; 26, Cervia; 27, Pomposa. U zelenoj boji, kontinentalna tradicija dunavskog sliva: 28, Lipe; 29, Vrhnika 2

**Ancient Sewn Boats** from the Northern Adriatic zone (blue and red) and from the Danube river basin (green). In blue, the north-eastern Adriatic tradition or Istro-Liburnian tradition: 1, Zambratija; 2, Pula 1; 3, Pula 2; 4, Zaton 1; 5, Zaton 2; 6, Zaton 3; 7, Caska 1; 8, Caska 3; 9, Caska 4. In red, the northern and north-western Adriatic tradition: 10, Barena del Vigno; 11, Cavanella d'Adige; 12, Comacchio; 13, Stella 1; 14, Lido di Venezia 1; 15, Lido di Venezia 2; 16, Lido di Venezia 3; 17, S. Francesco del Deserto; 18, Marcon; 19, Meolo 1; 20, Corte Cavanella 1; 21, Corte Cavanella 2; 22, Padua; 23, Aquileia 1; 24, Aquileia 2; 25, Santa Maria in Padovetere; 26, Cervia; 27, Pomposa. In green, the continental tradition of the Danube River basin: 28, Lipe; 29, Vrhnika 2.

(crtež / drawing by V. Dumas, G. Boetto, P. Pomey).

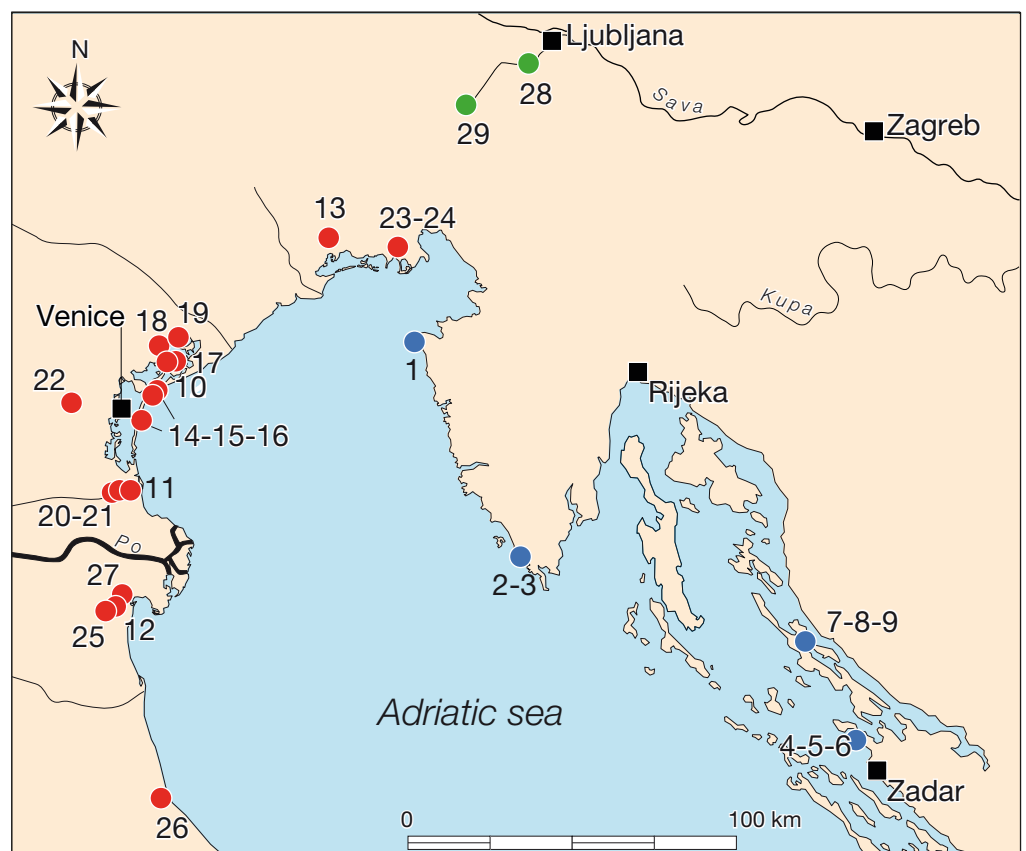

vodonepropusni sustav te oblikovane rebrenice vezane za oplatu pružaju detaljan uvid u dobro razvijenu tehnologiju obrade drva koja je u to vrijeme bila u upotrebi.

Štoviše, brod Zambratija predstavlja jedini dokaz o postojanju šivanih plovila u Istri u tom ranom periodu i može se koristiti kao odrednica za brodograditeljsku tradiciju koju bismo uvjetno mogli nazvati proto-histarskom. Također, treba istaknuti da latinski izvori potvrđuju dugovječnost i snagu histarske i liburnske tradicije šivanih brodova<sup>2</sup> te da je arheologija pružila dokaze o opstanaku tehnike šivanja brodova na sjevernom Jadranu kroz rimsko vrijeme i vjerojatno sve do ranog srednjeg vijeka.

Tehnika šivanja potvrđena je i u kontinentalnom dijelu (rijeka Ljubljanica, Slovenija), a s obzirom da nije u izravnoj vezi s Jadranskim morem, predstavlja dokaz o značajnom prenošenju brodograditeljskih tehnika.

Zbog navedenih razlika u uzorku šivanja i vrsti plovila, G. Boetto (Boetto, Rousse 2011, 2012) predložila je nazive za dvije izrazite tradicije šivanih brodova na Jadranu. Prva tradicija, koja je definirana kao „rimsko-ilirska“<sup>3</sup>, obuhvaća grupu brodova iz Istre i Dalmacije, dok drugoj tradiciji, definiranoj kao „rimsko-padanskoj“, pripadaju brodovi otkriveni u Raveni, na području delte rijeke Po pa do zaljeva kod Akvileje, tj. na području obalnih, lagunarnih i unutarnjih voda današnjih regija Emilia-Romagna, Veneto i Friuli Venezia Giulia.

Ipak, zbog problema koji su se pojavili u upotrebi termina „rimsko-ilirski“ i „rimsko-padanski“, šira geografska odrednica se čini prikladnijom, budući da je u ovoj fazi istraživanja određenu tradiciju šivanja teško pripisati pojedinoj geografskoj, sociokulturnoj i etničkoj skupini (Sl. V.4, V.5).

### Sjeveroistočna jadranska tradicija

Ova tradicija datira u rimsko razdoblje, a Z. Brusić nazvao ju je liburnskom na osnovi otkrića dvaju šivanih brodova u uvali Zaton, nekadašnjoj luci antičke Aenone, današnjeg Nina (1. st., Brusić 1986, 1995; Brusić, Domjan 1985). Posljednjih godina još je šest šivanih brodova pronađeno na području sjeverne Dalmacije, u Zatonu<sup>4</sup> i u Caski na otoku Pagu<sup>5</sup> te u Istri u Puli (Sl. V.4-V.8)<sup>6</sup>.

2 Posebno u tekstovima, kod Varona (kojeg citira *Aulus Gellius*, XVII, 3, 4) i Verija Flaka (u Festu, 508, 33), koji se izravno odnose na termin *serilia naves* naroda Histra i Liburna.

3 Ovaj naziv nije fokusiran na etničko značenje Ilira već ima naglasak na zemljopisne granice Ilirika kako ga je definirao Strabon (*Geografija*, VII, 5). Time je obuhvaćen teritorij od rijeke Dunav do granice provincije Makedonije s cijelom istočnom obalom Jadranskog mora, od sjeveroistočnog dijela Istre i Dalmacije do južne Albanije.

4 Zaton 3 brod, 1. st., Gluščević 2004.

5 Caska 1, 3 i 4 brodovi, 1. st., Čelhar 2008; Radić Rossi, Boetto 2010, 2011, 2013; Boetto 2016; Boetto, Rousse 2011, 2012; Boetto, Radić Rossi 2014, 2017; Ruff 2017.

6 Pula 1 i 2 brodovi, kraj 2. st. - početak 3. st., Uhač, 2014, 351-353; Boetto *et al.* 2014, 2017.

longitudinal sewing, the waterproofing method, and the shaped floor-timbers lashed to the planking give us a detailed picture of a well-developed woodworking technology already in use for boatbuilding at that time. Nevertheless, the Zambratija boat stands alone as proof of the existence of sewn-plank vessels in Istria at this early period. The boat can be used to define a native shipbuilding tradition that we could tentatively term Proto-Histrian. It is also interesting to note that Latin texts attest the longevity and the strength of the Istrian and Liburnian traditions of sewn boats<sup>2</sup> and that archaeology has provided proof of the survival of the sewing technique in the northern Adriatic in Roman times and possibly up to the Early Middle Ages.

The sewn-plank technique is also found in a continental area (Ljubljanica River, Slovenia) that is not in direct contact with the Adriatic Sea, which is evidence of significant transfers of shipbuilding techniques.

Due to evident differences in the sewing patterns and types of vessels, G. Boetto (Boetto, Rousse 2011, 2012) has tentatively proposed the definition of two distinct sewn-boat traditions in the Adriatic Sea. The first, defined as “Romano-Illyrian”<sup>3</sup>, includes the wrecks discovered in Istria and Dalmatia; the second, defined as “Roman-Paduan”, includes the wrecks discovered from Ravenna, through the Po River delta, to the gulf of Aquilea in the coastal, lagoon and inland waters of the present Emilia-Romagna, Veneto, and Friuli Venezia Giulia regions of Italy. Nevertheless, due to issues raised by the use of the terms “Romano-Illyrians” and “Romano-Paduan”, a more general geographical definition seems appropriate as, at this stage of research, it is difficult to ascribe each sewn-boat tradition to a specific geographic, socio-cultural, and ethnic group (Figs V.4, V.5).

### The north-eastern Adriatic tradition

This tradition is dated to the Roman period and has been defined as Liburnian by Z. Brusić following the discovery of two sewn-boats in Zaton, the harbour of *Aenona*, today known as Nin (1<sup>st</sup> century CE, Brusić 1986, 1995; Brusić, Domjan 1985). In recent years, six other sewn-boat wrecks have been discovered in Northern Dalmatia, at Zaton<sup>4</sup> and Caska on the island of Pag<sup>5</sup>, and in Istria in Pula (Figs V.4 - V.8)<sup>6</sup>.

2 In particular, Varro (quoted by *Aulus Gellius*, XVII, 3, 4) and Verrius Flaccus (in Festus, 508, 33) explicitly refer to the sewn-boats, *serilia*, of the Istrians and Liburnians.

3 This appellation was not focusing on the ethnic notion of Illyrians, but on the geographic dimension of Illyria as defined by Strabo (*Geography*, VII, 5). That means a territory going from the Danube to the border of the province of Macedonia and comprehensive of the whole eastern coast of the Adriatic, from the north-eastern part of Istria, Dalmatia to southern Albania.

4 Zaton 3 wreck, 1<sup>st</sup> c. CE: Gluščević 2004.

5 Caska 1, 3 and 4 wrecks, 1<sup>st</sup> c. CE: Čelhar 2008; Radić Rossi, Boetto 2010, 2011, 2013; Boetto 2016; Boetto, Rousse 2011, 2012; Boetto, Radić Rossi 2014, 2017; Ruff 2017.

6 Pula 1 and 2 wrecks, end of the 2<sup>nd</sup>-beginning of the 3<sup>rd</sup> c. CE: Uhač 2014, 351-333; Boetto *et al.* 2014, 2017.



**V.6**  
**Brodovi Pula 1 i Pula 2.** Pogled na nalazište s brodskim konstrukcijama tijekom istraživanja 2013.  
**Pula 1 and Pula 2 wrecks.** View of the remains during the 2013 excavation  
 (fotografija / photo by: T. Brajković)

**V.7**  
**Brodovi Pula 1 i Pula 2**  
**Pula wrecks Pula 1 i Pula 2**  
 (crtež / drawing by: V. Dumas)

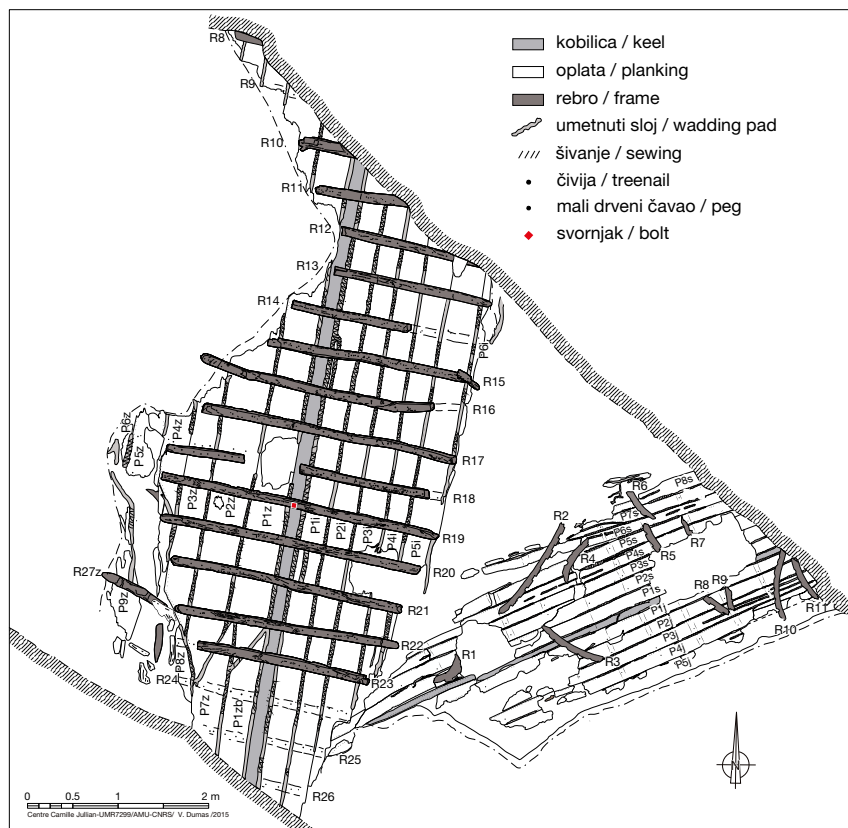

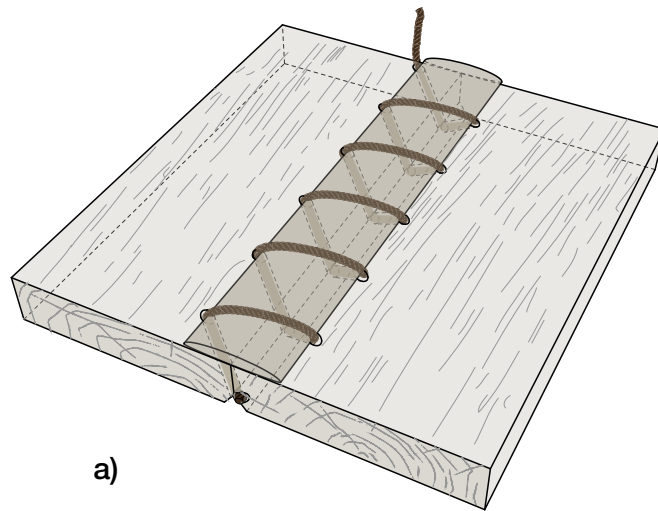

a)

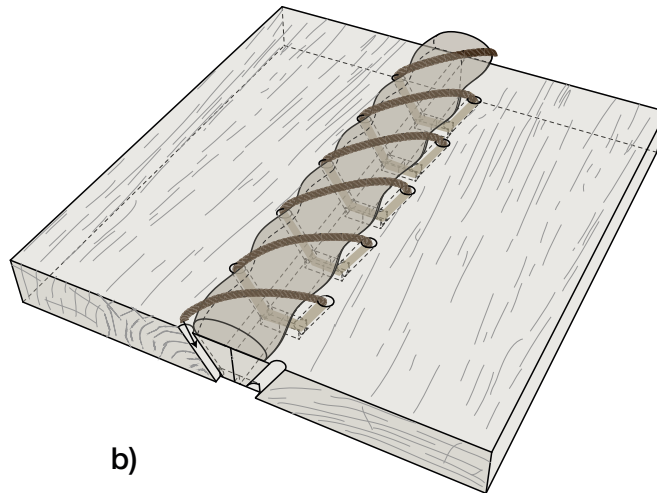
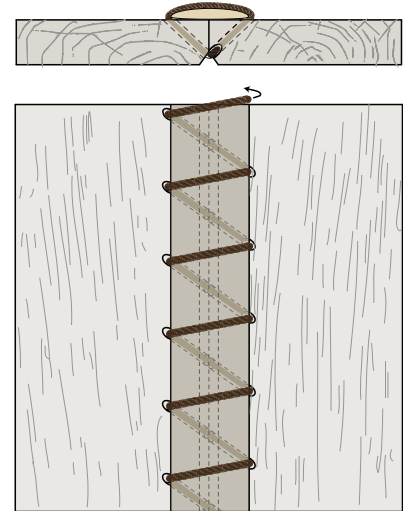

b)

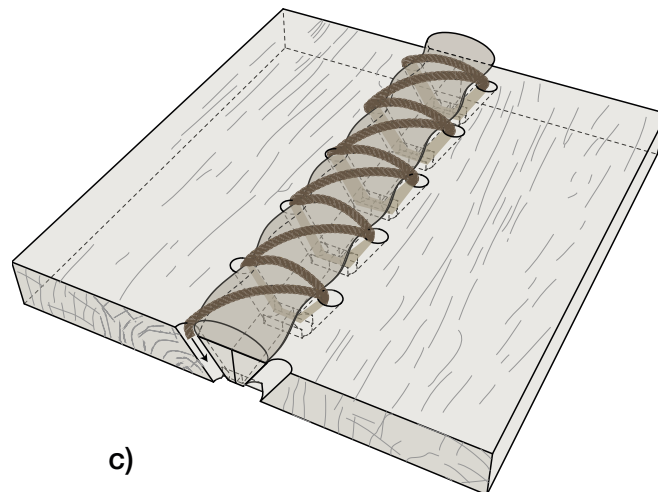
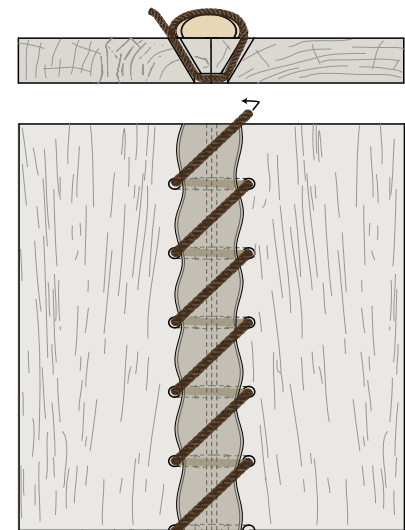

c)

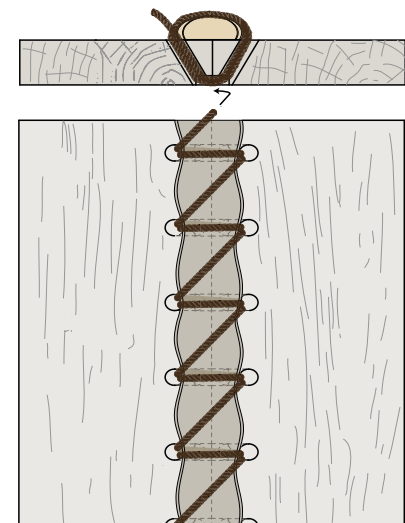

V.8  
Aksonometrijski prikaz šivanja: a) Zambratija; b) Pula 2; c) Pula 1  
Axonometric illustrations of the sewing systems: a) the Zambratija wreck; b) Pula 2; and c) Pula 1  
(crtež / drawing by: P. Poveda)



**V.9**

**Pula 2**, detalj šivanja na vanjskoj strani trupa

**Pula 2**, detail view of the sewing system on the outer face of the hull (fotografija / photo by: T. Brajković)



V.9

**V.10**

**Pula 2**, detalj spajanja šivanjem

**Pula 2**, detail view of the sewing system (fotografija / photo by: T. Brajković)



V.10

**V.11**

**Pula 1**, detalj spajanja šivanjem

**Pula 1**, detail view of the sewing system (fotografija / photo by: T. Brajković)



V.11

**V.12**

**Pula 1**, detalj spajanja šivanjem

**Pula 1**, detail view of the sewing system (fotografija / photo by: T. Brajković)



V.12

Svi ovi brodovi imaju kobilicu, a oplata im je sastavljena od stično položenih vojeva. Metoda i proces izgradnje trupa temelje se na načelu „prvo ljuska“ te na uzdužnom, vojevno orijentiranom konceptu za forme broda. Svi su ovi brodovi strukturalno i tehnički vrlo slični, ali ipak pokazuju značajne razlike u dimenzijama i obliku, u sustavu propulzije te u vrsti drva, dok se sve te razlike mogu pripisati različitim tipovima brodova. Međutim, većina plovila koja pripadaju ovoj skupini su manja (9-10 metara dužine), vjerojatno s kombiniranim pogonom, a karakterizira ih vrlo jednostavan sustav šivanja oplata, koji se sastoji od rubnih šavova (uzorak ///) koji prolaze kroz rupe izbušene okomito na rubove platica (Sl. V.9, V.10). Mali drveni čavli zaptivaju rupe i šavove, a umetnuti sloj vlakana osigurava da su sljubnice vodonepropusne. Brod Pula 1, koji tipologijom pripada većem brodu na jedra, dužine barem 15-17 m, ima složeniji uzorak šivanja, s rubnim šavovima i preklopnim okretom (uzorak ////) (Sl. V.11, V.12). Rebra pravokutnog presjeka većinom su za oplatu učvršćena čivijama, a njihova je baza istesana iznad sljubnica tj. šavova (Sl. V.13). S druge strane, brod Caska 4 ima rebrenice koje su povezane s rebrenim nastavkom, a rebra su vezana za oplatu bez upotrebe čivija.

All these boats are keeled, and the planking is flush-laid. The construction principle used is based on a shell concept for the hull structure, and a longitudinal strake-oriented concept for their shape. The building process is shell first. They are structurally and technically very similar but they also have significant differences in terms of their dimensions and shape, propulsion systems, and the selection of wood used; differences that might be ascribed to diverse ship types. Nevertheless, the majority of the vessels belonging to this group are small (9-10 m in length), probably with mixed propulsion, and are characterized by a very simple sewing pattern for the planking seams made of over-edge stitches (//) through oblique stitch holes perpendicular to the edges of the planks (Figs V.9, V.10). Pegs lock the ligatures in place and a wadding pad assures the seam is watertight. Only Pula 1, which is a bigger sailing vessel, at least 15-17 m long, presents a more elaborate sewing pattern made of over-edge stitches with a clamping turn (///) (Figs V.11, V.12). The frames, rectangular in section, are predominantly treenailed to the planking, and their base is crenellated to pass over the stitching (Fig. V.13). Otherwise, Caska 4 has floor-timbers connected to in-line futtocks, and the frames are lashed to the planking without the use of treenails.



V.13  
**Pula 1**, pogled na rebra obrađena iznad šivanja  
**Pula 1**, view of the frame crenellated to pass over the sewing  
 (fotografija / photo by: T. Brajković)

### Sjeverozapadna i sjeverna jadranska tradicija

Na sjevernoj i sjeverozapadnoj obali Jadrana zastupljena je jaka tradicija šivanih brodova, i to od Ravene i delte rijeke Po do zaljeva Akvileje, tj. na području obalnih, lagunarnih i unutrašnjih voda današnjih regija Emilia-Romagna, Veneto i Friuli Venezia Giulia u Italiji (Sl. V.4, V.5). Najstariji dokazi o toj tradiciji potječu iz 6. st. pr. Kr.<sup>7</sup>, i iz republikanskog razdoblja (2. – 1. st. pr. Kr.)<sup>8</sup>, dok su mlađi primjerci brodovi Cervia (Ravenna, 7. st.)<sup>9</sup> i Pomposa (Ferrara, 7. ili 11. st.)<sup>10</sup>.

Veći broj brodskih dijelova, datiranih između 1. i 3. stoljeća, otkriven je nakon što je bio izbačen na plažu ili nakon što je sekundarno upotrijebljen u nasipima

### The north-western and northern Adriatic tradition

In the northern and north-western part of the Adriatic, there is another strong sewn-boat tradition in use from Ravenna, through the Po River delta, to the gulf of Aquilea in the coastal, lagoon and inland waters of the present Emilia-Romagna, Veneto, and Friuli Venezia Giulia regions of Italy (Figs V.4, V.5). The earliest remains date to the 6<sup>th</sup> century BCE,<sup>7</sup> and then to the Republican period (2<sup>nd</sup> - 1<sup>st</sup> century BCE),<sup>8</sup> while the most recent examples are the Cervia (Ravenna, 7<sup>th</sup> century CE)<sup>9</sup> and Pomposa wrecks (Ferrara, 7<sup>th</sup> or 11<sup>th</sup> century CE)<sup>10</sup>.

A large number of boat timbers, dated between the 1<sup>st</sup> and the 3<sup>rd</sup> centuries CE, have been discovered washed up on the beach or reused in embankments in the Venice

7 Ulomak platice broda Barena del Vigno iz venecijanske lagune, Beltrame 2002a, 365.

8 Brod Cavanella d'Adige, Tiboni 2009, 2017.

9 Beltrame 2002a, 559, Sl. 10-11, 2009, 415.

10 Bonino 1968. O kasnosrednjovjekovnom datumu broda Pomposa raspravljao je C. Beltrame (2009, 415, Sl. 11) jer na brodolomu nisu pronađeni databilni nalazi, a obalna linija iz 11. stoljeća bila je postavljena daleko od mjesta nalazišta. Moguće je da su, zbog sličnih karakteristika između brodova Cervia i Pomposa, oba datirana u 7. stoljeće.

7 Plank fragment of Barena del Vigno, Venice lagoon: Beltrame 2002a, 365.

8 Cavanella d'Adige wreck: Tiboni 2009, 2017.

9 Beltrame 2002a, 559, fig. 10-11, 2009, 415.

10 Bonino 1968. The Early Medieval date for the Pomposa ship has been discussed by C. Beltrame (2009, 415, fig. 11) because no datable finds were associated to the wreck and the 11<sup>th</sup> century coastline has been situated far away from the site. It is possible that, due to the similar characteristics between the Cervia and Pomposa wrecks, they were both dated to the 7<sup>th</sup> century.



V.14

## V.14

**Brod Comacchio.** Opći prikaz trupa nakon demontaže rebara (po Berti 1990, 25)

**Comacchio shipwreck.** General view of the hull after dismantling the frame for recovery (from Berti 1990, 25)



V.15

## V.15

**Brod Comacchio.** Detalj šivanja (po Berti 1990, 30, fig. 4)

**Comacchio shipwreck.** Detail view of the sewing system (from Berti 1990: 30, fig. 4)

venecijanske lagune i okolice<sup>11</sup>, u gradu Padovi<sup>12</sup> te u kanalu Anfora u Akvileji<sup>13</sup>.

Naposljetku, samo tri olupine su dobro očuvane i dopuštaju razumijevanje njihove arhitekture i funkcionalnosti. Brod Comacchio, koji datira na početak augustovskog razdoblja (kraj 1. st. pr. Kr.)<sup>14</sup>, ima kobiličnu platicu i odgovara 20-metarskom riječno-morskom plovilu (Sl. V.14, V.15). Brodovi Stella (rijeka Stella, početak 1. st.; Sl. V.16)<sup>15</sup>, Corte Cavanella 2 (Rovigo, kraj 1. st. ili početak 2. st.; Sl. V.17)<sup>16</sup> i Santa Maria in Padovetere (Ferrara, 5. st.)<sup>17</sup> su brodovi s ravnim dnom bez obrađenih uzvojnih

lagoon and its surroundings<sup>11</sup>, in the city of Padua,<sup>12</sup> and in the Canale Anfora in Aquileia<sup>13</sup>.

Finally, only three wrecks are sufficiently well preserved to permit a reasonable understanding of their architectural and functional types. The wreck of Comacchio, dated to the beginning of the Augustan era (end of the 1<sup>st</sup> century BCE)<sup>14</sup> has a plank-keel and corresponds to a 20 m-long fluvio-maritime vessel (Figs V.14, V.15). The Stella wreck (Stella River, beginning of the 1<sup>st</sup> century CE; Fig. V.16)<sup>15</sup>, the Corte Cavanella 2 wreck (Rovigo, end of the 1<sup>st</sup> or the beginning of the 2<sup>nd</sup> century CE; Fig. V.17)<sup>16</sup>, and the Santa Maria in Padovetere wreck (Ferrara, 5<sup>th</sup> century CE)<sup>17</sup> are flat-bottom based

11 Brodovi Lido di Venezia 1, 2 i 3: 1. – 2. st., Beltrame 1996, 2000, 2001, 2002a, 2002b; Beltrame, Gaddi 2013, 302; Willis, Capulli, 2014, 2017, 2018; brod S. Francesco del Deserto: Capulli, Pellegrini 2010; Marcon brod: Beltrame, Gaddi 2013, 302; brod Meolo 1: Beltrame 2002a, 370-371.

12 2. st., Beltrame 2002, 366.

13 Brodovi Aquileia 1 iz 1. st. pr. Kr. i Aquileia 2 s kraja 2. st. na početak 3. st.: Beltrame 2002a, 358-359; Beltrame, Gaddi 2013.

14 Berti 1986; 1990.

15 Vitri *et al.* 2003; Castro, Capulli 2016.

16 Sličan takav brod je pronađen unutar rimskog naselja u Corte Cavanella u Loreo, ali nije izvađen; Beltrame 2000, 2002a.

17 Beltrame, Costa 2016.

11 Lido di Venezia 1, 2 and 3 wrecks: 1<sup>st</sup>-2<sup>nd</sup> c. CE, Beltrame 1996, 2000, 2001, 2002a, 2002b; Beltrame, Gaddi 2013, 302; Willis, Capulli, 2014, 2017, 2018; S. Francesco del Deserto wreck: Capulli, Pellegrini 2010; Marcon wreck: Beltrame, Gaddi 2013, 302; Meolo 1 wreck: Beltrame 2002a, 370-371.

12 2<sup>nd</sup> c. CE, Beltrame 2002, 366.

13 Aquileia 1, 1<sup>st</sup> c. CE, and Aquileia 2, end of the 2<sup>nd</sup> and the beginning of the 3<sup>rd</sup> c. CE: Beltrame 2002a, 358-359; Beltrame, Gaddi 2013.

14 Berti 1986, 1990.

15 Vitri *et al.* 2003; Castro, Capulli 2016.

16 Another very similar wreck was also found in the Roman settlement at Corte Cavanella di Loreo but not recovered: Beltrame 2000, 2002a.

17 Beltrame, Costa 2016.

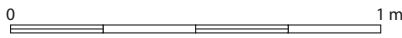
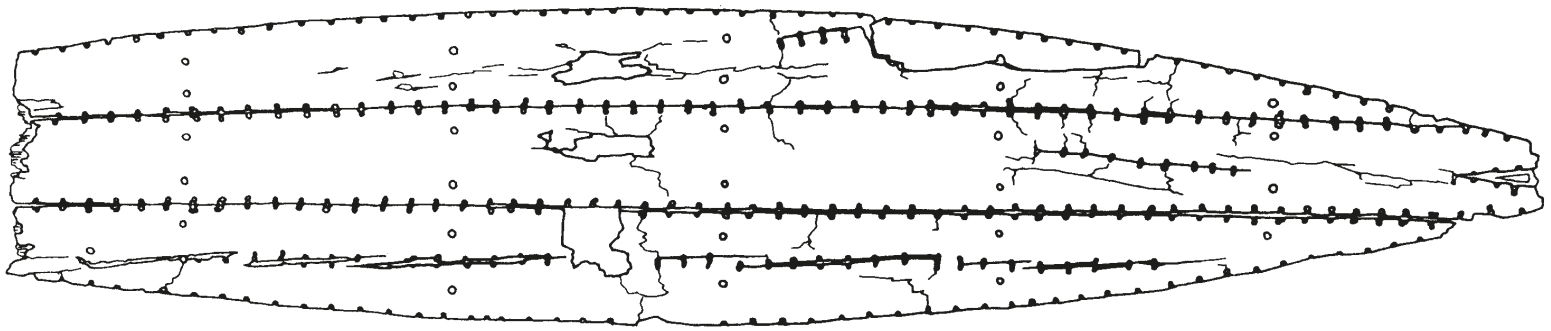

**V.16**  
**Brod Corte Cavarella 2.** Plan vanjske oplata broda (crtež: G. Boetto, prema Beltrame 2002a, fig. 13)  
**Corte Cavarella 2** shipwreck. Plan of the outer face of the planking (drawing by: G. Boetto, after Beltrame 2002a, fig. 13)

**V.17**  
**Brod Stella 1** (crtež: K. Yamafune, iz Castro, Capulli 2016, 35, fig. 7)  
**Stella 1** shipwreck (drawing by: K. Yamafune, from Castro, Capulli 2016, 35, fig. 7)

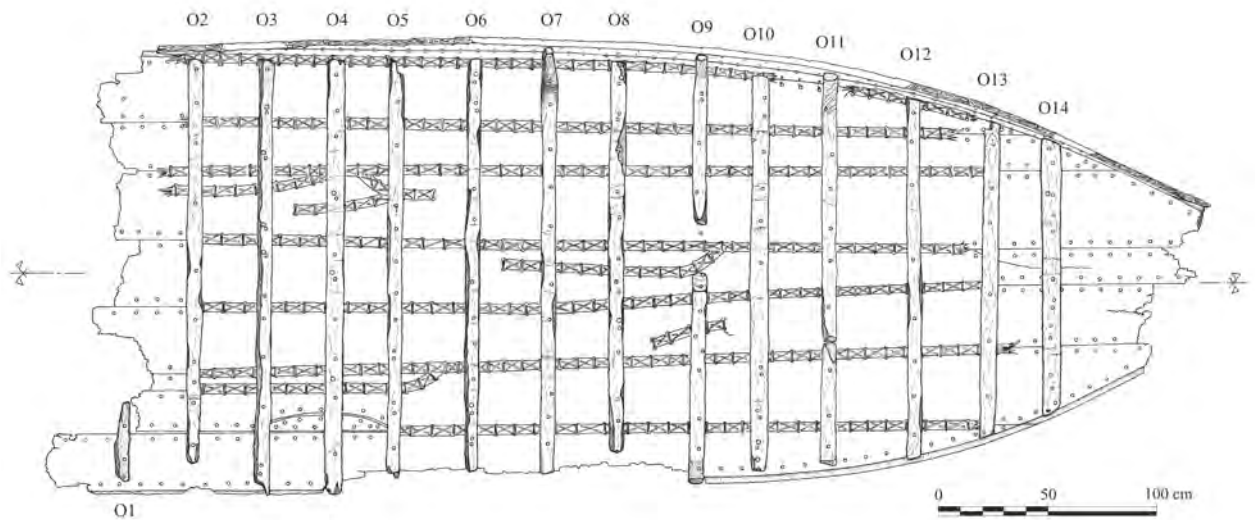

platica<sup>18</sup>.

Nalazi ovih 18 brodova te ostaci šivanih dijelova brodova svjedoče o tradiciji brodogradnje šivanjem koju karakterizira uzorak križnog šivanja (tipa IXIXIX) oplata te prevladavanje trapezoidnih utora na kraju rupe pojednog šava.

Brod Comacchio poseban je po tome što je oplata sašivena do prve bokoštitnice, dok mu je gornji dio oplata izgrađen spojem utor i ježičac. Na brodu Aquileia 1 se čini da je uzorak šivanja bio rubni s preklapnim okretom (/I/I/I). Konačno, sva ova plovila su dobro prilagođena plovidbi u unutarnjim vodama ili riječno-morskoj i priobalnoj plovidbi.

vessels without carved bilge strakes<sup>18</sup>.

All of these eighteen wrecks and remains of sewn boats prove the extent of this shipbuilding tradition, which is characterized by a pattern of crossing stitches (IXIXIX type) for the plank seams and by the predominant presence of trapezoidal recesses at the end of each stitch hole.

The Comacchio ship has the particularity of a sewn bottom up to the first wale with the upper part of the planking fastened with mortise-and-tenon joints. In Aquileia 1, it seems that the sewing pattern used was the over-edge type with a clamping turn (/I/I/I). Finally, all of these crafts are well adapted to inland waters, or fluvio-maritime and coastal sailing.

18 Suprotno brodovima s kobilničnom platicom koji su građeni na principu uzdužno orijentiranih vojeva po načelu „prvo ljuska“, brodovi s ravnim dnom su izgrađeni sukladno principu ravnog dna i procesu izgradnje u kojem su forma i struktura napravljene i organizirane oko prvo izgrađenog ravnog dna, koje može i ne mora imati izdubljeni uzvojni voj. Na ovim brodovima oplata je položena stično, osim na kasnoantičkom brodu Santa Maria in Padovetere, gdje su zadnji vojevi bokova građeni preklapno. Za različite koncepte, načela, metode konstrukcije i arhitektonske tipove vidi Pomey 2004a; Pomey, Rieth 2005, 29-33; Pomey *et al.* 2012, 2013.

18 On the contrary of the boats with a plank-keel, which are longitudinal strake-oriented and shell-first, the flat-bottomed boats are built according to a flat-bottom principle and process of construction in which the shape and the structure are given and organized around the flat-bottom laid down first with or without carved bilge plank (or carved transition strake). On these boats the planking is flush-laid with just one exception on the Late Roman Santa Maria in Padovetere wreck where the last strakes of the side are clinker built. About the different concepts of principle and method of construction and architectural types, see Pomey 2004a; Pomey, Rieth 2005, 29-33; Pomey *et al.* 2012, 2013.

## Kontinentalna tradicija dunavskog porječja

Teglenica Lipe, pronađena 1890. godine blizu današnjeg toka rijeke Ljubljanice u Sloveniji (Müllner 1892), pruža dokaze o još jednoj tradiciji šivanih brodova (Sl. V.5, V.18). Brod je nedavno reinterpetiran (Gaspari 2009) te je datiran u razdoblje između sredine 2. i sredine 1. st. pr. Kr. (Gaspari 2017, 141). Smješta se u okvir rimsko-keltske brodograditeljske tradicije koja pripada tradiciji s područja unutrašnjih voda jugoistočne Europe (Boetto, Rousse 2011, 2012). Brod Lipe pripada tipu velikih teretnih brodova ravnog dna, dug je 30 metara, a širok 4,8 metra. Nema kobilicu, ali ima izdubljenu uzvojnju platicu. Oplata je spojena šivanjem jednostavnim šavovima od biljnih vlakana koji prolaze kroz vertikalne rupe i čini se da tvore cik-cak uzorak (/1/1/).

Zbog sustava spajanja ravnog dna šivanjem, ovaj se brod prvotno nastojalo povezati s jadranskom tradicijom šivanih brodova budući da se u načinu šivanja oplata očituje jak utjecaj pomorskih tradicija brodogradnje jadranske regije (Gaspari 1998a, 1998b, 2009). Ovaj se utjecaj veže uz geografska obilježja tog prostora Slovenije, a koja je povijesno povezana s Tršćanskim zaljevom i Istrom te preko prijelaza u Julijske Alpe (Boetto, Rousse 2011, 2012; Gaspari 2017). Nadalje, područje plovidbe teglenice Lipe rijekom Ljubljanicom otvoreno je

## The continental tradition of the Danube River basin

The Lipe barge, found in 1890 near the present-day Ljubljanica riverbed in Slovenia (Müllner 1892), offers evidence of another sewn-boat tradition (Figs V.5, V.18). The boat has been recently reinterpreted (Gaspari 2009), and dated between the mid 2<sup>nd</sup> and the mid 1<sup>st</sup> centuries BCE (Gaspari 2017, 141). It is now placed within the frame of the Romano-Celtic tradition of shipbuilding, belonging to a regional inland-waters tradition of South-Eastern Europe (Boetto, Rousse 2011, 2012). The Lipe wreck corresponds to a large flat-bottom river barge, 30 m long and 4.80 m wide, without a keel but with a carved bilge plank. The planking is sewn with simple vegetal stitches going through vertical holes and appears to be in a zigzag pattern (/1/1/).

As the flat bottom was sewn, the boat was first linked to the Adriatic sewn ship traditions: the sewn assemblage of the planking was interpreted as revealing the strong influence of maritime shipbuilding traditions of the Adriatic Sea (Gaspari 1998a, 1998b, 2009, 2017). This influence is linked to the particular geography of this part of Slovenia, which historically opened towards the Gulf of Trieste and Istria through the accessible passes of the Julian Alps (Boetto, Rousse 2011, 2012; Gaspari 2017). Moreover, the area in which the Lipe barge navigated on

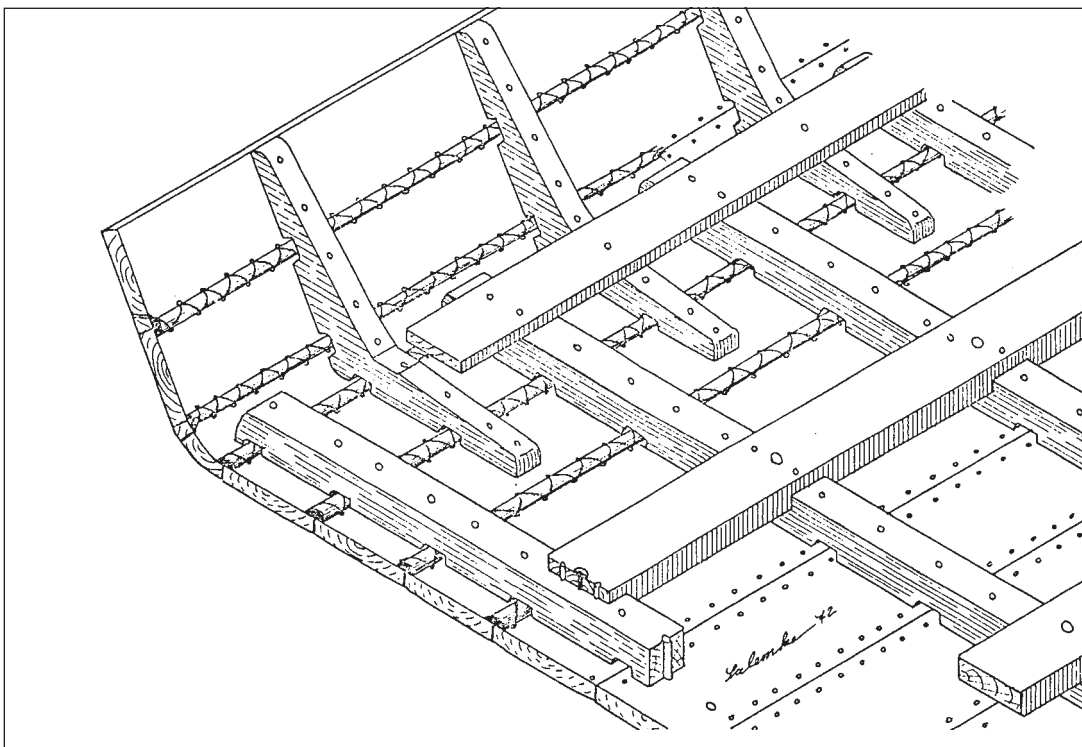

V.18  
**Brod Lipe.** Aksonometrijski prikaz trupa  
**Lipe wreck.** Axonometry of the hull  
 (prema / from: Salemke 1973, 23)

## V.19

Brod Kamensko, detalj oplate s klanfama  
 Kamensko wreck, detail view of the clamps  
 (fotografija / photo by: L. Damelet)

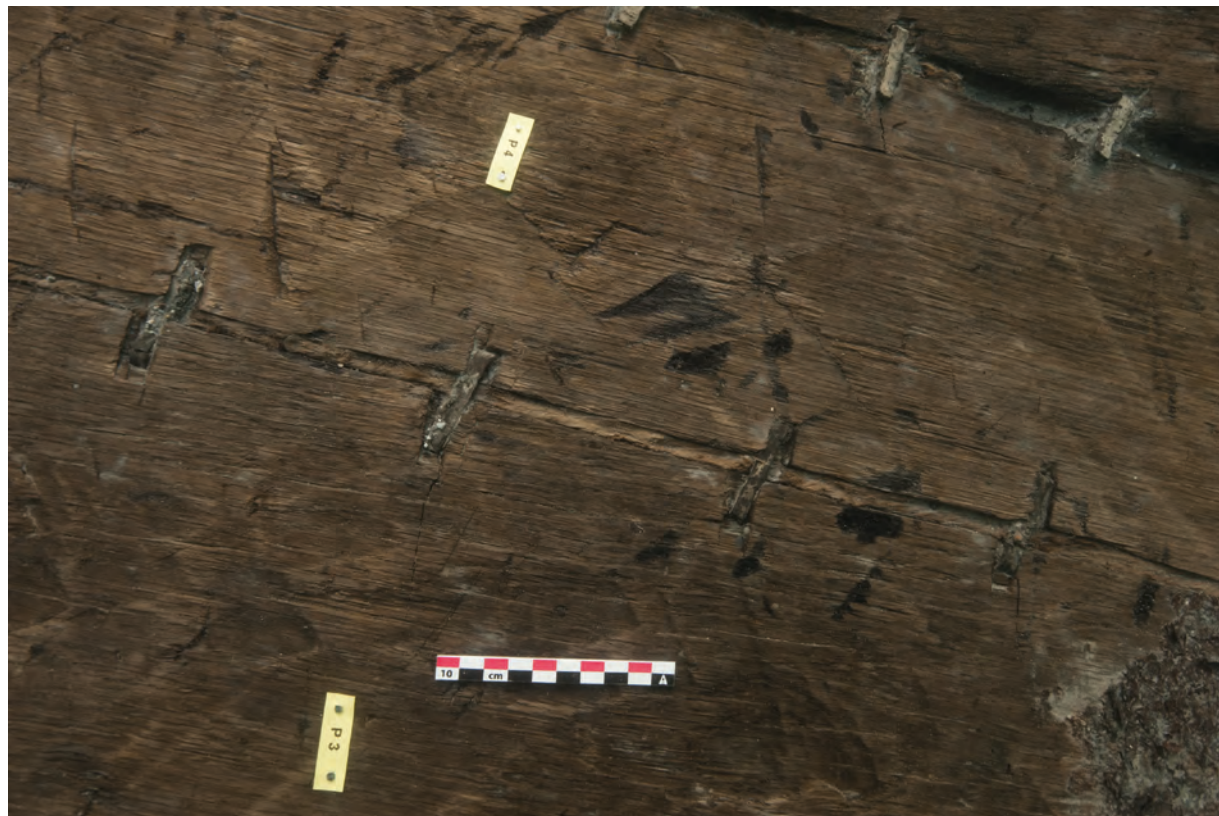

prema rijeci Savi i hidrogeografskom porječju Dunava te jasno pripada dijelu jugoistočne Europe. Godine 2015. na Vrhniki je pronađen još jedan šivani brod (Vrhnika 2). Datiran je u 2. st. pr. Kr., čime je potvrđena tehnika šivanja na području rijeke Ljubljanice vjerojatno i prije vremena teglenice Lipe<sup>19</sup>. Sva ova otkrića šivanih brodova u Sloveniji nalaze se na spoju tri regionalne tradicije: kontinentalne tradicije Dunava te pomorske tradicije sjeveroistočnog i sjeverozapadnog Jadrana.

Također je važno naglasiti da dosad poznati šivani brodovi u gornjem slivu rijeke Ljubljanice tvore podgrupu brodova na području dunavske brodograditeljske tradicije. Brodovi s metalnim klanfama koje učvršćuju biljni materijal između platica, pripadaju drugoj regionalnoj podskupini brodova (Boetto, Rousse 2011, 188-190; 2012), što je potvrđeno otkrićima teglenice u Kušnjaku na Dunavu (2. st., Srbija, Bockius 2003), u Sinjoj Gorici na rijeci Ljubljanici (*terminus post quem*, godina 3. Slovenija, Erič *et al.* 2014; Čufar *et al.* 2014), u Sisku (2. i 3. st., Gaspari *et al.* 2006) i u Kamenskom kod Karlovca na

the Ljubljanica River opens towards the Sava River and the Danube hydrographical basin, and clearly belongs to the south-eastern region of Europe. In 2015, another sewn boat was discovered in Vrhnika (Vrhnika 2 wreck). Dated to the 2<sup>nd</sup> century BCE, this ship find confirms the use of the sewing technique in the Ljubljanica River, possibly at an earlier date than the Lipe barge<sup>19</sup>. All of these discoveries of sewn boats in Slovenia occur at the intersection of three regional traditions: the continental Danube, the maritime north-eastern Adriatic, and the north-western Adriatic.

It is important also to underline that the sewn boats now known only in the upper part of the Ljubljanica River form a sub group within the Danubian shipbuilding tradition. The vessels with metal clamps holding the vegetal luting in place between planks constitute another sub group (Boetto, Rousse 2011, 188-190, 2012), attested by the discoveries of the river barges of Kušnjak on the Danube (2<sup>nd</sup> century CE, Serbia, Bockius 2003), Sinja Gorica on the Ljubljanica River (*terminus post quem* the year 3 AD

19 Gornji dio vojeva na kojem su se nalazile rupe za šivanje i koji je vjerojatno izrađen od mekog drva, bio je vidljiv u dužini od oko 2 m na boku riječnog korita. Također je identificiran debeli odvojeni dio umetnutog sloja napravljenog od biljnog materijala te gornji dio od tri rebra, smještena u razmaku od 60 cm i povezani hrastovim čavlim za oplatu. Jedno od rebara je imalo pravokutni urez iznad umetnutog sloja. Radiokarbonske analize jednog malog čavla od drva tise (*Taxus baccata*), koji je služio za učvršćenje šavova, te jednog uzorka s oplata, datirale su ih u 2. st. pr. Kr., iako se ne može isključiti upotreba starog drva (Gaspari 2017, 87, Sl. 85-87). A. Gaspari je također istaknuo da je u 19. st. A. Müllner izvjestio o kronološki neutvrđenom monoksilu koji je pronađen u močvari Ljubljanice kod Zelenog Hriba. Iz njegovog izvješća čini se da je monoksil imao dio vezan za trup (Gaspari 2017, 117-118).

19 The upper part of a strake with stitch-holes, probably made from a soft wood, was visible on the side of the riverbed in the length of about 2 m. A detached part of a thick wadding pad made of plant material and the upper part of three ribs, placed at an interval of 60 cm and connected by oak nail to the planking, were also identified. One of the ribs presented a rectangular notch over the wadding pad. Radiocarbon analyses of one peg in yew (*Taxus baccata*) fixing the stitches and of one sample from the planking date this sewn boat to the 2<sup>nd</sup> c. BCE even if the use of old wood cannot be excluded (Gaspari 2017, 87, fig. 85-87). A. Gaspari has also pointed out that in the 19<sup>th</sup> c. A. Müllner reported a chronologically undetermined logboat found in the Ljubljanica Marshes near Zeleni Hrib. From his report it seems that the logboat presented a piece lashed to the hull (Gaspari 2017, 117-118).

rijeci Kupi (1. i 2. st., Hrvatska, Boetto, 2016; Boetto *et al.*, u tisku, Sl. V.19)<sup>20</sup>.

S današnjeg gledišta teško je utvrditi da je korištenje klanfi omogućavalo bržu izgradnju i jednostavnije rukovanje te da se vezivalo uz rimsku okupaciju Ilirika i Panonije, kao i da je proizašlo iz tehnologije šivanja (Gaspari 2017, 184).

Monoksil Vrhnika 1, datiran na kraj 2. st. pr. Kr., koji je pronađen na Vrhniku u rijeci Ljubljanici i nedavno je objavljen (Gaspari 2017, u tisku), kao i drugi nalazi koje je reinterpreterao Gaspari (Gaspari 2017, 184), a gdje su u velikom broju pronađene metalne klanfe i metalne trake koje su korištene uglavnom kod popravaka, potvrđuju upotrebu klanfi kao tehničkog rješenja iz vjerojatno predrimskog razdoblja<sup>21</sup>.

## Ostale mediteranske tradicije šivanih brodova

### Iberska tradicija s punskim utjecajima

Iberska tradicija s punskim utjecajem je tradicija šivanih brodova potvrđena u Iberiji, današnjoj Španjolskoj (Pomey 2012a, 24-28; De Juan 2014), (Sl. V.4). Najraniji dokazi su lokaliteti Mazarrón 1 i 2 s brodovima skromnih dimenzija koje karakterizira zaobljeno dno trupa s kobilicom, oplata izgrađena spojem utor - jezičac te mala cilindrična rebra koja su privezana za oplatu (Sl. V.20, V.21). Ovakav princip izgradnje pronađen je i na kasnijem brodolomu kod Binisafüllera (4. st. pr. Kr., Minorca, Baleari) te vrlo vjerojatno i u brodolomu Golo (arhajsko razdoblje, Korzika).

Brodovi iz Mazarróna su lokalnog porijekla; i po korištenju i po konstrukciji namijenjeni su obalnoj plovidbi. Vezivanje rebara i opstanak ove tehnike stoljećima nakon toga, vrlo vjerojatno upućuju na stariju lokalnu tradiciju iberskog porijekla. S druge strane, u korištenju tehnike spajanja oplate spojem utor i jezičac još u arhajskom razdoblju očit je utjecaj punske brodograditeljske tradicije iz naselja u južnoj Iberiji.

Tehnika izgradnje spojem utor i jezičac, posvjedočena u brončanom dobu na istočnom Mediteranu u brodolomu Uluburun (Turska) s kraja 14. st. pr. Kr. (Bass 1989; Pulak 1998; 1999) te u brodolomu Cape Gelidonya s kraja 13. st. pr. Kr. (Bass 1967; 1999), vrlo se vjerojatno razvila na obali Levanta, u kanajskim i protofeničkim kontekstima (Wachsmann 1998; Polzer 2011). Tijekom razdoblja Rimske Republike, Katon Stariji (*De agr.*, XXI, 18, 9) tehniku sastavljanja oplate sustavom utora i jezičaca naziva

Slovenia, Erič *et al.* 2014; Čufar *et al.* 2014), Sisak (2<sup>nd</sup>-3<sup>rd</sup> century CE, Gaspari *et al.* 2006) and Kamensko, near Karlovac, on the Kupa River (1<sup>st</sup>-2<sup>nd</sup> century CE, Croatia, Boetto 2016; Boetto *et al.* forthcoming; Fig. V.19)<sup>20</sup>.

At present, it is hard to see the clamps as a derivative of sewing technology that allowed faster construction and easier maintenance, related to the Roman conquest of Illyricum and Pannonia (Gaspari 2017, 184).

The logboat Vrhnika 1, dated to the end of the 2<sup>nd</sup> century BCE found in Vrhnika, Ljubljanica River, and recently published (Gaspari 2017, forthcoming), and the other findings reinterpreted by A. Gaspari (2017, 184), in which large iron clamps and nailed iron strips are used mostly for repairs, confirm the use of clamps as a technical solution possibly of Pre-Roman origin<sup>21</sup>.

## Other Mediterranean sewn-boat traditions

### The Iberian tradition with Punic influence

The Iberian tradition with Punic influence is an ancient sewn-boat tradition attested in Iberia, modern Spain (Pomey 2012a, 24-28; De Juan 2014) (Fig. V.4). The earliest evidence is provided by the Mazarrón 1 and 2 wrecks of boats of modest size characterized by a round-bottom hull with keel, planking assembled by mortise-and-tenon joints, and small cylindrical frames lashed to the planking (Figs V.20, V.21). This combination was also found in the later Binisafüller shipwreck (4<sup>th</sup> century BCE, Minorca, Balearic Islands) and very likely in the Golo shipwreck (Archaic period, Corsica).

The Mazarrón boats are coastal crafts of both local use and construction. The lashing of the frames and its survival several centuries later is very likely evidence of an ancient local tradition of Iberian origin. On the other hand, the use as early as the archaic period of the mortise-and-tenon joint for the planking is an obvious influence of the Punic tradition of shipbuilding due to the presence of Phoenician settlements in southern Iberia.

The mortise-and-tenon joint, evidenced from the Bronze Age in the Eastern Mediterranean by the Uluburun wrecks (Turkey) dated to the end of the 14<sup>th</sup> century BCE (Bass 1989; Pulak 1998, 1999) and the Cape Gelidonya wreck of the end of the 13<sup>th</sup> century BCE (Bass 1967, 1999), very likely originated on the Levantine coast, in a Cananean or proto-Phoenician context (Wachsmann 1998; Polzer 2011). Then, during the Roman Republican period, Cato the Elder (*De agr.*,

20 Ovaj lokalitet se istražuje od 2015. u sklopu bilateralne suradnje između Hrvatskog restauratorskog zavoda (HRZ) i Centra Camille Jullian.

21 Prisutnost proizvedenih materijala za popravak monoksila Vrhnika moglo bi se također povezati s pomorskom praksom u brodogradnji (Gaspari 2017, 180), čime se potvrđuje upliv mediteranskih utjecaja prema rijeci Ljubljanici. Pregled se donosi u Gasparijevom radu, koji je u tisku.

20 This site is excavated from 2015 in the frame of bilateral collaboration between the Croatian Conservation Institute (HRZ) and the Centre Camille Jullian.

21 The presence of fabric material in the repairs of the Vrhnika logboat could also be connected to maritime shipbuilding practises (Gaspari 2017, 180) confirming the opening of the Ljubljanica river area to the Mediterranean influences. An overview in Gaspari forthcoming.

V.20

**Brod Mazarrón 2.** Pogled na brodsku konstrukciju tijekom istraživanja 2008

**Mazarrón 2** shipwreck. General view of the hull during the 2008 excavation  
(fotografija / photo by: J. A. Moya)



V.21

**Brod Mazarrón 2.** Crtež dna trupa s vezanim rebrima i usadnikom jarbola

**Mazarrón 2** shipwreck. Drawing of the hull bottom with the lashing of the frames and the mast step timber  
(prema / from: Negueruela 2005)

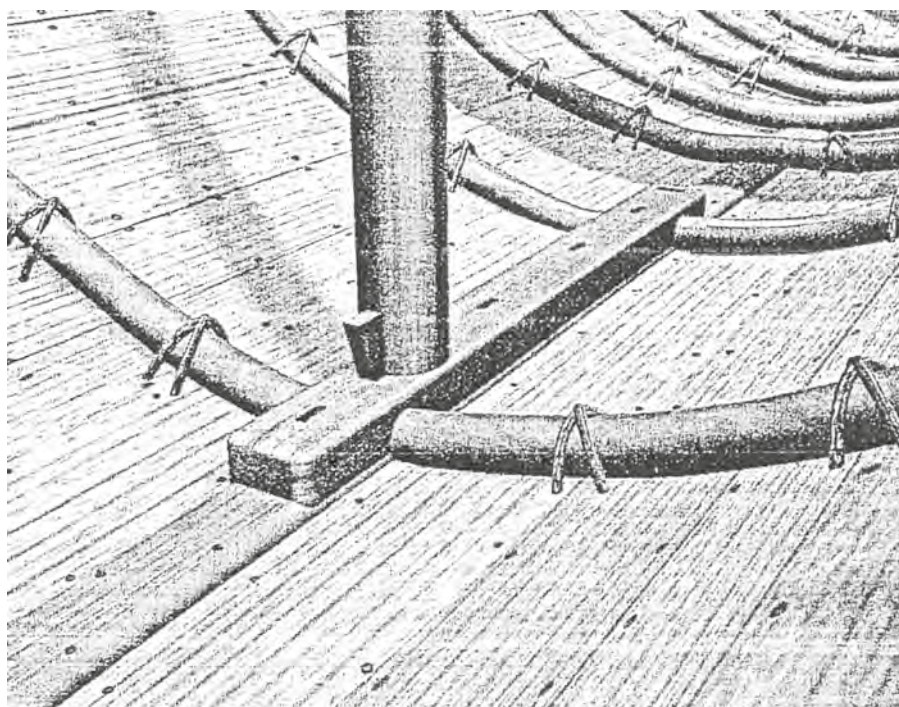



„*coagmenta punicana*“, potvrđujući njezino punsko-feničko porijeklo.

### Grčka tradicija

Grčka tradicija šivanih brodova dobro je potvrđena na Mediteranu nalazima jedanaest olupina koje su pronađene u istočnom i zapadnom kontekstu (Sl. V.4). Zbog brojnosti brodoloma na kojima je utvrđena, ova tradicija je vjerojatno najbolje poznata od svih mediteranskih tradicija šivanih brodova. Ustanovljene su četiri faze njene evolucije od arhajskog razdoblja do početka helenističkog doba (Pomey 1997; Kahanov, Pomey 2004; Pomey 2008, 2010, 2012a, 25).

Ranija ili „izvorna skupina“ (Pomey 2010) se odnosi na pet olupina iz grčkih ili masalijskih konteksta, datiranih u 6. st. pr. Kr., pronađenih na istočnom i zapadnom Mediteranu. Ovi brodovi pripadaju istoj tradiciji grčkih šivanih brodova. Riječ je o brodovima sa šivanim platicama i vezanim rebrima, od kojih su veći bili dužine između 15 i 25 m (Giglio, Pabuç Burnu i Cala Sant Vicenç), a manji dužine oko 10 m (Bon-Porté 1 i Jules-Verne 9) (Sl. V.22-V.24).

U usporedbi s ostalim mediteranskim sustavima šivanja, grčki djeluje vrlo sofisticirano. Tako se u sljubnice

XXI, 18, 9) called mortise-and-tenon joints ‘*coagmenta punicana*’, confirming their Punic-Phoenician origin.

### The Greek tradition

The Greek sewn-boat tradition is well attested in the Mediterranean by 11 wrecks found in both Eastern and Western contexts (Fig. V.4). Due to numerous shipwrecks belonging to this tradition, it is the best known of the Mediterranean sewn-boat traditions and four phases of evolution have been identified from the archaic period up to the beginning of the Hellenistic era (Pomey 1997; Kahanov, Pomey 2004; Pomey 2008, 2010, 2012a, 25).

The first or “original” group concerns five wrecks attesting to an Aegean or Massalian context dated to the 6<sup>th</sup> century BCE, found in both the Eastern and Western Mediterranean. They belong to the same Greek archaic sewn-boat tradition, and they correspond to large sailing vessels between 15 and 25 m long (Giglio, Pabuç Burnu, and Cala Sant Vicenç), or small boats around 10 m long (Bon-Porté 1 and Jules-Verne 9), each with sewn planks and lashed frames (Figs V.22-V.24).

In particular, the sewing system used for the planking appears more sophisticated than in the other known



V.22

**V.22**  
Brodovi Jules-Verne 7 i 9. Pogled tijekom istraživanja

Jules-Verne 7 and 9 wrecks. View of the wrecks in excavation  
(fotografija / photo by: M. Derain)

**V.23**  
Brod Jules-Verne 9. Aksonometrijski prikaz sustava spajanja, šivanjem i vezanjem Jules-Verne 9 wreck. Axonometry of the sewing and lashing assembly system  
(crtež / drawing by: M. Rival)

**V.24**  
Brod Jules-Verne 9. Crtež rekonstruiranog glavnog poprečnog presjeka Jules-Verne 9 wreck. Reconstruction drawing of the transversal main section  
(crtež / drawing by: P. Poveda)

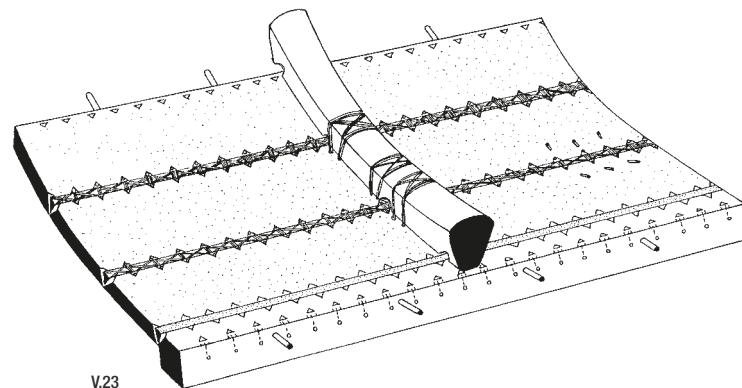

V.23

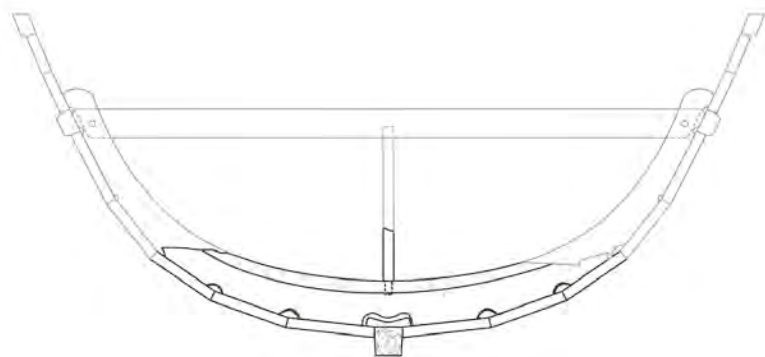

0 1 2m  
© P. Poveda, 2018. Aix Marseille Univ., CNRS, CCJ

V.24



V.25

**V.25**  
**Brod Jules-Verne 7.** Detalj popravka platice šivanjem Jules-Verne 7 wreck. Detailed view of the sewing on a plank repair (fotografija / photo by: M. Derain)

**V.26**  
**Brod Jules-Verne 7.** Shematski prikaz spoja utor i jezičac Jules-Verne 7 wreck. Schema of the mortise-and-tenon joint (crtež / drawing by: M. Rival)

**V.27**  
**Brod Jules-Verne 7.** Rekonstrukcija glavnog poprečnog presjeka Jules-Verne 7 wreck. Reconstruction of the transversal main section (crtež / drawing by: P. Poveda)

**V.28**  
**Brod Jules-Verne 7.** Aksonometrijski prikaz strukture trupa Jules-Verne 7 wreck. Axonometric view of the hull structure (crtež / drawing by: M. Rival)

platica umeću tiple kako bi se spoj učvrstio i spriječilo smicanje. Zatim se izrađuju dijagonalne rupe s unutrašnje strane platice do nižeg ugla sljubnica, kako šavovi ne bi bili ispupčeni izvan korita tj. da se umanjí mogućnost njihova oštećenja trenjem. Tetraedalni urezi se zatim izrađuju pravilno uz unutrašnji rub platice, na ulazu na svakoj rupi za šivanje. Ove tetraedalne rupe su rađene kako bi se postiglo pravilno šivanje te izbjegli oštri kutovi na ulazu pojedine rupe.

Sljubnice platice su prije šivanja prekrivene smotuljkom lanene tkanine koja osigurava vodonepropusnost. Nakon toga se obavlja šivanje trostrukom lanenom niti prema shemi IXIXIX, koja je istovjetna duplom preklopnom šavu s dijagonalnim prolazom cijelom dužinom sljubnice i nazad. Naposljetku se u rupe umeću mali drveni čavli kako bi se šavovi fiksirali, a rupe začepile.

Položaje svih elemenata za sastavljanje (čivije, tetraedalni utori, dijagonalne rupe) brodograditelji su precizno označili na oplati. Rebra su oblikovana tako da se mogu vezati na najbolji mogući način.

Drugu, tzv. „prijelaznu skupinu“ čine četiri broda; ova

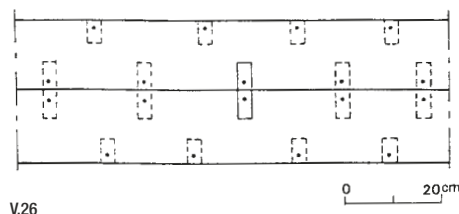

V.26

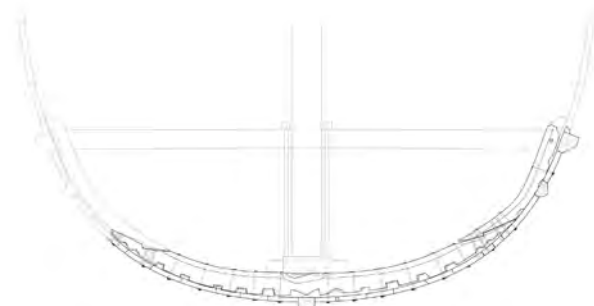

V.27

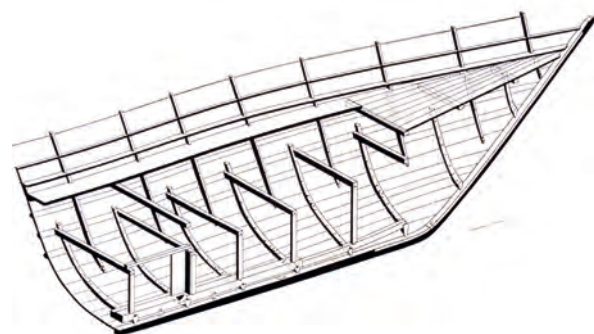

V.28

traditions. First, pre-assembly dowels (coaks) are placed in holes drilled in the thickness of the planks to keep the planks in place and to prevent the phenomena of shear. Then diagonal stitch holes start from the inner edge of the plank and finish just on the lower corner of the seams to avoid the stitches protruding and so prevent chafing. Tetrahedral recesses are cut regularly along the inner edge of the planks around the entry of each stitch hole. These tetrahedral recesses are made to ensure the sewing is very even and to avoid sharp angles at the entrance of the stitch channels.

A roll of linen fabric assures the seams are watertight and the sewing is made of a triple linen thread following an IXIXIX pattern corresponding to a double clamping turn with a diagonal passage, the whole length of the seam and back. Lastly, little pegs were driven into the channels to lock the stitches and plug the holes. The positions of all the assembly elements (treenails, tetrahedral recesses, and diagonal channels) were precisely marked by the carpenter on the planking. The frames are shaped to be lashed in the most efficient manner

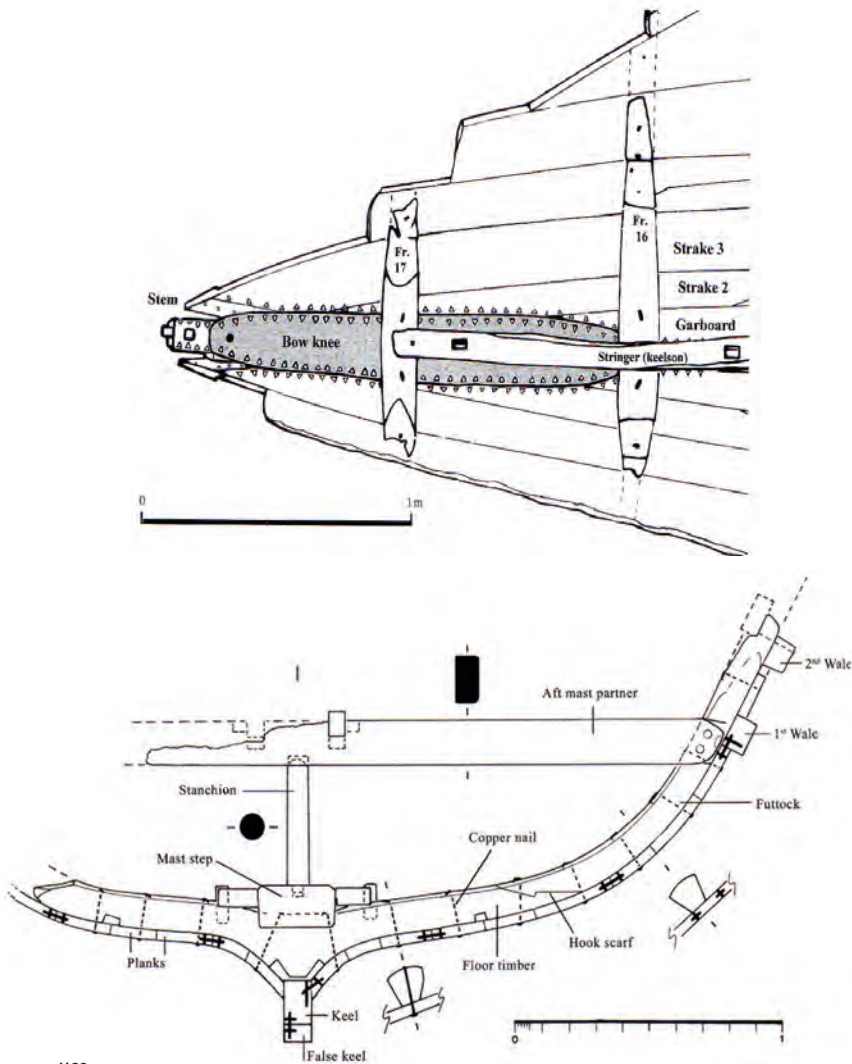

V.29

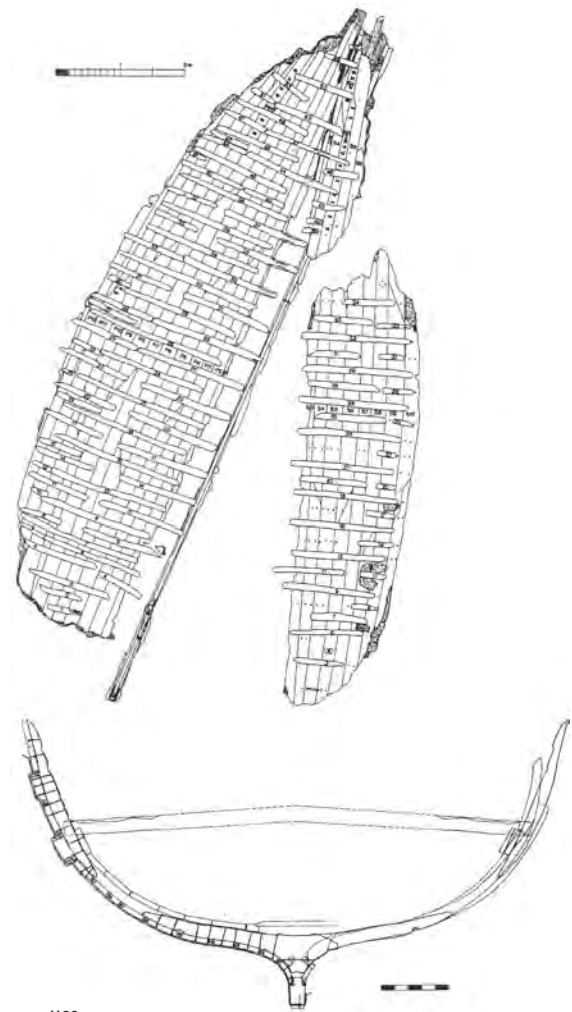

V.30

grupa ujedno predstavlja prvu fazu evolucije – vjerojatno u različitim stadijima – od tehnike šivanja do upotrebe spoja na utor i jezičac.

Šivanje se, slično kao u izvornoj grupi, još koristi za sastavljanje krajeva broda i popravke. Rebra su i dalje oblikovana za potrebe vezivanja, ali su rebrenice pričvršćene metalnim čavlima čiji je kraj s gornje strane savijen u obliku kuke. Ova skupina uključuje velike brodove (Grand-Ribaud F, Gela 1), srednje (Jules-Verne 7), (Sl. V.25-V.28) i brodice (Villeneuve-Bargemon 1).

Treća, tzv. „evolucijska skupina“ predstavlja drugu fazu u evoluciji ove grčke tradicije i posvjedočena je sredinom i u drugoj polovici 5. st. pr. Kr., na dvije olupine: Gela 2 i Ma’agan Mikhael (Sl. V.29).

Nekoliko karakteristika, poput ključa kobilice na zub, korištenja više tehnika za sastavljanje oplata, opće karakteristike slaganja rebara spojenih kukastim čavlima te korištenje tehnike šivanja s tetraedalnim rupama (ali bez prethodno umetanih drvenih tipli), povezuju ova dva brodoloma s prethodnom skupinom, ali ipak, oni imaju i bitne promjene u formi trupa (poprečni presjek u obliku

possible.

The second or “transition” group is composed of four wrecks and constitutes the first phase of evolution – possibly in a series of steps – from the sewing technique to the use of mortise-and-tenon joints for planking.

The sewing, similar to that attested in the “original group” type, was still used for the extremities and for repairs. The frames were still shaped for lashing, but the floor-timbers were fixed with clenched nails. This group concerns large ships (Grand-Ribaud F, Gela 1), medium (Jules-Verne 7) (Figs V.25-V.28), and small vessels (Villeneuve-Bargemon 1).

The third or “evolution” group is the second phase of evolution of this Greek tradition and is attested in the mid and the second half of the 5<sup>th</sup> century BCE by two wrecks: Gela 2 and Ma’agan Mikhael (Fig. V.29).

Several features, such as the keel hook scarf and a mixed coating, the general characteristics of the framing pattern fixed with clenched nails, and the use of the sewing technic with tetrahedral recesses (but without pre-assembly dowels) link these two wrecks to the former

V.29

**Brod Ma’agan Mikhael.** Tlocrt sašivenog pramčanog koljena; glavni poprečni presjek trupa **Ma’agan Mikhael shipwreck.** Top view of the sewing on the bow knee; transversal main section of the hull (Linder, Kahanov 2003).

V.30

**Brod Kyrenia.** Opći plan i glavni poprečni presjek trupa **Kyrenia shipwreck.** General plan and main cross section of the hull (Wylde Swiny, Katzev 1973).

„čaše za vino“), a u morfološkom smislu, rebra postaju više kvadratnog presjeka.

Na sami kraj 4. i početak 3. st. pr. Kr. datira se brod Kyrenia (sjeverna obala Cipra, Wylde Swiny, Katsev 1973; Steffy 1985) (Sl. V.30); iako na njemu nije ustanovljeno šivanje, spada u jedini dovoljno istražen brodolom važan za razumijevanje finalne faze evolucije grčkih šivanih brodova. Pripadnost broda iz Kyrenije obitelji grčkih šivanih brodova nije jasno vidljiva već se može uočiti jedino kroz usporedbe s prethodnom „evolucijskom skupinom“, a osobito s brodolomom Ma'agan Mikhael, s kojim dijeli nekoliko karakteristika. Štoviše, reupotreba platice s tetraedalnim utorima sa šivanog broda kao podnice za brod Kyrenia dokaz je za određenu bliskost i povezanost između broda Kyrenia i grčke tradicije šivanih brodova. Brodolom Ereĝli E, recentno otkriven u Crnom moru (Brennan *et al.* 2013; Davis *et al.* 2018), koji se datira na početak 3. st. pr. Kr., dokazuje da se grčka tradicija šivanih brodova nije ugasila sa zadnjim stupnjem evolucije, tj. s brodom Kyrenia.

Prema svim ovim karakteristikama, Kyrenia pripada novom tipu broda helenističkog i republikanskog razdoblja (Pomey 2004b). Ipak, ovaj brod predstavlja kulminaciju duge evolucije grčke tradicije šivanih brodova do prijelaza prema korištenju spoja utor i jezičac. Sustavno korištenje spojeva utor i jezičac ne implicira samo usvajanje novog sustava spajanja već i novi sustav gradnje broda. Ova tehnika je ostala u upotrebi u brodogradnjama diljem Mediterana, u grčkom, punskom i rimskom kontekstu od kraja klasičnog razdoblja do kraja antike, tj. do prijelaza prema izgradnji brodova tehnikom „prvo kostur“ (Steffy 1994; Pomey *et al.* 2012). Prednosti ovog novog sustava izgradnje dobro su poznate u literaturi (Pomey 2011b).

Jezičci, izrađeni uglavnom od tvrdog drva, mnogo su jači i izdržljiviji od ligatura biljnog porijekla čime je omogućen razvoj novih tipova brodova te povećanje dimenzija i nosivosti brodova u skladu s razvojem pomorske trgovine, kao i gradnja efikasnijih, dugotrajnijih i sigurnijih plovila.

Može se pretpostaviti da je upravo utjecaj korištenja spoja utor i jezičac u punsko-feničkoj tradiciji bio odlučujući impuls za usvajanje takve tehnike od grčkih brodograditelja, osobito u kontekstu zapadno-grčke kolonizacije te izravnog kontakta i sukoba Grka i Kartažana.

group, but they present major changes in the hull shape (a “wine-glass” transversal section) and in the morphology of the frames, which are evolving towards a square section.

In the last years of the 4<sup>th</sup> and beginning of the 3<sup>rd</sup> century BCE, the Kyrenia wreck (northern coast of Cyprus, Wylde Swiny, Katsev 1973; Steffy 1985) (Fig. V.30), although devoid of sewing, is the only wreck sufficiently excavated to allow an understanding of the final phase of the evolution of the Greek sewn-boat tradition. The Kyrenia ship's affiliation to the Greek sewn-boat tradition is not evident and can be established only through comparison with the former “evolution group” and especially with the Ma'agan Mikhael ship, which shares several features with Kyrenia. Moreover, the reuse in the ceiling of the Kyrenia ship of a plank with tetrahedral recesses from a sewn boat (Steffy 1985, 95) is a clue that proves a certain proximity and familiarity between the Kyrenia vessel and the Greek sewn-boat tradition. Moreover, at the start of the 3<sup>rd</sup> century BCE, the Ereĝli E wreck-site, recently discovered in the Black Sea (Brennan *et al.* 2013; Davis *et al.* 2018), shows that the Greek tradition of sewn boats did not suddenly vanish with the ultimate step of evolution evidenced by the Kyrenia wreck.

By all its traits, Kyrenia belongs to a new ship type characteristic of the Hellenistic and Republican period (Pomey 2004b). However, if this ship represents the culmination of the long evolution of the Greek sewn-boat tradition, up to the adoption of the mortise-and-tenon joint, the systematic use of mortise-and-tenon joints implies not only the adoption of a new system of assembly but also a new system of construction. This system was used in all Mediterranean shipbuilding, in Greek, Punic and Roman contexts, from the end of the Classical period to the end of Antiquity and the transition towards skeleton construction (Steffy 1994; Pomey *et al.* 2012). The benefits of the new system of construction are well known (Pomey 2011b).

Tenons, made generally of hard wood, are much stronger and much more durable than vegetal ligatures. It became possible to develop new ship types and to increase the size and tonnage of the ship in line with the development of maritime trade and to build more efficient, safer ships of greater longevity.

It is possible that the influence of the use of mortise-and-tenon joints in the Punic-Phoenician tradition gave the decisive impulse for the adoption of mortise-and-tenon joints by Greek shipbuilders, especially in the particular context of Western Greek colonization and the direct contact and confrontation between Greeks and Carthaginians.

## Sjeverozapadna mediteranska tradicija

Unatoč prevladavajućoj tehnici korištenja spoja utor i jezičac u mediteranskoj brodogradnji od kraja 4. st. pr. Kr., praksa šivanja preživjela je u drugim zemljopisnim i kulturnim područjima. Ovo je slučaj rimske tradicije na Jadranu, međutim postoje i dokazi preživljavanja tehnike šivanja u brodogradnji gdje je tradicionalno korištena tehnika izgradnje spojem utor i jezičac. Primjer za to je brod pogonjen jedrima i veslima Pisa C (Pisa, Italija, 1. stoljeće) (Sl. V.4), koji je na jednom malom dijelu oplate popravljen šivanjem (Camilli 2002, Sl. 7).

Značajnija je tradicija sastavljanja rebara unutarnjim vezivanjem, a koja je utvrđena na šesnaest olupina koje su pronađene na sjevernom dijelu zapadnog Mediterana, od Katalonije do južne Francuske i Korzike (Sl. V.4). Ova specifična tehnika vezivanja koja se koristi samo za rebara, i koja dolazi u kombinaciji s oplatom građenom spojem utor i jezičac, tvori zasebnu tehnološku tradiciju koju možemo nazvati „sjeverozapadnom mediteranskom tradicijom“. Rebra su spojena za oplatu pojedinačnim čivijama te naizmjenično unutarnjim vezivanjem. Povezi se sastoje od omče napravljene od isprepletenih biljnih vlakana koja prolaze kroz dvije vertikalne rupe u rebrima. Šavovi su nakon toga fiksirani u rupama uz pomoć dugih drvenih čavala. Žljebovi povezuju rupe na unutarnjoj gornjoj strani rebara i na vanjskoj strani oplate, ne bi li spriječili izvirivanje šavova i zaštitili ih od trenja.

Ovakav sustav pričvršćivanja rebara utvrđen je na brodovima koji se datiraju između sredine 3. st. pr. Kr. i kraja 1. stoljeća (Pomey 2002; Marlier 2005; Wicha 2005), a tvore je dvije skupine brodova.

Prva skupina obuhvaća male priobalne brodove s kobilicom i više-manje oštrim poprečnim presjekom dna, a druga uključuje brodove za riječno-morsku plovidbu koji imaju ravnu kobilicu i ravno dno. Brodovi iz druge skupine plovili su na području koje karakterizira mreža riječnih i morskih lokaliteta, između današnjih regija Katalonije i Languedoca, od rijeke Ebro do rijeke Rhone.

## Zaključak

U korpusu od preko 64 šivana broda koji su do danas poznati na Mediteranu moguće je razlučiti nekoliko različitih tradicija, koje su dobro okarakterizirane i identificirane te se mogu vezati uz precizno određene geografske regije i kulturološka područja. Važnost ovih tradicija, široko rasprostranjenih diljem Mediterana, svjedoči o značaju tehnika šivanja i vezivanja te o vrlo visokom stupnju njihove sofisticiranosti, što dokazuje da su bile dobro prilagođene potrebama brodogradnje

## The north-western Mediterranean tradition

In spite of the dominant use of the mortise-and-tenon joint in Mediterranean shipbuilding from the end of the 4<sup>th</sup> century BCE, the practice of sewing survives in other geographic and cultural areas. This is the case of the Roman traditions of the Adriatic Sea, but we also have evidence of the survival of sewing practices in fully mortise-and-joint fastened shipbuilding. An example is the Pisa C wreck, a sailed and rowed boat (Pisa, Italy, 1<sup>st</sup> century CE) (Fig. V.4), where a little sewn repair has been observed on the planking (Camilli 2002, fig. 7).

More significant is the tradition using frames assembled by internal lashings, which has been observed on 16 wrecks found in the northern part of the Western Mediterranean, from Catalonia to Southern France and Corsica (Fig. V.4). This specific lashing technique, used only for the frames and associated with mortise-and-tenon joints for the planking, constitutes a particular technical group that can be called the “north-western Mediterranean tradition”. The frames are attached to the planking by individual treenails alternating with internal lashings. The lashings are made of a loop of vegetal braid that passes through two vertical channels in the frames. The ligature is then locked in the channels with long wooden pegs. Grooves connect the exits of the vertical holes on the inside face of the frames, and on the outer surface of the planking, to prevent the ligatures protruding, and so protect them from friction.

This technical tradition has been observed on wrecks dated from the middle of the 3<sup>rd</sup> to the end of the 1<sup>st</sup> centuries CE (Pomey 2002; Marlier 2005; Wicha 2005), belonging to two architectural families.

The first concerns small, keeled coastal vessels with a more-or-less sharp bottom, while the second group concerns fluvio-maritime vessels, characterized by a flat keel and a flat bottom. The boats of this second group sailed in the geographic zone characterized by the network of rivers and coastal lagoons situated between the modern regions of Catalonia and Languedoc, from the Ebro River to the Rhône River.

## Conclusion

In conclusion, in the corpus of more than 64 sewn boats known in the Mediterranean region, several different traditions have been distinguished, that have been characterized, identified, and attributed to precise geographic and cultural areas. The importance of these traditions, spread widely throughout the Mediterranean, testifies to the pertinence of sewing and lashing techniques, which achieved a very high degree of sophistication, and proves they were well adapted to shipbuilding needs

u antici. Iako su uglavnom posvjedočene nalazima iz arhajskog razdoblja, čini se da su njihovi korijeni vrlo stari i da ih treba datirati barem u kasno brončano doba, ako ne i u ranija razdoblja.

Prema dostupnim podacima, tradicije šivanih brodova koje smo ovdje predstavili uglavnom se odnose na sjeverne obale Mediterana, s osobito jakim korijenima u Grčkoj, od jonske obale do zapadnih fokejskih naselja oko Marseillea, potom na sjevernom Jadranu, na Iberskom poluotoku te na sjevernom kraju zapadnog Mediterana.

Također, bilo je moguće razlučiti nekoliko sustava šivanja koji su se razvijali na različite načine. Primjerice, iako egejska grčka i tzv. protohistarska tradicija koriste isti princip šivanja oplata s vezanim rebrima, njihova evolucija je sasvim različita. U grčkoj tradiciji evolucija je vidljiva kroz postupno usvajanje spajanja oplata spojem utor i jezičac te kroz brzo napuštanje vezivanja rebara, koje je zamijenjeno učvršćivanjem čivijama i metalnim čavlima. U jadranskoj se pak tradiciji šivanje oplata očuvalo i tijekom rimskog razdoblja.

S druge strane, iberska tradicija s punskim utjecajima vrlo je brzo usvojila građenje oplata spojem utor i jezičac, vjerojatno radi punskog utjecaja i kao dio prethodne tradicije, dok vezivanje rebara ostaje prisutno još dugo. To je tehničko rješenje slično onom koje se pronalazi u sjeverozapadnoj mediteranskoj tradiciji, u kojoj je oplata spojena na utor i jezičac, u kombinaciji s rebrima koja su djelomično spojena unutarnjim vezanjem.

Paralelno s time, u tom se razdoblju sustav spajanja oplata spojem utor i jezičac, koji je dobro posvjedočen na kraju brončanog doba u brodogradnji na Levantu, širio cijelim Mediteranom tijekom arhajskog i klasičnog razdoblja, da bi krajem 4. st. pr. Kr. postao dominantnom tehnikom gradnje brodova. Ipak, čak i kada je sustav spajanja oplata utorima i jezičcima dominantan, tradicije šivanja ne nestaju. Neke od njih preživjele su do kraja antike, a u određenim regijama čak i do ranog srednjeg vijeka, primjerice na Jadranu, gdje je tradicija bila izuzetno jaka i dobro prilagođena specifičnom okolišu i plovnom području.

Veliki broj brodova jadranske tradicije čini se izuzetnim u usporedbi s drugim tradicijama šivanja, otvarajući pitanje opstanka te tradicije (Carre 1997; Marlier 2002). Vjerojatno je prema P. Pomeyu (Pomey 1985, 41) i S. Marlier (Marlier 2002) da se opstanak te tradicije može objasniti upotrebom u zatvorenom području plovidbe (poput arhipelaga liburnske obale ili mreže delte rijeke Po, kao i drugih rijeka i laguna sjeverne Italije) koji je utjecao na efekt očuvanja ove tradicije.

in Antiquity. Although these techniques are mainly attested during the archaic period, their origin appears to be very old, dating back to at least the Late Bronze Age, if not before.

According to our data, the sewn-boat shipbuilding tradition mainly concerns the northern coasts of the Mediterranean with particularly active roots in Greece, from the Ionian coast to the western Phocaeen settlements around Marseilles, in the northern Adriatic, in the Iberian Peninsula, and in the northern arc of the Western Mediterranean.

We can also distinguish different sewing systems that evolved in different ways. For example, the Aegean Greek and the so-called Proto-Histrian traditions originally both used sewn planking with lashed frames, but their evolution differed. In the Greek tradition, the evolution saw the progressive adoption of the mortise-end-tenon joint and the rapid abandonment of lashed frames in favour of nailing or treenailing, while in the Adriatic traditions sewn planking was maintained during the Roman period.

On the other hand, in the "Iberian with Punic influence tradition" mortise-and-tenon joints were rapidly adopted to assemble planking, probably under Punic influence and as part of an earlier tradition, while lashed frames survived for a long time. A similar technical solution is found in the north-western Mediterranean tradition in which the planking is fastened with mortise-and-tenons associated with frames in part connected using internal lashings.

During that time, in parallel, the mortise-and-tenon joint system, well attested at the end of the Bronze Age in Levantine shipbuilding, spread progressively throughout the Mediterranean during the Archaic and Classical periods, becoming the dominant technique of assembly in ancient Mediterranean shipbuilding by the end of the 4<sup>th</sup> century BCE. But, even when the mortise-and-tenon joint was predominant, sewing traditions did not disappear. Some of them survived until the end of Antiquity and even the Early Medieval Period in some precise areas, such as in the Adriatic region, where the tradition was particularly strong and well adapted to a specific environment and sailing area.

The large numbers of vessels discovered within the Adriatic traditions appear exceptional in comparison to the other sewn traditions, raising the question of survival (Carre 1997; Marlier 2002). It is probable, according to P. Pomey (Pomey 1985, 41) and S. Marlier (Marlier 2002), that their survival can be explained as they operated in closed sailing areas (such as the archipelagic Liburnian coasts or the fluvio-maritime network of the Po delta area and the other rivers and lagoons of northern Italy), which had the effect of conserving these traditions.