



HAL
open science

The hull structure

Giulia Boetto, Marko Uhač, Ida Koncani Uhač

► **To cite this version:**

Giulia Boetto, Marko Uhač, Ida Koncani Uhač. The hull structure. I. Koncani Uhač; G. Boetto; M. Uhač. Zambratija. Prapovijesni šivani brod. Rezultati arheološkog istraživanja, analiza i studija / Prehistoric sewn boat. Results of the Archaeological Research, Analysis and Study, 33, Arheološkom muzeju Istre, pp.62-87, 2020, Monografije i katalozi, 978-953-8082-50-4. halshs-02986179

HAL Id: halshs-02986179

<https://shs.hal.science/halshs-02986179v1>

Submitted on 4 Nov 2020

HAL is a multi-disciplinary open access archive for the deposit and dissemination of scientific research documents, whether they are published or not. The documents may come from teaching and research institutions in France or abroad, or from public or private research centers.

L'archive ouverte pluridisciplinaire **HAL**, est destinée au dépôt et à la diffusion de documents scientifiques de niveau recherche, publiés ou non, émanant des établissements d'enseignement et de recherche français ou étrangers, des laboratoires publics ou privés.

Brodaska konstrukcija

The hull structure

Giulia Boetto, Marko Uhač, Ida Koncani Uhač

Olupina je orijentirana u smjeru sjeveroistok - jugozapad, dok je očuvani kraj trupa okrenut prema plaži. Kada je potonuo, brod je nalegao na istočni bok, koji je stoga ostao očuvan sve do završnog voja, za razliku od slabije očuvanog zapadnog boka (Sl. II.1 – II.3).

Ostaci trupa sačuvani su u dužini od 6,7 m te najvećoj širini od 1,6 m. Brod se sastoji od izdubljene osnovne monoksilnog stila, pet vojeva na istočnoj i dva voja na zapadnoj strani te tri rebrenice.

Nizovi zaptivenih rupa na oplati, koje su vjerojatno bile dio sistema za učvršćivanje rebara, identificiraju položaj još tri rebra. Ovo je dodatno potvrđeno tamnijim tragovima i otiscima baze rebara u paklinom premazanom unutarnjem dijelu trupa.

Opis brodskih ostataka

Uzdužni osni element

Jedan drveni komad (P2) izrađen od brijestovog trupca (*Ulmus* sp.), čiji je promjer veći od 40 cm, upotrijebljen je za izradu uzdužnog osnovnog elementa plovila (Sl. II.4). Na presjeku glavnog rebara plosnat je, debljine 3 cm, dok mu prema sjevernom kraju broda debljina doseže 21-23 cm (Sl. II.5 – II.7).

Širina mu se pak postupno mijenja od 39 cm u sredini do 6 cm na sjevernom kraju broda, mogućem pramcu

The wreck is oriented NE - SW with one preserved end of the hull pointing towards the beach. When the vessel sunk, it came to rest on one side, thus the western side is poorly preserved while the eastern side survives up to the sheerstrake (Figs II.1 – II.3).

The hull remains measure 6.7 m in length and 1.6 m in width at the widest section. The wreck consists of a carved logboat-style base, five strakes of planking on the eastern side and two strakes on the western side, as well as three floor-timbers.

The position of three more frames has been identified by rows of plugged holes on the planking that were probably part of the system used to attach the frames. Some dark traces on the wood, and evident marks left by the base of the frames on the interior layer of pitch, also clearly indicate the position of frame stations.

Description of the remains

The longitudinal axial element

A single piece of wood (P2) obtained from the trunk of an elm (*Ulmus* sp.) with a diameter of more than 40 cm constitutes the longitudinal axial element of the vessel (Fig. II.4). At the main frame, it is flat, and 3 cm thick, while towards the north end its thickness increases to 21-23 cm (Figs II.5 – II.7).

It narrows from 39 cm in the centre to 6 cm at the northern extremity, perhaps the bow, where the log is



gdje je trupac zašiljen. Tragovi alata poput sjekire ili tesla vidljivi su na unutrašnjoj površini. S arhitektonskog i strukturalnog gledišta neupitno je da je ovaj osnovni uzdužni element imao ulogu kobilice.

Na udaljenosti od 7,6 cm od sjevernog kraja kobiličnog elementa uočene su dvije horizontalne rupe pravokutnog presjeka (široke 1,3-1,5 cm i visoke 2-2,8 cm), međusobno razmaknute 19 cm (Sl. II.7). Rupe su vjerojatno služile za spajanje drugih drvenih dijelova na kraju kobiličnog elementa. Brodski element koji nedostaje je vjerojatno bio izrađen iz jednog komada drva i u njega su se umetali krajevi vojeva.

Oplata

Od brodskih ostataka, uz uzdužni osni element očuvane su još dvije platice na zapadnoj (P1 i P8) te pet platica (P3-P7) na istočnoj strani broda (Sl. II.4). Platice su u prosječne debljine 2,8 cm (prosječno od 1,9 cm do 3,3 cm). Njihova širina varira od 13,5 cm (P7) do 24,6 cm (P1). Svi ovi dijelovi napravljeni su od brijesta.

carved to a sharp point. Some tool marks, either made with an axe or adze, are visible in the inboard surface. This major longitudinal timber plays, from an architectural and structural point of view, the role of a keel.

At a distance of 7.6 cm from the keel-like timber's northern end, two horizontal holes, rectangular in section (1.3-1.5 cm wide and 2-2.8 cm high) and spaced 19 cm apart, have been noted (Fig. II.7). These were probably used to assemble another timber on top of the pointed end of the keel-like timber. This missing timber was probably carved from a single piece of wood to hold the ends of the strakes.

The planking

Two strakes on the west side (P1 and P8) and five strakes on the east side (from P3 to P7) are also preserved (Fig. II.4). The planks are 2.8 cm thick on average (range 1.9 cm to 3.3 cm). Their width varies between 13.5 cm (P7) and 24.6 cm (P1). All are made of elm.

II.1

Pogled na brod sa sjevera. Dva kvadranta i dva foto mjerila su postavljena oko ostataka broda radi izrade fotogrametrije

View of the wreck from the north. Two quadrants and two photographic scales are positioned around the wreck remains for the purposes of photogrammetric survey (fotografija / photo by: Ph. Groscaux)

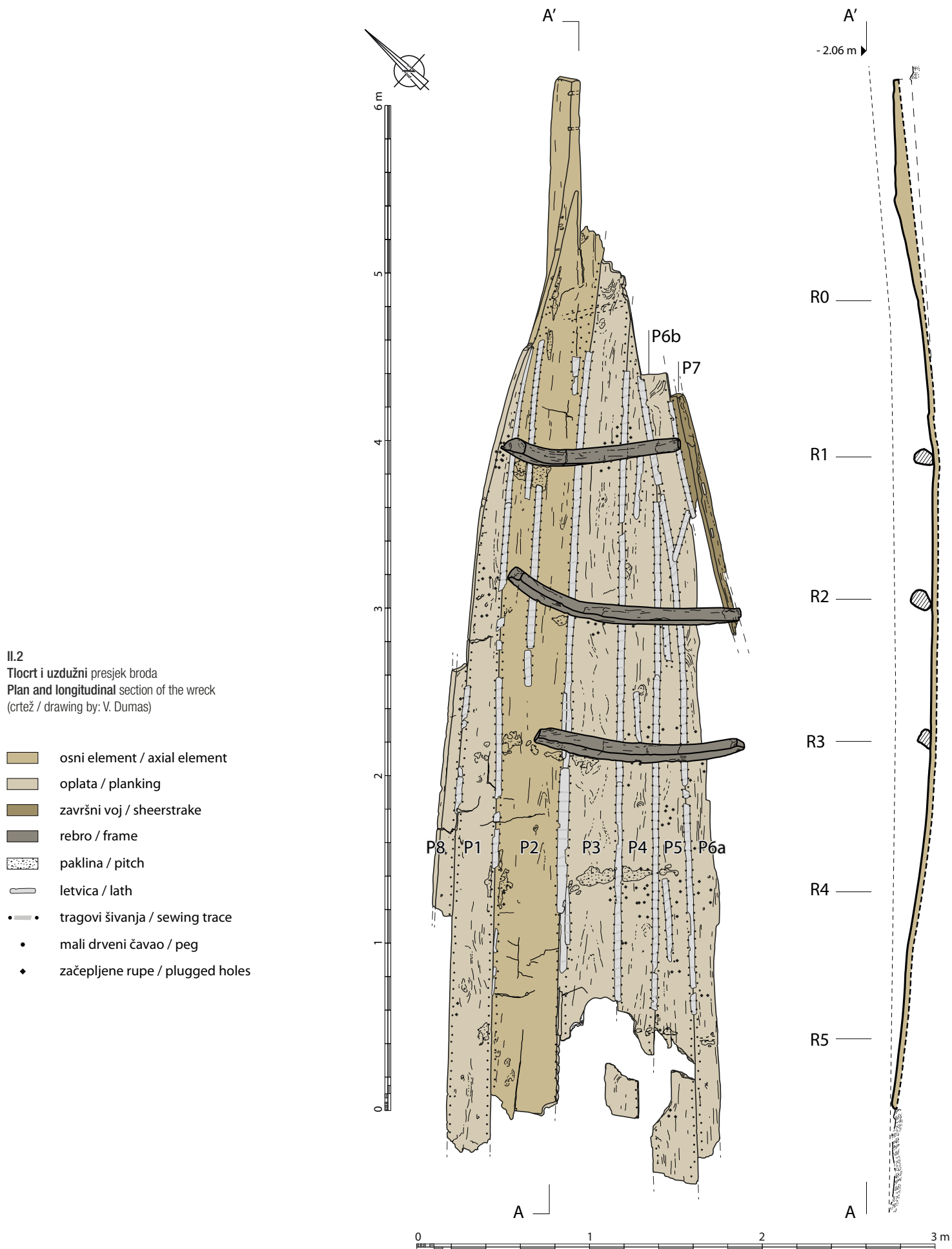

zapad / west

istok / east

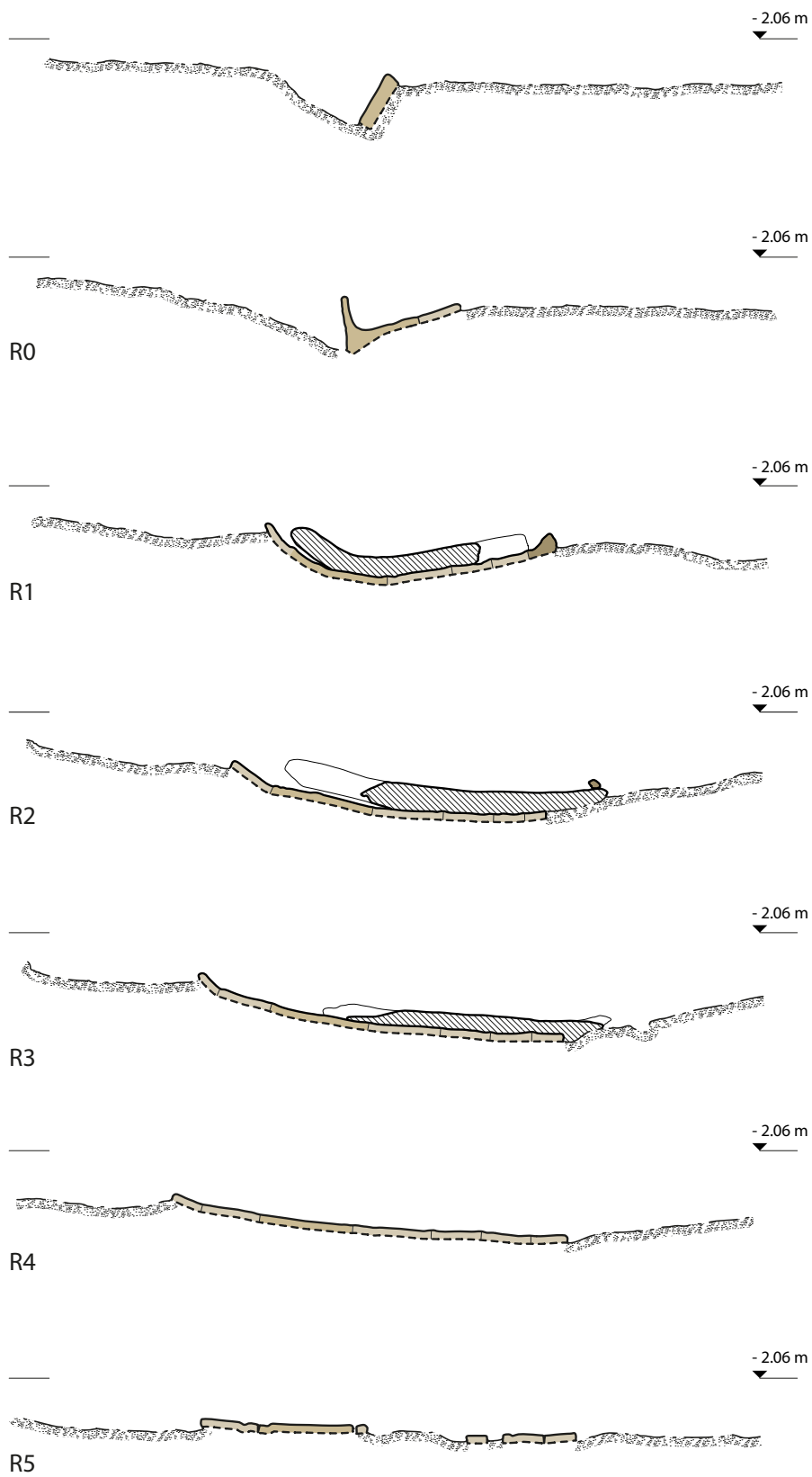

II.3
Poprečni presjeci
Cross sections
(crtež / drawing by: V. Dumas)

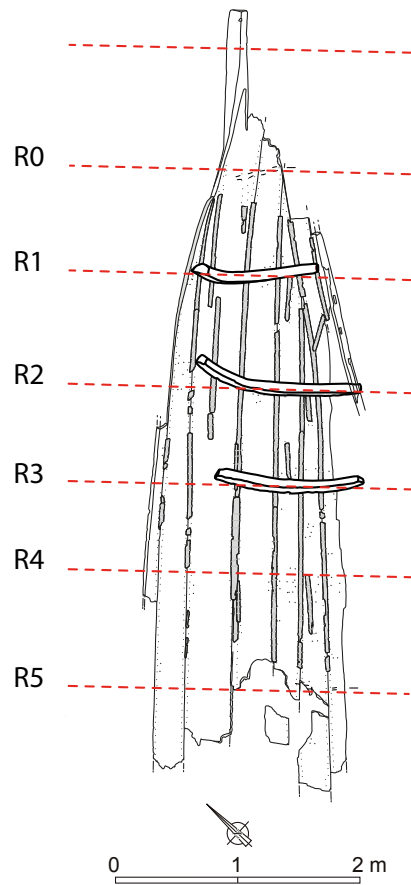

Drugu (P4) i treću (P5) platicu karakterizira šiljati dio na sjeveru. Ovi su mrtvi vojevi korišteni kako bi se suzila oplata na oštrom kraju broda. Četvrti voj sačinjavaju dvije platice (P6a i P6b) povezane kosim ključem.

Peti, gornji voj (P7) predstavlja završni voj broda (Sl. II.8 – II.10). Ima oblik L-profila orijentiranog prema unutrašnjosti trupa, a debljina mu iznosi od 3 do 4,3 cm. Ovaj obrađeni element L-profila ima dva (moguće i tri) utora pravokutnog oblika, dužine 4,5 cm i 7 cm te širine 1,3 cm i 2,5 cm. Funkcija ovih pravokutnih utora još nije poznata (Sl. II.10), a razmak između njih iznosi 20 cm. Mogući treći utor nalazi se na južnom kraju, a od prethodnog je udaljen 23 cm.

The second (P4) and the third (P5) strakes are characterized by a pointed end to the north. These stealers were used to reduce the planking at the pointed end of the boat. Two planks (P6a and P6b) connected with an oblique scarf compose the fourth strake.

The fifth and upper strake (P7) is the sheerstrake (Figs II.8 – II.10). It has an L-shaped section oriented towards the interior of the hull and is 3-4.3 cm thick. This carved L-shaped timber has two (possibly three) rectangular, open mortises, the function of which is still uncertain (Fig. II.10). The mortises are, respectively, 4.5 cm and 7 cm long, 1.3 cm and 2.5 cm wide, and are spaced 20 cm apart. The possible third mortise at the southern end is placed 23 cm from the previous one.

Sustav spajanja oplata

Vojevi položeni stično međusobno su spojeni uzdužnim sustavom šivanja (Sl. II.11, II.12). Šavovi, izvedeni od biljnih vlakana, nisu očuvani, ali se jasno vide njihovi tragovi na letvicama položenim preko sljubnica platica, a koje pripadaju sustavu vodonepropusnosti broda. Dvije

The system for assembling the planking

The strakes, which are flush-laid, are assembled using a longitudinal sewing system (Figs II.11, II.12). The stitches were made of vegetal fibres but have not been preserved. Instead, traces left by the cord are clearly visible on laths, placed over the seams before the planks

II.4
Brodsko oplata
The planking
(crtež / drawing by: V. Dumas)

-  osni element / axial element
-  oplata / planking
-  završni voj / sheerstrake
-  mrtvi voj / stealer
-  paklina / pitch
-  letvica / lath
-  tragovi šivanja / sewing trace
-  mali drveni čavao / peg
-  začepljene rupe / plugged holes

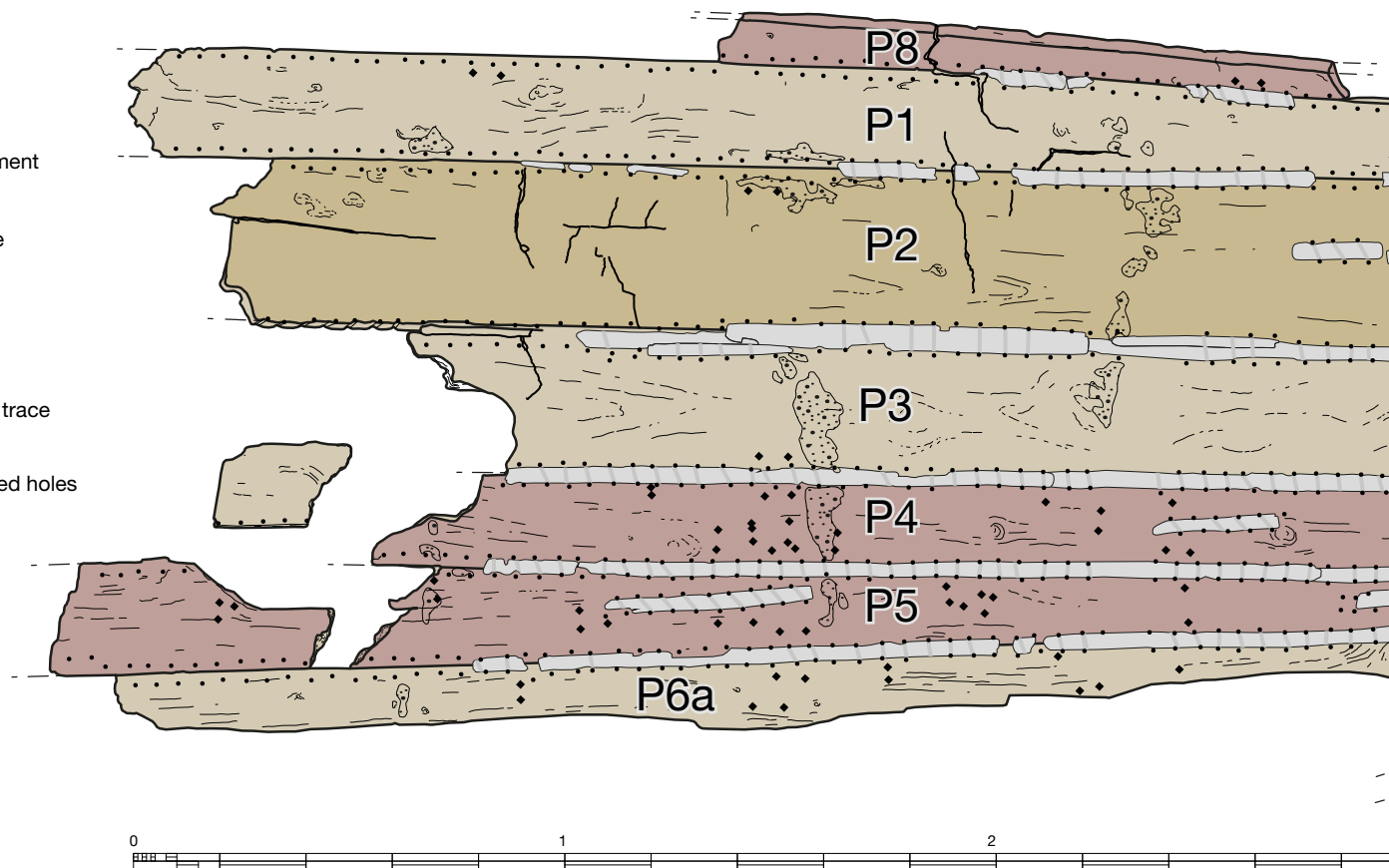

vidljive tamnije linije, s razmakom od 7 mm do 1 cm, omeđuju svjetliju traku na kojoj se nalazila ligatura od nekadašnjih šavova.

Na bočnim sljubnicama platica nema tragova njihovog predspajanja korištenjem tipli. Međutim, moguće je da će se, nakon vađenja broda iz podmorja, proučavanjem uočiti navedene značajke.

Šivanje je izvedeno jednostavnim rubnim šavom (uzorak ///), a šavovi prolaze kroz rupe izbušene ukoso, dijagonalno prema sljubnicama platica (nisu okomite) (Sl. II.13, II.15, II.16). Kut šivanja je promjenjiv, ali su šavovi paralelni, s međusobnim razmakom od 2 do 4,5 cm.

Vanjski rubovi platica su zakošeni radi upuštanja ligature unutar sljubnica platica (Sl. II.14, II.18). Svaka rupa za šav sastoji se od dva ili tri žlijeba napravljena konkavnim dlijetom ili svrdlom (Sl. II.17). Upravo stoga presjek ovih rupa nije kružni već ovalan (promjera od 1 do 2 cm).

Mali drveni konusni i zašiljeni čavli, od jedan do tri po rupi, zaptivali su šavove (Sl. II.19, II.20). Čavli su izrađeni rasijecanjem stabljika mekog drva, poput joha (*Alnus* sp.) i topole (*Populus* L.), i imaju polukružni ili trokutasti presjek. Dugi su 2,2-2,7 cm, široki 6-8 mm, debeli 3-5 mm), a zabijani su s unutrašnje strane trupa, s prosječnim

were sewn together to make the vessel watertight. Two dark lines, spaced 7 mm to 1 cm apart, flank a lighter zone where a ligature ran.

No evidence of pre-assembly of the planks using dowels was seen along the visible plank edges. However, it is possible that once the boat is recovered from the seabed, such features might be found.

The sewing consists of simple over-edge stitches (/// pattern) going through oblique stitch holes cut diagonally, rather than perpendicularly, to the plank edges (Fig. II.13, II.15, II.16). The angle of the sewing isn't regular, the angle of the stitches varies while they remain parallel to each other. The stitches were spaced 2 to 4.5 cm apart.

The external plank edges are chamfered to allow the passage of the ligature without it protruding (Figs II.14, II.18). Each stitch hole is composed of two or three grooves carved with a gouge or a drill (Fig. II.17). For that reason, the section of these holes isn't circular but oval and measures around 1 to 2 cm in width.

Small tapered and sharpened pegs, at least one to three for each stitch hole, locked each stitch in place (Fig. II.19, II.20). The pegs, obtained from splitting

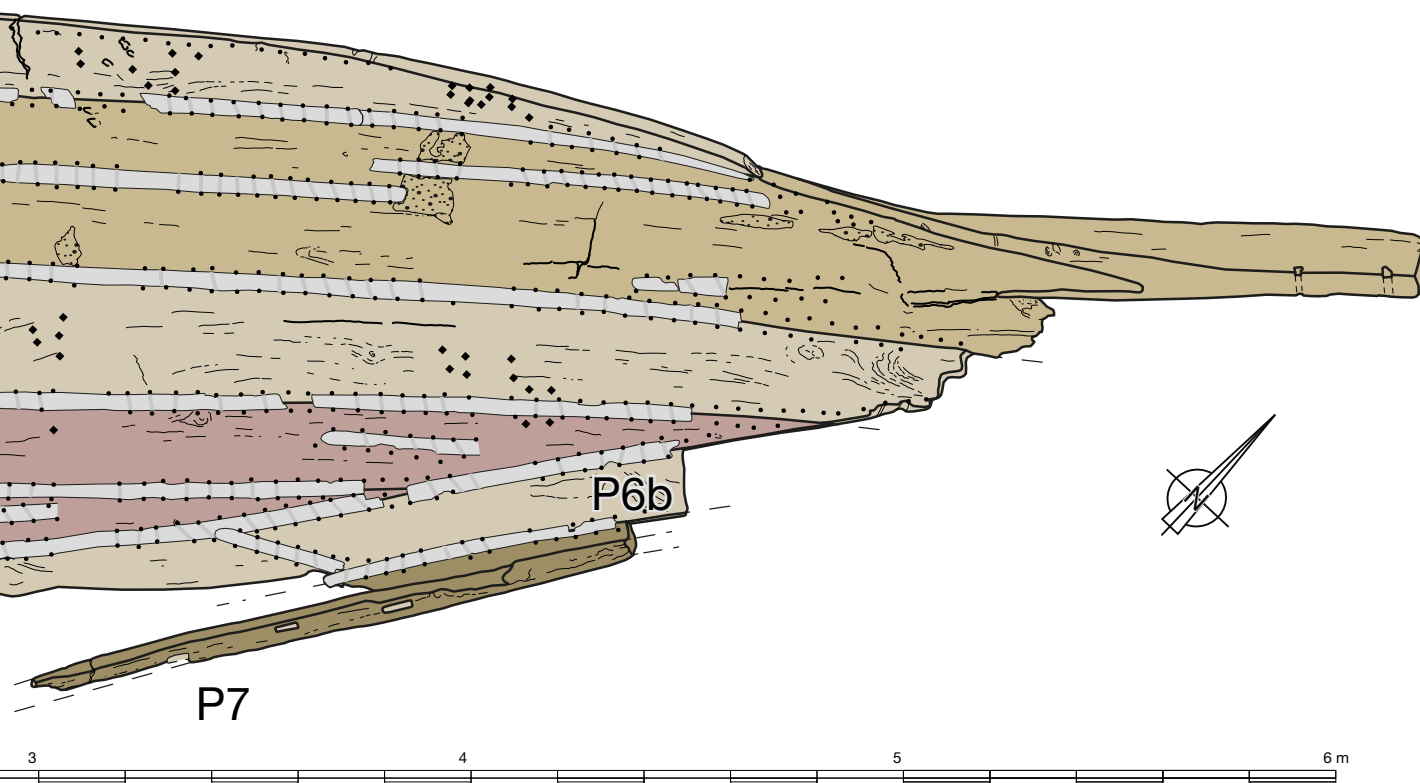

II.5

Šiljati sjeverni kraj kobličnog elementa, pogled sa sjevera
The pointed northern end of the keel-like timber viewed from the north
(fotografija / photo by: Ph. Groscaux)



II.5

II.6

Tragovi alatki vidljivi na unutrašnjoj površini šiljatog sjevernog kraja
The woodworking marks visible on the interior surface of the pointed northern end
(fotografija / photo by: Ph. Groscaux)



II.6



II.7

II.7

Detaljan prikaz para horizontalnih rupa izdubljenih na šiljatom kraju kobiličnog elementa

Detailed view of the pair of horizontal stitch holes carved in the pointed end of the keel-like timber
(fotografija / photo by: Ph. Groscaux)



II.8

II.8

Završni voj L profila i središnji dio broda, pogled sa sjevera

The L-shaped shearstrake and the central part of the wreck from the north
(fotografija / photo by: Ph. Groscaux)

II.9

Završni voj L profila i rebrenice R2 i R1
The L-shaped sheerstrake and the floor-timbers R2 and R1
(fotografija / photo by: Ph. Groscaux)

II.10

Četverokutni utori na gornjoj strani završnog voja L profila. Na fotografiji se s desne strane vidi gornji kraj rebrenice R1
The pair of rectangular holes carved in the upper face of the L-shaped sheerstrake. On the right side of the image, the top end of floor-timber R1 is visible
(fotografija / photo by: Ph. Groscaux)



II.9



II.10



II.11

Brodski vojevi od P3 (vrh) do završnog voja L profila P7 (dno). Vidi kosi spoj voja platica P6a i P6b te popravak pukotine u sredini platice P4. Bijele oznake nalaze se na pozicijama malih drvenih čavala koji su zaptivali rupe za šavove

The strakes from P3 (top) to the L-shaped sheerstrake P7 (bottom). Note the diagonal scar in the strake joining planks P6a and P6b, and the repair of a crack in the middle of plank P4. The white drawing pins indicate the position of pegs locking the stitches in place (fotografija / photo by: Ph. Groscaux)



razmakom od 6 cm od centra do centra čavla (između 4 i 8 cm). Razmak od ruba platica (sljubnice platica) je nepravilan, između 1,3 i 2 cm.

Tanka letvica od jele (*Abies alba*), širine 3-4 cm, položena je preko sljubnica prije šivanja radi učvršćenja sloja nepovezanih biljnih vlakana (Sl. II.11, II.12, II.21). Ovaj sloj napravljen je od nepovezanih biljnih vlakana. Pronađena biljna vlakna se mogu dovesti u vezu s morskom travom (*Cymodocea nodosa*) te, u manjoj mjeri, s mahovinom (*Neckera crispa*). Postoji razumna sumnja da je morska trava izvorno bila korištena kao materijal za postizanje vodonepropusnosti. Naime, korijenje ovih morskih biljaka prekrilo je brodsku konstrukciju i ušlo ispod letvice, zbog čega ga je prilikom istraživanja oplate bilo potrebno ukloniti.

softwood stems such as alder (*Alnus* sp.) and poplar (*Populus* L.), are semi-circular or triangular in section. They are 2.2-2.7 cm long, 6-8 mm wide, and 3-5 mm thick. They were driven from the inside of the hull at an average spacing (centre-to-centre) of 6 cm (range 4 to 8 cm). The distance from the edge of the planks is irregular and measures 1.3-2 cm.

Thin laths, 3-4 cm wide, made of fir (*Abies alba*), were placed over the seams before sewing to hold wadding (Figs II.11, II.12, II.21). Under the lath, some loose vegetal fibres were found mostly belonging to sea-grasses (*Cymodocea nodosa*) and, to a minor extent, to moss (*Neckera crispa*). Reasonable doubt exists about whether the sea-grass remains were part of the original material used for waterproofing. The roots of these marine plants covered the wooden structures and entered

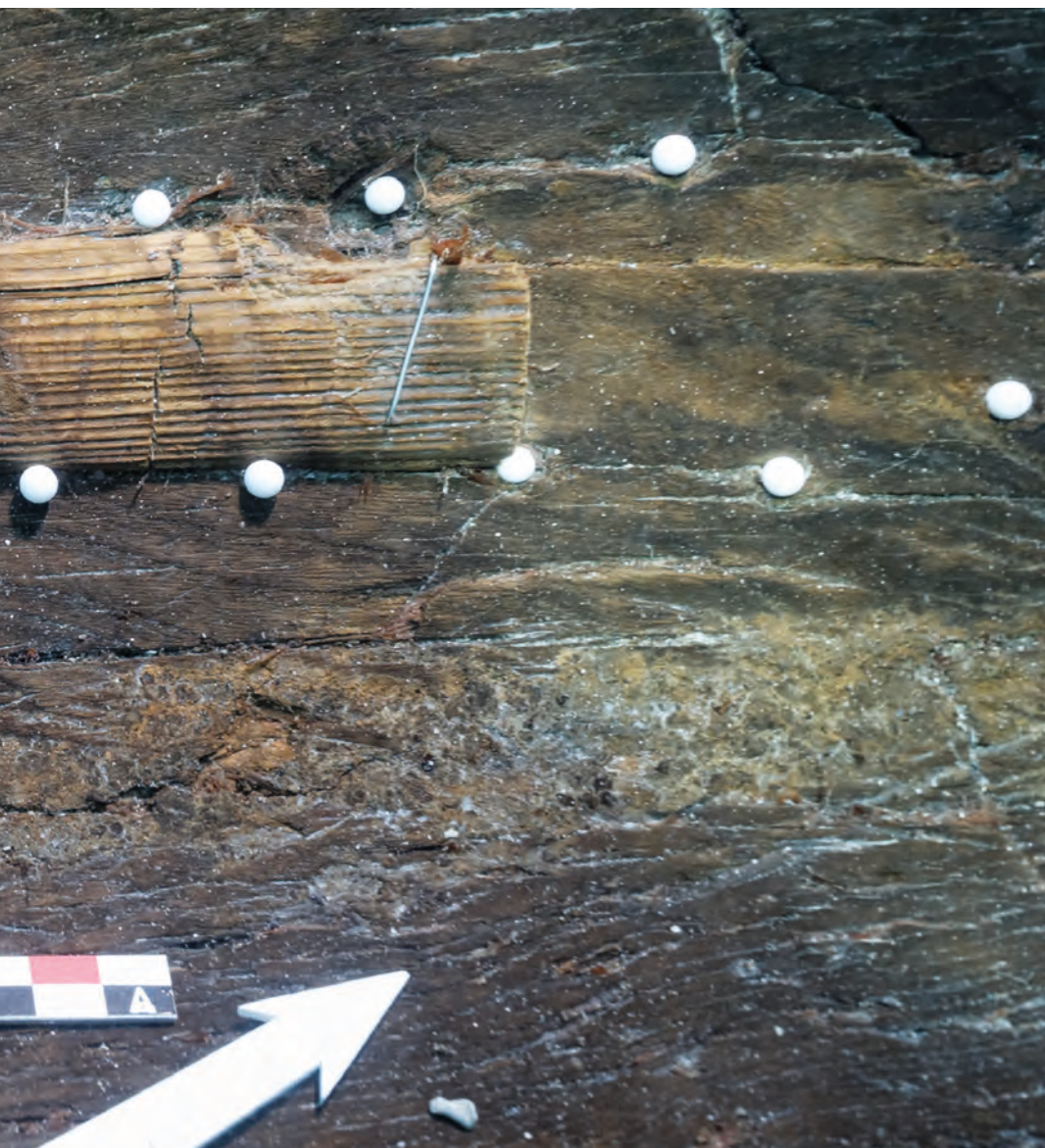

II.12

Detalj tragova od ligature na letvici postavljenoj preko sljubnica platica
Detail of the marks left by ligature on the laths placed over the seams
 (fotografija / photo by: Ph. Groscaux)

Neke pukotine na oplati (P4 i P5) i na kobiličnom elementu P2 također su bile popravljene jednakom tehnikom šivanja, kao i jednakom metodom brtvljenja i osiguravanja vodonepropusnosti plovila (Sl. II.2, II.22). Teško je ustanoviti jesu li ovi popravci napravljeni tijekom izgradnje broda ili za njegova radnog vijeka.

Između kobiličnog elementa P2 i platice P3 dvije letvice se preklapaju, što jasno ukazuje na popravke.

Pored letvica i umetnutog sloja biljnih vlakana, vodonepropusnost je dodatno osiguravao i zaštitni premaz paklinom na čitavoj unutarnjoj strani trupa.

under the laths making it necessary to cut during the cleaning of the hull.

Some cracks in the planking (P4 and P5) and the keel-like timber P2, were repaired using the same sewing technique and the same system of wadding and ensuring the watertightness of the vessel (Figs II.2, II.22). It is difficult to know if these repairs were done during the construction or later during the working life of the boat.

Between the keel-like timber P2 and plank P3, two laths are superposed at some points, clearly indicating repairs.

In addition to the laths and wadding, an interior coat of pitch ensured the hull was watertight.

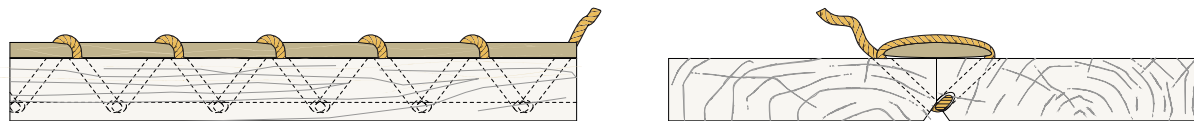

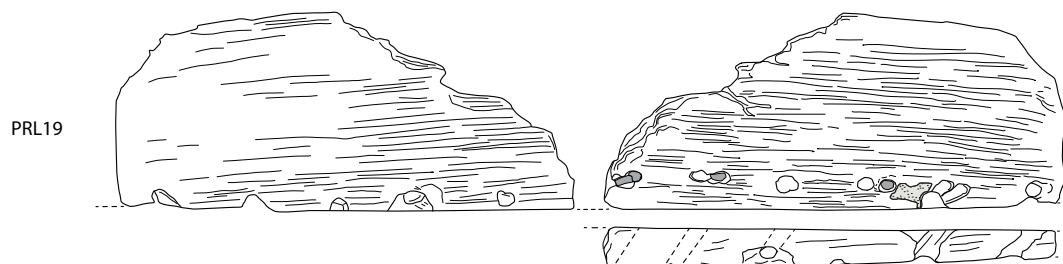
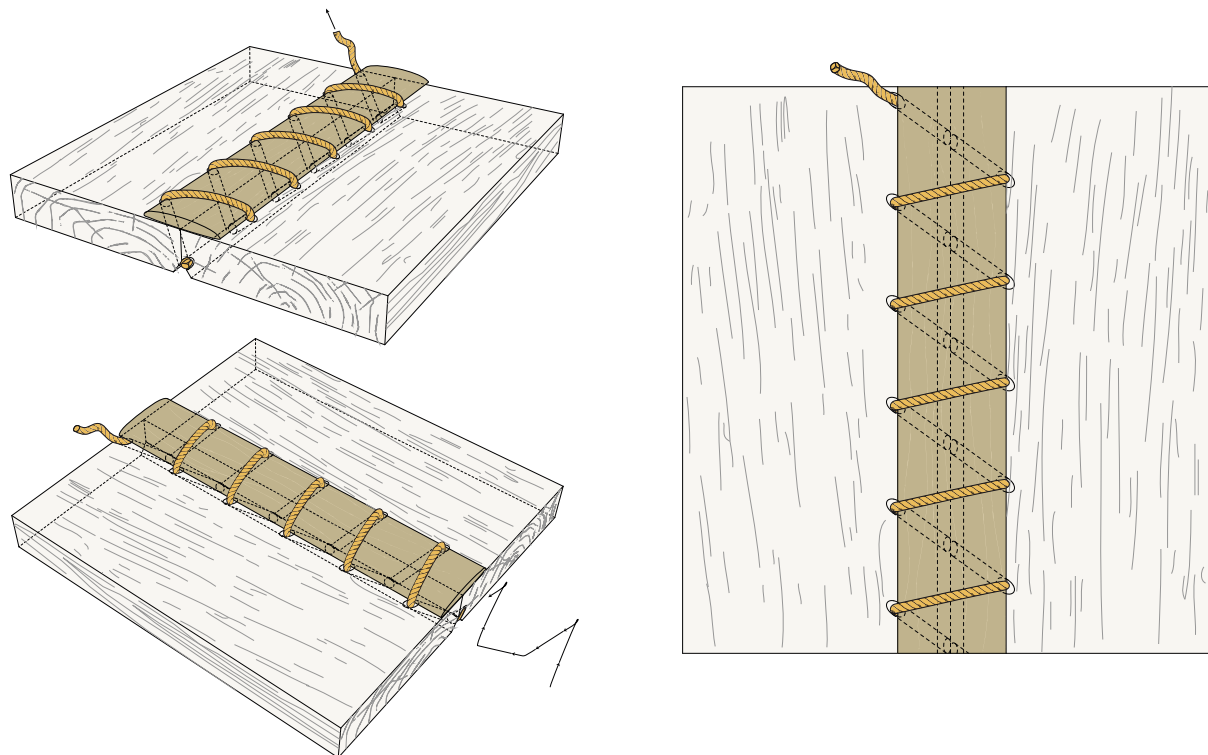

Il.13
Aksonometrijska rekonstrukcija
 sistema šivanja oplata
Axonometric reconstruction of the
 sewing system used for the planking
 (crtež / drawing by: P. Poveda)

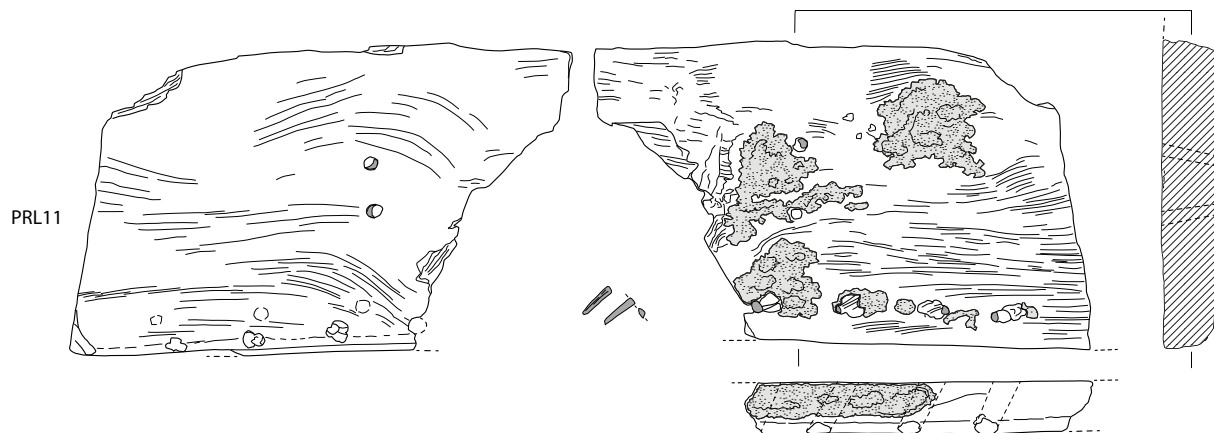

Il.14
Dva ulomka oplata, PRL19 i
 PRL11, izvađenih s nalazišta
Two planking fragments, PRL19
 and PRL11, recovered from the
 seabed
 (crtež / drawing by: G. Boetto)



0 10 20 cm
 © G. Boetto / CCJ / CNRS / 2016

 mali drveni čavao / peg
 paklina / pitch



II.15
Pogled na slomljeni kraj kobiličnog
 elementa P2 sa zakošenim rupama
 za šavove
View of the broken end of the
 keel-like timber P2 with oblique
 holes for stitches
 (fotografija / photo by: Ph. Groscaux)



II.16
Detaljni prikaz žljebova koji čine
 rupu na fragmentu platiće PRL19
Detail of the grooves composing a
 stitch hole on plank fragment PRL19
 (fotografija / photo by: Ph. Groscaux)

II.17

Detalj unutrašnjosti fragmenta platice PRL11 s duguljastim rupama. Vidljiva je prisutnost žućkaste pakline koja se koristila za zaštitu trupa

Detail of the interior of the plank fragment PRL11 showing the oblong stitch holes. Note the presence of yellowish pitch used to protect the hull
(fotografija / photo by: Ph. Groscaux)



II.18

Detalj zakošenog ruba platice PRL11

Detail of the outboard chamfered edge of plank fragment PRL11
(fotografija / photo by: Ph. Groscaux)





II.19

II.19
Detalj malog drvenog čavla koji je služio za zaptivanje šava, na fragmentu platiće PRL19
Detail of a peg used to lock the stitching on plank fragment PRL19
 (fotografija / photo by: Ph. Groscaux)

II.20
Mali drveni čavli za zaptivanje rupe šava
Pegs used to lock a stitch
 (fotografija / photo by: Ph. Groscaux)

II.21
Ulomak letvice s ostatkom biljnog materijala koji je korišten za osiguravanje vodonepropusnosti sljubnica
Fragment of a lath with remains of the vegetal fibres used for waterproofing
 (fotografija / photo by: Ph. Groscaux)



II.20



II.21





II.22
 Pogled na popravak pukotine u sredini kobiličnog elementa P2
 View of the crack repairs in the middle of keel-like timber P2
 (fotografija / photo by: Ph. Groscaux)

Rebra

Tri rebrenice (R1, R2 i R3) pronađene su *in situ*, a identificirana je pozicija još tri rebra, jednog na sjeveru (R0) i dva na jugu (R4 i R5) (Sl. II.23). Istočna strana rebara očuvana je do vrha, dok je njihov zapadni dio samo dijelom očuvan (Sl. II.24 – II.26).

Rebrenice su široko razmaknute (oko 83 cm u prosjeku) i imaju trapezoidni presjek (prosječne širine 8,4 cm i prosječne visine 11,3 cm) s uskom donjom stranom i zaobljenim širim gornjim dijelom (Sl. II.27). Dvije rebrenice su izrađene od joha (*Alnus* sp.) (R1 i R3), a treća (R2) od drva divlje kruške (*Pyrus communis* L.).

Donja strana rebrenica je ravna i oblikovana tako da odgovara unutrašnjoj strani oplata (Sl. II.28). Neki od vidljivih malih tragova na donjoj strani vjerojatno su nastali kontaktom između rebrenice i letvica.

Pored toga, na donjem dijelu rebrenica nalaze se slivnice koje omogućavaju protok kaljužne vode. Rebrenica R1 ima jednu kvadratnu slivnicu (široku 2,6 cm i visoku 1-1,6 cm) (Sl. II. 29 – II. 32), dok rebrenica R2 ima dvije trapezoidne slivnice koje su međusobno razmaknute 16 cm (široke su 3 cm, a visoke 1,1-1,8 cm) (Sl. II. 33, II.34). Na rebrenici R3 nisu bile izrađene slivnice.

The frames

Three floor-timbers (R1, R2 and R3) were found *in situ*, and traces of three additional frames were identified, one at the north (R0), and two at the south (R4 and R5) (Fig. II.23). The tops of the eastern arms are preserved, while the western arm is broken (Figs II.24 – II.26).

Widely spaced (around 83 cm on average), these floor-timbers have a trapezoidal section (8.4 cm wide, 11.3 cm high on average) with a narrow foot and a rounded, wider upper surface (Fig. II.27). Two of these frames (R1 and R3) are made of alder (*Alnus* sp.), while the third (R2) was obtained from a wild pear tree (*Pyrus communis* L.).







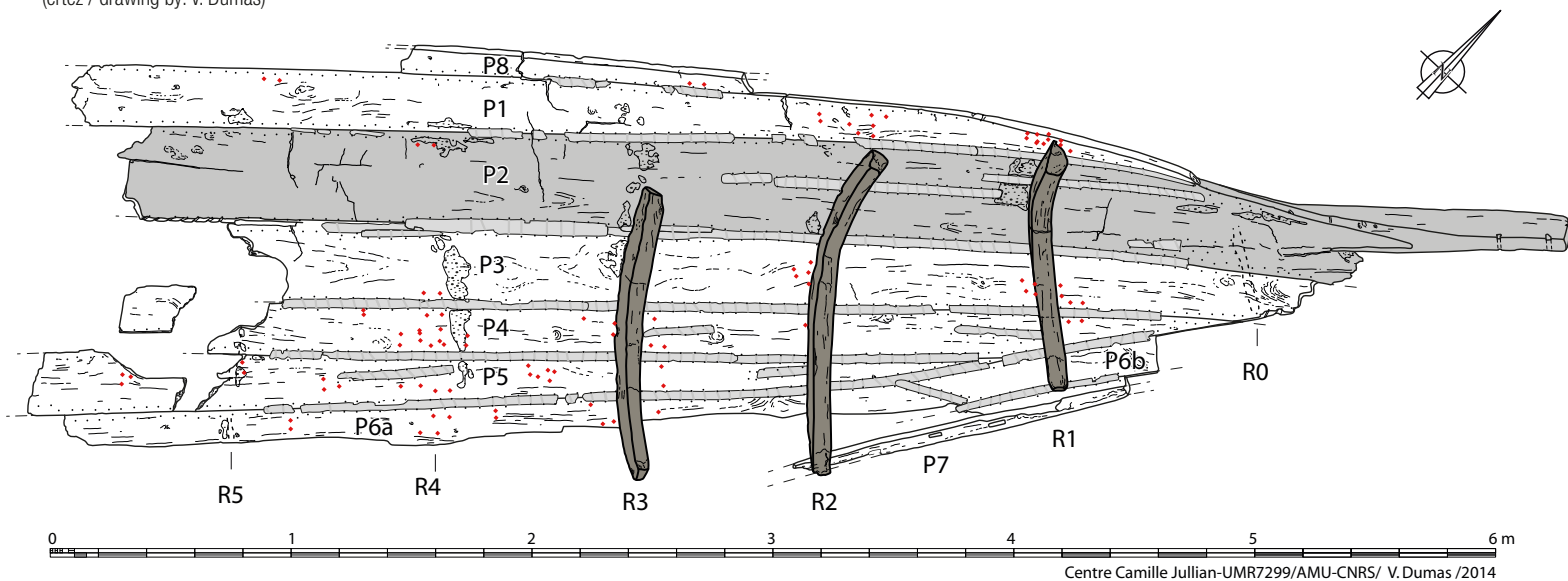

The lower face of the floor-timbers is smooth and shaped to match the inner surface of the planking (Fig. II.28). Fine marks visible on the lower face may have been produced by friction between the frames and the laths.

Additionally, the foot of each floor-timber was carved with limber holes, allowing the circulation of bilge water. Floor-timber R1 has a single quadrangular central limber hole (2.6 cm wide, 1-1.6 cm high) (Figs II.29 – II.32), while floor-timber R2 has two trapezoidal limber holes spaced 16 cm apart and 3 cm wide, 1.1-1.8 cm high (Figs II.33, II.34). No limber holes are present in floor-timber R3.

II.23
Brodsko rebra
The frames
(crtež / drawing by: V. Dumas)



Centre Camille Jullian-UMR7299/AMU-CNRS/ V. Dumas /2014

- | | | | |
|---|--|---|--|
|  rebrenica / floor-timber |  osni element / axial element |  paklina / pitch |  tragovi šivanja / sewing trace |
|  začepljene rupe / plugged holes |  oplata / planking |  letvica / lath |  mali drveni čavao / peg |



II.24
Pogled s juga na tri sačuvane rebrenice
View from the south of the three preserved floor-timbers
(fotografija / photo by: Ph. Groscaux)

II.25
Potpuno sačuvani istočni kraj
rebrnice R1
The complete eastern end of
floor-timber R1
(fotografija / photo by: Ph. Groscaux)



II.25

II.26
Uništeni zapadni kraj
rebrnice R1
The broken western end
of floor-timber R1
(fotografija / photo by: Ph. Groscaux)



II.26



II.27



II.28

II.27
Trapezoidni presjek s uskom bazom i zaobljenom gornjom površinom rebrenice R1
The trapezoidal section with a narrow foot and rounded upper surface of floor-timber R1
 (fotografija / photo by: Ph. Groscaux)

II.28
Tragovi obrade drva na bočnoj strani i bazi rebrenice R1
Woodworking marks on the side and foot of floor-timber R1
 (fotografija / photo by: Ph. Groscaux)

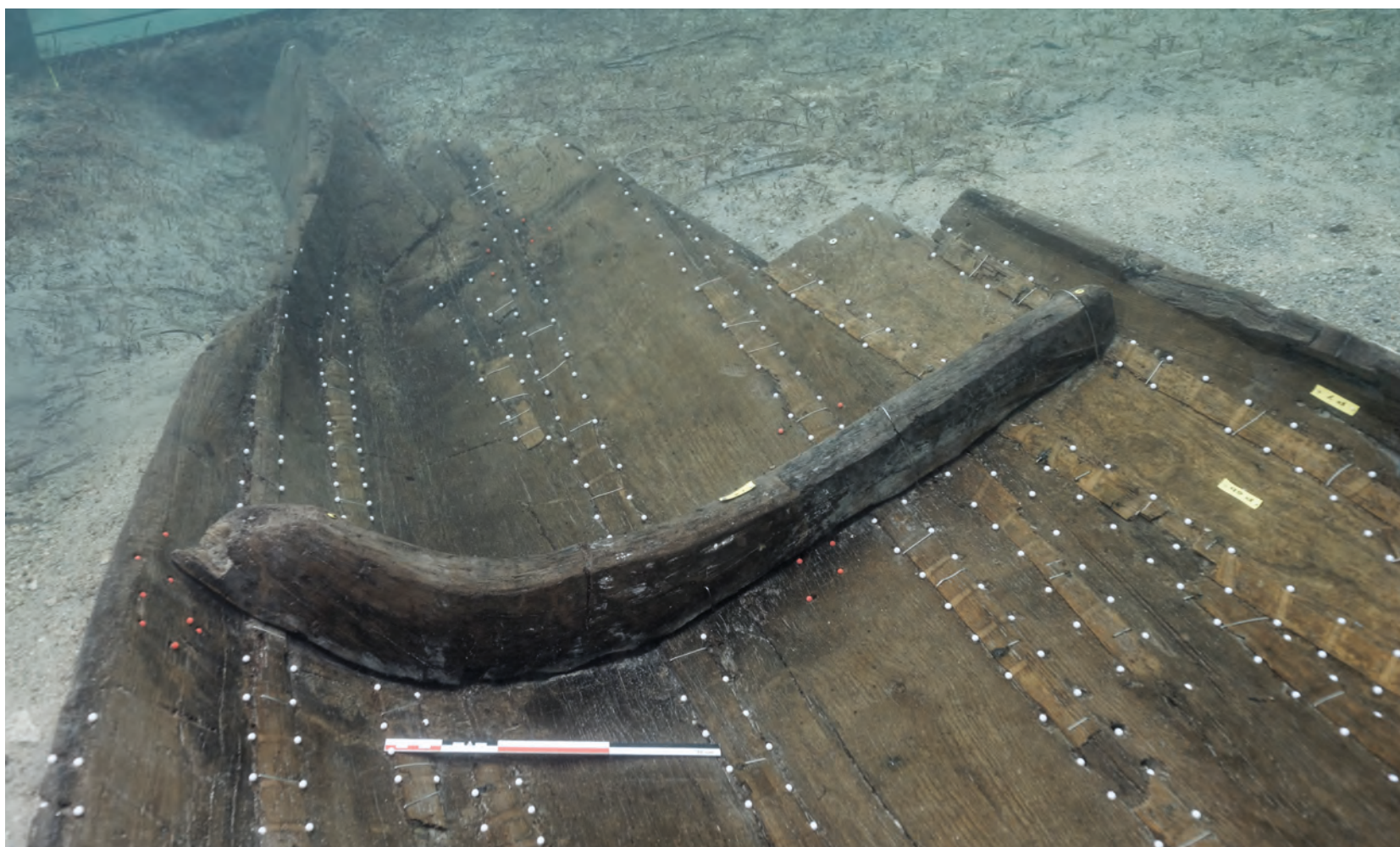

II.29

II.29
Pogled s juga na rebrenicu R1
View from the south of floor-timber R1
 (fotografija / photo by: Ph. Groscaux)

II.30
Četverokutna središnja slivnica
rebrenice R1
The quadrangular central limber
hole of floor-timber R1
(fotografija / photo by: Ph. Groscaux)



II.30

II.31
Četverokutna središnja slivnica
rebrenice R1
The quadrangular central limber
hole of floor-timber R1
(fotografija / photo by: Ph. Groscaux)



II.31

Površina rebrenica je pažljivo obrađivana i vidljivi su mnogobrojni tragovi alata, vjerojatno sjekire (Sl. II.28, II.31). Upotreba dlijeta i drugih sječiva potvrđena je za potrebe izrade slivnica (Sl. II.32, II.34).

The surface of the frames is carefully worked and many tool marks left by the axes used are evident (Figs II.28, II.31). The use of chisels and other cutting blades is attested in particular for fashioning the limber holes (Figs II.32, II.34).

Spajanje rebara za oplatu

Rebrenice nemaju rupe za čivije, čavle ili šavove što znači da su izvorno bile privezane za oplatu sustavom vanjskog vezivanja. Ove ligature, koje se nisu očuvale, prolazile su kroz koso probušene rupe u platicama,

Fastening the frames to the planking

The floor-timbers lack holes for treenails, nails or stitches, and were originally lashed to the planking. The lashings did not survive, but are indicated by holes cut obliquely through the planks and pegs that locked them in place



II.32

II.32
Tragovi obrade na četverokutnoj središnjoj slivnici rebrenice R1
Woodworking marks on the quadrangular central limber hole of floor-timber R1
 (fotografija / photo by: Ph. Groscaux)



II.33

II.33
Pogled s juga na rebrenicu R2. Dvije slivnice su vidljive na njenom dnu
View from the south of floor-timber R2. The two limber holes are visible at its base
 (fotografija / photo by: Ph. Groscaux)



II.34

II.34
Par četverokutnih slivnica na rebrenici R2
Detail of the pair of rectangular limber holes of floor-timber R2
 (fotografija / photo by: Ph. Groscaux)

II.35

Fragment platice PRL11 s vidljivim rupama za šavove i parom rupa u sredini za vezanje rebra

Plank fragment PRL11 showing the stitch holes near the edge and a pair of holes used for lashing the frame in place at its centre

(fotografija / photo by: Ph. Groscaux)

II.36

Detalj para zakošenih rupa na unutrašnjoj površini platice PRL11, korištenih za vezanje rebra

Detail of the pair of oblique holes used for lashing the frame in place on the interior surface of plank fragment PRL11

(fotografija / photo by: Ph. Groscaux)

a zatim su zaptivene malim drvenim čavlima (Sl. II.35 – II.38). Uzduž rebrenica su identificirane koncentracije probušenih rupa (Sl. II.23), ali bez detaljne analize oplate nije ih moguće rekonstruirati, barem ne prije no što se platice podignu s morskog dna. Ipak, dislocirani komad oplate (PRL19) koji je bio izvađen s morskog dna na sreću ima očuvan jedan par rupa kroz koje je prolazila ligatura. Unutarnji promjer ovih rupa (8 mm) je malo veći od vanjskog promjera (6-7 mm), tako da je razmak između ovog para rupa s unutarnje strane platice 2,4 cm, a vanjske 3,5 cm. Vezivanje je izvedeno jednostavno, a izvana rupe nisu povezane utorom koji štiti ligature.

Sustav vezivanja rebrenica potvrđen je prisutnošću žlijeba u obliku slova V, dubokog 5 mm, a vidljivog na vrhu rebrenice R3. Također su tijekom istraživanja primijećeni slabo vidljivi križni tragovi preko rebrenica, koji su nestali ubrzo nakon što je drvo otkriveno.

(Figs II.14, II.35 – II.38). Groups of plugged holes in the planking were observed along the frames (Fig. II.23), but the reconstruction of the lashing pattern is not possible without a more detailed observation of the wooden remains, which will be possible only after the planks are raised from the seabed. Nevertheless, the displaced plank fragment (PRL19), which was retrieved from the seabed, fortunately retained a pair of lashing holes. These holes have an inboard diameter (8 mm) slightly bigger than the outboard diameter (6-7 mm), so the space between them is 2.4 cm inboard and 3.5 cm on the outboard face of the plank. The lashing seems to be very basic, and on the outer face the holes are not joined by a groove that would protect the lashing.

The lashing of the frames is confirmed by a groove with an open V section, and a depth of 5 mm, visible near the top of the floor-timber R3. Some other faint traces, not easily visible, that appeared to mark a cross over the frames, unfortunately vanished as soon as the wood was uncovered.

II.35



II.36



Princip konstruiranja, proces gradnje i arhitektonski tip

Nema sumnje da se princip konstruiranja broda pronađenog u Zambratiji temelji na konceptu ljuske za strukturu i formu trupa. Vojevi determiniraju formu broda, a rebra imaju sekundarnu ulogu unutar brodske strukture. Proces gradnje podrazumijevao je da se prvo oformi ljuska, što je ujedno i jedini proces koji je omogućavao uzdužno šivanje oplata¹.

Plovilo iz Zambratije najstariji je primjer u potpunosti šivanog broda ikad pronađen u Mediteranu, a datiran je u vrijeme između posljednje četvrtine 12. i posljednje četvrtine 10. st. pr. Kr. Njegova arhitektonska rješenja i gradnja, tehnika šivanja i spajanja dijelova oplata, kao i sustav vodonepropusnosti samog trupa, također nemaju paralela na širem području Mediterana.

Arhitekturu broda Zambratija karakteriziraju sljedeće značajke:

- izrezbaren kobilični element;
- oplata, uključujući završni voj L-profila te stično položena i spojena uzdužnim šivanjem;

¹ Za različite koncepte principa i metodu gradnje te arhitektonske tipove vidi Pomey 2004a; Pomey, Rieth 2005, 29-33 te Pomey *et al.* 2012, 2013.

Construction principle, building process and architectural type

There is no doubt that the construction principle used for the Zambratija vessel is based on a shell concept for the hull structure and shape. The strakes determine the boat's shape, and the frame plays a secondary role in the boat's structure. The building process is shell first. Indeed only a shell-first process is compatible with longitudinal sewn planking¹.

The Zambratija vessel is the most ancient example of an entirely sewn boat ever found in the Mediterranean, as it has been dated between the last quarter of the 12th and the last quarter of the 10th centuries BCE. Its construction is unparalleled at this date, as is the sewing technique employed to assemble the planking and the system of wadding and laths used to render the vessel watertight.

The architectural type of the Zambratija boat is characterized by:

- a carved keel-like timber;
- planking, including a carved L-shaped sheerstrake,

¹ For the different concepts of principle and method of construction and architectural types, see Pomey 2004a; Pomey, Rieth 2005, 29-33; and, finally, Pomey *et al.* 2012, 2013.

II.37

Vanjska strana fragmenta platice PRL11 s rupama za šavove, koji završavaju na zakošenom rubu platice, te par rupa za vezivanje brodske rebra

The outer side of plank fragment PRL11 showing the stitch holes ending in the chamfered plank edge, and the pair of holes for lashing the frame in place (fotografija / photo by: Ph. Groscaux)

II.38

Detalj para zakošenih rupa na unutrašnjoj površini platice PRL11, korištenih za vezanje rebra

Detail of the pair of oblique holes used for lashing the frame in place on the outside surface of plank fragment PRL11 (fotografija / photo by: Ph. Groscaux)



II.37



II.38

- rebra koja se sastoje od široko razmaknutih rebrenica trapezoidnog presjeka, uske baze i zaobljene široke gornje strane, vezana za oplatu;
- zaobljeni središnji poprečni presjek trupa; uzdužni presjek s blagim povišenjem prema zašiljenom kraju.

Velika znanstvena važnost broda Zambratija leži u njegovoj osebujnoj konstrukciji. U naravi, to je primjer rane faze građenja brodova platicama, koji vuče porijeklo iz monoksila dograđenim vojevima. Umjesto uobičajene kobilice ili središnje ravne platice, uzdužni osni element ovog broda izdubljen je od debla brijesta, što izravno upućuje na monoksilni izvor. Međutim, ako promatramo cijeli oblik kobilicnog elementa s njenim ravnim središnjim dijelom, vidljivo je da ovaj brod ima izvor u razvijenom monoksilu s dograđenim vojevima.

Brod Zambratija svjedoči o razvoju brodova s izgrađenom oplatom iz monoksila. Njegov kobilicni element služi kao strukturalna baza za dogradnju oplata vojevima od brijesta. U ovoj fazi istraživanja ne možemo odgovoriti na pitanje je li monoksilni kobilicni element izdubljen u svoju formu ili je umjetno proširen savijanjem stranica uz pomoć vatre i vode. To ostaje otvoreno za buduća istraživanja.

Iako se čini da je većina malih zaptivenih rupa povezana s vezivanjem rebara i oplata, neke su od njih također mogle biti korištene za kontroliranje debljine, što predstavlja tipičnu karakteristiku proširenih monoksila (Van de Moortel 2003, 184-185).

S druge strane, tehnika šivanja koja je korištena za spajanje oplata i s njom povezan sustav vodonepropusnosti također nema paralela i karakteriziraju ih sljedeće odlike:

- koso izbušene rupe usmjerene dijagonalno na rubove platica, koje završavaju u zakošenju vanjskog ruba sljubnica;
- jednostavan nepravilan rubni uzorak šivanja (///);
- drvene letvice korištene za učvršćenje sloja biljnih vlakana;
- mali drveni čavli koji zaptivaju šavove;
- zaštitni premaz paklinom koji štiti trup broda.

Zbog svih ovih karakteristika konstrukcije, tipa gradnje i rane datacije, brod Zambratija može se smatrati arhetipom tradicije šivane brodogradnje na prostoru Jadrana. Tehnika izgradnje broda šivanjem preživjela je sve do kasne antike odnosno ranog srednjeg vijeka, kako potvrđuju nalazi šivanih brodova na prostoru Italije, od ušća rijeke Po do Akvileje, na području rijeke Ljubljanice u Sloveniji te u Hrvatskoj, gdje je u Istri (Pula) i u Dalmaciji (Caska i Zaton) pronađeno osam takvih brodova, datiranih u vrijeme između 1. i 2. stoljeća.

flush-laid and assembled by longitudinal sewing;

- frames composed by widely spaced floor-timbers, trapezoidal in section, with a narrow foot and a rounded, wider upper surface, that were lashed to the planking;
- a rounded mid section, and a gentle longitudinal rise to a pointed end.

The high scientific value of the Zambratija boat lies in its unusual construction. It is, in fact, an example of an early stage of planked boatbuilding, which originated in extended logboats. Instead of a traditional keel or a flat central-plank, it has an axial element carved from an elm trunk, a direct descendant of a logboat. But, considering the shape of the keel-like timber on the whole with its flat mid-section, this boat type has its origins in a developed, extended logboat.

Indeed, the Zambratija boat testifies to the development of plank-built boats from logboats. Its keel-like timber serves as a structural base for the planking, made by the addition of elm strakes. At this stage of research, the question of whether the logboat keel-like timber was entirely carved into shape or whether it was expanded, that is, widened by artificially bending out the sides using fire and water, remains open and requires further research.

Although most of the small plugged holes seem to be related to lashing the frames in place, some of them could have been used as gauges: holes used to check the thickness of the base are typical features of expanded logboats (Van de Moortel 2003, 184-185).

On the other hand, the sewing technique employed to assemble the planking and the waterproofing system, is also unparalleled and is characterized by:

- oblique stitch holes cut diagonally to the plank edge and ending in a chamfer along the outboard plank edge;
- a simple irregular over-edge sewing pattern (///);
- wooden laths to hold wadding composed of vegetal fibres;
- pegs to lock each stitch in place;
- a coat of pitch to protect the hull.

Due to these construction characteristics, the type of assemblage, and the early date of the boat, the Zambratija boat could be considered an archetype of the sewn-boat traditions found in the Adriatic geographical zone. Sewn construction techniques survived until the Late Roman-Early Middle Ages, as demonstrated by the discovery of a series of sewn boats in Italy, from the Po delta to Aquileia, in the river Ljubljanica in Slovenia, and in Croatia where eight wrecks dated from the 1st to the 2nd centuries CE were found in Istria, in Pula, and in Dalmatia, at Caska and Zaton.

Zaključak

Na kraju druge kampanje istraživanja broda Zambratija, prikupljeno je mnogo podataka što je omogućilo inicijalnu detaljnu analizu strukture trupa. Ipak, ovo istraživanje otvorilo je i mnoga pitanja na koja će se moći odgovoriti tek daljnjim dobro isplaniranim istraživanjima koja uključuju i vađenje svih ostataka broda te analiziranjem istih u laboratoriju.

Takva buduća istraživanja pomogla bi u istraživanju sustava vodonepropusnosti broda u smislu utvrđivanja prisutnosti materijala za brtvljenje unutar sljubnica ili utvrđivanja prisutnosti premaza paklinom na vanjskoj strani trupa ili na zakošenim vanjskim rubovima platica u kojima se nalaze šavovi.

Također, nova istraživanja omogućila bi cjelovitu analizu drva, ne samo zbog preciznijeg datiranja konstrukcije, već i s ciljem da se bolje prouče faze gradnje od debla do završenih arhitektonskih dijelova. Također bi bilo moguće detaljno proučiti tragove alata korištenih pri gradnji. Nadalje, analiza unutarnje strukture drva i, preciznije, njegovih medularnih zraka i uzdužnih ćelija pomogla bi da se napokon odgovori na važno pitanje – je li brod Zambratija baziran na proširenom monoksilu ili ne².

Na kraju valja zaključiti da otkriće broda u uvali Zambratija čini polazišnu točku za istraživanje porijekla i razvoja platicama građenih brodova na Mediteranu. On je potpora teorijama Basila Greenhilla (1976) i njegovog prethodnika Jamesa Hornella (1974) o porijeklu brodova građenih platicama iz četiri izvora primitivnih plovila (splav, brod od kože, brod od okorine i monoksil).

Plovilo iz Zambratije pruža prvi arheološki dokaz o ulozi monoksila kao temelja prema razvoju brodova građenih platicama na sjevernom Sredozemlju te osobito sjeveroistočnom Jadranu³.

Conclusion

At the end of the second season of excavation of the wreck, a large amount of data has been collected providing an initial detailed study of the hull structure of the Zambratija boat. However, this study has also raised a series of new questions that only further programmed research that will incorporate the recovery of the entire remains of the vessel and their analysis in the laboratory, will be able to answer.

Future research would enable the waterproofing system to be investigated further, such as the presence or absence of luting material between the seams, or whether an outer coat of pitch covers the outboard face of the planking and the plank-edge chamfers in which the sewing runs.

Also, future research would permit a complete study of the wood, not only to obtain a precise date for the construction, but also to better study the boatbuilding phases from log to finished pieces. It would also be possible to study in detail marks left on the wood by the tools used for this work. Moreover, the study of the internal structure of the wood, and more precisely its medullary rays and longitudinal cells, would finally help in answering the crucial question of whether the Zambratija boat is or is not based on an expanded logboat².

In conclusion the discovery of the Zambratija wreck constitutes a milestone in the study of the origin and development of plank-built boats in the Mediterranean. It follows the theories of Basil Greenhill (1976) and, before him, of James Hornell (1946), about the derivation of fully plank-built boats from in four primitive watercrafts (the raft, the skin boat, the bark boat, and the logboat).

The Zambratija vessel provides the first archaeological evidence of the logboat's role as a root in the development of fully planked boats in the northern Mediterranean and, more particularly, within the north-eastern Adriatic maritime area³.

2 Analiza drvenih ostataka broda iz Utrechta (997. god., Nizozemska) omogućila je A. Van de Moortelu (2003, 185-188, sl. 28.5-7) da ga identificira kao prošireni monoksil koji predstavlja primjer brodogradnje u prijelaznoj fazi između monoksilnih konstrukcija i izgradnje brodova u cijelosti od platica.

3 Zanimljivo je napomenuti da je upotreba monoksila te monoksila s dograđenim vojevima tradicija koja se zadržala na hrvatskoj obali kroz razdoblje srednjeg vijeka te sve do današnjeg vremena. Ova plovila, korištena za ribolov, najčešće su se nazivala *ladva*, *lada* ili *copul* (Radić Rossi 2009, 134-136).

2 The study on the wooden structure of the Utrecht ship (997 CE, The Netherlands) allowed A. Van de Moortel (2003, 185-188, fig. 28.5-7) to identify it as an expanded logboat, reflecting a building tradition at an intermediary stage between logboat construction and the production of fully plank-built vessels.

3 It's interesting to note that the use of logboats and, then, of extended logboats, persisted along the Croatian coast throughout medieval till modern times. These vessels, used for the purpose of fishing, were usually called *ladva*, *ladja* or *copul* (Radić Rossi 2009, 134-136).