

F2079

US 2079-2 CAMP-B? Lot 85 C6



1

US 2079-2 Lot 85 CL-REC C5

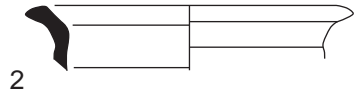

2

F2070

US 2070-5 Lot 83 A-ITA C48



3

US 2070-2 Lot 79 CAMP-A C47



4

F1054

US1054-2 Lot 111 PF C10



5

F1059

US1059-2C-9 CL-REC

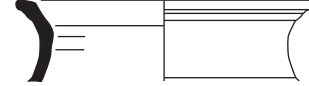

6

Ech 1:3  
0

15 cm

F2015

F2015 US2015-5 Dolium C10

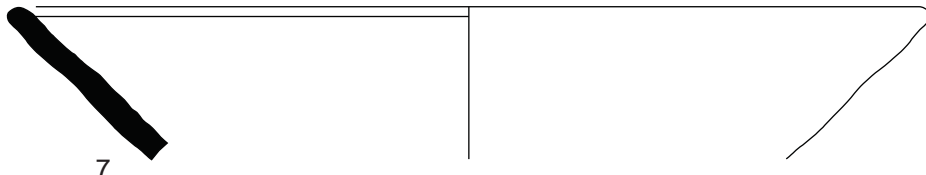

7

Ech 1:5  
0

25 cm

ARCHEODUNUM

Marignane (13) - RD20e - liaison RD9-RD48  
OA n° 11338 (2016)

Planche 4 : céramique datée de la fin de l'âge du Fer. Échelle : 1/3 (sauf n° 7 : échelle 1/5).  
Dessin et DAO : A. Gilles.

US 2015-5 Lot 62 A-MGR C42

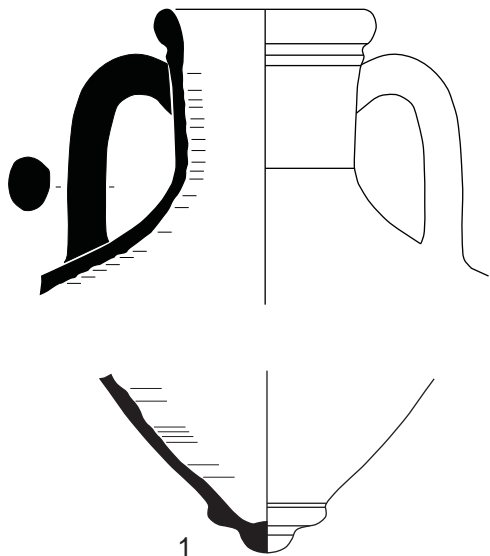

1

Ech 1:5  
0 25 cm

US 2015-5 Lot 62 A-ITA C41

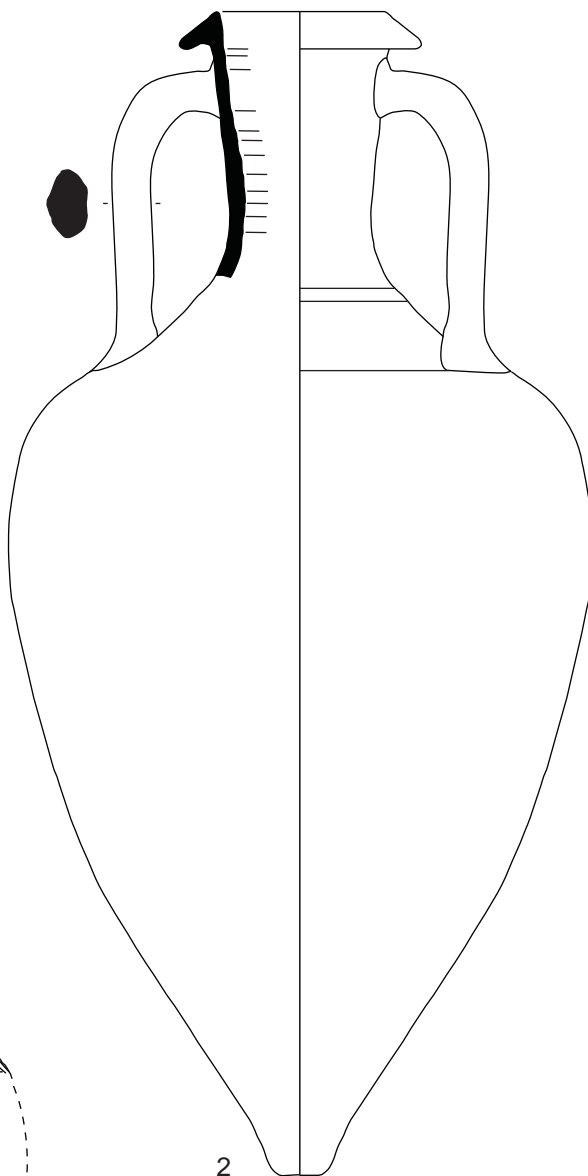

2

US 2015-5 Dolium C11

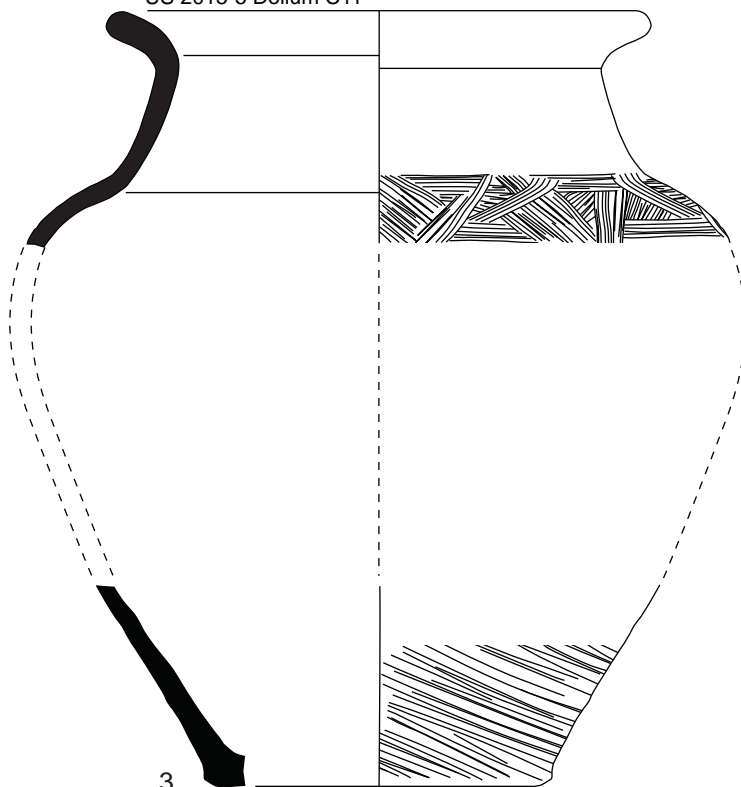

3

US 2015-5 Lot 64 CL-REC C41

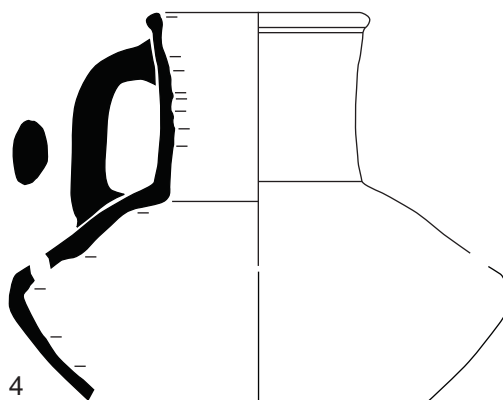

4

Ech 1:3  
0 15 cm

ARCHEODUNUM

Marignane (13) - RD20e - liaison RD9-RD48  
OA n° 11338 (2016)

Planche 5 : céramique issue de la structure F.2015. Échelle : 1/5 (sauf n° 4 : échelle 1/3).  
Dessin et DAO : A. Gilles.

F1063 US 1063-2 Lot 23 TS SG C35



F1004 US1004-5 Lot 2 TS-SG C12

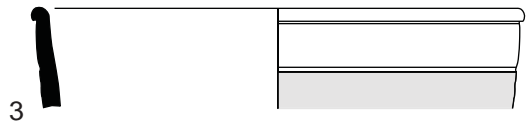

F1063 US 1063-2 Lot 23 TS SG C39

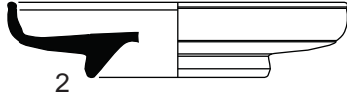

F1004 US1004-5 Lot 5 TS-SG C18

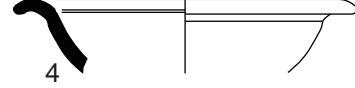

F1063 US 1063-2 Lot 23 TS SG C36

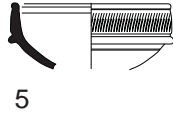

F1063 US 1063-2 Lot 23 TS SG C37

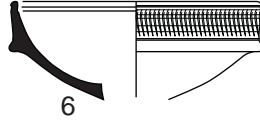

F1004 US1004-5 Lot 5 TS-SG C17

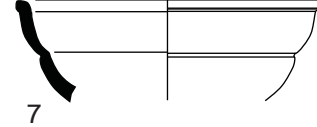

F1063 US 1063-2 Lot 23 TS SG C38

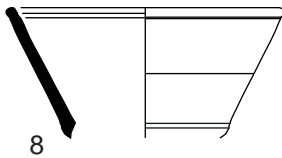

F1063 US1063-2 Lot 19 PF C31

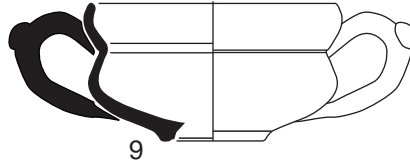

F1063 US1063-2 Lot 18 COM-CALC C30

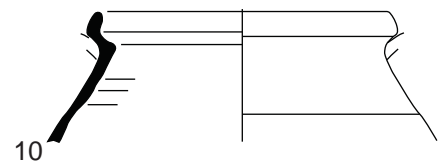

F1073 US1063-2 Lot 19 Cl. eng. C32

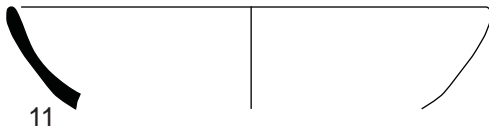

F2086-2 Lot 67 COM-CALC C40

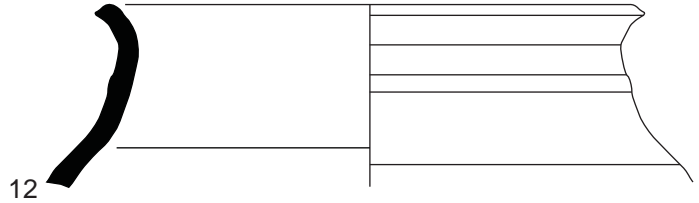

F1004 US1004-5 Lot 12 COM-CALC C27

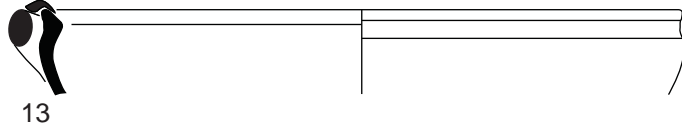

F1063 US 1063-2 CL-REC Lot 18 C29

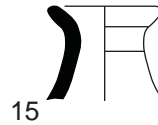

F1004 US1004.5 Lot 1 TG C11



F1063 US1063-2 Lot 18 COM-CALC C28

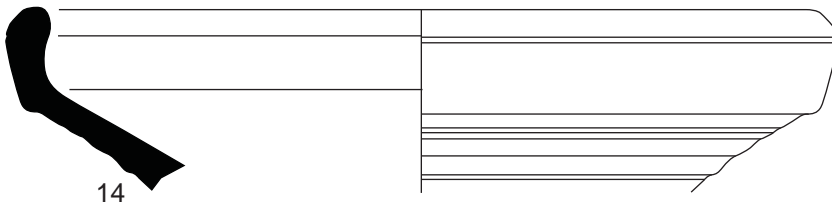

F1004 US1004.5 Lot 5 KAOL C13

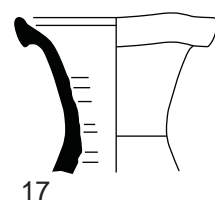

F1004 US1004-5 Lot 5 Brune pro. C16



F1004 US1004-5 Lot 5 TG C15

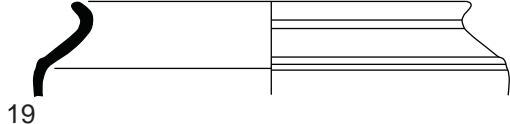

F1004 US1004.5 Lot 5 AF-CUI C14

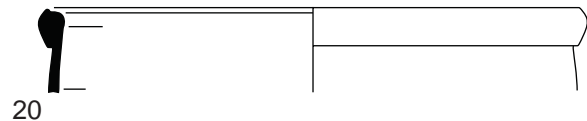

Ech 1:3

0 15 cm

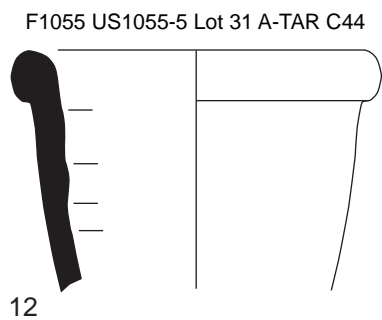
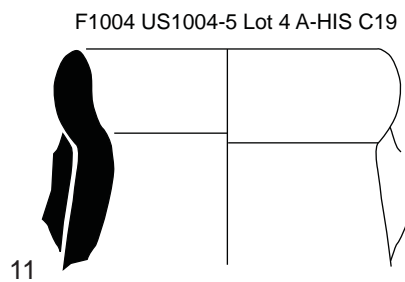
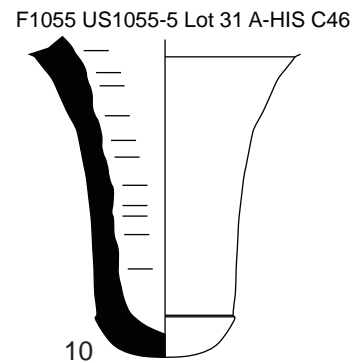
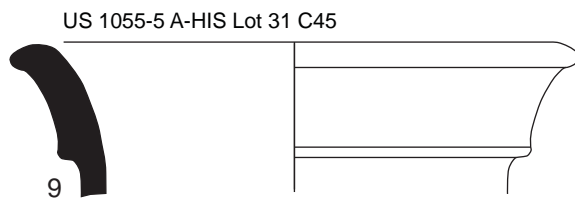
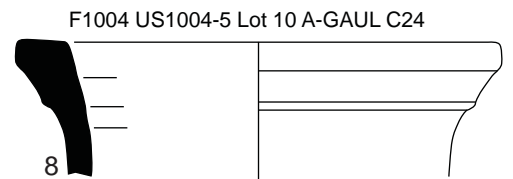
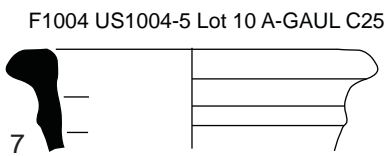
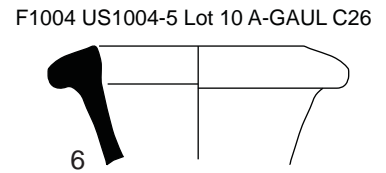
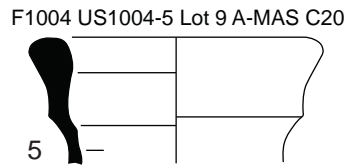
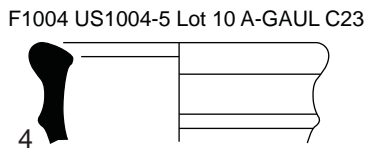
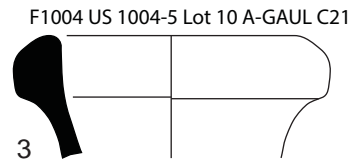
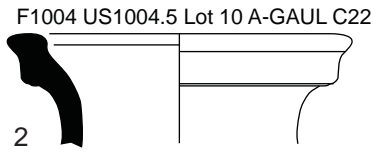
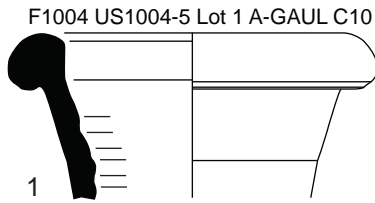

**ARCHEODUNUM**

Marignane (13) - RD20e - liaison RD9-RD48  
OA n° 11338 (2016)

**Planche 7** : amphores liées à l'occupation gallo-romaine. Échelle : 1/3. Dessin et DAO : A. Gilles.