



**HAL**  
open science

# Open Sea, Closed Sea. Local Traditions and Inter-Regional Traditions in Shipbuilding, Proceedings of the Fifteenth International Symposium on Boat and Ship Archaeology

Giulia Boetto, Patrice Pomey, Pierre Poveda

► **To cite this version:**

Giulia Boetto, Patrice Pomey, Pierre Poveda. Open Sea, Closed Sea. Local Traditions and Inter-Regional Traditions in Shipbuilding, Proceedings of the Fifteenth International Symposium on Boat and Ship Archaeology. 2018, Marseille, France. *Archaeonautica*, 21, pp.386, 2021, 978-2-271-12972-7. halshs-03388895

**HAL Id: halshs-03388895**

**<https://shs.hal.science/halshs-03388895>**

Submitted on 10 Nov 2021

**HAL** is a multi-disciplinary open access archive for the deposit and dissemination of scientific research documents, whether they are published or not. The documents may come from teaching and research institutions in France or abroad, or from public or private research centers.

L'archive ouverte pluridisciplinaire **HAL**, est destinée au dépôt et à la diffusion de documents scientifiques de niveau recherche, publiés ou non, émanant des établissements d'enseignement et de recherche français ou étrangers, des laboratoires publics ou privés.

# *Archaeonautica*

21 | 2021

Open Sea | Closed Sea  
Local and Inter-Regional Traditions  
in Shipbuilding

Proceedings of the Fifteenth International Symposium  
on Boat and Ship Archaeology  
Marseilles 2018

*Edited by Giulia Boetto, Patrice Pomey and Pierre Poveda*

CNRS EDITIONS





# ARCHAEO NAUTICA

21 | 2021

OPEN SEA | CLOSED SEA  
LOCAL AND INTER-REGIONAL TRADITIONS IN SHIPBUILDING

PROCEEDINGS OF THE FIFTEENTH INTERNATIONAL SYMPOSIUM  
ON BOAT AND SHIP ARCHAEOLOGY  
MARSEILLES 2018

Edited by Giulia Boetto, Patrice Pomey and Pierre Poveda

MER FERMÉE | MER OUVERTE  
TRADITIONS LOCALES ET INTERRÉGIONALES DANS LA CONSTRUCTION  
NAVALE

ACTES DU QUINZIÈME COLLOQUE INTERNATIONAL  
D'ARCHÉOLOGIE NAVALE  
MARSEILLE 2018

Volume édité par Giulia Boetto, Patrice Pomey and Pierre Poveda

**CNRS ÉDITIONS**

15, rue Malebranche - 75005 Paris

***Pour toute information relative à la diffusion de nos ouvrages,  
merci de bien vouloir contacter  
notre service lecteurs:***

CNRS ÉDITIONS  
15, rue Malebranche, F-75005 PARIS  
Tél. : 01.53.10.27.00 - Fax: 01.53.10.27.27  
Courriel: [cnrseditions@cnrseditions.fr](mailto:cnrseditions@cnrseditions.fr)  
Site Internet : [www.cnrseditions.fr](http://www.cnrseditions.fr)





International Symposium on  
Boat & Ship Archaeology  
Marseille 22-27 October 2018

Hosted by

The Centre Camille Jullian (Aix Marseille University, CNRS)  
The Maison Méditerranéenne des Sciences de l'Homme  
The Département des recherches archéologiques subaquatiques et sous-marines  
The Musée des Civilisations de l'Europe et de la Méditerranée  
The Musée départemental d'Arles antique  
The Musée d'Histoire de Marseille

With support from

The Aix Marseille University  
The LabexMed – Social Sciences and Humanities at the Heart of Multidisciplinarity for the Study of the Mediterranean  
The Région Sud Provence-Alpes-Côtes d'Azur  
The Département Bouches du Rhône  
The Métropole Aix Marseille Provence  
The Ville de Marseille  
The Honor Frost Foundation  
The Ipso Facto – Bureau d'Etude et de Recherche  
The Société Nautique Marseille  
Agisoft PhotoScan

Published with the support of Aix Marseille University





## To the memory of Patrice Pomey (1943-2021)

Patrice Pomey, our dear friend and colleague, passed away on 7 March 2021.

Patrice was one of the pioneers of underwater archaeology at the beginning of the 1970s and served as director of the Direction des Recherches archéologiques sous-marines (DRASM) from 1984 to 1991: from 1998 to 2010 he was editor-in-chief of the *Archaeonautica* collection, founded by Bernard Liou. From early in his career Patrice specialised in the study of ancient nautical construction, a research field that was in its infancy. As an internationally renowned scholar, he was called upon by all and sundry to interpret new discoveries. His kindness and friendliness, his willingness to share his immense knowledge, and his contagious enthusiasm for his subject have left a profound mark on all those who knew him.

Patrice was a great supporter of the *International Symposium on Boat and Ship Archaeology*, to which he first contributed in 1988 in Amsterdam, and he was joint director alongside Éric Rieth of the seventh symposium held at Tatihou. He strongly hoped that France would host the event a second time in 2018, and this conference was an opportunity for him to promote the discipline that he played such a part in creating and which owes so much to him, as well as an occasion to celebrate his students, who have sustained and extended his work, and the Centre Camille Jullian, the research centre which he joined on its creation in 1978 and which he directed from 2000 to 2008. The collection of essays in his honour that were presented to Patrice on the opening day of the conference (*De re navali. Pérégrinations nautiques entre Méditerranée et océan Indien, Archaeonautica 20*, 2018) is a reflection of the admiration and affection he inspired in his colleagues and students. He often told us just how touched and delighted he was by the gesture. His considerable bibliography had been gathered together by his friends for the occasion and this volume also includes the titles of his final contributions in the keynote address delivered at the inauguration of the symposium and which he put to paper towards the end of 2020.

Patrice retained a keen interest in *Archaeonautica* even after he handed over the editorial reins. He was an attentive reviewer, pinning down vagueness, pointing out holes in arguments and knowledge, underlining typos, and always in his inimitable style that mixed scholarly rigour with thoughtful and sensitive remarks. The very many articles that he revised and amended are a lot better for it. During preparation of the essays in his honour, of which he was unaware, we already felt just how much we missed his advice. Patrice was involved in the drafting and editing of this volume of proceedings up to the stage of sending the manuscript to CNRS Éditions in January, but he will not see its appearance. We hope that he would have been proud of the final version and we will continue, as orphans of his vast knowledge, along the route that he has lit. *Sit tibi terra leuis*, dear Patrice, you who loved so much the sea.

Marie Brigitte Carre  
Editor-in-chief, *Archaeonautica*

Notre ami et collègue Patrice Pomey nous a quittés le 7 mars 2021.

Parmi les pionniers de l'archéologie sous-marine au début des années 1970, directeur de la Direction des Recherches archéologiques sous-marines de 1984 à 1991, il a dirigé la collection *Archaeonautica*, fondée par Bernard Liou, de 1998 à 2010. Il s'était spécialisé dès le départ dans l'étude de la construction navale antique, un domaine qui était alors à créer. Savant de renommée internationale, il était sollicité de toute part pour interpréter les nouvelles découvertes. Son amabilité, sa disponibilité à partager ses immenses connaissances, sa passion communicative pour son sujet ont profondément marqué ceux qui l'ont côtoyé.

Très attaché à l'*International Symposium on Boat and Ship Archaeology*, auquel il a contribué dès 1988 à Amsterdam, et organisateur avec Éric Rieth de la 7<sup>e</sup> rencontre à Tatihou, il avait fortement voulu que la France se porte candidate une deuxième fois en 2018. Ce colloque a été pour lui l'occasion de mettre en valeur tout à la fois la discipline qu'il a contribué à créer et qui lui doit tant, ses élèves qui en ont assuré la pérennisation et le rayonnement, et le Centre Camille Jullian, le laboratoire qu'il intégra à sa création en 1978 et qu'il dirigea de 2000 à 2008. Le livre d'hommages (*De re navali. Pérégrinations nautiques entre Méditerranée et océan Indien, Archaeonautica 20*, 2018) qui lui a été offert lors de la journée inaugurale du colloque reflète l'admiration et l'affection que lui portent ses collègues et élèves. Patrice nous a dit souvent combien il en avait été touché, et heureux. Sa bibliographie considérable a été rassemblée par ses amis à cette occasion et on trouvera aussi dans ce volume les titres de ses dernières contributions dans la *keynote* présentée pour l'ouverture du colloque, qu'il a rédigée à la fin de 2020.

Patrice n'a jamais cessé de s'intéresser à *Archaeonautica* même après en avoir transmis la direction. Relecteur attentif, il traquait les imprécisions de fond, les lacunes dans le raisonnement et les connaissances, les coquilles de forme, avec son style inimitable fait de rigueur scientifique et de délicatesse dans les commentaires. Les très nombreux articles qu'il a révisés lui doivent beaucoup. Lors de la préparation du volume des *Mélanges*, qui devait être une surprise, nous avons déjà senti à quel point ses conseils nous manquaient. Il a participé à la rédaction et à l'édition de ce volume d'Actes jusqu'à l'envoi du manuscrit à CNRS éditions en janvier, il n'en aura pas vu l'achèvement. Nous espérons qu'il en aurait été fier et nous continuerons, orphelins de son grand savoir, sur la route qu'il a tracée. *Sit tibi terra leuis*, cher Patrice, toi qui as tant aimé la mer.





## CONTENTS

|  |    |
|--|----|
| List of contributors.....  | 13 |
| Preface .....  | 19 |
| Keynote address: The Centre Camille Jullian: fifty years of maritime and nautical archaeology<br>by Patrice Pomey..... | 21 |

### OPEN SEA/CLOSED SEA - LOCAL AND INTER-REGIONAL TRADITIONS IN SHIPBUILDING

|  |    |
|--|----|
| Innovation, institutions and migration: transfer of technology in Dutch shipbuilding, 500-1700 .....   | 33 |
| <i>André F.L. van Holk</i>   |    |
| Finding <i>Scepter</i> : assessing European influences in early Swedish shipbuilding<br>and evaluating new excavation techniques .....   | 47 |
| <i>Jim Hansson</i>   |    |
| The shipwreck of the <i>Jeanne-Elisabeth</i> , a Swedish merchant ship lost off the French<br>Mediterranean coast in 1755. Hull assembly: three different architectural traditions.....                            | 47 |
| <i>Marine Jaouen and Andrea Poletto</i>  |    |
| Baltic and east European shipbuilding influences in the Swedish Empire: tracing local<br>and inter-regional shipbuilding traditions from the armed vessel <i>Bodekull</i> , built 1659-1661<br>and sunk 1678 ..... | 53 |
| <i>Niklas Eriksson</i>   |    |
| National shipbuilding, international technology: technological exchange in 18 <sup>th</sup> century<br>European shipyards .....  | 59 |
| <i>Ida Christine Jorgensen</i>   |    |
| From Jonah to Jack Tar: the integration of whaleboats into the British Royal Navy .....  | 65 |
| <i>Morgan Breene</i>   |    |

|   |    |
|---|----|
| Wooden shipbuilding in Cyprus from the late 19 <sup>th</sup> to the mid-20 <sup>th</sup> century..... | 71 |
| <i>Constantinos Nicolaou</i>  |    |

### SHIP CONSTRUCTION

|   |    |
|---|----|
| Hull characteristics of the Yenikapı 16 galley..... | 79 |
| <i>Ufuk Kocabaş and Işıl Özsait-Kocabaş</i>         |    |

|                                      |    |
|--------------------------------------|----|
| The hopper barges of Marseilles..... | 83 |
| <i>Xavier Corré</i>                  |    |

|  |    |
|--|----|
| The Cossack boat of 1737 as an example of shipbuilding in the first half of the 18 <sup>th</sup> century ..... | 89 |
| <i>Dimitri Kobaliia and Ksenia Yermolaieva</i>   |    |

|   |    |
|---|----|
| The Korshamn wreck: preliminary investigations of a Nordic clinker-carvel ‘hybrid’<br>from the late 12 <sup>th</sup> century, and some thoughts on medieval cargo handling..... | 95 |
| <i>Staffan von Arbin</i>  |    |

|  |     |
|--|-----|
| Boa Vista 1: context and construction details of an early modern ship discovered<br>in Lisbon, Portugal.....       | 101 |
| <i>José Bettencourt, Gonçalo C. Lopes, Cristóvão Fonseca, Tiago Silva, Patrícia Carvalho and Inês Pinto Coelho</i> |     |

### INLAND SHIP CONSTRUCTION

|  |     |
|--|-----|
| Different kinds of repairs and maintenance on a 2 <sup>nd</sup> century AD wreck:<br>the Lyon Saint-Georges 4 barge..... | 107 |
| <i>Marc Guyon and Laure Meunier</i>  |     |

|  |     |
|--|-----|
| A Roman barge from the Kupa River at Kamensko, Croatia: evidence of a regional<br>shipbuilding tradition of the Danube River Basin in southeastern Europe..... | 115 |
| <i>Giulia Boetto, Anton Divić and Krunoslav Zubčić</i>   |     |

|  |     |
|--|-----|
| Ships and boats of late prehistoric and Roman Nauportus. New evidence and some remarks<br>on the transfer and innovation in the shipbuilding technologies on the northern fringes<br>of the Mediterranean, 2 <sup>nd</sup> century BC – 1st century AD ..... | 123 |
| <i>Andrej Gaspari</i>  |     |

|   |     |
|---|-----|
| Structurally predominant bottoms in frame-first construction:<br>the case of the <i>barque du Léman</i> ..... | 131 |
| <i>Paul Bloesch</i>   |     |



|  |     |
|--|-----|
| The assembly of hulls in Southeast Asian shipbuilding traditions: from lashings to treenails ..... | 137 |
| <i>Pierre-Yves Manguin</i>   |     |

|   |     |
|---|-----|
| The Penglai 3 shipwreck in context: Korean shipbuilding in late 14 <sup>th</sup> and early 15 <sup>th</sup> centuries ..... | 141 |
| <i>Damien Peladan</i>   |     |

## RECENT DISCOVERIES

|   |     |
|---|-----|
| A Roman ship scuttled near Salona in the Gulf of Kaštela, Croatia ..... | 147 |
| <i>David Ruff, Irena Radić Rossi, Cemal Pulak and Nili Liphshitz</i>    |     |

|  |     |
|--|-----|
| Initial construction evidence of the Bou Ferrer shipwreck, a large vessel<br>of the Early Roman Empire ..... | 153 |
| <i>Carlos de Juan and Franca Cibecchini</i>  |     |

|   |     |
|---|-----|
| The Grande Passe 1 shipwreck, 2 <sup>nd</sup> century BC, Hyères, France: new data on its cargo,<br>nautical equipment and wooden remains ..... | 161 |
| <i>Alex Sabastia</i>  |     |

|   |     |
|---|-----|
| The Ma'agan Mikhael B shipwreck: a summary of four excavation seasons ..... | 167 |
| <i>Maayan Cohen, Michelle Creisher and Deborah Cvikel</i>                   |     |

|   |     |
|---|-----|
| A Byzantine period merchant ship from the Black Sea ..... | 175 |
| <i>Kroum Batchvarov</i>                                   |     |

|   |     |
|---|-----|
| The Paragan 1 shipwreck, Corsica: a 17 <sup>th</sup> -18 <sup>th</sup> century coaster..... | 181 |
| <i>Eric Rieth and Franca Cibecchini</i>   |     |

|   |     |
|---|-----|
| The medieval shipwreck from Kalverev Syd, Denmark ..... | 187 |
| <i>Mikkel H. Thomsen</i>                                |     |

|   |     |
|---|-----|
| The 'Big Ship' of Wismar: a well-preserved 12 <sup>th</sup> -century cargo vessel<br>from the harbour of Wismar ..... | 193 |
| <i>Massimiliano Ditta and Jens Auer</i>   |     |

|  |     |
|--|-----|
| A recently discovered wreck with double planking in the Bay of Puck. Measurements,<br>recording and positioning of the site with the use of a 3D photogrammetry model<br>and a multibeam echosounder ..... | 199 |
| <i>Tomasz Bednarz</i>  |     |

|   |     |
|---|-----|
| A late 17 <sup>th</sup> -century ‘Double Dutch’ construction in the North Frisian Wadden Sea:<br>the case of the Hörnum Odde wreck on the island of Sylt, Germany ..... | 205 |
| <i>Daniel Zwick</i>   |     |
| The Fährdorf wreck: another large 12 <sup>th</sup> -century cargo ship in the Schlei, northern Germany.....   | 213 |
| <i>Jonas Enzmann, Fritz Jürgens and Feiko Wilkes</i>  |     |
| Two ships under rocks: a glimpse into rural shipbuilding in western Pomerania.....  | 219 |
| <i>Jens Auer</i>  |     |

### NAUTICAL ETHNOGRAPHY

|  |     |
|--|-----|
| Sewn-plank construction techniques in the western Indian Ocean:<br>evidence from the timbers of Al Baleed, Oman .....                                      | 225 |
| <i>Alessandro Ghidoni</i>  |     |
| Bark canoes: sewing, lashing and folding .....   | 233 |
| <i>Béat Arnold</i>   |     |
| Indigenous navigation in the Caribbean Basin: a historical, ethnoarchaeological<br>and experimental approach to the Caribbean-Guyanese <i>kanawa</i> ..... | 239 |
| <i>Benoît Bérard and Alexandra Biar</i>  |     |

### STUDIES ON WOOD

|  |     |
|--|-----|
| An overview of three decades of dendrochronology applied to ancient Mediterranean<br>shipwrecks in southeastern France ..... | 245 |
| <i>Frédéric Guibal, Alba Ferreira Domínguez, Giulia Boetto, Lisa Shindo, Sandra Greck and Patrice Pomey</i>                  |     |
| Preliminary results of the wood analyses of the Roman vessels of Caska, island of Pag, Croatia .....                         | 251 |
| <i>Alba Ferreira Domínguez, Frédéric Guibal, Giulia Boetto and Irena Radić Rossi</i>   |     |
| The Bremen-Cog: environmental issues .....   | 257 |
| <i>Mike Belasus, Aoife Daly and Adolfo Miguel Martins</i>  |     |
| Timber supply for <i>Vasa</i> : new discoveries.....   | 263 |
| <i>Aoife Daly</i>  |     |
| Ship timber from the Baltic with a special emphasis on wood from Old Prussia and Poland.....                                 | 269 |
| <i>Maik-Jens Springmann</i>  |     |

## EXPERIMENTAL ARCHAEOLOGY

|  |     |
|--|-----|
| Sailing Ma'agan Mikhael II.....  | 277 |
| <i>Yochai Palzur and Deborah Cvikel</i>  |     |
| Reconstruction of the Byzantine shipwreck Yenikapı 12 .....  | 283 |
| <i>Işıl Özsait-Kocabaş</i>   |     |
| The Oseberg ship: reflections on the choice of methodology when testing<br>experimental archaeological reconstructions ..... | 289 |
| <i>Vibeke Bischoff</i>   |     |
| The Skuldelev 3 reconstruction, <i>Roar Ege</i> : from reconstruction to retirement .....                                    | 295 |
| <i>Martin Rodevad Dael and Triona Sørensen</i>   |     |

## RESEARCH METHODS

|  |     |
|--|-----|
| The 5 <sup>th</sup> -century AD riverine boat of Santa Maria in Padovetere:<br>3D reconstruction of its shape and context..... | 303 |
| <i>Elisa Costa and Carlo Beltrame</i>  |     |
| An attempt to create a digital reconstruction of the Puck 2 wreck hull .....   | 309 |
| <i>Paweł Litwinienko and Janusz Różycki</i>  |     |
| The Bremen-Cog: reconstructed one more time.....   | 315 |
| <i>Pat Tanner and Mike Belasus</i>   |     |
| Computational fluid dynamics: floating a digital Barcode 02 .....  | 325 |
| <i>Sarah Fawsitt and Lin Cecilie Hobberstad</i>  |     |
| Mass documentation of archaeological ship timbers: introducing a novel,<br>time-efficient approach .....                       | 331 |
| <i>Thomas Van Damme, Massimiliano Ditta and Jens Auer</i>  |     |

## POSTERS

|   |     |
|---|-----|
| Artistic and symbolic elements of the Maltese <i>luzzu</i> .....  | 337 |
| <i>Efthymia Akrivopoulou and Irene Muñoz</i>  |     |
| The 16 <sup>th</sup> -century pump from <i>Gagliana Grossa</i> : preliminary results of recording and analysis..... | 341 |
| <i>Katarina Batur and Irena Radić Rossi</i>   |     |

|  |     |
|--|-----|
| What influenced British East Indiamen ship design? .....   | 345 |
| <i>Kurt Bennett</i>  |     |
| Traditional ship construction in the Gulf of Lion and the Ligurian Sea: the <i>tartane</i> case study .....                  | 347 |
| <i>Hélène Botcazou</i>   |     |
| Ships of the western Indian Ocean in Persian manuscript paintings.....   | 351 |
| <i>Michael J. de Ruyter</i>  |     |
| The Tallinn cog: smart conservation.....   | 355 |
| <i>Eero Ehanti, Heikki Häyhä and Priit Lätti</i>   |     |
| Early modern reused ship timbers from Boqueirão do Duro, Lisbon, Portugal .....  | 357 |
| <i>Gonçalo C. Lopes, José Bettencourt, Cristóvão Fonseca, Tiago Silva,<br/>Patrícia Carvalho and Inês Pinto Coelho</i>       |     |
| Ship shapes: digitising historic ship models.....  | 361 |
| <i>John K. McCarthy and Wendy van Duivenvoorde</i>   |     |
| The size of wooden components in relation to the tonnage of Greek and Roman ships .....                                      | 365 |
| <i>Emmanuel Nantet</i>   |     |
| The <i>Fougueux</i> (1785-1805): prototype of an 18 <sup>th</sup> –19 <sup>th</sup> century French construction method ..... | 369 |
| <i>Nuria E. Rodríguez Mariscal, Nicolás C. Ciarlo, Milagros Alzaga García, Eric Rieth<br/>and Manuel Izaguirre Lacoste</i>   |     |
| Viking boats in medieval Russia from written and archaeological evidence .....   | 373 |
| <i>Petr Sorokin</i>  |     |
| South and north: the linguistic mysteries of the <i>buss</i> .....   | 379 |
| <i>Katrin Thier</i>  |     |
| Building cheaply and simply: flat-bottomed boats with cross-planked bottoms<br>around the world .....                        | 383 |
| <i>Krzysztof Zamościński</i>   |     |

## LIST OF CONTRIBUTORS

Akrivopoulou, Efthymia  
Independent researcher  
Greece  
efthymia.akr@gmail.com

Alzaga García, Milagros  
Andalusian Historical Heritage Institute (IAPH)  
Underwater Archeology Center  
Cadiz, Spain

Arbin von, Staffan  
Department of Historical Studies University of Gothenburg  
PO Box 200 SE-405 30 Gothenburg, Sweden  
staffan.arbin@gu.se

Arnold, Béat  
Archaeologist for the canton of Neuchâtel (retired)  
The Laténium, Park and Museum of Archaeology Neuchâtel,  
Switzerland  
beat.arnold47@gmail.com

Auer, Jens  
Landesamt für Kultur und Denkmalpflege  
Mecklenburg-Vorpommern Landesarchäologie  
Domhof 4/5  
19055 Schwerin, Germany  
j.auer@lakd-mv.de  
jensauer@gmail.com

Batchvarov, Kroum  
Associate Professor of Maritime Archaeology  
Department of Anthropology  
Maritime Studies Program  
University of Connecticut, Avery Point  
ACD116C, 1084 Shennecossett Road  
Groton CT 06340, USA  
kroum.batchvarov@uconn.edu

Batur, Katarina  
University of Zadar, Department of Archaeology  
Obala kralja Petra Krešimira IV. 2  
23000 Zadar, Croatia  
kbatur@unizd.hr

Bednarz, Tomasz  
National Maritime Museum Gdańsk, Poland  
t.bednarz@nmm.pl

Belasus, Mike  
Saxo-Institute  
University of Copenhagen  
Copenhagen, Denmark  
belasus@hum.ku.dk

Beltrame, Carlo  
Dipartimento di Studi Umanistici  
Università Ca' Foscari Venezia  
Venice, Italy  
beltrame@unive.it

Bennett, Kurt  
Archaeology, College of Humanities, Arts and Social Sciences  
Flinders University  
Adelaide, Australia  
kurt.bennett@flinders.edu.au

Bérard, Benoît  
Professor Pre-Columbian Archaeology  
Director research unit AIHP-GEODE Caraïbe (EA 929)  
Université des Antilles  
Campus de Schoelcher BP 7209  
97275 Schoelcher cedex, Martinique F.W.I.  
benoit.berard@univ-antilles.fr

Bettencourt, José  
Department of History of NOVA FCSH  
CHAM-Centro de Humanidades / CHAM-Centre  
for the Humanities  
NOVA FCSH – Uac  
Av. de Berna, 26 C  
1069-061 Lisboa, Portugal  
jbettencourt.cham@gmail.com

Biar, Alexandra  
Laboratoire Archéologie des Amériques (UMR 8096)  
44 rue de la Clef  
75005 Paris, France  
alexbiar@hotmail.com

Bischoff, Vibeke  
Viking Ship Museum in Roskilde  
Roskilde, Denmark  
vb@vikingeskibsmuseet.dk

Bloesch, Paul  
Schalerstrasse, 1, 4054 Basel, Switzerland  
bloesch.bs@bluewin.ch

Boetto, Giulia  
CNRS, Aix Marseille University, Centre Camille Jullian  
MMSH, 5 rue du Château de l'Horloge CS 90412  
13097 Aix-en-Provence France cedex 2  
boetto@mmsh.univ-aix.fr

Botcazou, Hélène  
Ipso Facto, Marseille, France  
Aix Marseille University, CNRS, LA3M, Aix-en-Provence  
helene.botcazou@ipsufacto.coop

Breene, Morgan  
Oriol College  
OX1 4EW Oxford, UK  
morgan.breene@history.ox.ac.uk  
morgan\_breene@my.uri.edu

Carvalho, Patrícia  
CHAM-Centro de Humanidades / CHAM-Centre  
for the Humanities  
NOVA FCsH – Uac  
Av. de Berna, 26 C, 1069-061 Lisboa, Portugal  
patriciasanchescarvalho@gmail.com

Ciarlo, Nicolás C.  
National Scientific and Technical Research Council (CONICET)  
Institute of Archaeology, School of Philosophy & Letters  
University of Buenos Aires  
Argentina  
nciarlo1701@gmail.com

Cibecchini, Franca  
Département des Recherches Archéologiques Subaquatiques et  
Sous-Marines (DRASSM), Aix Marseille University, CNRS,  
Ministère de la Culture, Centre Camille Jullian  
Marseille, France  
franca.cibecchini@culture.gouv.fr

Cohen, Maayan  
Department of Maritime Civilizations and Leon Recanati  
Institute for Maritime Studies  
University of Haifa  
Abba Khoushy Avenue 199 3498838 Haifa, Israel  
maayancohen8@gmail.com

Corré, Xavier  
Musée d'Histoire de Marseille / Musée des Docks Romains  
2 Rue Henri Barbusse  
13001 Marseille, France  
xcorre@marseille.fr

Costa, Elisa  
Dipartimento di Studi Umanistici  
Università Ca' Foscari Venezia  
Venice, Italy  
elisa.costa@unive.it

Creisher, Michelle  
Department of Maritime Civilizations and Leon Recanati  
Institute for Maritime Studies  
University of Haifa  
Abba Khoushy Avenue 199 3498838 Haifa, Israel  
m.creisher@gmail.com

Cvikel, Deborah  
Department of Maritime Civilizations and Leon Recanati  
Institute for Maritime Studies  
University of Haifa  
Abba Khoushy Avenue 199 3498838 Haifa, Israel  
dcvikel@research.haifa.ac.il

Dael, Martin Rodevad  
Viking Ship Museum in Roskilde  
Roskilde, Denmark  
md@vikingskibsmuseet.dk

Daly, Aoife  
Associate Professor, Saxo Institute, University of Copenhagen  
Karen Blixens Plads 8  
2300 Copenhagen S, Denmark  
aoife.daly@hum.ku.dk  
dendro@dendro.dk

De Juan, Carlos  
Dirección General de Patrimonio y Cultura  
Generalitat Valenciana  
Valencia, Spain  
arqueologiadelmar@gmail.com

De Ruyter, Michael J.  
Archaeology, College of Humanities, Arts and Social Sciences  
Flinders University  
Adelaide, Australia  
mick.deruyter@flinders.edu.au

Ditta, Massimiliano  
Stavanger Maritime Museum Musegata 16  
4010 Stavanger, Norway  
massimiliano.ditta@museumstavanger.no  
massimiliano.ditta@outlook.com

Divić, Anton  
Aix Marseille University, CNRS, Centre Camille Jullian  
Aix-en-Provence, France  
University of Zagreb, Croatia  
antondivic@gmail.com

Ehanti, Eero  
For Our Generation OÜ  
Pikaliiva tn 90/2-32  
Tallinn, harju maakond, 13516, Estonia  
eero.ehanti@gmail.com

Enzmann, Jonas  
Lower Saxony Institute for Historical Coastal Research  
Viktoriastr. 26/28  
26382 Wilhelmshaven, Germany  
jonas.enzmann@nihk.de



Eriksson, Niklas  
Associate Professor  
Department of Archaeology and Classical Studies Stockholm  
University  
SE-10691 Stockholm, Sweden  
niklas.eriksson@ark.su.se

Fawsitt, Sarah  
Maritime archaeologist  
Documentation Laboratory  
Norwegian Maritime Museum  
Oslo, Norway  
sarah.fawsitt@marmuseum.no

Ferreira Domínguez, Alba  
Aix Marseille University, CNRS, Centre Camille Jullian  
MMSH, 5 rue du Château de l'Horloge CS 90412  
13097 Aix-en-Provence France cedex 2  
albaferreiradominguez@gmail.com

Fonseca, Cristóvão  
CHAM-Centro de Humanidades / CHAM-Centre  
for the Humanities  
NOVA FCsH – UAc  
Av. de Berna, 26 C, 1069-061 Lisboa, Portugal  
cristovaofonseca@fcsh.unl.pt

Gaspari, Andrej  
University of Ljubljana, Faculty of Arts, Department  
of Archaeology  
Aškerčeva 2  
1000 Ljubljana, Slovenia  
andrej.gaspari@ff.uni-lj.si

Ghidoni, Alessandro  
Department of Arab and Islamic studies  
Exeter University, UK  
alessandroghidoni@hotmail.com

Greck, Sandra  
Association Arkaeos  
59 Boulevard Camille Flammarion  
13001 Marseille, France  
sandragreck@arkaeos.fr

Guibal, Frédéric  
Aix Marseille University, Avignon Université, CNRS, IRD, IMBE  
Europôle Méditerranéen de l'Arbois  
13545 Aix-en-Provence, France  
frederic.guibal@imbe.fr

Guyon, Marc  
Institut National de Recherches Archéologiques Préventives,  
Aix Marseille University, CNRS, INRAP, Centre Camille Jullian  
marc.guyon@inrap.fr

Hansson, Jim  
Swedish National Maritime and Transport Museums  
P.O. Box 27131  
SE-102 52 Stockholm, Sweden  
jim.hansson@maritima.se

Häyhä, Heikki  
For Our Generation OÜ  
Pikaliiva tn 90/2-32  
Tallinn, harju maakond, 13516, Estonia  
heikkih9@gmail.com

Hobberstad, Lin Cecilie  
Maritime archaeologist  
Documentation Laboratory  
Norwegian Maritime Museum  
Oslo, Norway  
lin.hobberstad@marmuseum.no

Holk van, André F.L.  
Batavialand Oostvaardersdijk 01-13  
Postbus 119  
8200 AC Lelystad, Netherlands  
andre.vanholk@batavialand.nl

Izaguirre Lacoste, Manuel †  
Historical-Artistic and Museum Heritage Service  
Provincial Council of Gipuzkoa  
Gipuzkoa, Spain

Jaouen, Marine  
Département des Recherches Archéologiques Subaquatiques et  
Sous-Marines (DRASSM)  
Ministère de la Culture  
Marseille, France  
marine.jaouen@culture.gouv.fr

Jorgensen, Ida Christine  
University of Portsmouth  
Portsmouth, UK  
idachrjorgensen@gmail.com

Jürgens, Fritz  
Institute of Pre- and Protohistoric Archaeology  
Christian-Albrecht University Kiel  
Johanna-Mestorf-Str. 2-6  
24118 Kiel, Germany  
f.juergens@ufg.uni-kiel.de

Kobaliia, Dimitri  
Head of Archaeology Department  
National Reserve « Khortytzia »  
Zaporizhzhia, Ukraine  
kobalia72@gmail.com

Kocabaş, Ufuk  
İstanbul University, Faculty of Letters  
Division of Conservation of Marine Archaeological Objects  
Ordu Caddesi  
34459 Laleli-İstanbul, Turkey  
ufukkocabas@gmail.com

Lätti, Priit  
Estonian Maritime Museum  
Vesilennuki 1, 10415 Tallinn, Estonia  
priit@meremuseum.ee

Lipshitz, Nili †  
Tel Aviv University

Litwinienko, Paweł  
Underwater Archaeology Department  
National Maritime Museum  
Ołowianka 9-13  
80-751 Gdańsk, Poland  
p.litwinienko@nmm.pl

Lopes, Gonçalo C.  
CHAM-Centro de Humanidades / CHAM-Centre  
for the Humanities  
NOVA FCsH – UAc  
Av. de Berna, 26 C, 1069-061  
Lisboa, Portugal  
goncaloncl@gmail.com

McCarthy, John K.  
Archaeology, College of Humanities, Arts and Social Sciences  
Flinders University  
Adelaide, Australia  
john.mccarthy@flinders.edu.au

Manguin, Pierre-Yves  
Ecole française d'Extrême-Orient  
Paris, France  
Pierre-yves.manguin@efeo.net

Martins, Adolfo Miguel  
University of Wales Trinity Saint David  
Lampeter, UK  
adolfo.miguel.martins@gmail.com

Meunier, Laure  
Conservator, independent researcher IFIRES, France  
laure-ifires@ouvaton.org

Muñoz, Irene  
Independent researcher  
Spain  
ire22714@gmail.com

Nantet, Emmanuel  
Department of Maritime Civilizations and Leon Recanati  
Institute for Maritime Studies  
University of Haifa  
Abba Khoushy Avenue 199 3498838 Haifa, Israel  
enantet@univ.haifa.ac.il

Nicolaou, Constantinos  
Department of History and Archaeology  
University of Cyprus  
Nicosia, Cyprus  
lefkolla@gmail.com

Özsait-Kocabaş, Işıl  
İstanbul University, Faculty of Letters  
Division of Conservation of Marine Archaeological Objects  
Ordu Caddesi  
34459 Laleli-İstanbul, Turkey  
isilozsait@gmail.com

Palzur, Yochai  
Department of Maritime Civilizations and Leon Recanati  
Institute for Maritime Studies  
University of Haifa  
Abba Khoushy Avenue 199 3498838 Haifa, Israel  
yochai22@gmail.com

Peladan, Damien  
Université de Paris  
Paris, France  
damien.peladan@gmail.com

Pinto Coelho, Inês  
CHAM-Centro de Humanidades / CHAM-Centre for the  
Humanities  
NOVA FCsH – UAc  
Av. de Berna, 26 C, 1069-061 Lisboa, Portugal  
inespintocoelho@fcsh.unl.pt

Poletto, Andrea  
Independent researcher  
Genova, Italy  
andreapoletto504@gmail.com

Pomey, Patrice †  
CNRS, Aix Marseille University, Centre Camille Jullian  
MMSH, 5 rue du Château de l'Horloge CS 90412  
13097 Aix-en-Provence France cedex 2

Pulak, Cemal  
Texas A&M University  
College Station, TX, USA  
pulak@tamu.edu

Radić Rossi, Irena  
University of Zadar, Department of Archaeology  
Obala kralja Petra Krešimira IV. 2  
23 000 Zadar, Croatia  
irradic@unizd.hr

Rieth, Eric  
National Centre for Scientific Research (CNRS)  
Laboratory of Western Medieval Research of Paris (LAMOP),  
University Paris 1  
National Maritime Museum Paris, France  
eric.rieth.cnrs@gmail.com

Rodríguez Mariscal, Nuria E.  
Andalusian Historical Heritage Institute (IAPH)  
Underwater Archeology Center  
Cadiz, Spain  
nuria.rodriguez.mariscal@juntadeandalucia.es

Rózycki, Janusz  
Underwater Archaeology Department  
National Maritime Museum  
Ołowianka 9-13  
80-751 Gdańsk, Poland  
j.rozycki@nmm.pl

Ruff, David  
Texas A&M University  
College Station, TX, USA  
daveruff@aggienetwork.com

Sabastia, Alex  
Institut National de Recherches Archéologiques Préventives,  
Aix Marseille University, CNRS, INRAP, Centre Camille  
Jullian  
alex.sabastia@inrap.fr

Shindo, Lisa  
CNRS, Aix Marseille University, Centre Camille Jullian  
MMSH, 5 rue du Château de l'Horloge CS 90412  
13097 Aix-en-Provence France cedex 2  
shindo.lisa@gmail.com

Silva, Tiago  
CHAM-Centro de Humanidades / CHAM-Centre  
for the Humanities  
NOVA FCsH – UAc  
Av. de Berna, 26 C, 1069-061  
Lisboa, Portugal  
toiago@gmail.com

Sørensen, Tróna  
Viking Ship Museum in Roskilde  
Roskilde, Denmark  
trs@vikingskibsmuseet.dk

Sorokin, Petr  
Senior Researcher  
The Institute of the History of Material Culture  
Russian Academy of Science  
Dvorzovaja nab. 18  
191186 St. Petersburg, Russia  
petrsorokin@yandex.ru

Springmann, Maik-Jens  
Technical State Museum  
Mecklenburg-Western Pomerania  
Zum Festpl. 3, 23966 Wismar, Germany  
springmann@phantechnikum.de

Tanner, Pat  
Centre for Maritime Archaeology  
University of Southampton  
Southampton, UK  
Pat.Tanner@soton.ac.uk

Thier, Katrin  
Oxford English Dictionary  
Oxford, UK  
kthier@nexus.ox.ac.uk

Thomsen, Mikkel H.  
Viking Ship Museum in Roskilde  
Roskilde, Denmark  
mht@vikingskibsmuseet.dk

Van Damme, Thomas  
Ubi3D, Korte Gasthuisstraat 26  
2000 Antwerp, Belgium  
thomas.van.damme@outlook.com

van Duivenvoorde, Wendy  
Archaeology, College of Humanities, Arts and Social Sciences  
Flinders University  
Adelaide, Australia  
wendy.vanduienvoorde@flinders.edu.au

Wilkes, Feiko  
Institute of Pre- and Protohistoric Archaeology Christian-  
Albrecht University Kiel  
Johanna-Mestorf-Str. 2-6  
24118 Kiel, Germany  
feiko.wilkes@gmail.com

Yermolaieva, Ksenia  
National Reserve «Khortytzia»  
Zaporizhzhia, Ukraine  
evaermola@gmail.com

Zamościński, Krzysztof  
National Maritime Museum  
Gdańsk, Poland  
k.zamoscinski@nmm.pl

Zubčić, Krunoslav  
Croatian Conservation Institute  
Department of Underwater Archaeology  
Zagreb, Croatia  
kzubcic@h-r-z.hr

Zwick, Daniel  
State Archaeology Department of Schleswig-Holstein  
Archäologisches Landesamt Schleswig-Holstein  
Brockdorff-Rantzau-Str. 70  
24837 Schleswig, Germany  
d.zwick@archaeologia-navalis.org



## PREFACE

Twenty-four years after the seventh ISBSA was held on the island of Tatihou, it became the turn of Marseille on the Mediterranean coast of France to have the honour of hosting the fifteenth *International Symposium on Boat and Ship Archaeology* (ISBSA 15), which brought together, from 22 to 27 October 2018, some 300 scholars, PhD and post-doctoral researchers, and students from 36 countries belonging to almost 130 research bodies.

Marseille, the oldest town in France, was founded around 600 BC by Greek settlers, who had arrived by sea from Phocaea in Asia Minor. Today it is the country's largest port, the birthplace of underwater diving, and is endowed with numerous archaeological shipwrecks that have been found on land and under sea. Marseille was the European Cultural Capital for 2013, and the city and its region took advantage of the event to showcase its heritage, especially maritime, and update facilities and institutions in order to develop an ideal venue for hosting the many participants.

The conference was organised by the Centre Camille Jullian – UMR 7299 (CCJ), a research laboratory specialising in Mediterranean archaeology based within the Maison Méditerranéenne des Sciences de l'Homme at Aix-en-Provence. The CCJ has institutional ties to the University of Aix-Marseille,

the Centre National de la Recherche Scientifique (CNRS), the French Ministry of Culture, and the Institut National de Recherches Archéologiques Préventives (INRAP). For many years the CCJ has been one of the main centres of French research into nautical and maritime archaeology and, in 2018, on the occasion of ISBSA 15, it celebrated 50 years of activity in this field. Indeed, it was in 1968 that the Institut d'Archéologie Méditerranéenne, from which the CCJ was born, began underwater excavations on the Roman shipwrecks Planier III and Madrague de Giens, and developed the first French team dedicated to nautical and maritime archaeology.

Three great museums welcomed ISBSA 15: the Museum of European and Mediterranean Civilisations, Marseille History Museum with its exceptional collection of ancient wrecks from the city, and the Departmental Museum of Ancient Arles with its remarkable Gallo-Roman barge Arles-Rhône 3. The Ministry of Culture's department for underwater archaeological research (DRASSM), which is based in Marseille, mobilised its research ship *André-Malraux* and its fleet of support vessels for a special evening event dedicated to this institution.

The theme of the conference was "Open sea, closed sea: Local and inter-regional traditions in shipbuilding" and the



Group photograph of the participants in ISBSA 15, inside the Musée départemental d'Arles antique October 24 2018 (photo L. Roux, CNRS, Aix Marseille University, CCJ).



intention was to reveal interactions between local and inter-regional traditions of open and enclosed waters through examples taken from nautical areas as varied and representative as possible. Each region has its own shipbuilding traditions on the local level, which reflect the particularities of its sailing space, especially as regards geographic, physical and economic aspects, although political, social and cultural conditions are also relevant. The more pronounced the particularities, the stronger and more persistent the regional traditions. But beyond the local level, which is clearly marked by specific activities limited in scope, these same phenomena can be found in closed maritime spaces. On the other hand, once the maritime space extends beyond the regional, local particularities become blurred and give way to shared, if not universal traditions. Within this context, and the contradictory interplay between local resistance and reciprocal inter-regional influences that can lead to technology transfers, changes in shipbuilding traditions can occur. Such changes will be more or less rapid and more or less complex depending on the size and nature of the maritime exchanges and the extent of the maritime spaces in question.

This volume includes 60 contributions from 82 authors covering different nautical areas (the Mediterranean, Atlantic, Pacific, Baltic, North Sea, and South China Sea) from pre-history to the modern era, and is built around the principal theme and seven other sub-themes: ship construction; recent discoveries; nautical ethnography; dendrology; experimental archaeology; research methods; and Asian studies. Alongside traditional topics, dendrology studies were accorded a specific session for the first time: a sign of the important contributions of xylology, dendromorphology and dendrochronology to the study of vessels. In addition, nautical ethnography studies have regularly found a place in this conference to the extent that studies covering the Asian region required the allotment of two special sessions, whose presence is reflected in this volume. And lastly, the editors have chosen to publish the conference posters in the form of short contributions that appear in the ninth and final section.

Thus, the programme of ISBSA 15, as reproduced in this volume testifies by its very size to the development of nautical archaeology into a fully-fledged discipline grown to maturity. In this respect, the continuous involvement of new countries from outside Europe, the emergence of new research themes, and the rejuvenation of established teams by the remarkable presence of so many young researchers are all signs of vitality.

This augurs well for the future of studies in the archaeology of boats and ships. Nonetheless, we must be wary of closing ourselves off within this single discipline. Nautical archaeology cannot be self-sufficient, and can only be justified by the scope of the historical discourse that it generates. It is only through such an attitude that other disciplines, such as economic and social history, the history of technology and environmental history will recognise the interest in research conducted within our field and will interact with it. We must not slacken in the

endeavours already launched, and we must realise that much still remains to be done.

## ACKNOWLEDGMENTS

Although the symposium was primarily funded by the sponsoring institutions from their operating funds, and by participants' fees, grants were gratefully received from Aix-Marseille University through its Fond Incitatif à la Recherche (FIR), the LabexMed – Social Sciences and Humanities at the Heart of Multidisciplinarity for the Study of the Mediterranean, the Région Sud Provence-Alpes-Côtes d'Azur, the Département des Bouches du Rhône, the Métropole Aix-Marseille-Provence and the Ville de Marseille.

The organising committee is also grateful to Jean-Christophe Sourisseau, director, Laurent Borel, Gracinda Das Neves, Loïc Damelet, Anton Divić, Alba Ferreira Dominguez, Vincent Dumas, Cristel Lanata, Lionel Roux, Alex Sabastia of the Centre Camille Jullian; Sophie Bouffier, director, and Sylvie Laurens-Aubry of the Maison Méditerranéenne des Sciences de l'Homme; Michel L'Hour, director, and the staff of the Département des recherches archéologiques subaquatiques et sous-marines (DRASSM); Jean-François Chougnet, president, Myriam Morel-Deledalle, Anne Faure, Pascale Fabre, Aude Fanlo, and Eric Moncho of the Musée des Civilisations de l'Europe et de la Méditerranée; Claude Sintès, director, Sabrina Marlier of the Musée départemental d'Arles antique; Fabrice Denise, director, and Xavier Corré of the Musée d'Histoire de Marseille; Alison Cathie, chair, and the Trustees of the Honor Frost Foundation that awarded bursaries to enable ten young researchers and advanced students to attend the ISBSA 15; Mourad El Amouri and the cooperative Ippo Facto-Bureau d'Étude et de Recherche for its support in the organisation and navigation of *Gyptis* and other traditional boats; Pierre Sathal, director of the Société Nautique de Marseille, and Pascal Borel, vice-president of the Voiles du Vieux-Port; A. D'Agaro and the Direction de la Valorisation of Aix-Marseille University, and the students of the Master of Maritime and Coastal Archaeology (MoMarch), Ninon Basuau, Nazim Bensalah, Jeanne Bordé, Alison Fayot, Léo Fernandez, Aurélien Lacroix, Coralie Perrin, Ivan Vidulić, for their precious help in organising and managing the symposium.

The organising committee in Aix-en-Provence greatly appreciated the assistance and advice of several previous ISBSA organizers, Nergis Güsenin (Istanbul 2009), André Van Holk (Amsterdam 2012) and Jerzy Litwin (Gdańsk).

Finally, the editors of this volume are particularly indebted to Colin Clement who took care of English translation and editing, Marie-Brigitte Carre, editor in chief, and CNRS éditions who accepted to publish and distribute the present volume of proceedings in the *Archaeonautica* collection.



# KEYNOTE ADDRESS: THE CENTRE CAMILLE JULLIAN: 50 YEARS OF MARITIME AND NAUTICAL ARCHAEOLOGY

Patrice POMEY

---

## Abstract

This article retraces the principal activities of the Centre Camille Jullian – UMR 7299 (CCJ) in Mediterranean nautical archaeology from its beginnings with the pioneering underwater excavations of the Planier III and Madrague de Giens wrecks from the end of the 1960s, to the beginning of the 1980s, through the 1990s and the wrecks of Marseille’s ancient harbour, and up until the most recent developments. This latter period has seen the CCJ gradually extend its activities into further flung Mediterranean regions through international collaborations in Italy, Croatia, Egypt and the Black Sea, and the increasingly advanced integration of multiple interdisciplinary approaches. The theoretical and methodological foundations on which the innumerable projects of its researchers are based have allowed the study of ancient Mediterranean ships to be tackled in innovative and constantly renewed ways

## Keywords

Maritime archaeology, nautical archaeology, history of technology, ancient Mediterranean

## Résumé

Cet article retrace les principales activités du Centre Camille Jullian – UMR 7299 (CCJ) en archéologie navale méditerranéenne depuis ses débuts avec les fouilles sous-marines pionnières des épaves *Planier III* et de la Madrague de Giens de la fin des années 1960 au début des années 1980, en passant par les épaves du port antique de Marseille dans les années 1990 jusqu’aux développements les plus récents. Ces derniers ont amené le CCJ à s’ouvrir graduellement vers les terrains méditerranéens par le biais de collaborations internationales en Italie, en Croatie, en Égypte ou en Mer Noire et à l’intégration de plus en plus poussée de multiples approches interdisciplinaires. Les assises théoriques et méthodologiques sur lesquels sont fondés les innombrables travaux de ses chercheurs ont permis d’approcher de façon innovante et sans cesse renouvelée l’étude des navires antiques de Méditerranée.

## Mots-clés

Archéologie maritime, archéologie navale, histoire des techniques, Méditerranée antique

---

The *Fifteenth International Symposium on Boat and Ship Archaeology*, held in October 2018 at Marseille, and organised by the Centre Camille Jullian – UMR 7299 (CCJ, Aix Marseille University, CNRS), was the ideal occasion to recall the journey undertaken by this Centre in the world of maritime archaeology, and more specifically in nautical archaeology, over half a century of activities and research at the highest level within a domain that it effectively helped to establish.

In July 1968, exactly 50 years before the presentation of this paper, André Tchernia was excavating the Planier III, a Roman shipwreck dated to the mid-1<sup>st</sup> century BC that lay 28 m underwater by the Isle of Planier in the seas off Marseille. For the first time in France, a submarine excavation was overseen by a scholar capable of diving to lead the underwater operations directly. The following month, in August 1968, he conducted a preliminary campaign off the peninsula of Giens (Hyères) on a Roman wreck from the first half of the 1<sup>st</sup> century BC. This ship would come to be known as the Madrague de Giens and, a few years later, would become the site of one of the largest underwater excavations ever undertaken on an ancient wreck in the Mediterranean.

It all began in 1967 when A. Tchernia, then assistant lecturer in Latin at the University of Provence – now Aix Marseille University – and member of the Institut d’Archéologie Méditerranéenne (IAM), was nominated to lead the Direction des recherches archéologiques sous-marines (DRASM),

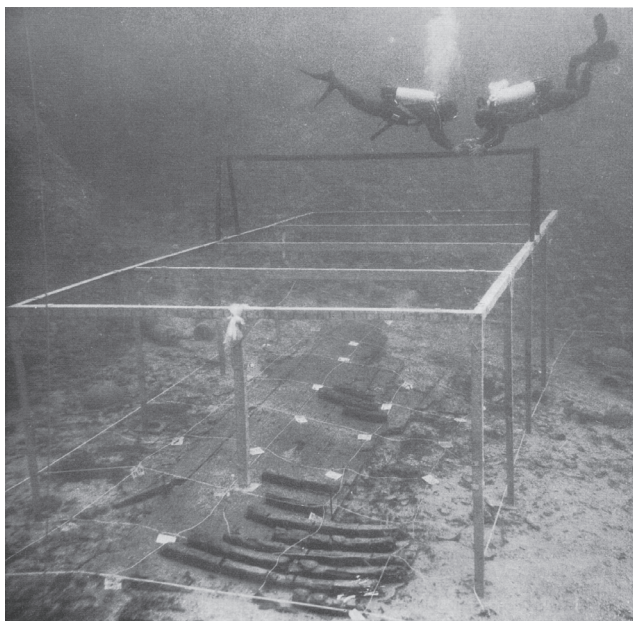
recently created in Marseille by the French Ministry of Culture to oversee underwater excavations in French territorial waters.

Tchernia, a former member of the French School of Rome, was an archaeologist and specialist in Roman economic history (Tchernia 1986, 2011). He was particularly aware of the extraordinary potential that wrecks and their cargoes represented for the study of ancient maritime trade. Furthermore, he was convinced, like George F. Bass, that archaeologists needed to take charge of underwater excavations themselves. He played a founding role in France in the organisation of underwater archaeology and the development of maritime archaeology as a new discipline of academic research. It was also in 1967, after meeting Tchernia and on his advice, that I myself, then a Master’s student in archaeology at the Sorbonne, turned towards the study of ships and ancient shipbuilding, developing my own focus on Mediterranean nautical archaeology.

In 1970, building on these early experiences and ever aware of the necessity of creating a specialised team capable of successfully conducting underwater excavations, particularly with regard to the Madrague de Giens wreck, Tchernia gathered together within the IAM some engineers and technicians from the Centre National de la Recherche Scientifique (CNRS). This group included Jean-Marie Gassend, an architect, Michel Rival, an illustrator, Antoine Chéné and Gérard Réveillac, photographers, Antoinette Hesnard, an archaeologist then attached to another CNRS unit in Marseille, and myself. In the meantime,

I had obtained the post of archaeology assistant at Nancy University and had participated along with Michel Rival in the preliminary campaign organised by Tchernia in 1968 on the Madrague de Giens wreck. This was the first university-CNRS team in France specialised in underwater archaeology, and it was to be the seed that sprouted the maritime and nautical archaeology teams of the CCJ, which was founded in 1978 out of the old IAM.

After the first excavation campaign on the Planier III in 1968, which concentrated on evaluating the potential of the wreck, and studying and dating the cargo (Tchernia 1968-1970), the following campaigns in 1970 and 1971 were conducted for the first time by the new IAM team, under the leadership of A. Tchernia, and then myself, with the support of the DRASM and *L'Archéonaute* (Liou 1973, p. 586-589; Liou, Pomey 1985, p. 553-556). These campaigns were entirely dedicated to the study of the remains of the ship's hull. Aside from the scientific interest in studying the wreck, the campaigns contained an important methodological dimension. They served not merely to train a team in the challenges of excavating a ship, but they also played the role of methodological and technical testing ground in preparation for the future excavation of the Madrague de Giens. So, following the example of the Yassiada excavation led by G.F. Bass (Bass 2012, p. xviii), stereo photography was systematically used in the photogrammetry survey of the Planier III hull (**fig. 1**). The plan thus obtained was then completed using a method that has since been tried and tested involving manual measurements of the ensemble and of details (plans and sections). In order to successfully accomplish all these measurements and produce stereoscopic photos of the hull details, a specific system for marking the structures and the assemblages was developed, the principle of which is still in use today. Moreover, in order to be able to study the hull in all its details, including inaccessible sections, parts were dismantled and samples were removed following a procedure that would be further developed thereafter on the Madrague de Giens.



**Fig. 1:** Stereo photography of the hull of the Planier III for use in photogrammetry reconstruction (photo A. Chéné, CNRS/CCJ).



**Fig. 2:** Patrice Pomey and André Tchernia during excavation of the Madrague de Giens wreck in 1973 (photo A. Chéné, CNRS/CCJ).

The excavation of the Madrague de Giens wreck truly began in 1972, with the IAM team under the joint leadership of André Tchernia, for the study of the cargo, and myself for the study of the ship (**fig. 2**): A. Hesnard was responsible for the data entry of the material inventory. The wreck lay at a depth of between 18 and 20 m to the north of the Giens peninsula, in the Îles d'Hyères archipelago near Toulon. It dates to the first half of the 1<sup>st</sup> century BC and was carrying a large cargo of roughly 6,000 Dressel I B wine amphorae from Campania and a complementary load of Campanian pottery and common ware. The ship was one of the largest of its era, reaching some 40 m in length. No less than 11 excavation campaigns, from 1972 to 1982, and the rounding up of considerable means were necessary to successfully complete the project, whose objectives were straightforward: to conduct the excavation and systematic study of this large well preserved ship according to the most advanced methods (Tchernia *et al.* 1978; Pomey 1982; Liou, Pomey 1985, p. 559-567; Rival 1991, p. 147-244; Pomey 1997a, p. 252-253, 1997b, p. 178-180; Hesnard 2012; Pomey 2015a, p. 73-81, Carre 2018)<sup>1</sup>. In 1969, an experiment in geomagnetic prospection, the first in France in an underwater context, was conducted on the site through the cooperation of Albert Hesse from the Centre de Recherches Géophysiques at Garchy, whom

1. Laëticia Cavassa and Pierre Poveda have just recently begun organising a CCJ team working on a new publication of the shipwreck. The project, in which I am participating alongside A. Tchernia, is supported by the Shelby White – Leon Levy Foundation, among others.



I had met shortly before on a land intervention, and of the DRASM (Chevalier *et al.* 1971). Thereafter, the prospection was extended across the whole of the site in order to fix the excavation zones as precisely as possible. The techniques developed during the Planier III excavation were then systematically applied and enhanced, and excavation methods were adapted to the large dimensions of the wreck, and to the following objectives:

- clearing and cleaning the large excavation zone to allow for a good view of the cargo and the structure of the hull;
- systematic marking of the amphorae in the cargo, which could then serve as markers for small objects, and labelling elements of the hull structure and their assemblage after consolidation;
- photogrammetry coverage in plan view on several levels of the cargo and the hull after the dismantling of different layers, and elevation views on transversal sections of the cargo;
- selected sampling of elements of the hull representative of the structure and assemblages, to be replaced after study, except, however, for a sample of keel and bottom preserved after treatment and currently exposed in the History Museum of Marseille;
- additional drawings of longitudinal and transversal plans and sections, and details of the hull;
- extraction of palynological and xyological samples for analysis.

In addition, one should point out the novel use of computer technology to inventory the material directly on site.

The excavation of the Madrague de Giens wreck, because of its magnitude and the methodological aspect, quickly became the founding excavation standard for scientific underwater archaeology in France. It also played an important role as an excavation school for training many future leaders in underwater archaeology from several countries. And it marked the beginning, in France, of the studies of economic history through maritime exchange and the study of nautical archaeology, two research fields in which the CCJ has become specialised and on which it has built its reputation.

The excavation methods developed on the Madrague de Giens shipwreck led not only to the meticulous reconstitution of the elements of the cargo and their distribution within the ship, but also to an identification of the form and structure characteristics of the hull and elements of the rigging (Carre 2018) (fig. 3). The particular features of the hull then led to iconographic comparisons, especially with the large ship visible in the mosaic of the Baths of Themetra (3<sup>rd</sup> century, Tunisia), which resulted in an identification of the vessel type (Pomey 1982). This identification facilitated the construction of models and led to an initial CAD digital modelling of the hull<sup>2</sup>.

These results opened up a global approach to the study of the ship and its cargo, extending naturally onto land in search of the provenance and distribution of the various elements of the cargo<sup>3</sup>. From now on, studies of maritime trade were to be closely linked to nautical archaeology within the heart of a new and vast domain, maritime archaeology.

2. Graphic reconstitution was undertaken by M. Rival (1991, p. 205), and study and display models were built by J.-P. Cuomo and L. Damonte. A 3D reconstitution was developed by the consulting firm Sistre International (M. Pommellet) in 1990-91 and represented an original and innovatory experiment for the time.

3. See, most recently, Hesnard 2012.

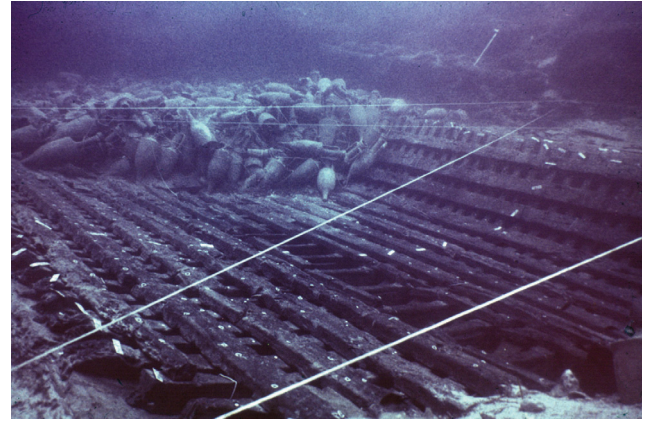


Fig. 3: Central part of the hull of the Madrague de Giens wreck (photo A. Chéné, CNRS/CCJ).

The impact of the Madrague de Giens excavation was decisive for nautical archaeology. The analysis of the ship, within a new anatomical perspective where each element, from the meanest (assembly tenon or peg) to the most striking (keel, plank or frame), is strictly correlated and participates fully in the ensemble, and where the forms, structures and function are all closely connected, opened new perspectives in the study of nautical archaeology. And so it was that, after joining the CNRS and the IAM on my return from the French School of Rome in 1975, I came to develop several themes on the basis of the examination of the Madrague de Giens ship that would provide matter for research in the CCJ and would arouse debate within ancient nautical archaeology in the following decades. These included: the notion of architectural type, and the closely dependent relationship between form, structure and function; examinations of tonnage and the sailing qualities of ships; and the use of the traditional sources of literature, iconography and ethnography in the interpretation of archaeological data<sup>4</sup>. But my interest was particularly piqued by questions related to construction systems (*shell-first, skeleton-first, mixed construction*) and in the years 1980-1990 these would lead me to develop a new analytical approach to the ship based upon the concept of “construction principle” and “construction methods” referring back to the notions of ship “conception” and “realisation” (Pomey 1994, 1998, 2004b). Within this framework, questions concerning the conception of ships and the intellectual tools available to the builders to accomplish this task occupied a fundamental place (Pomey 2009). At the same time, we must acknowledge Michel Rival’s work in advancing the studies of Roman nautical shipbuilding based particularly on analysis of the Madrague de Giens wreck, which played a fundamental role in his thinking, but also the Bourse de Marseille ship and the Port-Vendres 1 (Rival 1991).

Although the Madrague de Giens excavation was extremely important, it was not the only operation conducted during this period by the IAM, which was to become the CCJ in 1978. In 1973 and 1974, part of the team (J.-M. Gassend, M. Rival, A. Chéné, and G. Réveillac) worked for Bernard Liou, IAM member, new director of the DRASM and a lecturer at the University of Provence, on the excavation and salvage of a ship dated to the end of 4<sup>th</sup>-beginning of the 5<sup>th</sup> century AD, which

4. See for example: Pomey 1982, 2004a, 2011; Pomey, Tchernia 1978.





Fig. 4: Hull of the *Bourse de Marseille* wreck (photo G. Reveillac, CNRS/CCJ).

took its name, Port-Vendres 1, from its find site at the entrance to the harbour of Port-Vendres (Pyrénées-Orientales) (Liou 1974). In 1974-1975, the same team was led by J.-M. Gassend in the excavation of the *Bourse de Marseille* wreck (end 2<sup>nd</sup>-beginning 3<sup>rd</sup> century AD) which was discovered during excavation of the ancient harbour conducted by the Direction des Antiquités Historiques de Provence (Gassend 1982) (fig. 4). The hull of this ship was well preserved over a length of 20 m after having undergone atmospheric freeze-drying, and it has since been exhibited in the History Museum of Marseille.

In 1983-1984, under the supervision of A. Hesnard, the CCJ excavated the Grand-Ribaud D wreck and its cargo of *dolia* dating to the very end of the 1<sup>st</sup> century AD, which lay 18 m underwater at the foot of the island of Grand-Ribaud in the Îles d'Hyères archipelago (Hesnard *et al.* 1988). Investigation of the wreck shone a light on this original type of ship, which was especially built to transport bulk wine in large containers and which was the object of a modelling project by M. Rival. Thereafter, A. Hesnard in 1987-1989, and Marie-Brigitte Carre, in 1993-1994 excavated a 1<sup>st</sup> century BC ship, Camarat 2, lying 40 m down off Cap Camarat (Ramatuelle, Var): M. Rival conducted a partial architectural examination of the hull (Pomey 1992, p. 40-42; Carre 1998-1999, 2001). As regards methodology, photogrammetry coverage of the Grand-Ribaud D and Camarat 2 was achieved using an elaborate system of suspended cameras. In addition, the Camarat site was also used as a testing ground for electrical resistance measurements adapted for a subaquatic environment.

Some 15 years after the Grand-Ribaud D excavation, the CCJ revisited the study of *dolia*-carrying wrecks. In 1998 and 1999 Sabrina Marlier, then a PhD student with the CCJ studying the tradition of sewn boats in the Mediterranean (Marlier 2005), participated in the excavation of the Giraglia shipwreck (Corsica, circa 20 AD, Sciallano, Marlier 2008) and in 2004, M.-B. Carre and R. Roman built a reconstruction model of a *dolia* ship in an attempt to answer some of the many questions raised by this special type of vessel (fig. 5)<sup>5</sup>.

When I became director of the DRASM from 1984 to 1991, I was the third to have arrived via the IAM or CCJ after A. Tchernia and B. Liou. In collaboration with Frédéric Guibal, dendrochronology specialist at the Mediterranean Institute of Marine and Terrestrial Biodiversity and Ecology (IMBE, Aix Marseille University, CNRS), I launched a research programme into the dendrochronology and dendromorphology of ancient Mediterranean shipwrecks. Between 1991 and 2000, this programme, supported by the DRASSM (formerly DRASM) and their vessel *L'Archéonaute*, led to the reopening and analysis of some 30 ancient wrecks along the French Mediterranean coast (Guibal, Pomey 1998, 2003, 2009; Guibal *et al.* in this volume). The aims were: to identify the different species of wood used in ancient nautical construction and thus to understand the ship-builders' choices as a function of different structural elements; to study the working techniques applied to the wood in order to

5. Carre, Roman 2008. On *dolia* ships, see also Carre 1993; Marlier 2008, 2020.





Fig. 5: Model of a dolia ship (modelling by R. Roman, photo L. Damelet, CNRS/CCJ)

reconstruct the process of transforming the wood from the original tree to the final piece; to discover the origins of the wood and its ecological environment and establish dendrochronological relationships between different shipwrecks; and lastly, to build up dendrochronological reference sequences for the different species of wood that were used. The project was completely novel for the era and contributed greatly to the development of dendrological studies applied to nautical archaeology. It gave rise to two doctoral theses from the CCJ looking at the Mediterranean (Wicha 2005; Wicha, Girard 2006; Ferreira Dominguez *et al.* in this volume), and has since been followed by numerous other teams working in other countries and on other periods<sup>6</sup>.

In 1992 and 1993, the salvage excavations at Place Jules-Verne in Marseille, followed in 1997 by those in the neighbouring Place Villeneuve-Bargemon, were to mark a new stage in the development of CCJ research. Under the leadership of A. Hesnard, the digs revealed a large part of the ancient harbour and its surrounds, and their evolution from the foundation of the town at the beginning of the 6<sup>th</sup> century BC until the modern era (Hesnard 1994, 1999; Hesnard *et al.* 2001). Having examined maritime exchange and nautical archaeology, the study of port installations and coastal developments became a new field of research for the CCJ within maritime archaeology, and one that was to experience considerable growth.

However, the contribution of the Place Jules-Verne excavations was to be especially important in the development of nautical archaeology studies (fig. 6). No less than seven ancient

6. See articles on dendrology in this volume.



Fig. 6: The Jules-Verne 7 and 9 under excavation, Marseille (M. Derain, CNRS/CCJ).

ships were discovered there, and the excavations were the responsibility of the CCJ archaeology team, composed of M. Rival and R. Roman under my management. Among these wrecks were two Archaic Greek boats, abandoned at the end of the 6<sup>th</sup> century BC: one, the Jules-Verne 9, was a large coastal vessel propelled by both oar and sail, entirely assembled by lashings, designed for fishing, especially coral, and inshore transport; the other was a small merchant sailing ship, the Jules-Verne 7, assembled with mortises and tenons as well as lashings. There were also five Roman boats: three barges with central hatches from the 1<sup>st</sup>-2<sup>nd</sup> century AD, Jules-Verne 3, 4 and 5, used for the transportation of sediment during dredging of the port; a small vessel, Jules-Verne 8 from the 3<sup>rd</sup> century AD; and merchant ship, Jules-Verne 1-2, of the 4<sup>th</sup> century AD (Pomey 1995, 1999a, 1999b, 2001a, 2014b)<sup>7</sup>. Apart from this latter and the Jules-Verne 5, all of these wrecks were salvaged and treated in the Arc-Nucléart laboratory of Grenoble (Bernard-Maugiron 2007) and are currently exhibited in the History Museum of Marseille alongside the Roman ship from the Bourse. The ensemble represents an exceptional collection of ancient ships, unique in France.

The reconstruction of ships via graphic compositions backed up by experimental study models, following a method inspired by the work of J.R. Steffy (Steffy 1994), was first attempted during the study of the Madrague de Giens but came to be developed in a systematic fashion at the CCJ thanks to the talent of our model maker R. Roman working from graphic reconstructions by M. Rival<sup>8</sup>. The method was expanded to the reconstruction of assemblage systems using life size study models and was applied to many cases, notably the Greek ships Jules-Verne 7 and 9 and the barges Jules-Verne 2, 3 and 5 (Pomey 2003, 2014b).

Based on this work, the Protis project to reconstruct a sailing replica of the Jules-Verne 9 was begun and eventually achieved a few years later, in time for the 2013 celebrations of Marseille as the European Capital of Culture. There were many aims to

7. See also Corré in this volume. X. Corré studied the hatched barges of Marseille port through medieval and modern sources for a doctoral thesis supervised by the CCJ (Corré 2009).

8. R. Roman was also responsible for reconstruction models of several other ancient shipwrecks (Roman 1997).



Fig. 7: The Gyptis, a sailing replica of the Jules-Verne 9 wreck, under sail off Marseille (photo Ph. Groscaux, CNRS/CCJ).

this experimental archaeological project: to recreate the operational process of construction and rediscover the actions and the know-how of the shipbuilders of the period; to verify the feasibility of the plank-based and oriented construction principles and methods that had been deduced from the archaeological examination; to understand the assemblage system of stitches and lashings, and to verify how they held at sea; to learn how to handle the ship with side rudders and an ancient square sail with its system of brails; and to judge the sailing qualities of the boat and its performance under sail and/or oar (Pomey 2014a, 2017a; Pomey, Poveda 2017, 2018, 2019a, 2019b). Along with the drawings and models made by M. Rival and R. Roman, the project also involved precise design specifications drawn up by S. Marlier and myself, which were edited and formatted by Marlier as a CNRS post-doctoral study. Then, Pierre Poveda, who was still a PhD student at the CCJ, developed a computer generated 3D model of the ship. The construction of the vessel, coordinated by Poveda under my guidance, took place in the Borg de Marseille shipyard with the support of the Arkaeos Association in the management of the project (Pomey 2014a; Pomey, Poveda 2018). The boat was launched in October 2013 and, after a period of sea trials, has sailed regularly since then allowing for an accumulation of experimental data on its construction and assembly system and on its sailing qualities (fig. 7) (Pomey, Poveda 2017, 2019a).

The success of this project stands as confirmation of the CCJ's expertise in reconstructing ancient ships, where digital 3D modelling occupies an increasingly important place within experimental archaeology (Poveda 2012, 2015).

During all these years, propelled by studies of the Place Jules-Verne wrecks in the wake of the Madrague de Giens, new research horizons have opened up that look towards the phenomena of technical transitions in ancient nautical architecture (Pomey 2010b). Thus, as regards the Archaic Period, research in the Greek context has focused on the shift from assembly by lashings to assembly by mortise and tenon (Pomey 2010a), while towards the end of antiquity, there is the complex question of the transition from plank-based to a skeleton-based construction (Pomey *et al.* 2012).

Giulia Boetto joined the CCJ after her recruitment to the CNRS in 2007. Her PhD thesis had been on the Roman boats of Fiumicino in relation to the port complex of Portus-Ostia (Boetto 2006, 2008, 2010, 2016a), and this led her to develop a

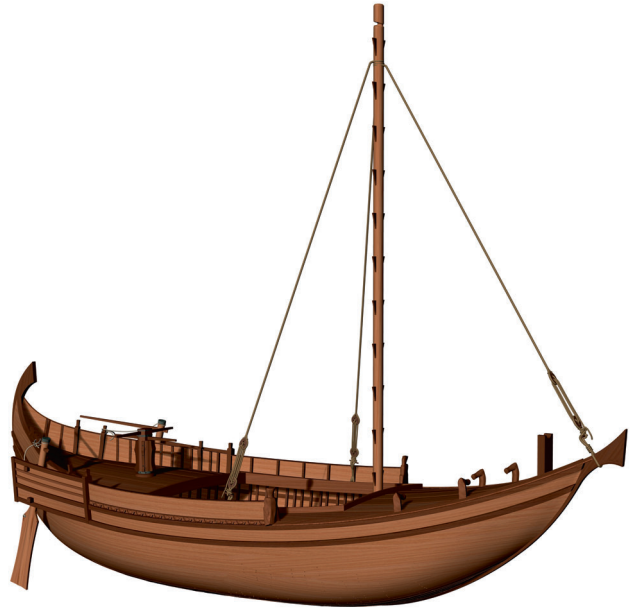


Fig. 8: 3D reconstruction model of the caudicaria Fiumicino 1 (modelling by D. Peloso, Ipso Facto, Marseille and P. Poveda, CNRS/CCJ, courtesy Parco Archeologico di Ostia Antica).

research programme focusing on fluvio-maritime shipping and the organisation of ports from the nautical point of view (distribution and maintenance of basins, the circulation of ships). Alongside the *naves caudicariae* of Fiumicino (fig. 8), identified as lighters navigating between Rome, Ostia and Portus, she managed to reveal several other types of coasters and service craft with either a blunt bow or stern transom at Naples (Boetto 2005, 2009; Boetto *et al.* 2009, 2010, 2019, 2021) (fig. 9), Toulon (Boetto 2009, forthcoming) and Isola Sacra (Boetto *et al.* 2012a, 2014, 2017)<sup>9</sup>. These studies led her to review the literature, iconography and archaeology referring to the *horeia* type of craft and make a linkage with boating activities of harbours and coastal waters (Boetto 2020) (fig. 10).

Also in 2007, under the leadership of G. Boetto, the CCJ participated in a number of excavations and studies of ancient wrecks in Dalmatia<sup>10</sup>, Istria<sup>11</sup> and the River Kupa<sup>12</sup> (Boetto 2016b) in collaboration with a variety of Croatian partners (Irena Radić Rossi of Zadar University, Ida Koncani Uhač of the Archaeological Museum of Istria, Marko Uhač of the Ministry of Culture of the Republic of Croatia, Krunoslav Zubčić and Igor Miholjek of the Croatian Conservation Institute). These different operations made it particularly clear the importance in this region of a strong tradition of sewn boats attested from the end of the Bronze Age: the Zambratija wreck

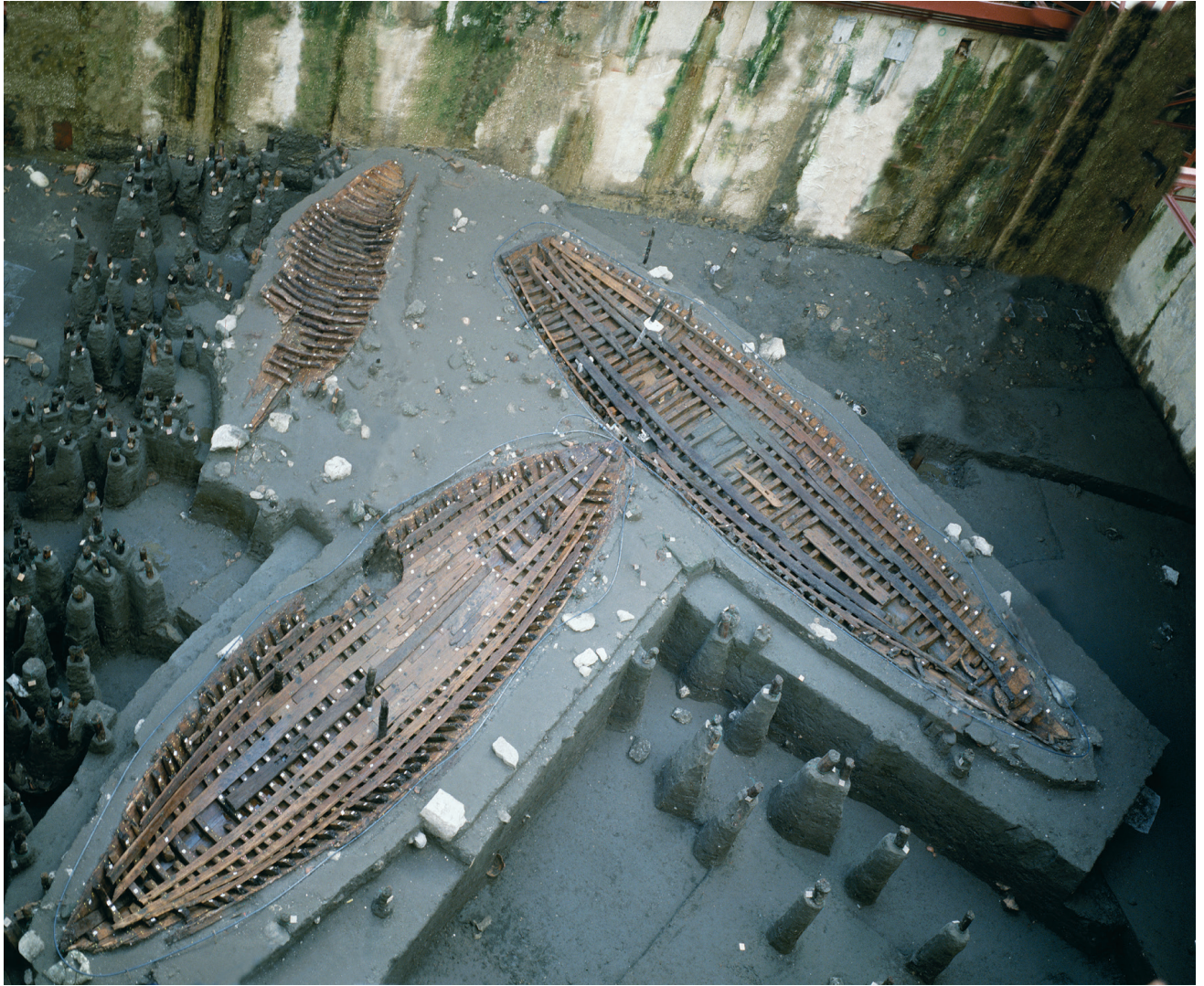
9. Reconstitution models of these harbour craft types were created following the procedure developed by P. Poveda. For the boat with transom bow *Napoli C*, Poveda 2012 et Boetto, Poveda 2014: for the small sailboat *Napoli A*, see, most recently, Boetto, Poveda 2018.

10. Pakoštane wrecks (Boetto *et al.* 2012b; Radić Rossi, Boetto 2018), Caska 1, 2, 3 and 4 (see, most recently, Radić Rossi, Boetto 2020). The Ilovik-Paržine wreck is still being excavated by a team from the Croatian Conservation Institute and CCJ under the joint leadership of I. Miholjek and G. Boetto.

11. Zambratija wrecks (see, most recently, Koncani Uhač *et al.* 2019), Pula 1 and 2 (Boetto *et al.* 2017) and Debeljak.

12. Kamensko wreck (Boetto 2016b et Boetto *et al.* in this volume).





**Fig. 9:** The three wrecks from the ancient port of Naples, Piazza Municipio (photo F. Avallone, courtesy Superintendence of Naples).



**Fig. 10:** 3D reconstruction model of the horeia Toulon 2 (modelling by P. Poveda, CNRS/CCJ).





**Fig. 11:** The Zambratija wreck, Istria, Croatia (photo Ph. Groscaux, CNRS/CCJ and the Archaeological Museum of Istria).

is currently the oldest known example of an ancient craft employing an assembly system of lashings (Koncani Uhač *et al.* 2019) (fig. 11). These investigations in conjunction with the work on the Archaic era wrecks of Place Jules-Verne have revealed the importance in the ancient Mediterranean of assembly by lashings and that this technique was more widespread than we might have suspected. Extending the area of research has revealed evidence of at least six different sewn boat traditions and their evolution from the end of the Bronze Age until the Early Middle Ages (Pomey, Boetto 2019).

The expertise that has been acquired in the field of nautical archaeology has led the CCJ researchers to become involved in numerous aspects of this discipline as varied as riverine nautical archaeology, ships of war, nautical iconography, and Egyptian shipping of the Pharaonic Period. Hence, between 2005 and 2014, M. Rival and P. Poveda took part in the excavation, survey and study of the sunken river barge Arles-Rhône 3 dated to the 1<sup>st</sup> century AD, which was organised by the Museum of Ancient Arles under the supervision of S. Marlier (Marlier 2014).

By looking at Mediterranean influences on Gallo-Roman shipbuilding for inland waters, the CCJ effectively opened up a new and promising area of research (Boetto *et al.* 2011) which has since been enhanced by the excavation and study of a Roman-era flat-bottomed craft from Kamensko (cf. *supra*) and

by the review of other ship discoveries in the River Kupa and the middle Danube basin by a CCJ PhD student, Anton Divić. Likewise, the study of ancient warship wrecks, because of their extreme rarity, is another particularly interesting and novel field of research. Thus, we should mention the participation of G. Boetto and P. Poveda in the study led by Sergey V. Olkhovskiy (Moscow Institute of Archaeology, Russian Academy of Sciences) of the Phanagoria wreck on the east bank of the Straits of Kerch (Russia), which turned out to be a remarkably well preserved wreck of a small military ship from the 1<sup>st</sup> century AD, with a bronze casing displaying symbols of Mithridates VI Eupator (Olkhovskiy 2016, 2017). And lastly, we should note the work undertaken in the domain of historiography, nautical iconography<sup>13</sup> and Egyptian nautical archaeology, especially the examination of vestiges of Middle Kingdom ships discovered at Ain Soukhna (Pomey 2012, 2015b)<sup>14</sup>.

In parallel to research in nautical and maritime archaeology, the CCJ has also engaged in the development of digital tools to be applied to nautical and underwater archaeology. In this respect, we should point out the operational chain developed by Vincent Dumas, topographer, Loïc Damelet and Lionel Roux, photographers, and P. Poveda, which uses photogrammetry surveys and 3D models of ancient shipwrecks to propose theoretical virtual reconstructions of the ships and hydrostatic analyses (Dumas *et al.* 2015; Poveda 2015).

Finally, the CCJ is active in research dissemination and in education through its collection *Archaeonautica*, its seminars, and its participation in the MoMarch programme (Master of Maritime and Coastal Archaeology) of Aix Marseille University, and PhD supervision with the Maison Méditerranéenne des Sciences de l'Homme. The periodical *Archaeonautica* is published through the CNRS, and is dedicated to maritime and nautical archaeology research and submarine and subaquatic archaeology in France and abroad, from prehistory to the 19<sup>th</sup> century. It first appeared in 1997 and now counts some 20 issues composed of collected articles and of monographs. Issue number 14 of 1998 was taken up by the *Proceedings of ISBSA 7*, which was held in 1994 on the island of Tatihou (Saint-Vaast-la-Hougue, France) (Pomey, Rieth 1998) and currently it is to host the *Proceedings of ISBSA 15* from Marseille<sup>15</sup>. As regards the MoMarch master's programme established in 2013 as part of the A\*midex Foundation of Aix Marseille University, the CCJ is a significant participant<sup>16</sup>, contributing, among other activities, the teaching of nautical archaeology under the supervision of G. Boetto.

As we reach the end of this overview of 50 years of CCJ activity in the field of maritime and nautical archaeology, it remains clear that the study of the Mediterranean as a place of exchange and of resources is always at the heart of the Centre's work. The principle avenues of research developed over these years have involved the technical and functional analyses of ships and of navigational systems, the identification of networks

13. Cf. especially for the most recent works, Pomey 2001b, 2006, 2017b, 2019.

14. See also Abd El-Maguid 2009.

15. All issues of *Archaeonautica* are available at: <https://www.persee.fr/collection/nauti> and <https://journals.openedition.org/archaeonautica/>.

16. From 2021, the master's programme is under the supervision of the Institut d'archéologie méditerranéenne-Arkaia of Aix Marseille University. Jean-Christophe Sourisseau, professor at Aix-Marseille University and CCJ member is academic director along with Michel L'Hour, Head Conservator of Heritage and director of DRASSM.

of maritime trade and of port installations, and the examination of means of exploiting the sea's resources, alongside the development of new interdisciplinary approaches open to environmental sciences and of new instruments of research. These are at the core of the CCJ activities and research work, and they have contributed to the development of maritime archaeology as a new historical discipline.

By according an important place to the technical and functional analysis of the ship, the CCJ is respecting the academic

research movement of history of technology that was developed by Aix Marseille University (Amouretti, Comet 1993). And by updating its research programmes and developing new activities within the world of maritime and nautical archaeology, while ensuring a consistency of the spirit that presided over the creation of this wide research field, the Centre Camille Jullian has managed to maintain the innovatory nature of its work and the required high scientific standards which have underpinned its reputation.

## REFERENCES

- ABD EL-MAGUID M.  
2009 *Recherches sur la construction navale antique en Méditerranée orientale de l'Égypte pharaonique à la fin de l'Antiquité. Étude archéologique*, PhD Thesis, Université de Provence (Aix Marseille I) (unpublished).
- AMOURETTI M.-CL., COMET G.  
1993 *Hommes et techniques de l'Antiquité à la Renaissance*, Paris, Armand Colin.
- BASS G.  
2012 Keynote address: A Brief History of Nautical Archaeology in Turkey, in N. Güsenin (ed.), *Between Continents, Proceedings of the Twelfth International Symposium on Boat and Ship Archaeology (ISBSA 12), Istanbul 2009*, Istanbul, Yayinlari, p. xvii-xxv.
- BERNARD-MAUGIRON H.  
2007 Marseille, mille objets et trois épaves à conserver, in H. Bernard-Maugiron, Ph. Coeuré, M. Clermont-Joly, J. Duchêne, P. Vaudaine, P. Veysseyre (eds), *Sauvés des eaux. Le patrimoine archéologique en bois. Histoire de fouilles et de restaurations*, Grenoble, Arc-Nucléart, p. 77-81.
- BOETTO G.  
2005 Le navi romane di Napoli, in D. Giampaola *et alii*, La scoperta del porto di Neapolis: dalla ricostruzione topografica allo scavo e al recupero dei relitti, *Archaeologia Maritima Mediterranea* 2, p. 63-76.  
2006 *Les navires de Fiumicino (Italie) : architecture, matériaux, types et fonctions. Contribution à l'étude du système portuaire de Rome à l'époque impériale*, PhD Thesis, Université de Provence (Aix-Marseille I) (unpublished).  
2008 L'épave de l'Antiquité tardive *Fiumicino 1* : analyse de la structure et étude fonctionnelle, *Archaeonautica*, 15, p. 29-62.  
2009 New archaeological evidences of the *Horeia*-type vessels: the Roman Napoli C shipwreck from Naples (Italy) and the boats of Toulon (France) compared, in R. Bockius (ed.), *Between the seas. Transfer and Exchange in Nautical Technology. Proceedings of the Eleventh International Symposium on Boat and Ship Archaeology (ISBSA 11), Mainz 2006*, Mainz, Römisch-Germanisches Zentralmuseum, RGZM Tagungen Bd 3, p. 289-296.  
2010 Le port vu de la mer : l'apport de l'archéologie navale à l'étude des ports antiques, in S. Keay, G. Boetto (eds), *Portus, Ostia and the Ports of the Roman Mediterranean. Contributions from Archaeology and History, Proceedings of the 17<sup>th</sup> International Congress of Classical Archaeology, Rome 2008*, Rome, Ministero per i Beni e le Attività Culturali, p. 112-128.  
2016a Portus, Ostia and Rome: a transport zone in maritime/land interface, in K. Höghammar, B. Arloth, A. Lindhagen (eds), *Ancient Ports. The Geography of Connections, International Conference at the Department of Archaeology and Ancient History, Uppsala 2010*, Uppsala, Uppsala University, Boreas 34, p. 269-287.  
2016b Recherches d'archéologie navale en Adriatique orientale, *Comptes Rendus de l'Académie des Inscriptions et Belles-Lettres*, novembre-décembre, p. 1401-1422.  
2020 *La batellerie portuaire en Méditerranée à l'époque romaine. Le cas des bateaux à extrémité coupée*, Habilitation à diriger des recherches, Université d'Aix-en-Provence.  
Forthcoming Les épaves du port antique de Toulon, in J.-P. Brun, M. Pasqualini, G. Boetto (eds), *Telo Martius. Une agglomération portuaire romaine de la cité d'Arles*, Aix-en-Provence, PUP / Centre Camille Jullian, BiAMA.
- BOETTO G., POVEDA P.  
2014 La restitution de *Napoli C*. Un navire romain à tableau, in P. Pomey (ed.), *Ports et navires dans l'Antiquité et à l'époque byzantine*, Dijon, Faron, Dossiers d'Archéologie 364, juillet-août, p. 64-65.  
2018 *Napoli A*, un voilier abandonné dans le port de *Neapolis* à la fin du 1<sup>er</sup> siècle : architecture, fonction, restitution et espace de navigation, in G. Boetto, E. Rieth (eds), *De re navali. Pérégrinations nautiques entre Méditerranée et océan Indien. Mélanges en l'honneur de Patrice Pomey*, Paris, CNRS éditions, *Archaeonautica* 20, p. 19-56.
- BOETTO G., CARSANA V., GIAMPAOLA D.  
2009 Il porto di *Neapolis* e i suoi relitti, in X. Nieto, M. A. Cau (eds), *Arqueologia Nàutica Mediterrània*, Girona, CASC-Museu d'Arqueologia de Catalunya, Monografies del CASC 8, p. 457-470.  
2010 I relitti di Napoli e il loro contesto portuale, in S. Medas, M. D'Agostino, G. Caniato (eds), *Archeologia, Storia e Etnologia navale, Atti del II Convegno Nazionale, Cesenatico 2008*, Bari, ISTIAEN / Edipuglia, *Navis* 4, p. 115-122.
- BOETTO G., GHELLI A., GERMONI P.  
2012a Due relitti d'epoca romana rinvenuti a Isola Sacra, Fiumicino (Rm): primi dati sullo scavo e sulla struttura delle imbarcazioni, *Archaeologia Maritima Mediterranea* 9, p. 15-38.  
2014 Isola Sacra (Fiumicino). Nuove scoperte di navi romane, in A. Asta, G. Caniato, D. Gnola, S. Medas (eds), *Archeologia, Storia e Etnologia navale, Atti del II Convegno Nazionale, Cesenatico 2012*, Padova, Libreria Universitaria, *Navis* 5, p. 43-48.  
2017 New Roman Shipwrecks from Isola Sacra (Rome, Italy), in J. Gawronski, A. Van Holk, J. Schokkenbroek (eds), *Ships and Maritime Landscape, Proceedings of the Thirteenth International Symposium of Boat and Ship Archaeology (ISBSA 13), Amsterdam 2012*, Eelde, Barkhuis Publishing, p. 260-266.
- BOETTO G., KONCANI UHAČ I., UHAČ M.  
2017 Sewn Ships from Istria (Croatia), in J. Litwin (ed.), *Baltic and Beyond. Change and continuity in shipbuilding. Proceedings of*

the Fourteenth International Symposium on Boat and Ship Archaeology (ISBSA 14), Gdansk 2015, Gdansk, National Maritime Museum, p. 189-198.

BOETTO G., POMEY P., TCHERNIA A. (EDS)

2011 *Bateaux de navigation intérieure : pratiques régionales et influences maritimes méditerranéennes, Actes de la Table Ronde Internationale, Aix-en-Provence 2008*, Paris / Aix-en-Provence, Errance / Centre Camille Jullian, BiAMA 9.

BOETTO G., ZAZZARO C., POVEDA P.

2021 Final report on the remains of four vessels recently found in the ancient harbour of Naples, Italy (late 2<sup>nd</sup> century BCE – late 3<sup>rd</sup> century CE), in S. Demestica, L. Blue, et al. (eds), *Under the Mediterranean I. Studies in Maritime Archaeology*, Leiden, Sidestone Press, p. 59-74.

BOETTO G., RADIĆ ROSSI I., MARLIER S., BRUSIĆ Z. (EDS)

2012b L'épave de Pakoštane, Croatie (fin IV<sup>e</sup> – début V<sup>e</sup> siècle apr. J.-C.). Résultats d'un projet de recherche franco-croate, *Archaeonautica* 17, p. 105-151.

BOETTO G., ZAZZARO C., GIAMPAOLA D., DAVIDDE PETRIAGGI B., DI GIOVANNI A.

2019 Nuovi relitti dagli scavi del porto di Napoli, in A. Asta, G. Caniato, D. Gnola, S. Medas (eds), *Atti del III Convegno Nazionale dell'Istituto Italiano di Archeologia e Etnologia Navale, Cesenatico 2016*, Limena (PD), Libreriauniversitaria. it Edizioni Navis, 6, p. 29-40.

CARRE M.-B.

1993 L'épave à *dolia* de Ladispoli (Etrurie méridionale), étude des vestiges de la coque, *Archaeonautica* 11, p. 9-29.

1998-1999 Littoral PACA, Var, Ramatuelle : *Camarat 2*, in L. Long et alii, Recherches Sous-Marines, *Gallia Informations*, CD Rom.

2001 L'épave *Camarat 2*, in D. Foy, M.-D. Nenna (eds), *Tout feu tout sable, Mille ans de verre antique dans le Midi de la France*, Musées de Marseille / Edisud, Aix en Provence, p. 103-105.

2018 Quelques pièces pour la manœuvre des voiles découvertes sur l'épave de la Madrague de Giens (Hyères, Var, 70-45 av. J.-C.) in G. Boetto, E. Rieth (eds), *De re navali. Pérégrinations nautiques entre Méditerranée et océan Indien. Mélanges en l'honneur de Patrice Pomey*, Paris, CNRS éditions, *Archaeonautica* 20, p. 57-65.

CARRE M.-B., ROMAN R.

2008 Hypothèse de restitution d'un navire à *dolia* : la construction d'une maquette, *Archaeonautica* 15, p. 175-192.

CHEVALIER Y., HESSE A., POMEY P.

1971 Expérience de détection magnétique sous-marine d'une épave antique, *Prospezioni archeologiche* 6, p. 65-71.

CORRÉ X.

2009 *L'activité portuaire de Marseille dans l'Antiquité. Modélisation à partir de l'analyse des sources antiques, médiévales et modernes*, PhD Thesis, Université de Provence (Aix-Marseille I) (unpublished).

DUMAS V., GROSCAUX PH., BOETTO G.

2015 Application de la photogrammétrie en archéologie navale, in *Les nouveaux enjeux de l'archéologie sous-marine, Revue d'Histoire Maritime* 21, p. 127-156.

GASSEND J.-M. (ED.)

1982 *Le navire antique du Lacydon*, Marseille, Musée d'Histoire.

GUIBAL F., POMEY P.

1998 L'utilisation du matériau-bois dans la construction navale antique : analyse anatomique et dendrochronologique, in E. Rieth (ed.), *Méditerranée antique. Pêche, navigation, commerce, Congrès national des sociétés historiques et scientifiques, 120e, Aix-en-Provence 1995, 121e, Nice 1996*, Paris, CTHS, p. 159-175.

2003 Timber supply and ancient naval architecture, in C. Beltrame (ed.), *Boats, Ships and Shipyards. Proceedings of the Ninth*

*International Symposium on Boat and Ship Archaeology (ISBSA 9), Venice 2000*, Oxford, Oxbow Books, p. 35-41.

2009

Ancient shipwrecks, naval architecture and dendrochronology in the western Mediterranean, in R. Bockius (ed.), *Between the seas. Transfer and Exchange in Nautical Technology. Proceedings of the Eleventh International Symposium on Boat and Ship Archaeology (ISBSA 11), Mainz 2006*, Mainz, Römisch-Germanisches Zentralmuseum, RGZM Tagungen Bd 3, p. 219-226.

HESNARD A.

1994 Une nouvelle fouille du port de Marseille, place Jules-Verne, *Comptes Rendus Académie des Inscriptions et Belles-Lettres*, janvier-mars, p. 195-217.

1999 Le port, in A. Hesnard, M. Moliner, F. Conche, M. Bouiron, *Parcours de Villes. Marseille : 10 ans d'archéologie, 2 600 ans d'histoire*, Marseille / Aix-en-Provence, Musées de Marseille / Édisud, p. 17-76.

2012 L'épave de la Madrague de Giens (Var) et la plaine de Fondi (Latium). Producteurs des vins, des amphores Dr.1B et commerçants, *Archaeonautica* 17, p. 71-93.

HESNARD A., BERNARDI PH., MAUREL CH.,

2001 La topographie du port de Marseille de la fondation de la cité à la fin du Moyen Age, in M. Bouiron, H. Tréziny (eds), *Marseille. Trames et paysages urbains de Gyptis au Roi René, Actes du colloque international d'archéologie, Marseille 1999*, Aix-en-Provence, Édisud, Études Massaliètes 7, p. 159-202.

HESNARD A., CARRE M.-B., RIVAL M., DANGRÉAUX B.

1988 *L'épave romaine Grand Ribaud D (Hyères, Var)*, Paris, éd. du CNRS, *Archaeonautica* 8.

KONCANI UHAČ I., BOETTO G., UHAČ M. (EDS)

2019 *Zambratija. Prapovijesni šivani brod / Prehistoric sewn boat*, Pula, Arheološki muzej Istre, Monographs and catalogues 33.

LIOU B.

1973 Informations archéologiques : Recherches sous-marines, *Gallia* 31, 2, p. 571-608.

1974 L'épave romaine de l'anse Gerbal à Port-Vendres, *Comptes rendus Académie des Inscriptions et Belles-Lettres*, juillet-octobre, p. 414-433.

LIOU B., POMEY P.

1985 Informations archéologiques : Recherches sous-marines, *Gallia* 43, 2, p. 547-576.

MARLIER S.

2005 *Systèmes et techniques d'assemblage par ligatures dans la construction navale antique méditerranéenne*, PhD Thesis, Université de Provence (Aix-Marseille I) (unpublished).

2008 Architecture et espace de navigation des navires à *dolia*, *Archaeonautica* 15, p. 153-173.

2020 L'architecture et l'espace de navigation des navires à *dolia* : une synthèse sur la question, in C. Carrato, F. Cibecchini (eds), *Nouvelles recherches sur les dolia. L'exemple de la Méditerranée nord-occidentale à l'époque romaine (I<sup>er</sup> s. av. J.-C. - III<sup>e</sup> s. ap. J.-C.)*, Montpellier, RAN, Supplément 50, p. 207-219.

MARLIER S. (ED.)

2014 *Arlès-Rhône 3, un chaland gallo-romain du I<sup>er</sup> siècle après Jésus-Christ*, Paris, CNRS éditions, *Archaeonautica* 14.

OLKHOVSKIY S. V.

2016 Underwater explorations, in V.D. Kuznetov, *Phanagoria*, Moscow, p. 48-57.

2017 The Phanagoria shipwreck (Taman Bay, Russia). First attempt at its identification, in J. Gawronski, A. Van Holk, J. Schokkenbroek (eds), *Ships and Maritime Landscape, Proceedings of the Thirteenth International Symposium of Boat and Ship Archaeology (ISBSA 13), Amsterdam 2012*, Eelde, Barkhuis Publishing, p. 477-480.



- POMEY P.
- 1982 Le navire romain de la Madrague de Giens, *Comptes Rendus Académie des Inscriptions et Belles-Lettres*, janvier-mars, p. 133-154.
- 1994 Shell Conception and Skeleton Process in Ancient Mediterranean Shipbuilding, in Ch. Westerdahl (ed.), *Crossroads in Ancient Shipbuilding. Proceedings of the Sixth International Symposium on Boat and Ship Archaeology (ISBSA 6)*, Roskilde 1991, Oxford, Oxbow Books, p. 125-130.
- 1995 Les épaves grecques et romaines de la place Jules-Verne à Marseille, *Comptes Rendus Académie des Inscriptions et Belles-Lettres*, avril – juin, p. 459-484.
- 1997a Madrague de Giens Wreck, in J.P. Delgado (ed.), *Encyclopaedia of Underwater and Maritime Archaeology*, London, British Museum Press, p. 252-253.
- 1998 Conception et réalisation des navires dans l'Antiquité méditerranéenne, in E. Rieth (ed.), *Concevoir et construire les navires. De la trière au picoteux*, Technologie, Idéologies, Pratique, Ramonville Saint-Agne, Érès, Revue d'anthropologie des connaissances XIII, 1, p. 49-72.
- 1999a Les épaves grecques du VI<sup>e</sup> siècle av. J.-C. de la place Jules-Verne à Marseille, in P. Pomey, E. Rieth (eds), *Construction navale maritime et fluviale. Approches archéologique, historique et ethnologique, Actes du 7<sup>e</sup> Colloque International d'Archéologie Navale – Seventh International Symposium on Boat and Ship Archaeology, île Tatihou 1994*, Paris, éd. du CNRS, *Archaeonautica* 14, p. 147-154.
- 1999b Les épaves romaines de la place Jules-Verne à Marseille : des bateaux dragués? in H. Tzalas (ed.), *Tropis V, Proceedings of the 5<sup>th</sup> International Symposium on Ship Construction in Antiquity, Nauplia 1993*, Athens, Hellenic Institute for the Preservation of Nautical Tradition, p. 321-328.
- 2001a Les épaves grecques archaïques du VI<sup>e</sup> s. av. J.-C. de Marseille : épaves Jules-Verne 7 et 9 et César 1, in H. Tzalas (ed.), *Tropis VI, Proceedings of the 6<sup>th</sup> International Symposium on Ship Construction in Antiquity, Lamia 1996*, Athens, Hellenic Institute for the Preservation of Nautical Tradition, p. 425-437.
- 2001b Le renouveau d'une discipline : historiographie de l'archéologie navale antique, in J.-P. Brun, Ph. Jockey (eds), *Technai. Techniques et sociétés en Méditerranée. Hommage à Marie-Claire Amouretti*, Paris, Maisonneuve-Larose, p. 613-623.
- 2003 Reconstruction of Marseilles 6<sup>th</sup> century BC Greek ships, in C. Beltrame (ed.), *Boats, Ships and Shipyards. Proceedings of the Ninth International Symposium on Boat and Ship Archaeology (ISBSA 9)*, Venice 2000, Oxford, Oxbow Books, p. 57-65.
- 2004a La structure du navire de la Madrague de Giens et le type hellénistique, *Ligures, Rivista di Archeologia, Storia, Arte e Cultura* Figure 2, p. 370-373.
- 2004b Principles and methods of construction in ancient naval architecture, in F. M. Hocker, C. A. Ward (eds), *The Philosophy of Shipbuilding. Conceptual approaches to the study of wooden ships*, Collège Station, Texas A&M University Press, p. 25-36.
- 2006 Les graffiti navals de l'agora. Etude préliminaire, in M. Taslialan, Th. Drew-Bear *et alii*, *Fouilles de l'agora de Smyrne : rapport sur la campagne de 2005, Anatolia Antiqua XIV*, p. 327-337.
- 2009 On the Use of Design in Ancient Mediterranean Ship Construction, in H. Nowacki, W. Lefèvre (eds), *Creating Shapes in Civil and Naval Architecture. A Cross-Disciplinary Comparison*, Leiden, Boston, Brill, p. 137-149.
- 2010a De l'assemblage par ligatures à l'assemblage par tenons et mortaises. Introduction, in P. Pomey (ed.), *Transferts technologiques en architecture navale méditerranéenne de l'Antiquité aux temps modernes : identité technique et identité culturelle, Actes de la Table Ronde, Istanbul 2007*, Varia Anatolica XXX, Istanbul, Institut Français d'Etudes Anatoliennes, p. 15-26.
- 2011 Defining a ship: architecture, function, and human space, in A. Catsambis, B. Ford, D.L. Hamilton (eds), *The Oxford handbook of Maritime Archaeology*, Oxford, Oxford University Press, p. 25-46.
- 2012 Pharaonic Ship remains of Ayn Sukhna, in N. Günsenin (ed.), *Between Continents, Proceedings of the Twelfth Symposium on Boat and Ship Archaeology (ISBSA 12)*, Istanbul 2009, Istanbul, Ege Yayınları, p. 7-15.
- 2014a Le projet Prôtis. Construction de la réplique navigante d'un bateau grec du VI<sup>e</sup> siècle av. J.-C., *Comptes Rendus Académie des Inscriptions et Belles-Lettres*, juillet-octobre, p. 1333-1357.
- 2014b L'entretien des ports antiques. Les chalands à clapet de Marseille, in P. Pomey (ed.), *Ports et navires dans l'Antiquité et à l'époque byzantine*, Dijon, Faton, *Dossiers d'Archéologie* 364, juillet-août, p. 62-63.
- 2015a The Madrague de Giens Project in the Wake of the Excavation of the Byzantine Shipwreck at Yassiada, in D. Carlson, J. Leidwanger, S. Kampbell (eds), *Maritime Studies in the Wake of the Byzantine Shipwreck at Yassiada, Turkey*, College Station, Texas A&M. University Press, p. 73-81.
- 2017a The Protis project (Marseilles, France). The construction of a sailing replica of an Archaic Greek boat, in J. Gawronski, A. van Holk, J. Schokkenbroek (eds), *Ships and Maritime Landscapes. Proceedings of the Thirteenth International Symposium on Boat and Ship Archaeology (ISBSA 13)*, Amsterdam 2012, Eelde, Barkhuis Publishing, p. 484-489.
- 2017b A propos de la voile latine : la mosaïque de Kelenderis et les *Stereometrica* (II, 48-49) d'Héron d'Alexandrie, *Archaeonautica* 19, p. 9-25.
- 2019 The Rock Engravings of Boats of Sinai and the Pharaonic Maritime Expedition, in A. Manzo, Ch. Zazzaro, D. Joyce de Falco (eds), *Stories of Globalisation: The Red Sea and the Persian Gulf from Late Prehistory to Early Modernity. Red Sea Project VII, Napoli 2015*, Leiden, Boston, Brill, p. 13-29.
- POMEY P. (ED.)
- 1992 Recherches Sous-Marines, *Gallia Informations*, 1992-1, p. 1-85.
- 1997b *La Navigation dans l'Antiquité*, Aix-en-Provence, Édisud.
- 2010b *Transferts technologiques en architecture navale méditerranéenne de l'Antiquité aux temps modernes : identité technique et identité culturelle, Actes de la Table Ronde Internationale, Istanbul 2007*, Istanbul, IFEA, Varia Anatolica XXX.
- 2015b *La batellerie égyptienne. Archéologie, histoire, ethnographie*, Alexandrie, Centre d'Études Alexandrines, *Études Alexandrines* 34.
- POMEY P., BOETTO G.
- 2019 Ancient Mediterranean Sewn-Boat Traditions, *IJNA* 48.1, p. 5-51.
- POMEY P., PAVEDA P.
- 2017 The Prôtis Project: the Gyptis sailing trials, in J. Litwin (ed.), *Baltic and beyond. Change and continuity in shipbuilding, Proceedings of the Fourteenth International Symposium on Boat and Ship Archaeology (ISBSA 14)*, Gdansk 2015, Gdansk, National Maritime Museum, p. 229-236.
- 2018 Gyptis: Sailing Replica of a 6<sup>th</sup>-century-BC Greek Sewn Boat, *IJNA* 47.1, p. 45-56.
- 2019a Gyptis and the Archaic Greek Sewn-boat Technique, *IJNA* 48.2, p. 416-426.
- 2019b Construction et navigation du *Gyptis*. L'expérimentation appliquée à l'archéologie navale, in N. Monteix, A. Poidevin (eds), *L'expérimentation, un matériau de l'histoire*, Rouen, Le Havre, PURH, p. 15-33.
- POMEY P., RIETH E. (EDS)
- 1998 *Construction navale, maritime et fluviale. Approche archéologique, historique et ethnologique, Actes du 7<sup>e</sup> Colloque International d'Archéologie Navale - 7<sup>th</sup> International Symposium on Boat and Ship Archaeology (ISBSA 7)*, île Tatihou 1994, Paris, CNRS éditions, *Archaeonautica* 14.
- POMEY P., TCHERNIA A.
- 1978 Le tonnage maximum des navires de commerce romains, *Archaeonautica* 2, p. 233-251.

- POMEY P., KAHANOV Y., RIETH E.  
2012 Transition from Shell to Skeleton in Ancient Mediterranean Ship-Construction: analysis, problems, and future research, *IJNA* 41.2, p. 235-314.
- POVEDA P.  
2012 *Le navire antique comme instrument du commerce maritime : restitutions 3D, tonnage, qualités nautiques et calculs hydrostatiques des épaves Napoli A, Napoli C, Dramont E et Jules-Verne 7*, PhD Thesis, Aix Marseille Université (unpublished).  
2015 Méthode de restitution des navires antiques: nouveaux outils et nouvelles analyses des restitutions en archéologie navale, in *Les nouveaux enjeux de l'archéologie sous-marine, Revue d'Histoire Maritime* 21, p. 57-169.
- RADIĆ ROSSI I., BOETTO G.  
2018 *PAKOSTANE VELI SKOLJ. Kasnoantički brodolom u geološko-geografskom i kulturno-povijesnom kontekstu / The Late Roman shipwreck in its geological-geographic, and cultural-historical context*, Zadar, University of Zadar/ Institute for maritime archaeology ARS NAUTICA, ADRIAS series 1.  
2020 The Roman Scuttled Ships and Harbour Structures of Caska, Pag Island, Croatia in their Cultural and Historical Context, *IJNA* 49.2, p. 263-290.
- RIVAL M.  
1991 *La charpenterie navale romaine*, Paris, éd. du CNRS, Travaux du Centre Camille Jullian 4.
- ROMAN R.  
1997 *Étude architecturale comparative de sept navires de commerce gréco-romains et byzantins*, PhD Thesis, Université de Provence (Aix Marseille I) (unpublished).
- SCIALLANO M., MARLIER S.  
2008 L'épave à *dolia* de l'île de la Giraglia (Haute-Corse), *Archaeonautica* 15, p. 113-151.
- STEFFY J.R.  
1994 *Wooden Ship Building and the Interpretation of Shipwrecks*, College Station, Texas A&M University Press.
- TCHERNIA A.  
1968-1970 Premiers résultats des fouilles de juin 1968 sur l'épave 3 de Planier, *Études Classiques* III, p. 51-82.  
1986 *Le vin de l'Italie romaine, essai d'histoire économique d'après les amphores*, Rome, Ecole française de Rome, BEFAR 26.  
2011 *Les Romains et le commerce*, Naples, Centre Jean Bérard / Centre Camille Jullian.
- TCHERNIA A., POMEY P., HESNARD A.  
1978 *L'épave romaine de la Madrague de Giens (Var)*, Paris, éditions du CNRS, XXXIV<sup>e</sup> supplément à Gallia.
- WICHA S.  
2005 *Caractérisation d'un groupe d'épaves antiques de Méditerranée présentant un assemblage des membrures par ligatures végétales. Approche architecturale et paléobotanique*, PhD Thesis, Université de Provence (Aix-Marseille I) (unpublished).
- WICHA S., GIRARD M.  
2006 Archaeological characterisation of three ancient, sewn, Mediterranean shipwrecks, in L. Blue, F. Hocker and A. Englert (eds), *Connected by the Sea. Proceedings of the Tenth International Symposium on Boat and Ship Archaeology (ISBSA 10), Roskilde 2003*, Oxford, Oxbow Books, p. 111-116.



# INNOVATION, INSTITUTIONS AND MIGRATION: TRANSFER OF TECHNOLOGY IN DUTCH SHIPBUILDING, 500-1700

André F.L. VAN HOLK

“For a long time historians [and for that matter archaeologists] systematically underestimated the mobility of workers in pre-industrial Europe, on the assumption that individuals before the nineteenth-century industrialisation and urbanisation were essentially place-bound” (Reith 2009, p. 114).

---

## Abstract

This paper focuses on innovation in shipbuilding. The central question is by what mechanisms innovation took place. Was new technology locally invented or was it transferred, from the outside, as exogenous knowledge? How did technology transfer work? Two main strands of reasoning will be followed. The tainted concept of migration will be revitalised. In addition, the role of guilds will be analysed. The role of guilds is crucial for understanding the system of the tramping journeyman, implying the sharing of new tacit knowledge. The step-by-step development of shipbuilding technology was stimulated by the guild system of transferring knowledge.

## Keywords

Guild, innovation, migration, mobility, shipbuilding

## Résumé

Cet article s’interroge sur la place de l’innovation dans la construction navale. La question centrale est de savoir par quels mécanismes elle s’effectue. La nouvelle technologie a-t-elle été inventée localement ou provient-elle de l’extérieur? Et comment ce transfert de technologie fonctionne-t-il?

Deux grandes pistes d’analyse seront invoquées ici : le concept de migration, la plupart du temps considéré d’un point de vue négatif, sera reconsidéré. Par ailleurs, le rôle des guildes sera analysé, puisqu’il est crucial pour comprendre le système du compagnonnage itinérant, qui implique le partage empirique de nouvelles connaissances. Le développement progressif de la technologie dans la construction navale a donc été vraisemblablement stimulé par un transfert des connaissances opéré à l’intérieur même des guildes.

## Mots-clés

Guilde, innovation, migration, mobilité, construction navale

---

In this paper I would like to discuss the topic of innovation in shipbuilding. The central question I would like to address is: By what mechanisms did innovation take place? A group of economic historians, including Epstein (1994, 2009, 2013), Epstein and Prak (2009), Reith (2009), van Zanden (2009), Prak and van Zanden (2013) among others, as well as the maritime historian Unger (2013), have developed some interesting ideas about innovation and technological change. Another question is: Are these ideas applicable to innovations in Dutch shipbuilding?

A common line of reasoning in current archaeology is that knowledge develops in isolation, for example, as an evolutionary process. On the contrary, I will argue that innovation often takes place as a cultural process of exchange of information and ideas. Information does not spread by itself. For all kinds of exchange, human mobility is essential, at least in the premodern period.

## 1. TRANSFER OF TECHNOLOGY

If technology was transferred, how did it work? Basically we can differentiate between two types of technology transfer.

The first is by the spreading of ideas, which is termed diffusion (for example, through trade), and the second is by migration, a term designating the spatial movement of people (Burmeister 2000, p. 559; 2016, p. 42). Thus, a temporary or permanent change of residence is involved. The duration of the movement of people can take place on three different time scales. The first involves short-term contacts: trade is a good example. Secondly, migration could be temporary: for example, seasonal migration or the wandering of journeymen. The last form of movement is permanent migration: permanent colonisation or the settlement of people in new surroundings. More generally put, technology can be transferred by the mobility of people. This seems obvious for maritime archaeologists, but for most other branches in archaeology it is not. There, an ‘immobilist’ stand is often taken (Hakenbeck 2008, p. 17).

### 1.1. MIGRATION

As scholars of migration archaeology have pointed out (Hakenbeck 2008; Burmeister 2000, 2016), under the culture-historical paradigm in archaeology, migration was used as an

unproven explanation, as an axiom that did not have to be explained any further. As such, it was misused by German archaeologists for nationalistic purposes in the 19<sup>th</sup> and 20<sup>th</sup> century. The advocates of ‘New Archaeology’ totally abandoned the concept of migration because, from their systemic and evolutionary perspectives, historical events like migrations were attributed no explanatory power (Burmeister 2016, p. 49). Of course, the critic was right to condemn the theoretical and methodological deficits of earlier approaches to migration. In particular, the concept of archaeological cultures, their equation with ethnic groups, and the simplistic ways in which migrations were used to explain social change were criticised (Hakenbeck 2008, p. 14). But with this stand, a fundamental factor of human existence was forgotten: people have been on the move constantly and have taken their ideas and customs with them on the way.

Currently, archaeologists of migration are trying to revive the concept of migration (Burmeister, 2000, p. 548-552). Some of the new ideas are:

- Migration is a socio-cultural process that must be studied and not taken for granted;
- Migration can be group specific: gender, age or elite (selective migration);
- Group sizes can differ greatly: from small family-sized groups to larger conglomerations of society (versus presupposed mass migration);
- Migration can be a long term process, taking place over a long period of time in different phases (versus one moment in time);
- Migrating can encompass reverse migration.

One of the problems is that these processes are difficult to trace in the archaeological record.

## 1.2. CULTURE CONTACT

Human mobility might be the best way to achieve technological transfer, but we cannot reverse this statement. Culture contact does not automatically lead to the transfer of technology. For successful innovation by culture contact, there has to be a drive on the receptive side to adopt the innovation. A good example is a man with an *eharo* mask from Papua New Guinea: a sailing vessel is mounted on top of the mask (fig. 1) (Davies, Taçon 2013, p. 114). In reaction to early colonial contact, people of New Guinea tried to find ways to control or counteract the dominant colonial material culture by incorporating that culture into their own world, but clearly without the technological innovative impact. There are many more examples of culture contact between the ‘high technology’ of the western world and the intricate worldview of indigenous people. In these cases the western ‘superior’ technology is often mimicked.

## 2. EXAMPLES OF TECHNOLOGY TRANSFER

### 2.1. THE SPREAD OF THE NORDIC CLINKER SHIPBUILDING TRADITION: A CLASSIC CASE OF MIGRATION

From the 6<sup>th</sup> century BC onwards people of the coastal area of the northern Netherlands lived on manmade dwelling



Fig. 1: Man from Papua New Guinea wearing an *eharo* mask topped by an effigy of a ship (after Davies, Taçon, 2013, p. 114).

mounds built on the salt marshes, so-called *terpen* (province of Friesland) or *wierden* (province of Groningen). This salt marsh area was undiked and would flood temporarily (Nieuwhof 2010, p. 173). Excavations in the area have revealed that at the end of the 4<sup>th</sup> century AD the area was characterised by a completely new composition of material culture (i.e. in housing, metal-working, appearance of cruciform brooches, new pottery types of (Anglo-) Saxon style, introduction of formal cemeteries) suggesting the arrival of new inhabitants (Nieuwhof 2011, p. 56). Another, often overlooked, element of the new composition of material culture is the appearance of clinker nails (van Holk 2003, p. 301). In the 1960s and 1970s, however, in archaeological reasoning the culture-historical paradigm was rejected and with it migration as an explanation for this change.

Once it could be proven that the area was almost completely deserted in the 4<sup>th</sup> century AD, the idea of newcomers started to gain ground. The possible areas of origin of the new inhabitants are the regions between the Weser and Elbe, Schleswig-Holstein and possibly Scandinavia (Nicolay 2010, p. 125).

Among the finds excavated in the artificial dwelling mounds were clinker nails, dating from the 5<sup>th</sup> to the 9<sup>th</sup> century AD. It is not surprising that the new inhabitants took along with them their shipbuilding technology. More curious are some wreck finds of ships supposedly built in the Netherlands, dating from the 15<sup>th</sup> and 16<sup>th</sup> century, built in the Nordic tradition. It seems therefore that the map of the route followed by migrating people from the north has to be revised, because it is very likely that colonists not only populated Great Britain, but also settled the coastal area of the Netherlands. The newcomers continued to build ships the way they were used to do, with overlapping

strakes connected by clinker nails. So, in this case, it is not so much a technology transfer as a continuation of known technology, a continuation of a tradition of shipbuilding.

## 2.2. THE CASE OF THE COG: A REAL MULTI-CULTURAL TECHNOLOGICAL PHENOMENON

I would like to discuss two technological features of the cog: first, the combined flush and lapstrake hull; and second, cross beams in the form of through beams extending through the hull planking. This second feature, however, is not a general constructional feature of cogs.

In my opinion the bottom-based, flush bottom and lapstrake sides of the cog can be traced back to Roman barges built in the Romano-Celtic tradition (Hocker 2004, p. 77; van de Moortel 2011, p. 89). There are more common features that the cog shares with the Romano-Celtic tradition apart from the flush bottom and lapstrake sides: for example, the use of double-clenched nails, the caulking method and the mast step construction (see also Hocker 2004, p. 77; Adams 2003, p. 203). One can wonder about the long ‘gap’ between the Roman era and the first appearance of the cog, but when we take a closer look at vernacular craft, we will see that this supposed gap is filled by a continuous tradition of river craft showing the same planking arrangement up to the Middle Ages and even into recent times, for example, along the Danube (Sarrazin, van Holk 1996) and in Polish waters (Litwin 1991). This concept has been used for centuries, so the combination of flush bottom planks and overlapping side strakes is not an innovation at all. This does not mean that the cog as a total concept was not innovative.

In the last quarter of the 11<sup>th</sup> century AD through beams are introduced into northwestern Europe in several ship types, for example the Kolding cog (dendrochronologically dated to 1188/1189 AD) and the ‘Big Ship’ of Bergen (dendrochronologically dated to 1187/1188). It is interesting to note that the

Kollerup cog of 1155 AD does not feature through beams (Hansen 1944, p. 122; Bill 2002, p. 108).

It is most likely that the introduction of through beams made the building of bigger (higher sides) and more ships easier, especially for ships that were built shell-first. Hand in hand with other changes this resulted in a cheaper, more economical mode of production.

In the Mediterranean the use of the through beam in shipbuilding is widespread and it probably originated there (see also Bill 2002, p. 108). There are many examples from the 1<sup>st</sup> to 10<sup>th</sup> century AD, to name a few: Nemi, Laurons, Pantano Longarini; Yenikapi 5 (fig. 2), 11, 12, 14; Yassi Ada I; Dor 2006 (Casson 1971; Bass, van Doorninck 1982; Throckmorton 1987, p. 94-95; Pomey *et al.* 2012; Navri *et al.* 2013; Pulak *et al.* 2015, p. 55-57; Jones 2017; Ingram 2018; Özsait-Kocabaş 2018). A stone relief depicting the port of Rome from around the 2<sup>nd</sup> century AD also shows through beams (Casson 1971, fig. 144 and 146). In northwestern Europe we have three examples of ships, predating cogs, equipped with through beams. The EPI-Taillebourg wreck was discovered in the Charente River and has a calibrated radiocarbon date of AD 145-420 (Rieth 2006, p. 78-83) and the County Hall ship, reconstructed with several through beams and dating to *circa* 300 AD (Marsden 1994, p. 109-129). The protruding beams of these vessels might be directly related to the Roman presence in northwestern Europe at that time since there are many examples of technology transfer in this region during the Roman Period.

I have to mention one other interesting find with through beams: the 7<sup>th</sup> century Port-Berteau II shipwreck, found in the Charente River near the Atlantic coast of France (Rieth 2000, p. 225-228). Is this an example of a regionally preserved trait from Roman times? Up to now it is an isolated find (for this period), so it is difficult to understand the meaning of this boat in the development of shipbuilding. It is clear that more research is necessary to solve this question. With reference to the Port-Berteau II wreck, an interesting hypothesis has been put

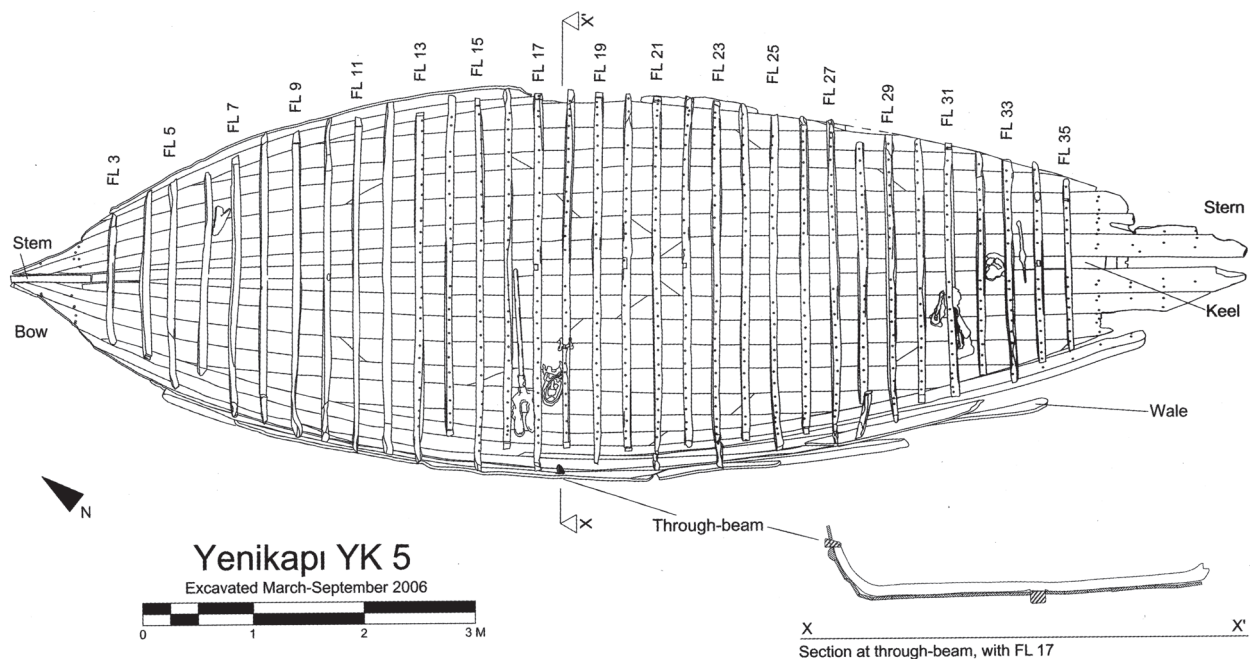


Fig. 2: Through beam of Yenikapi 5, 10<sup>th</sup> century AD (after Pulak *et al.* 2015, p. 55, fig. 17).



forward about the continental influence on the transition from shell to skeleton in Mediterranean ship construction (Pomey *et al.* 2012, p. 305-308). Concerning the through beam, this (reverse) influence is unlikely from a chronological point of view, because the oldest wrecks in the Mediterranean equipped with through beams (Nemi, 1<sup>st</sup> century AD and Laurons, *circa* 200 AD) predate their continental counterparts, except for EP1-Taillebourg. However, in this last case, we have the uncertainty of quite a broad dating range.

But how did the technology transfer work for the protruding beams in the cog? Or was there no transfer at all and was this feature preserved in local vernacular craft like Port Bertheau II?

There could also have been a renewed transfer of technology. In that case we are left with several scenarios. There were contact zones in Spain and southern Germany and contacts over land and by sea. Contact zones in Spain were via the Muslim conquest of Al-Andalus and, later on, Italian shipbuilders that were brought to Iberia to establish a navy for the kingdoms of Castille (1037-1157) and Portugal (1139-1908) (Unger 1980, p. 130). In the 12<sup>th</sup> century, Frederick I Barbarossa was the Holy Roman Emperor, ruling over both northern Italy and southern Germany. Shipbuilding techniques could have crossed the Alps in this context (Vlierman 1997, p. 92). Last but not least and maybe more likely is the technology transfer by sea, especially during the Second Crusade in 1147, when a fleet of 190 ships from different parts of western and southern Europe sailed to Syria (Unger 1980, p. 129).

On the other end of the scale there were two developments going on in northwestern Europe: one is the demand for ships that could carry increasingly larger and heavier cargoes in the growing bulk trade, and the second, taking place at the same time, is the changing organisation of shipbuilding from dispersed shipyards in the countryside to concentrated yards in towns (Bill 2002, p. 110). This last process might have stimulated the sharing of knowledge and openness to new technologies, as this made more intense contacts between shipbuilders possible. Moreover, as towns can be seen as hubs in larger networks, flows of new technology from the outside were more frequent and easy.

To sum up, two traits (and even more) of the cog have their roots in the Romano-Celtic shipbuilding tradition (carvel bottom and overlapping sides) and in the different Mediterranean traditions (through beams). In the first case, there is a clear connection to the Roman occupation from the 1<sup>st</sup> to the 4<sup>th</sup> century AD, while the combination of a flush bottom and overlapping side strakes could have been preserved in vernacular craft. Two shipwrecks north of the Alps show protruding deck beams at an early stage, EP1-Taillebourg and County Hall, and the Roman influence is clear at least in the case of the County Hall wreck. This trait could either have been preserved in local craft (Port-Bertheau II) or reintroduced in various other ways at a later stage.

### 2.3. INTRODUCTION OF THE LEEBOARD

This example concerns the short-term movement of people, i.e. trade. The feature involved is the leeboard and the introduction thereof into Dutch shipbuilding around 1600. Leeboards were used to counteract the leeway of flat-bottomed ships. The leeboard is a drop-shaped assembly of planks, the broader end of which can be lowered along the ship's side, while the

narrower end is attached by a bolt to the side of the vessel. The bolt is the pivot for lowering and raising the leeboard. Both sides of the vessel are equipped with a leeboard. The board on the lee side is always down, while the leeboard at the other side is raised. Most Dutch inland vessels were flat-bottomed, designed to sail in predominantly shallow waters. Moreover, for maximum cargo capacity, the hull form of vessels developed into an almost box-like shape – full bows, flat bottom and straight sides – resulting in very bad sailing capabilities. In order to improve sailing capabilities, especially when sailing close-hauled, leeboards were necessary. One can also put it another way: the introduction of the leeboard made it possible to build bluff-bowed, flat-bottomed vessels.

From around 1600 Dutch inland and coastal vessels were equipped with leeboards. Scholars do not agree on the exact date of the introduction of the leeboard, but it is obvious from iconographical evidence that before *circa* 1600 ships are depicted without, and thereafter with leeboards. This is reflected in the archaeological evidence.

The introduction of this new technology was very quick. A reason for this might be the way the shipbuilding industry was organised. Merchantmen were built on privately owned wharfs, often family-run businesses, with a master in command assisted by journeymen and apprentices (Unger 2013, p. 182). Shipbuilders in northwestern Europe were organised in guilds. These guilds were most common in Germany and the Low Countries (Unger 2013, p. 185). Guilds were sources of both education and innovation. The primary purpose of guilds was training skilled workers. Unintended by-products were invention and innovation (Epstein 2009, p. 52, 2013):

1. Education: guilds trained new carpenters. Education of new tradesmen was one of the principal functions of guilds. Typically, there were provisions for apprenticeships. Guilds promoted, preserved and institutionalised a handicraft tradition, passing on knowledge from individual to individual.

2. Innovation: craft guilds created an environment that was conducive to tacit, embodied, and incremental innovation, because:

- there were levels of freedom to allow for technical advance;
- ideas and practices of others were shared (and I would add, most importantly were discussed) within and across guilds;
- the market structure of many small firms was an incentive to technical change. A number of small firms could engage in a variety of small experiments, generating micro-inventions one after the other. Craft-based invention and the multi-centred, competitive institutional setting in which it was embedded came close to resembling an ideal market structure for innovation.

3. Migration, short term/long term: an important element of the guild organisation was tramping. During his tramping years a journeyman was able to learn about new methods and to pass them on in his next job in some other place, in this way stimulating the influx of new ideas from elsewhere (knowledge exchange). Technological transfer could only be successfully achieved through human mobility. Skilled migrant workers included mainly apprentices and journeymen, who travelled on a seasonal basis, or established masters, whose migrations were more often permanent.

Guilds were not opposed to technological innovation. In pre-modern manufacture, the nature of technological knowledge was largely implicit, which created the need for one-to-one training and meant that technological innovations had to be

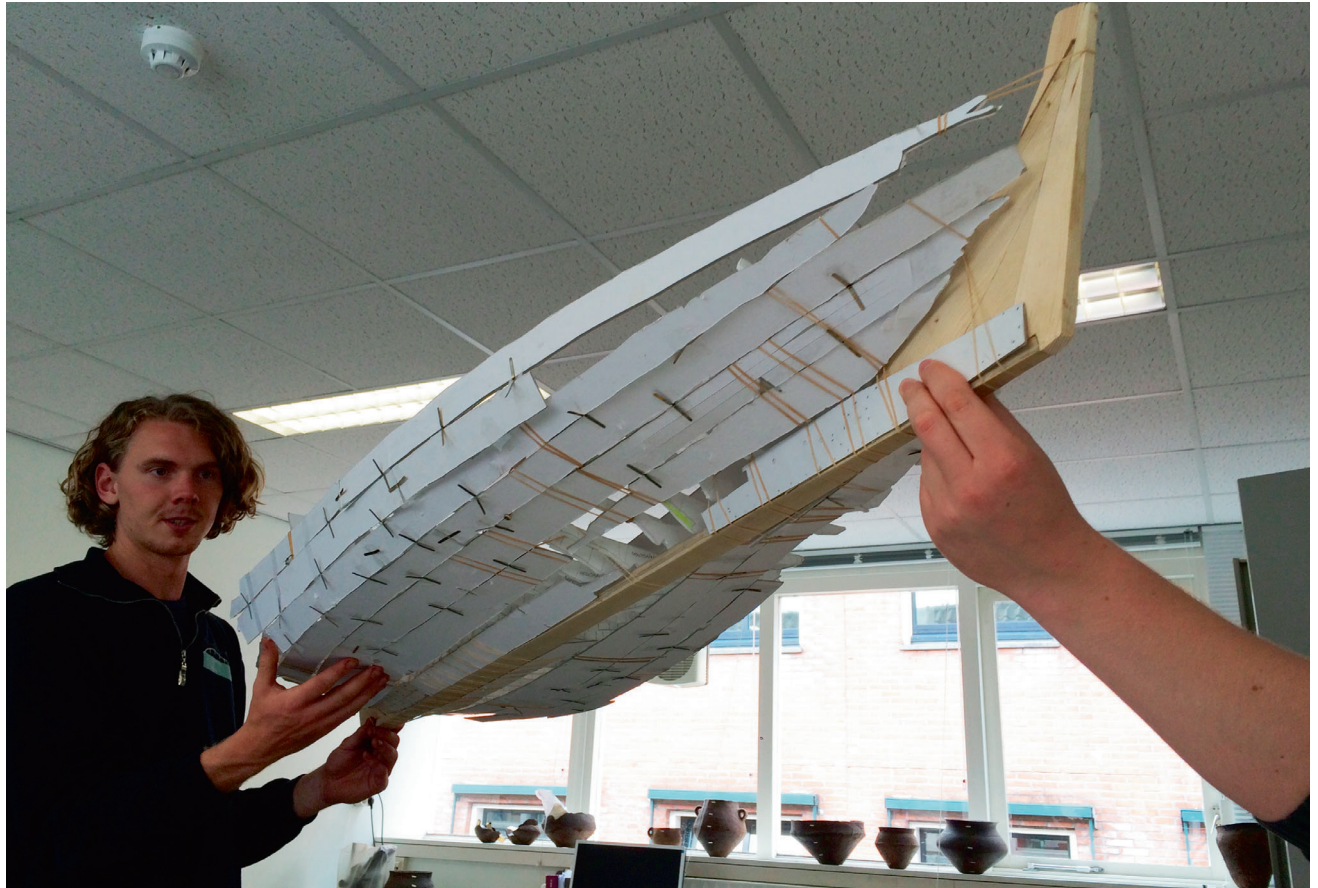


Fig. 3: Model of shipwreck OE 34, Flevoland, Netherlands, showing the slender hull form in the stern (photograph IFMAF).

transferred by travelling craftsmen and engineers (Epstein 2013, p. 54-55). And that is exactly what guilds stimulated.

This perhaps accounts for the quick spread of leeboard use in the Low Countries, but what about the origin of the leeboard? At a conference on maritime archaeology in Penglai, China, I showed a picture of a Dutch vessel equipped with leeboards, a so-called *wijdschip*. I was immediately asked if I knew the origin of the leeboard? I gave the right answer in the opinion of the Chinese audience: it originates in China.

There is indeed a strong chronological argument to accept the idea that Dutch shipbuilders copied the leeboard from Chinese examples (Doran, 1967, p. 39-53). The first, more intensive, contacts of the Dutch with China date from 1595, while the Dutch East Indian Company (VOC) was founded in 1602 (Gaastra 2001, p. 21, 25). The VOC and the Jesuit order acted like “long-distance corporations” that contributed a lot to the accumulation of knowledge about Asia (Hertroijs 2014, p. 8).

Another point to keep in mind is that on their arrival in China, the Dutch were almost immediately impressed by the high standards of Chinese technology in general. The production of porcelain could serve as a good example of the superior techniques, and this product was imported in great quantities very soon after the first contacts. Other examples are the watertight bulkhead, described already by Marco Polo and applied in the 18<sup>th</sup> century by English shipwrights (Hertroijs 2014, p. 7). Hertroijs (2014, p. 4) emphasises that we should realise the mutual character of knowledge exchange between China and

the West and that we should preferably speak about the circulation of knowledge and technology.

At the same time, a development in the design of the hull form of Dutch vessels can be traced, which started in the middle of the 16<sup>th</sup> century. The slender medieval hull of, for example, the cog was modified to a more full-bodied hull form. A vessel that was excavated in the province of Flevoland can serve as an example: it is dated to the mid-16<sup>th</sup> century (fig. 3)(van Holk 2017). As can be seen in the underwater body of this vessel, the stern still shows the ‘medieval’ slenderness, while the bow shows a rather full form. In order to build a full bow and stern, leeboards were essential.

#### 2.4. THE DEVELOPMENT OF THE *FLUIT*

The development of the *fluit* might be another example of the way that the guild system operated. The articulation of established practice was the norm for shipbuilding and for most of the premodern period worldwide. Technological development was a process of many small micro-inventions (Unger 2013, p. 173). Craft innovation was the outcome of small-scale and incremental practical experiment and of random variation (Epstein 2009, p. 70). This is exactly what could thrive through the closely-knit guild infrastructure.

The *fluit* is a three-masted seagoing merchantman of about 86 to 140 feet in length (24-39 m) with a cargo capacity between 55 (earliest examples) and 200 (later examples) last (equivalent



to 100 to 400 tons) dating to the 17th and 18th century (fig. 4) (Wegener-Sleeswijk 2003, p. 53-54, 66, 71, 97-99; Eriksson 2014, p. 11).

Their length was at least four times their width. In addition to their slenderness, they had a shallow draught. Another typical element of the hull form was the strong tumblehome (the inward curvature of the upper parts of the sides), resulting in a rather narrow deck. In a short time it became a 'bestseller' (not uncommon for books, but more so for ships). It became the most used merchantman on the North Sea and the Baltic (Wegener-Sleeswijk 2003, p. 20; Eriksson 2014, p. 10).

In historic sources it is mentioned that the *fluit* was the invention of the merchant Pieter Jansz Liorne. This is described by Theodorus Velius in his chronicle of the West Frisian town of Hoorn in 1604. According to Velius' interpretation, the first *fluiten* were built there in 1595.

At that time many skippers of the Dutch merchant fleet were Baptists (or Mennonites). As pacifists on the basis of their religious belief, they sailed without cannonry and thus saved weight, allowing them to build a longer, but not wider, ship, and a more slender vessel was the result. We might possibly attribute to the merchant Pieter Jansz Liorne the novel insight that the weight reduction could be used to give the fluyt a still more slender form. He did not invent the fluyt, but he was the sponsor of this experimental slender form, who took the financial risk to build vessels this way. The longer ship had more cargo capacity, while the same number of hands was needed to sail the vessel.

According to André Wegener-Sleeswijk (2003), who has written a comprehensive study about the *fluit*, the development

of this vessel should be seen as the outcome of a step-by-step development in building bigger and more slender ships that started much earlier. As predecessors, he mentions the *boot* and the (herring) buss.

Probably, so-called *verlangers* were the inspiration for the hull form of the *fluit*, along with the herring buss and the *boot*. From this point of view, the fluyt was not the result of an invention but of small, successive improvements in the shipbuilding industry. Dutch shipbuilders had started to lengthen several ship types: these ships were called *verlangers*. This tricky operation was necessary because of the economic revival in the northern Netherlands and the corresponding increased demand for cargo capacity that followed the collapse of the Spanish Armada in 1588 (Wegener-Sleeswijk 2003, p. 29-32, 39-48). This incremental development of technological innovation is typical of an industry organised in guilds.

## 2.5. FORE-AND-AFT RIG

This last example is about rigging. Again we encounter the refinement of existing designs, the exploration of the potential of new technology (Unger 2013, p. 175), and the previously mentioned step-by-step incremental development of tacit knowledge typical of an industry organised in guilds.

The spritsail was in use on Dutch inland vessels in the 16th century. At about the same time as the spritsail, a sail rigged on a forestay was introduced (Unger 1978, p. 55). This arrangement of a single mast and fore-and-aft sails was the type of rig that could be easily handled by one man. This new uncomplicated combination appeared on small boats used on rivers and estuaries.

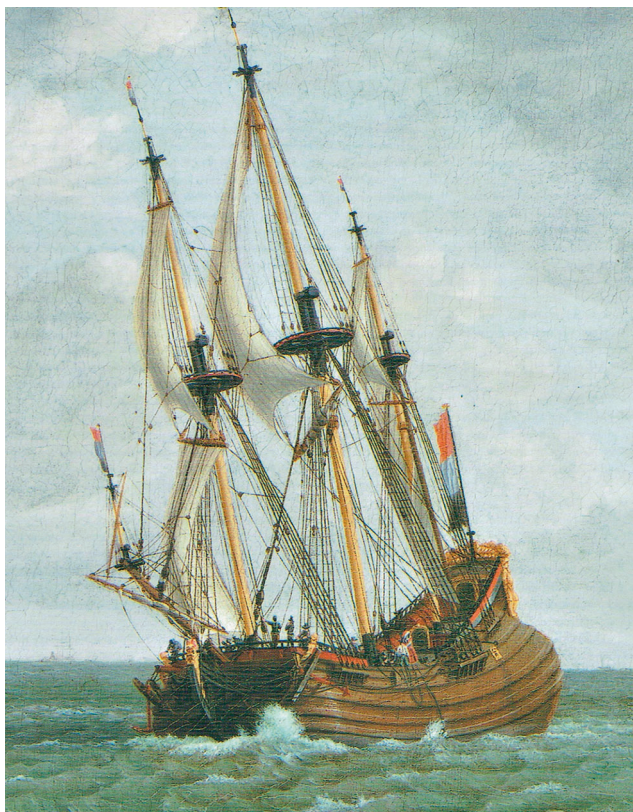
In the 17th century this rig was introduced on seagoing vessels in combination with a square rig (Unger 1978, p. 56). The fore-and-aft rig had several advantages: easier handling (less hands needed); closer sailing to windward (making trips shorter); and greater manoeuvrability. Here we see a transfer of technology from small inland vessels to larger seagoing ones.

According to McGregor (1985, p. 166) the rig of Dutch *kofs* and galliots was adopted by the British, as there was a continual traffic of vessels between Dutch and British ports. This is an example of ships being an advertisement for themselves. Experiential knowledge was embedded in objects, and objects could travel and be observed.

## 3. CONCLUDING REMARKS

In this paper the importance of the movement of people, either in the form of (im)permanent migrations or as part of the guild structure (the tramping journeyman) of the shipbuilding industry, has been shown in respect to technological innovation.

In practice, technological transfer could only be successfully achieved through human mobility. Moreover guilds were not opposed to technological innovation (Epstein 2013, p. 55-57). According to Epstein (2009, p. 52), technological invention and innovation in the pre-industrial economy are still poorly understood. This is partly because of the difficulty in identifying the small-scale and anonymous innovations that dominated technical progress at the time. However, the problem is compounded



**Fig. 4:** A fluit, sailing close to the wind (detail), probably painted around 1680 by Claes Jansz. Rietschoof (Wegener-Sleeswijk 2003, p. 12, fig. 1).



by several long-standing assumptions about premodern manufacture, in particular by the view that from the 15<sup>th</sup> century onwards craft guilds, which provided European urban manufacture with its main institutional framework for over 600 years, were organised rent seekers systematically opposed to technical

innovation. On the contrary, the primary purpose of craft guilds was to provide adequate skills training through formal apprenticeship. Technological invention and innovation were a significant, albeit mostly unintended, effect of the crafts' support for the investment in skills.

## REFERENCES

- ADAMS J.  
2003 *Ships, innovation & social change: Aspects of carvel shipbuilding in northern Europe 1450 – 1850*, PhD thesis, Stockholm University, Stockholm studies in archaeology 24, Stockholm marine archaeology reports 3.
- BASS G. F., VAN DOORNINCK F.H.  
1982 *Yassi Ada. Vol. 1, A Seventh-Century Byzantine Shipwreck*, College Station, Texas A&M. University Press.
- BILL J.  
2002 The Cargo Vessels, in L. Berggren, N. Hybel, A. Landen (eds), *Cogs, Cargoes, and Commerce: Maritime Bulk Trade in Northern Europe, 1150-1400*, Toronto, Pontifical Institute of Medieval Studies, p. 92-112.
- BURMEISTER S.  
2000 Archaeology and Migration, Approaches to an Archaeological Proof of Migration, *Current Anthropology* 41.4, p. 539-567.  
2016 Archaeological Research on Migration as a Multidisciplinary Challenge, *Medieval Worlds* 4, p. 42-64.
- CASSON L.  
1971 *Ships and Seamanship in the Ancient World*, Baltimore and London, The John Hopkins University Press.
- DAVIES S. M., TAÇON P. S. C.  
2013 Images of introduced watercraft and Europeans on indigenous material culture from northern Australia and the south-western pacific region, 1820-1920, in *Maritime Rock Art, Special Issue, The Great Circle* 35.2, p. 103-114.
- DORAN E.  
1967 The origin of leeboards, *The Mariner's Mirror* 53.1, p. 39-53.
- EPSTEIN S. R.  
1994 Regional Fairs, Institutional Innovation, and Economic Growth in Late Medieval Europe, *The Economic History Review, New Series* 47.3, p. 459-482.  
2009 Craft Guilds, Apprenticeship, and Technological Change in Pre-industrial Europe, in S. R. Epstein, M. Prak (eds), *Guilds, Innovation, and the European Economy, 1400-1800*, Cambridge, Cambridge University Press, p. 52-80.  
2013 Transferring Technological Knowledge and Innovating in Europe, c.1200 – c.1800, in M. Prak, J. L. van Zanden (eds), *Technology, Skills and the Pre-Modern Economy in the East and the West*, Leiden & Boston, Brill, p. 25-67.
- EPSTEIN S. R., PRAK M. (EDS)  
2009 *Guilds, Innovation, and the European Economy, 1400-1800*, Cambridge, Cambridge University Press.
- ERIKSSON N.  
2014 *Urbanism Under Sail. An archaeology of fluit ships in early modern everyday life*, Huddinge, Södertörns högskola.
- GAASTRA F. S.  
2001 *De geschiedenis van de VOC*, Zutphen, Walburg Pers.
- HAKENBECK S.  
2008 Migration in Archaeology: are we nearly there yet?, *Archaeological Review from Cambridge* 23.2, p. 9-26.
- HANSEN K.E.  
1944 Kolding Skibet. Foreløbig meddelelse om fund af middelalder-skib, *Aarvog 1944*, Helsingør, Handels-og Søfartsmuseet paa Kronborg, p. 119-129.
- HERTROJIS E. R.  
2014 *Hoe kennis van China naar Europa kwam. De rol van jazuïten en VOC-dienaren, circa 1680-1795*, PhD thesis, Vrije Universiteit Amsterdam.
- HOCKER, F. M.  
2004 Bottom-based shipbuilding in Northwestern Europe, in F. M. Hocker, C. A. Ward (eds), *The Philosophy of Shipbuilding. Conceptual approaches to the study of wooden ships*, College Station, Texas A&M. University Press, p. 66-93.
- HOLK VAN A. F. L.  
2003 Clenched Lap-Strake Boat Finds from the Netherlands, between 1200 and 1600, in C. Beltrame (ed.), *Boats, Ships and Shipyards, Proceedings of the Ninth International Symposium on Boat and Ship Archaeology (ISBSA 9), Venice 2000*, Oxford, Oxbow Books, p. 296-305.  
2017 *Een Wijsdship, Watergeuzen en Wolfsklngen: Opgraving van een scheepswrak aan de Vogelweg (gem. Lelystad), vergaan in 1572*, Groningen, Groninger Instituut voor Archeologie, Rijksuniversiteit Groningen, Grondsporen 26.
- INGRAM R.  
2018 The Hull of Yenikapı Shipwreck YK 11: a 7th-century merchant vessel from Constantinople's Theodosian Harbour, *IJNA* 47.1, p. 103-139.
- JONES M. R.  
2017 The Hull Construction of Yenikapı 14 (YK 14), a Middle Byzantine Shipwreck from Constantinople's Theodosian Harbour, Istanbul, Turkey, *IJNA* 46.2, p. 253-283.
- LITWIN, J.  
1991 Clinker and carvel working boats on Polish waters. Their origin, development and transformations, in R. Reinders, K. Paul (eds), *Carvel Construction Technique, Fifth International Symposium on Boat and Ship Archaeology (ISBSA 5), Amsterdam 1988*, Oxford, Oxbow books, Oxbow Monograph 12, p. 112-121.
- MACGREGOR D. R.  
1985 *Merchant Sailing Ships 1775-1815. Sovereignty of Sail*, London, Conway Maritime Press.
- MARSDEN P.  
1994 *Ships of the Port of London: First to eleventh centuries AD*, London, English Heritage, English Heritage Archaeological Monographs 3.

- MOORTEEL VAN DE A.  
2011 Medieval boats and ships of Germany, the Low Countries, and northeast France – archaeological evidence for shipbuilding traditions, shipbuilding resources, trade, and communication, in *Marschenratskolloquium 2009 / Marschenrat Colloquium 2009: Flüsse als Kommunikations- und Handelswege / Rivers as Communication and Trade Routes, Bremerhaven 2009*, Rahden / Westfalen, Leidorf, Siedlungs- und Küstenforschung im südlichen Nordseegebiet / Settlement and Coastal Research in the Southern North Sea Region 34, p. 67-104
- NAVRI R., KAHANOV Y., CVIKEL D.  
2013 The Byzantine-Period Dor 2006 Shipwreck, Israel: preliminary hull construction report, *IJNA* 42.2, p. 305-325.
- NICOLAY J. A. W.  
2010 Settlement research and material culture in the northern Netherlands: Herrenhöfe and other evidence of socio-political differentiation, in *Probleme der Küstenforschung im südlichen Nordseegebiet*, Rahden / Westfalen, Leidorf, Siedlungs- und Küstenforschung im südlichen Nordseegebiet / Settlement and Coastal Research in the Southern North Sea Region 33, p. 119-132
- NIEUWHOF A.  
2010 Living in a dynamic landscape: prehistoric and proto-historic occupation of the northern-Netherlands coastal area, in H. Marencic, K. Eskildsen, H. Farke, S. Hedtkamp (eds), *Science for Nature Conservation and Management: the Wadden Sea Ecosystem and EU Directives, Proceedings of the 12th International Scientific Wadden Sea Symposium, Wilhelmshaven 2009*, Wilhelmshaven, Common Wadden Sea Secretariat, Wadden Sea Ecosystem 26, p. 174-178.  
2011 Discontinuity in the Northern-Netherlands coastal area at the end of the Roman Period, in T. A. S. M. Panhuysen (ed.), *Transformations in North-Western Europe (AD 300-1000), Proceedings of the 60th Sachsensymposium, Maastricht, 2009*, Hannover, Theiss, Neue Studien zur Sachsenforschung 3, p. 55-66.
- ÖZSAIT-KOCABAŞ I.  
2018 The Yenikapi 12 Shipwreck, a 9th-Century Merchantman from the Theodosian Harbour in Istanbul, Turkey: construction and reconstruction, *IJNA* 47.2, p. 357-390.
- POMEY P., KAHANOV Y., RIETH E.  
2012 Transition from Shell to Skeleton in Ancient Mediterranean Ship-Construction: analysis, problems, and future research, *IJNA* 41.2, p. 235-314.
- PRAK M., VAN ZANDEN J. L. (EDS)  
2013 *Technology, Skills and the Pre-Modern Economy in the East and the West*, Leiden & Boston, Brill.
- PULAK C., INGRAM R., JONES M.  
2015 Eight Byzantine Shipwrecks from the Theodosian Harbour Excavations at Yenikapi in Istanbul, Turkey: an introduction, *IJNA* 44.1, p. 39-73.
- REITH R.  
2009 Circulation of Skilled Labour in Late Medieval and Early Modern Central Europe, in S.R. Epstein, M. Prak (eds), *Guilds, Innovation, and the European Economy, 1400-1800*, Cambridge, Cambridge University Press, p. 114-142.
- RIETH E.  
2000 The medieval wreck from Port-Berteau II (Charente-Maritime, France), in J. Litwin (ed.), *Down the river to the sea, Proceedings of the Eighth International Symposium on Boat and Ship Archaeology (ISBSA 8), Gdańsk 1997*, Gdańsk, Polish Maritime Museum, p. 225-228.  
2006 A preliminary report on the hull characteristics of the Gallo-Roman EPI-Taillebourg wreck (Charente-Maritime, France): archaeological evidence of regional practices of ancient flat-bottomed construction?, in L. Blue, F. Hocker, A. Englert (eds), *Connected by the sea, Proceedings of the Tenth International Symposium on Boat and Ship Archaeology (ISBSA 10), Roskilde 2003*, Oxford, Oxbow Books, p. 78-83.
- THROCKMORTON P.  
1987 Reconstruction and conservation/ the shipwright's art, in P. Throckmorton (ed.), *The Sea Remembers. Shipwrecks and Archaeology from Homer's Greece to the Rediscovery of the Titanic*, Weidenfeld & Nicolson, New York, p. 92-100.
- SARRAZIN J., HOLK VAN A.F.L.  
1996 *Schopper und Zillen. Eine Einführung in den traditioneller Holzschiffbau im Gebiet der deutschen Donau*, Bremerhaven / Hamburg, Deutsches Schiffahrtsmuseum / Kabel Verlag, Schriften des Deutschen Schiffahrtsmuseums 38.
- UNGER R. W.  
1978 *Dutch Shipbuilding before 1800*, Assen, Van Gorcum.  
1980 *The Ship in the Medieval Economy 600-1600*, London / Montreal, Croom Helm / McGill-Queens's University Press.  
2013 The Technology and Teaching of Shipbuilding 1300-1800, in M. Prak, J. L. van Zanden (eds), *Technology, Skills and the Pre-Modern Economy in the East and the West*, Leiden & Boston, Brill, p. 161-204.
- VLIERMAN, K.  
1997 De middeleeuwse kogge: scheepsarcheologische vondsten in het Zuiderzeegebied, in D.E.H. de Boer, E.H.P. Cordfunke, H. Sarfatij (eds), *Holland en het water in de middeleeuwen. De strijd tegen het water en beheersing en gebruik van het water*, Verloren, Hilversum, p. 71-95.
- WEGENER-SLEESWIJK, A.  
2003 *De Gouden Eeuw van het Fluitschip*, Franeker, Van Wijnen.
- ZANDEN VAN J. L.  
2009 *The Long Road to the Industrial Revolution. The European Economy in a Global Perspective, 1000-1800*, Leiden & Boston, Brill.

# FINDING *SCEPTER*: ASSESSING EUROPEAN INFLUENCES IN EARLY SWEDISH SHIPBUILDING AND EVALUATING NEW EXCAVATION TECHNIQUES

Jim HANSSON

---

## Abstract

In 2017 the Swedish National Maritime and Transport Museums were commissioned to monitor the excavation at the old shipyard at Skeppsholmen's quay in Stockholm in case remains were revealed. The shipyard was the biggest workplace in the 17<sup>th</sup> century. During the excavation a careening dock that was used for the maintenance and repair of large naval ships was first found. It was made of a large number of huge piles. The piles were pulled up and massive ship parts appeared beneath. It turned out to be a large shipwreck in oak. Due to the short time available we tried a new technique. We used a powerful suction digger so as not to damage the roots of trees during excavations. The suction digger helped us to remove the fill material very smoothly and quickly. With this method we managed to uncover large parts of the starboard side. A great number of dendro-samples were taken and it was also possible to conduct detailed archaeological documentation.

The identification of the *Scepter* was made with the support of archaeological observations and dendrochronological samples, confirmed by archival documents. With these results we could see that this ship was indeed the first flagship of King Gustav II Adolf. The ship had a long and exciting history that now could be revealed.

This is a fine example of how salvage archaeology together with new techniques can give us new information and great history that was once forgotten.

## Keywords

Maritime archaeology, 17<sup>th</sup> century, shipbuilding, shipyard, warship, wreck

## Résumé

En 2017, les Musées Nationaux Suédois de la Marine et des Transports ont été chargés de surveiller les fouilles préventives à l'emplacement de l'ancien chantier naval du quai de Skeppsholmen à Stockholm. Ce chantier naval a employé un très grand nombre de travailleurs de la région au XVII<sup>e</sup> siècle. Au cours de la fouille, un quai de carénage utilisé pour l'entretien et la réparation de grands navires de guerre a été découvert. Il était constitué de nombreux poteaux de grandes dimensions qui, une fois enlevés, ont laissé apparaître de massives structures en chêne appartenant à un navire. En raison du peu de temps disponible, nous avons eu recours à une nouvelle technique de fouille et utilisé un puissant excavateur à suction initialement destiné au dégageage de racines d'arbres. Cette machine a permis, en facilitant le déblayage de l'épave, de découvrir rapidement une grande partie du flanc tribord. Un grand nombre d'échantillons de bois ont été prélevés. En parallèle, une documentation archéologique détaillée des vestiges a été réalisée. Les observations archéologiques, les analyses dendrochronologiques et les documents d'archive ont permis d'identifier le navire comme le *Sceptre*, premier navire amiral du roi Gustav II Adolf.

La longue et passionnante histoire de ce navire a ainsi pu être de nouveau évoquée. Cette opération offre un bel exemple de la façon dont l'archéologie préventive, associée à l'utilisation de nouvelles techniques, peut apporter des informations inédites et faire revivre un pan important d'une histoire oubliée.

## Mots clés

Archéologie maritime, XVII<sup>e</sup> siècle, construction navale, chantier naval, navire de guerre, épave

---

When King Karl IX died in autumn 1611 he left Sweden in a difficult situation. The country was poor and the army and navy were in a bad condition. In addition, Sweden was at war with three countries simultaneously: Denmark, Poland-Lithuania and Russia. His son, Gustav II Adolf took over the crown at only 16 years of age and in these circumstances it was of course a very difficult task. Therefore, the young king decided early in his reign to equip his war machine. Together with Chancellor Axel Oxenstierna, he concentrated on setting up a system of government agencies, courts and other authorities to create a modern bureaucracy and thus strengthen Sweden. Gustav II Adolf's half-brother, Admiral Carl Carlsson Gyllenhielm, who returned home after 12 years in Polish captivity, also had a large part in the plans of the young king. Together, they decided that more ships needed to be built to strengthen the fleet, which

was considered an important part of the plans. Gyllenhielm and the young monarch tried to maintain and rebuild the fleet and make it modern and competitive.

Almost 400 years after the king's plans, an archaeological excavation of Skeppsholmen's quay began in central Stockholm (fig. 1). The Swedish National Maritime and Transport Museums were commissioned to monitor the excavation in case cultural remains were revealed. We were going to dig right into the naval base and shipyard, which was the biggest workplace in the 1600s, where, among other things, famous ships such as the *Kronan* (the Crown) and *Svärdet* (the Sword) were built.

Numerous heavy piles were found bearing inscriptions we had never seen before. The inscriptions are probably a marking system on timber that was floated to the shipyard and which only the fleet used. It consisted of numbers but also letters that



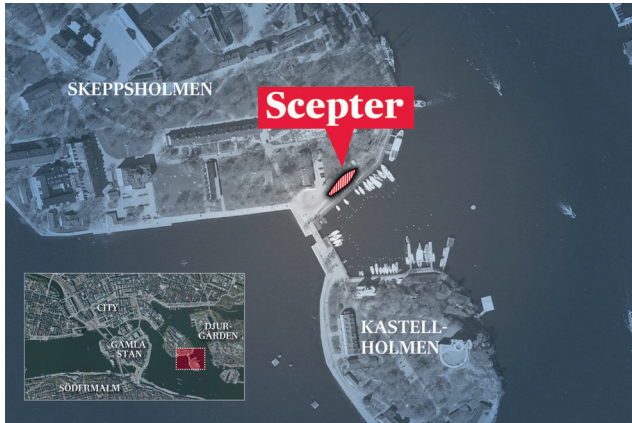


Fig. 1: Location of the Scepter in Stockholm.

almost looked like Viking Age runes. When I cross-referenced old historical maps, it appeared that we had dug straight into a careening dock that was used for the maintenance and repair of large naval ships.

The piles were lifted and beneath were ship parts. We documented the parts and took samples for age analysis. After deliberation with the county administrative board, it was decided that we should try to bring out the bow and stern in order to understand the direction and size of the wreck. Because we had to work fast, I had the idea of using a powerful suction digger that I had seen being used. This was able to excavate without damaging the roots of trees during excavations. The suction digger, essentially a giant vacuum cleaner working something like an airlift does on underwater sites, helped us to remove the fill material very smoothly and quickly. With this method we managed to uncover large parts of the starboard side, the bow and the stern, which then gave us a good idea of the size and shape of the ship (fig. 2).

By allowing us to expose a large part of the wreck quickly with minimal risk of damage, the new technique was crucial in the understanding of the ship's size and construction. To speed things up further, we took photos and made a 3D model of the wreck.

## 1. DESCRIPTION OF THE WRECK

The wreck is built completely in oak. The keel is about 32-33 m long. The largest width is about 9 m. The hull is preserved up to the first wale on the starboard side. The height from the keel to the wale is about 2.2 m. Eroded frames point up a little bit above the wale in some places. The wale is about 18 cm thick. The treenails measure about 3.5 cm in diameter. The planking measures between 34 and 55 cm in width and is approximately 12-15 cm thick. The ceiling measures between 50 and 65 cm in width and about 5-6 cm thick.

In the hull several riders were found in their original location. The function of the riders was to support heavy cannons on the deck above. The riders measure approximately 26 × 30 cm (the riders of *Vasa* measure approximately 37 × 46 cm) and are about 3 m long.

No bilge stringer was found in the wreck. Bilge stringers are a powerful longitudinal timber that stabilises the hull inside. No traces of attachments were found, which means that the ship probably never had any bilge stringer. The close distances between the riders (0.75-1 m) probably had the same function and provided the hull with the stability that was needed even without bilge stringers. According to Fred Hocker (research leader at the *Vasa* Museum), *Vasa* may be one of the first vessels to be built in Sweden with a bilge stringer on top of the riders. The cookroom was found partly preserved just in front of the main mast.

While the stern was exposed quickly and smoothly with the new technique, the ship parts were removed one by one. During the uncovering, a second layer of planking could be noted. It turned out that an approximately 5 cm-thick layer of pine planks was nailed to the original oak hull. On the original hull, several minor repairs could be noted piercing through the hull. These repairs on *Scepter* rendered the hull very weak and there would also be a significant risk of leakage without an outer shell. On *Vasa* there are carved branches in the planking that have been replaced with smaller new pieces of wood but these do not pass through the hull.



Fig. 2: In the left-hand picture we can see the stern with the first rider. The big concrete block is like an anchor that will hold the front of the new quay. In the picture to the right, the starboard side is visible. The big pipe is the suction digger that we used. (left-hand photograph, Annelie Karlsson, Swedish National Maritime and Transport Museums; right-hand photograph, Johan Runer).

The only draft mark was found on this outer planking. It is a cross that symbolises 10 feet. The interesting thing was that on the original hull there were no draft marks and probably never had been. It could therefore have been introduced in the 1620s.

The wreck had been buried deliberately after being stripped, but some ceramics were found that probably belonged to the ship, in addition to some equipment associated with the artillery. An intact quoin and cannonballs were found lying against the ceiling. We also found several different artillery tools on board, which definitely belonged to the ship.

## 2. SCEPTER 1615

Once the results of the dendrochronology analyses were available, it was clear that the wood was Swedish oak felled during the spring of 1613 and the winter of 1613/14 (Daly, in this volume). In Stockholm naval shipyard documents from the 1620s one can see that timber was normally used within two years from the time it was cut. This means that the ship should have been completed in 1615-16 or just after. The outer planking/sheathing that was found had been felled after 1623 (Daly, in this volume).

Now the detective work to try to identify the ship began in earnest. We were quickly able to see that only four ships were built in Sweden during this period: *Scepter*, *Riksnnyckeln*, *Harbo Lion* and *Jupiter* (Glete 2010).

The last two were too small in comparison with the wreck. In 1628 *Riksnnyckeln* sank at Viksten in the Stockholm archipelago: its wreck was discovered in the early 20<sup>th</sup> century. There was only one ship left, *Scepter*. The dendrochronological dating also matched the archives: it matched the initial stage but also the felling after Isbrand's complaint one year later. The Dutch shipbuilder Isbrand Johansson was recruited to Sweden in the year 1600 and his first assignment was the first *Scepter*, built at Stegeborg in Östergötland, 1601-1602 (SH 1600-1604). The ship sank in 1611 (Glete 2010, p. 410).

In October 29, 1612 Isbrand Johansson was again commissioned to build a ship that would also be named *Scepter*.

The name *Scepter* appears on four ships during the 1600s.

- *Scepter*, 1601/02
- *Scepter*, 1615 (which this article is about)
- *Scepter*, 1634.
- *Scepter*, 1678 (later renamed *Carolus XI*).

The construction site of the new *Scepter* was Biskops Arnö located on Lake Mälaren: the availability of oak decided where the shipyard was established. However, already in April 1613, Isbrand complained that the carpenters hardly had any food, and in June he wrote again to the Admiralty that there was no money for shipbuilding (RA RR 119, 24 Sept 1613).

Once again, Isbrand wrote to the king and complained that he and the workers were not being provided for as they should. The king threatened him with the bailiff and ordered him to deliver the goods that had been commissioned immediately (RR 118, 221, 10 April 1613).

In December, Isbrand sent another letter saying that the supply of oak was depleted and they immediately felled more oak in the area in order to continue construction on *Scepter* during 1614. In 1615 the ship was ready for launch.

From Stockholm, some iron, nails and other materials were delivered to the shipyard on Biskops Arnö and it is likely that

*Scepter* was launched in the spring or early summer of 1615. Work continued on *Scepter* during summer, autumn and winter and soon the ship could be brought to Stockholm in 1616. In 1617 the ship was completed with masts at the naval yard in Stockholm (SH 1615).

In the summer of 1618, *Scepter* was finally ready to sail. The ship's crew was estimated to be 370 men. Of these, 120 were sailors, 20 handled the ship's guns and the remaining 250 men were military personnel (SH 1618-19). The first time we are certain that the ship set sail is in August 1618. In a letter to Captain Alexander Forath on the ship *Hannibal*, who was on his way from Stockholm to join the fleet, the Admiralty mentions that at the same time King Gustav II Adolf is on *Scepter*, which he had chosen as the flagship (RR vol. 130 givet av *Scepter*, 2/8 1618).

Under Carl Carlsson Gyllenhielm's command, *Scepter* was the king's flagship. An eyewitness described the inside of the king's cabin when Gustav II Adolf and Gyllenhielm sailed to Germany in the spring of 1620 on the way to secret wedding negotiations in Brandenburg: "A great cabin clad in gilded leather over a green base, green silk taffeta covering the overhead, while the smaller cabin was in double red taffeta covering the overhead and everything" (Hand 1879).

In 1621 Gustav II Adolf decided to move against what was then called Livland (present-day Estonia and Latvia) and the first goal was to conquer Riga, since the city was an important hub for trade and therefore strategically important.

The same year, 148 ships left Sandhamn (an island in the Stockholm archipelago) and headed for Riga. *Scepter* was again the king's flagship, which meant that the king himself was on board and was in command of the fleet. The fleet almost immediately ended up in a severe storm and several vessels had to ride out the storm at sea for three days before they dared to sail to the coast. *Scepter* was one of these and was badly damaged but eventually managed to reach Pernau (Pärnu in Estonia). The king therefore had to travel by land to Riga. After the entire fleet had dispersed in the storm, the fleet gathered again in Dünamünde. But the fleet once again was hit by a storm in which several ships suffered extensive damage, masts were sprung and the navy was therefore forced to make new repairs before they finally sailed away. The king's flagship soon encountered new problems. *Scepter* ran aground on a reef in the evening and the whole fleet again had to anchor and wait for *Scepter*. They managed to get her afloat the following day. Finally, the rest of the ships joined *Scepter* and sailed on to Riga (Lybeck 1945).

During the 1620s, *Scepter* performed several missions guarding different tactical areas in the Baltic and blockading various ports. It may seem like a simple task to patrol and stand watch on the high seas, but correspondence between Carl Carlsson Gyllenhielm (by now Admiral of the Realm) and Chancellor Axel Oxenstierna gives a taste of how rough it could be onboard a patrolling warship in the 1620s.

In the letter it is described that *Scepter* and *Andromeda* were forced to sail from Pillau to Öland with sick sailors. A Dutch *krejare* also sailed with sick sailors, but to Stockholm. It was so bad that it was suggested that both the ships and the sailors could not continue in service for more than two months in a row because of all the diseases that spread quickly on board. This applied to both the common sailors and the officers. There seemed to be no hostile warships, so they thought that they could sail with large parts of the fleet to Kalmar and leave a few guarding the harbour at Pillau (Oxenstierna 1900).



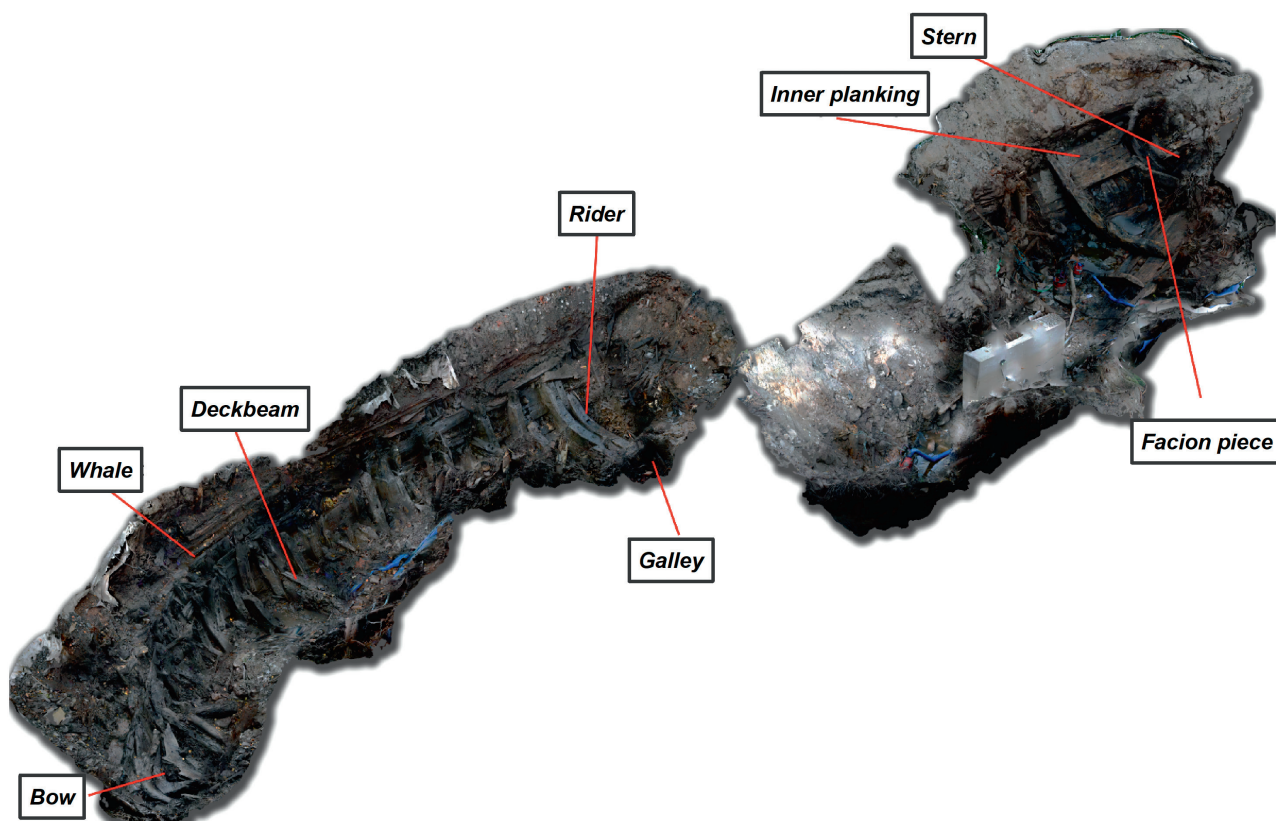


Fig. 3: 3D model of all that was excavated of the Scepter (3D model Jim Hansson, Swedish National Maritime and Transport Museums).

For most of the 1630s, there is no known information about the role *Scepter* played in the fleet. In 1638 and 1639, on the other hand, expenditure on nails and other materials was registered to the *Scepter* (now mentioned in the archives as the *Old Scepter*), which indicates that the ship was probably included as an active part in the naval fleet. We can then follow the ship in the archives until 1640 when 100 small nails for the *Old Scepter* are reported in the navy's daily expense book (Amiralitetskollegiets accounts 1638-40).

Thereafter, the once proud and powerful flagship falls into oblivion.

### 3. DISCUSSION AND INTERPRETATION

Identification would not have been possible without the new digging technique. If we had not had the possibility of exposing the wreck as much as we did, we would not know the size of the ship or seen the profile and so many construction details, such as the absence of the bilge stringer and the outer planking/sheathing.

The identification of *Scepter* was made with the support of archaeological observations and the dendrochronological samples that matched letters in the archives. The fact that it was discarded around 1640 also supports the identification, since the shipyard was moved to Skeppsholmen in 1640 and they started building new facilities directly, such as a careening dock.

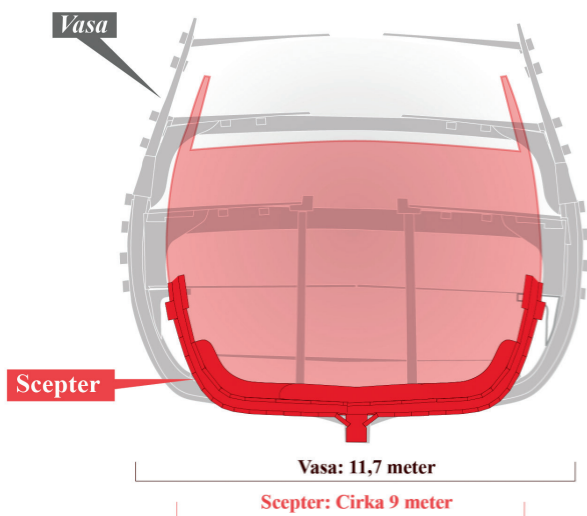
Based on the 3D model that was established during documentation, it was possible to subsequently analyse and document the hull. *Scepter's* technical details are very interesting. We have no other archaeological finds before *Vasa* to compare with (fig. 3). The 3D model could be sliced and in this way a hull profile could be drawn. The profile and reconstruction of the ship provided exciting results (fig. 4).

It turns out that *Scepter's* hull profile is almost identical to *Vasa's*. This is perhaps not so strange since Dutch shipbuilders built both ships, but given *Vasa's* history and all the theories about her construction and the cause of the sinking, it is exciting to see how similar they are (see Fred Hocker 2018). *Scepter* shows that the Dutch method was used at least ten years earlier than *Vasa*. It is very interesting that Isbrand Johansson is one of the first Dutch shipbuilders to start building warships in Sweden. Perhaps there are some national influences in *Scepter's* construction, but at present this is very difficult to determine, as there are no other good archaeological finds documented around the period when *Scepter* was built.

*Scepter* had only one gun deck and was therefore much lower than *Vasa*. The length of the keel was estimated at about 32 m and can be compared to *Vasa's* 38 m. With the hull profile combined with the length of the keel, we get a ship that is slightly smaller than *Vasa* but one of the largest ships of its time in the fleet.

How *Scepter* would have looked beyond what is left of her is, of course, unclear. If you look at a print from the 1610s, the



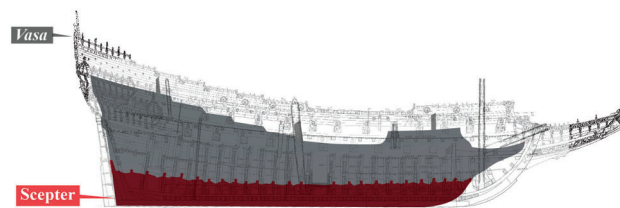


**Fig. 4:** Comparison between the Scepter and Vasa, cross section: the similarities are striking. The dark red area is what is left of the Scepter (illustration, Jim Hansson, Swedish National Maritime and Transport Museums).

transom may have had more rake than *Vasa's* but probably *Scepter* was built in this way too (fig. 5).

Imagine finding Gustav II Adolf's forgotten flagship in a quay that one has walked over hundreds of times! That it was also used as a foundation for a careening dock after it was discarded, you can say it was a kind of early organised recycling. *Svärdet*, for example, went hard on a reef in 1675 and had to return to Skeppsholmen for significant repairs. Was it at the careening dock above *Scepter* that it was repaired? Not impossible at all.

The discovery of *Scepter* makes a significant contribution to revealing an even better picture of early Dutch shipbuilding in



**Fig. 5:** Comparison between the Scepter and Vasa, longitudinal profile. This reconstruction is based on a ship depicted in a copperplate print from Copenhagen dated to 1611 (layout, Alexander Rauscher; illustration Jim Hansson, Swedish National Maritime and Transport Museums).

Sweden. Since we do not have any good references to compare *Vasa* with, this is a very important find. And, I am reasonably sure that *Scepter* is not the only forgotten warship with amazing stories to discover.

## SWEDISH NATIONAL ARCHIVES

Amiralitetskollegiets räkenskaper (Admiralty accounts) 1638-40 under utgiften till byggnation och utredning till *Gamle Scepter* 1638 och 1639 samt Anders Svenssons, dagsverkesskriver, uppbörds- och utgiftsbok, för anno 1640.

RR vol. 118 bild 221 den 10/4 1613, till Olof Svensson, för Isbrandh skeppsbyggare.

RR vol. 119 bild 279 den 24/9 1613.

RR vol. 130 givet av *Scepter* den 2/8 1618, till Alexander Forath, huru han i sjön förhålla skall.

SH (Ship yard accounts) 1600-1604, RR vol.1600

SH 1615 i Materialredogörelsen redovisas en leverans på 7 skp 11 lb Stång- och Bultjärn som levererats från Arnö skeppsbyggning vilket tyder på att arbetet vid Arnö avslutas under året.

SH 1618-19 Stater och anordningar. Förslag på sjöfolk, arkli-folk och krigsfolk på H.K.Majts skepp.

## REFERENCES

- GLETE J.  
2010 *Swedish naval administration, 1521-1721: resource flows and organisational capabilities*, Leiden, Brill.
- HAND J. (ED.)  
1879 *Historiska handlingar. D. 8. Nr 3, Johan Hands dagbok under k. Gustaf II Adolfs resa till Tyskland 1620*, Stockholm, Samf.
- HOCKER, F.  
2018 *Vasa and the origins of professional naval procurement in Sweden*. Särtryck ur *Tidskrift i Sjöväsendet* N:r 1 / 2018. Sidorna 15-30. Kungl. Örlogsmannasällskapet Sveriges Marina Akademi.
- LYBECK O. (ED.)  
1945 *Svenska flottans historia: örlogsflottan i ord och bild från dess grundläggning under Gustav Vasa fram till våra dagar. Bd 3 [1815-1945]*, Malmö, Allhem.
- OXENSTIERNA A.  
1900 *Rikskansleren Axel Oxenstiernas skrifter och brevvevling Afd. 1. Bd 3 Bref 1625-1627*, Stockholm, Utg.
- RANDALL L.  
1997 Hertig Johans eldrör- ett stycke funnen historia från belägringen av Riga 1621, *Forum navale* 52, p. 17-33.



# THE SHIPWRECK OF THE *JEANNE-ÉLISABETH*, A SWEDISH MERCHANT SHIP LOST OFF THE FRENCH MEDITERRANEAN COAST IN 1755. HULL ASSEMBLY: THREE DIFFERENT ARCHITECTURAL TRADITIONS

Marine JAOUEN and Andrea POLETTA

---

## Abstract

The excavation of the *Jeanne-Elisabeth* began in 2008 and was led by archaeologists from the French Ministry of Culture. This Swedish brig of 200 tons sunk in November 1755 while sailing from Cadiz to Marseilles. The starboard hull is preserved for a length of 23 m, from the stem to the stern timbers, from the keel to the second deck. The assembly of the hull is a synthesis of the three traditions of shipbuilding in use in Wolgast, Germany, during the mid-18<sup>th</sup> century: Dutch, English and French. The *Jeanne-Elisabeth* is a great laboratory to study merchant ship construction as designed by a private shipyard in the mid-18<sup>th</sup> century.

## Keywords

18<sup>th</sup> Century, merchantman, *snaubrig*, Sweden, Wolgast

## Résumé

Les fouilles sur l'épave de la *Jeanne-Elisabeth* ont débuté en 2008 et ont été menées par des archéologues du ministère français de la Culture. Ce brick suédois de 200 tonnes coula en novembre 1755 alors qu'il naviguait de Cadix à Marseille. Le flanc tribord est conservé sur une longueur de 23 m, de l'étrave à l'étambot, et de la quille jusqu'au deuxième pont. L'assemblage de la coque est une synthèse des trois traditions de construction navale en usage à Wolgast, en Allemagne, au milieu du XVIII<sup>e</sup> siècle : tradition néerlandaise, tradition anglaise et tradition française. La *Jeanne-Elisabeth* est un excellent laboratoire pour étudier la construction de navires marchands telle qu'elle a été conçue par un chantier naval privé au milieu du XVIII<sup>e</sup> siècle.

## Mots clés

XVIII<sup>e</sup> siècle, navire marchand, brick, *snaubrig*, Suède, Wolgast

---

The wreck of the *Jeanne-Elisabeth* is situated 300 yards from Maguelone, a beach in the Gulf of Lion, and at a depth of 3 to 5 m. This part of the French Mediterranean is characterised by a low coast displaying few landmarks and mobile sandbanks forming underwater dunes, which are difficult to map. Combined, these two phenomena constitute a veritable danger for shipping.

Data relating to the *Jeanne-Elisabeth* is abundant, varied in type and mostly of very good quality. Swedish, Danish and French archives provide information on her construction, route, cargo and foundering. Contemporary observers produced manuscripts relating to naval architecture of very good quality. In the present day, ten years of excavations have complemented the archival data from the standpoint of material culture and ship design. Serious looting of the site was discovered by an investigation of the French Customs in 2007 (Jaouen *et al.* 2017). It had an irremediable impact on the vessel's structure, cargo and other shipboard objects. The Département des recherches archéologiques subaquatiques et sous-marines (DRASSM) has been working on the wreck *in situ* since 2008. Legal action against the looters is ongoing.

The *Jeanne-Elisabeth*, or *Johanna-Elisabet* in Swedish, was a merchant ship built in 1754 in Wolgast, which was then a

Swedish enclave on the German coast of the Baltic Sea. Built in a commercial shipyard, her hull timbers were exclusively made of oak from Polish forests, except for the decks, which were built in pine. Her tonnage certificate describes her as an "oak carvel bregantin", rigged as a "snow" (or *snaubrig* in Swedish) and carvel-planked. It gives the following dimensions: length, 79 Swedish feet or roughly 23.46 m; beam inside the hull, 22 feet 4 inches or 6.62 m; depth of the hold, 9 feet 9 inches or 2.90 m; and height between decks, 4 feet 6 inches or 1.34 m (fig. 1). Note that one Swedish foot measured 29.7 cm. Her rigging comprised two masts proper with a supplementary mast close behind the mainmast. Like the shipyard where she was built, the vessel was privately owned. Her owners were three, all Swedish, and lived in Stockholm and Uddevalla. One of her owners was also the ship's captain. She was named after the principal owner's wife.

The ship was launched in September 1754 and sailed immediately for Stockholm, her home port. In July 1755 she sailed out of the Baltic, bound for Lisbon. Nothing is known of her cargo but Sweden was renowned at that time for exporting pitch, in particular to the west of Europe.

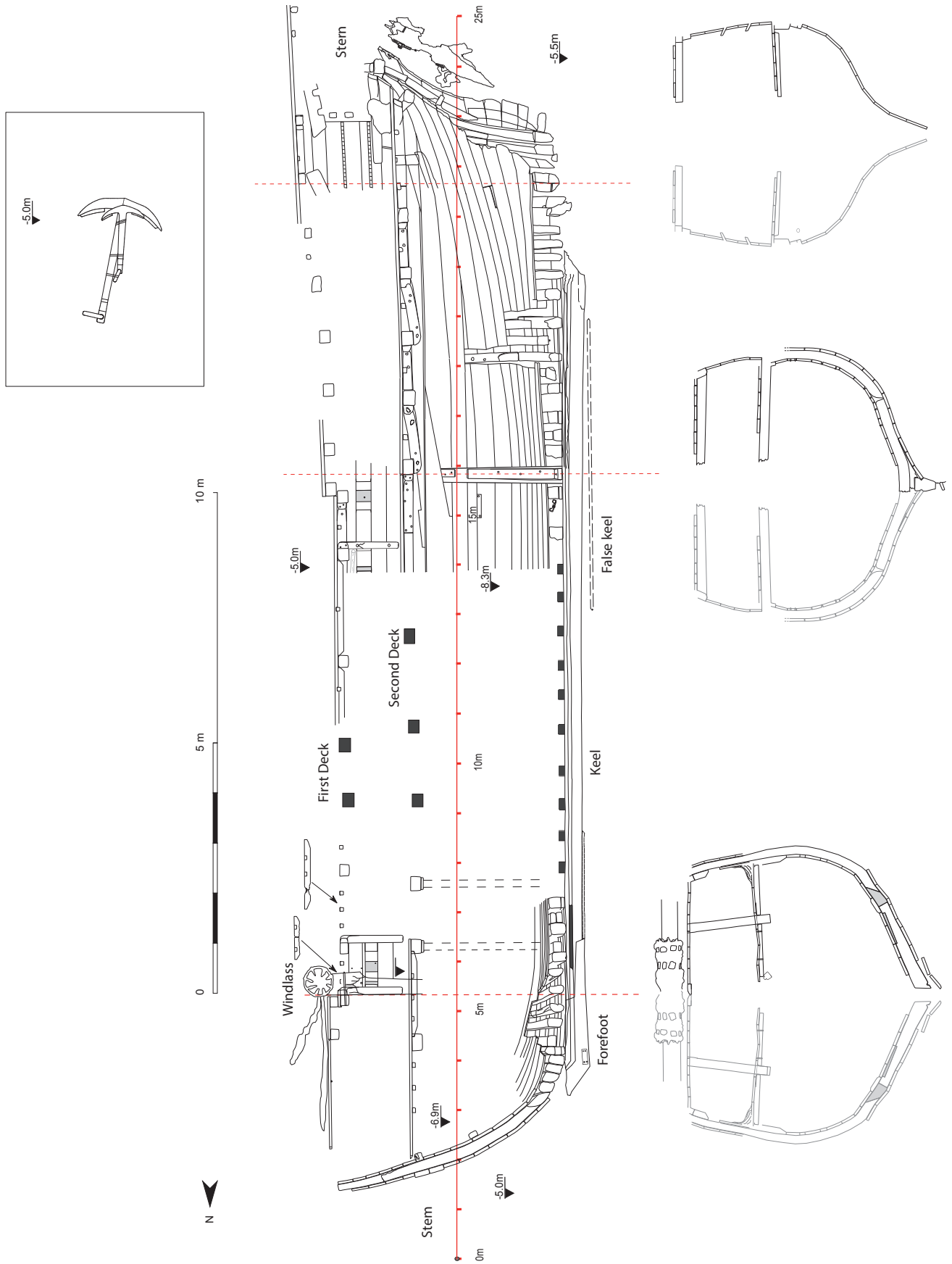


Fig. 1: Planimetry of the starboard side as found on the seabed, and three cross-sections of the Jeanne-Elisabeth (Drawing A. Poletto, M. Jaouen).



We lose track of her temporarily until she turns up in Cadiz in October of the same year. From there the vessel was chartered by a Marseilles businessman, Pierre-Honoré Roux, notably on behalf of Swiss bankers. At the close of 1755 relations between England and France were strained and would develop, six months later, into the Seven Years' War. English privateers based in Minorca were harassing merchant ships heading for France. To ensure trade could continue with the French kingdom, charterers looked for ships sailing under neutral flags, such as Sweden, which is where the *Jeanne-Elisabeth* comes in. Loaded with 24,600 piastres, placed in bags and camouflaged under a layer of 200 tons of wheat, she set sail for Marseilles.

It was late in the season. A storm forced the captain to sail along the coast of the Languedoc, the easternmost part of the Gulf of Lion, in the hope of ascertaining his position. On 14 November 1755 the ship hit a sandbank lying a few dozen yards from the beach. The hull was breached at the stern and waves submerged the deck. All 11 sailors and eight of the ten passengers sought refuge in the masts until morning, when they were rescued.

The cargo was one of the biggest registered with Marseilles' chamber of commerce in the year 1755. Unsurprisingly, attempts to recover the cargo were sustained and continued for over a year. Despite the efforts of the salvors, the piastres remained in the hull. All the items salvaged from the vessel were sequestered in Sète and subsequently auctioned off.

Currently the site is situated 300 yards from the beach. It is entirely covered with sand. In 2006, however, the sands parted to reveal the ship's hull. The site was looted and 18,000 piastres were sold off through unofficial channels. Archaeological excavations began in 2008. Surveys indicated that the architectural remains were exceptionally well preserved (Jaouen, Poletto 2014).

In accordance with the archive accounts, only the starboard side is extant, from the apron to the remains of the stern, and from the lower deck to the upper deck. This half of the hull rolled onto its side and sank into the sand without suffering any notable distortion. Unfortunately the stem is missing.

## 1. HISTORICAL INFLUENCES: THE DUTCH TRADITION

Only the feet of the frames were directly accessible to archaeologists diving on the wreck. Spaces between the frames were equal in width to the width of the frames. In 2011, 2016 and 2018 some of the ceiling was cut away to expose the reason for such spacing. It also enabled us to see how the frame timbers were joined together.

With the ceiling removed, it became apparent that, starting at a distance of 80 cm from the keel, filling timbers occupied the spaces between the frames that were fastened to the keel, the purpose being undoubtedly to strengthen the ship's sides.

Blaise Ollivier, master shipwright to King Louis XV, was sent by Minister of the Navy Maurepas to England and Holland to observe how ships were built in those countries. His mission lasted five months. Upon his return, Ollivier drafted a 360-page manuscript, which detailed and compared the building practices he had observed. He called it, *Remarks on the Navies of the English and the Dutch* (Roberts 1992).

In the chapter devoted to frames, Blaise Ollivier notes that the Dutch spaced their floors along the keel in this fashion, each space being equal in width to a floor timber. Pieces that he calls *genou*, 'knee' in English, occupied the spaces. He adds that the English and the French opted for a different, and in his eyes preferable, solution. In the three areas where the ceiling was removed we were able to ascertain the presence of this construction technique. This part, which we will call 'filling timber' (or half-frame), is not joined to the structural frames that surround it. In comparison, French shipwrights would join the floor timber and its futtock from the side using an iron spike. This gave additional strength to the transverse structure. Here, the filling timber might be a single piece, for example M100, or composed of two pieces placed one on top of the other, as in M99, 97 and 49, to ensure a sufficient thickness upon which the ceiling could be fastened (fig. 2).

## 2. ENGLISH INFLUENCE

It must be noted, however, that this technique of alternating frames and filling pieces appeared later in English shipbuilding. For instance, it was used on the English sloop *Boscawen*, which was built in 1760 on the shores of Lake Champlain in the United States of America. Another similarity with the *Boscawen* involves the futtocks, which were placed in line with the floors and were not joined together in any way. On the *Jeanne-Elisabeth* this type of assembly was observed in several places, on the structural frames M45, 44, 30 and 29. The filling timbers, floors and futtocks, are placed in line but are not touching. The floors and futtocks of the *Jeanne-Elisabeth* do not overlap side by side. Instead they are placed in line. Also, they are fastened together using chocks. Frames M43, 44, 30 and 29 possess such chocks, which might be bevelled at both ends or have one straight end and one bevelled end.

According to Jonathan Adams (2013), frame chocks appeared in English shipbuilding at the end of the 17<sup>th</sup> century. Their use in the construction of merchant ships was first attested in 1714 and became commonplace during the 18<sup>th</sup> century. By the middle of the 19<sup>th</sup> century they tend to disappear.

The influence of English shipbuilders can also be seen, to a lesser extent, in the knees that support the deck beams. Referring once again to Blaise Ollivier, the English fitted four knees to each beam using iron nails. As for the French, they fitted only two. The English method was, according to Blaise Ollivier, to be avoided because it required more wood and more iron. Thus the knees that supported the upper-deck beams were placed in line and at right angles to the hull. The lower deck beams were reinforced with knees fitted alternately between two beams, in parallel to the centreline of the ship and slanting.

## 3. FRENCH INFLUENCE

In 2008 the remains of the ship were visible from the keel to the second deck. The remains of the keel, which at that time measured 7 m long, terminated in a forefoot, against which the lower end of the stem would have rested. The following year a storm washed the keel and forefoot away from the site.

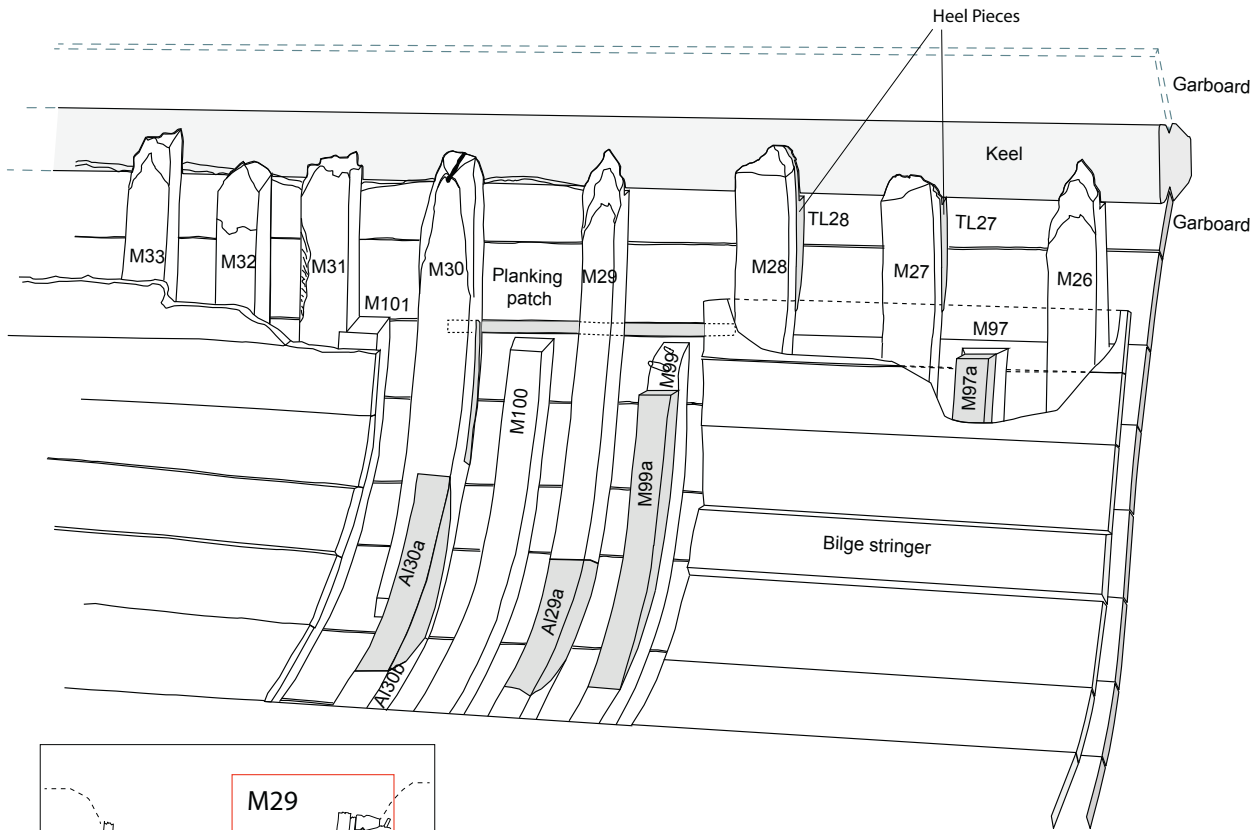


Fig. 2: Midship beam axonometry (Drawing A. Poletto).

Blaise Ollivier also described a forefoot, “The length of the forefoot is never given, it is always made as long as is possible.” The forefoot is the same width and depth as the keel. Each side of the forefoot displays a rabbet similar to the one found on the keel. It is made of oak. This piece is typically attributed to the French tradition of naval construction. Ollivier, who had toured Dutch and English shipyards, remarks that the forefoot was omitted from the ships built by these nations. He insists on the forefoot’s important role in strengthening a ship at a point subjected to great strain, while understanding that the English would want to avoid fitting it because obtaining timber large enough to make it was difficult and particularly expensive. The forefoot of the *Jeanne-Elisabeth* was 3 m long, and the scarf which fastened it to the keel occupied its after third. Also, it featured a rectangular graving piece fastened with four treenails to compensate for a weakness at that point.

#### 4. A UNIQUE FEATURE: THE HEEL PIECE

The feet of the best-preserved frames, designated M12, 26 and 29, were shaped so as to bear upon the upper side of the

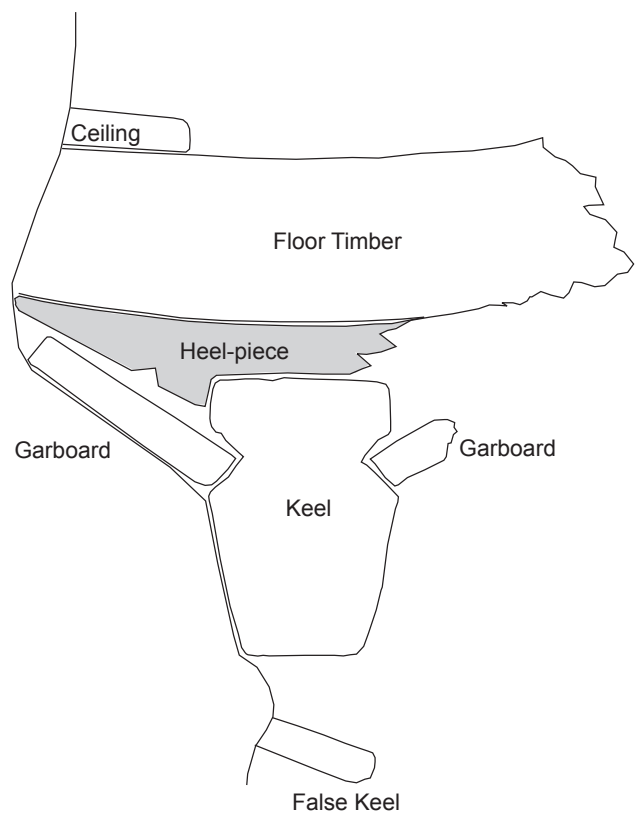


Fig. 3: Heel piece (Drawing A. Poletto).

keel and upon the side of the keel down to the garboard. Unfortunately, the poor condition of the feet of the frames, resulting from when the ship's port side was ripped off, as well as damage caused by shipworm, prevented us from identifying how they were fastened to the keel.

Nevertheless, an unusual feature is worth noting. At the feet of frames M10, 25, 27 and 28 we observed triangular pieces, identical in size to the frames adjoined (fig. 3). This 'heel piece' was inserted between the foot of the frame and the keel. It was shaped to bear on the upper face and side of the keel, just like the feet of the frames mentioned earlier. It seems that the frame and the heel piece were not fastened together, suggesting they were in some way loose. Perhaps a spike entering through the upper side of the frame (or keelson) and penetrating the keel held the frame and heel piece assembly to the keel. Randomly inserted heel pieces such as these have yet to be observed on other wrecks.

## 5. CURRENT SITUATION

This year, by cutting away the ceiling at the bow, we were able to partially resolve one of our study objectives: identifying

where the masts were stepped. With the keel missing, only the floor timbers could provide clues as to the position of the masts. The foremast appears to have been placed between frames M10 and M11 (fig. 4). After cutting away some ceiling planks, we exposed five frames. Our first observation was that they were slightly narrower than the others. The lower part of each of these five frames was situated at the second plank up from the keel. The floor timbers situated on either side of this group were fastened to the keel with spikes, which are no longer extant. They were assembled from the side to the filling timbers and thus form a doubly thick frame. This type of assembly has not been observed elsewhere. So, we have a 2.5-metre section of the hull that is built differently from the rest and long enough to receive the foot of the foremast. The windlass is situated in line with this zone.

## 6. CONCLUSION

In his book *Swedish Naval Administration 1521-1721, Resource Flows and Organizational Capabilities*, the author Jan Glete (2010) lays out in chronological order the arrival of foreign

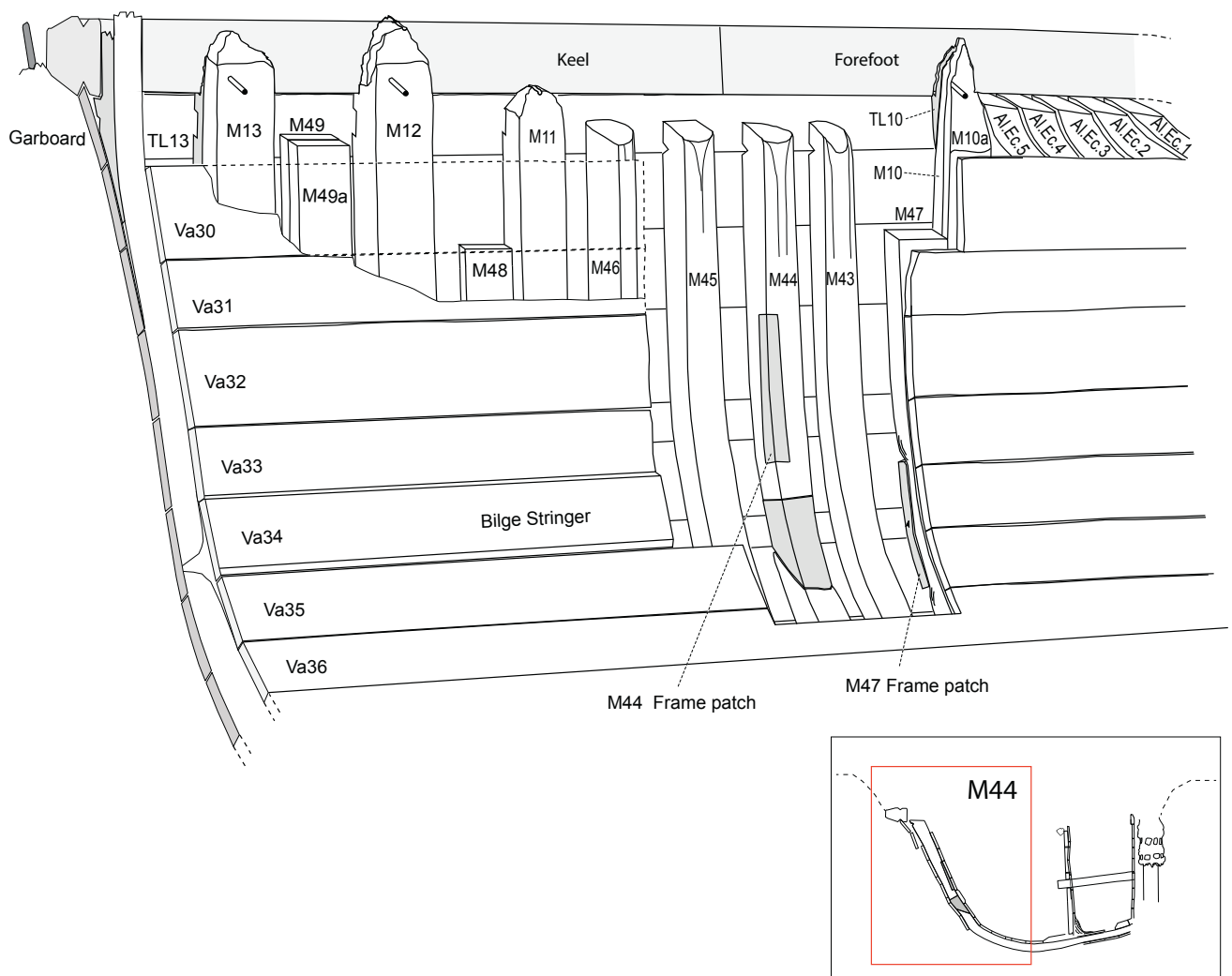


Fig. 4: Stempost axonometry (Drawing A. Poletto, M. Jaouen).



shipbuilders and influences in Swedish shipyards. Initially deployed on military vessels, these new techniques eventually found their way into commercial shipyards. It is for this reason that Dutch techniques dominated the Swedish shipbuilding of the 16<sup>th</sup> century. In 1660 the first British master shipwrights began to arrive in the dockyards. Of particular note is the Sheldon dynasty whose plans remained in use until the 1760s. By the middle of the 18<sup>th</sup> century French hull design was much imitated because its finer lines were perceived as leading to greater vessel speed. While none of the French shipbuilding dynasties seems to have been active in Sweden, French design did nevertheless exert a notable influence. Of the 70 ship plans displayed in *Architectura Navalis Mercatoria*, published by Chapman (1768), chief shipbuilder of the Swedish Royal Navy, four were French. Clearly such designs were representative of the period. In his brief description, the author considers them to be good, even very good sailers. It was at this time that Chapman, championed by another Swedish shipbuilder called Sohlberg, began to apply mathematics to ship design and construction. A new era was thus begun under the reign of Gustav III of Sweden, a monarch of the Enlightenment with a keen interest in the arts and science.

The *Jeanne-Elisabeth* is a remarkable example of three centuries' worth of development in naval architecture. She attests to Swedish shipbuilders' ability to take known designs and adapt them, choosing whether to adopt or not new technical solutions from other countries in accordance with their own intrinsic criteria. What we see here is the gradual disappearance of Dutch 'markers' and the rise of British design solutions throughout the transverse structure of the ship. Arriving much later in Sweden, French influence is predictably less extensive but nonetheless significant, as can be seen, for example, in the presence of the forefoot.

Fitted out for international trade, the *Jeanne-Elisabeth* sailed the Baltic, the North Sea, the Channel, the Atlantic and the Mediterranean. In other words, along the coasts of the countries whose shipbuilding techniques influenced her own construction.

The absence of the port side, including the keel, and the poor condition of the feet of the floor timbers constitute a veritable obstacle to a more profound study of the hull's essential structures. Fortunately, the gaps in the data obtained on the seabed are compensated by archive documents and contemporary accounts of the utmost reliability.

## REFERENCES

- ADAMS J.  
2013 *A Maritime Archaeology of Ships: Innovation and Social Change in Late Medieval and Early Modern Europe*, Oxford, Oxbow Books.
- CHAPMAN F.-H.  
1768 *Architectura Navalis Mercatoria*, Reprint Douarnenez, Reink Books, 2016.
- GLETE J.  
2010 *Swedish Naval Administration 1521-1721, Resource Flows and Organizational Capabilities*, Leiden / Boston, Brill.
- JAOUEN M., RIETH E., BERTHAUT-CLARAC S., DIEULEFET G., JAMBU J., POLETTO A., SADANIA M., SERRA L.  
2017 L'épave de la Jeanne-Elisabeth, 1755 (Villeneuve-lès-Maguelone, Hérault). 2008-2016, Bilan de huit campagnes de fouilles, *Archaeonautica* 19, p. 41-86.
- JAOUEN M., POLETTO A.  
2014 The Shipwreck of the Jeanne-Elisabeth, 1755, in Ch. Dagneau, K. Gauvin (eds), *ACUA Underwater Archaeology Proceedings 2014*, Québec, Advisory Council on Underwater Archaeology, p. 93-97.
- ROBERTS D. (ED.)  
1992 *Blaise Ollivier, 18<sup>th</sup> Century Shipbuilding: Remarks on the Navies of the English and the Dutch from observations made at their dockyards in 1737*, Rothersfield, Jean Boudriot Publications.

# BALTIC AND EAST EUROPEAN SHIPBUILDING INFLUENCES IN THE SWEDISH EMPIRE: TRACING LOCAL AND INTER-REGIONAL SHIPBUILDING TRADITIONS FROM THE ARMED VESSEL *BODEKULL*, BUILT 1659-1661 AND SUNK 1678

Niklas ERIKSSON

---

## Abstract

Research in the Swedish military archives has revealed the identity of the 'Edesö Wreck' as the *Bodekull* belonging to the Swedish navy. The vessel was one of around 45 *struss* vessels ordered by King Karl X Gustav in 1659 to be used to transport troops and horses between the Danish isles. As a consequence of the king's sudden death in January 1660 and the end of the war against Denmark, the semi-finished purpose-built invasion fleet was rebuilt into vessels for which the navy had better use. It is still possible, however, to trace the original design of the vessel through the preserved hull structure.

## Keywords

Baltic Sea, naval architecture, rebuilt vessel, *struss*

## Résumé

Des recherches dans les archives militaires suédoises ont révélé l'identité de l'épave d'Edesö comme étant le *Bodekull* de la marine suédoise. Ce navire était l'un des 45 *struss* commandés par le roi Karl X Gustav en 1659 pour transporter troupes et chevaux à travers les îles danoises. Après la mort soudaine du roi en janvier 1660 et la fin de la guerre contre le Danemark, la flotte d'invasion spécialement construite à cet effet, et seulement en partie achevée, a été transformée afin de fournir des navires plus utiles à la marine suédoise. Il est cependant toujours possible de restituer l'architecture d'origine du navire à travers la structure préservée de sa coque.

## Mots clés

Mer Baltique, architecture navale, navire transformé, *struss*

---

Early-modern Sweden expanded rapidly through regions conquered by war. Even though the empire occupied a large area, it was sparsely populated and most inhabitants were peasants. People with specific competences, from merchants to bureaucrats or ironworkers, had to be recruited from abroad. Through recruiting skilled master shipwrights in foreign countries, the Swedish navy could remain up-to-date with the latest technologies and techniques of European shipbuilding. In the early 17<sup>th</sup> century such shipwrights were usually recruited from the Netherlands, though from the mid-16<sup>th</sup> century, when the Netherlands joined Denmark in the wars against Sweden, shipbuilding competence was also sought in England. This is quite a well-known story in the history of Swedish naval architecture (Eriksson 2017a, 2017b).

The Dutch and later English influences were most evident in the larger ships. Besides these, the Swedish navy had a large number of smaller vessels. In the written sources some of these are named as *lodja* or *struss* vessels. The phonetics of these designations already reveal that these types of vessels originate from the eastern side of the Baltic Sea and Russia. The influences from Eastern Europe on early-modern Swedish naval architecture appear to have been substantial, and yet they

have not received as much scholarly attention as the influences from the Netherlands or England.

The *lodja* is a type of vessel that seems to have been particularly numerous. In 1617 for instance, it was suggested that the Swedish navy should have at least 100 vessels of this type during times of peace (Zettersten 1890, p. 326-327). The *lodja* was a wide, flat-bottomed vessel that appears to have varied considerably in size. By reason of specific coincidences in connection to a certain campaign or conflict, the navy ordered *lodjas* to be mass-produced according to specific dimensions (Zettersten 1903, p. 78; Åkerlund 1951; Alopæus 2018).

## 1. KING GUSTAV II ADOLF'S *STRUSS* VESSELS

Since the *lodja* deserves a separate paper, the following will concentrate on the second type of vessel, namely the *struss*. According to the Swedish Academy Dictionary (SAOB), the word derives from the Slavonic *strudzi*, which is the name of a large, flat-bottomed boat somewhat like a hoy, used for transport on rivers and around shallow coasts (SAOB, entry: *struss*).

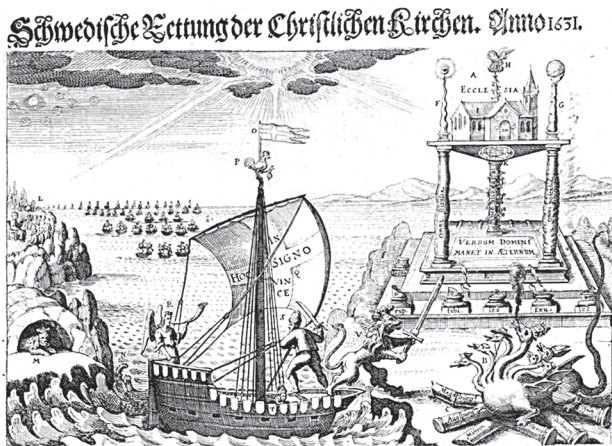


Fig. 1: The Swedish King Gustav II Adolf, depicted as 'The Lion from the North', travelling aboard a struss (Royal Library Stockholm).

Furthermore, the designation is without doubt related to the Russian word *strug*. Through the centuries, the term has been used for a wide range of vessels of different sizes. Written sources mention that *strugs* were used in medieval Russian trade on the Daugava River, and from the 16<sup>th</sup> and 17<sup>th</sup> centuries the term referred to a large, flat-bottomed military and cargo vessel used on, for instance, the Volga (Petr Sorokin, personal communication, Tredrea, Sozaev 2010, p. 362). Whereas *lodjas* were clinker built and produced by almost any shipyard, from large ones controlled by the crown to small local vernacular shipyards, the *struss* – at least those used by the Swedes – was carvel built. They were fitted with a small cabin in the stern and some images depict them with leeboards to improve their sailing capabilities.

The *struss* was built in several different sizes, and written sources mention 30, 48, 70 and 80 feet in length from stem to sternpost. They could be sailed with a crew of five to ten in addition to one captain. The Swedish army used the *struss* on the rivers and along the eastern coasts of the Baltic Sea during the Thirty Years' War (fig. 1) (Zettersten 1890, p. 328; Börjeson 1937, p. 30). In 1621 Swedish forces conquered Riga in present-day Latvia. Due to the uncertain situation regarding the ongoing war, it was decided not to establish a large shipyard for building large warships in the vicinity of the city. Instead, the efforts were directed at building smaller vessels that could be used for transporting soldiers on the rivers. King Gustav II Adolf thus ordered that one large *lodja* and six *struss* should be built annually in Riga (Zettersten 1890, p. 285).

In 1626 Sweden took Elbing and it was decided that the town should be used as a winter quarter for Swedish vessels. A shipyard was established in 1629, and a small fleet consisting of 22 *strusses* and four *lodjas* were placed at Elbing. Captain Lars Mattsson, who appears to have been a reliable and competent individual, was given command of the shipyard. The crown, at least, thought well of him, as he was later ennobled under the fitting name of Strusshielm, which literally translates as "*struss* helmet" (Zettersten 1890, p. 68). In the House of Nobility in Stockholm, which has carefully painted depictions of the coats-of-arms of the Swedish nobility, the coats-of-arms of both Strusshielm and Strussköld (*struss* shield) depict the relevant vessel (fig. 2).

Until recently the sources describing what a *struss* looked like have been limited to depictions and some descriptions.



Fig. 2: The coats-of-arms belonging to Strusshielm (left) and Strussköld (right) as depicted in the House of Nobility in Stockholm (photographs Gabriel Hildebrand, Riddarhuset).

Recent research in the Swedish military archives has identified the so-called 'Edesö Wreck' as the armed vessel *Bodekull* (for a thorough account with full archival references, see Eriksson 2018a and 2018b). However, even if *Bodekull* is a *struss*, it is quite an odd example, as it was rebuilt in a manner that appears very different from the vessels used by Gustav Adolf.

## 2. KING KARL X GUSTAV'S STRUSS VESSELS

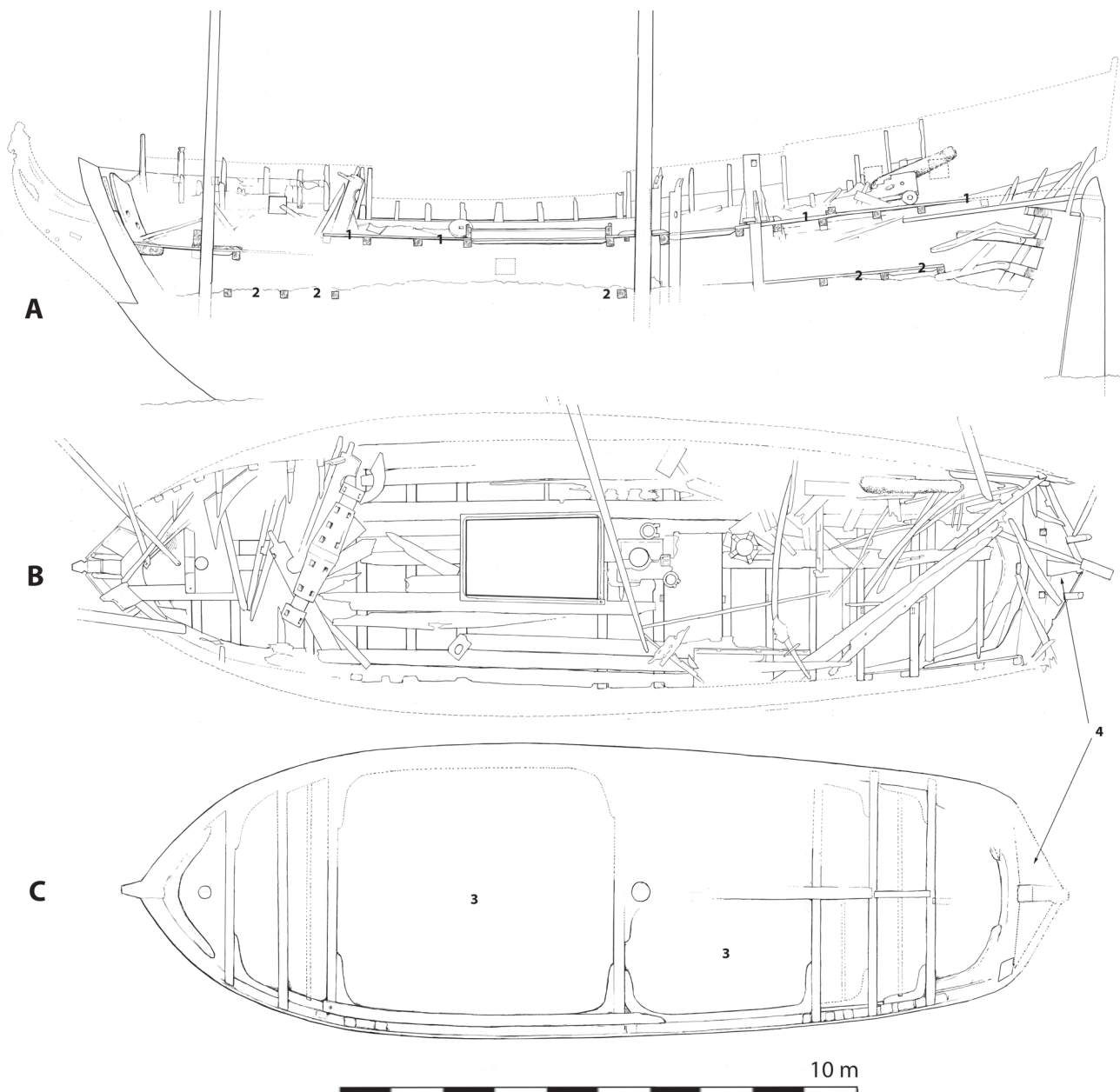
The background against which *Bodekull* was built and later rebuilt is the wars of Swedish King Karl X Gustav. During his short reign, from June 1654 to February 1660, Sweden was engaged in conflicts at several levels and on several fronts, and the war stretched to various corners of Europe (for an overview of the war at sea, see Askgaard 1974; Glete 2010, p. 175-184).

In November of 1659 the king wrote from Kronborg castle in Denmark to the Admiralty Board in Stockholm, informing them that they should "build 45 *struss* to transport our soldiers and horses" (RR, 1659-11-30, folio 3509, author's translation). The vessels were to be used to invade Denmark and the king had the vessels used during the Thirty Year's War in mind when he formulated the order. He thus mentions that, "during the late Gustav Adolf's realm such vessels were used in Prussia and Pillau" (RR, 1659-11-30, folio 3509, author's translation). Karl Gustav listed the preferred main dimensions for the vessels: 60 feet between the posts and 18 feet wide. Half were to have gaff sails and the other half square sails (Zettersten, 1903, p. 310–311).

Those with square sails had two masts while those with gaff sails had one, which is another difference compared to, for instance, the vessels depicted on the Strusshielm and Strussköld coats-of-arms, which show a single mast with square sail. However, there are also examples dating from the 1630s where a *struss* was rigged with three masts (Börjeson 1937, p. 30-31, note 3).

The Admiralty thought that the dimensions suggested by the king were much too small, not least as the intention was to carry 40 horses aboard each *struss*. The size of the vessels was thus increased to 72 feet in length, and only the first few examples, including the *struss* that was later named *Bodekull*, were built measuring 60 feet from stem to sternpost.





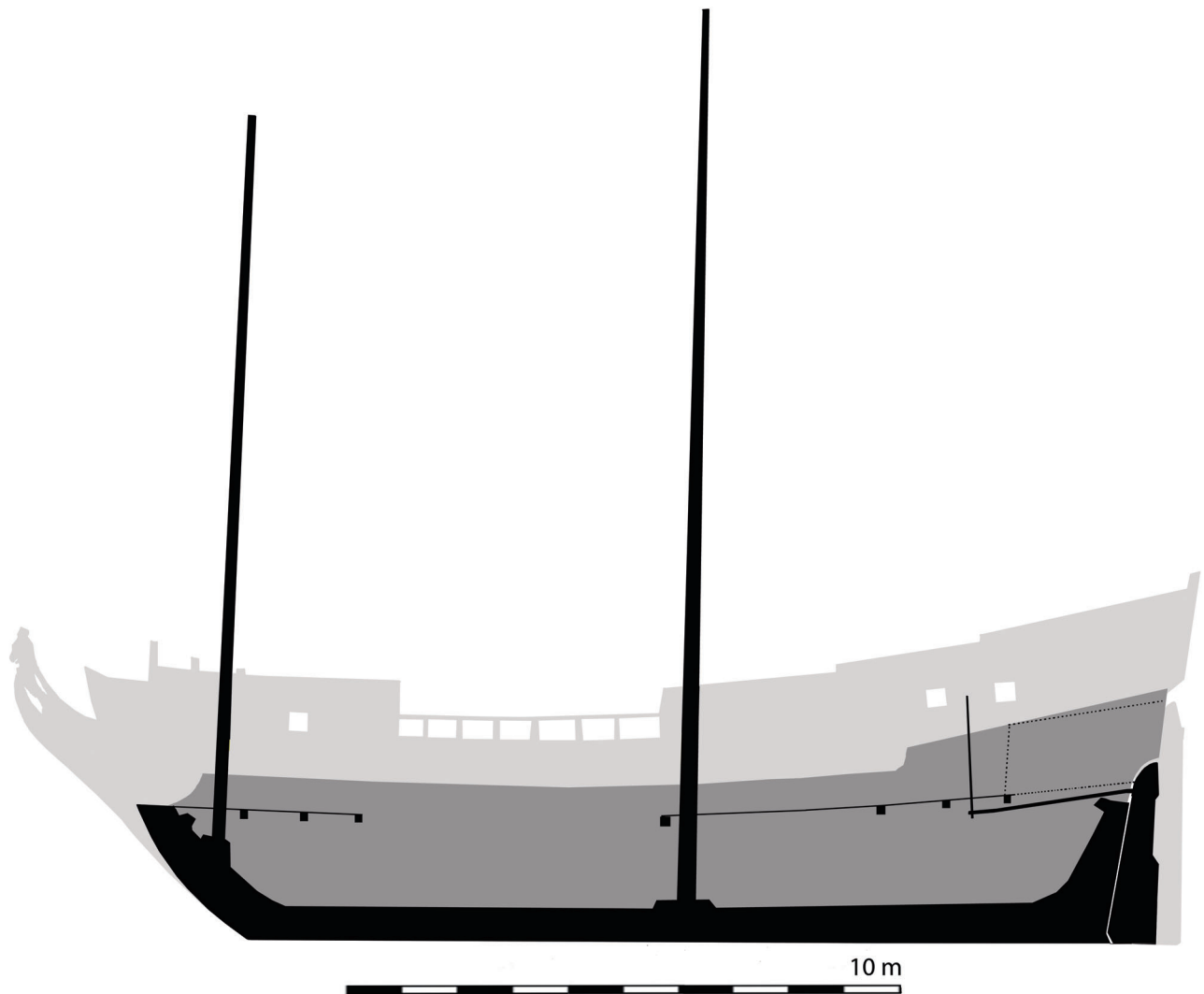
**Fig. 3:** A) longitudinal section of Bodekull's hull. Note that there are two rows of deck beams. The upper deck (1) and the lower deck (2). B) Plan of the upper deck, completed after Karl X Gustav's death, when it was decided to rebuild the vessels. C) The remains of the deck structure that were originally intended to be the upper deck of the original struss. Note the half beams indicating which parts were to be decked in the bow and stern, leaving an open area (3) for horses amidships. Timbers (4) were added abaft the transom beams in order to rebuild the originally flat stern into a round tuck (drawings Niklas Eriksson, Jon Adams, Jim Hansson).

The king also stipulated that the vessels were to be completed by the first day of spring. It should be noted that this order was sent to the Admiralty Board on the last day of November 1659. To build an entire invasion fleet during four or five cold and dark winter months was quite a challenge and the Admiralty Board made their best efforts to complete the task. Ten to 12 were to be built in Stockholm, ten in Gothenburg, eight in Västervik, six in Halmstad and 12 at a recently founded shipyard in the town of Bodekull in the county of Blekinge, a former Danish territory that was given to Sweden in the Treaty of Roskilde in 1658. The first Swedish vessel completed here was thus named after the town. The town's name was changed to Karlshamn in 1664.

### 3. A REBUILT STRUSS

An English master shipwright named Thomas Day was employed in Sweden in 1659. He was in charge of the design at the shipyard in Bodekull and built the vessels in accordance to the king's orders. In February 1660 the king died suddenly from a short illness, which brought an end to the Danish war. In consequence, there were partly finished *struss* vessels at shipyards all over Sweden, for which the navy had no use. The Admiralty Board decided to rebuild the larger ones into small frigates to carry between 12-16 guns (Bergman 1954, p. 14-17; Wendt 1950, p. 187-90; Eriksson 2018a, p. 396, 20187b, p. 26-27).





**Fig. 4:** Reconstruction of the original design of the vessel. The hull is only decked in the bow and stern in order to allow for the transport of horses. The later additions, as well as the extended stern, are shown as a grey shadow. Compare fig. 3 (drawing Niklas Eriksson).

The smaller ones, including the vessel that was later to become the *Bodekull*, were rebuilt in a similar fashion. Their hulls were built higher and a new deck level, which was built above the structure of the original deck, was introduced, and finished with a quarterdeck and a forecastle. What is interesting is that elements of the original *struss* design are still preserved and visible inside the wreck that rests on the seabed, 30 m below the surface of the Stockholm archipelago (figs 3 and 4).

According to the king's specifications, the vessels were to be built with "*een plickt framme och en kajuta akter*" ("a small deck in the bow and a cabin in the stern"), leaving an open space amidships to provide room for horses. The horses were to be placed in two rows along the length of the hull, with their heads facing each other. Each horse would require between 2 and 2.5 feet. The Admiralty estimated that the smaller version of the *struss* could accommodate 20 horses (Eriksson 2018a, p. 394-395, 2018b, p. 22-23).

A principal difference between 17<sup>th</sup> century Dutch and English shipbuilding is the design of the stern. Whereas the Dutch built square sterns below the wing transom, the English introduced the round tuck. *Bodekull* was originally designed

with a square stern but was rebuilt as a round tuck, which is not surprising as the work was done under the command of an English master shipwright. Additional timber was added abaft the sternpost and transom beams, resulting in the hull being about 2 feet longer and finished with a round tuck stern (Eriksson 2018a, p. 397-398, 2018b, p. 30-32).

In August of 1660 a detailed report describing the activity at the shipyard in Bodekull was sent to the Admiralty Board in Stockholm. Both *Bodekull* and her sister-vessel *Jonas* had been launched. There was no master woodcarver available at the shipyard and the lieutenant wrote that the Admiralty Board should decide, "what carvings should be made when the vessels arrive in Stockholm". He comments on their appearance through mentioning, "[h]ad they English beakheads, they were small English frigates" (letter from Daniel Strussflycht 1660-08-08, KrA, Registry of the Admiralty, author's translation). The vessels, at first intended for transporting horses, were now rebuilt in such a manner that they appeared as small frigates (Eriksson 2018a, p. 399, 2018b, p. 32-34)!

Some occasional examples of vessels of this type had been equipped with a few cannons as early as the 1630s, though in

general *struss* were unarmed. They were used for transport and not for engaging the enemy (Börjeson 1937, p. 30-31, note 3). When Karl X Gustav ordered his invasion fleet to be built in 1659, his intention was likely that the vessels should be more or less unarmed. However, according to a written report from the shipyard, *Bodekull* and *Jonas* had been rebuilt such that they could carry six guns astern the mainmast and four before the main mast. The preserved hull structure reveals an arrangement of gunports that corresponds to this report (Eriksson 2018a, p. 400, 2018b, p. 35).

Both *Jonas* and *Bodekull* were finished and finally equipped in 1661. A document stipulating both vessels' food supply has been relocated and reveals two categories of food: food for commoners and *kajutkost*, which literary translates to 'cabin food'. The latter category was served in the cabin and was thus reserved for officers and prominent guests (Söderlind 2006, p. 50-69; Eriksson 2014, p. 139-144; Hammar 2014, p. 102-105). The size of the crew is not known, though a document mentions that the sister vessel *Jonas* had a crew of eight in addition to one officer.

Even if *Bodekull* measures only 19 m between posts, the interior reveals a clear spatial hierarchy and division between the few people onboard (for the spatial arrangement aboard *Bodekull*, see Eriksson 2013). The original *struss* design only had a cabin in the stern, whereas the remainder of the hull, except for a small deck in the bow, was left open.

The navy's smaller units, including *strusses* and *lodjas*, have not left a great impression in the written sources in the same way as the larger fighting ships have, and yet it was vessels such as these that were the inalienable workhorses of the navy, necessary for the transport of people, horses, and provisions in times of both war and peace. The written sources mention that both *Jonas* and *Bodekull* were used for transporting everything from letters to people and salvaged cannons from sunken warships. Most commonly, however, the two vessels transported flour for the Swedish navy: a very important task. As an indication of the quantities involved, one could mention that during July 1678 the navy needed 252 barrels of flour for provisions (Eriksson 2018b, p. 38). It was while transporting a load of flour that *Bodekull* struck a rock in the Stockholm Archipelago and sank in October of the same year (for an account on the wrecking of *Bodekull* see Eriksson 2018a, p. 401, 2018b, p. 38-41).

## 4. CONCLUSIONS

The theme of this ISBSA has been *Open sea, closed sea – Local traditions and inter-regional traditions in shipbuilding*, *Bodekull* is indeed an interesting case in this context as the vessel reveals influences and traditions from various corners of Europe. It began as a *struss*, aimed to be used on rivers and closed seas, a type of vessel that originates from the Baltic and Eastern Europe. It was built in an area conquered from Denmark, was named after a former Danish town and was intended for warfare against Denmark. It was under the supervision of an English master shipwright that the vessel was built and rebuilt.

The craftsmen that built the vessel were Swedish, English, German and Danish (see also Lundgren 1999 for an overview). The carvings were made in Stockholm, probably under supervision of the German-speaking master woodcarver Jost Shütze. *Bodekull* is thus a piece of material culture sprung out of a variety of different traditions and nationalities, all entangled by the events of history. In a sense, this is quite characteristic of early-modern Sweden.

## ACKNOWLEDGMENTS

The author would like to thank Krzysztof Zamościński from the National Maritime Museum in Gdańsk and Petr Sorokin from the Russian Academy of Sciences for important information and remarks regarding *strug*.

## ARCHIVES

KrA, Krigsarkivet (The Swedish Military Archives)  
Registry of the Admiralty (Amiralitetskollegium ankommande handlingar och registratur) 1659, 1660, 1661 Admiralty Board Protocol (Amiralitetskollegiums protokoll) 1661, 1678  
RA, Riksarkivet (The Swedish National Archives)  
Sjöexpeditioner 1664-1679, RR, Riksregistraturet 1659.

## REFERENCES

- ÅKERLUND H.  
1951 *Fartygsfynden i den forna hamnen i Kalmar*, Uppsala, Almqvist & Wiksells.
- ALOPAEUS H.  
2018 Litet om lodjan, in M. Lindholm, S. Beijar, K. Gustavsson (eds), *Bottnisk kontakt XIX*, Mariehamn, Ålands landskapsregering & Ålands Museum, Åländsk odling 69, p. 40-53.
- ASKGAARD F.  
1974 *Kampen om Östersjön på Carl X Gustafs tid*, København, Militärhistoriskaförlaget, CarlXGustaf-studier 6.
- BERGMAN E.  
1954 *Gamla varvet i Göteborg 1660-1825: historik och beskrivning*, Göteborg, Nautics.
- BÖRJESON, H.  
1937 *Sveriges krig 1611-1632 Bilagsbd I [Sveriges sjökrig 1611-1632]*, Stockholm, Generalstaben.
- ERIKSSON N.  
2013 Sailing, sleeping and eating on board seventeenth century ships: Tapping the Potential of Baltic Sea shipwrecks, with regard to the Archaeology of Space, in J. Adams, J. Rönnby (eds), *Interpreting Shipwrecks: Maritime Archaeological Approaches*, Southampton, Highfield Press, p. 97-109.  
2014 The Edesö Wreck: the hull of a small, armed ship wrecked in the Stockholm archipelago in the latter half of the seventeenth century, *IJNA* 43.1, p. 103-114.  
2017a Riksäppet (1676): resurrecting a neglected wreck, in J. Litwin (ed.) *Baltic and beyond: Change and continuity in shipbuilding*,

- Proceedings of the Fourteenth International Symposium on Boat and Ship Archaeology (ISBSA14)*, Gdansk, National Maritime Museum, p. 39-48.
- 2017b The ship *Riksäpplet* and the introduction of English naval architecture in Sweden in the 17<sup>th</sup> century, *Post-Medieval Archaeology* 51.2, p. 309-331.
- 2018a A New View of the 'Edesö Wreck': identifying the Swedish naval vessel *Bodekull*, built 1659-1661 and sunk 1678 from written sources, *IJNA* 47.2, p. 391-404.
- 2018b Trupptransporten som blev en mjölskuta: identifieringen av "Dalarövraket" som flottans fartyg *Bodekull* (1661-1678), *Forum Navale* 74, p. 12-52.
- GLETE J.  
2010 *Swedish Naval Administration 1521-1721, Resource Flows and Organisational Capabilities*, Leiden and Boston, Brill.
- HAMMAR A.  
2014 *Mellan kaos och kontroll: Social ordning i svenska flottan 1670-1716*, Lund, Nordic Academic Press.
- LUNDGREN K.  
1999 *De stora örlogsskeppen från Carlshamn 1659–1676: en mikrohistorisk studie i skeppsbyggnad, teknik och livsvillkor under stormaktstiden*, Carlshamn.
- SÖDERLIND U.  
2006 *Skrovsmål: Kosthållning och matlagning i den svenska flottan från 1500-tal till 1700-tal*, Forum Navales skriftserie 17, Stockholm, Carlssons.
- TREDREA J., SOZAEV E.  
2010 *Russian Warships in the Age of Sail 1696-1860: Design, Construction, Careers and Fates*, London, Seaforth Publishing.
- WENDT E. (ED.)  
1950 *Amiralitetskollegiets historia, I, 1634–1695*, Stockholm.
- ZETTERSTEN A.  
1890 *Svenska flottans historia: åren 1522-1634*, Stockholm, Seligmanns.  
1903 *Svenska flottans historia: åren 1635-1680*, Norrtelje, Norrtelje tidnings boktr.

# NATIONAL SHIPBUILDING, INTERNATIONAL TECHNOLOGY: TECHNOLOGICAL EXCHANGE IN 18<sup>TH</sup> CENTURY EUROPEAN SHIPYARDS

Ida Christine JORGENSEN

---

## Abstract

As England and France were engaged in regular naval battles throughout the 18<sup>th</sup> century, the situation was rather quiet in Denmark, while Sweden experienced sporadic wars. Nevertheless, the overall political situation was nothing but unstable, so while the motivation for keeping the navy on its toes was high within all four nations, the methods of gaining advanced technology for shipbuilding were very different. Technological exchange carried out between European shipyards took the form of prizes of war, industrial espionage and migration. It resulted in a network of relations that rendered national shipbuilding a technologically international matter.

## Keywords

18<sup>th</sup> century, international relations, naval history, shipbuilding, technology

## Résumé

Alors que l'Angleterre et la France étaient régulièrement engagées dans des batailles navales tout au long du xviii<sup>e</sup> siècle, la situation était plus calme au Danemark, tandis que la Suède n'était confrontée qu'à des guerres sporadiques. Néanmoins, la situation politique générale demeurait instable, de sorte que le maintien d'une marine prête à agir était fondamental dans les quatre États. Dans ce contexte, les méthodes pour acquérir une technologie de pointe pour la construction des flottes de guerre étaient très différentes. Les transferts technologiques entre les chantiers navals européens se sont faits par le biais de prises de guerre, d'espionnage industriel et de migration. Il en résulta un réseau de relations qui fit de la construction navale une question d'intérêt stratégique international pour chacun des États.

## Mots clés

xviii<sup>e</sup> siècle, relations internationales, histoire navale, construction navale, technologie

---

A navy is the very symbol of a nation. It is there to defend and protect the national territories. It is made to fight for its government and its people, and it is paid for by the state. This is true now, and it was certainly true in 18<sup>th</sup> century Europe. Then, naval vessels were not only made for fighting, they were meant for showing off, exhibiting the power of the country and especially its king. In terms of shipbuilding technology, however, the process of designing and constructing the technologically advanced naval vessel produced for the nation was in turn less national. When it comes to technology, there is no such thing as nationality. Technology travels wherever people take it or send it, and it does not care about national borders. This article will address the means of technological transfer between 18<sup>th</sup> century European shipyards and emphasise why this is important to historians and archaeologists alike.

This article reflects the very early stages of a PhD project in naval history to be presented to the University of Portsmouth. It contains the initial thoughts and budding ideas in a process that will conclude in the autumn of 2021.

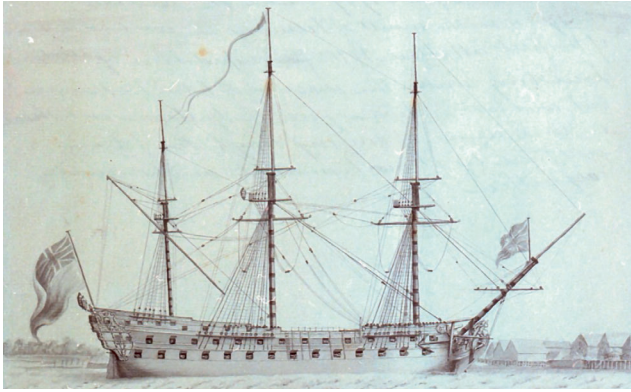
The unstable political situation between European countries in the 18<sup>th</sup> century created an arms race that led to a significant flow of innovations. Naval shipyards being at the forefront of technological advancement, these were the hubs for innovation and the centres where technological knowledge was imported and, less willingly, exported.

Largely based on trial and error, 18<sup>th</sup> century naval shipbuilding was a risky business: all the more reason to copy vessels that were doing well, regardless of their nationality. Being on the top of one's game and producing state of the art naval equipment meant being innovative in the ways of gathering methods and techniques, rather than inventing the wheel all over again. Thus, the scene was set for international technology exchange in all its shapes and forms. These shapes and forms are presented in the following.

Before proceeding to the means and methods of exchange of technology, it might be worth pointing out where these historical studies fit into a maritime archaeological conference paper and subsequent article. Other than finding evidence in the written sources of technology being transferred between nations, it is present in the archaeological record, although less explicit. 18<sup>th</sup> century shipwrecks, of which there are plenty, are concrete evidence of the technology used in shipbuilding at the time and the international relations between European navies. However, the origin of the methods and techniques are less evident unless one knows what to look for. In other words, this research of the historical sources will provide a solid foundation for the archaeological analysis of the construction and design of ships, as well as providing an understanding of the inter-European network of knowledge exchange created by conflict.

The exchange of knowledge between allies, government to government, is indeed worth mentioning in terms of technology diffusion. The general purpose of this exchange is the strengthening of their combined power towards a common enemy.





**Fig 1:** HMS Invincible was a French prize. Originally built in Rochefort in 1744 and named L'Invincible, she sailed for the French navy until she was captured by the English in 1747. Her survey draft resulted in two new ships: HMS Valiant (1759) and HMS Triumph (1764). Invincible was wrecked in 1758 in the Solent off Portsmouth, where her wreck remains (drawing by captain's clerk between 1749 and 1752, National Maritime Museum, Greenwich, London).

However, this aspect will not be discussed any further here. It is a rather open, visible, and more importantly, legal exchange between governments, and thus not hard to detect from communication between allied forces. As the project focuses on conflict-driven interactions, rather than those based on coherence, the importance of technology exchange between allies are recognised in terms of evidence in the archaeological record, though not included in the research.

Three other means of technology exchange, clandestine and less so, represent the very nature of conflict, including competition, suspicion and power struggle.

Firstly, there is the matter of prizes of war. During battle, a navy would seek to board and capture the enemy's vessels. Routinely, the ships were taken back to a shipyard, where they were surveyed and refitted, and then put into commission. Furthermore, the lines would be taken from the ship. As well as an additional vessel, the navy would now have captured information on how the enemy constructs and designs. The survey of the captured vessel was therefore not only in order to assess the amount of prize money for the crew that had captured the ship, it was just as much to assess the quality of the construction for potentially copying the design, and matching the force of the enemy. If the vessel was found to be of technological interest and worth copying, the ship was further measured and subsequently drafted. Especially in the English dockyards of the south coast, Portsmouth and Plymouth, surveys and additional measuring were frequently carried out in order to create a construction draft of the ship. The sources also reveal that these drafts were used in the construction of new ships for the Royal Navy. Thus, plenty of French designs were ruling the waves for Britannia, and especially in the second half of the century a significant amount of prizes and copies of prizes made up the Royal Navy (Ferreiro 2007) (fig. 1).

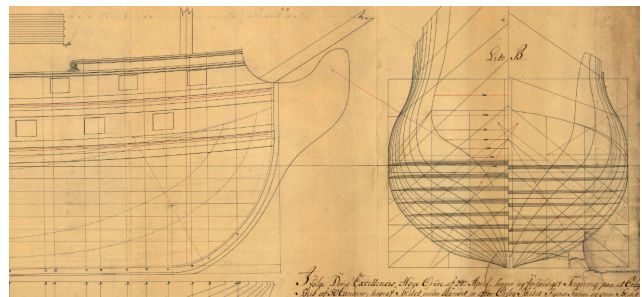
After the survey, captured ships in Britain were refitted and some were quite significantly altered. French vessels were built to be manoeuvrable and fast. Their hulls were narrow and long. British vessels were made for blockade. Their hulls were full and wide. Furthermore, the French ships were built light and with fewer framing timbers and generally a lighter planking. While it is hard to determine to what extent the alterations to French ships were carried out before they went into service for the British, the message from the shipyard surveyors is clear:

these light and flimsy hulls have no place in the British Royal Navy. Additional planking and extra framing timbers seem to be a minimum in the refitting of French prizes. On top of that comes the general layout inside the ships, gunports not fitting the elevation of British gun carriages etc.

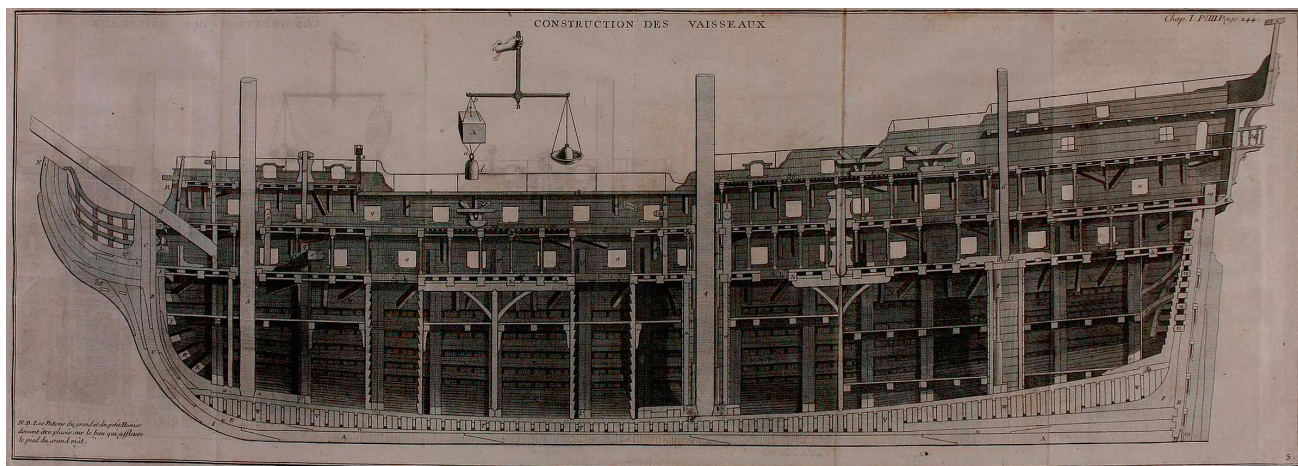
For other countries, however, prizes and capturing ships from the enemy was simply not an option. For Denmark, an 80-year absence of war during the 18<sup>th</sup> century resulted in a dry spell in war prizes, leading to an urgent need to restore the inflow of shipbuilding technology from outside the Danish kingdom. The issue was resolved by intensive and rather well planned, well-administered industrial espionage. While Britain and France were competing in naval excellence on the seas, Danish naval officers, who were being trained in shipbuilding, were conducting 'educational voyages' around European shipyards. Hiding among the locals, trying to fit into the crowd in order not to be recognised as the threat they were in fact posing to the military secrets of the nation, they sneaked around naval dockyards. What they returned home with was an impressive amount of drawings and blueprints of ships, buildings, and miscellaneous constructions like docks and dams. The natural inflow of technology and innovation that the warring nations enjoyed through prizes was achieved in part through spying by the Danes. Thus, in the words of naval historian N.A.M. Rodger, the Danes were masters of espionage (Rodger 2006).

Danish espionage led to some quite interesting ship designs in terms of origin. Returning from England in 1745 with a copy of the construction draught of *HMS Augusta*, the construction committee in Copenhagen decided to copy the design. It was a success: the 50-gun ship *Fyen* was then copied further. This time, however, the construction committee in charge of Danish naval shipbuilding decided to change the upper works of the ship. Everything above the waterline was then a copy of vessels built after French methods, also gained from espionage, naturally. Furthermore, the committee fancied a stern like that of a Swedish prize captured 40 years previous. The result was the 50-gun *Grønland* (fig. 2), with a hull copied from an English ship, French inspired upper works and a stern angled like a Swedish war prize. For the purpose of keeping the Kingdom of Denmark-Norway safe, paid for by the king and sailing under Danish colours, it was indeed Danish. In regards to the technology within, it was a result of clandestine international relations.

France was also highly active in industrial espionage. Throughout the 18<sup>th</sup> century, French naval officers and scientists were sent to England to spy on the dockyards. Several written reports remain wherein the French comment on and compare the Royal Navy to La Marine Royale (Bradley 1992, 2005; Llinares 1994). The French naval constructor Blaise Ollivier was



**Fig 2:** Detail of the construction draft for the Danish 50-gun *Grønland*, launched in 1756 (Rigsarkivets tegningsarkiv, A 1179a).



**Fig 3:** Ollivier's design for the 74-gun Dauphin Royal, launched in 1738, was highly inspired by what he had observed in English shipyards, as were some of his subsequent constructions (Duhamel du Monceau 1752, chap. 1, fig. III, p. 144).

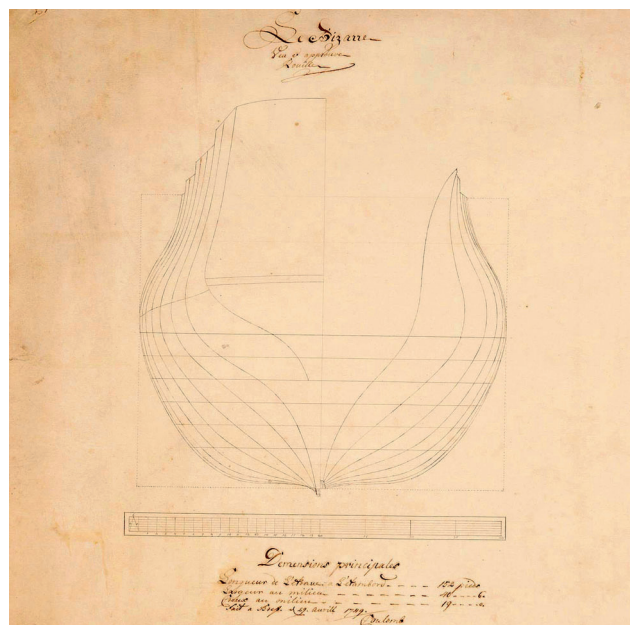
responsible for France building its first heavily armed 74-gun ships after his travels around English and Dutch dockyards in the 1730s (fig. 3). His report, translated and published in 1992, is one of the most important sources on English and Dutch shipbuilding from a French perspective today (Roberts 1992). It is a French interpretation of shipbuilding in England and Holland, and though the report is very thorough, we can only assume that Ollivier reported on whatever he found interesting and relevant to the French shipbuilding industry. Between the lines, the report is a reflection of the state of French shipbuilding at the time.

While industrial espionage was more common in peacetime than during war, it was perhaps carried out in the absence of conflict, but not in the absence of political tension. Industrial espionage infers a pending and potential conflict, for why else spy on your neighbours if they are not potential enemies? Furthermore, espionage was not only in the absence of other means of technological inflow, but a common practice in all countries with a potential enemy right on their doorstep, as was indeed the case in Europe of the 18<sup>th</sup> century. Naval industrial espionage of this century between England and France is only covered in detail by a few historians (Harris 1998; Bradley 1992, 2005). It remains an aspect of naval history that is still somewhat in the dark and yet to be researched.

From espionage, we can move along to the last of the three means of technology exchange: migration. It is a term that is rather hard to define and thus a historical issue that is even harder to detect. When are we talking about migration, and when are we talking about educational travel, or espionage trips? When are we talking about migration and when are we talking about plain tourism? There is indeed an overlap.

In any case, migration, the movement of people, led to technology and knowledge travelling with them. It meant that a French shipbuilder could bring his ideas to Denmark, or an English shipbuilder could introduce his knowledge to Sweden. Obviously, these are not examples taken out of thin air: they happened. The Sheldon family was the main shipbuilding dynasty for quite some time in 17<sup>th</sup> and 18<sup>th</sup> century Swedish shipyards. Born and originally trained in England, the first Sheldon, Francis, brought ideas from his homeland in 1659 into this Scandinavian naval power that was in a continuous struggle with its neighbour, Denmark, over the supremacy of the Baltic. Between 1672 and 1677 he was back in England, then returning to Sweden. After a

stopover in Denmark, he once again went back to England. The last well-known Sheldon, also named Francis, was the third generation of the Sheldon family to be born in Sweden. His father Gilbert and his grandfather Charles had all followed in Francis the Elder's footsteps, and it was natural that little Francis should become a shipbuilder too (Harris 1997, 1999). The migration and the knowledge that went with it, had now morphed into the rather old-fashioned arrangement of master and apprentice, and the knowledge exchange stops here, for the Sheldons at least. Fredrik Henrik af Chapman, the Swedish naval constructor and the pride of naval shipbuilding in late 18<sup>th</sup> and early 19<sup>th</sup> century Sweden was trained in England as well as in France before he came back to Sweden and introduced the scientific approach to shipbuilding (fig. 4). He outshone the Sheldons (Gilbert and



**Fig 4:** The Swedish were, like the Danes, rather interested in French shipbuilding methods. This 1749 draft of a 56-gun ship holds the name of the French shipbuilder Coulomb. It was most likely brought to Sweden by Chapman (Marinmuseum, Karlskrona).



Francis the Younger with whom his work overlapped) with his modern approach to shipbuilding and anything technological and mechanical related to this profession (Harris 1998).

The Danish navy hired the French shipbuilder Laurent Barbé in 1740. It was never to be a success. Otherwise determined to nationalise the shipbuilding in terms of labour force, Denmark was forced to seek expertise from outside the kingdom (Bjerg, Erichsen 1980). Little is known as to Barbé's background, but his methods were considered old fashioned and rigid by the leaders of shipbuilding in the construction committee. His stubborn and arrogant nature did not improve relations between himself and the committee, and he was sacked in 1746. In a time of scarcity in terms of Danish shipbuilders, the navy was willing to import the expertise. Unfortunately, it was not the expertise they had hoped for.

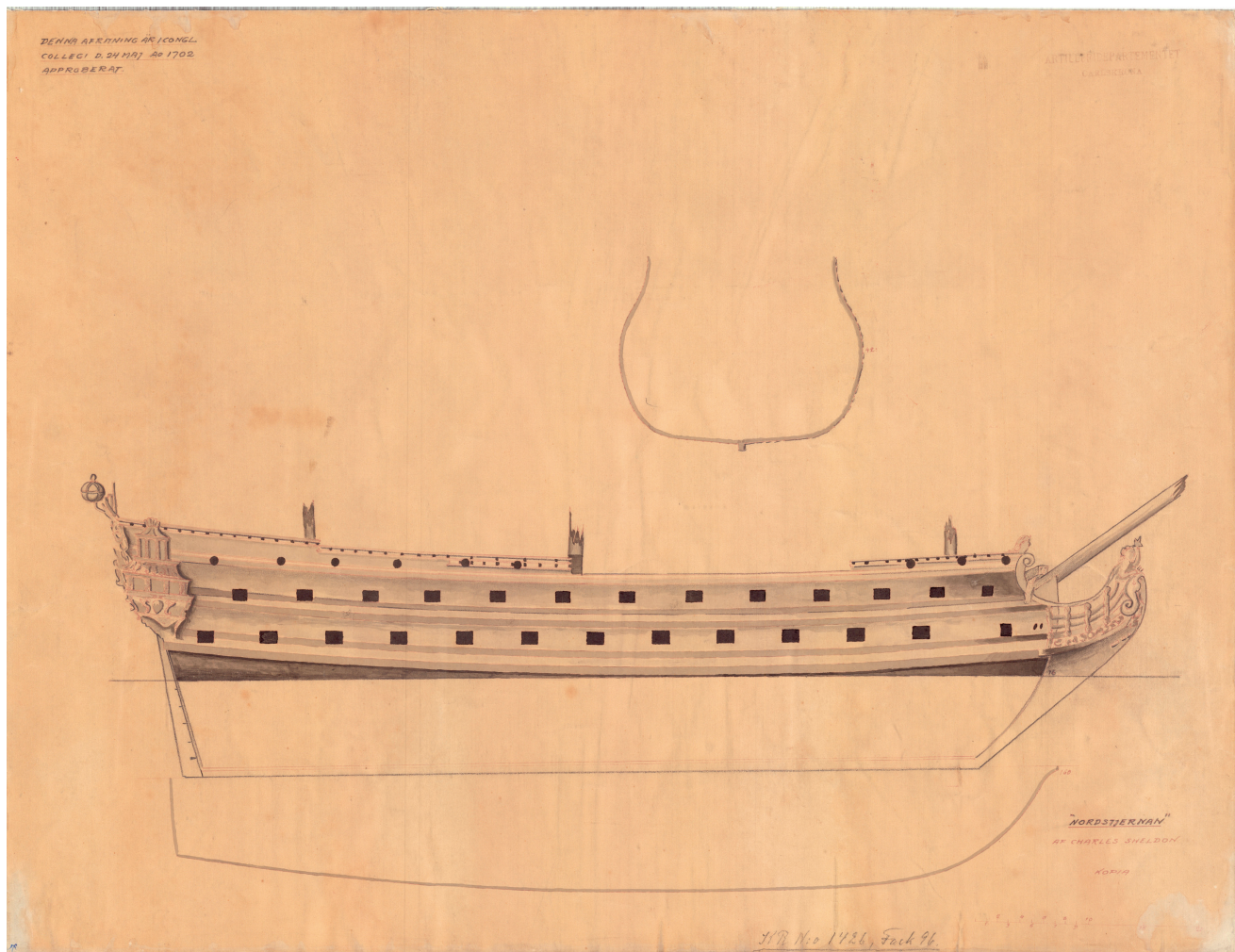
Migration between England and France might have been more intensive than we know of because of religious persecution in both countries. How many Huguenot shipbuilders came to work in English shipyards during the 18<sup>th</sup> century is very hard to say, but the flow of Protestants to England and Catholics to France must have contained people from the shipbuilding industry as well. Furthermore, scientists from England and

France frequently met, especially in the case of determining the Paris/Greenwich longitude meridian, which caused astronomers to work closely together (Bradley 2005). Though with no relation to shipbuilding technology, such an example emphasises the fact that science frequently crossed national borders and national pride.

In conclusion, the technology used in European shipyards of the 18<sup>th</sup> century was far from national. It was used for a national purpose and gathered by national people, paid for by the national state, but for the most advanced machine in the pre-industrial world, a vast part of the technology came from without, not from within national borders (fig. 5).

In terms of maritime archaeology, this project seeks to emphasise the complex nature of ships' designs and construction, and thus the importance of the international relations between the European nations that are represented in 18<sup>th</sup> century shipwrecks.

This PhD project will study the events of technology exchange throughout the 18<sup>th</sup> century and the results of the international relations created in a time characterised by political instability and subsequent arms races and a high motivation to stay on top of the technological innovation game.



**Fig 5:** Nordstjernen. Taken as a prize by the Danes, this Swedish 72-gun ship inspired a new type of stern in Danish naval shipbuilding. She was built by Charles Sheldon and launched in 1703 (Marinmuseum, Karlskrona).

## REFERENCES

- BJERG H. CH., ERICHSEN J.  
1980 *Danske Orlogsskibe 1690-1860: konstruktion og decoration*, Copenhagen, Lademann.
- BRADLEY M.  
1992 Engineers as military spies? French engineers come to Britain 1780-1790, *Annals of Science* 49, p. 137-161.  
2005 *Daniel Lescallier 1743-1822: man of the sea or military spy? Maritime developments and French military espionage*, Lewiston, NY, E. Mellen Press.
- DUHAMEL DU MONCEAU H. L.  
1752 *Éléments de l'architecture navale ou Traité pratique de la construction des vaisseaux*, Paris, Jomber.
- FERREIRO L. D.  
2007 Spies versus prize: technology transfer between navies in the age of Trafalgar, *The Mariner's Mirror* 93.1, p. 16-27.
- HARRIS D. G.  
1997 Francis Sheldon in Denmark 1686-1690, *The Mariner's Mirror* 83.3, p. 293-302.
- 1999 Charles Sheldon and the Baltic's first dry dock, *The Mariner's Mirror* 85.4, p. 396-404.
- HARRIS J. R.  
1998 *Industrial Espionage and Technology Transfer: Britain and France in the Eighteenth Century*, Ashgate, Aldershot-Brookfield.
- LLINARES S.  
1994 *Marine, propulsion et technique : L'évolution du système technologique du navire de guerre français au XVIII<sup>e</sup> siècle*, Thèse de doctorat d'Histoire de l'Université Paris-Sorbonne, Paris IV, 26 mars 1993, Paris, Librairie de l'Inde, 2 vol. (<https://halshs.archives-ouvertes.fr/halshs-00699191>).
- ROBERTS D. (ED.)  
1992 *Blaise Ollivier, 18<sup>th</sup> Century Shipbuilding: Remarks on the Navies of the English and the Dutch from observations made at their dockyards in 1737*, Rothersfield, Jean Boudriot Publications.
- RODGER N. A. M.  
2006 *The command of the ocean: a naval history of Britain, 1649-1815*, London, Penguin Books.





# FROM JONAH TO JACK TAR: THE INTEGRATION OF WHALEBOATS INTO THE BRITISH ROYAL NAVY

Morgan BREENE

---

## Abstract

One of the most distinctive technologies associated with the 19<sup>th</sup> century whaling industry is the whaleboat. A fast, manoeuvrable craft, the whaleboat was adopted by the Royal Navy as a ship's boat, however, the precise date and rationale for this adoption is unknown due to a lack of engagement with the ways in which technologies were transmitted between commercial and naval fleets. Interactions between the whaling and naval fleet in the 18<sup>th</sup> and 19<sup>th</sup> centuries can be used to facilitate a discussion on the means by which the whaleboat transitioned from commercial craft to widely deployed naval ship's boat.

## Keywords

British Royal Navy, ship's boats, technology transfer, whaleboat

## Résumé

La technologie la plus emblématique de l'industrie baleinière du XIX<sup>e</sup> siècle est sans nul doute la baleinière. Embarcation rapide et maniable, la baleinière a été adoptée par la marine royale britannique comme canot embarqué sur ses navires. Cependant, la date précise et la justification de cette adoption demeurent inconnues en raison de notre méconnaissance des modes de transmission technologiques entre les flottes commerciales et les flottes de guerre. Ce sont ces interactions entre la flotte baleinière et la flotte de guerre aux XVIII<sup>e</sup> et XIX<sup>e</sup> siècles qui peuvent nous permettre d'ouvrir une réflexion sur les moyens par lesquels la baleinière a évolué du statut d'embarcation commerciale à celui de canot le plus employé par la marine royale britannique.

## Mots clés

Marine royale britannique, canots, transfert de technologie, baleinière

---

Maritime historians have shown a sustained interest in the technology of the British Royal Navy with a traditional focus on large-scale ship construction, armament, and navigation. Ship's boats, however, while an essential piece of onboard technology, have not warranted the same level of detailed attention. The only major work conducted on ship's boats is W.E. May's 1978 book *The Boats of Men of War* (May 1999), but the potential for these craft to serve as a significant inroad into the motives and means by which new technology was adopted into the navy is great. The integration of the whaleboat will be used here as an example of the ways in which the process of technological adoption by the navy can be illuminated and interpreted.

## 1. HISTORY AND DEFINING CHARACTERISTICS

Whaleboats were originally designed specifically for hunting and killing whales. While the ancestral form of the whaleboat likely dates to the Basque whalers of the 13<sup>th</sup> century, by the mid-18<sup>th</sup> century they appear consistently in a clearly recognisable form (Ansel 2014, p. 8). Commercial whaleboats of the early 19<sup>th</sup> century were double ended, allowing them to move quickly both forwards and backwards; laterally strong, to survive being towed by whales and hurried lowering and raising; relatively cheap to build, ensuring that when the boats were inevitably damaged or broken up by a whale, replacement costs were minimal; and capable of travelling under oar or sail for long distances in both calm and heavy seas and surf (Chapman 1768, plate L item 10; Scoresby 1820, p. 221-23; Steel 1812, p. 182) (fig. 1).

A whaleboat in the British whale fishery in the early 19<sup>th</sup> century was a fast, manoeuvrable double-ended craft, designed to solve many of the problems faced by the offshore whaling industry. Many of these scenarios resembled those faced by the Royal Navy, which lacked a manoeuvrable ship's boat that could survive high surf and dangerous landing conditions. The appearance and use of whaleboats in the whaling industry does not, however, explain or justify their adoption into the navy, and no satisfactory explanations for this phenomenon exist. In his work on Royal Navy ship's boats, May notes only that whaleboats "became popular" as a ship's boat during the Napoleonic Wars, were used with increasing frequency over the course of the century, and reached the point of near-ubiquity after the adoption of the Montagu rig in 1907 (May 1999, p. 52, 73).

This explanation of the timing of adoption is poorly supported by available evidence, including that presented in May's own book, and leaves much to be desired (May 1999, p. 63). Prior work on the transfer of technologies, both in a naval context and more generally, argues for nuanced interpretations and robust utilisation of supporting evidence. Richard Harding has argued that approaches to technological evolution in the Royal Navy that incorporate social and cultural contexts are needed, rather than relying on rational arguments focused on utility (Harding 2016, p. 113). Pfaffenberger (1992, p. 499) made a similar argument, stating that rather than being based on some underlying logic, technological choices are governed by culture, aesthetic interest, and mere preference. Furthermore, Misa (1994, p. 127) has also stressed the need to avoid seeing rationality in historical actors, and confusing outcomes with motivations. It is not sufficient to justify the integration of

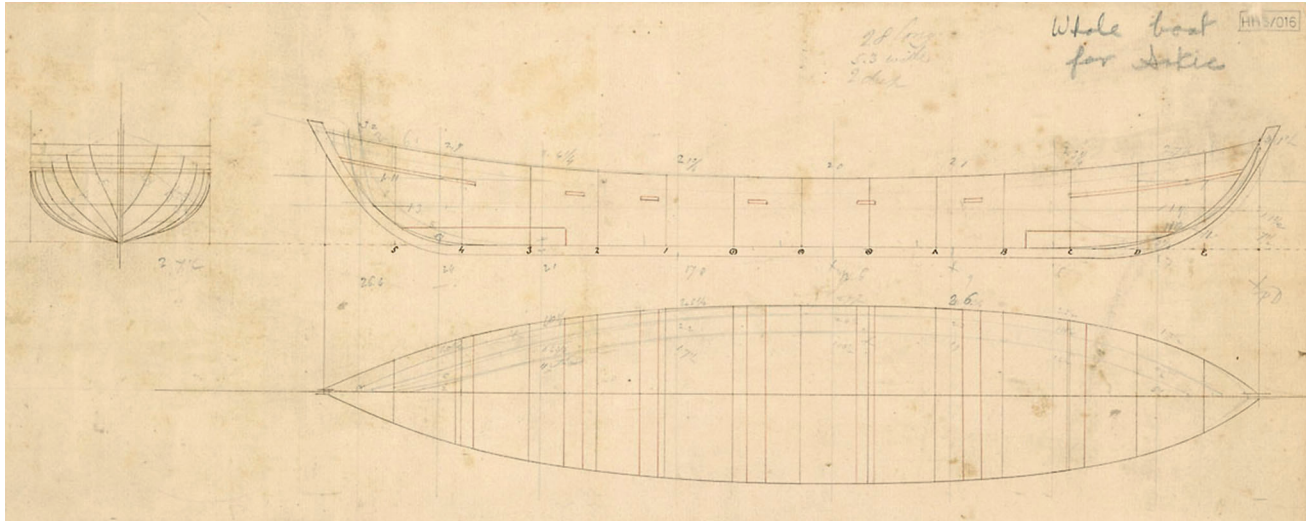


Fig. 1: Lines plan of a 19<sup>th</sup>-century whaleboat (National Maritime Museum, Greenwich, London, HIL 0229).

whaleboats because of the recognition of their ‘usefulness’ by some faceless rational historical entity. Evidence of exposure between the naval and whaling fleets, the perception of particular, overlapping needs, and gradual institutional integration will be used to make a suggestion as to when and how whaleboats were introduced into the naval fleet.

## 2. NAVAL EXPOSURE TO WHALEBOATS

Whaleboats played an important role in the maritime element of colonial-era conflicts in North America. During the American Revolution, small boat operations were used to harry British supply centres and attack British ships in Boston and New York harbours. At the same time, the Royal Navy also used whaleboats to carry out similar operations against the Americans (Chapelle 1951; Gardner 1976, p. 59-63). Whaleboats used in the revolution were purchased or commandeered instead of being specially made for a military purpose, and their use is an example of exposure to the technology and its potential applications.

Additionally, much of the Nantucket whaling fleet was seized and impressed into the Royal Navy, as was nearly half of the Whitby fleet. Impressed whalers were deployed on naval vessels, and whaling ships were used as transports, suggesting extensive opportunities for naval exposure to the particular expertise gained and technology used in the whaling fleet (Ashley 1938, p. 60; Barrow 2001, p. 31). After the revolution, Samuel Enderby, head of a prominent whaling family, urged the Board of Trade to offer incentives to Nantucket whalers to move to Britain with their families, arguing that it was important to have a “Nursery of Seamen” from which to draw expertise in time of war, and to deprive the Americans of the same (TNA, BT 6/93/2).

In the Napoleonic Wars, members of the two fleets interacted again. In April 1808, Captain Philip Broke was sent to Greenland to protect the British whaling fleet, which had been attacked by the French the previous season. Broke contended that his ship went further north than any naval vessel since the 1770s and encountered ice (Clark, McArthur 1815, p. 9).

Whaling crews were again withdrawn to man naval vessels in the British Channel squadron during the later years of the Napoleonic Wars (Enderby 1848, p. 14). The earliest evidence of a whaleboat on a naval vessel comes from this period in the form of a model of an 18-gun, Cruizer-class brig, and dates to circa 1810. These vessels were typically used for blockading, carrying dispatches, and convoying trade, meaning that this model likely represents a vessel from the Channel fleet (fig. 2). The whaleboat on board may be representative of the influence of whalers on that station, and perhaps the behest of a certain captain. This model is not sufficient evidence, however, to suggest institutional adoption.

## 3. EVIDENCE OF INSTITUTIONAL ADOPTION

In 1840, the *Nautical Magazine and Naval Chronicle* published an anonymous editorial on steam navigation, in which the writer tangentially expressed his surprise at the fact that men-of-war did not carry whaleboats, citing their proficiency at travelling through surf, and the navy’s lack of any other class of ship’s boat that could do the same (Mercator 1840, p. 433). While a technically sound assertion, the author may not have been completely correct in assuming the Royal Navy had not begun using whaleboats. Specialised adaptation instead appears to have begun two decades earlier, if not widespread use. Mentions of whaleboats as ship’s boats fall into three categories over the period from 1818-1870: Arctic exploration, the West Africa Squadron, and Pacific exploration.

### 3.1. ARCTIC EXPLORATION

English attempts to find the Northwest Passage began as early as the Elizabethan period, however, interest quickly waned in favour of other trading routes until the middle of the 18<sup>th</sup> century, when an expedition under Constantine Phipps was attempted in 1773 (Phipps 1774). Successive wars distracted the navy from further attempts until that made by John Ross in 1818, which sparked decades of Arctic missions.

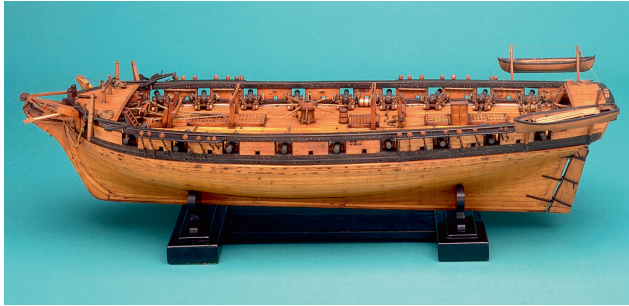


Fig. 2: Model of an 18-gun brig of the Cruizer class, showing a whaleboat on the starboard side, 1810 (National Maritime Museum, Greenwich, London, SLR 0348).

The Arctic is an area in which it seems adoption of the whaleboat happened early, perhaps a result of Captain Broke's experience guarding the Greenland whaling fleet in 1808. Ross's orders from the Admiralty specifically mention the importance of relying on the expertise of whalers:

"And, as the navigation among ice may be considered as an art to be acquired only by practice, we have directed that there be appointed to each of the ships under your orders, a master and a mate of whale-fishing vessels, well experienced in those seas, from whose knowledge and skill you may derive material assistance" (Ross 1819, p. 2).

In addition to employing whalers, Ross also included five whaleboats and supplies for repairing and building additional boats on his list of supplies (Ross 1819, p. xi).

It is less clear whether John Franklin carried whaleboats on his first two Arctic expeditions in 1819 and 1824. Instructions for the fitting out of his 1824 voyage held in the British National Archives include provisions for building four boats especially for the voyage, but the class of vessel was not mentioned (TNA, CO 6/16/9). Whaleboats were included on his doomed 1845 expedition: the plans of the *Erebus* dated 1839 clearly show whaleboats stowed on the upper deck (fig. 3). Subsequent rescue missions over the course of the 1850s all carried whaleboats as well, and whaleboats remained a staple of Arctic expeditions into the 20<sup>th</sup> century (Ansel 1981; Pullen 1982, p. 444; Captain Austin's Arctic Expedition, 1850, p. 400).

### 3.2. WEST AFRICA SQUADRON

In 1807, Britain outlawed the slave trade, and in 1808 established the West Africa Squadron for monitoring the slaving coast. The squadron had no real success until the 1840s, when new treaties gave it further latitude, its size was increased to 25 vessels, and landing and destroying barracoons, or slave depots, was declared legal (Rose 1936, p. 60). May suggests that whaleboats were used extensively in the suppression of the slave trade due to their effectiveness as surfboats, which would explain why the earliest mentions of whaleboats on the West Africa Squadron come from the 1840s: it is not until the Squadron had to contend with dangerous surf that a class of boat well-suited to rough landing conditions would be required (May 1999, p. 73).

The earliest mention of a whaleboat on the West Africa Squadron is from 1845, when it was reported that HMS *Pantaloön* captured a pirate slaver and sent a cutter and two whaleboats to board and take the vessel (Dispatches from Africa, *The Nautical Magazine and Naval Chronicle* 1845, p. 611). When the King of Lagos refused to cease trading slaves in 1852, a contingent landed and proceeded upriver in a flotilla of whaleboats, pinnaces, cutters, and paddle-box boats as a show of strength (Rose 1936, p. 162). In 1853, the boats of HMS *Linnet* captured the brigantine *Paulina*, and in an illustration by the *Linnet's* captain, Henry Need, a whaleboat can be seen in the foreground (fig. 4). As late as 1866, vessels bound for West Africa were specially fitted with whaleboats. In the ship's book for HMS *Reindeer*, instructions were included for the installation of an additional pair of davits before the main mast to carry an extra 27-foot whaleboat if the ship was ordered for the west coast of Africa (TNA, ADM 135/393).

### 3.3. PACIFIC EXPLORATION

Following James Cook's first voyage in 1768, Britain sent successive expeditions of exploration and conquest into the Pacific. A south sea whaling fleet was established shortly after the colonisation of Australia, and through the first half of the 19<sup>th</sup> century leading families in the British whaling industry advocated for strengthening the fishery in order to compete

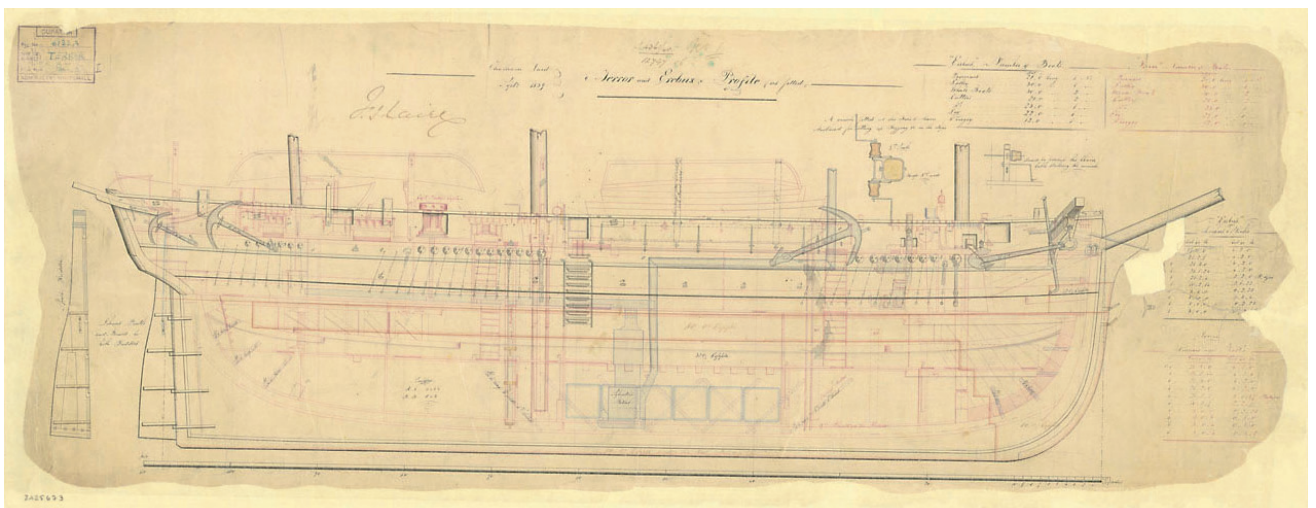


Fig. 3: Plan of the *Erebus*, 1839, showing a whaleboat stowed on the aft upper deck (National Maritime Museum, Greenwich, London, ZAZ 5673).



with the American fleet (Jackson 2005, p. 126; Pearson 1983; TNA, BT 6/93/2).

Whaleboats are mentioned regularly in accounts in the *Nautical Magazine* of exploratory expeditions to the Pacific. In April of 1831, a Lieutenant Preston was wrecked in a whaleboat in the estuary of Nornalup in Australia, while in 1838, the port regulations for Tahiti and Moorea included a punishment for deserters that consisted of cutting and carrying four whaleboats' worth of wood to a specified location (Nairne 1842, p. 448; Port Regulations for Tahiti and Moorea, *The Nautical Magazine and Naval Chronicle*, 1838, p. 418). HMS *Beagle* carried whaleboats when it set out for the south Pacific in 1840, where they were used for scouting and exploration of bays and rivers (Voyage of HMS *Beagle*, *The Nautical Magazine*, 1840, p. 708-711). There are also various allusions to the use of whaleboats by natives. In 1849 in the Pitcairn Islands, natives came out to a Royal Navy ship in a whaleboat because the surf was too high for a ship's boat to land and it could not be achieved without a local pilot (Nautical Notices, *The Nautical Magazine and Naval Chronicle*, December 1849, p. 160). In an account of the "Sandalwood Voyage" to Australia in 1850, Captain Woodin recounted how the chief Angulla moved two whaleboats of the *Vanguard* out of sight of the crew and out of musket range, refusing to give them back (Woodin 1850, p. 299).

#### 4. CONCLUSION

Exposure between the naval and whaling fleets occurred at least as early as the wars in North America in the mid-18<sup>th</sup> century, however, adoption of the whaleboat as a naval craft does not appear to have occurred until much later. Eighteenth century use of whaleboats in North America as raiding, smuggling, and transport craft differs significantly from the use of the whaleboat as a ship's boat in the 19<sup>th</sup> century. Mentions of whaleboats as a ship's boat fall into three main categories and are clustered from the 1840s to 1860s, with some limited examples from 1818 through the 1830s. The use of whaleboats in the Arctic, West Africa and the Pacific all suggest that whaleboats were first utilised on specialised expeditions into existing whaling grounds. The numerous examples of whaleboats in these locales suggest that the introduction of whaleboats was



Fig. 4: Illustration of the capture of the brigantine *Paulina* by the boats of HMS *Linnæus*, sketched by Captain Henry Need, 1853. The boat in the foreground clearly lacks a transom, a key marker of a whaleboat (National Maritime Museum, Greenwich, London, ART/10/1).

gradual, and developed as an extension of the traditional geographical bounds of the whaleboat as a commercial craft. The explicit recognition by the Admiralty of the knowledge held by whalers prior to Ross's 1818 expedition lends credence to this hypothesis, as does Mercator's call for the use of whaleboats in the West Africa Squadron. The mirroring of naval use to commercial use shows that there is no flooding of the naval fleet with whaleboats at the end of the Napoleonic Wars based on a rational acceptance of universal utility, but rather a slow adoption based on the expertise of whalers in certain regions of the world.

#### ARCHIVES

TNA, The National Archives at Kew

ADM 135/393 *Ships Book for the HMS Reindeer*, 1868.

BT 6/93/2 *Board of Trade First Committee papers on the Greenland and South Sea whale fishery*, 1786.

CO 6/16/91 *Correspondence on Captain Franklin's Second Journey*, 1824.

#### REFERENCES

- ANSEL W.  
1981 The Polaris Whaleboat, *The Log of Mystic Seaport* 34.3, p. 84-93.  
2014 *The Whaleboat: A Study of Design, Construction and Use from 1850-1970*, Mystic, Vermont Printing Company.
- ASHLEY C.  
1938 *The Yankee Whaler*, Boston, Houghton Mifflin Company.
- BARROW T.  
2001 *The Whaling Trade of Northeast England*, Sunderland, The University of Sunderland Press.
- CHAPELLE H. I.  
1951 *American Small Sailing Craft: Their Design, Development and Construction*, New York, W. W. Norton and Company.
- CHAPMAN F. H.  
1768 *Architectura Navalis Mercatoria*, Vol. 1, Stockholm.
- CLARK J. S., MCARTHUR J. (EDS)  
1815 Biographical Memoir of Sir Philip Bowes Vere Broke, Bart, *The Nautical Magazine and Naval Chronicle*, p. 1-23.
- ENDERBY C.  
1847 *Proposal for Re-Establishing the British Southern Whale Fishery, through the Medium of a Chartered Company, and in Combination with the Colonisation of the Auckland Islands, as the Site of the Company's Whaling Station*, Second edition, London, Effingham Wilson, 11, Royal Exchange.

- GARDNER J.  
1976 Whaleboat Warfare on the Sound, *The Log of Mystic Seaport* 28.2, p. 59-68.
- HARDING R.  
2016 *Modern Naval History: Debates and Prospects*, London, Bloomsbury.
- JACKSON G.  
2005 *The British Whaling Trade*, Newfoundland, International Maritime Economic History, Association Research in Maritime History 29.
- MAY W. E.  
1999 *The Boats of Men of War*, 2nd ed. London, National Maritime Museum and Chatham Publishing.
- MERCATOR (ANONYMOUS EDITORIALIST)  
1840 Atlantic Steam Navigation. *The Nautical Magazine and Naval Chronicle*, p. 429-439.
- MISA T.  
1994 Retrieving Sociotechnical Change From Technological Determinism, in M. Roe Smith, L. Marx (eds), *Does Technology Drive History? The Dilemma of Technological Determinism*, Cambridge Massachusetts, Massachusetts Institute of Technology Press, p. 115-141.
- NAIRNE W. C.  
1842 Mr Nairne on His Expedition to Nornalup, *The Nautical Magazine and Naval Chronicle*, p. 451-460.
- PEARSON M.  
1983 The Technology of Whaling in Australian Waters in the 19<sup>th</sup> Century, *Australian Historical Archaeology* 1, p. 40-54.
- PFAFFENBERGER B.  
1992 Social Anthropology of Technology, *Annual Review of Anthropology* 21, p. 491-516.
- PHIPPS C.  
1774 *A Voyage Towards the North Pole Undertaken by His Majesty's Command 1773*, London, Nourse.
- PULLEN H. F.  
1982 W.J.S Pullen (1818-1887), *Arctic* 35.3, p. 444-445.
- ROSE J. H.  
1936 The British Royal Navy and the Suppression of the West African Slave Trade, Part II, *The Mariner's Mirror* 20. 2, p. 162-171.
- ROSS J.  
1819 *A Voyage of Discovery: Made under the Orders of the Admiralty*, Vol. 1, London, J. Murray.
- SCORESBY JR. W.  
1820 *An Account of the Arctic Regions, and the Whale-Fishery*, Edinburgh/London, Archibald Constable and Co/Hurst, Robinson and Co.
- STEEL D.  
1812 *The Elements and Practice of Naval Architecture*, London, Steel and Company.
- WARD W. E. F.  
1969 *The Royal Navy and the Slavers*, London, George Allen and Unwin Ltd.
- WOODIN W.  
1850 Sandalwood Voyage. *The Nautical Magazine and Naval Chronicle*, p. 298-302.



# WOODEN SHIPBUILDING IN CYPRUS FROM THE LATE 19<sup>TH</sup> TO THE MID-20<sup>TH</sup> CENTURY

Constantinos NICOLAOU

---

## Abstract

Wooden shipbuilding in Cyprus was a craft based on traditional, pre-industrial design and construction methods. The transition of the island administration at the end of the 19<sup>th</sup> century from the Ottoman to the British Empire with resultant economic and social changes, and then the turmoil of two World Wars with their population movements, impacted on the craft in the first half of the 20<sup>th</sup> century. The evolution of traditional wooden shipbuilding in Cyprus during the 20<sup>th</sup> century constitutes an excellent example of how geographic and socio-economic changes can affect shipbuilding.

## Keywords

British Empire, Cyprus, Ottoman Empire, traditional wooden shipbuilding

## Résumé

À Chypre, la construction navale en bois s'est longtemps basée sur une conception et des méthodes de construction traditionnelles typiquement préindustrielles. À la fin du XIX<sup>e</sup> siècle, la transition administrative de l'île de l'Empire ottoman à l'Empire britannique, avec les changements économiques et sociaux qui en résultèrent, puis la tourmente de deux guerres mondiales, ont eu un grand impact sur le métier de charpentier de marine. L'évolution de la construction navale traditionnelle chypriote au cours du XX<sup>e</sup> siècle constitue un excellent exemple de la manière dont les changements géographiques et socio-économiques peuvent affecter la construction navale.

## Mots clés

Empire britannique, Chypre, Empire ottoman, construction navale traditionnelle en bois

---

The period from the late 19<sup>th</sup> to the mid-20<sup>th</sup> century, the last phase of the widespread use of wooden vessels in the Mediterranean, was a period that shaped modern Cypriot wooden shipbuilding activity. It coincides with British rule on the island, during which the administrative and political system changed after 300 years of Ottoman rule, along with historical events of global impact, like the two World Wars, which also affected the socio-economic conditions of the island. This article discusses the results of a broader research into vernacular wooden shipbuilding on Cyprus during this period within its historical and cultural context.

As this is the first attempt at a systematic recording of the island's nautical heritage, published literature on the subject is very limited. The main sources used were of four types. Information on the historical and economic context of the period was retrieved from 19<sup>th</sup> century consular reports, the British administration's annual reports, known as 'Blue Books', and the statistical publications of the Republic of Cyprus after the country's independence in 1960.

In order to create a coherent typology of the small wooden vessels of Cyprus, 19<sup>th</sup> century published photographs were the main source of information for the early period of the research (Bonato *et al.* 2007, p. 14, 2011, p. 57-62). In addition, a total of about 35,000 photographs from private archives and published albums were examined, of which only 700 were related to shipping and shipbuilding activity in Cyprus.

Ethnography was extensively used, with interviews of elderly mariners and especially the last Cypriot shipwrights, now in their 70s or older, who were able to give, even indirect, information about the craft during the mid-20<sup>th</sup> century.

About 400 boats docked in fishing shelters or small harbours around the island have been visually inspected and used both as

a direct and indirect source of information on shipbuilding and typology. The characteristic features of almost 150 of them were recorded.

## 1. THE HISTORICAL CONTEXT

By 1571 Cyprus had become part of the Ottoman Empire (Papageorgiou 1996, p. 67). From the end of the 17<sup>th</sup> century the island experienced economic decline with a negative impact on the local population, which suffered from high tax, poverty and mortality rates. The negative socio-economic status seems to have continued up until the 19<sup>th</sup> century (Dionyssiou 2009, p. 166). According to British consular reports for the years 1854-1858, the local population was engaged mainly in agricultural work on a very basic level, leaving large fertile areas uncultivated, while it seems to have had a very limited involvement in maritime activities (Papadopoulou 1980, p. 57-58, 60). According to Ottoman archives, a state shipyard operated on the island during the 17<sup>th</sup> and 18<sup>th</sup> century (Mpekiaroglou-Exadaktidou 1994, p. 53, 56), however, no information about an organised shipyard is reported in the official consular reports of the 19<sup>th</sup> century. In 1878, after a secret agreement between the Ottoman Empire and Great Britain, Cyprus came under British rule (Hadjivasiliou 1998, p. 43-44). One of the British administration objectives, however, was the general development of the economy including trade and shipping (Hadjivasiliou 1998, p. 44), and thus particular attention was paid to the recording of related activities by the authorities. Thus far no strong local shipbuilding activity could be identified in the late 19<sup>th</sup> century.



In the early 20<sup>th</sup> century, even though Cyprus was not really involved territorially in the First World War, it was affected by the war's migration problems. From 1914 more than 300,000 refugees, mainly from Asia Minor, moved to different regions of the eastern Mediterranean and some of them seem to have ended up in Cyprus (Michaelides 2018, p. 50-51). In 1922, the Greek Asia Minor Campaign and subsequent debacle led to the destruction of Smyrna and the violent and permanent removal of the Greek population (Llewellyn Smith 1973, p. 284-311). Between November 1921 and November 1923, a total of 5,249 Greek refugees ended up on Cyprus (Mathopoulou 2015, p. 81-106). Among others, craftsmen of different expertise, shipbuilders included, significantly enriched the local vernacular industries (Egoumenidou-Rizopoulou 1998, p. 125-147).

During the Second World War, Cyprus was used by Britain as a transit point for over 23,000 Greeks on their way to Egypt and the Middle East: more than 5,500 of them settled permanently on the island (Michaelides 2018, p. 177-179). The majority of them came from the Aegean islands and in particular from Samos and Symi, which had strong shipbuilding traditions (Michaelides 2018, p. 52-53, 108-112; Damianidis 1998, p. 30-32).

## 2. SHIPBUILDING IN CYPRUS

According to British consular reports, five to ten brigs or *goletes* and a total of 30 to 80 small fishing boats were permanently docked in the ports of the island during the years 1854-1858 (Papadopoulou 1980, p. 60). Another report of the Ministry of Foreign Affairs of the United States in 1856 gives the following information:

“There being no good port in Cyprus, the number of vessels belonging to the island is quite insignificant, and these are small craft not built in Cyprus, but on the coast of Caramaria [Karamania] from Castel Rasso to Adalia. Vessels are also sometimes bought at public sales in and out of the island; but these instances are extremely rare. Small boats are built in Cyprus now and then” (Merchant’s Magazine and Commercial Review 33, January-June, 1856, p. 387).

Even though shipbuilding activity is not reported in the consular or administration reports, the presence of a number of wooden vessels on the island during the late 19<sup>th</sup> century is possibly a result of the existence of some basic shipbuilding

infrastructure, or at least the existence of some basic knowledge in relation to the repair and maintenance of wooden vessels. This is definitely confirmed by photographs of the late 19<sup>th</sup> or early 20<sup>th</sup> century depicting wooden ships careening, i.e. during maintenance (Chatterton 1914, p. 335).

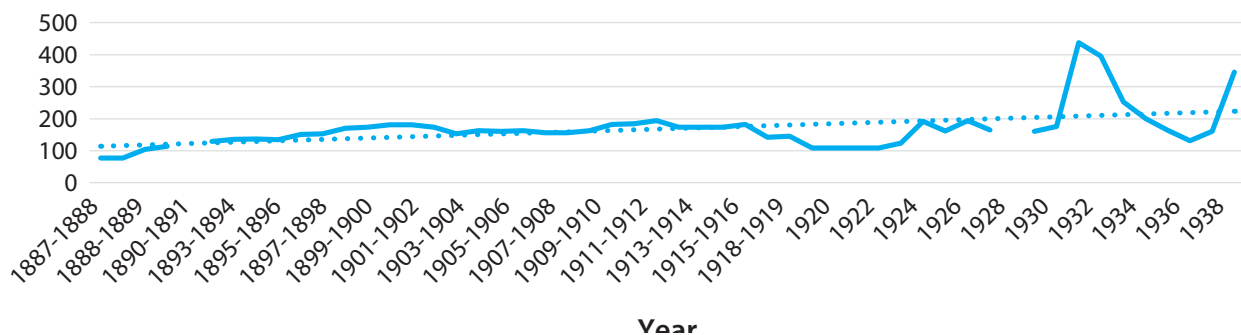
The existence of Cypriot registered sailing vessels is documented by the ‘Blue Books’ from 1888 to 1946, although their number cannot be accurately determined, nor can it be confirmed that these vessels were permanently docked in the island. However, probably no more than two or three dozen permanently docked caiques, in Kyrenia and Limassol if not elsewhere, sailed beyond the island and belonged to wealthy locals engaged in commerce, at least since the early 20<sup>th</sup> century (Yiordamli 2008, p. 106-109).

According to the ‘Blue Books’ for the years 1887-1888, a total of 77 fishing boats were docked in the harbours of Limassol, Larnaca, Famagusta and Kyrenia. Until 1916, the number of fishing boats gradually increased, when Paphos was added as a mooring as well. From 1917 up until 1946 the numbers fluctuate, with some interesting indications. After a decline between the years 1920-1923, an impressive, sharp increase is recorded in 1932, a drop in 1938, and an increase again in 1946. One of the issues that emerges here is the possibility that some of these boats came from abroad and were only temporarily involved in fishing in Cypriot waters. This could explain the annual variations that are presented in the numbers of vessels over the years, especially after 1920 (Table 1).

The first documented testimony of wooden shipbuilding in Cyprus found so far dates back to 1917 in Kyrenia, when the Cypriot shipwright Kostas Fitos and one of his brothers (Michalis or Alexandros) were called from Limassol to Kyrenia and built two or three wooden caiques for the local businessman Demosthenis Severis. The information is reported by the newspaper *Φωνή της Κύπρου* (The Voice of Cyprus, 30/04/1919), and is confirmed by Katselli (1979, p. 140) as well as by interviews with Karkanias (CRC/OTA 1), Ekonomou (CRC/OTA 3) and Toumanis (CRC/OTA 2) (fig. 1).

The first official report of a shipyard in Cyprus is found slightly later in the ‘Blue Books’, in 1922, and concerns a small “boatbuilding yard” in Famagusta. The existence of a boatbuilding yard in Famagusta is reported every year up until 1936, while during the years 1925, 1930, 1934, 1935 and 1936 another unit with very limited staff and very small production, not exceeding five boats per year, is also reported. This must be related to the arrival of

**Number of Fishing Boats 1887-1946**



**Table 1:** Number of boats engaged in fishing according the ‘Blue Books’ for the years 1887-1946.



Fig. 1: Wooden vessels under construction: unknown photographer, Kyrenia 1910s (Katselli 1979, p. 99).

Greek refugees from Asia Minor. According to Andoniadis (2018, p. 88), as well as to two different shipwrights who were interviewed, Kyriakou and Nicolaou (NC 1-2), two shipwrights named Pantelis Stavrou and Kyriakos Konstantinou (Kimilis) came as refugees and engaged in shipbuilding in the towns of Famagusta and Limassol. Marios Parbour (probably of Lebanese origin) seems to have been another shipwright who, according to his grandsons (NC 7), might have already been working in Limassol in the 1920s and then moved to Lebanon probably in the 1930s. Giakoumis “Varkaris” (no information about his origins were found) and “Mastre” Giorgis (son-in-law of the shipwright Pantelis Stavrou of Asia Minor origin) were reported as shipwrights in Famagusta during the 1920s by Kantounas (CRC/OTA 5) as well as by Eleftheriou (NC 3). The oldest known shipwright that worked in Larnaka is Dimitris (Dimitros) Skeparnidis. According to Andoniadis (2018, p. 90) and Nicolaou (NC 2), he was a Cypriot engaged in shipbuilding at least since the 1920s.

During the period between the Second World War and 1960, at least 27 shipwrights were engaged in building boats and small caiques around the island (fig. 2). Three of them (Pantelis Stavrou, Kyriakos Konstantinou Kimilis and Dimitris Skeparnidis) had already been working since the 1920s and continued their activity during the next decades. However, Kantounas (CRC/OTA 5), as well as four different shipwrights who were interviewed (NC 1, 3-4, 6, 8), agreed that at the beginning of the Second World War in 1940, five shipwrights and their relatives from the island of Symi (Loucas, Giannis, Nikos and Vassilis Moraris, together with Eleftherios Billis) came as refugees to Cyprus and worked in different cities.

## 2.1. SHIPBUILDING ACTIVITY IN DIFFERENT CITIES

In Famagusta there seems to have been no large organised shipyard before 1953, when, according to Tziortzis (CRC/OTA 7), Kantounas (CRC/OTA 6) and Zouvanis (CRC/OTA

4), the first one was established within the city’s port: it seems that only vessels of up to 200 tons could be hoisted out of the water there. In the same oral testimonies, as well as in the testimonies of Toumanis (CRC/OTA 2), Spaou (CRC/OTA 8) and five other shipwrights that were interviewed (NC 1, 3-6), at least eight shipwrights were reported as working in the city. These were: Nicolaos Eleftheriou Billis (son of Eleftherios Billis from Symi), Chrysostomos Antoniou, Panagiotis Dimitriadis, Gregoris Panayi, Christos Fartas, Mattheos Philis, “Mastre” Panaos and Riskalas Parpour. The shipwrights were working either in the port’s shipyard, or in small private shipyards. Although no information about the origins of any of them was found, most of them were locals or from Greece, except one, Riskalas Parpour, who according to his sons (NC 7) learnt the craft from his father, Marios Parpour, in Lebanon and immigrated to Cyprus in 1956 or 1957. He first settled in Paphos and then in Famagusta where he established a small shipyard.

In Larnaca, according to Andoniadis (2018, p. 90) as well as the five shipwrights who were interviewed (NC 1-3, 6, 8), two other Cypriots worked alongside Dimitris Skeparnidis and learned the craft from him: Antonis Kyriakidis (Otsokkas) and Patroklos Nikolaou (Patroklis).

In Limassol, in addition to Pantelis Stavrou and Kyriakos Konstantinou Kimilis, Lambros Rigos and Dimitris Agisilaou, both Cypriots, were reported as shipwrights by Yiordamli (2008, p. 114) and Andoniadis (2018, p. 88), as well as by six shipwrights that were interviewed (NC 1-4, 6, 8). During the 1950s a new generation of shipwrights learned the craft and engaged in shipbuilding in Limassol. These were Herakles Kyriakou (son of Kyriakos Konstantinou Kimilis) and the Cypriot brothers Grigorios Avgousti and Charalambos (Hampis) Avgousti, whose families were the most active shipwright families on the island during the second half of the 20<sup>th</sup> century. Ali Jafer Rati is the only Turkish Cypriot shipwright reported during the research: he learnt the shipbuilding craft from



Fig. 2: Map of Cyprus presenting shipyard locations during the first half of the 20<sup>th</sup> century (drawing C. Nicolaou, 2019).

Dimitris Agisilaou and worked also in Limassol (Yiordamli 2008, p. 114).

In Kyrenia the only reported shipwright was the Cypriot Sotiris Georgiou (Karagiaouris) who was the owner of a small shipyard and one of the shipwrights that were interviewed (NC 4).

The Cypriot Vasilis Shiakallis was reported by Kofteros (2010), as well as by Kyriakou (NC 1), Georgiou (NC 4) and Spyrou (NC 6), as a shipwright in Karavostasi, (Morfou district). He was also the owner of a small shipyard.

In Paphos, the only shipwright reported during this period was Pantelis Kyriakou (son of Kyriakos Konstantinou Kimilis) who, according his brother Kyriakou (NC 1), engaged in shipbuilding in the early 1950s, but he died in an accident in 1957.

## 2.2. SHIPBUILDING TECHNIQUES

In order to study and characterise shipbuilding activity and origins on the island, an understanding of the shipbuilding design methods is required. Information about the methods used during the period under consideration was primarily available from the local modern shipwrights whose knowledge was obtained from the shipwrights who worked on the island in the first half of the 20<sup>th</sup> century. Research has shown that the basic shipbuilding design methods used locally were: the *monochmaro*, a 'master frame' method used by seven shipwrights that were interviewed (NC 1-3, 5-8); and the *sala*, a 'lofting process' used by six shipwrights that were interviewed (NC 1-2, 4-5, 7-8).

The same methods are found and similarly named in the Aegean tradition, and are used in different variants (Damianidis 1989, p. 180-227, 1993, p. 97-101; Prifti, Loukakis 1993, p. 141-149). Similar methods are also found in several Mediterranean traditions (Bloesh 1983, p. 148-149; Lane 1992, p. 93-97; Marzari 1998, p. 192-211; Rieth 1998, p. 91-100, 2011, p. 409-418; McGrail 2001, p. 164-165). However, during research it emerged that shipbuilding design knowledge was poor among most of the modern local shipwrights, which led to the use of local variants in order to create a new vessel. A typical method, probably used in order to ensure a positive result, was the creation of moulds after the construction of a successful vessel, which were then re-used for the construction of new vessels. This method was used by at least by five shipwrights who were interviewed (NC 1-2, 5, 7-8) and is a distinct practice not common to the Aegean.

The local shipbuilding process was based on the frame-first or skeleton-first method, where the frames (skeleton) of the vessel precede the construction of the shell, a method which most probably became gradually predominant somewhere between the 6<sup>th</sup> and the 10<sup>th</sup> century AD and has prevailed to date in most of the Mediterranean and on traditions further afield (Steffy 1994, p. 83-100; McGrail 2001, p. 160-164; Rieth 2011, p. 409; Pomey *et al.* 2012, p. 235-314).

The construction of the shell was based on the carvel method, where the planks are placed edge to edge in order to create a smooth outer surface (Adams 2013, p. 53-55). The shipbuilding process included seven different basic stages described the same way by the eight shipwrights who were interviewed, and they include:

- the laying down of the keel and the posts;
- the construction and adjustment of the frames, called *skarmoloima*;
- the adjustment of the longitudinal reinforcing elements;
- the deck fastening;
- the planking, called *maderoma*;
- the ceiling
- the caulking, called *kalafatisma* (NC 1-8).

The local shipbuilding process presents obvious similarities with the Aegean tradition in the construction procedures, the use of particular construction parts, and the terminology. (Damanidis 1989, p. 255-304).

## 2.3. TYPES OF VESSELS AND SAILS

For the period between the late 19<sup>th</sup> and the middle of the 20<sup>th</sup> century, 11 different types of vessel, according to their hull construction features, were found to be built or used on the island. These include six vessels with a pointed stern: *botis*, *trexantiri*, *trexantira*, *tserniki*, *maouna* or *fortigida*, and *santali*; three with a transom stern: *varkalas*, *bombarda* and *passara*; and two with an elliptical stern: *karavoskaro* and *liberty* (NC 1-8; CRC/OTA 1-8; Chiotellis 1987, p. 137; Pilavakis 1997, p. 226; Yiordamli 2008, p. 106-116; Kofteros 2010, p. 174-177; Antoniadis 2018, p. 90). The above 11 types are also found in the Greek traditional typology (Segditsas 1940, p. 237-258; Konstantinidis 1954, p. 137, 156, 565; Throckmorton 1964, p. 205-216; Denham 1986, p. 277-293; Damianidis 1998, p. 41-76). The presence of imported vessels on the island during the specific period was also confirmed, however it seems that vessels from a non-Greek speaking region were called by the corresponding Greek names according to their hull construction features. Two cases were found to be the exception to this pattern, however information about their construction features is very limited. The first case is a vessel called a *douba*, probably of Middle Eastern origin (Yiordamli 2008, p. 107-108), and the second is a vessel called a *pottouni*, probably of English origin (CRC/OTA 7).

In addition to the vessels' hull typology, 16 different types of sail and combinations of sails were also found. All of them have been identified in photographic records. These include: two triangular sails, *latini* (lateen) and *pena* (Bermuda or gunter); four quadrilateral sails, *sakoleva* or *sakolefi* (sprit), *psatha* (lug), *randa* or *mpouma* (gaff) and *stavrosi* or *pina* (square); seven combinations of sails: *briki* or *vriki* (brig), *brigantini* or *polaka* (brigantine or polacre), *goleta* (gulet), *bombarda*, *brazzera*, *radopsathi*, *schoona* or *lover* (schooner); and three secondary



sails: *flokos*, *straliera* and *trikettina* (variant of *tourkettina*) (CRC/OTA 2-3, 8-10; Chiotellis 1987, p. 137). The same types are also found in the Aegean typology (Kotsovilis 1919; Damianidis 1998, p. 77-96), and most of them correspond to types used widely in the Mediterranean and beyond (Casson 1964, p. 57-198; Moore 1970).

### 3. CONCLUSIONS

Significant local shipbuilding activity on the island cannot yet be corroborated during the middle and end of the 19<sup>th</sup> century, at least on an organised level. Thus, a local shipbuilding tradition cannot be identified either, even though the existence of Cypriot flagged vessels and Cypriot ship owners can be confirmed. The reason behind this is probably related to the limited needs for wooden vessels by wealthy local merchants, or local fishermen. These needs could more easily be addressed by the experienced and productive shipyards of neighbouring areas, especially those in Asia Minor and the Aegean, or by occasional shipbuilding taking place on the island, or even through the importing of used vessels from nearby places. The first documented evidence of wooden shipbuilding in Cyprus for the period under consideration is dated to the end of the 1910s, however, there is no official reference to shipbuilding activity on the island before 1922 according to statistical records kept from the beginning of the British administration. The establishment of the first small shipbuilding units seems to have triggered the shipbuilding craft on the island. This tradition, in the sense of apprenticeship, was based in most of the cases on the simple relationship of an employer and an employee. The involvement of the majority of Cypriot shipwrights in shipbuilding during the first half of the 20<sup>th</sup> century has been through choice and was less associated with a family tradition, which has never in fact exceeded two generations.

The collected evidence also indicates that during the first half of the 20<sup>th</sup> century there was a clear impact of Greek traditional shipbuilding on the island. The settlement and activity of Greek shipwrights, the terminology preserved through the modern shipwrights, as well as the types of vessels built locally, all point towards this conclusion. The common cultural background between Greek Cypriots and Greeks has certainly enhanced this process, which was initiated by the political and economic events of the period. It therefore appears that the local development of wooden shipbuilding between the late 19<sup>th</sup> and the mid-20<sup>th</sup> century has been the result not of a specific need for wooden vessels, but mainly of certain historical events.

It depended mainly on the settlement of shipwrights from Asia Minor and the Aegean, who filled an existing gap in this craft on the island.

### ETHNOGRAPHIC SOURCES

Interviews of the Oral Tradition Archive (OTA), Cyprus Research Centre (CRC) conducted by the researchers K. Barris, C. Georgiou, E. Ktoridou, V. Kella, U. Kypri, G. Mathaiou, A. Neophytou, Z. Papaconstantinou, K. Protopapa, S. Spyrou and N. Xristofidou.

**CRC/OTA 1:** Record n. 256, Kyrenia, 65: testimony of Giannis Karkanias, Kyrenia resident (10/12/1990, 22/12/1990).

**CRC/OTA 2:** Record n. 523, Kyrenia, 95: testimony of Andreas Toumani, fisherman (20/03/1991, 21/03/1991).

**CRC/OTA 3:** Record n. 1626, Kyrenia, 133: testimony of Michael Economou, Kyrenia resident (21/03/1992, 02/04/1992).

**CRC/OTA 4:** Record n. 3031, Famagusta, 49: testimony of Charalampos Zouvani, portman (30/06/1993, 20/05/1993).

**CRC/OTA 5:** Record n. 3134, Famagusta, 50: testimony of Georgios Kantouna, mariner (10/09/1993, 28/09/1993).

**CRC/OTA 6:** Record n. 3135, Famagusta, 51: testimony of Georgios Kantouna, mariner (15/09/1993, 28/09/1993).

**CRC/OTA 7:** Record n. 4765, Famagusta, 170: testimony of Andreas Tziortzis, shipyard owner (23/02/1996, 26/02/1996).

**CRC/OTA 8:** Record n. 5626, Famagusta, Liopetri, 11: testimony of Christodoulos Spaou, fisherman (25/02/2005).

**CRC/OTA 9:** Record n. 154, Kyrenia, 32: testimony of Cristofis Philipou Christoforidi, Kyrenia resident (24/11/1990, 26/11/1990).

**CRC/OTA 10:** Record n. 169, Kyrenia, 36: testimony of Cristofis Philipou Christoforidi, Kyrenia resident (01/12/1990, 03/12/1990).

Interviews conducted by the author (NC):

**NC 1:** Heracles Kyriakou, shipwright, Limassol (21/12/2016).

**NC 2:** Patroklos Nicolaou, shipwright, Larnaca (26/08/2017).

**NC 3:** Nicolaos Eleftheriou (Billis), shipwright, Limassol (09/01/2018).

**NC 4:** Sotiris Georgiou (Karagiaouris), shipwright, Limassol (09/01/2018).

**NC 5:** Charalampos Pogiartzis (Champis), shipwright, Paralimni (27/05/2018).

**NC 6:** Antonis Spyrou (Nicolis), shipwright, Xylophagou (06/06/2018).

**NC 7:** Rimon, Marios, Georgios Parbour, shipwrights, Paphos (21/07/2018).



## REFERENCES

- ADAMS J.  
2013 *A Maritime Archaeology of Ships, Innovation and social change in Medieval and Early Europe*, Oxford, Oxbow Books.
- ANTONIADIS S.  
2018 *Παλαιοί Τεχνίτες της Λάρνακας / Old Craftsmen of Larnaca*, Larnaca, Βιβλιοεκδοτική / Bibliokdotiki.
- BLOESH P.  
1983 Mediterranean Whole Moulding, *The Mariner's Mirror* 69, p. 305-306.
- BLUE BOOK  
*The Cyprus Blue Book*, 1886-1938 and 1946, Nicosia, 55 volumes.
- BONATO L., ΥΙΑΚΟΥΜΙΣ CH., ΚΑΒΑ Κ.  
2007 *Η Νήσος Κύπρος, Φωτογραφικό Οδοιπορικό από τον 19ο στον 20ο Αιώνα / The Island of Cyprus, Photographic Journey from the 19<sup>th</sup> to the 20<sup>th</sup> Century*, Nicosia, Εν τύποις / Entypis.
- BONATO L., ΚΑΡΑΓΕΩΡΓΗΙΣ J., ΥΙΑΚΟΥΜΙΣ H.  
2011 *Η Κύπρος Πανοραμικά / Cyprus Panoramic*, Nicosia, Kallimages.
- CASSON L.  
1964 *Illustrated History of Ships & Boats*, New York, Doubleday & Company, Inc.
- CHATTERTON E. K.  
1914 *Sailing Ships*, London, Sidgwick & Jackson LTD.
- CHIOTELLIS N.  
1987 Οι Καραβοκύρηδες της Κερύνειας / Kyrenia's Ship-owners, in A. Chrysochos, St. Spyrou, K. Limpouris (A. Χρυσόχος, Στ. Σπύρου, Κ. Λυμπουρή) (eds.), 1987, Το Καράβι της Κερύνειας / *the Ship of Kyrenia*, Nicosia, Έκδοση Υπουργείου Παιδείας / Publication of the Ministry of Education, p. 137.
- DAMIANIDIS K.  
1989 *Vernacular Boats and Boatbuilding*, PhD thesis, University of St Andrews.  
1993 Methods for Controlling the Form of Vessels During Shipbuilding in the Eastern Mediterranean – 18<sup>th</sup> and 19<sup>th</sup> Centuries, in K. Damianidis (ed.), *The Evolution of the Wooden Shipbuilding in the Eastern Mediterranean during the 18<sup>th</sup> and 19<sup>th</sup> Centuries, 1st International Workshop*, Athens, Π. Μπαλλίδης / P. Mpallidis & ΣΙΑ Ο.Ε. p. 97-101.  
1998 *Ελληνική Παραδοσιακή Ναυπηγική / Greek Vernacular Shipbuilding*, Athens, Πολιτιστικό Τεχνολογικό Ίδρυμα ETBA, Β' Έκδοση / Cultural Technological Foundation ETBA, 2<sup>nd</sup> Edition.
- DENHAM H. M.  
1986 Aegean Caiques (1915-1980), *The Mariner's Mirror* 72, p. 277-293.
- DIONYSIOU A. G.  
2009 *The Implimentation of the Tanzimat Reforms in Cyprus (1839-1878). An Assessment of the Greek and Ottoman Evidence from Local Sources*, Nicosia, MAM.
- EGOUMENIDOU-RIZOPOULOU E.  
1998 Σχέσεις Κύπρου και Μικράς Ασίας σε Τομείς της Λαϊκής Τέχνης / Relations between Cyprus and Asia Minor in Folk Art Field, *Μικρασιατικά Χρονικά / Asia Minor's Chronicles* 21, p. 125-147.
- HADJIVASILIOU E.  
1998 *Το Κυπριακό Ζήτημα 1878-1960, Η Συνταγματική Πτυχή / The Cyprus Issue 1878-1960, The Constitutional Aspect*, Athens, Ελληνικά Γράμματα / Ellinica Grammata.
- CATSELLI R.  
1979 *Κερύνεια: Ιστορική, Λαογραφική Έρευνα / Kyrenia: A Historical Study*, Nicosia, Χρυσopolitissa / Chrisopolitissa (in Greek).
- KOFTEROS K.  
2010 Βασίλης Σιακαλλής Ναυπηγοξυλουργός στο Καραβοστάσι / Vasilis Shiakallis a Shipwright in Karavostasi, *Ενατενίσεις / Enatenisis* 10, p. 174-177.
- KOSTANTINIDES T. P.  
1954 *Καράβια Καπετάνιοι και Συντροφοναύται (1800-1830) / Ships Captains and Comrade-Sailors (1800-1830)*, Athens, Έκδοσις Ιστορικής Υπηρεσίας Β.Ν. / Publication of Historical Service B.N.
- KOTSOVILLIS G. I.  
1911 *Περί Εξαρτισμού των Πλοίων / About Ships' Rigging*, Syros, Τυπολιθογραφείο Νικόλαος Φρέρης / Printing Shop Nicolaos Freris.
- LANE C. F.  
1992 *Venetian Ships and Shipbuilders of the Renaissance*, London, Johns Hopkins University Press.
- LLEWELLYN SMITH M.  
1973 *Ionian Vision, Greece in Asia Minor 1919-1922*, London, Allen Lane.
- MARZARI M.  
1998 Evolution of Shipbuilding Techniques and Methodologies in Adriatic and Tyrrhenian Traditional Shipyards, in E. Rieth (ed.), *Concevoir et construire les navires de la trière au picoteux*, Ramonville Saint-Agne, Erès, Technologies, idéologies et pratiques 13-1, p. 192-211.
- MATHOPOULOU E.  
2015 Οι Πρόσφυγες από την Μικρά Ασία στην Κύπρο: Έλευση και Εγκατάσταση / The Refugees from Asia Minor to Cyprus: Arrival and Settlement , in G. Ch. Chotzakoglou (Γ.Χ. Χοτζάκογλο) (ed.), *Κύπρος-Μικρασία, Κοιτίδες Πολιτισμού, Πρακτικά Α' Επιστημονικού Συμποσίου, Λευκωσία 2012 / Cyprus-Asia Minor, Cradles of Civilisation, Proceedings of the 1<sup>st</sup> Scientific Conference, Nicosia 2012*, Nicosia, Σύνδεσμος Μικρασιατών Κύπρου / Asia Minor Cypriots Association.
- McGRAIL S.  
2001 *Boats of the world. From the Stone Age to Medieval Times*, New York, Oxford University Press.
- MICHAELIDES D. I.  
2018 *Παιδιά του Οδυσσέα, Έλληνες Πρόσφυγες στη Μέση Ανατολή και στην Αφρική (1941-1946) / Odysseus's Children, Greek Refugees in the Middle East and in Africa (1941-1946)*, Athens, Μεταίχμιο / Metechmio.
- MOORE A.  
1970 *Last Days of Mast and Sail, an Essay in Nautical Comparative Anatomy*, Oxford, David & Charles Reprints (2nd edition).
- ΜΡΕΚΙΑΡΟΓΛΟΥ-ΕΧΑΔΑΚΤΙΛΟΥ Α.  
1994 *Οθωμανικά Ναυπηγεία στον Παραδοσιακό Ελληνικό Χώρο / Ottoman Shipyards in the Traditional Greek Space*, Athens, Πολιτιστικό Τεχνολογικό Ίδρυμα ETBA / Cultural Technological Foundation ETBA.
- PAPAGEORGIOU S.  
1996 *Η Πρώτη Περίοδος της «Αγγλοκρατίας» στην Κύπρο, 1878-1914: Πολιτικός Εκσυγχρονισμός και Κοινωνικές Αδράνειες / The first Period of the «British occupation» in Cyprus, 1878-*

- 1914: *Political Modernization and Social Inactions*, Athens, Εκδόσεις Παπαζήσης / Papazisis Publishings.
- ΠΑΡΑΔΟΡΟΥΛΛΟΥ ΤΗ.  
 1980 *Πηγαί και Μελέται της Κυπριακής ιστορίας, Προξενικά έγγραφα του 19<sup>th</sup> αιώνα* / Sources and Studies of the Cypriot history, Consular documents of the 19<sup>th</sup> century, Nicosia, Κέντρο Επιστημονικών Ερευνών Κύπρου / Cyprus Research Centre.
- ΠΙΛΑΒΑΚΗΣ Κ.  
 1997 *Η Λεμεσός σ' άλλους καιρούς / Limassol in Other Times*, Limassol, Εκδόσεις Ονήσιλος, Β' Έκδοση / Onisilos Publishings, 2<sup>nd</sup> Edition.
- ΡΟΜΕΥ Ρ., ΚΑΧΑΝΟΒ Υ., ΡΙΕΤΗ Ε.  
 2012 Transition from Shell to Skeleton in Ancient Mediterranean Ship-Construction: Analysis, Problems, and Future Research, *IJNA* 41.2, p. 235-314.
- ΠΡΙΦΤΙ C., ΛΟΥΚΑΚΗΣ Τ. Α.  
 1993 Technical contributions to the study of traditional Greek vessels, in K. Damianidis (ed.), *The Evolution of the Wooden Shipbuilding in the Eastern Mediterranean during the 18<sup>th</sup> and 19<sup>th</sup> Centuries, 1st International Workshop*, Athens, Π. Μπαλλίδης / P. Mpallidis & ΣΙΑ Ο.Ε., p. 97-101.
- ΡΙΕΤΗ Ε.  
 1998 Une tradition médiévale et méditerranéenne de conception des navires construits à franc-bord 'membrane première', in E. Rieth (ed.), *Concevoir et construire les navires de la trière au picoteux*, Ramonville Saint-Agne, Erès, Technologies, idéologies et pratiques, 13-1, p. 91-100.
- 2011 Mediterranean Ship Design in the Middle Ages, in A. Catsambis, B. Ford, D. L. Hamilton (eds), *The Oxford Handbook of Maritime Archaeology*, Oxford, Oxford University Press, p. 409-418.
- ΣΕΓΔΙΤΣΑΣ Ρ. Ε.  
 1940 *Κωπήρη και Ιστιοφόρα Πλοία / Rowing and Sailing Ships*, Athens.
- ΣΤΕΦΥ Ρ. J.  
 1994 *Wooden Ship Building and the Interpretation of Shipwrecks*, College Station TX, Texas A&M. University Press.
- ΘΡΟΚΜΟΡΤΟΝ Ρ.  
 1964 Roman Shipwrecks and Aegean Ships, *The Mariner's Mirror* 50, p. 205-216.
- ΥΙΟΡΔΑΜΛΙ Α.  
 2008 *Echoes from the Past, The Turkish Cypriot Community of Limassol and its Heritage*, Nicosia, Terra Cypria, The Cyprus Conservation Foundation.



# HULL CHARACTERISTICS OF THE YENIKAPI 16 GALLEY

Ufuk KOCABAŞ and Işıl Özsait-KOCABAŞ

## Abstract

The Theodosian harbour, unearthed during salvage excavations at Yenikapı by the Istanbul Archaeology Museums, has revealed many archaeological artefacts that have enriched the cultural history of Istanbul, in addition to 37 shipwrecks, which sank at different moments over a time span of approximately 600 years. The Byzantine *galeai* discovered are particularly important, as they constitute the first archaeological evidence of galleys in the early medieval age. In this article, we shall describe the construction characteristics of one of these galleys, YK16, within the context of the other galleys.

## Keywords

Byzantine shipbuilding, galley, Istanbul, Theodosian harbour, Yenikapı shipwrecks,

## Résumé

Le port de Théodose, mis au jour lors des fouilles de sauvetage à Yenikapı par les équipes des musées d'archéologie d'Istanbul, a révélé de nombreux objets archéologiques qui ont grandement enrichi la connaissance de l'histoire d'Istanbul. Parmi ces découvertes on compte 37 épaves, qui ont coulé à différents moments sur une période d'environ 600 ans. Les *galeai* byzantines découvertes sont particulièrement importantes, car elles constituent le premier témoignage archéologique de galères du début du Moyen Âge. Dans cet article, nous allons décrire les caractéristiques de construction de l'une de ces galères, baptisée YK16, tout en tenant compte d'observations effectuées sur d'autres galères découvertes sur le même site.

## Mots clés

Construction navale byzantine, galère, Istanbul, port de Théodose, épaves de Yenikapı,

Salvage excavations were conducted in the Yenikapı quarter of the historic peninsula of Istanbul by the Istanbul Archaeological Museums (IAM) between 2004 and 2013 (Kızıltan 2010; Kocabaş 2015b). The Theodosian Harbour, which was unearthed during these excavations, has revealed many archaeological artefacts that have enriched the cultural history of Istanbul, in addition to 37 shipwrecks dating from the 5<sup>th</sup> to the 10<sup>th</sup> centuries AD. The Yenikapı ships can be divided into two main groups: the galleys (or long warships) and merchantmen. Six galleys were identified among the Yenikapı shipwrecks: four of them have been studied by a team from Istanbul University (YK13, YK16, YK25 and YK36) and two of them by the Institute of Nautical Archaeology (YK2 and YK4) (Pulak 2007, p. 213-215; Pulak *et al.* 2015, p. 62-68).

Yenikapı 16 (YK16) was discovered in 2008 on the east side of the site, at -1.30/-1.80 m below sea level (fig. 1). The wreck has been dated to between AD 720 and 890 by radiocarbon analyses (Kocabaş 2012, p. 7). *In situ* surveying of the wreck was conducted using a total station device. The inner surface of the planking was drawn in detail on clear acetate at full scale. General and detailed photography and a photomosaic study were carried out. The timbers were lifted using a procedure developed on site. Thereafter, ship members were recorded in full-scale three dimensions using a Faro Arm in the IU Yenikapı Shipwrecks Research Centre. Studies of the construction technology and reconstruction of Yenikapı galleys are ongoing.

## 1. THE HULL CHARACTERISTICS

The preserved dimensions of YK16 are 22.5 m in length and 2.4 m in width. Only one side of the hull survived. It is preserved from the garboard to above the third wale on the starboard side, while the stern and port sides have been partially destroyed. Extant elements of YK16 comprise the central keel timber and a curved keel timber, pieces of keelson, most of the frames, two stringers, three wales, planking, a knee and elements of rowing thwarts (fig. 2).

### 1.1. KEEL TIMBERS

YK16's central keel timber is rectangular in section. Its dimensions are on average 16 cm moulded and 14 cm sided. The curved keel timber was scarfed to its end at the bow. The central keel and curved keel timbers have rabbets.

### 1.2. PLANKING

Preserved hull planking is composed of nine strakes on the starboard side and four strakes on the port side. The garboards (PP1, PS1) were made from three planks. The garboard planks were fastened in the keel rabbets with closely spaced iron nails, driven from the outer surface towards the keel. The planks were on average 3 cm thick and varied from 24 to 30 cm in width, except planks placed between wales (Planks PS8 and PS9 are about 5.5 cm); and their original length over 10 m. Each strake is made up of three planks. The planks were joined by S-shaped





Fig. 1: In situ view of YK16 (photograph Istanbul University Yenikapı Shipwrecks Project/IUYSP Archive).

scarfs and span four or five frames each. Scarf lengths varied from 60 to 105 cm. Hull planking has an alternating arrangement of the plank placement and scarf orientation. Plank seams with luting were fastened with dowels up to the first wale. Spaces between the widely spaced dowels range from 44 to 140 cm.

### 1.3. WALES

Three wales were found *in situ* on the starboard side of the YK16 hull. Between these wales, there are narrow planking strakes. The first wale (Wale 1) was thicker than the others and almost square in cross section. It was 13 cm moulded and 15 cm sided, and its preserved length was 14.7 m. Wale 1 has 16 sockets cut into its upper face. These sockets were 12-13 cm in width and 1.5-2 cm in depth. The distances between the centres of these sockets vary from 90 to 97 cm. These are likely for fitting the rowing thwarts.

### 1.4. THWARTS AND KNEES

Thwart pieces were preserved in some sockets on Wale 1. Dovetail joints were identified on some rowing thwart-wale joints. Similar rowing thwarts have been identified on the galley YK13. Some of the rowing thwarts had to be placed where frames were: a groove was then cut to place the thwarts.

Only one knee sample supporting a rowing thwart was found. But sites of the other knees can be identified from marks on the planks.

### 1.5. FRAMES

Frame timbers were preserved on the shipwreck at 139 frame stations (fig. 3). They are thin and fragile. Frames were on average 5 cm sided and 6 cm moulded. They were closely spaced, with room and space ranging from 20 to 24 cm. YK16 was built with a framing pattern of alternating floor timbers and paired half-frames. The futtocks were positioned on the fore or after sides of the floor timbers. They were fastened to the planking, but not attached to the floor timbers. Frames were fastened to planking

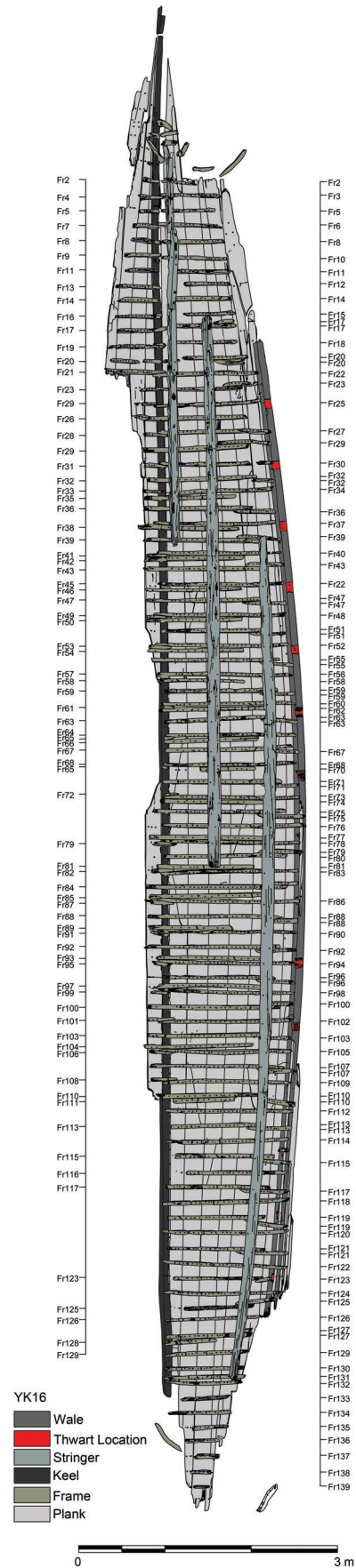


Fig. 2: Plan of YK16 (IUYSP Archive, digital version processing /DVP M. Sağır and Ç. Şanlıgöçler).

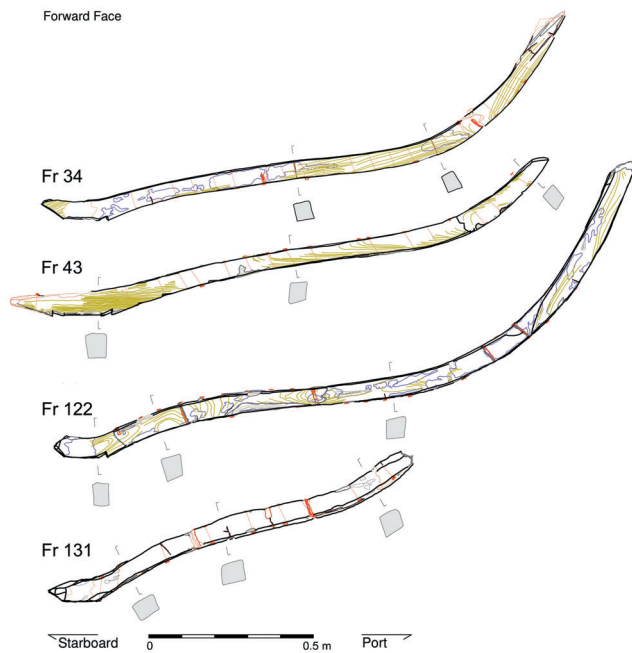


Fig. 3: Faro Arm drawing of frames Fr34, Fr43, Fr122, Fr131 (drawing G. Turan, PDV Ç. Şanlıgençler).

with treenails and iron nails. These consisted of four to five closely spaced treenails (approximately at intervals of 6-7 cm) and one or two iron nails per strake. All floor timbers and half-frames were nailed to the keel with a single iron nail.

### 1.6. KEELSON

The keelson's bow and stern ends were broken. Its preserved length is about 604 cm. It has shallow notches cut on the underside that fit on the floor timbers. Also, there are two mortises on the upper surface of the keelson.

### 1.7. STRINGERS

Two stringers extended across the frames. These stringers were slightly rounded on the top surface and flat on the lower surface. Their ends are broken. They were 16-20 cm wide and 30 mm thick. The preserved lengths of these stringers were 820 cm (stringer 1) and 1270 cm (stringer 2). The stringers were fastened to the frames with short iron nails.

## 2. TREE SPECIES

A total of 239 wood samples were taken from YK16's hull for genus or species identification. YK16 was mainly built with black pine (*Pinus nigra* Arn.), eastern plane (*Platanus orientalis* L.), elm (*Ulmus* L.) and fir (*Abies* L.). The keel members and keelson pieces were identified as eastern plane (*Platanus orientalis* L.). Wales, stringers and a few planks were fir (*Abies* L.). Planks were black pine (*Pinus nigra* Arn.). Frames were mainly from elm (*Ulmus* L.) and eastern plane (*Platanus orientalis* L.). Treenails

were oak or red oak and dowels were from Spanish broom (*Spartium junceum* L.) (Akkemik, Kocabaş 2013, p. 34).

## 3. CONSTRUCTION AND RECONSTRUCTION

The galleys are easily distinguished from merchantmen at the Yenikapı site by their long, slender hulls, thwarts for oarsmen, oar ports, and the types of timber used. The galleys that have been studied by Istanbul University are dated between the 8<sup>th</sup> and 10<sup>th</sup> century and their preserved lengths vary from 19 to 23 m (except YK36). Preliminary evidence shows that galleys YK13, YK16, YK25 and YK36 have dowels joining the plank edges, while planks within a strake are joined with long S-shaped scarfs. They have thick planks and delicate frames. Frames were attached to the planking with treenails and iron nails. Long and wide stringers running along the hull were attached to the frames. Wales are thick and robust (Kocabaş 2015b, p. 91, 95-97, 115, 135). The main wood species used in the galleys are *Pinus nigra*, *Cedrus libani*, *Platanus orientalis*, *Ulmus* sp and *Castanea sativa* (Akkemik, Kocabaş 2013, p. 33). Long, narrow hulls built of light frame timbers and strong planking timbers would have provided the galleys with the required high speed and manoeuvrability, along with robustness (Özsait-Kocabaş, Kocabaş 2008, p. 176-82).

Information derived from other Yenikapı galleys with similar dimensions and building characteristics have contributed to the reconstruction of YK16. Fragments of thwarts have been identified on YK13 (Kocabaş 2015a, p. 22), YK25 (Kocabaş 2015a, p. 23) and YK4 (Pulak *et al.* 2015, p. 66). Also, one complete thwart timber was found on YK2 and was studied by INA (Pulak *et al.* 2015, p. 63). YK16 has 16 preserved sockets on its first wale, and pieces of thwarts in these sockets. According to these, the location of thwarts and the distance between the upper side of the thwarts and upper side of the floor timbers of YK16 could be determined. With the additional archaeological evidence of YK4 (Pulak *et al.* 2015, p. 67) and YK36 (Kocabaş 2015a, p. 27), it may be supposed with great probability that an oar port strake was located on the third wale of YK16. Based on these details and the required measurements for rowing, the distance between thwart and rowlock were determined. Moreover, abrasions related to the pressure caused by the oarsmen's feet were detected on the floor timbers. This finding indicates the accuracy of the measurements obtained (fig. 4). Referring to the evidence and analyses, the original dimensions of the galley YK16 is estimated to be approximately 28-30 m in length and 4 m in breadth. It is thought to have been single banked, having one row of oarsmen on each side. It probably had 25 oars on either side based on the spacing of the rowing thwarts and estimated hull dimensions, adding up to 50 oars in total. This oared ship may be connected with the *galeai* mentioned in Byzantine texts (Pryor, Jeffreys 2006, p. 188-189): the single banked scout ships that led the way for the principal Byzantine warships called *dromons* in the Byzantine navy (Casson 1994, p. 98; Sakelliades 1997, p. 47-54; Pryor, Jeffreys 2006, p. 190). The *galeai* were used for surveillance or as support ships for *dromons* and this particular one had 25 oars on either side, with 50 oars in total (Pryor, Jeffreys 2006, p. 254-255). In medieval sources, small galleys are described with a single mast and lateen sail (Pryor, Jeffreys 2006, p. 188-89, 246, 564). The mortises on the inner surface of the YK16's keelson may be evidence pointing to the presence of this equipment.

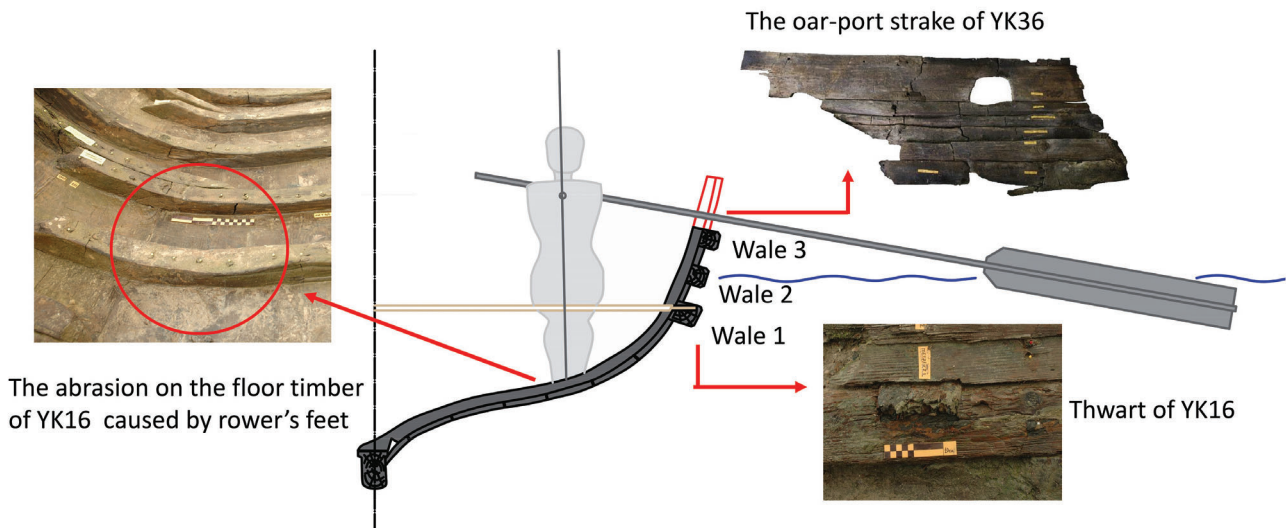


Fig. 4: Ergonomics of YK16 (drawing I. Özsait-Kocabaş, DVP Ç. Şanlıgençler).

#### 4. CONCLUSIONS

The recovered Byzantine *galeai* are particularly important, being the first archaeological evidence of galleys used in the Byzantine navy. Moreover, they now provide the bulk of the archaeological evidence for galleys throughout the Mediterranean region for Byzantine periods. When YK16 is evaluated with other Yenikapı galleys, very important knowledge about the design and ergonomics of Byzantine galleys has been obtained such as the dimensions and the seating order and seating intervals, heights of the rowers and construction techniques.

#### ACKNOWLEDGEMENTS

We would like to extend our sincere thanks to Istanbul Archaeological Museums, to Zeynep Kızıltan and Rahmi Asal; to the Istanbul University Yenikapı Shipwrecks Project team. The Yenikapı Shipwrecks Project was supported by Istanbul University Scientific Research Projects Unit (Project no: 2294, 3907, 7381, 12765).

#### REFERENCES

- AKKEMİK Ü., KOCABAŞ U.  
2013 Woods of the old galleys of Yenikapı, Istanbul, *Mediterranean Archaeology and Archaeometry* 13.2, p. 31-41.
- CASSON L.  
1994 *Ships and seafaring in ancient times*, London, British Museum Press (2nd edition).
- KIZILTAN Z.  
2010 Excavations at Yenikapı, Sirkeci and Üsküdar within Marmaray and Metro projects, in U. Kocabaş (ed.), *Istanbul Archaeological Museums, Proceedings of the 1st Symposium on Marmaray-Metro Salvage Excavations, Istanbul 2008*, Istanbul, Epsilon, p. 1-16.
- KOCABAŞ U.  
2012 The latest link in the long tradition of maritime archaeology in Turkey: The Yenikapı shipwrecks, *European Journal of Archaeology* 15.1, p. 1-15.  
2015a The Yenikapı Byzantine-Era shipwrecks (Istanbul, Turkey): a preliminary report and inventory of the 27 wrecks studied by Istanbul University, *IJNA* 44.1, p. 5-38.  
2015b *Geçmişe açılan kapı, Yenikapı batıkları*, Istanbul, Ege Yayınları.
- ÖZSAIT-KOCABAŞ I., KOCABAŞ U.  
2008 V. Technological and constructional features of Yenikapı shipwrecks: a preliminary evaluation / V. Yenikapı batıklarında teknoloji ve konstrüksiyon özellikleri: bir ön değerlendirme, in U. Kocabaş (ed.), *The 'Old Ships' of the 'New Gate' 1, Yenikapı Shipwrecks, Vol. 1 / Yenikapı'nın Eski Gemileri 1, Yenikapı Batıkları Cilt 1*, Istanbul, Ege Yayınları, p. 97-186.
- PRYOR J. H., JEFFREYS E. M.  
2006 *Age of the ΔΡΟΜΩΝ: The Byzantine navy ca 500–1204*, Leiden, Brill.
- PULAK C.  
2007 Yenikapı Byzantine shipwrecks, in A. Karamani-Pekin, S. Kangal (eds), *Istanbul: 8000 Years, Brought to Daylight. Marmaray, Metro and Sultanahmet Excavations*, Istanbul, Vehbi Koç Vakfı, p. 202-15.
- PULAK C., INGRAM R., JONES M., MATTHEWS S.  
2015 Eight Byzantine shipwrecks from the Theodosian harbour excavations at Yenikapı in Istanbul, Turkey: an introduction, *IJNA* 44.1, p. 39-73.
- SAKELLIADES, V.,  
1997 Byzantine naval power, in D. Zafiropoulou (ed.), *Journeys on the Seas of Byzantium*, Athens, Hellenic Ministry of Culture, p. 47-53.



# THE HOPPER BARGES OF MARSEILLES

Xavier CORRÉ

## Abstract

The archaeological excavations of Place Jules-Verne in Marseille, France, at the beginning of the 1990s revealed three ancient sister-ships (JV3, JV4 and JV5) abandoned near the shoreline around AD 100. These shipwrecks feature a central cavity, which made them difficult to identify. Medieval sources have now helped us to identify them as hopper barges designed to pickup sludge from the bottom of the harbour and to carry and dump it in another place by means of a 'door' we can now reconstruct in the bottom of the barge hull.

## Keywords

Harbour dredging, hopper barge, Marseille

## Résumé

Les fouilles archéologiques de la place Jules-Verne à Marseille, en 1993, ont révélé les vestiges de trois bateaux antiques tout à fait similaires (JV 3, 4 et 5) abandonnés près du rivage vers l'an 100 apr. J.-C. Ces épaves présentent une cavité rectangulaire au centre de la carène au niveau du fond. Cette caractéristique a rendu leur interprétation difficile. Néanmoins, les sources médiévales ont permis de les rapprocher des gabarres à vase conçues pour évacuer les vases du port et les déverser au large en ouvrant la trappe de fond.

## Mots clés

Dragage portuaire, gabarre à vase, Marseille

The three shipwrecks Jules-Verne 3, 4 and 5 (JV3, JV4 and JV5) were first presented a few months after their discovery by Patrice Pomey during the *Tropis V* symposium of 1993 in Nafplio (Pomey 1999). Twenty-five years later, we have an opportunity to present what has happened since this discovery: preservation, study and exhibition.

## 1. DISCOVERY: A REMINDER

These three shipwrecks were discovered in 1993 during excavations of the Place Jules-Verne, next to Marseilles town hall. The overall archaeological dig was led by Antoinette Hesnard but shipwreck excavations were directed by Patrice Pomey, both

of whom were members of the CNRS – Centre Camille Jullian. For details of these discoveries and excavations, one should refer to the numerous articles they have written (Hesnard 1995, 1999, 2004a, 2004b; Hesnard, Pasqualini 1993; Hesnard *et al.* 2001; Pomey 1993, 1995, 1999, 2005; Pomey, Hesnard 1994), about which we can only provide a short summary here.

The shipwrecks belonged to a harbour context. JV5 had been abandoned at the end of the 1<sup>st</sup> century AD in front of a warehouse *circa* 15 m from the shoreline. This shore was constituted by a beach running to the west of the mouth of a small stream, and by a quay connected to a *dolia* warehouse, east of this stream. Ships JV3 and JV4 were loaded with stones and deliberately sunk at the beginning of the 2<sup>nd</sup> century AD, *circa* 8 and 16 m from the quay in order to provide foundations for a wharf (fig. 1).

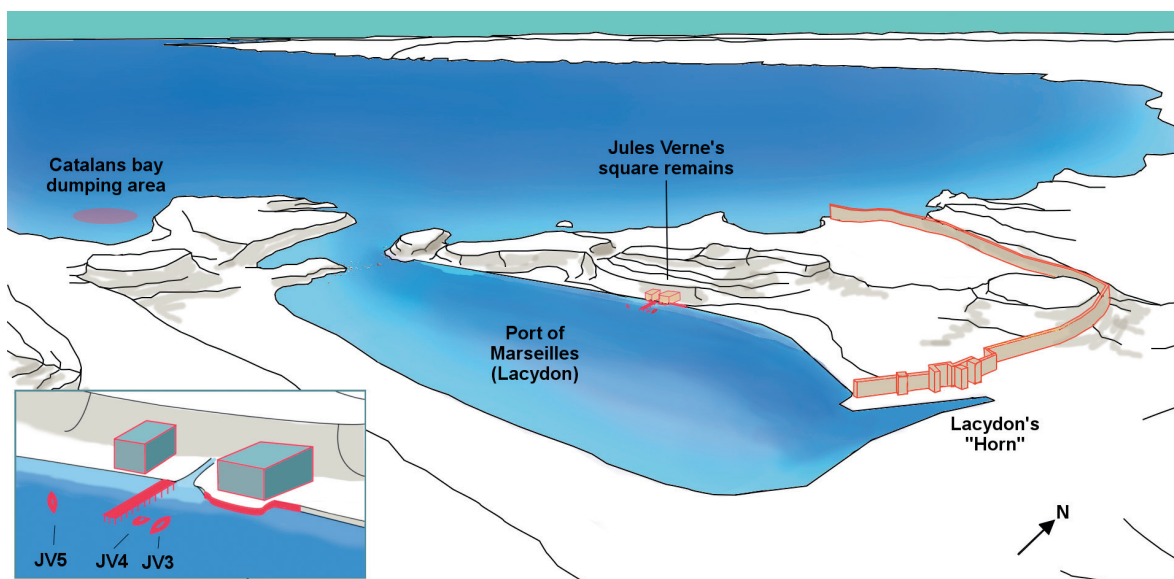


Fig. 1: Hopper barges; general (harbour) and detailed (Place Jules-Verne) contexts (drawing X. Corré).



Their states of preservation varied: JV3 was best preserved in length, JV4 was preserved only in its forward third, and JV5, the most deteriorated, represented almost half a ship. Characteristics of these three shipwrecks defined them as sister ships, 16 m long and 5 m wide.

The three hulls had the particularity of a central and rectangular cavity (2.60 x 0.50 m). Framed lengthwise by two stringers and crosswise by two floor timbers: these cavities interrupted the keels. In spite of its bad state of preservation, JV5 featured wooden planks carefully disposed and angled with the rectangular cavity, thus creating a well that was wider in its upper part.

## 2. CONSERVATION

During the 1980s, the museums of Marseilles, in response to agreements between the French State and the city regarding archaeological artefacts discovered in Marseilles, developed a determined policy, unusual at the time, of financial, human and technical engagement in the entire post-excavation process (conservation, study, scientific publication, exhibition catalogues etc.) (Morel *et al.* 2004). The archaeological material from Place Jules-Verne was obviously concerned. However, given that there were nine shipwrecks in this excavation, municipal funding was insufficient, and the Roman shipwrecks could not be treated and restored in Grenoble, unlike the two Archaic Greek examples (JV7 and JV9) and the small prow of a rowboat from the 3<sup>rd</sup> century AD (JV8). The solution was then to apply a slow drying process for JV3 and JV4, which had been disassembled, wrapped in polyurethane tarpaulins, sprayed with fungicide and stored in a stable atmosphere in a dark room of the Marseille History Museum (Area 54), awaiting new funding for restoration (Morel-Deledalle 1999, p. 43). JV5 was too badly preserved for this long process to be applied and it could not be saved after excavation.

## 3. INTERPRETATION

The lack of similar boats known for the ancient Mediterranean forced the researchers to guess what kind of boats they were dealing with. The central well, associated with the strength of the frames and the numerous traces of impacts, led Patrice Pomey to conclude that he had excavated harbour service barges. Providing a more detailed interpretation was tricky but appeared to be possible when considering two other discoveries made during these excavations: inland, archaeologists revealed signs of Roman<sup>1</sup> dredging which had caused the disappearance of stratigraphic layers of the Hellenistic period; at sea, a wooden crank wheel from a “gear” was found next to these shipwrecks. It seemed then possible to link these three boats to dredging activity, and their noticeable originality naturally led Patrice Pomey, followed by Antoinette Hesnard, to identify them as very specific boats: dredgers.

1. For Marseille, it is usual to distinguish a Greek Period, from the city's foundation (600 BC) to Julius Caesar's siege of the town (49 BC), and a Roman Period, from this siege to the end of antiquity.

Inspired by a picture of the port of Marseille in the 16<sup>th</sup> century showing a boat fitted with a gantry bearing a large vertical wheel, Patrice Pomey very cautiously hypothesised that JV3, JV4 and JV5 could be identified as bucket-chain dredgers (Hesnard, Pasqualini 1993, p. 33; Pomey 1993, p. 60, 1995, p. 468-469, 1999, p. 323; Pomey, Hesnard 1994, p. 113). The crank wheel could have belonged to the drive mechanism of the bucket-wheel, with the chain running across the well of the hull.

For her part, Antoinette Hesnard presented in 1998 a model, made by Denis Delpalillo and then exhibited in the Roman Docks Museum in Marseille, of a dredger fitted with two vertical squirrel-cage wheels and two lateral dipper arms, known in Marseilles from 1682. One year later, she suggested two possibilities (Hesnard 1999, p. 48-49): the dredger of 1682 and a dredger with a bucket-chain also drawn in 17<sup>th</sup> century.

In order to solve the puzzle of these boats, comparisons seemed a good option, especially after the promising material provided by the comparative study of the port of Marseille in antiquity and the Middle Ages conducted by Antoinette Hesnard, Philippe Bernardi and Christian Maurel for a symposium in 1999 (Hesnard *et al.* 2001). Within this context, Pomey and Hesnard gave us the opportunity to explore this track in a doctoral thesis begun in 2001 (Corré 2009).

## 4. MEDIEVAL ARCHIVES (13<sup>TH</sup>-16<sup>TH</sup> CENTURY)

If medieval sources on Marseille are too poor in iconography to have provided immediate data for comparisons, written archives are in contrast numerous enough to provide information. We could target, for example, 197 texts dealing with maintenance of the port between 1229 and 1500<sup>2</sup>. Written in cursive script, in Latin or medieval Provençal, these sources needed meticulous inventorying, verification<sup>3</sup>, transcription and translation, which could not be done for immediate post-excavation exploitation.

Two main facts emerged from this study, which was successfully defended in 2009 but is still unpublished except for a short synthesis of the principal ideas in Corré 2013.

First, there were numerous attempts in the Middle Ages to build dredgers in Marseille. The first mention of a municipal order for building a dredger appears in 1324 with a harbour maintenance contract for ten years, in which is also mentioned the “usual place” where dredged materials are dumped, namely “Saint Lambert's Bay”<sup>4</sup> nowadays Baie des Catalans.

It should be noted that, according to Régine Pernoud, who published many medieval texts about the port of Marseille, a

2. Most of these are held in the Communal Archives of Marseille (ACM) or in the Departmental Archives (AD13) of the Bouches-du-Rhône. In our thesis, 27 texts written between 1229 and 1753 and related to port maintenance are given as supporting documents. In the following notes, they are indicated with the abbreviation PJ (*pièces justificatives*).

3. Sometimes historians rely on and copy short abstracts provided with inventories of archives without checking the sources. These abstracts may include misleading simplifications, extrapolations or errors and thus the information relayed by historians is corrupted but becomes written history (*cf. infra* about the bucket-chain dredger).

4. ACM, BB13, f° 131 v; AD13, 381 E 406, f° 15-20.



Fig. 2: Dionisio di Martino, Escavazione del fondo marino del Mandraccio nel 1575, second half of the 16<sup>th</sup> century (N.I.M.N. 3513, courtesy of Galata Museo del Mare-MuMA, Genoa).

bucket-wheel was used in 1300-1301 and in 1323 (Pernoud 1949, p. 285, note 3). Nevertheless, the references she gave mention only harbour dredging and prisoners assigned to this activity<sup>5</sup>: a bucket-wheel is thus her extrapolation. A dredging machine is however definitely mentioned many times, in 1333 or 1340, but it is never specified that it is a bucket-wheel (Corré 2009, PJ V.13-V.16).

Perhaps this idea came from texts of 1408 related to important restoration work, financed by Pope Benedict XIII, of the towers based in the water at the entrance of the port<sup>6</sup>. These sources indeed mention a machine removing water from a watertight cofferdam in order to conduct dry masonry work offshore.

It must also be noted that, during this work, the city commissioned a machine fitted with iron pincers to remove stones from the seabed, especially in front of the cathedral of Sainte-Marie-Majeure<sup>7</sup>.

Other experiments with harbour machinery followed. In 1414, a Genoese is requested to build and test a machine to dig

out the port and reach a depth of 18 palms (4.5 m)<sup>8</sup> at the entrance and along its northern shore. In 1466 (or 1467), a document related to the dredging of the harbour contracted between the city and a private company describes the design brief ordered by the city and indicates that digging must be done by a *gaffa*<sup>9</sup>. Older documents, in 1447 and 1455, already mention such *gaffas* and link them to dredgers<sup>10</sup>. In 1481, 1485 and 1488, new city deliberations deal with building dredgers but unfortunately they do not provide new details about this<sup>11</sup>.

Considering that this set of more or less successful attempts relates only to the Late Middle Ages, it would seem wise to consider that ancient dredgers will have differed from more modern examples, which appear to be the result of this long list of experimentations.

8. AD13, 355 E 68, f° 111 r-v; Corré 2009, PJ V.18.

9. AD13, 391 E 69, f° 24-25; Corré 2009, PJ V.23. What exactly were these *gaffas* and how were they used to dig the seabed? It would be interesting to reconstruct such a harbour machine based on the different documents of the 15<sup>th</sup> century preserved in the archives.

10. AD13, 351 E 771, f° 193r-196r; Corré 2009, PJ V.21; AD13, 351 E 369, f° 100v-101r; Corré 2009, PJ V.22.

11. ACM, BB 32, f° 178-180; ACM, BB 33, f° 15v; AD13, 381 E 146, f° 245 r-v; Corré 2009, PJ V. 24 to 26.

5. AD13, B 1936, f° 82; ACM, BB 14, f° 61-62 and 88-90.

6. ACM, CC 464, p° 61, p° 73, p° 77, p° 80, p° 87; Corré 2009, PJ IV.3, IV.6, IV.9, IV.10, IV.13.

7. ACM, CC 464, p° 76 (June) and p° 88 (August); Corré 2009, PJ IV.8, IV.14.



Secondly, a boat associated with harbour dredging appears often in these texts and ought to be considered: the *caupol*, pl. *caupols*. Already mentioned in 1253 in the city laws and related to dredged material<sup>12</sup>, a *caupol* is engaged in dredging in 1333<sup>13</sup>: it gets specific carpenters in 1340<sup>14</sup> and is the topic of city deliberations in 1446 regulating the standard amount of the sludge “*caupolées*” and brought out of the port<sup>15</sup>.

Just these few references attest that in medieval Marseille boats called *caupols* were used to collect material dredged by man or machines and then to carry and dump it outside the port.

Municipal archives also hold many receipts from the beginning of the 16<sup>th</sup> century mentioning swing doors in the bottom of barges used for dredging the port<sup>16</sup>. We are very likely dealing here with the earlier *caupols* and such swing doors in the hull bottom could fully explain the existence of specific carpenters mentioned in 1340.

We shall find that such barges are known elsewhere. In Genoa, the painting by Dioniso di Martino showing the dredging of the port of Mandraccio in 1575 displays the use of boats loaded with hand-dredged material (figs 2-3) and, not far away, in Livorno, according to B. Crescentio Romano (1607, p. 544-545), there were hopper barges used at the very beginning of the 16<sup>th</sup> century.

## 5. DIGGING THE SOUTH SHORE OF THE OLD PORT (1668-1674)

After Mazarin’s death in 1661 and following Colbert’s advice, Louis XVI wanted to develop maritime trade with the eastern Mediterranean and wished consequently to exploit the port of Marseilles, which he considered underused. He assigned the two following tasks to Nicolas Arnoul: to build new city walls incorporating the port to increase the size of the town (achieved in 1666); and to dredge the south shore of this port to obtain a greater length of quays (Corré 2012).

This port extension began in 1668 and finished in 1674: the existing correspondence between Nicolas Arnoul and Colbert provides much information and detail, (Rambert 1931, p. 4, 18-19, 20bis, 22, 30, 32-33, 36-37, 39). Thus, it is possible to know, for example, that the remuneration of the dredging company depended on the number of *caupols* of a regulated capacity exiting the port for offshore dumping, and this implied a careful control of loading, movement and unloading of the *caupols* to avoid fraud. For this reason, a man standing on Le Pharo peninsula was in charge of the count and verification of the dumping in the Baie des Catalans.

In 2004 and 2005, Luc Long, curator and archaeologist with the DRASSM (*Département des Recherches Archéologiques Subaquatiques et Sous-Marines*) recorded an underwater dumping ground in this bay, revealing a remarkable stratigraphy with modern material in the upper layers and medieval and ancient remains below (Long *et al.* 2006; Long 2007). It seems therefore, as written in 1324, that there was a genuine

12. ACM, AA 1, f° 94v.

13. ACM, BB 17, f° 130r.

14. ACM, BB 19, f° 77-78.

15. ACM, BB 33A, f° 6 (May 21) and 8 r-v (July 9)

16. ACM, HH 576, p° 77, 1509; ACM, HH 576, October 4, 1510; ACM, HH 577, May 20, 1514.



Fig. 3: Barges loading hand-dredged material, detail from Dionisio di Martino, *Escavazione del fondo marino del Mandraccio nel 1575, second half of the 16<sup>th</sup> century* (N.I.M.N. 3513, courtesy Galata Museo del Mare-MuMA, Genoa).

and long tradition of dredging the port of Marseille and dumping the material in the same location which could well date back to Antiquity.

Identifying JV3, JV4 and JV5 as hopper barges was thus tempting (Corré 2009, p. 211), but this needed to be proven, and new observations of these shipwrecks with this hypothesis in mind were necessary.

## 6. MARSEILLE HISTORY MUSEUM RENOVATIONS (2010-2013)

Following renovation of the Marseilles History Museum, the event *Marseille-Provence 2013, European Capital of Culture* had a decisive effect in that it provided funding to restore the JV3 and JV4 shipwrecks, and once their fragments had been removed from their polyurethane tarpaulins in 2011, the satisfaction was double. The wood of the shipwrecks was not only relatively well preserved despite almost 20 years of storage but it also led to new observations. There were indeed two vertical cuts on one of the lateral stringers of the cavity of JV3 and they displayed remains of metal fittings (fig. 4), which according Patrice Pomey very probably bore hinges to open and close the bottom flap. Furthermore,



Fig. 4: View of one of the two vertical cuts probably made to bear the hinges of a bottom flap (photograph X. Corré).

a review of the so-called crank revealed that it could not be a gear wheel because of its asymmetry and the evidence of nails between its teeth. It should rather be identified as the vertical base of a horizontal drum made of wooden laths nailed to a couple of such bases and intended to wind the chain of the bottom flap (Pomey 2014; Corré 2016, 2018). Consequently, it is possible to affirm that these boats had a bottom door and should now be identified as hopper barges otherwise called *maries-salopes*. The two ships were restored (Bernard-Maugiron 2016) and, since summer 2013, have been exhibited in the museum, next to the 'drum base', as it is now known to be, and a model built in the Centre Camille Jullian by Robert Roman following the reconstitution suggested by Patrice Pomey (fig. 5).

## 7. CONCLUSION AND PERSPECTIVES

In the case of the three shipwrecks of Place Jules-Verne, an analysis of medieval and modern sources brought new and decisive evidence for a closer reading and reinterpretation of the shipwrecks. On a broader level this approach raises the question of the use of these hopper barges. When one considers that the inhabitants of Marseille in the Middle Ages looked to higher authority in order to finance port maintenance, and that digging works were so expensive that they were only conducted when extraordinary funding was available, as in 1408 from Pope Benedict XIII or in 1668-1674 from King Louis XIV, one might reflect upon the refurbishment work of the whole north shore of the Old Port in the 1<sup>st</sup> century AD when Marseilles was part of the Roman Empire. The use of a cofferdam to pump out the end (the 'horn') of the Lacydon Calanque, and the building of a masonry quay around 80 AD (Guéry 1992, p. 113-114), when at the same period a hopper barge is abandoned along the north shore of the port, conjures up the image of a wide-ranging project that was probably impossible for the ancient city of Marseilles to finance on its own, given that it had been divested of its treasure by Julius Caesar one century before. One can easily imagine that the works looked like Genoa's Mandraccio harbour in 1575: an enclosed area kept dry by a cofferdam, dug by manual labour (as on Trajan's column, with legionaries carrying baskets full of excavated material?) and emptied of its material thanks to a flotilla of hopper barges like JV3, JV4 and JV5, employed in round-trip voyages, loading at the cofferdam and dumping in the Baie des Catalans.



Fig. 5: Model of a Roman hopper barge (modelling R. Roman, photograph L. Damelet CNRS, CCJ).

## ACKNOWLEDGMENTS

The author expresses his warmest thanks to P. Pomey and M. Morel-Deledalle for their help to this article. We also thank Philippe Rigaut for sharing important information on the medieval sources.

## ARCHIVES

ACM: Archives Communales de Marseille  
AD13: Archives Départementales des Bouches-du-Rhône

## REFERENCES

- BERNARD-MAUGIRON H.  
2016 La restauration du chaland gallo-romain *Arles-Rhône 3* et des épaves antiques de Marseille, in K. Baslé, A. Blanchet, J.-L. Kérouanton (eds), *Musée...port(s) et mer(s), entre histoire et patrimoine. Actes des Journées d'études, Marseille 2014*, Marseille, Ville de Marseille, p. 78-81.
- CORRÉ X.  
2009 *L'activité portuaire de Marseille dans l'Antiquité. Modélisation à partir de l'analyse des sources antiques, médiévales et modernes*, PhD thesis, Aix-Marseille University, 3 vol., unpublished.  
2012 Le port de Marseille et son activité au début de l'époque Moderne (1481-1599), *Revue Marseille* 237, p. 68-72.



- 2013 Le port médiéval, in *Marseille la plus ancienne ville de France*, Archéothéma 29, p. 58.
- 2016 Marseille : un destin portuaire mis en musée, in K. Baslé, A. Blanchet, J.-L. Kérouanton (eds), *Musée...port(s) et mer(s), entre histoire et patrimoine. Actes des Journées d'études, Marseille 2014*, Marseille, Ville de Marseille, p. 13-21.
- 2018 Le complexe portuaire antique, in *L'histoire de Marseille révélée par l'archéologie*, Paris, Faton, Dossiers d'Archéologie 389, p. 32-35.
- CRESCENTIO ROMANO B.  
1607 *Nautica Mediterranea*, 1602; *Portolano della maggior parte de luoghi da stantiar navi, et galee in tutto il Mare Mediterraneo, con le sue traversie, i luoghi pericolosi*, Rome, Appresso R. Bonfadino.
- GUÉRY R.  
1992 Le port antique de Marseille, in M. Bats, G. Bertucchi, G. Congès, H. Tréziny (eds), *Marseille grecque et la Gaule, Actes du Colloque international d'Histoire et d'archéologie et du Ve Congrès archéologique de Gaule méridionale, Marseille 1990*, Lattes/Aix-en-Provence, ADAM/PUP, (Etudes Massaliètes 3), p. 109-121.
- HESNARD A.  
1995 Les ports antiques de Marseille, Place Jules-Verne, *JRA* 8, p. 65-77.  
1999 Le port, in A. Hesnard, M. Moliner, F. Conche, M. Bouiron (eds), *Parcours de villes. Marseille : 10 ans d'archéologie, 2 600 ans d'histoire*, Marseille / Aix-en-Provence, Musées de Marseille/ Edisud, p. 17-74.  
2004a Terre submergée, mer enterrée : une « géoarchéologie » du port antique de Marseille, in L. De Maria, R. Turchetti (eds), *Evolución paleoambiental de los puertos y fondeaderos antiguos en el Mediterráneo occidental, I Seminario ANSER, El Patrimonio arqueológico submarino y los puertos antiguos, Alicante 2003*, Soveria Mannelli, Rubettino, p. 3-29.  
2004b Vitruve, *De architectura*, V, 12 et le port romain de Marseille, in A. G. Zevi, R. Turchetti (eds), *Le strutture dei porti e degli approdi antichi, II Seminario ANSER, Roma-Ostia Antica 2004*, Soveria Mannelli, Rubettino, p. 175-204.
- HESNARD A., PASQUALINI M.  
1993 Port et navires romains de Marseille, *Archéologia* 290, p. 32-33.
- HESNARD A., BERNARDI P., MAUREL C.  
2011 La topographie du port de Marseille de la fondation de la cité à la fin du Moyen Age, in M. Bouiron, H. Tréziny (eds), *Marseille. Trames et paysages urbains de Gyptis au roi René, Actes du colloque international d'archéologie, Marseille 1999*, Aix-en-Provence, Centre Camille Jullian / Edisud, (Etudes Massaliètes 7), p. 159-202.
- LONG L.  
2007 Carte archéologique de l'anse des Catalans, in *Bilan Scientifique du DRASSM 2005*, Paris, Ministère de la Culture, p. 68-73.
- LONG L., DRAP P., GIUSTINIANI P.  
2006 L'anse des Catalans, *Bilan Scientifique du DRASSM 2004*, Paris, Ministère de la Culture, p. 64-68.
- MOREL M., POMEY P., HIRON X.  
2004 L'épave Jules-Verne 9 de Marseille: de la découverte à la présentation muséographique, in ARAAFU *Cahier technique* 13, p. 43-48.
- MOREL-DELEDALLE M.  
1999 Marseille, 150 années de découvertes et de conservation de bois gorgés d'eau de grandes dimensions, in C. Bonnot-Diconne, X. Hiron, Q. K. Tran, P. Hoffmann (eds.), *Proceedings of the 7th ICOM-CC Working Group on Wet Organic Archaeological Materials Conference, Grenoble 1998*, Grenoble, ARC-Nucléart CEA, p. 40-44.
- PERNOUD R.  
1949 Le Moyen Age jusqu'en 1291, in G. Rambert (ed.) *Histoire du Commerce de Marseille*, t. 1, Paris, Plon, p. 107-382.
- POMEY P.  
1993 Les épaves romaines et grecques, in M. Morel-Deledalle (ed.), *Le temps des découvertes. Marseille, de Protis à la reine Jeanne*, Marseille, Musées de Marseille, p. 59-62.  
1995 Les épaves grecques et romaines de la place Jules-Verne à Marseille, *CRAI*, p. 459-482.  
1999 Les épaves romaines de la place Jules-Verne à Marseille : des bateaux dragues ?, in H. Tzalas (ed.), *Tropis V, Proceedings of the 5th International Symposium on Ship Construction in Antiquity, Nauplia 1993*, Athens, Hellenic Institute for the Preservation of Nautical Tradition, p. 321-328.  
2005 Les épaves romaines, in M.-P. Rothé, H. Tréziny (ed.), *Marseille et ses alentours*, Paris, Académie des Inscriptions et Belles-Lettres, (Carte archéologique de la Gaule 13.3).  
2014 L'entretien des ports antiques. Les chalands à clapet de Marseille, in P. Pomey (ed.), *Ports et navires dans l'Antiquité et à l'époque byzantine*, Paris, Faton, *Dossiers d'Archéologie* 364, p. 62-63.
- POMEY P., HESNARD A.  
1994 Les épaves romaines et grecques, *Bilan Scientifique SRA-PACA 1993*, Paris, Ministère de la Culture, p. 112-115.
- RAMBERT G.  
1931 *Nicolas Arnoul, intendant des galères à Marseille (1665-1674) : ses lettres et mémoires relatifs à l'agrandissement de la ville et à l'entretien du port*, Marseille, Provincia.

# THE COSSACK BOAT OF 1737 AS AN EXAMPLE OF SHIPBUILDING IN THE FIRST HALF OF THE 18<sup>TH</sup> CENTURY

Dimitri KOBALIIA and Ksenia YERMOLAIEVA

---

## Abstract

The article is devoted to a 'new style' Cossack boat. It was investigated and raised near Khortytsia Island, Ukraine, in 1999. Such vessels were part of the Dnieper rowing flotilla in 1737-1739. The Cossack boats were armed with four falconets and could both be rowed and sailed. The interior space consisted of five zones: a fore-deck, two rowing sections, a cargo section and a poop deck. The boat is carvel planked with oak framing of futtocks and floor timbers, a mast step, four swivel-gun stands, a keelson and a number of partitions. The planking and the knees were made of pine.

## Keywords

Boat, Cossack shipbuilding, Dnieper flotilla, Russo-Turkish wars

## Résumé

L'article est consacré à un bateau cosaque d'un type nouveau. Il a été étudié puis renfloué près de l'île de Khortytsia, en Ukraine, en 1999. Ces navires faisaient partie de la flottille à rames du Dniepr en 1737-1739. Les bateaux cosaques étaient armés de quatre fauconneaux et pouvaient évoluer à la rame et sous voile. L'espace intérieur se composait de cinq zones: un pont avant, deux sections d'aviron, un espace de cargaison et un pont de poupe. Le bateau est bordé à franc-bord avec une membrure composée de varangues et allonges, en chêne, un massif d'emplanture, quatre pierriers, une carlingue et plusieurs cloisons. Le bordé ainsi que les genoux ont été réalisés en pin.

## Mots clés

Bateau, construction navale cosaque, flottille du Dniepr, guerres russo-turques

---

The new type of Cossack boat of 1736 was found near Khortytsia Island, Ukraine, in 1999. This boat, like no other found in the Dnieper River, is interesting from the point of view of the correlation of shipbuilding traditions in Ukraine and in Europe. Unlike riverine merchant shipping on the Dnieper, dominated for almost 200 years by well-known but at the same time archaic principles of construction widely used in medieval Europe, military shipbuilding of the first half of the 18<sup>th</sup> century underwent significant transformations. This occurred in the context of the formation of the Russian Imperial fleet and the desire to expand south. It was a time of intense search for optimal proportions adapted to local conditions for military operations. By the 1730s, Saint Petersburg was no longer satisfied with the simple use of Cossack boats and even blindly copying them. The scale of construction required the introduction of new technological methods and their standardisation (Kobaliia 2016).

Even a cursory glance at the documents preceding the Russo-Turkish war of 1736-1739 makes it possible to characterise this period as one of chaos and brainstorming. What to build, whom to follow – Dutch, French or British shipbuilders? In a certain sense, this was a time of tough competition among European shipbuilding schools and local shipbuilding traditions: our boat is a good illustration of this.

In 1736, after consulting with Zaporijjia Cossacks, Field Marshal von Münnich made a preliminary sketch and suggested building boats in the manner of the Zaporijjia *doub* (oak-tree boat) or the Turkish *scher* boat. The main thing that interested

the army commander was the draught (Кобалия, Нефедов 2005). The boats were required to clear the rapids of the Dnieper River, but at the same time to have powerful artillery. Von Münnich even anticipated Chapman's cannon yawls (the Swedish shipwright was 15 years old at the time), but the idea was not implemented and the regimental cannon were replaced with falconets. In a sense, the situation was similar to the beginning of the Anglo-Dutch wars of the 17<sup>th</sup> century, when the Dutch built relatively small-sized ships with shallow draught. As a result, the mass construction of James Brown's double-chaloupes and Andrei Alatchenin's new type of Cossack boats took place. During the first years of the war, more than 500 units were built.

## 1. HISTORY OF THE FIND

One of these boats was found in 1998 near Khortytsia Island in southeast Ukraine. For two years it was investigated by archaeologists of the Khortytsia National Reserve. In that period the boat was dated. In September 1999 the hull was raised (Кобалия, Нефедов 2002).

The vessel was constantly sprayed with water to prevent uncontrolled drying, and in October 1999 the conservation process began. Until July 2000 this was conducted in the open air, then the vessel was placed in a specially constructed hangar (fig. 1). Despite the extreme conditions of this period, the find



Fig. 1: View of the Cossack boat of 1737 (photograph D. Smolienko).

was kept in quite a good state of preservation, but it was not possible to completely avoid some shrinkage. By 2002, the state of the wood had been stabilised. The wood was impregnated with PEG 400 and PEG 1500, and since 2003 with PEG 4000. At the same time, the hull was repositioned on a stationary cradle. In August 2003, the boat sat on its keel for the first time in 270 years. Since 1999, it had been suspended on rubber slings from a crossbeam in the hanger.

## 2. STATE OF THE HULL

At the time of discovery, up to 60% of the hull survived though less than half of the starboard side is preserved. The bow part, except the forefoot, is completely lost. The starboard stanchions, the thwarts, as well as the fore starboard swivel gun mount were missing. While under water, the starboard, protruding from the bottom, was destroyed by the current of the river. The process of destruction was apparently rather gradual, as indicated by the smooth curved edge of the destroyed part. For some time the bow of the vessel protruded above the shallow water and was dismantled, the traces of an axe are clearly visible on the lower part of the stem.

The frames are in a poor state of preservation. On the starboard side, they survive only to the wrongheads; on the portside, many of the futtocks are cracked and with fissures, but are in place and retain the integrity of the vessel. It is clear that after raising, none of them could withstand any load, including their own weight.

One more problem was the change of the centre of gravity of the hull. The lack of some parts of the boat together with the lack of interconnection between separate elements led to a redistribution of load and deformation. For example, a major deformation was detected in the bow part, where the shift in weight had caused a twist to the left.

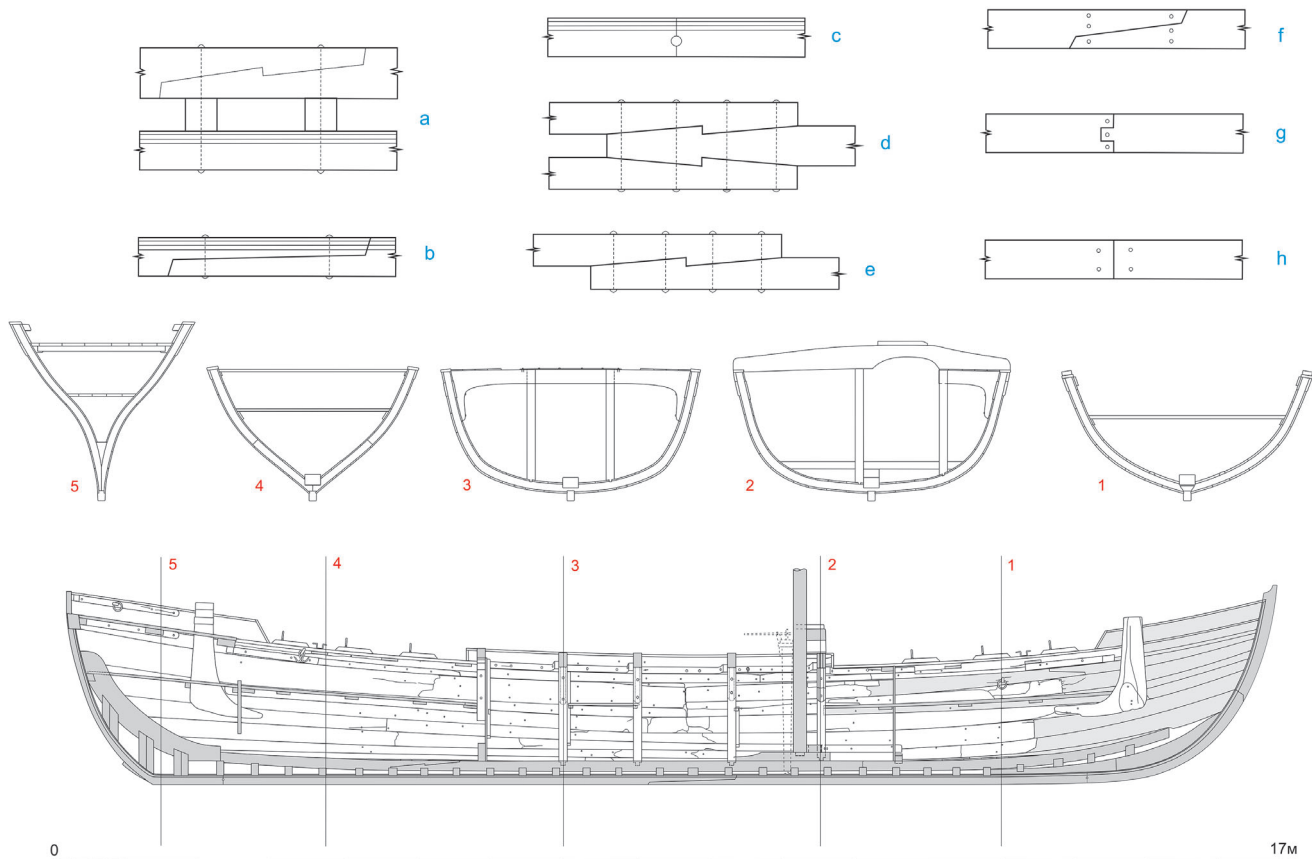
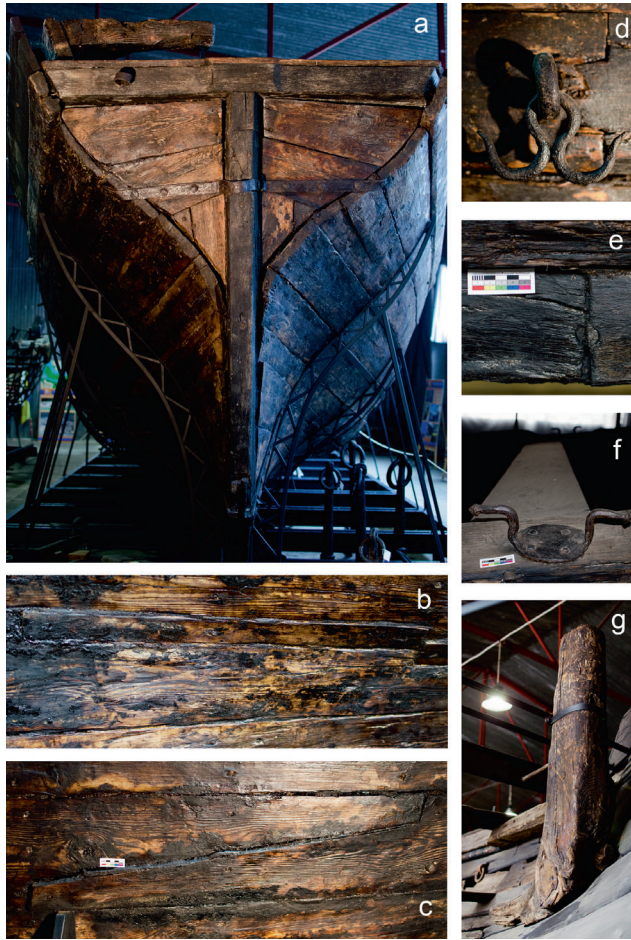


Fig. 2: The design of the boat: a) keelson scarf; b) keel scarf; c) butt joint of the keel with the bow and the sternpost; d) midsection scarf; e) frame scarf; f) planking ribbed scarf; g) sheer strake scarf; h) ceiling scarf. From a to h not in scale (drawings D. Koballia)





**Fig. 3:** Construction details: a) transom of the boat; b) stealers; c) nibbed scarf of the planking; d) sheer strake scarf; e) butt joint of the keel; f) iron cleat; g) swivel gun mount of the bow section (photographs D. Smolienko, K. Yermolaieva).

### 3. HULL DESIGN AND GENERAL SPECIFICATIONS

The keel consists of two timbers and has a straightforward horizontal flat scarf (fig. 2b). That is, in general, characteristic of many sailing vessels of the end of the 17<sup>th</sup> to the beginning of the 18<sup>th</sup> centuries. We see similar scarfs on *La Belle* of 1684 (Boudriot 2000, p. 67), *La Renommée* of 1744 (Boudriot 1993a, p. 33) and *Le Mercure* (Boudriot 1991, p. 35). A butt joint is used to connect the keel to the forefoot and the sternpost (figs 2c and 3e). The keel has a rabbet in the upper part along its entire length. The entire longitudinal construction ('backbone') of the stem, the keel and the sternpost is made of oak.

The stem, which consists of two parts, is curved and raked forward. The rabbet continues without major changes to the place of the break.

The sternpost, both in form and in design, slightly differs from the stem. It is a curved timber raking aft.

The vessel has 30 frames. In the central part of the hull, they consist of oak floor timbers with triangular limber holes cut in them, and pine futtocks. The midships floor timber has futtocks attached to both the fore and the aft faces (fig. 2d). The closest

variant of the junction between floor timbers and futtocks can be seen on the Kitten shipwreck, explored near the Bulgarian coast in 2000-2003. The design of the midships frame also finds its parallels here (Batchvarov 2014). The average spacing is 45 cm (centre to centre). From above, the floor timbers are locked in place by the keelson. All the units (keel, floor timbers, keelson) were fastened with bolts and long-shanked nails.

It is noteworthy that the frames are numbered. Each floor timber was marked with a neatly carved Arabic numeral. The numbering started from the bow and stern tail frames at number 1 and reached the midsection, which was number 10.

All frames were preassembled, as evidenced by the horizontal nails fastening futtocks to floor timbers (fig. 2e). Numbering of the frames, as well as their assembly, was carried out prior to installation on the keel. This is indicated by the location of the marks: from the bow to the midsection on the portside and from the stern to the midsection on the starboard. In the central part of each floor timber there are three vertical notches, of which the central one represents the diametrical plane, and the outer ones correspond to the lateral edges of the keel. Adjacent to the central notch is a semicircle located on the right. Numbering is also found on some futtocks, however, it has no system. At the same time, on a number of futtocks, in addition to numbers, surmarks were also preserved. It is probable that during the construction of the ship, moulds for other vessels were used, which can be confirmed by data found in written sources.

In the stern part of the vessel there are three crutches, held by the knee of the sternpost. The stern deadwood consists of a timber located between the keel and the keelson.

The keelson consists of two timbers, jointed with a hook scarf (fig. 2a). The junction of the parts with the hook scarf is located between the first and third floor timbers from the stern side. The shape of the keelson scarf is similar to what we see on Captain Cook's *Endeavour*, built in 1764 (Marquard 2001, p. 48), as well as on other ships, such as the bomb vessel *Granado* of 1742 (Goodwin 1989, p. 45) and *La Renommée* of 1744 (Boudriot 1993b, p. 114). In the bow it presses the frames directly onto the deadwood.

The stern of the vessel has a flat, nearly triangular transom, framed by the fashion pieces and the wing transom (fig. 3a). The space between them is covered with two longitudinal and one transverse row of planks. On the sternpost, the pintle and the gudgeon are preserved. On the wing transom to the portside a flagpole ring is installed. The plane of the transom rakes aft 75 degrees: the transom itself consists of two planes converging on the stern.

The ship is carvel-built. All planks are made of pine. The width of the planks reaches 35 cm, and the length up to 6 m. The thickness of the planking is 4 cm. The ends are fastened with nibbed scarfs (figs 2f and 3c). That, in turn, has lots of parallels in European shipbuilding: *La Belle* of 1684, *Le Fleuron* of 1729, and also the Dutch Indiaman found at Cape Town in 1971, the Dutch East Indiaman *Batavia* of 1629 sunk on the west coast of Australia. The boat had a sheer strake, to which the hook bolts were attached. The scarf on the sheer strake was of a different shape (figs 2g and 3d).

The ceiling planking had a clamp and a footwaling consisting of a triple row of planks with inserts in the stern part.

Two transverse beams situated in the stern, together with the wing transom, served as a support for the deck. The arched mast partner beam was situated above the seventh floor timber counting from the bow and served to support the trunk of the



mast. It was attached to the sides of the vessel with two hanging knees located beneath it. An additional beam separated the central part of the vessel from the aft rowing section. It is also fixed by two hanging knees. A rectangular ring is attached to the beam above the keelson.

In addition to the knee of the sternpost and the false stem knee, there are 32 units. Perhaps there were even more. Of these, six were lodging knees. At least two more knees were located in the bow. The central cargo hold of the ship was of increased strength. Here, along the side was located the top row of lodging knees, five on each side. They joined the clamp with the planking and five deck beams. The hanging knees of the middle part of the vessel were additionally joined with stanchions tenoned along the hull. Each stanchion was attached to the side by a horizontal bar, embedded in the middle part of it. All the knees are made of coniferous trees and fixed to the frames with iron bolts.

The deck is fully preserved in the stern. The deck planking is longitudinally oriented. The seams between the planks are caulked and payed with tar. The entire outer planking of the hull is caulked in a similar way.

Due to the serious destruction of the bow, we do not have any parts of the bow bulwarks. However, 18<sup>th</sup> century drawings give us an idea of its design, which apparently did not differ much from the stern.

The mast was positioned forward of midships. The rectangular tenon of the mast heel lies in a mortise in the oak mast

step, which is fastened with bolts and nails to the keelson. Forward of the mast, a beam braces the mast step and is jointed to the frames. At the height of the deck, the mast is supported by a beam that served as mast partners. The mast and the beam were joined by a lodging knee. (Кобалія, Нефедов 2005).

#### 4. THE INNER SPACE OF THE BOAT

The inner space can be divided into five zones.

1) The stern cabin or *cherdack* is a small room located under the aft deck. The cabin furniture consists of a small sleeping platform, the narrow side of which lies on the sternpost knee and the wider side on two transversal beams. The cabin is separated by a wooden bulkhead made of one plank. On the after deck there are two swivel gun mounts made of pine trunks with preserved rootstock (fig. 3 g). They are oval in cross section, cut through the after deck and overhang the bulwark. The mounts had a round hole on the top with an iron tube and square fitting for the installation of a falconet. The upper part is additionally reinforced with two iron pipe holders.

2) The rowing section in the stern consisted of three rowing thwarts with thole boards fastened on the planksheer. The thwarts were positioned at the level of the planksheer. An iron cleat is installed between the last two thole boards (fig. 3f). Under the thwarts there was a locker.

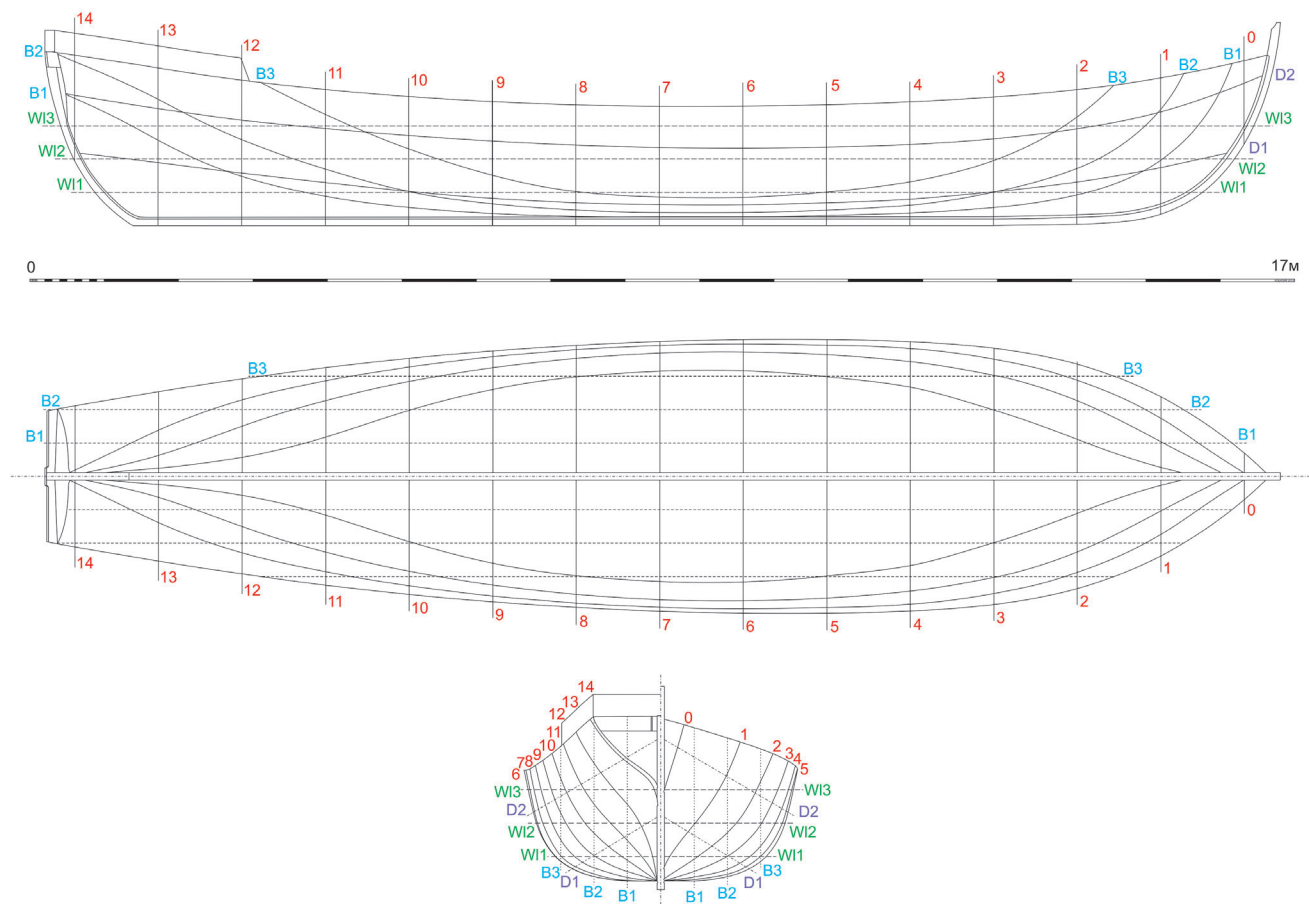


Fig. 4: The theoretical lines of the Cossack boat (drawing D. Kobaliia).

3) The cargo section in the central part of the vessel has a side board that is one strake higher. The preserved planksheer has no traces of thole boards, therefore, the section was not intended for rowing. During the excavations, a ship pump was found on the portside, near the mast. The pump is wooden, round in section, tapering from top to bottom. The purpose of the other wooden structures of the section is not fully understood.

4) The thwarts and the thole boards of the bow rowing section were not preserved, therefore the only evidence in favour of assuming that there was a bow rowing section is a fragment of the riser along the portside. The plank is fastened from the inside of the portside at the height of the top timbers: it had cut-outs for fastening the thwarts. For the rest, there are no construction differences between the second and fourth sections.

5) Damage to the bow means that this section is the least informative for the moment. Its appearance can be reconstructed from 18<sup>th</sup> century drawings. It is known that the bow section was used to carry the artillery. Here, along the portside, another gun mount, similar to the stern one, was found. At the time of research, all the iron fittings were removed from it. There is a small square mortise for a stanchion in the keelson above the bow deadwood.

In addition to clench and forelock bolts, 19 types of nails were recorded.

## 5. CONCLUSIONS

Summing up, I would like to underline that this vessel is a unique source for the study of military shipbuilding of the 18<sup>th</sup> century, a source that embodied the needs of those times and the particularities of various shipbuilding schools. This boat was a compromise between the tasks set for the flotilla and the conditions in which she came into the world.

Despite many analogies of its constructive elements in European shipbuilding of the end of the 17<sup>th</sup> to the beginning of the 18<sup>th</sup> centuries, we insist that the vessel is closer to Mediterranean traditions, particularly, galley-building traditions (fig. 4). This can be proved by the following features: the relative narrowness of the bow, double guy hooks widely used on galleys, the high position of the thwarts, almost at the planksheer level, and a characteristic rounded sternpost with a long pintle, which, according to K. Batchvarov, is “typical for vessels with sharp sterns and curved sternposts, similar to the 16<sup>th</sup> century Ottoman wreck from Yassiada”. He also underlines that “this type of stern was popular among traditional lateen-rigged craft in the Mediterranean world until the 19<sup>th</sup> century, if not later”. (Batchvarov 2014, p. 4).

## REFERENCES

- BATCHVAROV K.  
2014 The Hull Remains of a Post Medieval Black Sea Merchantman from Kitten, Bulgaria, *IJNA* 43.2, p. 1-16.
- BOUDRIOT J.  
1991 «*Le Mercure*», *Navire marchand, 1730*, Paris, Ed. J. Boudriot.  
1993a «*La Renommée*», *frégate de VIII, 1744*, Paris, Ed. J. Boudriot.  
1993b *The history of the French frigate, 1650-1850*, Rotherfield, Jean Boudriot Publications.  
2000 «*La Belle*» 1684, Paris, Ed. J. Boudriot.
- GOODWIN P.  
1989 *The bomb vessel Granado, 1742*, London, Conway Maritime Press.
- КОБАЛИЯ Д.  
2016 Political prerequisites of Dniro flit generation, in *History on frames. Ancient boats restoration project*, Запоріжжя (Zarogozhye), Дике поле, p. 8-15.
- КОБАЛИЯ Д., НЕФЕДОВ В.  
2002 Методика исследований и организация подъема казачьей лодки 1738 г., in *Подводная археология: сто лет исследований. Материалы международной научно-практической конференции «К столетию подводной археологии» 6-8 февраля 2002 г., Москва (Moscow)*, p. 66-74.  
2005 «Запорозька чайка» Історія однієї знахідки, Запоріжжя (Zarogozhye), Дике поле.
- MARQUARDT K. H.  
2001 *Captain Cook's Endeavour*, London, Conway Maritime Press.



# THE KORSHAMN WRECK: PRELIMINARY INVESTIGATIONS OF A NORDIC CLINKER-CARVEL ‘HYBRID’ FROM THE LATE 12<sup>TH</sup> CENTURY, AND SOME THOUGHTS ON MEDIEVAL CARGO HANDLING

Staffan von Arbin

---

## Abstract

During 2016, several undocumented shipwreck sites were exposed on the sandy shores of Halland, western Sweden. One of the most interesting finds is situated in the shallow bay of Korshamn, close to the medieval town of Falkenberg. A limited test excavation revealed a clinker-built vessel over 13 m long. Dendrochronological analysis suggests that the vessel was built shortly after 1168 from Scandinavian wood. Even though it clearly conforms to contemporaneous Scandinavian ship building practices, there are certain features that appear highly unusual. This paper presents the preliminary results of the excavation. In addition, the *kar* phenomenon of southern Scandinavia is briefly discussed.

## Keywords

Cargo handling, carvel, clinker, Middle Ages, Scandinavia

## Résumé

En 2016, plusieurs sites d'épaves non documentés ont été mis au jour sur les rives sablonneuses de Halland, dans l'ouest de la Suède. L'une des découvertes les plus intéressantes est située dans la baie peu profonde de Korshamn, à proximité de la ville médiévale de Falkenberg. Un sondage limité a révélé un navire construit à clin de plus de 13 m de long. L'analyse dendrochronologique suggère que le navire a été construit peu après 1168 à partir de bois scandinave. Même s'il est clairement conforme aux pratiques de construction navale scandinaves contemporaines, certaines caractéristiques semblent très inhabituelles. Cet article présente les résultats préliminaires de la fouille. En outre, le phénomène du *kar* propre au sud de la Scandinavie est aussi brièvement abordé.

## Mots-clés

Manutention des marchandises, carvel, clin, Moyen Âge, Scandinavie

---

For the County Administrative Board of Halland, south-western Sweden, the year 2016 was an unusually busy one in regards to maritime archaeology. In the course of the year, several previously unknown shipwreck sites were reported to the authority. The main reason behind these new discoveries is coastal erosion, a serious problem for the region, which will certainly increase in years to come due to global warming (von Arbin 2017a).

The most interesting of these newly discovered sites is located in the nature reserve of Morups Tånge, 8 km northwest of the medieval town of Falkenberg. The stony spit of Morups Tånge is demarcated by two shallow bays, Brevik to the north and Korshamn to the south. The shipwreck discussed here is located in the latter. It is buried in fine sand in ankle-deep water, approximately 50 m from land.

In this paper, some preliminary findings regarding the Korshamn wreck are presented. Moreover, based on place names, written sources and archaeological observations, it will be argued that the vessel was abandoned in a contemporaneous harbour. Furthermore, based on the presumed harbour remains observed in the area, cargo-handling procedures during the Middle Ages will be briefly discussed:

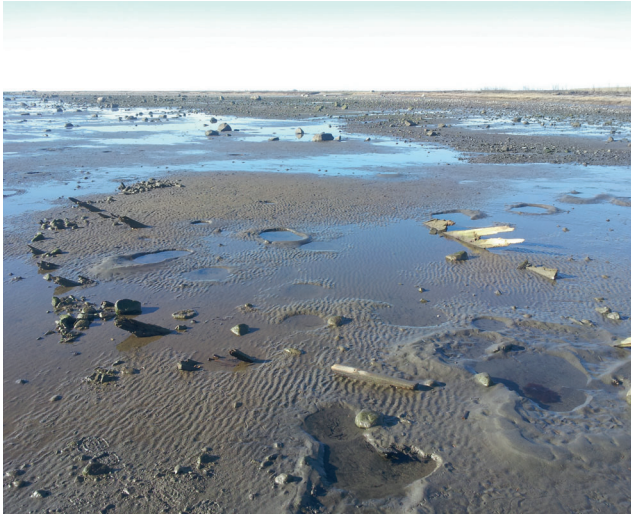
in particular the *kar* phenomenon of southern Scandinavia will be addressed.

## 1. DISCOVERY, DATING AND PRELIMINARY INVESTIGATION

The Korshamn wreck was discovered in March 2016 by a birdwatcher who noticed ship timbers protruding above the sand during low tide (fig. 1). Morups Tånge is one of the most popular birdwatching sites in Sweden. The wreck is therefore likely to have been recently exposed prior to its discovery. A general inspection of the site was conducted by the author and colleagues a couple of weeks after its discovery. Site inspection also included sampling for dendrochronological analysis.

Unfortunately, initial dendrochronological dating of samples proved unsuccessful (Daly 2016). Therefore, so-called <sup>14</sup>C wiggle matching was performed on one of the samples. The method comprises <sup>14</sup>C dating two or more annual growth rings in a single sample. Since the exact intervals between





**Fig. 1:** Photo of the wreck site in April 2016 (photograph S. von Arbin, Bohusläns museum).

the analysed rings are known, it is often possible to narrow the calibration range of the  $^{14}\text{C}$  dates considerably (see e.g. Blauw *et al.* 2004).

The result, although somewhat inconclusive, indicated a date after *circa* 1026–1147 (Daly 2016). This also conformed to archaeological observations made during inspection. Further dendrochronological sampling and investigation was thus considered essential and additional fieldwork was conducted in October 2016 (von Arbin 2017b). In order to access the hull for wood sampling and documentation, a trench approximately 4 m long and 2 m wide was dug in what appeared likely to be the bow section of the vessel. Fortunately, the water level was lower than usual during the five-day investigation, which allowed the work to be carried out in a semi-dry environment.

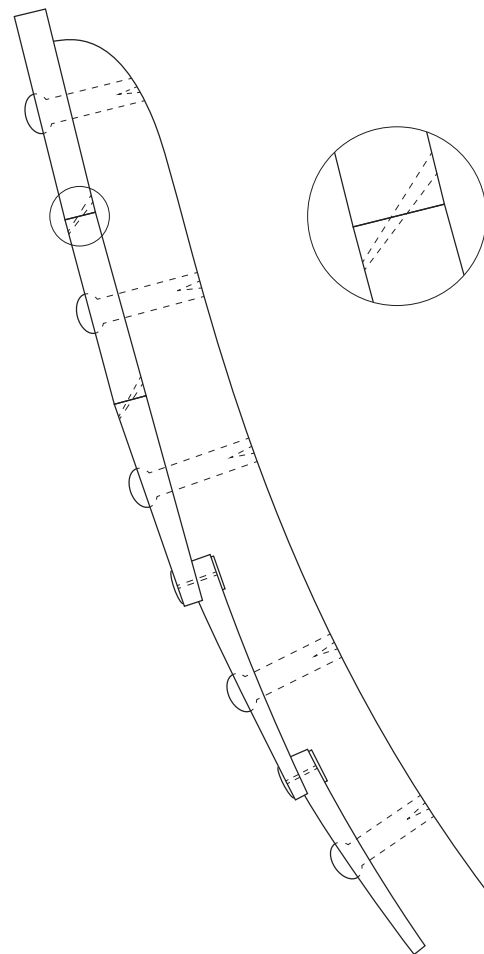
An additional three samples were submitted for dendrochronological analysis, of which two were dated to after 1162 and 1168 respectively. Based on the newly acquired results, the previously analysed samples were re-examined. Eventually another two samples were dated, one of which dates to after 1034 and the other to after 1167 (Daly, Nielsen 2016). If the dendrochronological results are combined, it seems likely that the vessel was built relatively soon after 1168, and most probably before the turn of the 12<sup>th</sup> century. Since the analysed wood consists of Scandinavian pine, its construction is likely to have taken place within Scandinavia.

## 2. THE SHIPWRECK

The limited investigation revealed a lapstrake hull with a preserved length of 12.5 m and a beam of 3.5 m. The vessel lies tilted towards its presumed starboard side, which has therefore largely survived. The port side, on the other hand, is much less preserved. Orientation of the hull indicates that the keel and keelson, possibly also stem and sternpost, are still preserved in the sand. Floor timbers, futtocks, and lower strakes seem to be made of oak, whereas the upper part of the planking is made of pine. A small stringer on the starboard side proved to be of oak, while a more massive one on the starboard side is made of spruce.

Two levels of cross beams were recorded. The lowest one consists of so-called *bitis* that rest on the upper faces of the floor timbers. *Bitis* have arch-shaped undersides. On top of the beams at either end are standing knees that are fastened with treenails to the hull. Beams and knees seem to be made of pine. This type of assemblage is typical of Scandinavian shipbuilding up to the end of the 12<sup>th</sup> century. Other recorded features that are highly indicative of contemporaneous Scandinavian shipbuilding are tangentially split planks, decorative plank mouldings, planks with short diagonal scarf joints, clenched iron nails with rounded shafts, and wool luting (Bill 1997, p. 133-143).

The upper section of the presumed starboard side displays a curious transition from lapstrake to carvel planking (fig. 2). The flush-laid strakes, of which there were at least three, are fastened to each other in an even more peculiar way: small treenails have been driven sidelong, through pre-drilled conical holes in the lower edge of the upper plank and the upper edge of the underlying plank. Possibly, this planking constitutes some kind of bulwark, which has prevented the cargo from being sprayed with seawater. To the author's knowledge, there are no contemporaneous parallels to this design. A reason for this could of course be that there are few well-preserved surviving shipwrecks from the 12<sup>th</sup> and 13<sup>th</sup> centuries similar to the



**Fig. 2:** Sketch showing the transition from lapstrake to carvel, and the fastening method used between the flush-laid planks (drawing A. Gutehall).

Korshamn wreck: the number of recorded shipwrecks from this period is still not very large.

Artefacts found during excavation were few. Finds consisted mainly of a small number of animal bones, mainly from sheep, and some well-preserved rope fragments made from linden bast. The bones are likely to derive from provisions carried on board. The thickest rope, which has a diameter of approximately 8 cm, may have served as the vessel's anchor cable, while the thinner ropes are likely to be rigging. Excavated organic materials are in an extraordinary state of preservation, proving that conditions in the sand are very favourable for these materials.

In summary, the overall construction of the Korshamn wreck clearly conforms to contemporaneous Scandinavian ship building practices. At the same time, the vessel also displays features that appear highly unusual in this context. Preliminary investigation suggests that the vessel had an original length of 13-14 m or more. Contemporaneous Scandinavian ship finds of comparable size include Roskilde 2 and the Eltang and Ellingå ships from Denmark, the vessel from Möveninsel in Schleswig, Germany, and Galtabäck I and II from Sweden (Enqvist 1929; Björck 2005; Englert 2015, p. 325, 237). Interestingly enough, the latter two were located slightly more than 10 km further north along the coast.

### 3. THE SETTING

The navigational importance of Morups Tånge and its immediate surroundings in historical times is clearly evidenced in both written and archaeological sources. The spit, considered a hazard to seafarers, is marked in some of the earliest sea charts, dating to the 16<sup>th</sup> century. Due to the high number of foundered vessels in the area, a lighthouse was eventually constructed in the 1840s (Bengtsson 1979, appx. 6). North of Morups Tånge is the so-called Glumstenen, or Glumstenen, a large boulder that for many centuries served as a natural navigation aid. According to Icelandic sagas, the flotilla of the Norwegian king Harald Hadrada anchored at 'Glummstein' in the beginning of the 1060s (Schöldström 1881). Less than 200 years later, the flotilla of another Norwegian king, Haakon Haakonson, is said to have halted there (Storm, Bugge 1914, p. 249-250).

Historically, there would have been two main options for harbouring ships in the area: the two bays of Brevik and Korshamn. Ship timbers of unknown date found east of Brevik, in what is now dry land, imply that the bay once reached further inland and that it actually may have served as a harbour. In the case of Korshamn (fig. 3), which literally means 'cross harbour', the place name itself provides an important clue to its former function (Westerdahl 1989, p. 169; Connellid, Ahnlund 2012, p. 207). In a maritime context, *kors*+noun may denote a place where a cross-shaped seamark was erected during the Middle Ages. The name Korshamn is known from several locations in Scandinavia, some of which have actually been proven as medieval harbour locations (Westerdahl 1989, p. 167-171).

From a topographical viewpoint, the bay probably offered excellent harbour opportunities before it silted up and became too shallow for larger vessels to approach. During the investigation, structures, which possibly constitute the foundations of



Fig. 3: Extract from a 1778 map in the Swedish Land Survey Board archive (LMS) showing the locations of Korshamn and Karet.

houses or sheds, were observed on land. At the waterfront, large stone structures, which may be the remains of jetties and piers, were also recorded. Of particular interest in this connection is a large accumulation of stones and rocks, known as *Karet*, located outside the entrance to the bay. In modern Swedish, *kar* is another word for stone caissons used as foundations for jetties, bridges or similar. Whether this massive stone assembly, which measures approximately 150 x 50 m, constitutes a natural formation, or if it is fully or partially fabricated, remains an open question.

### 4. THE KAR PHENOMENON AND EARLY STATE FORMATION

Large *kar* structures have, however, been recorded at several locations in southern Sweden (fig. 4). Unfortunately, few of them have been thoroughly investigated. The most renowned is the so-called *Lödde kar*, located in Öresund outside Löddeköpinge in southwestern Scania. It is semicircular in shape with an overall length of 160 m. Carbon-14 analysis of worked timber found within the structure dates its construction to the 10<sup>th</sup> or 11<sup>th</sup> century. In the beginning of the 13<sup>th</sup> century it is mentioned as "*kar iuxta ludde*", that is, "the *kar* close to Lödde". In later sources, it is evident that it was of continuing importance during the ensuing centuries (Lindqvist 1981).

Other possible medieval *kars* are known from Åhus (*Norra karet*, *Östra karet* and *Södra karet*), Kivik (*Gula kar* and *Stora kar*), and Simrishamn (*Karet*) (Hansen 1989, p. 7). Based on written sources, it is also known that the medieval town Malmö used to have three *kars*, named *Kon*, *Blidan* and *Kalven* (lit. The Cow, The Trebuchet and The Calf). Like *Lödde kar*, they were apparently in use for a long period of time (Rosborn 2015, p. 257). Another large *kar*-like structure has been recorded

at Bossholmen, north of Oskarshamn. It was found in conjunction with the wreck of a late 13<sup>th</sup> century cog, the so-called Bossholmen or Oskarshamn cog. Geological expertise has concluded that it is a natural formation, which at some point was remodelled (Cederlund 1989, p. 33). Finally, there is a possible *kar* near the mouth of the Øle Å river on the Danish island of Bornholm, indicated by the place name *Ølekarret* (Crumlin-Pedersen 1985, p. 75-76).

Despite limited knowledge regarding the southern Scandinavian *kar* phenomenon, some general observations can be made. First, *kars* often seem to occur in shallow and exposed coastal areas that lack proper natural harbours. Secondly, they often seem to have a geographical connection with early trading centres, or, at the very least, areas with a rich hinterland. Thus, they should in most cases probably be interpreted as wharfs, places for the transhipment of goods. *Kars* are generally very large structures and the resources used in their construction must have been considerable, even if natural formations often seem to have served as their foundation. Interestingly, their construction seems to have occurred during a relatively short period in history, roughly speaking the 11<sup>th</sup>-12<sup>th</sup> centuries. What is also interesting is that the phenomenon often appears to be restricted to areas that were under Danish supremacy in this period.

Based on these preliminary findings it is very tempting to explain the *kar* phenomenon as the result of a conscious and co-ordinated strategy of a central power. Could it be that the building of *kars* during this period was directed by the Danish kings, as a means to gain control of their geographically divided territory and to exploit local resources? In order to prove such a hypothesis, however, further archaeological investigations are required. A desirable first step would be a detailed survey of Korshamn and its surroundings, including the presumed *kar* structure outside the bay. Considering this, further excavation of the Korshamn wreck is of course also high on the wish list.

## ACKNOWLEDGEMENTS

The author would like to thank Thomas Bergstrand, Matthew Gainsford and Anders Gutehall, who participated in fieldwork during April and October 2016. Thank you also to Jan Bill, Niklas Eriksson and Fred Hocker, for invaluable input on medieval, and particularly Scandinavian, ship construction. The English was kindly revised by Matthew Gainsford.



Fig. 4: Scandinavian *kar* structures mentioned in the text (map A. Gutehall).

## REFERENCES

- ARBIN VON S.  
 2017a Sandvandring blottade skeppsvrak, in *Arvet till framtiden. Årsredogörelse från kulturmiljöfunktionen 2016*, Halmstad, Länsstyrelsen i Hallands län, p. 11-16.  
 2017b *En tidigmedeltida fartygslämning vid Morups tånge. Arkeologisk förundersökning. Morups socken*, Falkenbergs kommun, Halland, Uddevalla, Bohusläns museum, Rapport 2017:19.
- BENGTSSON S.  
 1979 *Skötselplan för Morups tånge naturreservat*, Halmstad, Länsstyrelsen i Hallands län.
- BILL J.  
 1997 *Small scale seafaring in Danish waters AD 1000-1600*, PhD thesis, University of Copenhagen, Institute of Archaeology and Ethnology.
- BJÖRCK N. (ED.)  
 2005 *Arkeologisk undersökning av skeppsvrak vid Galtabäck (RAÄ 5; Galtabäck II), Tvååkers sn, Varbergs kommun, Halland, Flemingsberg, Södertörns högskola*.
- BLAAUW M., VAN GEEL B., MAUQUOY D., VAN DER PLICHT, J.  
 2004 Carbon-14 wiggle-match dating of peat deposits: advantages and limitations, *Journal of Quaternary Science* 19.2, p. 177-181.
- CEDERLUND C. O.  
 1989 Låg Oskarshamnskoggen i en medeltida storhamn?, *Populär Arkeologi* 4, p. 33-34.
- CONNELID P., AHNLUND B.  
 2012 *Kulturmiljöprogram för Falkenbergs kommun*, Falkenberg.
- CRUMLIN-PEDERSEN O.  
 1985 Havne og søfart i romersk og germansk jernalder, in H. Thrane (ed.), *Gudmeproblemer. Beretning fra et bebyggelsesarkæologisk symposium på Hollufgård afholdt den 24.-25. oktober 1984*, Odense, Odense universitet, Skrifter fra historisk institut 33, p. 68-91.
- DALY A.  
 2016 *Dating analysis of timbers from a ship found at Korshamn, Falkenbergs kommun, Halland, Sweden*, Copenhagen, dendro.dk. report 2016:38.
- DALY A., NIELSEN J.  
 2016 *Dendrochronological analysis of timbers from a boat found at Korshamn, Falkenbergs kommun, Halland, Sweden*, Copenhagen, dendro.dk. report 2016:69.
- ENGLERT A.  
 2015 *Large cargo ships in Danish waters 1000-1250. Evidence of specialised merchant seafaring prior to the Hanseatic period*, Roskilde, Viking Ship Museum, Ships and Boats of the North 7.
- ENQVIST A.  
 1929 *Skeppsfyndet vid Galtabäck. Preliminär redogörelse för undersökningen*, Halmstad.
- HANSEN L.  
 1989 Hamnanläggningar på Kivik – en studie över medeltida aktiviteter med maritim anknytning, in *Vrakeskans vänner* 1989, Kivik, p. 1-18.
- LINDQVIST P.-I.  
 1981 Lödde kar, *Meddelanden från Marinarkeologiska sällskapet* 3, p. 32-38.
- ROSBORN S.  
 2015 Äldre kommunikationer i Öresundsområdet, in S. von Arbin, P. Nymoen, F.-A. Hedlund Stylegar, M. Sylvester, A. Gutehall, P. Skanse (eds), *Tjop tjop! Vänbok till Christer Westerdahl med anledning av hans 70-årsdag den 13 november 2015*, Skärhamn, Båtdokgruppen, p. 247-262.
- SCHÖLDSTRÖM B.  
 1881 Vid Morups tånge, *Svenska Familj-Journalen* 20, p. 329.
- STORM G., BUGGE A.  
 1914 *Norges kongesagaer IV. 1914-utgaven. Haakons, Guttorms, Inges saga, Haakon Haakonsøns saga, Magnus Haakonsøns saga*, Kristiania, I.M. Stenersens Forlag.
- WESTERDAHL C.  
 1989 *Norrlandsleden I. Källor till det maritima kulturlandskapet*, Härnösand, Länsmuseum -Murberget, Arkiv för norrländsk hembygdsforskning XXIV, 1988-89.





# BOA VISTA 1: CONTEXT AND CONSTRUCTION DETAILS OF AN EARLY MODERN SHIP DISCOVERED IN LISBON, PORTUGAL

José BETTENCOURT, Gonçalo C. LOPES, Cristóvão FONSECA, Tiago SILVA, Patrícia CARVALHO  
and Inês P. COELHO

---

## Abstract

Archaeological excavations carried out in the riverside area of Lisbon in 2012 and 2013 revealed the remains of two ships: Boa Vista 1 and Boa Vista 2. Both were found in a wide anchorage used since Roman times, where they were deposited at some point between the mid-17<sup>th</sup> and the mid-18<sup>th</sup> centuries.

This paper will present a preliminary analysis of the Boa Vista 1 construction. Some features are common in the Mediterranean, for example, a composite keel with butt joints and hook scarfs in the connection between floor timbers and futtocks. A particular feature of this ship is the hull's protective wooden sheathing.

## Keywords

Lisbon, Portugal, post-medieval ships.

## Résumé

Les fouilles archéologiques effectuées sur les rives du Tage à Lisbonne entre 2012 et 2013 ont mis au jour les vestiges de deux navires : *Boa Vista 1* et *Boa Vista 2*. Tous deux ont été trouvés dans une grande zone de mouillage, en usage depuis l'époque romaine, où ils ont vraisemblablement été abandonnés entre le milieu du xvii<sup>e</sup> et le milieu du xviii<sup>e</sup> siècle.

Cet article présentera une analyse préliminaire de la construction du navire *Boa Vista 1*. Certaines caractéristiques sont courantes en Méditerranée avec, par exemple, une quille composite présentant des joints plats et des écarts à crocs pour la liaison entre varangue et allonges. Une particularité de ce navire est la présence d'un doublage en bois de la coque.

## Mots clés

Lisbonne, Portugal, navires, époque moderne

---

Archaeological excavations performed in the construction area of the new corporate headquarters of EDP (Energias de Portugal) uncovered the remains of two ships, Boa Vista 1 (BV1) and Boa Vista 2 (BV2). Both were unearthed between September 2012 and February 2013, during a salvage excavation carried out by ERA Arqueologia Company, which requested the contribution of CHAM-Centre for the Humanities to ensure the required nautical archaeology expertise.

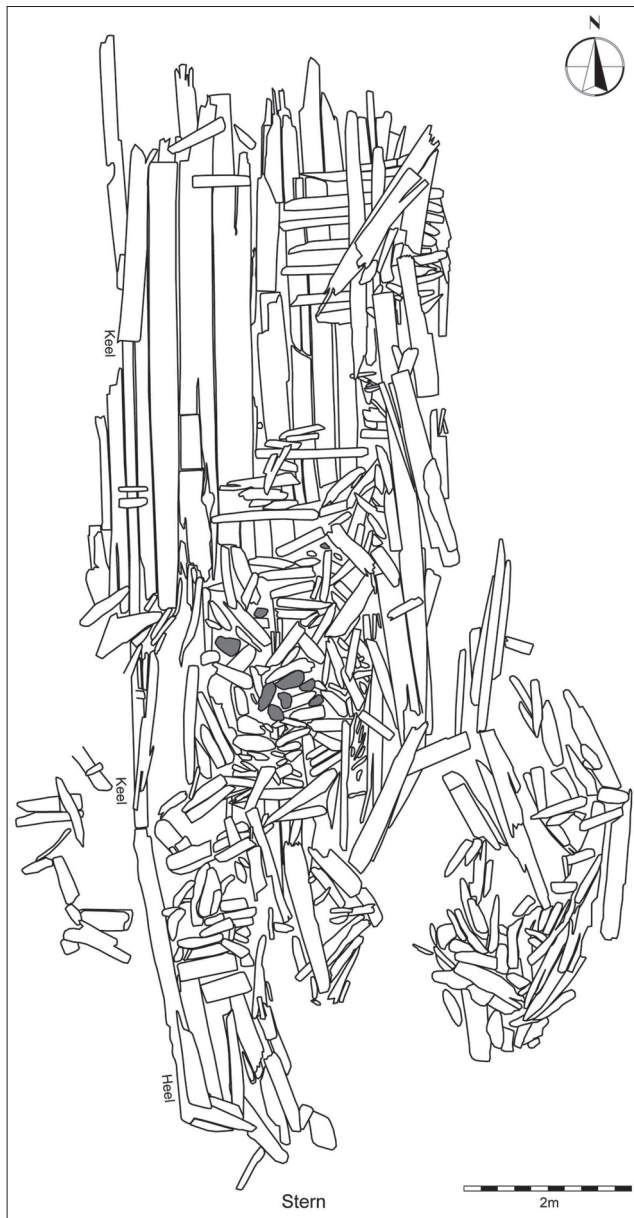
The BV1 ship was excavated in two distinct phases, due to the constraints of the engineering works. The vessel was recorded *in situ*, using rectified photographs and a total station survey. The remains were then dismantled, also in two phases, which required the sectioning of some timbers; they were kept immersed in water tanks, first at EDP's storage facilities and then at the CAL (Centro de Arqueologia de Lisboa) depot. In 2013, our team took over the study of these remains and conducted a four-month assessment, including a phase of analysis and systematisation of the field data. A general inventory of all the ship's timbers and other archaeological finds was compiled. A number of selected timbers deemed crucial for the vessels' interpretation were recorded. This research is now being carried out as an objective of the Lisbon waterfront project and in the scope of the PhD dissertation of one of the authors.

This paper will present the first results of the BV1 research, concerning an approach to the field data, the inventory and the archaeological recording of some selected timbers.

## 1. THE CONTEXT

The vessels were found on Lisbon's riverfront, buried in the former Boa Vista beach, a submerged zone until the 18<sup>th</sup> century. From the mid-17<sup>th</sup> century onwards, this area was occupied by an anchorage, several wharves and warehouses belonging to the Junta de Comércio do Brasil, a state-owned trading agency. Three different occupation phases were identified and recorded during the archaeological monitoring. The first phase corresponds to the Fábrica de Gás da Boa Vista (gasworks), which was active between 1846 and 1923; the second phase corresponds to the Boavista landfill, of considerable thickness, upon which the Fábrica do Gás was built. The third phase corresponds to the remains associated with the riverfront and the former beach where the two vessels and a number of vestiges related to port activities were found. The latter predate the Boavista landfill and featured four sedimentary units deposited in a subtidal, low energy environment. These sediments show a clear increase of the anthropic signature, including ceramics, glass and anchors made between the 16<sup>th</sup> and the 18<sup>th</sup> centuries and, to a lesser degree, some remains of Roman amphorae (Bettencourt *et al.* 2017).

The Boa Vista 1 ship was found within these layers, in the subtidal zone: the top of its structures was only 0.49 m below the lowest tide. This depth suggests abandonment because the structure could be accessed during low tide. This



**Fig. 1:** Provisional plan of the Boa Vista 1: first layer, including scattered timbers (CHAM- Centre for the Humanities).

hypothesis is consistent with the low quantity of artefacts associated with the ship: actually just some rigging elements. The abandonment hypothesis is also suggested by the dismantling processes, showing different orientations, clearly conditioned by human actions. The hull was sealed by deposits containing materials dating from the second half of the 17<sup>th</sup> century or from the first half of the 18<sup>th</sup> century: for example, English or Dutch kaolin pipes, English onion bottles, Rhenish blue-on-grey stoneware and Portuguese faience. The chronological range indicates that these materials cannot be associated to the BV1 ship. Instead, they correspond to deposits that are either contemporaneous with or postdate the ship and resulted from the use of this zone as a port area. Nevertheless, these materials indicate a chronology for the ship, between the mid-17<sup>th</sup> and the mid-18<sup>th</sup> century (Bettencourt *et al.* 2017).



**Fig. 2:** a) General view of the Boa Vista 1 during the first excavation phase (north to the right); b) view from south of the stern section. Note the difficult working conditions and the jumble of timbers. The heel appears in the foreground; c) view from north of frames and stringers in the northeast extremity of the hull (CHAM- Centre for the Humanities).

## 2. THE HULL

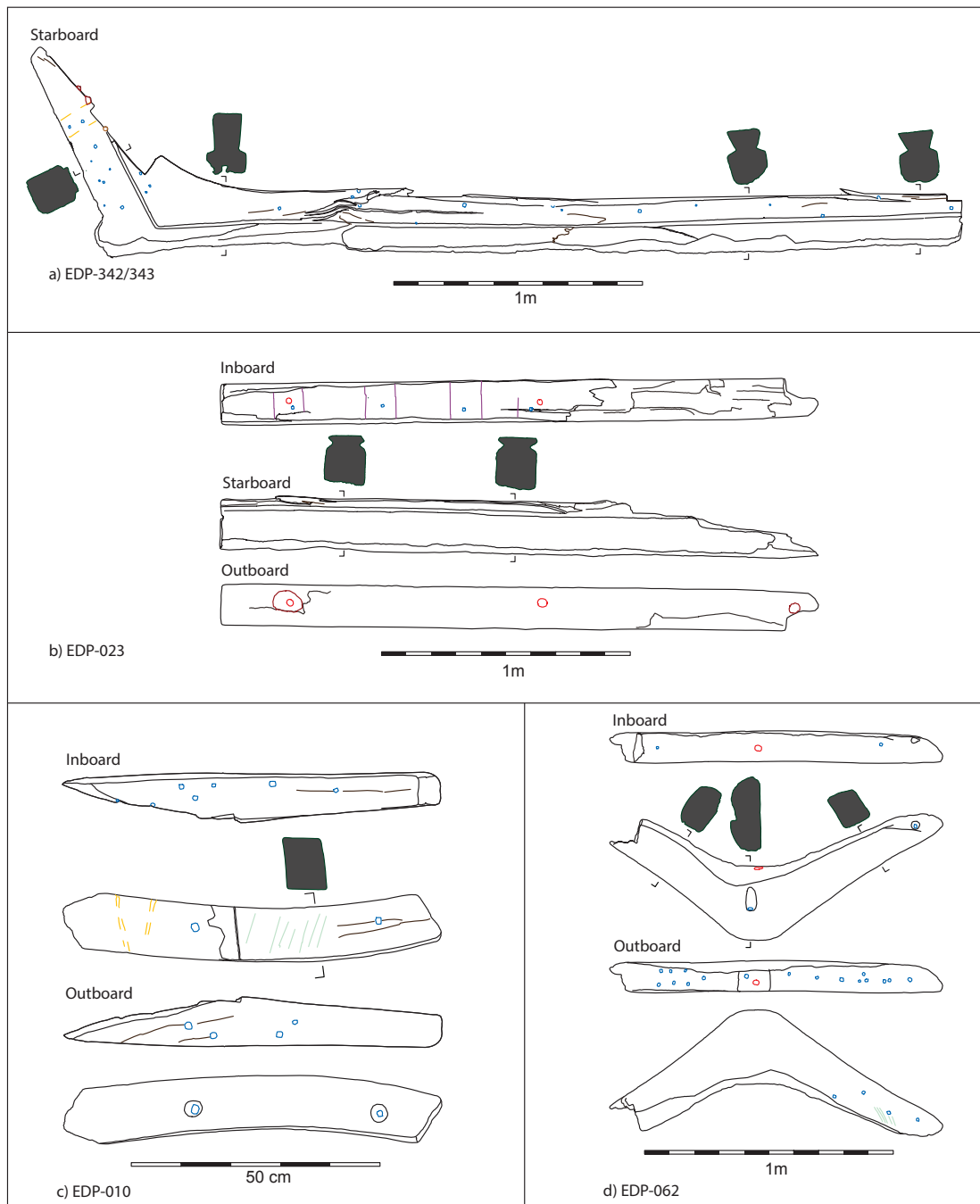
The ship's remains extended over 12 m (north/south) and 5 m (east/west) and corresponded to a section of the stern, from the keel to the tenth strake of the starboard planking, in the northernmost area (fig. 1). The stern was located in the southern end, starboard side slumped over.

The context was heavily disturbed due to the landfill's pilings, and contaminated by naphtha, used as fuel in the gasworks. No frames were attached to the keel and the southeast portion of the site was a jumble of timbers, apparently collapsed from the starboard bottom. Thus, the only elements of the hull that still kept their original arrangement were a part of the keel, the planking, some futtocks, hanging knees and stringers on the starboard side, and some fragments of the framing near the stern (fig. 2).

### 2.1. KEEL AND STERNPOST

The keel was preserved as far as the stern and was composed of three sections, to a total length of 11.84 m. In broad terms, it features a rectangular section +/-16 cm wide and 20 cm in height.

The first section (EDP-023) is incomplete, measures 2.40 m in length and was displaced. The other two sections were complete (fig. 3b). The main section (EDP-089/502) measures



**Fig. 3:** a) EDP-342/343 – heel; b) EDP-023 – keel; c) EDP-010 – frame fragment with a hook scarf; d) EDP-062 – V-shaped floor timber (CHAM- Centre for the Humanities).

5.97 m in length. The EDP-342/343 piece is 3.74 m long and corresponds to the final portion of the ship's stern, incorporating a heel in the transition to the sternpost and a very significant part of the keel (fig. 3a).

These sections were connected with butt joints, without any evidence of a fastening system. The butt joints feature, all along their width and below the rabbet, a semicircular notch, 2 cm in diameter, left by the drilling of a stopwater.

The transition of the keel to the sternpost with a heel (EDP-342/343) is also interesting. Besides the incorporation of a very significant part of the keel, it shows no sternpost knee and features a rebate *circa* 3.5 cm deep along a length of 1.01 m,

starting at the stern. Right after the keel rabbet, the sides of the heel are carved to fit the garboards. Therefore, the top of the heel shows a progressive narrowing, from 14.5 cm at the joint to the keel to 11.5 cm at the zone where the sternpost is fitted. Accordingly, the rabbets' opening angle increases progressively, in the same direction.

At the extremity of the stern, the heel was fitted with a filling piece (EDP-606), over the skag. The sternpost, only preserved at the base (EDP-605), was also fitted to the heel, by means of a hook scarf with three stopwaters between 2.5 and 1.8 cm in diameter. The position of the first rudder gudgeon is indicated by the negatives of the concretions.



## 2.2. FRAMING

The ship's frames were almost totally displaced. At the northern extremity of the site, only a small fragment of a frame and some futtocks were found along the starboard side. At the southern end, the condition of the structure was not much better: a number of Y-shaped frames were found in the heel. The other recovered pieces were found within a jumble of timbers, some of which were in good condition. A total of 11 frames, 51 futtocks and 74 undetermined elements was found.

Nevertheless, the observations made so far allowed for the characterisation of some details of the framing. The fittings and the negatives of the frames, on the inner face of the planking and the keel, indicate that the frames were between 11 and 14 cm sided in the central section of the ship. The EDP-072 frame, the only one found in position, was 12.5 cm sided 10.8 cm moulded. The space between these frames measured between 14 and 24 cm, corresponding to a room and space of *circa* 30 cm. The futtocks show a square section, with between 8 and 11.2 cm moulded and between 7.5 and 12.6 cm sided.

The fastening holes on the upper surface of the keel show that each floor timber was connected by at least one 1 cm square iron nail. One of each three or four frames featured round iron bolts, 1.8 to 2.2 cm in diameter, with round countersinks in the lower surface of the keel, probably for the connection between keelson, floor timber and keel.

Among the fragments of the central frames, we identified two hook scarfs between the floor timbers and the futtocks, in the only portion of the structure where the overlap was preserved (fig. 3c). There was yet another scarf among the scattered fragments. It is not possible to measure the overlap, but apparently the futtocks were placed towards the extremity of the ship. The scarfs were 1.1 to 1.6 cm deep. The connection was probably fastened with two or three iron nails. The nails' heads were embedded in circular countersinks 2.5 to 3 cm in diameter.

Towards the stern there were some V- and Y-shaped frames, sometimes composite, with filling pieces. The joints of the V-shaped frames were fastened with one nail, 1.4 cm to a side, driven obliquely from the lateral face and embedded in a previously opened notch (fig. 3d). Some frames were also fastened by one or two iron bolts with a 2 cm section, driven from the top. The V-shaped frames were also attached to the futtocks using iron nails.

## 2.3. STRINGERS, CEILING AND KNEES

Only two stringers were found in position but the presence of holes from iron fittings on the top of the futtocks suggests the use of other internal elements.

None of these pieces keeps its original length but EDP-079 is 19 cm wide and was notched on its inferior face to fit the frames: its thickness therefore varies between 7.5 and 8.5 cm. It was fastened to the frames with two 1 cm square iron nails per joint, placed in subcircular cavities. The imprint of the heads seems to be circular, *circa* 2.5 cm in diameter.

Two elements identified among the stringers are similar to hanging knees, but they are probably just reinforcement pieces. A detailed observation of the fastening system connecting these knees to the futtocks is not possible, but the use of iron fasteners is not unlikely.

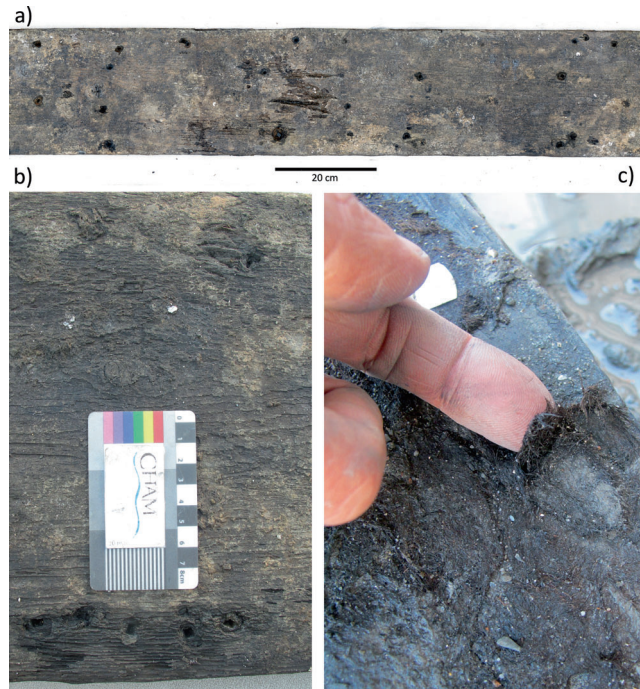


Fig. 4: Wooden sheathing: a) typical outboard aspect; b) detail of nail heads on the outboard face; c) detail of the coat of unidentified animal hair placed between the sheathing, the planking and the keel (CHAM- Centre for the Humanities).

## 2.4. PLANKING

The outer planking was better preserved, especially on the starboard side, where ten strakes were preserved. On the port side, only the start of two strakes was preserved. A total of 170 elements are accounted for, including the pieces found in connection and the displaced ones.

No complete pieces were found but the larger planks probably measured over 4.50 m, considering the length of the largest recorded pieces. The width varies between 4.8 and 39.7 cm, but mostly between 20 and 29 cm: the thickness ranges from 4.5 to 5.6 cm but is mostly around 5 cm. The narrower pieces may correspond to repairs.

The majority of the planks were connected with butt joints, even if some flat scarfs were recorded. Another particularity of the planking concerns the existence of numerous repairs with small planks: this was also observed in displaced pieces.

The planks were fastened to the frames using 1 cm square iron nails. The nail heads were embedded in round countersinks in the outboard face. The pattern of these joints varies between two or three nails along the plank and up to five in some of the extremities. No wooden fittings were used to fasten the planking. An unidentified vegetable fibre was used in the caulking.

A possible displaced footwale (EDP-367/475) was also identified on the eastern extremity of the site, measuring 19.5 cm in width and 10 cm in thickness and featuring a vertical flat scarf at the top.

## 2.5. SHEATHING

The planking, the keel and the heel were protected by a wooden sheathing composed of a total of 117 elements. The

complete planks have lengths between 3.90 m and 4.20 m, widths between 23.8 and 27.5 cm, and thicknesses between 2 and 2.5 cm.

These planks were fastened using 0.5 to 0.6 cm square nails, mostly placed close to the edges: the heads were embedded in round countersinks, 1.5 cm in diameter (fig. 4). A number of wooden plugs, driven from the outboard face, were also recorded, which may well have been used to provisionally attach the planks.

Between the sheathing, the planking and the keel, the hull had a coat of still unidentified animal hair (fig. 4c). Some planks featured circular holes, 2.5 cm in diameter, of unknown function. Some other pieces show incised markings whose function also remains unknown.

### 3. PRELIMINARY DISCUSSION

The analysis of the ship's hull is a complex task due to its condition. It is also difficult due to the ship's chronology, late 17<sup>th</sup> or early 18<sup>th</sup> century, an under-researched period as far as the Atlantic is concerned. In fact, the set of construction features presented here has no close parallel in any other hull published to date. Nevertheless, BV1 features some construction details common in the Mediterranean, which can be viewed as a starting point for the research.

First of all, the keel butt joints: this kind of scarf, of probable Mediterranean origin, is referred to in several Spanish 17<sup>th</sup>-century documents and its use was probably common, namely in oceanic ships (Hormaechea *et al.* 2018, p. 68-73). The same type of joint is described in the 1691 *Traité de la Construction des Galères* (Rodrigues *et al.* 2001, p. 356). These scarfs may feature varied characteristics, with or without rabbet, for example: parallels can be found in the Mediterranean, from the western Mediterranean to the Black Sea and from the Middle Ages to the 19<sup>th</sup> century (Batchvarov 2014, p. 409-410). However, the use of stopwaters has only been documented in the Dnieper (Ukraine, 18<sup>th</sup> century) and Kitten (Bulgaria, 19<sup>th</sup> century) ships (Batchvarov 2014, p. 409). It has also been recorded in Portugal, in the Cais do Sodré ship (16<sup>th</sup> century) (Rodrigues *et al.* 2001, p. 354-357).

The second feature was observed on the frames. The fastening holes show that the ship was built frame-first: all the floor timbers were fastened to the keel and heel. The frames confirm a skeleton-first construction, since it is possible to find hook scarfs in the connection between the floor timbers and the futtocks. This is also a feature mostly found in Mediterranean ships, for instance, in Culip VI (Spain, 14<sup>th</sup> century), at Yassi Ada (Turkey, 16<sup>th</sup> century), in Mortella III (France, 16<sup>th</sup> century)

(Cazenave de la Roche 2016, p. 853) in the Sardinaux ship (France, late 17<sup>th</sup> century) or in the Kitten ship (Bulgaria, 19<sup>th</sup> century) (Joncheray 1988, p. 53; Rieth 1998, p. 40; Batchvarov 2014, p. 401). The small section of the floor timbers and a bigger space is yet another characteristic of these ships (E. Rieth, personal communication).

However, BV1 shows some characteristics that make it quite unique. The morphology of the heel, similar to the ships of Ibero-Atlantic tradition, incorporates a significant part of the keel, as opposed to other known cases. For example, the larger Red Bay ship features a shorter, only 1.95 m-long heel (Loewen 2007, p. 41). Another uncommon feature is the lack of a dead-wood knee reinforcing the connection between the heel, the keel or the sternpost.

Another unparalleled characteristic, as far as Mediterranean vessels are concerned, is the protection of the bottom by a wooden sheathing, attached with small iron nails, compressing a coat of animal hair against the keel and planking. Actually, during the period that concerns us here, this particular technique was mostly used by Northern European navies in ships that sailed to the Mediterranean Sea routes or to tropical waters. Besides its well-known use in Dutch vessels, it has also been identified in British ships, such as the *Dartmouth*, in which a layer of hair and tar was present as well (Martin 1978, p. 49-50). The use of sheathing in Portugal is also referred to in written sources since the 17<sup>th</sup> century, but it had never been identified in the archaeological record prior to the discovery of the Boa Vista ships (Bettencourt *et al.* 2017).

To conclude, the poor preservation of BV1 conditioned the intervention and interpretation of the remains, deferring the systematic recording of the ship's hull and its cultural integration to the laboratory phase. The location, the site formation processes and the finds suggest that it was abandoned on Boa Vista beach during the transition of the 17<sup>th</sup> to the 18<sup>th</sup> century. To the best of our knowledge, the assemblage of construction features presented herein has no close parallel in any other hull published to this date in Portuguese and Atlantic contexts, even though BV1 features some details common in the Mediterranean. Its place in history remains a mystery, and she is therefore an essential and unique source for the study of post-medieval shipbuilding.

### ACKNOWLEDGMENTS

This article had the support of CHAM (NOVA FCSH / UAc), through the strategic project sponsored by FCT (UID/HIS/04666/2019).

## REFERENCES

- BATCHVAROV K. N.  
 2014 The Hull Remains of a Post-Medieval Black Sea Merchantman from Kitten, Bulgaria, *IJNA* 43.2, p. 397-412.
- BETTENCOURT J., FONSECA C., SILVA T., CARVALHO P., COELHO I. P., LOPES G. C.  
 2017 Navios de Época Moderna: balanço e perspectivas de investigação, in A. Caessa, C. Nozes, I. Cameira, R. B. Silva (eds), *I Encontro de Arqueologia de Lisboa: Uma Cidade em Escavação*, Lisboa, Centro de Arqueologia de Lisboa / Departamento de Património Cultural / Direcção Municipal de Cultura / Câmara Municipal de Lisboa, p. 478-495.
- CAZENAVE DE LA ROCHE A.  
 2016 El pecio de la Mortella III (Córcega, Francia): un aporte al conocimiento de la arquitectura naval del siglo XVI en el Mediterráneo, in R. C. Belinchón, A. R. Pernía, L. A. T. Sobriño (eds), in *Actas del V Congreso Internacional de arqueología Subacuática (IKUWA V), Un patrimonio para la humanidad, Cartagena 2014*, Cartagena, Ministerio de Educación, Cultura y Deporte, p. 853-870.
- HORMAECHEA C., RIVERA I., DERQUI M.  
 2018 *Los barcos oceánicos del Atlántico ibérico en los siglos XVI y XVII – Tomo II*, Barcelona. [https://www.academia.edu/37437680/Los\\_barcos\\_oce%C3%A1nicos\\_del\\_At1%C3%A1ntico\\_ib%C3%A9rico\\_en\\_los\\_siglos\\_XVI\\_y\\_XVII\\_Tomo\\_II\\_de\\_III](https://www.academia.edu/37437680/Los_barcos_oce%C3%A1nicos_del_At1%C3%A1ntico_ib%C3%A9rico_en_los_siglos_XVI_y_XVII_Tomo_II_de_III) (11/06/2019)
- JONCHERAY J. P.  
 1988 Un navire de commerce de la fin du XVII<sup>e</sup> siècle, l'épave des Sardinaux. Première partie : le navire et son mode de chargement, *Cahiers d'Archéologie Subaquatique* VII, p. 21-67.
- LOEWEN B.  
 2007 14. The Hull: of Ship Design and Carpentry, in R. Grenier, M. Bernier, W. Stevens (eds), *The Underwater Archaeology of Red Bay. Basque Shipbuilding and Whaling in the 16<sup>th</sup> century*, Vol. III, Ottawa, Parks Canada, p. III-1 – III-148.
- MARTIN C. J. M.  
 1978 The Dartmouth, a British frigate wrecked off Mull, 1690. The ship, *IJNA* 7.1, p. 29-58.
- RIETH, E.  
 1998 Construction navale à franc-bord en Méditerranée et Atlantique (XIV<sup>e</sup>-XVII<sup>e</sup> siècles) et signatures architecturales : une première approche archéologique, in E. Rieth (ed.), *Méditerranée Antique. Pêche, Navigation, Commerce*, Aix en Provence, CTHS, p. 177-188.
- RODRIGUES P., ALVES F., RIETH E., CASTRO L. F.  
 2001 L'épave d'un navire de la deuxième moitié du XV<sup>e</sup> siècle/début du XVI<sup>e</sup>, trouvée au Cais do Sodré (Lisbonne). Note préliminaire, in F. Alves (ed.), *Proceedings. International Symposium on Archaeology of Medieval and Modern Ships of Iberian-Atlantic Tradition. Hull remains, manuscripts and ethnographic sources: a comparative approach, Lisbon 1998*, Lisboa, Instituto Português de Arqueologia, *Trabalhos de Arqueologia* 18, p. 347-380.

# DIFFERENT KINDS OF REPAIRS AND MAINTENANCE ON A 2<sup>ND</sup> CENTURY AD WRECK: THE LYON SAINT-GEORGES 4 BARGE

Marc GUYON and Laure MEUNIER

---

## Abstract

Thanks to the complete dismantling of the Lyon Saint-Georges 4 shipwreck prior to conservation work, interventions and repairs conducted after construction and before abandonment were noticed. This was a real opportunity for the acquisition of all kinds of archaeological data, ultimately revealing that only 25% of the data is available when the wreck cannot be dismantled.

The recovery of this data is the result of a multidisciplinary approach. Conservators, wood specialists, metallurgists, textile specialists, archaeologists were able to describe, detail, and understand all the repairs and to rewrite the ship's maintenance log. The complete dismantling also led to the recovery of a lot of waterproofing material, providing complementary data.

## Keywords

Caulking, Gallo-Roman, maintenance, shipwreck, repair

## Résumé

Grâce au démontage complet de l'épave *Lyon Saint-Georges 4* avant conservation, les interventions et réparations effectuées sur le bateau, après sa construction et avant son abandon, ont pu être précisément documentées. Cela a permis l'acquisition de toutes sortes de données archéologiques, révélant finalement que seulement 25% des données sont disponibles lorsque l'épave n'est pas démontée.

La récupération de ces données est le résultat d'une approche pluridisciplinaire. Les restaurateurs, les xylologues, les métallurgistes, les spécialistes du textile et les archéologues ont pu décrire, détailler et comprendre toutes les réparations et réécrire le journal d'entretien du navire. Le démontage complet a également conduit à la récupération de nombreux matériaux d'étanchéité, apportant des données complémentaires.

## Mots clés

Calfatage, gallo-romain, entretien, naufrage, réparation

---

From October 2002 to June 2004, 16 wrecks dated to between the 1<sup>st</sup> century AD and the 18<sup>th</sup> century were excavated on the ancient right bank of the River Saône in Lyon, France. The Institute for Preventive Archaeological Research (INRAP) at the request of the Ministry of Culture carried out the excavations of this harbour site, located on the future Parc Saint Georges' car park. Grégoire Ayala was the manager of this huge archaeological intervention and Marc Guyon was responsible for the excavation of the wrecks. Operations took place within a cofferdam following traditional methods of terrestrial archaeology on an area of approximately 4000 m<sup>2</sup>, to a depth of 10 m (Ayala, Guyon, Laurent 2005).

The Lyon Saint-Georges 4 (LSG4) wreck belongs to a set of six Gallo-Roman boats discovered in 2004. A complete architectural study was conducted and published in 2010 (Rieth, Guyon 2010), but lack of time and the impossibility of dismantling prevented an in-depth survey. The three most complete wrecks were removed and stored in a lake near Lyon to await project funding. This occurred in 2013 and would ultimately lead to the launch of the LSG4 project, which was designed to run for several years and involved: the raising of the wreck from the water (as with AR3); the consolidation of the waterlogged wood; restoration of the ensemble; the creation of a suitable

presentation environment; and the conduct of a complete archaeological study. This large cargo boat could carry a load of up to 53 tons. A full reconstitution of this boat would reach 28 m in length and nearly 5 m in width, however only 15 m in length are preserved. The other parts of the wreck are still under earth, protected by the houses and streets of Old Lyon.

Eight weeks were necessary to remove LSG4 from the car park, but five months were needed to conduct a complete dismantling and to prepare it for PEG consolidation once the sections were raised and transported to the ARC-Nucléart laboratory in Grenoble, France.

The second phase of the conservation campaign began in January 2014. The dismantling took three weeks per section. Elements were stored on shelves by architectural type (flat bottom, sides and ribs) and consolidated in a PEG 2000 solution for at least eight months. The various elements were then freeze-dried using two freeze-dryers. It took between two to six weeks for a cycle and 18 months for the whole shipwreck. Since the end of 2016, it has been stored at the ARC-Nucléart lab, waiting for an exhibition space in the *Lugdunum* museum to be ready in 2024. Time was thus available for further analysis of the various materials and data recovered leading to new archaeological information.



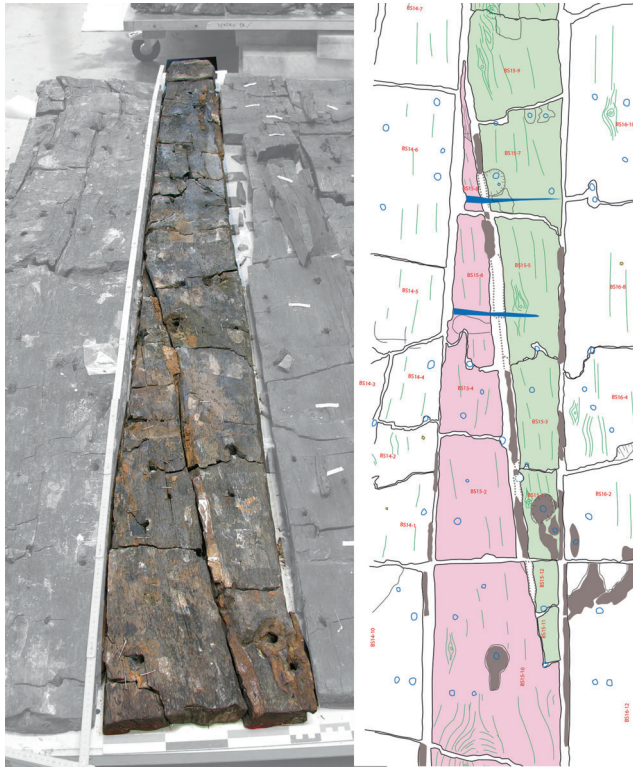


Fig. 1: A crack in plank BS15, section 4 (M. Guyon, Inrap).

## 1. A COLLABORATION OF CONSERVATORS AND ARCHAEOLOGISTS IN COORDINATED RESEARCH TO RECOVER MORE ARCHAEOLOGICAL DATA

Complete coordinated dismantling is a real opportunity for the acquisition of all kinds of archaeological data, only 25 % of which is available when the wreck is not dismantled. (This estimate is based upon the notion of a section still on the excavation site and studied over three days without special equipment and only partial dismantling, versus a complete dismantling with the intervention of conservators). The removal of all frames gave access to the flat bottom and led to a completion of the original plan that had been recorded during discovery in 2003. This initial plan had left many questions unanswered concerning the assembly of planks in the same strake, and had provided no view of the underneath. Dismantling allowed among other things the drawing and recording of all the surfaces of the constituent elements and both sides of the flat bottom once cleaned.

## 2. REPAIRS AND MAINTENANCE

After dismantling it became apparent that two planks of the flat bottom had been repaired (Guyon forthcoming). They cracked during installation, and so the carpenters chose to repair and consolidate them by transverse nailing (fig. 1) on the plank BS15, section 4. Another repair involved the replacement of a frame timber. This is visible because of the presence of a

lot of small pegs, although this was very difficult to perceive before the wood was freeze-dried. We observed oblique alignments of three pegs (fig. 2), which exactly reproduced the alignment of nailing on the upper surface of the flat bottom under VP7. Once the old frame had been removed, the carpenters filled the holes left by the nails with the pegs before re-attaching a new frame. During the archaeological excavations, no pegs were seen on the surface of the flat bottom: it was only during dismantling that these pegs were noticed and recorded. A further search for pegs was carried out after freeze-drying because during this operation a slight shrinking of the wood takes place making the pegs more easily visible.

Another repair can be seen involving a frame timber. A hole had appeared in plank BS15, section 4, of the flat bottom because of a knot being removed, hence causing a potential leak. This hole was filled with caulking textiles held in place by a small wooden plate (fig. 3) (Rieth, Guyon 2010).

Another repair was made using a piece of wood embedded in a frame timber. This was first thought to be a waterproofing repair but as nothing was visible on the flat bottom after its removal, the floor timber must have had a fault at this point and the carpenters preferred to remove it during construction. Anyway, this rectangular piece is not from the same wood.

A major repair took place at the front of the boat. Several lead strips, originally from ancient piping, are present (Rieth, Guyon 2010). After removal of these lead strips, we saw that the widest strake had been repaired with many softwood wedges. This repair might have been as a result of operational wear on the plank, which is about 70 cm wide and had split naturally in its centre, which includes the middle of the tree, a fragile area from the outset. Alternatively the repair may have been necessary after a frontal impact, requiring a serious intervention including the cutting of many frames.

At least nine wedges were found in the large crack in the central strake. Other wedges were present but have since disappeared because this part of the boat experienced a number of problems, particularly during its removal from the excavation site when parts of the flat bottom cracked during extraction. Once the wedges had been inserted, in order to make the repair as waterproof as possible, cloth coated with pitch was placed over the wedges before laying the lead strips. We clearly distinguished the weave of the textile used impressed in negative on the underside of the lead plate.

Another repair filled a gap due to the missing part of the bilge, with a knee having a protuberance forming a heel on its lower face. Thanks to the dismantling it was also possible to observe manufacturing marks from a nail header on the underside of the nail heads.

Similar observations have also been made on various shipwrecks, in particular on the Chalon-sur-Saône wreck (France), the Bevaix barge (Switzerland) and the Arles-Rhône 3 (France). These marks are not exclusive to nails for shipbuilding, but are also found on Roman shoe nails, for example. They could be interpreted as motifs recording the production of a particular blacksmith or blacksmith's workshop.

## 3. CAULKING

The waterproofing of the boat was made with textiles impregnated with pitch. During the manufacture of the flat bottom

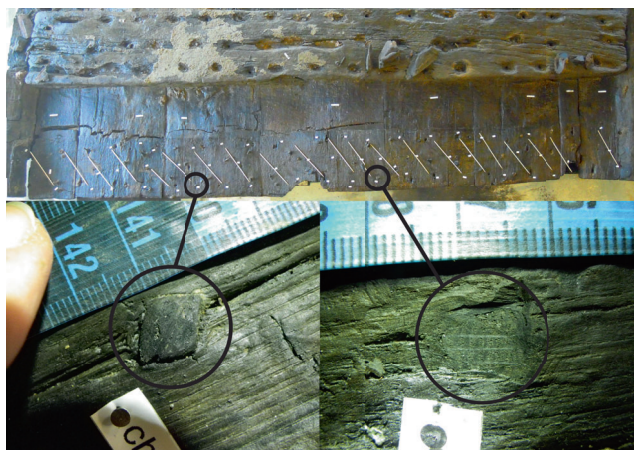


Fig. 2: Pegs on the upper face of the flat bottom under VP7 (M. Guyon, Inrap).

planks, carpenters gave a particular shape to the profile of the edge. This profile, once the two planks were positioned against each other, formed an inverted Y, with a slight protrusion downwards to keep the caulking material in place without any other means to secure it. The initial profile of the edge was axe cut. When replacing the waterproofing, the protrusion disappeared because, in order to remove it, a gouge had to be used to pull the pitch cloth out. Use of this tool eliminated the protrusion on the edge, thus allowing us to record precisely where the waterproofing had been replaced.

During the dismantling of the barge 26 m of caulking material was removed for further study. It mainly came from the space between the bilge and the side. At first, it looked like a piece of wood, but after a more detailed examination the textiles could be seen. During our research we were faced with a new challenge as to how we might carefully unfold this material and how this new data could be exploited to answer historical questions.

Indeed, Roman nautical textiles are quite rare artefacts and previous studies have focused on the textile characteristics (Médard 2009, 2010a, 2010b, 2013, 2014, 2018; Schoefer 2004). Our aim was to link these textiles with the barge, to understand how the caulker did his job, and which techniques were employed.

Until now, caulking textiles have been chemically unfolded by removing the pitch, leaving the cloth in a clean and flat condition for archaeological study (Plantec 2010; Schoefer 2004). Attempts to follow the previous procedure led to the destruction of the samples because of the very high pitch content, which had completely impregnated the textile. This unsatisfying state of affairs encouraged us to elaborate a new protocol, which began first with the question of the link between the material and the barge, and secondly how to record these operations, since each stage, from beginning to end, is a definitive transition with no possible return. The functional specifications of this new protocol were: to be efficient and fast; to limit waste, costs and toxicity for the operator; and still respect the textile. Organic solvents attack fibres, which become more fragile when treated this way and then tear at the folds. The new protocol used hot water to make the pitch plastic enough to allow the textile to be unfolded. With this technique, larger pieces of textile can be recovered (Meunier, Guyon forthcoming). Observation of

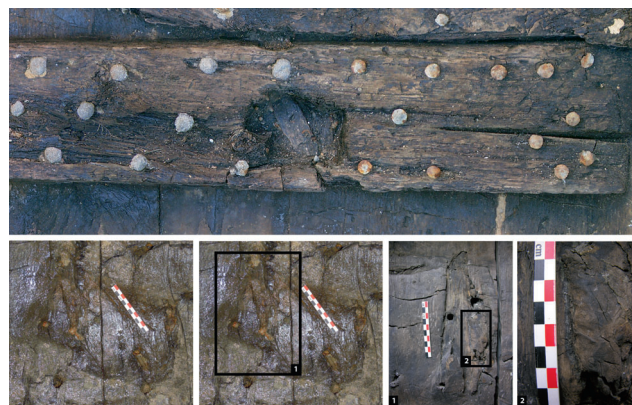


Fig. 3: Wooden plate on plank BS15, section 4 of the flat bottom (M. Guyon, Inrap).

impregnated textiles is more difficult because the pitch is not removed with the new method, but this technique allows for complementary recording.

#### 4. NEW FINDS FOR ARCHAEOLOGY

During the unfolding of the textiles, a clue appeared to identify the waterproofing technique used on the Lyon Saint-Georges 4 shipwreck. Normally on the Rhône-Saône axis between the 1<sup>st</sup> to the 3<sup>rd</sup> century AD luting was used. This technique applies the waterproofing material in the course of boat construction, between the seams of timbers as they are being assembled. A very good example of this technique using pitched textiles, as on the Lyon Saint-Georges 4, has been recorded on the Arles-Rhône 3 shipwreck (Marlier 2014, p. 114). Marlier has shown that in this case large amounts of waterproofing material extend inside the bottom and that it can reach 6.5 cm outwith the seal between the bilge and the side. Excess waterproofing material can regularly be observed inside the boat. A lining was put over this to avoid the necessity of dealing with it. In the Arles-Rhône 3, the form of the seal was an inverted V with no protrusion. This can be explained by the use of the luting technique. Pitched textile was nailed during the construction, helping to keep it in place. This shipwreck, through her characteristics, date (1<sup>st</sup> century AD) and location, can be compared to Lyon Saint-Georges 4. Here, no excess waterproofing material has been observed inside the shipwreck. The profile of the seals between the planks, the inverted Y, stops before reaching the other, interior side. This means that waterproofing material simply cannot physically escape beyond the seal. Moreover, while unfolding the pitched textiles, no lack of textile has been observed in the pieces located in the upper part of the seal, meaning that the excess textile extending beyond the seam might have been cut. And the protrusion at the bottom of the edge helps to keep the waterproofing material in place. All this led to the hypothesis of caulking instead of luting on this barge. This hypothesis was confirmed when we found an example from the area between the bilge and the side, in which a nail was trapped in the pitched textile (a second nail has also been found, showing this was not a unique example): the nail did not pierce the cloth (fig. 4). The textile is wrapped around the nail, and



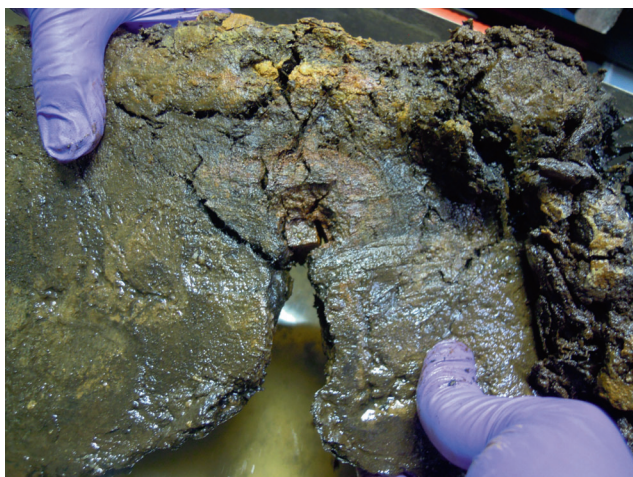


Fig. 4: Waterproofing material surrounds a nail (M. Guyon, Inrap).

the fact that the textile is not pinned by the nail signifies that the waterproofing material was placed after nailing. The textile does not run perfectly to the end of the gap, meaning that there was no way of checking that it did. This shows that the waterproofing was done after the complete construction of the boat, and this process is caulking.

Through exhaustive unfolding work, new perspectives and new data appeared. Nearly 3 m<sup>2</sup> of Roman textiles have been recovered from the Lyon Saint-Georges, the most from one boat in Europe. Some vegetal textiles are part of this material, but they represent a small part of the discoveries, which are mainly animal fibres (essentially sheep and goat: it is very difficult to differentiate them). As regards the vegetal fibres, only two types of weaving are present: tabby and twill. This latter has been identified as a technical fabric already known in the 3<sup>rd</sup> century as a support for sewing metal elements to form Roman armour (personal communication with J.P. Wild, April 2018, about his finds on the Vindolanda site). These textiles are of course reused, and we tried to find some clue as to their previous utilisation and to understand if they were specifically chosen for this task.

Nautical textiles from ancient shipwreck have been found before now. The textiles coating the hulls of the Madrague de Giens shipwreck from the 1<sup>st</sup> century BC (Tchernia, Pomey, Hesnard 1978, p. 85) and the Nemi ships from the 1<sup>st</sup> century AD (Ucelli 1950, p. 265-268) were both woollen, and the thickness of the fibres used on the Nemi ships suggested a very high quality. However, no ancient source records this process. The fabrics we have found were tabby and were used between the planks of the hull and an external protective layer of lead sheeting. This indicates a specific production for that purpose, and a highly controlled quality. The use of wool in this location is a calculated choice, and after 2000 years it has come down to us, conserved by the resin that impregnated it. But these textiles were not the only ones used onboard. Sails and tarpaulin were also present, even if remains from ancient times are scarce. Black (Black 1996) assumed that since no piece of sail has been found in shipwreck excavations in the Mediterranean area, and since antique sources only indicate vegetal fibres as being used for that purpose, the material has not survived the ravages of time either underground or underwater. But with the tabbies



Fig. 5: Warp-faced tabby from Lyon Saint-Georges 4, comparable to the Nemi's finest textiles (L. Meunier, IFIRES).

of the Nemi and the Madrague de Giens, we have proof that nautical textiles have survived the ages, at least those made from wool when impregnated with resin, which are the same conditions as the pitched textiles used to waterproof the Lyon Saint-Georges' shipwrecks, as well as those of Arles-Rhône and Tolozan.

Other nautical textiles have been found, mainly in Egypt, where the climate is more favourable to their conservation. These includes examples from Berenike, 1<sup>st</sup> to 5<sup>th</sup> century AD (Wild & Wild 2001), Quseir al-Qadim from 1<sup>st</sup> to 2<sup>nd</sup> century AD (Handley 2011), Myos Hormos 1<sup>st</sup> century or early 2<sup>nd</sup> century AD (Whitewright 2007) and Thebes, from an Egyptian mummy conserved in Lyon, France, dated to the 2<sup>nd</sup> century AD (Schoefer, Cotta, Beentjes 1987; Rougé 1987; Wild & Wild 2001). All these textiles are from vegetal fibres. Those from Berenike were compared with those from the mummy by J.P. Wild, who identified several pieces as reinforcement strips, often seen as dividing lines on representations of traditional sails, forming a grid pattern where the horizontal widths of fabric intersect with brail lines, to which brail rings were sewn. Parts of these brail rings were found in Myos Hormos, Thebes and Quseir, thus helping to identify the strips on which they were sewn. In Quseir, the amount of material (2,455 fragments of Roman textiles) and the logic of utilisation by spatial location led Handley to assume that textiles remained in the place they were first used until eventual deposition, therefore, in a boat repair yard the cloth would come from a torn sail (Handley 2011, p. 323). This led us to reassess both new and old finds from the Lyon Saint-Georges shipwrecks. While making a catalogue of the nearly 150 pieces of textiles (Meunier 2018), it quickly appeared that some analogies could be made with the ancient nautical textiles from Nemi. The finest textile recovered was the fourth sample, a weft-faced tabby, with a count of 21/2x35 (warp/weft) threads in each direction and made of fibres with a 16 $\mu$  range. This is a technical fabric that has been specifically chosen for the purpose by the Romans with no random element. Fifteen similar examples can be found in the collection of Lyon Saint-Georges, with an average fibre diameter of maximum 20 $\mu$  and the same tabby aspect and z/z spun (fig. 5). Figure 5 is an example of this warp-faced tabby, with regular bundles of threads clearly designed to attach something to the fabric. The number of threads is only available for a few textiles because the survey is still ongoing, but it

is between 24-28/10-12 and 90-110/16. Thread diameters are between 0.1 to 0.3 mm. Six textiles with these characteristics are also present in the collection of Arles-Rhône 3 barge (Médard 2013). In Lyon, three strips can be compared to those from Quseir, Berenike and Thebes, with a width of 4 cm, 3.77 cm and 4.5 cm. Even if the materials used are different – wool for the French textiles and vegetal fibres for the Egyptian – the textiles look the same, are from the same nautical context, and were adapted from material available in their geographical area. Previous surveys by Médard on half of the Lyon Saint-Georges textiles (Médard 2009, 2010a, 2010b, 2014, 2018) provided precious indications as to the technical aspect of the textiles and their fabrication, but made no real link with the nautical world. Médard's experience in the study of clothing and domestic fabrics has convinced her that there are no sewn remains from that particular domain. Another detail to be noticed is the impregnation of the textiles with ochre, which cannot be dissolved in water or organic solvents, in 45 examples (also visible in fig. 5). This cannot be due to the burial phase, since the soil consisted of sand, or from the storage lake, because then all the textiles would have been impregnated. This can be interpreted in the light of nautical practices as a well-known technique recorded since antiquity: sails used to be treated to improve their technical performance and to avoid rotting. This technique has been successfully applied to the woollen sails of the Skuldelev ship replicas (Cooke, Christiansen, Hammarlund 2002) and also the sails of the *Gyptis*, a sailing replica of a 6<sup>th</sup>-century BC Greek sewn boat (Pomey, Poveda 2017), after two years because of the rotting of the sail provoked by dry/wet cycles (P. Poveda, personal communication). The textile is boiled in a mixture of seawater, grease and ochre, then rinsed in the sea and naturally dried. Similar aspects are present in the Arles-Rhône 3 collection. All these observations lead us to the conclusion that nautical textiles and certainly sailcloth were reused to waterproof the boats of Lyon and Arles (fig. 6). All of this survey is still ongoing and a doctoral thesis will begin next September focusing on the subject. A scientific publication on the new discoveries made during the conservation of Lyon Saint-Georges 4 is also in preparation.

While working on the newly found textiles, we had the opportunity to go and see the hemp sails of the *Jeanne-Elisabeth*, wrecked in 1755 near Palavas-les-Flots, France (Bartoš, Sanders 2012). Comparison with some of the nautical textiles conserved in Lyon showed the same reinforcement strip, with an approximate width of 5 cm, and with the same sewing points as on the LSG8 shipwreck, dated to AD 55. They are different on each side of the strip: one with wide stitches, spaced and with a triple twisted thread, and invisible sewing on the other side (fig. 4). This would seem to imply that we have a technological continuity in sail manufacture between AD 55 and 1755, that is, over 17 centuries. Given that nautical techniques are known to be conservative, this could be possible.

## 5. RECORDING THE DIFFERENT STEPS

Several complementary techniques have been used to record the different steps of the protocol. First, photogrammetry coverage of the caulking material was made in order to retain a

3D memory of how it was before and to provide documentation for recording. Thereafter, a GoPro film was made while unfolding the textiles, and a map of the different pieces of textiles was drawn. This was a transitional stage, where observation could be conducted.

This stage was also recorded, and a relief map was made to understand how the textile was folded to be inserted between the planks. The folds are still visible and can be read by transferring the relief map into a monochrome picture. Through this technique, we compared the ways of folding the textiles. We wanted to know if it was always done in the same way or not, so that we might understand the actions involved in doing this task. We can also compare the textile type and the location of the samples to know if there is a link between the space to be filled and the textile used. This seemed to be correct, since the textiles used between the side and the flat bottom were often thicker and their preparation looked rougher, in that, the pieces used were less regular and transformed for this aim, than between the flat bottom planks, where the border was torn. These small pieces showed reduced dimensions to fit the space to be filled, in contrast with the space between the flat bottom and the side, which is wider. It seems logical to quickly fill this gap with a thicker textile, which would allow for faster work and which appears more suitable for this location.

All these textiles can provide exceptional information on Roman techniques of caulking, of course, but also about textiles themselves. The way the caulker operated is still not well understood, but several avenues are currently being explored. We already have more than 2 m<sup>2</sup> of unfolded textile, from nearly 6 linear metres of material, and there are still 23 m waiting to be done. There is a great potential here to make a reference set of Roman textiles. This is what is planned for the near future.



**Fig. 6:** Example of the material that helped connect these finds to a nautical context: two elements sewn together at right angles; two deliberately made circular holes of the same diameter; and a very thick (2.2 mm diam.) vegetal-fibre S2z sewing thread.



## 6. CONCLUSION

This work has shown the complementarity of, and the necessity of collaboration between the archaeologist and the conservator. The conservator's know-how can shed new light on material and add to the understanding of artefacts. Repairs are small but can provide a lot of information regarding the maintenance applied to the shipwreck during its active life. Through archaeodendrochronology of these remains, we hope to know how long this boat was in use. For textiles, the conservation process has allowed us to recover information about textiles used to waterproof barges on the Rhône, showing that they originated within a closed system proper to the shipyard itself, even if complementary observations still need to be conducted.

Textiles are more intimately linked to the artefact in which they feature, and are not just add-ons.

## ACKNOWLEDGMENTS

Thanks are due to the Lugdunum Museum (Lyon, France) for allowing the study of the textiles from the Lyon Saint-Georges shipwrecks, to Inrap (Institut National de Recherches Archéologiques Préventives) for archaeological support, to ARC Nucléart (Grenoble, France) for technical support and access to the textiles, and to LPA (Lyon Parc Auto) for funding.

## References

- AYALA G., GUYON M., LAURENT F.  
2005 Lyon Saint-Georges (France): la fouille d'une berge de Saône, in H. Stoepker (ed.), *Archaeological Heritage Management in riverine landscapes*, Rapportage Archeologische Monumentenzorg, 126, Amersfoort, p. 89-94.
- BARTOŠ L., SANDERS D.  
2012 The Sail of the Swedish Merchantman *Jeanne-Elisabeth*, Wrecked off Montpellier, France, in 1755, *IJNA* 41.1, p. 67-83.
- BLACK E.  
1996 Where have all the sails gone? in H. Tzalas (ed), *Tropis IV, Proceedings of the 4<sup>th</sup> International symposium on ship construction in antiquity, Athens 1991*, Athens, Hellenic Institute for the Preservation of Nautical Tradition, p. 103-112.
- COOKE B., CHRISTIANSEN C., HAMMARLUND L.  
2002 Viking woollen square-sails and fabric cover factor, *IJNA* 31.2, p. 202-210.
- GUYON M.  
Forthcoming Lyon Saint-Georges 4: entretien d'un chaland gallo-romain du II<sup>e</sup> siècle après J.-C., in *Rencontres internationales Instrumentum. Les modes de transports dans l'Antiquité et au Moyen-Âge. Mobiliers d'équipement et d'entretien des véhicules terrestres, fluviaux et maritimes, Arles 2017*.
- HANDLEY F. J. L.  
2011 Textiles: a preliminary report, in D. Peacock, L. Blue (eds), *Myos Hormos – Quseir-al-Qadim, Roman and Islamic Ports on the Red Sea. Volume 2: Finds from the excavations 1999-2003*, Oxford, BAR Int. Series 2286, p. 321-334.
- MARLIER S. (DIR.)  
2014 *Arles-Rhône 3, un chaland gallo-romain du I<sup>er</sup> siècle après Jésus-Christ*, Paris, CNRS Editions, Archaeonautica 18.
- MÉDARD F.  
2009 *Les tissus du Parc Saint-Georges (Lyon, 5<sup>e</sup> arrondissement), I-III<sup>e</sup> siècles de notre ère*, Rapport d'analyse, unpublished.  
2010a *Les tissus du Parc Saint-Georges (Lyon, 5<sup>e</sup> arrondissement), I-III<sup>e</sup> siècles de notre ère*, Rapport d'analyse des fibres, unpublished.  
2010b Les tissus associés à la construction des chalands gallo-romains du Parc Saint-Georges (Lyon), I<sup>er</sup>-III<sup>e</sup> siècles ap. J.-C, in E. Rieth (dir.), *Les épaves de Saint-Georges. Lyon – I<sup>er</sup>-XVIII<sup>e</sup> siècles*, Paris, CNRS Editions, Archaeonautica 16, p. 136-146.  
2013 *Les tissus associés à la construction du chaland Arles-Rhône 3 : qualité et gestion de la matière première*, Rapport d'analyse, unpublished.
- 2014 Les tissus associés à la construction du chaland Arles-Rhône 3 : qualité et gestion de la matière première, in S. Marlier (dir.), p. 116-125.
- 2018 *Fiches d'intervention sur les tissus des calfats 10 et 39 de Lyon Saint-Georges 4*, unpublished.
- MEUNIER L.  
2018 *Histoire des techniques d'étanchéification des bateaux fluviaux à coque en bois à l'époque romaine en Europe*, Master's Degree in History of Technology, Université de Paris I, Panthéon-Sorbonne, unpublished.
- MEUNIER L., GUYON M.  
Forthcoming Caulking textiles from the Lyon Saint-Georges 4's shipwreck: recording and conservation questions, in *Proceedings of the 14<sup>th</sup> ICOM-CC Group on Wet Organic Archaeological Materials Conference, Southampton 2019*.
- PLANTEC M.  
2010 *Cinq ensembles de tissus gallo-romains de calfatage*, dossier de conservation-restauration, unpublished.
- POMEY P., POVEDA P.  
2017 The Prôtis Project: the *Gyptis* sailing trials, in J. Litwin, *Baltic and Beyond. Change and continuity in shipbuilding, Proceedings of the 14<sup>th</sup> International Symposium on Boat and Ship Archaeology, Gdansk 2015*, Gdansk, National Maritime Museum, p. 229-236.
- RIETH E., GUYON M.  
2010 Epave EP. 4, in E. Rieth (dir.), *Les épaves de Saint-Georges. Lyon – I<sup>er</sup>-XVIII<sup>e</sup> siècles*, Paris, CNRS Editions, Archaeonautica 16, p. 73-82.
- ROUGÉ, J.  
1987 La momie contenait-elle les fragments d'une voile? *Nouvelles Archives du Museum d'Histoire Naturelle de Lyon* 25, p. 91-96.
- SCHOEFER M., COTTA D., BEENTJES A.,  
1987 Les étoffes de rembourrage: du chiffon au vêtement et à la voile de bateau, *Nouvelles Archives du Museum d'Histoire Naturelle de Lyon* 25, p. 77-80.
- SCHOEFER M.  
2004 *Textiles issus des fouilles des berges de la Saône, Saint-Georges, Lyon – 2003*, Rapport d'observations, unpublished, Musée des Tissus de Lyon.

- TCHERNIA A., POMEY P., HESNARD A.  
1978 *L'épave romaine de la Madrague de Giens (Var)*, Paris, CNRS  
Editions XXXIV<sup>e</sup> supplément à Gallia.
- UCELLI G.  
1950 *Le Navi di Nemi*, Rome, Libreria dello Stato.
- WILD, F. C., WILD, J. P.  
2001 Sails from the Roman Port of Berenike, *IJNA* 30.2, p. 211–220.
- WHITEWRIGHT J.  
2007 Roman Rigging Material from the Red Sea Port of Myos  
Hormos, *IJNA* 36.2, p. 282–292.



# A ROMAN BARGE FROM THE KUPA RIVER AT KAMENSKO, CROATIA: EVIDENCE OF A REGIONAL SHIPBUILDING TRADITION OF THE DANUBE RIVER BASIN IN SOUTHEASTERN EUROPE

Giulia BOETTO, Anton DIVIĆ and Krunoslav ZUBČIĆ

---

## Abstract

The Kamensko barge is a flat-bottomed fluvial vessel dated between the 1<sup>st</sup> century BC and the 3<sup>rd</sup> century AD. Its remains lie on the riverbed of the Kupa next to the town of Karlovac in Croatia. Constructed mostly from oak on the principles of bottom-based construction, it is 2 m wide and preserved to a length of 12 m. On its last journey it was transporting a cargo of several hundred bricks. Its interesting structural features suggest a kinship with other Roman-era shipwrecks from the Danube hydrographical basin.

## Keywords

Bottom-based construction, fluvial navigation, fluvial landscape, Pannonia, flat-bottomed barge

## Résumé

L'épave de Kamensko est un chaland fluvial à fond plat daté entre le 1<sup>er</sup> siècle av. J.-C. et le III<sup>e</sup> siècle apr. J.-C. Ses vestiges ont été découverts dans le lit de la rivière Kupa non loin de la ville de Karlovac en Croatie. Construit principalement en chêne selon les principes de la construction sur sole, il mesure 2 m de large et est conservé sur une longueur de 12 m. Lors de son dernier voyage, il transportait une cargaison de plusieurs centaines de briques. Ses caractéristiques structurelles intéressantes suggèrent une parenté avec d'autres épaves d'époque romaine trouvées dans le bassin hydrographique du Danube.

## Mots clés

Construction sur sole, navigation fluviale, paysage fluvial, Pannonie, chaland à fond plat

---

The riverbed of the Kupa, next to the village of Kamensko in Croatia, holds the remains of a sunken Roman-era river barge, well preserved under the cargo of bricks it was transporting.

Discovered in 2009 and briefly excavated from 2011 to 2014, the shipwreck has been systematically researched between 2015 and 2018 by a team from the Croatian Conservation Institute and the Centre Camille Jullian, making Kamensko the first riverine shipwreck to be systematically investigated in Croatia. This article will present the most interesting results of the project and attempt to place the Kamensko barge within the shipbuilding traditions of the Danube River hydrographical basin.

## 1. GEOGRAPHICAL AND HISTORICAL CONTEXT

The Kupa River, referred to as *Colapis* by a number of ancient sources, is a tributary of the Sava River and belongs to the Danube hydrographical basin. It is just under 300 km long, which makes it the third longest river in Croatia, but the longest whose source and confluence are both located within the country. Functioning as an important waterway on a strategic position between Pannonia and the Mediterranean, as well as

between the Italian peninsula and the Balkans, this river today represents a very interesting, although little studied, fluvial landscape with great archaeological potential (Divić 2016; Divić *et al.* forthcoming).

The village of Kamensko is located on the far southwestern edge of the Pannonian Basin. It is positioned on the right bank of the Kupa, 5 km east of the town of Karlovac, on the closest navigable section of the Kupa to the Adriatic Sea, a mere 70 km as the crow flies through the mountainous region of Gorski Kotar (fig. 1).

Traces of a Bronze and Iron Age settlement (Azinović Bebek 2006, 2007), as well as a Roman one dated between the 2<sup>nd</sup> and 4<sup>th</sup> centuries AD (Perkić 2005, p. 19), have been located in the vicinity of Kamensko. These sites might have functioned in relation with the Kupa River as was the case for the city of Karlovac. Founded *ex nihilo* in the 16<sup>th</sup> century, on a spot where the Kupa receives the Korana, Mrežnica and Dobra Rivers, Karlovac took advantage of its strategic position within an exceptional riverine network and rose to the status of a wealthy river port during the 18<sup>th</sup> and 19<sup>th</sup> centuries (Zatezalo 1970).

Kamensko is also located around 60 km west of the modern-day town of Sisak, the Roman settlement of *Siscia* that was founded around 35 BC after the conquest and destruction



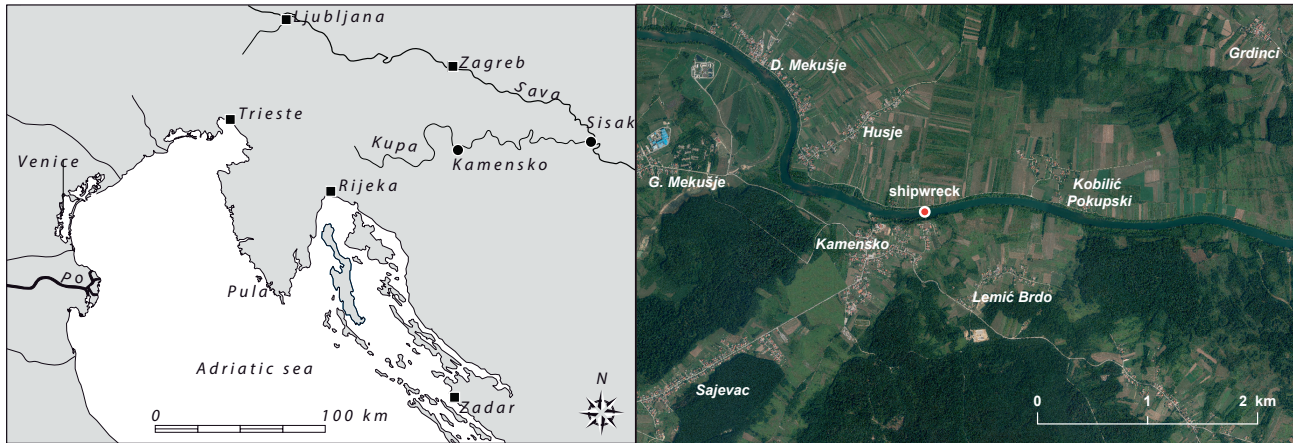


Fig. 1: Location of the Kamensko shipwreck on the Kupa River (G. Boetto, V. Dumas, AMU, CNRS, CCJ).

of the Celto-Illyrian settlement and river port, *Segestica*, by the future emperor Octavian. The newly established settlement thrived due to its exceptional position on the confluence of the Kupa and Sava Rivers, subsequently reaching the status of a colony. Settled by veterans from the Fleets of Misenum and Ravenna (Zaninović 1993), the colony became the capital of *Pannonia Savia* under Emperor Diocletian. Based on a brief mention in the 5<sup>th</sup> century AD *Notitia Dignitatum* (Occ. XXXII, 56), it can be considered as a naval base for a part of the Roman Pannonian fleet, *Classis Pannonica* (Rummel 2008, p. 72). Its nautical importance is also attested by numerous archaeological finds from the river. These include a great number of random artefacts recovered during dredging operations in the 19<sup>th</sup> and 20<sup>th</sup> centuries, remains of loading platforms, a number of dugouts, as well as the remains of a flat-bottomed river barge (Šarić 1986; Durman 1992, p. 120; Lolić 2003, p. 137-138; Gaspari *et al.* 2006; Radić Rossi 2009, p. 138; Vukelić, Radman-Livaja 2012; Zubčić 2015; Drnić 2018).

## 2. FROM DISCOVERY TO SYSTEMATIC RESEARCH

The village of Kobilic Pokupski, situated on the left bank of the Kupa opposite Kamensko, has been known to archaeologists for decades due to the numerous fragments of bronze sculpture that have been extracted from the riverbed of the Kupa by sand dredgers. These irregular pieces of roughly broken, monumental Roman sculpture made up a cargo transported by the river, most likely towards the *Siscia* foundries in order to be recycled. Extracted from the riverbed as early as 1913 and on towards the end of 20<sup>th</sup> century, the fragments were generally sold to collectors or in nearby Karlovac as scrap metal, with only 89 pieces remaining preserved until today in Karlovac City Museum (Šarić 1985).

In an attempt to locate this endangered ‘bronze shipwreck’, co-author Krunoslav Zubčić launched a systematic prospection campaign in 2007. Although no bronze fragments were ever located, the 2009 survey led to the discovery of a mound of bricks at a depth of approximately 5 m that was identified as the cargo of a Roman-era river barge. Its importance immediately asserted, the discovery was followed by several short annual research campaigns (Zubčić 2010; 2014) and by four systematic

excavations as part of a Franco-Croatian research project (Boetto 2015, p. 68-82; 2016, p. 16-28; 2017, p. 23-32; 2018, p. 13-21)<sup>1</sup>.

## 3. THE WRECK SITE

The wreck of the barge is 2 m wide and preserved to a length of 12 m, following an approximate east/west orientation according to the course of the river. It is located some 30 m from the right bank of the Kupa River (fig. 2).

The longitudinal layout of the wreck does not follow the flat morphology of the surrounding riverbed. Its upstream extremity, identified as the prow, has remained relatively well preserved due to the fact it lies at a lower level than its downstream counterpart and was fully covered by sediment consisting of sand, silt and small pebbles. The downstream extremity protrudes from the sediment and was most likely destroyed by the river flow or sand dredgers due to its greater exposure.

Transversally, the wreck leans northwards, its starboard bilge strake lying at a deeper level than the port bilge strake. Due to the fact that it was fully covered by sediment and the brick cargo, the starboard bilge strake has remained preserved almost to its original height (fig. 2).

## 4. THE BRICK CARGO

On its last journey the Kamensko barge was transporting a cargo of several hundred bricks, on average 43.8 cm long, 5.6 cm thick and 31 cm wide, whose standardised units of measurement classify them as *Lydion* (Brodrigg 1987, p. 3, 37).

1. The project has been supported by the Ministry of Culture of the Republic of Croatia, the French Ministry of Europe and Foreign Affairs through its archaeological programme ‘ADRIBOATS’, the INSHS of the CNRS, and Aix-Marseille University/Ecole française de Rome through two PhD programmes under the direction of G. Boetto – one focused on the fluvial landscape of the Kupa River (A. Divić) and the second on the study of the wood for ship construction (A. Ferreira Dominguez).

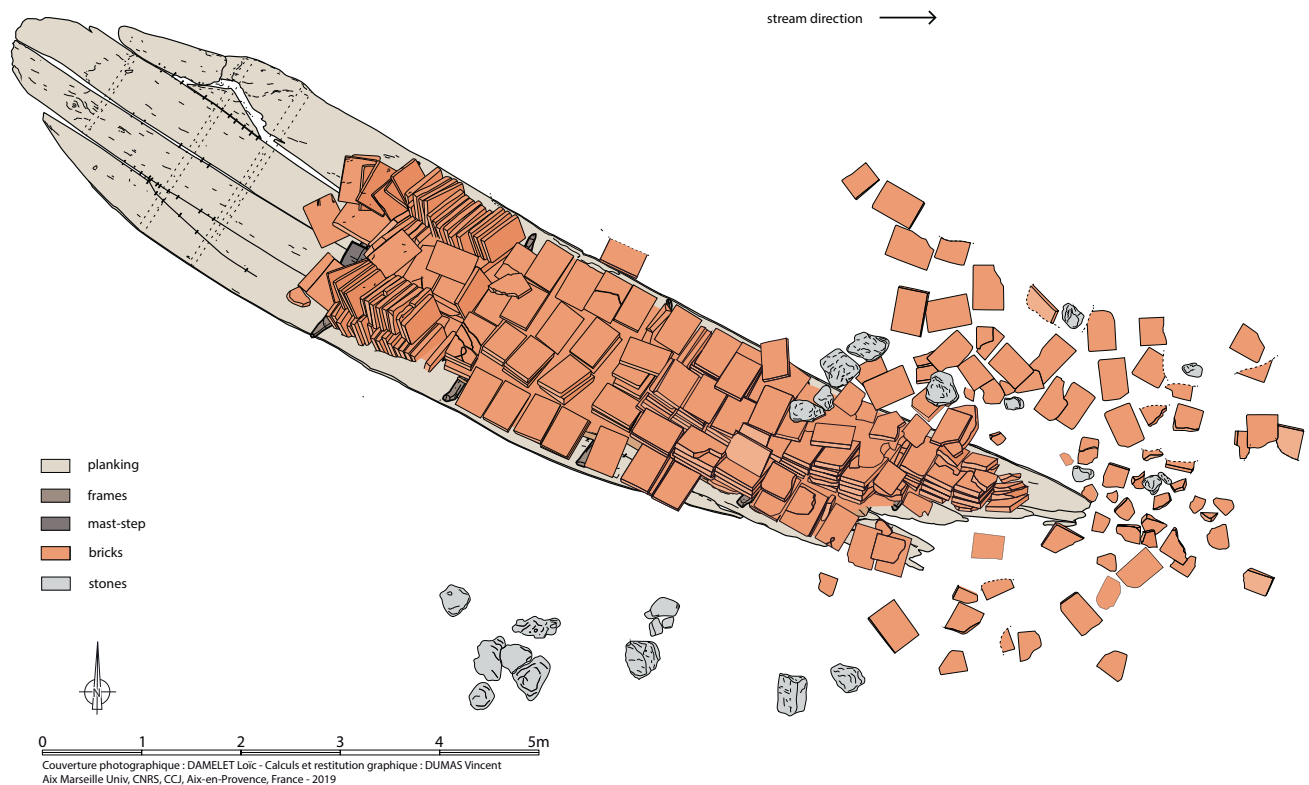


Fig. 2: The shipwreck with its cargo of bricks (V. Dumas, AMU, CNRS, CCJ).

The bricks, stacked in columns and arranged in rows, were settled on a support made out of branches and small tree trunks arranged longitudinally on top of the frames. This dunnage, used for preventing any damage both to the hull and the cargo, might have been sold or used as firewood after the unloading of the brick cargo (fig. 3).

We can estimate that the Kamensko barge was transporting a cargo of some 600 bricks, which would, with an average weight of 11 kg per brick, allow us to estimate the minimum tonnage of the vessel at 6 tons. More precise data will be gathered after the completion of the reconstruction of the original hull shape and structure.

A number of both unintentional and deliberate markings were noted impressed in the bricks. Unintentional ones include imprints of human feet, both barefoot and wearing hobnailed *caligae*, as well as dog paw prints. Although no epigraphic workshop stamps were found, more than 80% of the bricks bear an alpha-shaped symbol, impressed on the short sides of the bricks before firing. In one instance the alpha is accompanied by a cross-shaped symbol, possibly the Roman numeral X, while on another brick a total of three alphas appear. Three bricks bear marks of a semicircle while on one brick the underlined Roman numeral CCXLI is visible.

It seems likely that all the aforementioned markings can be placed in relation with the brick production process, being personal signatures, workshop marks, and ways for tracking the productivity of workers, as noted elsewhere on similar finds (Brodrigg 1979, p. 215; Matijašić 1986, p. 212). The bricks also bear witness to the homogeneity of the cargo, probably hailing from a single workshop that relied on the extensive local waterway network in order to distribute its product.

This assumption is confirmed by the discovery of the same alpha-shaped symbol, appearing on most of the bricks, inscribed with a burnt point into the port bilge strake of the barge, placing the cargo and the barge in a mutual relation.

## 5. THE STRUCTURE

The Kamensko river barge is a flat-bottomed vessel of a bottom-based construction (Hocker 2004; Pomey, Rieth 2005, p. 33, 195-198).



Fig. 3: View of the brick cargo lying on the dunnage. The northern side of the barge is preserved almost to its original height (L. Damelet, AMU, CNRS, CCJ).

The bottom is made out of two oak strakes, 36 cm wide and 6 cm thick on average. One strake is made out of a single plank (P2/11/13), while three planks compose the second strake (P3/7 assembled with an oblique scarf to P10, and P4/9) (fig. 4).

The two bottom strakes are inserted between the bilge strakes: P1/12/14 on the starboard side and P5/6/8 on the port side. These two bilge strakes, each cut from a single large oak trunk, as much as 1 m wide in diameter, constituted the sides as well as a part of the bottom of the barge (fig. 3). The starboard bilge strake can be continuously followed along a length of 11 m and, due to the northern inclination of the wreck, is preserved almost to its original height, which measures 60 cm. It is possible that the top of this bilge strake also represents the sheer of the barge, as there are no indications of any side planks being added. The port bilge strake, broken just after the turn of the bilge due to its greater exposure, presents two long oblique repairs, one forward of the frame F11S, the other between F9S and F10S.

The strakes are assembled together by a great number of small metal clamps, driven across the seams at regular intervals both from the inside and the outside of the hull (fig. 5). Up to 4-5 cm long and around 1 cm wide, they have been inserted in already prepared notches. The same assembly system was used for repairing the cracks that occurred in the port bilge strake.

A sample of the eastern extremity lifted in 2018, composed of a part of the starboard bilge strake P1/12/14 and its adjoined bottom strake P2/11/13, allowed us to confirm the presence of the clamps on the external part of the barge as well, where they have been driven in shorter intervals (between 8.5 and 11 cm) than in the interior (between 11 and 15 cm)

Apart from holding the hull together, the metal clamps held in place a waterproofing material of vegetal origin, inserted in the form of braids or cords<sup>2</sup> in the seams between the planks, according to the principles of luting (fig. 5).

Five frames have been preserved and documented *in situ*, while the position of another two can be established in the prow due to the presence of treenails in the hull. The frames, 12 cm moulded and 8 cm sided, are made out of paired knees settled side by side, the starboard knee always placed forwards. They have been carved from already curved oak branches and attached to the hull by a limited number of faceted treenails (diam. 2 cm), 3 or 4 per knee. The frames themselves are very widely spaced, the room and space amidships being 1.5 m and somewhat decreasing towards the prow (fig. 4).

## 6. THE PROPULSION SYSTEM

On the western part of the wreck, towards the prow, the mast step of the barge was preserved under the brick cargo. It is made of oak, has a rectangular section 30 cm wide and 14 cm high, and is 182 cm long. It was settled longitudinally on the bottom planks between frames F10 and F11. Its extremities were cut in order to be settled onto these frames, to which it had been attached by two nails driven from the inside of the hull, one on each extremity (fig. 4).

In the middle, the timber has been carved with a recess 13.8 cm long, 11.7 cm wide and 11 cm deep. It is likely that this

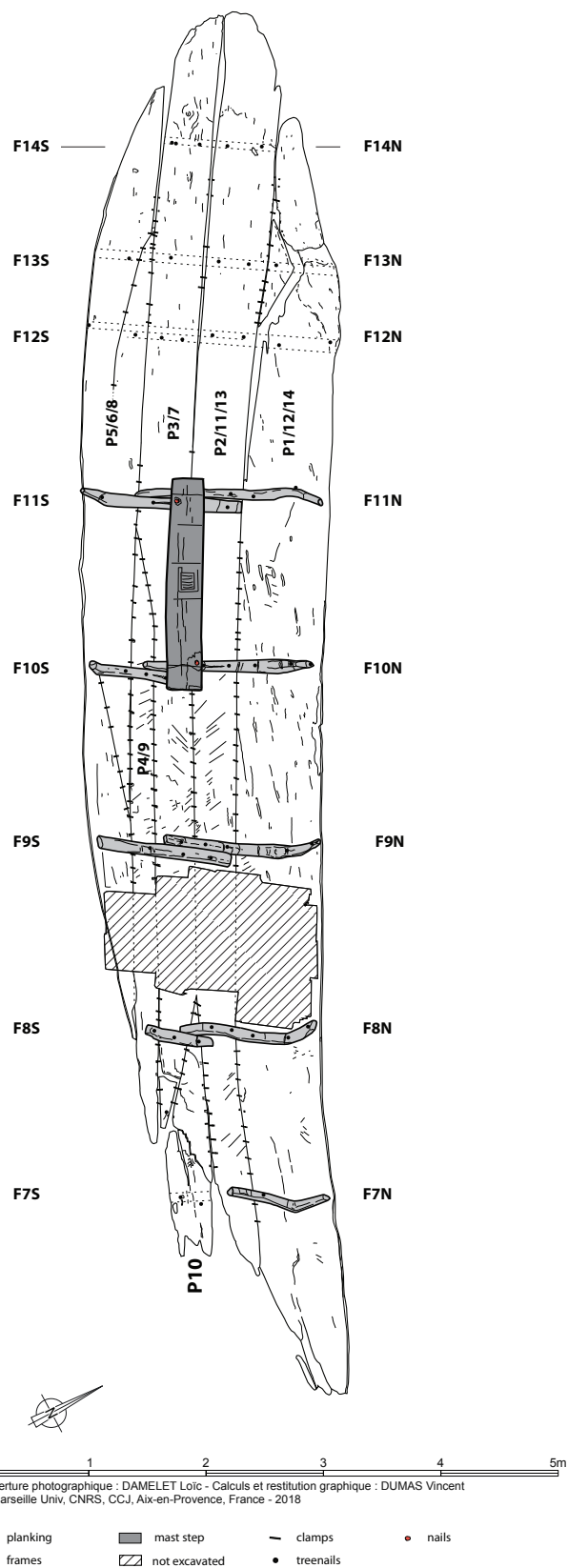
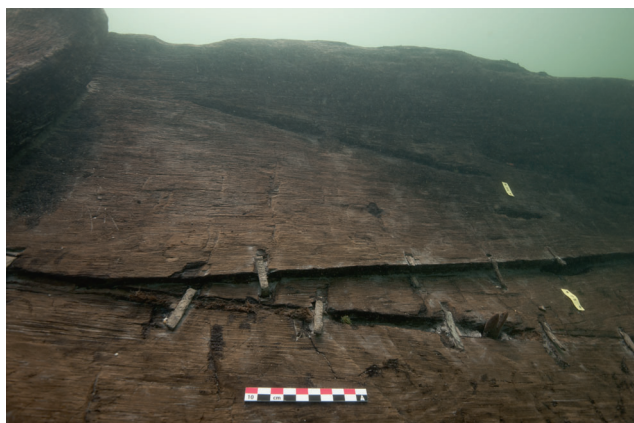


Fig. 4: Preserved structure of the barge (V. Dumas, AMU, CNRS, CCJ).

2. The analysis of this material is ongoing.





**Fig. 5:** View of the bottom of the barge with the clamps connecting the planks (L. Damelet, AMU, CNRS, CCJ).

mast step housed a towing mast used for hauling the barge upstream, a typical riverine system of propulsion attested in both Roman iconography and archaeological sources (Arnold 1992, p. 57, 84-85; de Izarra 1993, p. 123; Rieth 1998, p. 106-109; Marlier, Poveda 2014, p. 209-211). It is interesting to note that on the Kupa River the practice of towing vessels upstream by manpower, using prisoners or poor peasants named *burlaci*, survived until the 20<sup>th</sup> century although haulers were gradually replaced by animals from the second half of the 19<sup>th</sup> century onwards (Ott 2008, p. 68).

The presence of the mast step allows us to identify the western or upstream extremity as the prow of the barge. The fact that the brick cargo covered the mast step on the barge's last voyage allows us to propose the hypothesis that the barge was not being towed upstream, but was sailing downstream, in the direction of *Siscia*. The position of the shipwreck on the river bottom, therefore, does not necessarily indicate the sailing direction of the barge, as it might have rotated during the wrecking process.

## 7. DATING

In order to obtain an absolute date for the construction of the barge, two accelerator mass spectrometry (AMS) radiocarbon analyses were performed by the Vienna Environmental Research Accelerator (VERA) and by the Centre de Datation par le Radiocarbone in Lyon. The first sample (VERA-5732) yielded the calibrated date of 40 BC – 230 AD (95.4% probability) while the second (Lyon-14133-SacA49774) resulted in the calibrated date 82 – 234 AD (95.4% probability), placing the barge construction in a wide timespan between the middle of the 1<sup>st</sup> century BC and the first half of the 3<sup>rd</sup> century AD. A third AMS date (Lyon-14132-SacA49773) performed on an element of the dunnage (C6) yielded a similar date (117 – 252 AD, 91.5% probability).

## 8. CONCLUSION

The use of clamps for connecting the planking appears very sporadically in Roman fluvial shipbuilding, and is documented only in a few cases of repairs (Arnold 1992, p. 35). Clamps were never used as a principal joining element, except on a small group of relatively less-known river barges, all hailing from the middle section of the Danube hydrographical basin in Slovenia, Croatia and Serbia.

These are the vessels from Sinja Gorica, Sisak, and Kušjak (Erič *et al.* 2014; Gaspari *et al.* 2006; Bockius 2003), all three presenting a number of similar architectural characteristics to the Kamensko barge, although different in shape and dimensions. The vessels are flat-bottomed, bottom-based, with carved bilge strakes. Their strakes are assembled by numerous, small, metal clamps that also hold luting material of vegetal origin in the seams. The frames, except in the case of Sinja Gorica, are attached to the hull by wooden treenails, another uncommon element in Roman fluvial shipbuilding where nails were predominantly used (McGrail 1995, p. 140; Arnold 1992, p. 82, 98-99; 1998, p. 74; 1999).

Based on their architectural similarities, and affiliation with a certain time and a certain nautical transport zone, these vessels form a specific assembly belonging to one of the Roman fluvial shipbuilding traditions proper to the Danube hydrographical basin (Boetto, Rousse 2011, 2012; Boetto 2016b; Pomey, Boetto 2019, p. 6, 17-18).

The second shipbuilding tradition is represented by a large flat-bottomed barge from Lipe, discovered in the 19<sup>th</sup> century next to the Ljubljana River in Slovenia and dated between the 2<sup>nd</sup> century BC and the 1<sup>st</sup> century AD (see Gaspari in this volume). Its strakes were assembled by the sewing technique, a technological transfer from the northeastern Adriatic where this technique has been attested in shipbuilding from the Bronze Age and well into the Roman imperial era (Boetto, Rousse 2011, 2012; Boetto 2016b; Pomey, Boetto 2019, p. 17-18). It is possible that, within the Danube hydrographical basin, this Mediterranean technique evolved into the more cost- and time-effective assembly by metal clamps.

The technological and chronological relations between these two shipbuilding traditions of the Danube hydrographical basin and between the other inland shipbuilding traditions of continental Europe constitute important questions that could be clarified in the future by continued pursuit of systematic research in the Kupa River and, more generally, in the Danube hydrographical basin.

## ACKNOWLEDGMENTS

We would like to thank all the participants of the four excavation campaigns on the Kamensko shipwreck. In particular, we are indebted to Alba Ferreira Domínguez, who identified the wood species used in the barge construction, and Vincent Dumas, who prepared the graphic documentation for this contribution.



## REFERENCES

- ARNOLD B.  
 1992 *Batellerie gallo-romaine sur le lac de Neuchâtel*, Neuchâtel, Musée cantonal d'archéologie, tome 2, Archéologie neuchâtoise 13.  
 1998 Embarcations romano-celtiques et construction sur sole, in É. Rieth (ed.), *Concevoir et construire les navires. De la trière aux picoteaux*, Ramonville Saint-Agne, Editions Erès, p. 73-90.  
 1999 Some remarks on Romano-Celtic boat construction and Bronze Age wood technology, *IJNA* 28.1, p. 34-44.
- AZINOVIC BEBEK A.  
 2006 Kamensko – pavlinski samostan, *Hrvatski arheološki godišnjak* 2/2005, p. 183-184.  
 2007 Kamensko – pavlinski samostan, *Hrvatski arheološki godišnjak* 3/2006, p. 211-212.
- BOETTO G.  
 2015 *ADRIBOATS – Navires et navigation en Adriatique orientale dans l'Antiquité. Rapport des opérations 2015*, Aix-en-Provence, Centre Camille Jullian (unpublished report).  
 2016a *ADRIBOATS – Navires et navigation en Adriatique orientale dans l'Antiquité. Rapport des opérations 2016*, Aix-en-Provence, Centre Camille Jullian (unpublished report).  
 2016b Recherches d'archéologie navale en Adriatique orientale. *Comptes Rendus de l'Académie des Inscriptions et Belles-Lettres*, novembre-décembre, p. 1401-1422.  
 2017 *ADRIBOATS – Navires et navigation en Adriatique orientale dans l'Antiquité. Rapport des opérations 2017 & Opérations projetées en 2018*, Aix-en-Provence, Centre Camille Jullian (unpublished report).  
 2018 *ADRIBOATS – Navires et navigation en Adriatique orientale dans l'Antiquité. Rapport des opérations 2018 & Bilan du programme 2015-2018; Nouveau programme 2019-2022 & Opérations projetées en 2019*, Aix-en-Provence, Centre Camille Jullian (unpublished report).
- BOETTO G., ROUSSE C.  
 2011 Le chaland de Lipe (Ljubljana, Slovénie) et la tradition de construction «sur sole» de l'Europe sud-orientale : quelles influences méditerranéennes? in G. Boetto, P. Pomey, A. Tcherna (ed.), *Batellerie gallo-romaine. Pratiques régionales et influences maritimes méditerranéennes*, Paris/Aix-en-Provence, Errance/Centre Camille Jullian, Bibliothèque d'archéologie méditerranéenne et africaine 9, p. 179-191.  
 2012 Traditions régionales d'architecture navale en Adriatique à l'époque romaine, *Histria Antiqua* 21, p. 427-441.
- BRODRIBB G.  
 1979 Markings on Tile and Brick, in A. McWhirr (ed.), *Roman Brick and Tile: Studies in Manufacture, Distribution and Use in the Western Empire*, Oxford, British Archaeological Reports, BAR International Series 68, p. 211-220.  
 1987 *Roman Brick and Tile*, Gloucester, Alan Sutton Publishing.
- DIVIĆ, A.  
 2016 *A Roman barge from the river Kupa at Kamensko (Croatia); the preliminary study of its architecture in the context of southeast European bottom-based naval construction*, Aix-en-Provence, Aix-Marseille University (unpublished master's dissertation).
- DIVIĆ A., BOETTO G., ZUBČIĆ K.  
 Forthcoming The Kupa River (Croatia): A preliminary reconstruction of a fluvial landscape during antiquity, in L. Kröger (ed.), *Proceedings of the conference River valleys, river vessels, river harbours – Records from Antiquities and Medieval times, Jena 2018*.
- DRNIĆ I. (ED.)  
 2018 *Segestica and Siscia – From the periphery of the Empire to a provincial centre*, Zagreb, Archaeological Museum in Zagreb.
- DURMAN A.  
 1992 O geostrateškom položaju Siscije, *Opuscula archaeologica* 16, p. 117-131.
- ERIĆ M., GASPARI A., ČUFAR K., SOLINA F., VERBIĆ T.  
 2014 Zgodnjerimska ladja iz Ljubljane pri Sinji Gorici, *Arheološki vestnik* 65, p. 187-254.
- GASPARI A., ERIĆ M., ŠMALCELJ M.  
 2006 Roman river barge from Sisak (Siscia), Croatia, in L. Blue, F. Hocker, A. Englert (eds), *Connected by the sea, Proceedings of the Tenth International Symposium of Boat and Ship Archaeology (ISBSA 10), Roskilde 2003*, Oxford, Oxbow books, p. 284-289.
- HOCKER M. F.  
 2004 Bottom-based Shipbuilding in Northwestern Europe, in F. M. Hocker, C. A. Ward (eds), *The Philosophy of shipbuilding. Conceptual Approaches to the Study of Wooden ships*, College Station, Texas A&M. University Press, p. 65-93.
- IZARRA DE F.  
 1993 *Hommes et fleuves en Gaule romaine*, Paris, Errance.
- LOLIĆ T.  
 2003 *Colonia Flavia Siscia*, in M. Šašel Kos, P. Scherrer (eds), *The Autonomous Towns of Noricum and Pannonia / Die autonomen Städte in Noricum und Pannonien*, Ljubljana, Narodni muzej Slovenije, Situla 41, p. 131-152.
- MARLIER S., POVEDA P.  
 2014 Présentation et analyse du système mécanique, in S. Marlier (ed.), *Arles-Rhône 3. Un chaland gallo-romain du 1<sup>er</sup> siècle après Jésus-Christ*, Paris, CNRS editions, Archaeonautica 18, p. 209-216.
- MATIJAŠIĆ R.  
 1986 Lateres sisciensis, *Vjesnik Arheološkog muzeja u Zagrebu* 19, p. 203-215.
- MCGRAIL S.  
 1995 Romano-Celtic boats and ships: characteristic features, *IJNA* 24.2, p. 139-145.
- OTT I.  
 2008 *Karlovački leksikon*, Zagreb, Školska knjiga.
- PERKIĆ D.  
 2005 *Crkva Blažene Djevice Marije Snježne i Pavlinski samostan u Kamenskom: Elaborat sa zaštitnih arheoloških iskopavanja i istraživanja 1999-2002*, Karlovac (unpublished report).
- POMEY P., BOETTO G.  
 2019 Ancient Mediterranean Sewn-Boat Traditions, *IJNA* 48.1, p. 5-51.
- POMEY P., RIETH É.  
 2005 *L'archéologie navale*, Paris, Errance.
- RADIĆ ROSSI I.  
 2009 Dugouts of Croatia, in R. Bockius (ed.), *Between the Seas. Transfer and Exchange in Nautical Technology, Proceedings of the Eleventh International Symposium of Boat and Ship Archaeology (ISBSA 11), Mainz 2006*, Mainz, Verlag des römisch-germanischen Zentralmuseums, RGZM-Tagungen 3, p. 133-145.
- RIETH É.  
 1998 *Des bateaux et des fleuves. Archéologie de la batellerie du Néolithique aux Temps modernes en France*, Paris, Errance.

- RUMMEL C.  
2008 *The fleets on the northern frontier of the Roman empire from the 1<sup>st</sup> to 3<sup>rd</sup> century*, PhD thesis, Nottingham, University of Nottingham.
- ŠARIĆ I.  
1985 Rimski brončani materijal izvađen iz rijeke Kupe kod Karlovca, *Izdanja hrvatskog arheološkog društva* 10, p. 69-89.  
1986 Zaštitno arheološko istraživanje lokaliteta „Kovnica“ u Sisku 1985. godine, *Obavijesti Hrvatskog arheološkog društva* 18.1, p. 28-29.
- VUKELIĆ V., RADMAN-LIVAJA I.,  
2012 *Blago rijeke Kupe – Arheološka istraživanja Kupe kod Siska prije I. svjetskog rata*, Zagreb, Arheološki muzej u Zagrebu.
- ZANINOVIĆ M.  
1993 *Classis Flavia Pannonica, Izdanja Hrvatskog arheološkog društva* 16, p. 54-58.
- ZATEZALO Đ.  
1970 Kupa kao plovni put u XVIII. i XIX. stoljeću, in Zatezalo Đ. (ed.), *Karlovac, radovi i građa iz dalje i bliže prošlosti*, Karlovac, Historijski arhiv u Karlovcu, Zbornik 2, p. 7-104.
- ZUBČIĆ K.  
2010 Rijeka Kupa – antički brodolom, *Hrvatski arheološki godišnjak* 6/2009, p. 308-310.  
2014 Rijeka Kupa – antički brodolom. *Hrvatski arheološki godišnjak* 10/2013, p. 301-302.  
2015 *Izvještaj o izvedenim radovima tijekom arheološkog rekognosciranja i istraživanja rijeke Kupe u Sisku*, Zagreb, Zagreb, Hrvasti restauratorski zavod (unpublished report).



# SHIPS AND BOATS OF LATE PREHISTORIC AND ROMAN NAUPORTUS. NEW EVIDENCE AND SOME REMARKS ON THE TRANSFER AND INNOVATION IN THE SHIPBUILDING TECHNOLOGIES ON THE NORTHERN FRINGES OF THE MEDITERRANEAN 2<sup>ND</sup> CENTURY BC – 1<sup>ST</sup> CENTURY AD

Andrej GASPARI

---

## Abstract

This paper discusses the archaeological evidence regarding the unique navigational environment of the *Ljubljansko barje* (Ljubljana Marshes) in the 2<sup>nd</sup>-1<sup>st</sup> centuries BC. The evidence consists of the renowned and almost completely preserved flat-bottomed boat of sewn construction from Lipe (1890), the newly discovered sewn boat of a presumably similar size and technology from the Ljubljanica River at Vrhnika (2015), and the very large oak logboat also from Vrhnika featuring complex repairs and other unusual technical solutions. The construction details of all three watercraft originate in Mediterranean shipbuilding practices, but arguably lean on local tradition embedded in the broader socio-cultural environment of the pre-Roman populations of the northern Adriatic and its immediate hinterland.

## Keywords

Adriatic shipbuilding tradition, Early Roman Period, inland navigation, Late Iron Age, Ljubljana Marshes, sewn boats

## Résumé

Cet article propose un examen des témoignages archéologiques concernant l'espace de navigation unique constitué par le Ljubljansko barje (marais de Ljubljana) aux II<sup>e</sup>-I<sup>er</sup> siècles av. J.-C. (fig. 1). Les principales découvertes sont : le bateau cousu à fond plat de Lipe, presque entièrement conservé (1890); un second bateau cousu, de taille et de construction similaire à la barge de Lipe, récemment découvert (2015) dans la rivière Ljubljanica à Vrhnika; et enfin la très grande pirogue monoxyle en chêne découverte elle aussi à Vrhnika, qui présente des réparations complexes et d'autres solutions techniques inhabituelles. Les techniques de construction des trois embarcations nous semblent issues de pratiques méditerranéennes, mais s'appuient sans doute sur la tradition locale ancrée dans l'environnement socioculturel plus large des populations pré-romaines du nord de l'Adriatique et de son arrière-pays immédiat.

## Mots clés

Tradition de la construction navale de l'Adriatique, période romaine, navigation intérieure, second Âge du fer, marais de Ljubljana, bateaux cousus

---

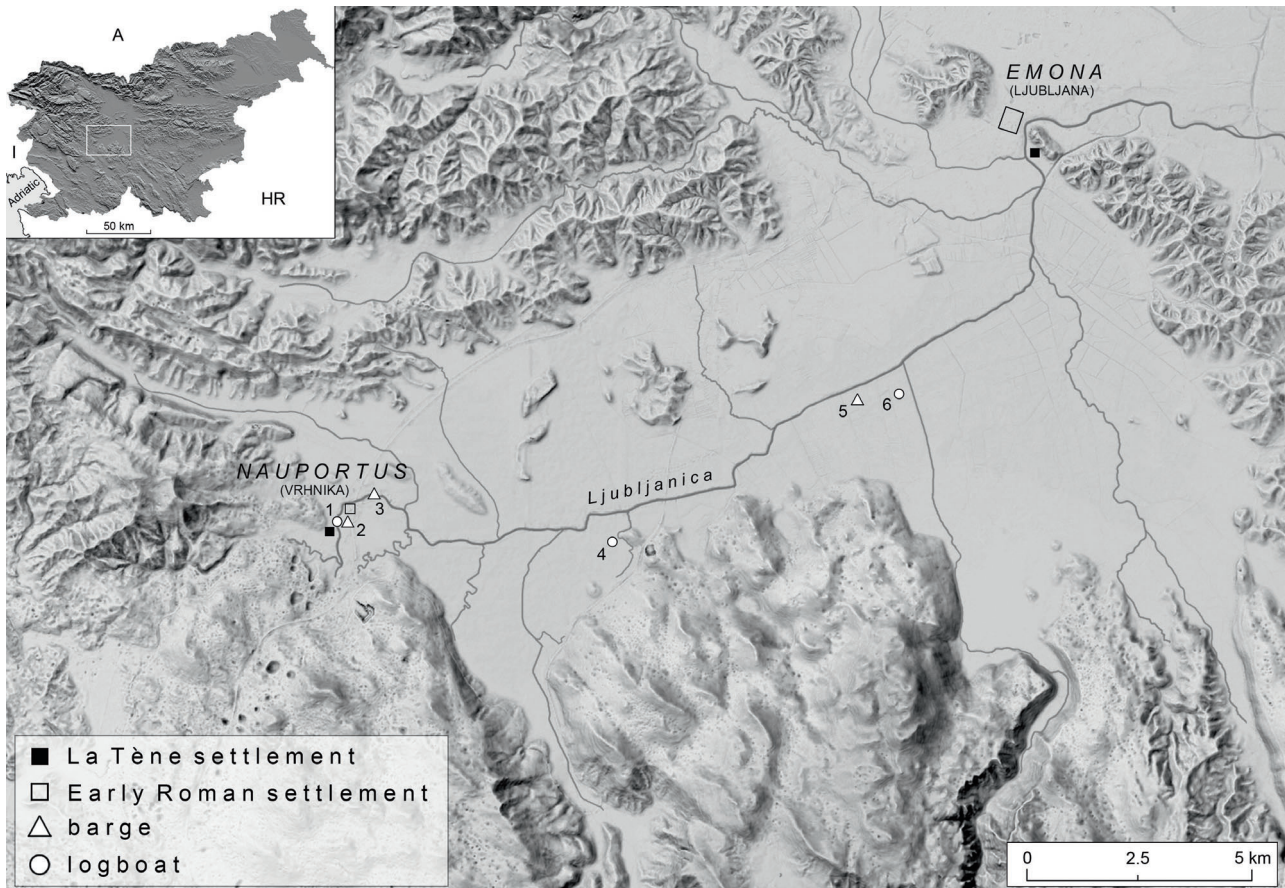
Since the discovery of the famous Ljubljana (Lipe) cargo ship of sewn construction (1890), other important remains of large capacity watercraft have come to light in the area of the *Ljubljansko barje* (Ljubljana Marshes, central Slovenia), particularly in the Ljubljanica River at ancient Nauportus (present-day Vrhnika) (fig. 1). These offer physical evidence of the writings of the ancient Greek geographer Strabo (*Geography* 4, 6, 1; 7, 5, 2) who records large-scale waterborne cargo traffic between the Latin colony of Aquileia, on the one side, and the Transalpine Celts in the hinterland of the northern Adriatic and the peoples of the Danubian provinces on the other (Šašel Kos 1990, p. 17-21, 143-148).

This paper focuses on the results of an underwater salvage excavation in the Ljubljanica riverbed at Vrhnika, conducted in 2015. These revealed a highly interesting cluster of finds from

the late 2<sup>nd</sup> to the first half of the 1<sup>st</sup> century BC (Gaspari *et al.* 2017). The cluster is most probably associated with the presumed cargo and reloading post of pre-Roman Nauportus. It consists of a large capacity oak logboat, the wreck of a roughly contemporary sewn cargo ship and the skeletal remains of an adult woman from the early 1<sup>st</sup> century BC lodged in the sediments directly under the logboat (fig. 2).

Geoarchaeological investigations at the site have indicated that in comparison to the present the riverbed was broader in this section during the Iron Age. They have also shown that the archaeological context was formed in the sandy sediments of the gently inclined underwater slope along the right bank. The logboat, which the lateral shift of the channel caused to break into three parts, was obviously abandoned here. It was





**Fig. 1:** Sites of archaeological evidence mentioned in the text. 1 – Vrhnika (logboat); 2 – Vrhnika (sewn boat); 3 – Sinja Gorica (barge); 4 – Zakotek (logboat with repairs executed by iron clamps); 5 – Lipe (“Ljubljana” sewn boat); 6 – Črna vas (logboat with iron clamp) (prepared by the author).

intentionally immersed complete, in a functional state. As for the sewn boat, the initial investigation provided no solid evidence as to why it ended up on the bottom of the river. Further objects related to shipbuilding activities lay exposed on the river bottom, including a board with an unlocked mortise-and-tenon joint (radiocarbon dated to the 3<sup>rd</sup>-2<sup>nd</sup> century BC) and a large number of iron clamps. A significant part of the latter might be understood as the remnants of post-Roman shipping, since the harbour of medieval and early post-medieval Vrhnika (*Oberlaibach* in German) occupied more or less the same area as the presumed pre-Roman reloading and toll station, with piers and associated facilities, platforms and shipyards.

At the end of the investigations, the logboat was lifted and transported to conservation facilities, and the detached wooden elements were collected, while the sewn boat remains were left *in situ*.

## 1. BOATS FROM THE LJUBLJANICA RIVER IN THE AREA OF PRE- AND EARLY ROMAN NAUPORTUS

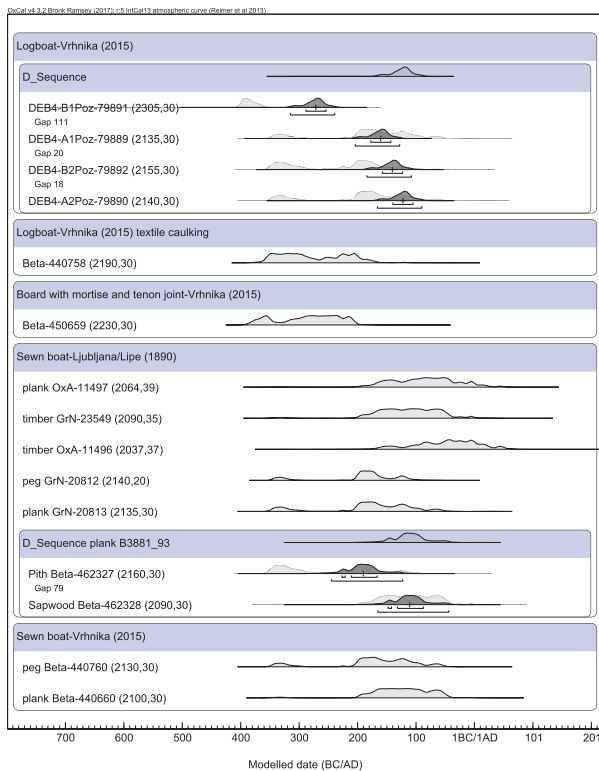
### 1.1. LOGBOAT

The logboat is one of the largest known late prehistoric and Roman examples of this type of watercraft. It originally

measured approximately 14.4 m in length, 1.25 m in beam and 0.68 m in depth. It was made of a roughly 200 year-old oak tree (*Quercus* sp.), with the lower part of the trunk used for the bow (Gaspari *et al.* 2017). The characteristic sections have rounded sides and a flat bottom, on both the inner and outer surfaces. The more probable of the two possible displacement situations calculated from the reconstructed lines and sections of the boat with a light weight at around 1.5 tonnes in a partly saturated condition and with a cargo space volume of around 6 m<sup>3</sup> shows a total load capacity of around 2 tonnes at a still safe draught, retaining 20 cm of freeboard. Considering the asymmetric shape with the centre of gravity in the front part and a protrusive stern, the logboat was probably powered by paddle and/or punt, and, if necessary, by towing from the bank.

In addition to its large size and capacity, the logboat also stands out in its technological features. There are control perforations, but even more particular is the substantial use of iron clamps and fittings, wooden treenails, plugs, patches and boards, as well as resin-soaked woollen cloth for repairing cracks and extensive luting of the replaced parts.

The bottom of the boat has two openings along the mid-axis. The one towards the stern is perfectly round, with a diameter of 12 cm and oblique walls accommodating a conical plug secured with an iron clamp. The other opening, located between the first and second thirds of the boat’s length (fig. 3), is of a more complex design. A large oval patch board with truncated ends and a stepped section closes the opening and was lined with



**Fig. 2:** Probability distributions of the radiometric dates of the 2<sup>nd</sup>-1<sup>st</sup> century BC ships and boats from the Ljubljansko barje (compiled by the author).

cloth previously soaked in resin. The cloth was held in place with two cylindrical treenails reaching through the main trunk and secured with three iron clamps from the inside and two more from the outside. The function of the openings is debatable. The larger one, without any signs of subsequent removal of the board, probably replaced a weakened part of the bottom at a knot, while the round one at the rear may have served for discharging bilge water and/or facilitating immersion for storage, though it may also have been conceived as a lock, preventing the theft of the craft (see Medas 1994, p. 35).

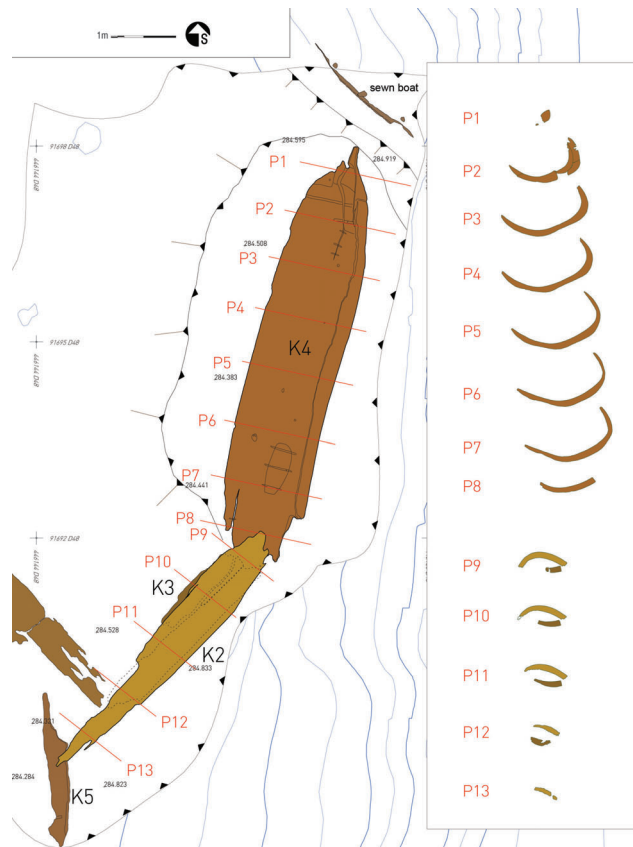
The replacement of the bow section is particularly interesting: the original was probably weakened due to the growth pattern of the root part of the trunk. It was replaced with a perfectly fitting block cut from the same trunk, indicating that the intervention took place in the initial phase of the logboat construction. Similar to the design of the above-mentioned board, the surface of the main trunk was caulked with large resin-soaked cloths before installing the substitute part that was subsequently attached with cylindrical treenails fitted in the pre-prepared recesses in the corresponding parts of the bow. The final stage of repair consisted of fastening the protruding extension of the prow by adding a band-shaped clamp and securing the cracked areas of the main trunk with nailed fittings and additional clamps. The textile used for waterproofing was made in plain weave technique (tabby y/y) from Z-twisted wool yarn, corresponding to the technique of the tablet woven textiles from the Middle and Late La Tène sites in central Europe, as well as textiles from pre-Roman and Roman contexts in the eastern Po Plain.

A singular feature is a forged iron nail with a hemispherical head that resembles the rivets of the roughly contemporary

(second half of the 2<sup>nd</sup>-early 1<sup>st</sup> century BC) Celtic shield bosses, both those with a rectangular flange and a barrel-shaped dome and those of the Mokronog-Arqua type, with a main distribution area between the central Transpadana and southeastern Alpine regions.

Luting with cloth soaked in a natural resin is typical of ancient Mediterranean shipbuilding, which supposedly also influenced such practice in the Roman-era vessels of the Rhône basin (Médard 2011). While joining with coaks/treenails is a very old technological solution, known at least as early as the Late Stone Age in continental and Atlantic Europe, the extensive use of iron clamps may indicate a local, Celtic tradition. It became more widespread later on with the use of numerous small iron clamps in the shipbuilding process of the Early Roman Period. Both large holes along the logboat's central axis are similar to those in two presumably Roman logboats from the Po Delta (Berti 1987, p. 20, 23, figs 6 and 12). Together with other details, this would indicate an exchange of technological knowledge within the northern Adriatic region.

Found next to the logboat towards the middle of the riverbed was an oak board with the remains of an iron clamp, two repairs of cracks with resin-soaked textile and the remains of an unpegged mortise-and-tenon joint. Radiometric measurements have shown it to be earlier than the logboat (fig. 2), but the board may nevertheless represent the repair of one of the sides at the stern: we may verify this when physically comparing the pieces after the completion of the logboat's conservation.



**Fig. 3:** Vrhnik; Ground plan and cross sections of the parts belonging to the logboat and the sewn ship (prepared by D. Badovinac).



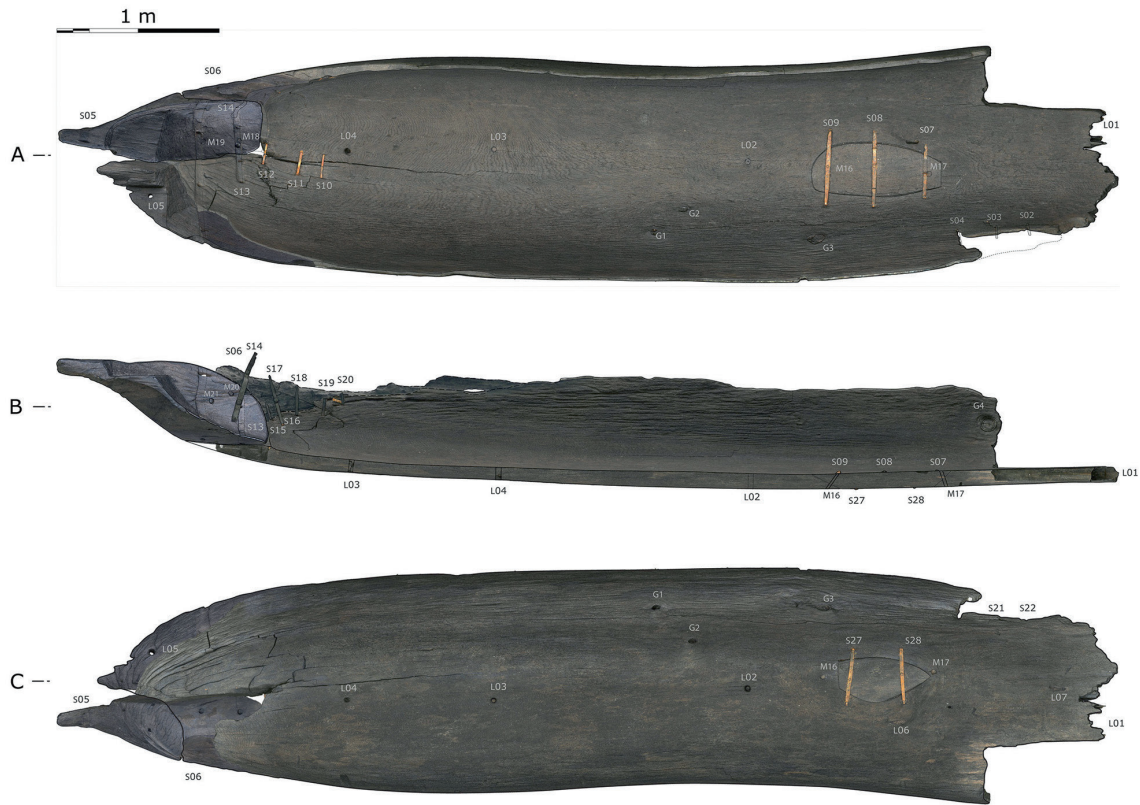


Fig. 4: The Vrhnika logboat; orthomosaic of the bow section (prepared by D. Badovinac).

## 1.2. SEWN BOAT

The upper part of a wreck's side was discovered just north of the logboat's bow at the foot of the riverbank. The research of the wreck was limited to preliminary documentation of the exposed top section, situated diagonally to the riverbed (Gaspari *et al.* 2017, p. 85-87). A 2.15 m-long part of the side planking and frames was recorded (fig. 3). The boat end protruding from the bank was destroyed through post-depositional processes and the condition of the part embedded in the bank is unknown. The topmost of the surviving planks is 3 cm thick: its original width is unknown. It is presumably made of conifer wood and bears obliquely drilled sewing holes in intervals of 7-8 cm, approaching the prevalent values of 7.5-8.5 (some reaching up to 10) cm recorded on the Ljubljana (Lipe) boat (see below). The direction of the holes corresponds with the logic of minimised rope exposure on the external surface of the planking. Ropes for sewing and rolls of wadding placed on the plank joints were made of undetermined plant material, while the small pegs for blocking the rope and its reinforcement were made of yew wood (*Taxus baccata*). The surviving upper part of the central rib (of the three exposed) bears a semicircular notch (crenulation) in the axis of the wadding at plank joints. The ribs and cylindrical treenails for attaching the frame elements to the planking were made of oak (*Quercus* sp.). The upper parts of ribs measured 8 x 8 cm in section and were placed 0.6 m apart, measured from centre to centre, again resembling the framing interval values on the Ljubljana (Lipe) boat. The dimensions of particular elements and the observed constructional features indicate that the newly discovered remains belong to a large barge. It has been radiocarbon dated to the 2<sup>nd</sup> century BC (fig. 2).

## 2. THE LJUBLJANA (LIPE) SEWN BOAT: SURVIVING EVIDENCE, RADIOCARBON AGE AND REMARKS ON THE LESSER-KNOWN TECHNOLOGICAL SIGNATURES

Upon its accidental discovery in October 1890, the barge from Lipe was almost completely preserved. The excavation and documentation of the approximately 30 m long, 4.8 m wide and 0.6 m high boat followed the next spring. It was conducted by Alfons Müllner, curator at the Provincial Museum of Carniola in Ljubljana (*Laibach* in German) and his team. They removed two sections to preserve at least a partial insight into the vessel's construction (Müllner 1892). As the successor institution, the National Museum of Slovenia presently holds 110 wooden elements, 20 iron nails (all reproduced in drawings in Karinja 1998), field drawings (technical ground plan with one general section and several sections of details, a more 'artistic' plan of a less informative value), two photographs (one taken shortly after discovery and the other before the conclusion of the fieldwork in April 1891) and a model of the ship in the scale of 1:10 (fig. 5). The model was skilfully executed by Karol Binder, museum carpenter, based on his own measurements of the remains *in situ* (Gaspari 1998a, 1998b). Müllner also provided a detailed description, which includes expert identification of the wood and plant species used in the construction. His study far exceeds the average quality of publications in his day, but does leave some constructional issues unanswered. One of the most intriguing questions, the date of the boat, long remained unclear despite a series of radiometric measurements. Recently, wiggle-matching calibration of two radiocarbon dates of a spruce (*Picea* sp.) plank with

one of the longest surviving tree ring sequences has pointed to the ship's construction between the mid-2<sup>nd</sup> and the mid-1<sup>st</sup> century BC (fig. 2). It thus confirms the initial hypothesis of Müllner, who proposed an Iron Age date based on stratigraphic evidence.

The unique shape of the boat, clearly adapted to the specific environment of the Ljubljana Marshes, is characterised by an ellipsoidal-oval outline with truncated ends, a flat bottom and slanting sides. Two long strakes of boards (stringers) of ash wood (*Fraxinus* sp.), laid parallel to the ship mid-axis at a distance to one another and interpreted as members of a roll-on roll-off corridor, support the alleged use of the pramm for the transport of goods in barrels, such as is described in contemporary texts (Strabo, *Geography* 1, 8, c. 214).

The technological characteristics of the Lipe (Ljubljana) ship have been discussed in a series of papers following Gerhard Salemke's 'rediscovery' of the original publication in 1972. The present contribution therefore only highlights the observations and remarks on the lesser-known details based on the surviving parts, original drawings and the ship model. The first concerns the arrangement of the floor planking in longitudinal strakes with symmetrically distributed diagonal scarfs. Their pattern only survives on the model (fig. 5), but there is no reason to doubt the authenticity of the reproduction in spite of Müllner's silence on the subject.

There are uncertainties about the sewing technique employed in the boat as Müllner's drawing (see the interpretation schemes proposed by Boetto and Rouse (2011, p. 184, fig. 7) presents it as of a continuous type in a zigzag pattern, while the model shows a diagonal (///) pattern. It is worth mentioning the absence of notches of any kind at the holes of the obliquely bored cylindrical channels on both surfaces. The alignment of the channels also requires further study, but a hint is provided by Müllner himself, who wrote that the planks were installed facing upwards, meaning with concave side of the tree rings facing the internal surface. This is of importance for understanding the direction of the channels as drawn by the excavator, which peculiarly expand towards the external surface of the ship's bottom (Müllner 1892). This would result in extensive exposure of the rope to wear and tear during navigation. The observed growth pattern of the surviving planks is not always in accordance with the statement above, as both situations occur: sometimes the holes of the oblique channels do lie close or at the very edge (corner) of the alleged internal surface of the plank (with concave facing growth pattern), but also vice versa. The alignment of the channels as proposed by the excavator would be unique and odd. We should therefore consider the possibility that the detail was incorrectly drawn, as Boetto and Rouse (2011, p. 183-184) have already suggested.

Bundles or rolls of lime (*Tilia* sp.) bast were placed above the plank joints. After the rope had been tightened, the channels were locked with pegs of common buckthorn (*Rhamnus carthartica*).

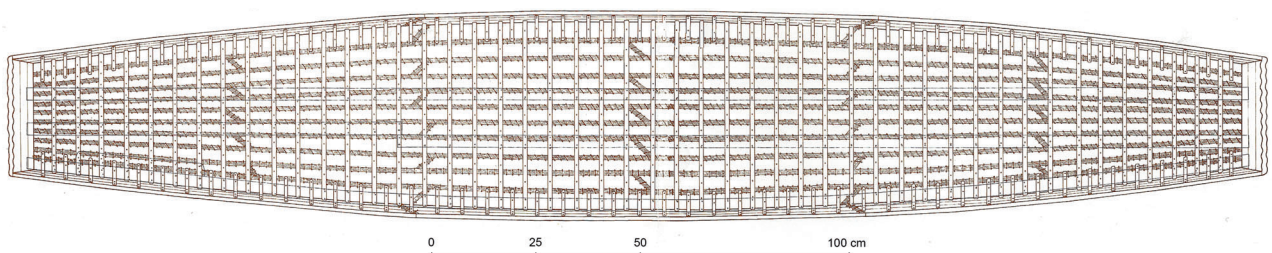
There are several other features showing that the whole set of technological solutions inherent to the sewn boats of the Mediterranean tradition was adopted. The cylindrical recesses in the sides of three surviving planks (Nos. 6, 45, 100) testify to the use of dowels at intervals between 15 and 23 cm (Gaspari 1998a, 1998b; Karinja 1998, pls. 20.1 and 21.5). These were not extensively used, as the detail occurs neither in the description and drawing nor on other surviving elements. It is possible that they served to secure the (side?) planking, but their role in providing the longitudinal structural rigidity of the hull also cannot be excluded.

The other common and frequently discussed feature of the Ljubljana boat is crenulated timbers (*Quercus* sp., *Fraxinus* sp.) and ribs (*Quercus* sp.). These enabled the frame elements to pass over the wadding placed along the seams of the longitudinal strakes. The frames, which occur at regular intervals of 60 cm (possibly adhering to the Italic/Roman measuring standards based on one Roman *pes*), were only fastened to the planking with cylindrical treenails (*Rhamnus carthartica*), although several large and small iron nails were also collected from the boat.

### 3. DISCUSSION

Of the newly acquired evidence of organised water transport on the Ljubljana at the end of prehistory, the cultural and technological context of the discovered sewn ships is particularly interesting. Radiocarbon dates show the barges from Lipe and Vrhnika to be the earliest known examples of flat-bottomed sewn boats of the northern Adriatic area (the regional traditions recently analysed by Pomey and Boetto 2019), specially designed to navigate shallow, slow-moving or stagnant waters. This raises a number of questions. These concern the origin of the technology, its carriers or modalities of the transfer of artisanal solutions. They also pertain to the owners or users of such high-capacity vessels in the late prehistoric environment deep in the hinterland of *Caput Adriae*, in the period before the presence of the Italic/Roman merchants and the military became more intense around the mid-1<sup>st</sup> century BC.

The roughly contemporaneous use of the sewing technology and mortise-and-tenon joints in the construction of local vessels already in the 2<sup>nd</sup> century BC, as well as resin-soaked textile luting of logboats, all seem to be rooted in Mediterranean



**Fig. 5:** The Ljubljana (Lipe) sewn boat; drawing of the model in the scale of 1:10 made by carpenter Karol Binder in 1891 (drawing I. Murgelj, National Museum of Slovenia).



shipbuilding tradition, which is of no surprise as the *Ljubljansko barje* is only located some 55 km from the nearest coast. As attested in literary sources for the final centuries BC, the sewing technique was employed by the neighbouring tribes of the Histri and Liburni, while the records on the river and lagoon of flat-bottomed vessels of the Veneti make no mention of their modes of assembly, although they might also involve ligatures. In connection with this, we should bear in mind the cultural and possibly even ethnic background of the local population at Nauportus. As argued recently (Gaspari *et al.* 2017, p. 179-185), the linguistic origin of autochthonous (pre-Roman) names indicates an integration of the broader area of pre-Roman Nauportus into the northern Adriatic onomastic region, consolidated around the Venetic, Histrian or Liburnian name tradition. The alleged kinship is corroborated by the local toponym *Emona* (present-day Ljubljana) with its typical northern Adriatic suffix *-ona*, as well as the similarities of the epigraphically attested local female deity *Aecorna* with the Venetic and northern Adriatic deities. The potential connection between the prevalence of specific artisanal, in this case shipbuilding knowledge, and the ethnic/linguistic affiliation of local community(ies) to a larger group of peoples in the *Caput Adriae* area is further supported by a strong non-Celtic component in the local Late Iron Age material culture. These indicate a close attachment to the (local) Late Hallstatt tradition and the integration of the coastal and hinterland areas between Friuli, Notranjska and the Kvarner Gulf or northern Dalmatia into the regional trends.

In the cultural regionalisation of the La Tène Period, the area between Ljubljana and Vrhnika is traditionally considered a territory under the military-political authority of the Tauriscan tribal alliance. Here, the Celtic material culture only becomes more numerous represented from the beginning of the 2<sup>nd</sup> century BC onwards. At the same time, a greater influx of Italic imports and Roman Republican coins east of Razdrto (*Ocra*) is noted towards the end of the 2<sup>nd</sup> century BC. This shows that we cannot completely exclude the possibility that the vessels bearing the northern Adriatic technological signature are actually those of Italic/Roman owners, i.e. merchants and other civilians with business interests in the area of one of the Celtic kingdoms beyond the Alps, or of consular armies on expedition along the Sava corridor (Šašel Kos 2005, p. 329-334).

The local shipbuilding practice is marked by vitality and innovativeness. In its very nature, it reflects both the significance of water transport for the local community and the interest of successive political authorities in participating in the organised transport of goods, also for military purposes. It played an important role in the formation of (supra)regional trends, perhaps even in the development of (military) barges of the 'Romano-Celtic' type. Its vitality and innovativeness is clearly visible in the new technology of joining planks with densely distributed iron clamps. An autochthonous origin of this technology is supported by the substantial use of iron clamps for repairing cracks and reinforcing the bow parts on the Iron Age logboats from Vrhnika, Zakotek and perhaps also Črna vas (Gaspari *et al.* 2017, p. 106-107, 116-117), which is unusual in other parts of the Mediterranean and continental Europe. The Sinja Gorica barge, constructed soon after AD 3 (Erič *et al.* 2014, p. 218-220), is for

now the earliest reliably dated representative of this new tradition, which resembles and might have been inspired by the technology of sewn ships, as could be cautiously hypothesised from the rough contemporaneity of the barges from Lipe and Vrhnika with listed examples of assembly by iron clamps from the *Ljubljansko barje* area. Nevertheless, the available dataset is still too slight to enable firmer conclusions in this respect. Allegedly, the reason for changing the joining technique or abandoning sewing in the construction of larger vessels in the hinterland of the north Adriatic might be connected to faster construction and easier maintenance. The chronological coincidence of the Sinja Gorica barge with the period of the Roman conquest of Illyricum and Pannonia, in which Nauportus served as an important logistic post, indicates that the new shipbuilding practice may be associated with increased supply requirements, perhaps with a military shipyard. The new method of construction of barges could have been practiced by *fabri navales* of northeastern Italian or even local origin, who either mastered or were at least knowledgeable of both techniques, sewing and joining with iron clamps.

The integration of the new practice into the shipbuilding traditions of the area is also confirmed by the geographical area of distribution of the vessels with such a technique of joining the hull, all originating from the Sava-Danube river basins. Two more ships of this tradition, discovered in the Kupa riverbed near Kamensko (end of the 1<sup>st</sup>-beginning of the 3<sup>rd</sup> century; Boetto 2016, p. 1413-1416; Boetto *et al.* in this volume) and at Sisak (3<sup>rd</sup> century AD (?); Gaspari, Erič, Šmalcelj 2006), have features similar to the sewn ships from Vrhnika and Lipe: flat bottom with the typical transition into the sides composed of carved bilge strakes with a C- or L-shaped cross section and made of a single piece of wood, the use of vegetal luting and the prevailing use of wooden treenails for joining floor timbers or ribs and the planking.

The feature that distinguishes the Sinja Gorica ship from both the Roman-era ships with iron clamps from the Kupa River and the sewn ships of the northern Adriatic area is metal nails for joining the frame and the planking (Erič *et al.* 2014, p. 242-248). In Roman-era shipbuilding, these were typically used on the barges of the Romano-Celtic tradition from the Rhône basin, the lakes of western Switzerland and Rhineland. The isolated occurrence of the use of nails within the Sava-Danube tradition could therefore be interpreted (with some reservation and pending new finds) as a workshop signature and a practice that was later abandoned. This assumption is supported by an unusual and as yet unexplained design of the vessel that is, in its researched part, marked by the absence of the usual frame – part of its functions were obviously carried out by the slim floor timbers placed into the transverse recesses in the floor planking. Judging by the similarity with the dovetail joint, the use of which reaches back to the pre-metal periods of European prehistory, and the absence of such transverse and longitudinal reinforcement of floor planking in Mediterranean shipbuilding, it is possible that this feature also relates to pre-Roman carpentry practice. All this clearly testifies to the importance of the discussed area for the innovation and transfer of naval technology at the end of prehistory and in the Early Roman period.

## REFERENCES

- BERTI F.  
1986 Rivenimenti di archeologia fluviale ed endolagunare nel delta Ferrarese, *BA* 37-38, Suppl., p. 19-38.
- BOETTO G.  
2016 Recherches d'archéologie navale en adriatique orientale, *CRAI*, novembre-décembre IV, p. 1401-1422.
- BOETTO G., ROUSSE C.  
2011 Le chalands de Lipe (Ljubljana, Slovénie) et la tradition de construction "sur sole" de l'Europe sud-orientale: quelles influences méditerranéennes? In G. Boetto, P. Pomey, A. Tchernia (eds), *Batellerie Gallo-Romaine: pratiques régionales et influences maritimes Méditerranéennes*, Paris/Aix-en-Provence, Errance/Centre Camille Jullian, BiAMA 9, p. 179-191.
- ERIČ M., GASPARI A., ČUFAR K., SOLINA F., VERBIČ T.  
2014 Early Roman barge from the Ljubljanica River at Sinja Gorica, *Arheološki vestnik* 65, p. 187-254.
- GASPARI A.  
1998a Pontonium iz Lip na Ljubljanskem barju / A "Pontonium" from Lipe on the Ljubljana Moor (Summary), *Arheološki vestnik* 49, p. 187-224.  
1998b Das Frachtschiff aus Lipe in Moor von Laibach (Ljubljana), *JRGZ* 45, p. 527-550.
- GASPARI A., ERIČ M., ŠMALCELJ M.  
2006 Roman river barge from Sisak (Siscia), Croatia, in L. Blue, F. Hocker, A. Englert (eds), *Connected by the Sea, Proceedings of the Tenth International Symposium on Boat and Ship Archaeology (ISBSA 10)*, Roskilde 2003, Oxford, Oxbow, p. 284-289.
- GASPARI A., ŠINKOVEC I., BADOVINAC D., BOCKIUS R., ČUFAR K., DRAKSLER M., KAVKLER K., MERELA M., TOMAZO-RAVNIK T., VERBIČ T.  
2017 *The Late 2<sup>nd</sup> century BC Logboat from the Ljubljanica River at Vrhnika. Study on the Ships and Boats of Preroman and Roman Nauportus with the Outline of the Navigation on the Ljubljana Marshes between Prehistory and the Early Modern Period*, Ljubljana, Ljubljana University Press, Faculty of Arts, and Museum and Galleries of Ljubljana.
- KARINJA S.  
1998 Šivana ladja z Ljubljanskega barja / Sewn boat from the Ljubljana moor (Summary), *Annales. Series historia et sociologia* 14, p. 57-98.
- MÉDARD F.  
2011 Textiles archéologiques et archéologie navale: l'exemple des tissus gallo-romains du Parc Saint-Georges, in G. Boetto, P. Pomey, A. Tchernia (eds), *Batellerie Gallo-Romaine: pratiques régionales et influences maritimes Méditerranéennes*, Paris/Aix-en-Provence, Errance/Centre Camille Jullian, BiAMA 9, p. 105-117.
- MEDAS S.  
1994 Un frammento di scafo monossile dal Po, in *Civiltà Padana, Archeologia e storia del territorio*, V, Modena, Aedes Muratoriana, p. 29-42.
- MÜLLNER A.  
1892 Ein Schiff in Laibacher Moore, *Argo* 1, p. 1-7.
- POMEY P., BOETTO G.  
2019 Ancient Mediterranean Sewn-Boat Traditions, *IJNA* 48.1, p. 5-51.
- ŠAŠEL KOS M.  
1990 Nauportus: literary and epigraphical sources, in J. Horvat (ed.), *Nauportus (Vrhnika)*, Ljubljana, Slovenian Academy of Sciences and Arts, Dela 1. razreda SAZU 33, p. 17-33, 143-159.  
2005 *Appian and Illyricum*, Ljubljana, National Museum of Slovenia, Situla 43.



# STRUCTURALLY PREDOMINANT BOTTOMS IN FRAME-FIRST CONSTRUCTION: THE CASE OF THE *BARQUE DU LÉMAN*

Paul BLOESCH

---

## Abstract

The lateen-rigged *barque du Léman* (Lake Geneva, France/Switzerland, 19th-20th centuries) was skeleton-built in genuine post-medieval Mediterranean tradition, however, its bottom was constructed in a very particular way: the heavy planks, made of silver fir (*Abies pectinata*) and almost as thick as the frames were sided, ran uninterrupted over most of the bottom's length. The rest of the planking was made of oak (at the ends of the bottom) and of larch (at the sides). Obviously, the bottom's structural strength mainly depended on these fir planks.

## Keywords

*Barque du Léman*, bottom planking, Lake Geneva, wood species

## Résumé

La *barque du Léman* (France/Suisse, XIX<sup>e</sup>-XX<sup>e</sup> siècles) est une grande embarcation à voile latine, construite sur couple selon la plus authentique tradition méditerranéenne postmédévale. Cependant, son fond a été construit d'une manière très particulière : les lourds bordés de fond en sapin pectiné (*Abies pectinata*) sont presque aussi épais que la membrure et courent sans interruption sur presque toute la longueur du fond. Le reste du bordé était en chêne (pour le bouchain) et en mélèze (pour les flancs). De toute évidence, la résistance structurelle du fond dépendait principalement de ces planches de sapin.

## Mots clés

*Barque du Léman*, bordé de fond, lac Léman, bois

---

The *barque du Léman*, as it is conventionally called today, was a specific type of transport vessel used on Lake Geneva. It reached the end of its evolution around the year 1900 and disappeared between the two World Wars. The smaller vessels (called *bricks*) had a carrying capacity of between 30 and 70 tons deadweight, the bigger ones (the *barques*) carried from 90 to 180 tons. They were built frame-first in genuine post-medieval Mediterranean tradition, and rigged with two lateen sails, to which a jib was added shortly before 1900. Two vessels have survived to this day, but not without having undergone some radical repairs or even rebuilds: the *Neptune*, of 1904, at Geneva, and the *Vaudoise*, of 1931, at Lausanne-Ouchy.

The planking, which was added to the pre-erected framework, can be divided into three categories: the flat part of the bottom, made of silver fir (*Abies pectinata*) ; the rising and narrowing extremities of the bottom, made of oak (*Quercus sp.*) ; and the bilges and sides, each made of larch (*Larix decidua*). The particular structure of the bottom will be the subject of the present contribution.

The principal characteristics of the fir planks in the centre of the bottom have been described by Gérard Cornaz (1976, p. 75, 191). Called *meïnets*, they were up to 17.50 m long and from 8 to 14 cm thick, almost as much as the sided dimension of the floor timbers (10 to 14 cm according to the size of the vessel). They were worked green, and applied to the frames without any heating. In order to fit the shape of the rising floor timbers fore and aft, the *meïnets* were sawn obliquely at their extremities (Cornaz 1976, p. 75: “Le sciage aux extrémités se faisait en biais pour épouser la forme acculée des varangues à l'avant et à

l'arrière”). This could be understood as if the faces of the planks were sawn at their extremities to exhibit a slight twist, but this is not the case, as will be shown later. The *meïnets* were fastened to the framing with treenails made of laburnum (*Laburnum alpinum*), one per strake and per floor timber, and distributed in an alternating pattern. The treenails were driven from the inside of the floor timbers and wedged at the outer face of the plank.

The *meïnet* strakes were continued at both ends of the vessel by oak planks called *pièces entorses*, which can be translated by ‘twisted pieces’<sup>1</sup>. These planks were bent by heating over fire, and fastened with iron spikes.

During the winter months 2004-2005, the restoration of the *barque Neptune* in Geneva provided this author with the opportunity to study the structures that might be original, or at least be related to repairs executed during the first career of the ship. Unfortunately it was not possible to record in detail more than four fragments of old planking situated in the rear of the port half of the bottom (fig. 1: yellow). The piece next to the keel seems to be original, while the following three result from an early repair, as they have been laid over plugged spike holes in the floor timbers. The seams, on the other hand, could be recorded for most of their length thanks to the carpenters who, when dismantling the bottom planking, had carefully marked them on the floor timbers (fig. 1: bold dashed lines).

---

1. Cornaz (1976, p. 75, 191) writes *pièces en torse*, but we prefer the adjective following the usage of the shipyard Christin of Saint-Gingolph as attested in its account books covering the years 1910-1921 (private collection, Saint-Gingolph).



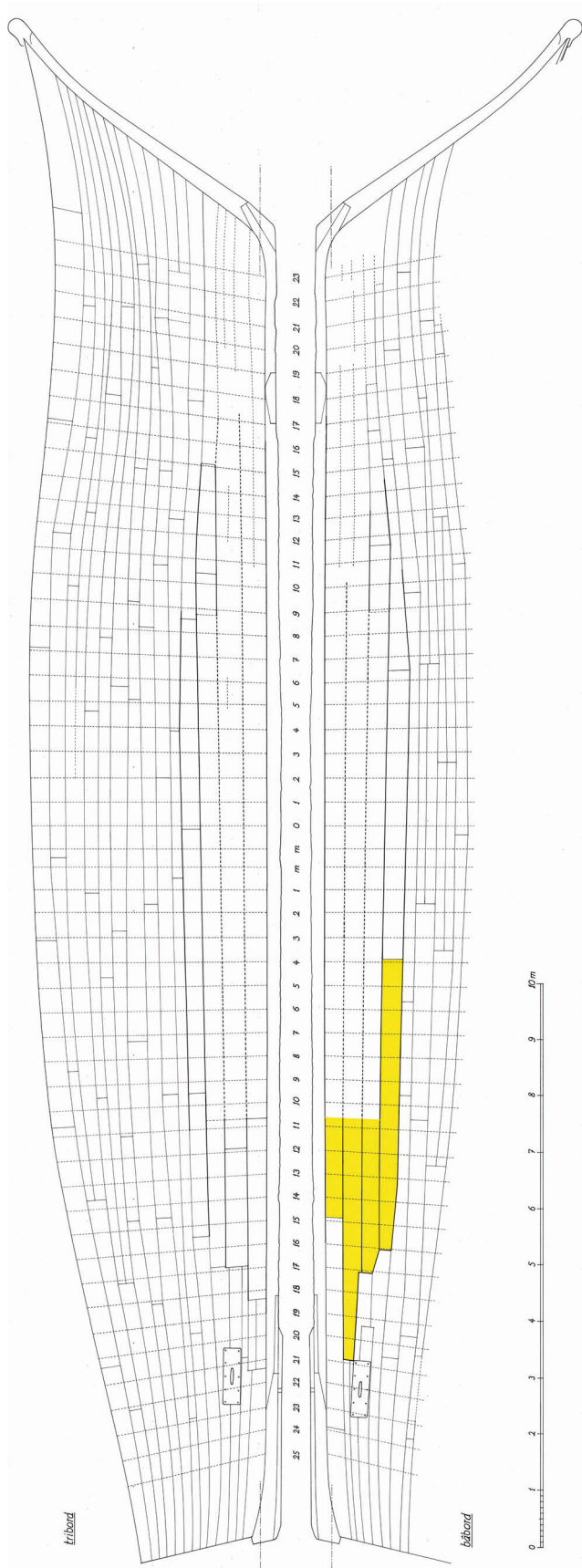


Fig. 1: Neptune, 1904. Planking expanded (drawing P. Bloesch).

We can distinguish four strakes on each side of the keel: they exhibit straight edges and steadily narrowing widths as they approach the rear end of the bottom. The extremities of most bottom planks are further reduced in width by a more or less oblique cut of their outboard edges. At the forward end of the bottom the situation is less clear. Several conspicuous oblique seams could be observed, but unfortunately no old planking was left.

Two kinds of fasteners could be observed: treenails in the central part of the bottom and iron spikes in the ends of the planks which, in the case of the four recorded fragments, extend over three to seven floor timbers (fig. 2). The treenails, one per strake in every floor timber, are driven from inboard, wedged at the outboard face of the plank, and arranged in the characteristic pattern described by Cornaz (1976, p. 75). The treenails are of two sizes: about 25 mm and about 29 mm mean diameter. The spikes, about 10 mm square, are distributed normally two per strake in every floor timber. There is also evidence of the use of some odd threaded iron nuts and bolts near the ends of the planks.

The dimensions of the bottom planks are impressive. Their widths range from 33 to 46 cm at their wide ends, and from 29 to 39 cm at their narrow ends. Since the original planks are almost entirely lost, their lengths could not be established. Their thickness was 11 cm near the keel, tapering to 10 cm at the outer edge of the third strake and to 9 cm at the outer edge of the fourth strake (fig. 2). The ends of the planks taper to 8 or 7 cm at their butts where they meet the oak *pièces entorses*, which in turn taper to about 5 cm close to the rabbet of the stem and at the sternpost. The rabbet has a depth of about 4 cm, which is also the thickness of the hood ends of the planks fitted into them.

The general pattern underlying the construction of a *barque* bottom, which looms through the planking seams of *Neptune*, is further revealed, and confirmed, by a model in the *Musée du Léman* at Nyon (Inv. No. ML 141) and said to have been made in 1905 or 1906 by a shipwright apprentice, called Duchamp, at Saint-Gingolph (fig. 3). It indeed looks very much like a school exercise. It shows the characteristic planking pattern in its simplest form, and it reproduces the choice of the wood species of the real construction. On each side of the keel we see two long fir planks with parallel edges and trapezoidal ends, each continued forward and aft by oak planks (the *pièces entorses*). The third fir plank, with diverging edges and square ends, is continued by larch planks, and the sides are entirely planked in larch.

This particular shape of the bottom planks seems to have remained unnoticed until quite recently, when it was possible – as mentioned above –, to record the seams of the bottom planking of the *barque Neptune* in detail, and to compare the resulting pattern with that of the model of Duchamp.

Cornaz (1976, p. 75, 191) does not explicitly mention this pattern of the bottom planking. He only says, as we remember, that the fir planks were up to 17.50 m long and had their extremities sawn ‘obliquely’. However, in the light of our observations, this can only be understood in the sense that the extremities of the planks were given the trapezoidal shape we have seen in the bottoms of *Neptune* and of the model of Duchamp, and not in the sense of their being sawn with a certain twist at the ends of their faces, which, incidentally, could only have been achieved by handwork, and not in a sawmill. Curiously enough, Cornaz’ drawings (e.g. 1976, plan No. 1-2



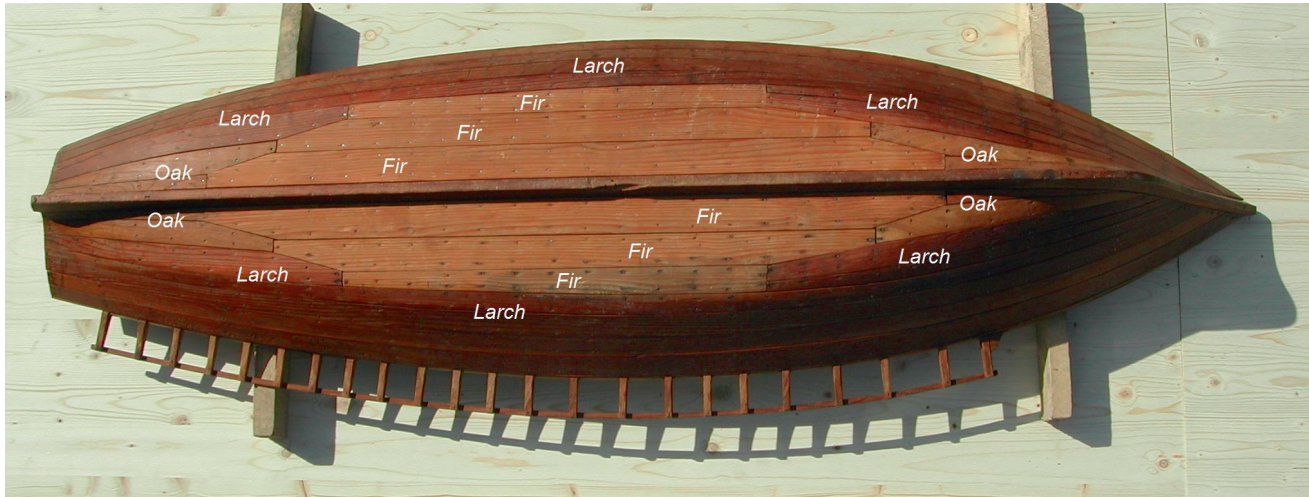


Fig. 3: Barque model, about 1905. Nyon, Musée du Léman, ML 141. Keel length: about 1.31 m (photography P. Bloesch).

In any case, when the shipwright Laurent Dental from Nice was commissioned by the Duke of Savoy in 1671 to build two Mediterranean *barques* on Lake Geneva (Bloesch 1999), he almost immediately went to a mountain forest to select and fell some exceedingly large fir trees suitable to be sawn into bottom planks<sup>5</sup>. This is a striking illustration of

the maxim pointed out by Fernando Oliveira in his *Livro da fabrica das Naos*, namely that a shipwright working in foreign countries should, in choosing his building materials, follow the local traditions (Rieth 1999, p. 38; Oliveira 1991, p. 66, 144).

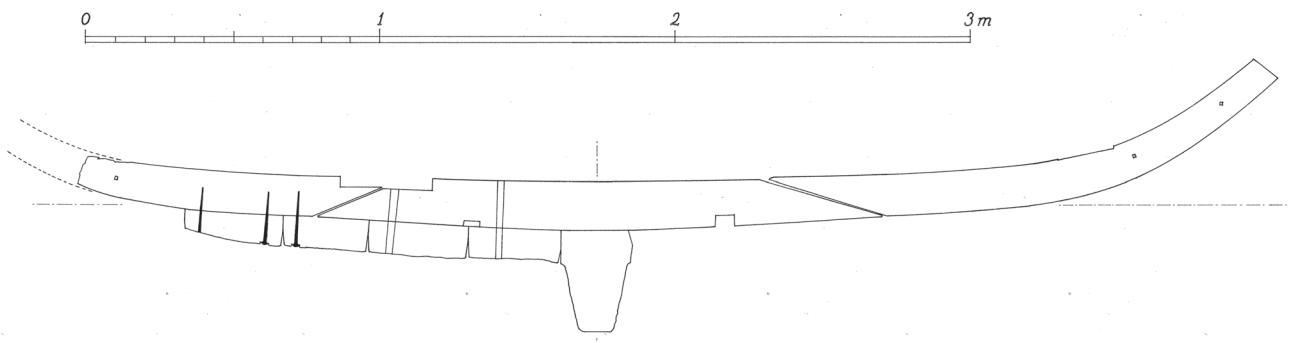


Fig. 4: Neptune, 1904. Repair of floor timber A 10. The outer edge of the fourth strake has been reduced in thickness in a subsequent repair, carrying away the head of the spike (drawing P. Bloesch).

5. Turin, Archivio di Stato di Torino, Corte, Materie politiche per rapporto all'interno, Lettere di particolari, M 48. Letter of auditor Metral, dated 31 March 1671, informing the Duke that "*demain je les conduiray tous deux a la montagne pour marquer les pieces de sappin necessaires...*" (Translation: "tomorrow I will take them both [i.e. the shipwrights] up into the mountain to mark the necessary fir trees..."). An anonymous memorandum informing the Council of Geneva on 2 June 1671 (old style) about the progress of the Savoyan ship-building programme (Geneva, Archives d'État, CL 46, fol. 14-15) mentions "*les bois de la forest de Toulon qui est au dessus du village de Maillairia et de St Gingou ou il y a des scies assez propres à refendre lesdits arbres d'excessive longueur et grosseur qui sont des vuargnes propres pour faire lesdits fonds des bastimens qui ne se pourrissent dans l'eau...*" (Translation: "the woods of the forest of Thollon, situated above the villages of Meillerie and Saint-Gingolph where there are saw[-mills] quite suitable for sawing the said trees of excessive length and thickness, being firs suitable for making the said bottoms of the vessels, which do not rot in the water".)



## REFERENCES

### BLOESCH P.

- 1999 Conversion d'un navire de mer en navire de lac (lac Léman), in P. Pomey, É. Rieth (eds), *Construction navale maritime et fluviale. Approches archéologique, historique et ethnologique, Actes du Septième Colloque international d'archéologie navale/ Proceedings of the Seventh International Symposium on Boat and Ship Archaeology (ISBSA 7), Île Tatihou 1994*, Paris, éditions du CNRS, Archaeonautica 14, p. 115-121.

### CONTI (DE ZUANNE) S.

- 1686 *L'architettura navale*. London, British Library, mss. Add. 38655. Another copy is kept in the Biblioteca comunale of Treviso, Italy, ms. 1784.

### CORNAZ G.

- 1976 *Les barques du Léman*, deuxième édition revue et corrigée, Grenoble, 4 Seigneurs. (Nouvelle édition revue et corrigée: Genève, Slatkine, 1998.)

### JONCHERAY J.-P.

- 1988 Un navire de commerce de la fin du XVII<sup>e</sup> siècle, l'épave des Sardinaux. Première partie: Le navire et son mode de chargement, *Cahiers d'archéologie subaquatique* 7, p. 21-67.

### MAZAUDIER M.

- 1835 *Guide pratique d'architecture navale*, Paris/Toulon, Desauche/Bellue.

### OLIVEIRA F.

- 1991 *Livro da fabrica das naos*, Facsimile of the cod. 3702 of the National Library of Lisbon, edition, and English translation, Lisbon, Academia de Marinha.

### RIETH É.

- 1999 La sélection des bois selon le Livro da fabrica das naos (1570-1580) de Fernando Oliveira, in A. Corvol (ed.), *Forêt et Marine*, Paris et Montréal, L'Harmattan, p. 33-40.

### VILLIÉ P.

- 1998-2005 *Unpublished excavation reports of the site U Pezzo, Saint-Florentin, Haute-Corse*, Marseille, Département des recherches archéologiques subaquatiques et sous-marines, EA 2331.





# THE ASSEMBLY OF HULLS IN SOUTHEAST ASIAN SHIPBUILDING TRADITIONS: FROM LASHINGS TO TREENAILS

Pierre-Yves MANGUIN

---

## Abstract

This article describes the techniques used in Southeast Asian boats and ships to assemble planks and frames as observed over the past two millennia in archaeological and ethnographical contexts. Planks were first lashed with vegetal fibre and dowelled, with frames also lashed to planks. The sewing of the planks later gave way to treenails only, with frames still lashed to planks. In large ships, the lashings of planks to frames were finally also replaced by treenails, as could still be observed in Indonesia in the late 20<sup>th</sup> century.

## Keywords

Lashed-lug frames, sewn plank boats, Southeast Asia

## Résumé

Cet article décrit les techniques utilisées dans les bateaux et les navires d'Asie du Sud-Est pour assembler le bordé et la membrure comme observé au cours des deux derniers millénaires dans des contextes archéologiques et ethnographiques. Les planches du bordé ont tout d'abord été assemblées à l'aide de fibre végétale et chevillées, et renforcées par des couples ligaturés au bordé. Cette couture des planches de bordé a cédé petit à petit la place à un assemblage uniquement assuré par des chevilles, les couples demeurant ligaturés au bordé. Sur les plus grands navires, l'assemblage par ligatures de la membrure au bordé a finalement aussi été remplacé par des chevilles, comme on pouvait encore l'observer en Indonésie à la fin du xx<sup>e</sup> siècle.

## Mots clés

Membrures ligaturées, bateaux cousus, Asie du Sud-Est

---

Southeast Asian shipbuilding processes have by now been sufficiently documented, with data gathered from textual sources, ethnographic observations and, more recently, from archaeological research, to start distinguishing paths of development in technologies used to assemble hulls in the past two millennia. It is now possible to build up a tentative typology of this technical tradition in both chronological and regional terms. In this short contribution, I will concentrate only on how hull planks were assembled and then fastened to frames, in a shell-first shipbuilding process that survived until our days in Indonesian waters. Such defining features are easily observable, even in the most disturbed archaeological contexts.

The oldest recorded boat remains found in Southeast Asian archaeological sites date from the first half of the first millennium AD. Their hulls were assembled with vegetal fibres, using a technique belonging to a broadly defined “sewn-plank tradition”, but with clear local specificities, usually designated as the “stitched-plank and lashed-lug tradition” (Manguin 1985, 2019; Gibson-Hill 1952; McGrail 2001, p. 297-298; Flecker 2012; Liebner 2014; Lacsina 2015). The Southeast Asian tradition needs to be clearly distinguished from the other major sewn-plank tradition of Asian seas, characteristic of the craft of the western Indian Ocean, also known as the “Arabo-Indian tradition” (*Fibre and Wood 2019*; Staples, Blue 2019). Contrary to the latter tradition, where sewing is done with a continuous thread passed through holes drilled across the planks, therefore visible on the outer side of the hull, the Southeast Asian technique uses

discrete lashings, disconnected from each other, that pass through holes drilled into the edge and out of the inner face of planks. Stitches are therefore not visible on the flush outer surface of the hull. Ropes used to assemble these vessels were almost always made of the fibre of the sugar palm tree (*Arenga pinnata* or *A. saccharifera*).

In the earlier ships observed in Southeast Asia (dated to around the 4<sup>th</sup> to 5<sup>th</sup> century AD), the fastening of the planks with separate lashings was reinforced by only a few treenails inserted at a distance from each other (some craft may have been built without such dowels, but reliable evidence is lacking). All planks were fastened to the frames (and to the thwarts) by way of protruding lugs or blocks carved out on the inner face of planks (a feature independently attested in Scandinavian ancient traditions, but unknown to the Arabo-Indian or Mediterranean traditions) (fig. 1).

The craft dated to the second half of the first millennium AD still had their planks stitched together with vegetal fibres, but the number of treenails clearly increased, providing more structural rigidity to the hull. The occasional tenon-and-mortise joint also appears to have been used in places to lock planks together, as observed so far only in the 7<sup>th</sup>-century Sambirejo (South Sumatra) and Punjulharjo (Central Java) sites (Manguin 2019, fig. 4). On the other hand, the lashing of planks to frames via lugs still remained in general use.

At the turn of the second millennium AD, a major change occurred. Whereas the lashing of planks to frames via lugs again remained in use, the sewing of planks with discrete

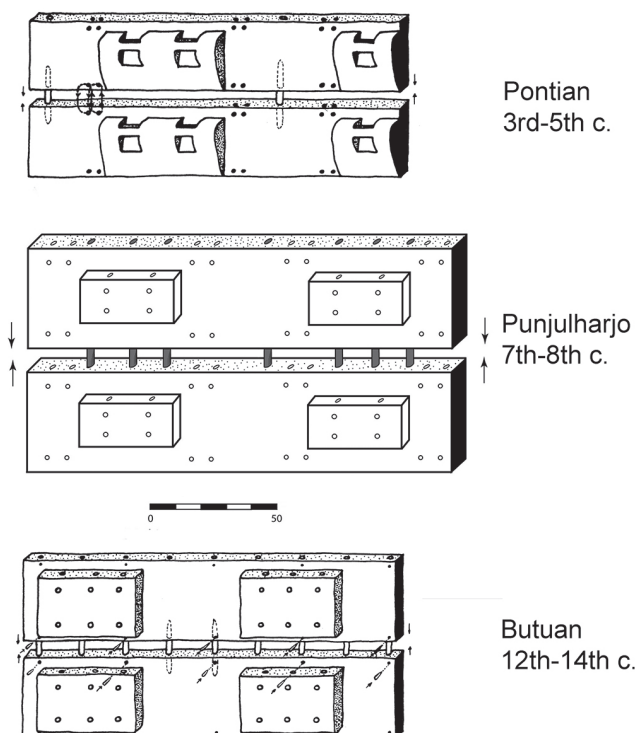


Fig. 1: Fastening of planks in Southeast Asian shipbuilding: from stitches to treenails (drawings by Puslit Arkenas and P.-Y. Manguin).

lashings disappeared in all known ship remains of Southeast Asian build. Only treenails, by now more numerous, remained to fasten planks together. Treenails alone may not have been sufficient to keep the hull in compression during its construction in a shell-first shipbuilding process, or to prevent the strakes from riding apart when sailing, with only the lashings between frames, thwarts and planks left to keep the hull in place. Driving smaller locking treenails into some of the dowels from the inside of the planks became a common practice to compensate the loss of the lashings, as clearly attested in Southeast Asian craft discovered in archaeological contexts. This technique was still to be observed in purely dowelled plank-built boats in Java in the 1980s (figs 1-3). Another technique that fulfils the same purpose, known among 20<sup>th</sup>-century shipbuilders of South Sulawesi (Indonesia) but never found in an archaeological context, is to drive a wedge into the head of a treenail (one out of every three or four) left protruding after assembling two strakes (figs 2 and 4) or assembling planks to the frames.

Whereas the process of forsaking the sewing of the planks appears to have been general in Southeast Asian waters in the second millennium, the lashing of frames to lugs carved out of planks remained attested in the Philippines and the Moluccas for smaller craft in the 16<sup>th</sup> and 17<sup>th</sup> centuries, and even survived to this day in whaling boats of the small island of Lembata, in eastern Indonesia (Manguin 2019, p. 402; Barnes 1985).

So far no sites with remains of ships from the 15<sup>th</sup> and 16<sup>th</sup> centuries have been found in Southeast Asia. However, keen Portuguese observers precisely described the large traders they then encountered in the Melaka Strait and the Java Sea, which were built by the major maritime powers of insular Southeast Asia. The Malays and Javanese called

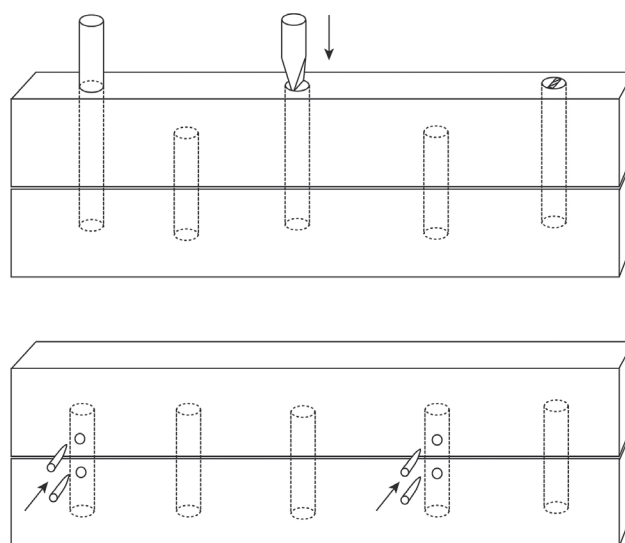
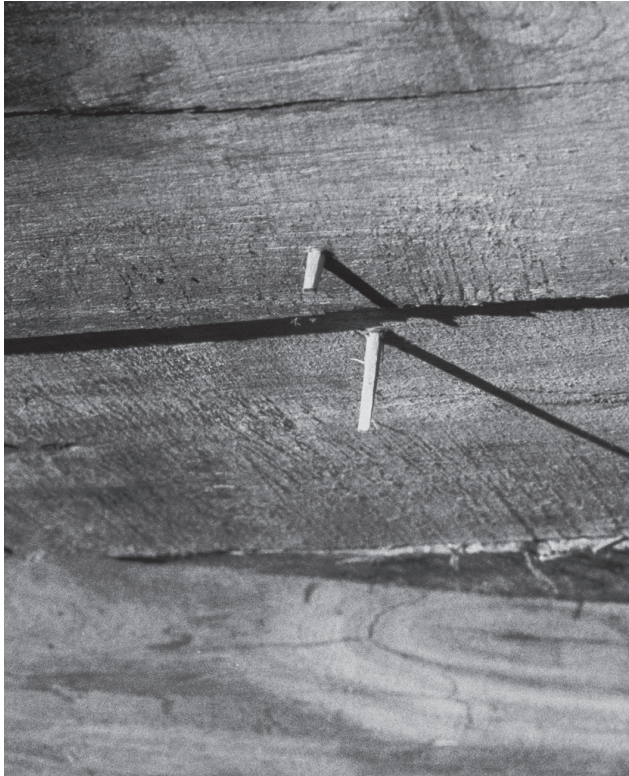


Fig. 2: Locking treenails and wedges to fasten planks in South Sulawesi (top) and Java or Madura (bottom) (drawing by P.-Y. Manguin).

them *jong*, the term at the origin of the modern word *junk*. These concurring texts tell us that a further major change had taken place in some Southeast Asian shipyards: assembly of the hull was now entirely done by way of treenails, both between planks and between planks and frames (to the total exclusion of iron nails or clamps, as in earlier times) (Manguin 1980, 2019). Lashings with vegetal fibres were no longer in use for assembling these large vessels, and the protruding lugs carved out in the inner side of the planks must have then disappeared. Such fully treenailed ship structures survived in Indonesian waters until late in the 20<sup>th</sup> century. The fact that Indonesian shipbuilders kept alive the process of locking the treenails and the strakes in place with smaller treenails or with wedges is one good indication that 15<sup>th</sup>-16<sup>th</sup> century and later ships are the final step in the evolution from the earlier sewn techniques used in Southeast Asian waters. The first major step in this development was the rejection of stitches between planks and their progressive replacement by treenails, keeping the lashings only to fasten the planks to the frames. These lashings of planks to frames via lugs were in turn discarded and also gave way to treenails to fasten the frames to the hull.

There is sufficient evidence at hand, therefore, to establish that Southeast Asian shipbuilding techniques underwent significant evolution during the past two millennia. All the available data confirms the continuity between shipbuilding procedures of the first and second millennia AD. It is relevant here to note that a comparable evolution – from sewing to treenails (and/or tenons and mortises), with composite intermediary phases – took place in Greek vessels around the mid-first millennium BC (Pomey 2010). Compared to the vast corpus of Mediterranean ships, however, we still have a very limited amount of data at hand in Southeast Asia, with only some 30 sewn vessels available for study, many of them fragmentary or from insufficiently controlled excavations. These craft are, moreover, spread over two millennia, and dispersed over a vast and culturally very diverse area, within a multitude of mainland and insular Southeast Asian ecosystems, harbouring





**Fig. 3:** Locking treenails in a tao de' from Madura (photo P.-Y. Manguin/EFEO 1981).

peoples of a variety of ethnolinguistic groups. Sizes, carrying capacities and functions of these vessels may have widely contrasted. The largest ships were built within societies that progressively formed complex polities of various magnitudes, which played an active role in shaping exchange and trade networks in the Indian Ocean and the South China Sea. Many of the ship remains from South Sumatra were thus discovered during surveys and excavations in the city of Palembang and its surroundings, the capital of the powerful thalassocracy of

Srivijaya (7<sup>th</sup>–13<sup>th</sup> century) (Manguin 2004). Others may have been used by fishermen belonging to simpler societies, many of which survived in remote parts of insular Southeast Asia well into the 20<sup>th</sup> century.

If there is little doubt that Southeast Asian technologies evolved over the centuries along the pattern described above (a pattern shared with other regions in the world), we obviously do not have enough examples to fully describe and understand this evolution. One may speculate that improvements could have been introduced in larger trading ships, where more structural strength was required to carry large cargoes. The large 10<sup>th</sup>-century Cirebon wreck may thus represent a transition phase. Her upper planks were fastened by dowels alone, with lugs still carved out to lash them to frames and thwarts. The bottom strakes, for lack of clear evidence, are harder to interpret as they were not dismantled during excavation: the holes in the flat (lug-less) bottom strakes could have been used to lash the latter to the floors, with planks fastened together with treenails (Liebner 2014). However, the smaller boats excavated in Butuan, dated to between the late 8<sup>th</sup> and the 10<sup>th</sup> century, also appear to pertain to this new trend in shipbuilding, providing the earliest example of true lashed-lug only vessels with no more stitches for fastening the planks (Lacsina 2015).

As was often noted for Mediterranean vessels, such evolution in Southeast Asian seas may not have been unilinear. Not all the vessels examined above would have served the same functions, and interactions between regional variants must have taken place. We will need many more properly studied craft, brought to light during systematic excavations, to better distinguish between internal evolution and technological transfers within or without the Southeast Asian shipbuilding tradition.

## ACKNOWLEDGMENTS

The participation of the author in the ISBSA conference in Marseille was made possible by the *Seafaring: Maritime knowledge in the South China Seas* project (ANR/Ecole française d'Extrême-Orient, Paris/Academia Sinica, Taipei).



**Fig. 4:** Locking wedge in a pinisi from South Sulawesi (photo P.-Y. Manguin/EFEO 1979).



## REFERENCES

- BARNES R. H.  
1985 Whaling Vessels of Indonesia, in S. McGrail, E. Kentley (eds), *Sewn Plank Boats. Archaeological and ethnographic papers based on those presented to a conference at Greenwich in November 1984*, Oxford, National Maritime Museum, BAR International Series 276, p. 345-366.
- FIBRE AND WOOD  
2019 Fibre and Wood Special Section, *IJNA* 48.2, p. 269-426.
- FLECKER M.  
2012 The Jade Dragon Wreck: Sabah, East Malaysia, *The Mariner's Mirror* 98.1, p. 9-29.
- GIBSON-HILL C. A.  
1952 Further Notes on the Old Boat found at Pontian, in Southern Pahang, *Journal of the Malayan Branch, Royal Asiatic Society* 25.1, p. 110-133.
- LACSINA L.  
2015 The Butuan Boats of the Philippines: Southeast Asian edge-joined and lashed-lug watercraft, *Bulletin of the Australian Institute of Maritime Archaeology* 39, p. 126-132.
- LIEBNER H. H.  
2014 *The Siren of Cirebon: A Tenth-Century Trading Vessel Lost in the Java Sea*, PhD Dissertation, The University of Leeds, Leeds.
- MCGRAIL S.  
2001 *Boats of the World: from the Stone Age to Medieval Times*, Oxford, Oxford University Press.
- MANGUIN P.-Y.  
1980 The Southeast Asian Ship: An Historical Approach, *Journal of Southeast Asian Studies* 11.2, p. 266-276.  
1985 Sewn-plank Craft of South-East Asia. A Preliminary Survey, in S. McGrail, E. Kentley (eds), *Sewn Plank Boats. Archaeological and Ethnographic papers based on those presented to a conference at Greenwich in November, 1984*, Oxford, National Maritime Museum, BAR International Series 276, p. 319-343.  
2004 The archaeology of the early maritime polities of Southeast Asia, in P. Bellwood, I. C. Glover (eds), *Southeast Asia: from Prehistory to History*, London, Routledge Curzon, p. 282-313.  
2019 Sewn Boats of Southeast Asia: the stitched-plank and lashed-lug tradition, *IJNA* 48.2, p. 400-415.
- POMEY P.  
2010 De l'assemblage par ligatures à l'assemblage par tenons et mortaises. Introduction, in P. Pomey (ed.), *Transferts technologiques en architecture navale méditerranéenne de l'Antiquité aux temps modernes: identité technique et identité culturelle, Actes de la Table Ronde, Istanbul 2007*, Istanbul, Institut Français d'Etudes Anatoliennes, Varia Anatolica XX, p. 15-26.
- STAPLES E., BLUE L.  
2019 Archaeological, Historical, and Ethnographic Approaches to the Study of Sewn Boats: past, present, and future, *IJNA* 48.2, p. 269-285.

# THE PENGLAI 3 SHIPWRECK IN CONTEXT: KOREAN SHIPBUILDING IN THE LATE 14<sup>TH</sup> AND EARLY 15<sup>TH</sup> CENTURIES

Damien PELADAN

---

## Abstract

The latest developments in Korean nautical archaeology have provided a clearer picture of what medieval shipbuilding in Korea looked like. However, the Penglai 3 shipwreck, excavated in China and dated to the late 14<sup>th</sup> or early 15<sup>th</sup> century, though unequivocally Korean in its basic structure, shows features which have never been seen before or since on other Korean shipwrecks. The present paper aims to explain the uniqueness of this ship by examining the specific historical context in which it was built, at a time when the Korean court was conducting experiments with various techniques.

## Keywords

Korea, Middle Ages, Penglai, shipbuilding

## Résumé

Les derniers développements de l'archéologie navale coréenne ont fourni une image plus claire de la construction navale coréenne à l'époque médiévale. Cependant l'épave *Penglai 3*, fouillée en Chine et datée de la fin du xiv<sup>e</sup> ou du début du xv<sup>e</sup> siècle, bien que clairement coréenne dans sa structure de base, présente des caractéristiques qui n'ont jamais été observées ailleurs sur d'autres épaves coréennes. Cet article vise à expliquer le caractère unique de ce navire en examinant le contexte historique spécifique dans lequel il a été construit, à une époque où la cour coréenne poursuivait diverses expériences techniques.

## Mots-clés

Corée, Moyen Âge, Penglai, construction navale

---

For most of its history, Korea has had its own unique shipbuilding tradition, distinct from the neighbouring countries of Japan and China, a fact which has recently come to light thanks to the development of underwater and intertidal naval archaeology in South Korea. The first ancient shipwreck was excavated in 1984, followed by a second one in 1995. Since then, the pace of discovery has been rapidly increasing, to the point that so far 13 ancient wrecks have been excavated in Korean waters, and two others in the city of Penglai in Shandong province, China. The vast majority of these shipwrecks are dated to the Middle Ages (fig. 1), so we now possess a good overview of what medieval Korean shipbuilding looked like, especially for the Koryŏ era (918-1392), when maritime activity was at its greatest in the waters of the peninsula.

However, among these 15 wrecks, the Penglai 3 shipwreck (one of the two excavated in Penglai, China, in 2005) stands out from the lot: although typically Korean in its basic structure and building techniques, it exhibits features which have never been observed on wrecks excavated within Korean waters, some of which were clearly influenced by Chinese shipbuilding. Several hypotheses have been proposed to explain these peculiar shapes. For some archaeologists, they are the result of technology transfers from China to Korea at the time of the failed Mongol invasions of Japan (in 1274 and 1281), when the Mongols ordered the newly conquered Korean court to construct an invasion fleet using Chinese shipbuilding techniques (Yuan 2011, p. 54). However, the very same historical source which reports this fact also

states that the costs of such an enterprise would have been too high and it would have taken too long, so the Koreans ended up using indigenous techniques<sup>1</sup>. It is therefore rather doubtful that this event would have been the occasion of considerable technology transfers. Moreover, the Tallido shipwreck, excavated in 1995 and dated to the second half of the 13<sup>th</sup> or first half of the 14<sup>th</sup> century does not exhibit any of the features found on the Penglai 3 wreck. Another explanation is that the Penglai 3 was in fact an oceangoing ship, designed to cross the sea from Korea to China, while the wrecks found within Korean waters were coasters, which would explain its singularities (Kim 2009, p. 265-266). However, a few metres away from the Penglai 3, the remains of another Korean wreck were also excavated, the Penglai 4, which does not exhibit any of the characteristics of the Penglai 3, somewhat undermining this hypothesis. Moreover some of these special features have also been found on contemporaneous wrecks in Korean waters, as we shall discuss below.

The present paper thus aims to explain the uniqueness of the Penglai 3 shipwreck through its specific historical context, as it was built at a time when the Korean court, facing many challenges from across the sea, was experimenting with various techniques in order to improve its own navy.

---

1. KRS: 104, 10b *Kim Panggyŏng chŏn* ("Biography of Kim Panggyŏng"), 15<sup>th</sup> year of Wŏnjong's reign (1274).

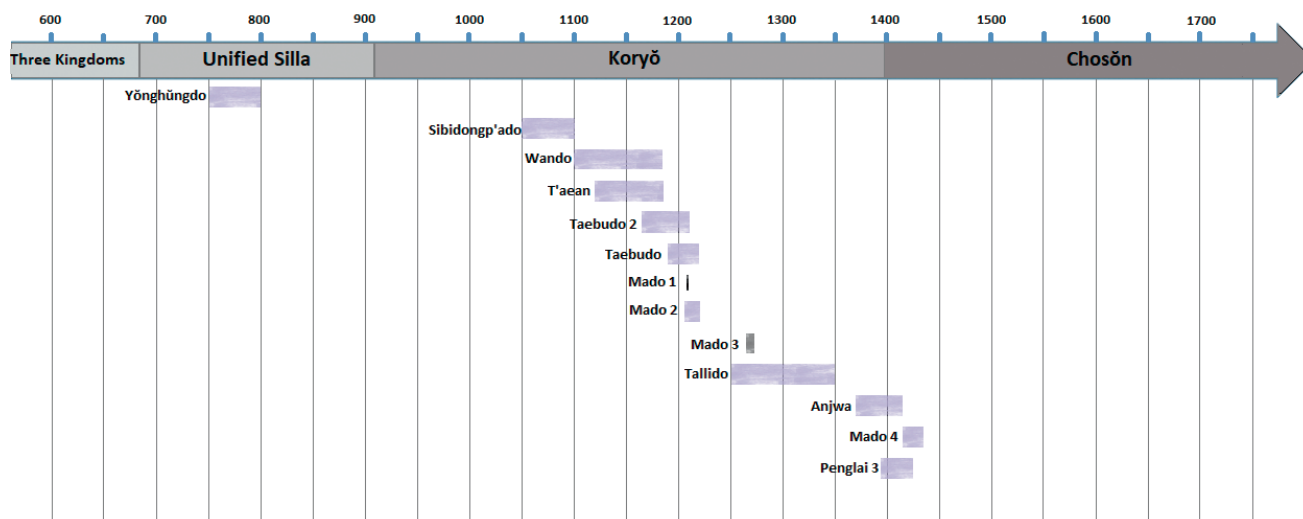


Fig. 1: Ancient Korean shipwrecks excavated from 1983 to 2019.

## 1. OVERVIEW OF MEDIEVAL KOREAN SHIPWRECKS AND SHIPBUILDING

First and foremost, let us begin with an overview of Korean shipbuilding in the Koryŏ era. Traditional Korean ships were entirely made of wood (mostly pinewood) and had the particularity of not using any iron nails or clamps in their structure. The components of the hull were joined together using grooved clinker joints, mortise-and-tenon joints, wooden pegs and wedges. They were flat bottomed so as to navigate safely the coastal waters of the peninsula, strewn with mudflats and intertidal zones. The bottom was made of an odd number of rows of thick planks (usually 3, 5 or in some cases 7)<sup>2</sup>, which were held together using a long wooden peg (called *changsak*) going through the whole width of the bottom planking. In earlier wrecks, these bottom planks tended to be very thick, and then got thinner over time.

The side strakes were attached on either side of the bottom planking, rising at a steep angle, and joined together using an elaborate system of grooved clinker joints and wooden pegs (called *p'isak*). The strakes on both sides were then held together using throughbeams arranged in rows, which would act as a frame. The way these strakes were connected to the bottom planks evolved over time. While earlier ships used one or two rows of L-shaped chine strakes on either side to serve as a transition, these seem to have been completely abandoned in the early 13<sup>th</sup> century. From then on, the bottom side strakes were directly attached to the bottom planking using a groove joint. Korean shipwrights would typically waterproof the hull by tightly packing rice straw rope in between the planks.

All of the wrecks dated from the 11<sup>th</sup> to 14<sup>th</sup> centuries had only one mast, as evidenced by the two slots carved in the centre of the middle bottom plank, where the mast support was directly inserted, without any intermediary mast step. Textual evidence from the early 12<sup>th</sup> century confirms that it was the

norm for Korean ships to have only one mast<sup>3</sup>. It was placed forward of the central row of throughbeams, against which it directly rested (Lee Chul-Han, Sasaki Randall 2010).

The size of the ships varied according to their use, from about 9 m for the smaller (Wando shipwreck) to 30 to 40 m long in the case of the Naju shipwreck, although only a few bottom and side strakes have been found. The length of most of the ships ranged from 12 to 17 m (Mun 2014, p. 171-184) (fig. 2).

## 2. THE CHARACTERISTICS OF THE PENGLAI 3 SHIPWRECK

As stated above, the Penglai 3 shipwreck is the most peculiar Korean shipwreck excavated to date. Dating from the late 14<sup>th</sup> to early 15<sup>th</sup> century (but no later than 1420) (Kim 2009, p. 259-260), it is rather large in comparison to most Korean wrecks (the ship's reconstructed length is estimated to be about 22 m). As is the case of other Korean ships, it was primarily made of pinewood. Flat bottomed, its side strakes were fastened using grooved clinker joints and wooden pegs, and its overall shape and basic structure can be qualified as typically Korean.

On the other hand, it used bulkheads instead of throughbeams in order to strengthen the hull. Furthermore, a plank resembling a keelson was attached on top of the middle row of bottom planks, and iron nails were also used along with the wooden pegs in order to reinforce the structure of the hull. It also had two masts, as evidenced by the presence of two mast steps, another innovation never found on other Korean ships, and it used a lime-based compound as luting material, as opposed to typical rice straw rope waterproofing (fig. 3-4).

Most of these features can be traced back to either Chinese or Japanese shipbuilding. The use of bulkheads for instance is ubiquitous in Chinese shipbuilding, as is the use of keelsons

2. The only exception is the Taebudo 2 shipwreck, which has four bottom planks. All the other wrecks have an odd number.

3. Xu Jing (1091-1153), *Xuanhe fengshi Gaoli tujing* ("Illustrated Account of an Official Mission to Korea during the Xuanhe Reign"), Book 33, *Xunchuan* ("Patrol ships"); *Guanchuan* ("Government ships").

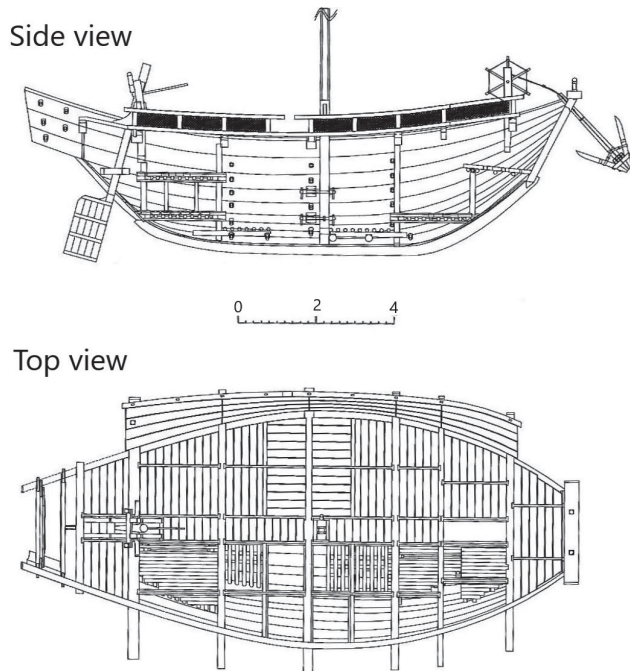


Fig. 2: Reconstruction of Mado 1 shipwreck (sank in 1208) (from NRMCH 2015, p. 118). This class of ship probably corresponded to *ch'omasŏn* (government-operated tax transport ships).

(which is not surprising as Chinese seagoing junks possessed a V-shaped hull constructed around a keel), mast steps and lime-based caulking compound. However, Chinese caulking compound mixed tung oil with the lime as a binding agent, while the compound found on the Penglai 3 ship solely used lime and was, as a result, of poorer quality (Yuan 2011,

p. 52-53). The use of iron nails was also common in both Chinese and Japanese shipbuilding.

The Penglai 3 can be compared to two other wrecks dating from the same period found in Korea. The Anjwa shipwreck, dated to the late 14<sup>th</sup> century, is one of the largest Korean ships excavated to date, with an estimated total length of 17 m. The cross section of the hull shows a flat bottom with a gentle wine-glass-like turn of the bilge, slightly more elegant than earlier shipwrecks, with similarities to the Penglai 3. Although it does not have any mast step, the two mast slots on the middle bottom plank were dug into a slightly elevated platform carved on the plank, to which it added an extra third in width, a feature that so far has only been observed on this shipwreck. Another interesting point of the Anjwa ship is that it used, in addition to the traditional rice straw rope stuffed in between the planks as waterproofing, a lime-based luting material similar to the one found on the Penglai 3 (NMM 2006, p. 32, 81, 88 and 96). In fact, historical records show that Koreans knew about using lime as a luting material at least since 1412 (CWS: 1412.5.21 [3]), but only learnt about the Chinese technique of mixing tung oil (or, when not available, fish oil or sesame oil) with the lime in 1451 (CWS: 1451.3.3 [2]).

Another contemporaneous point of comparison for the Penglai 3 is the Mado 4 shipwreck (NRMCH 2016). Excavated in 2015, it was a government operated tax transport ship which sank en route while sailing from the south to the capital, sometime between 1417 and 1425. It is the most recent medieval wreck to be found, dating from roughly the same period as the Penglai 3. It too has a few noteworthy features, such as the sparing use of iron nails, as well as two sets of mast slots on the middle row of bottom planks, indicative of a second mast, something which had never been witnessed on earlier wrecks found in Korean waters. As the wreck has not yet been dismantled for study, we do not know what type of caulking was used.

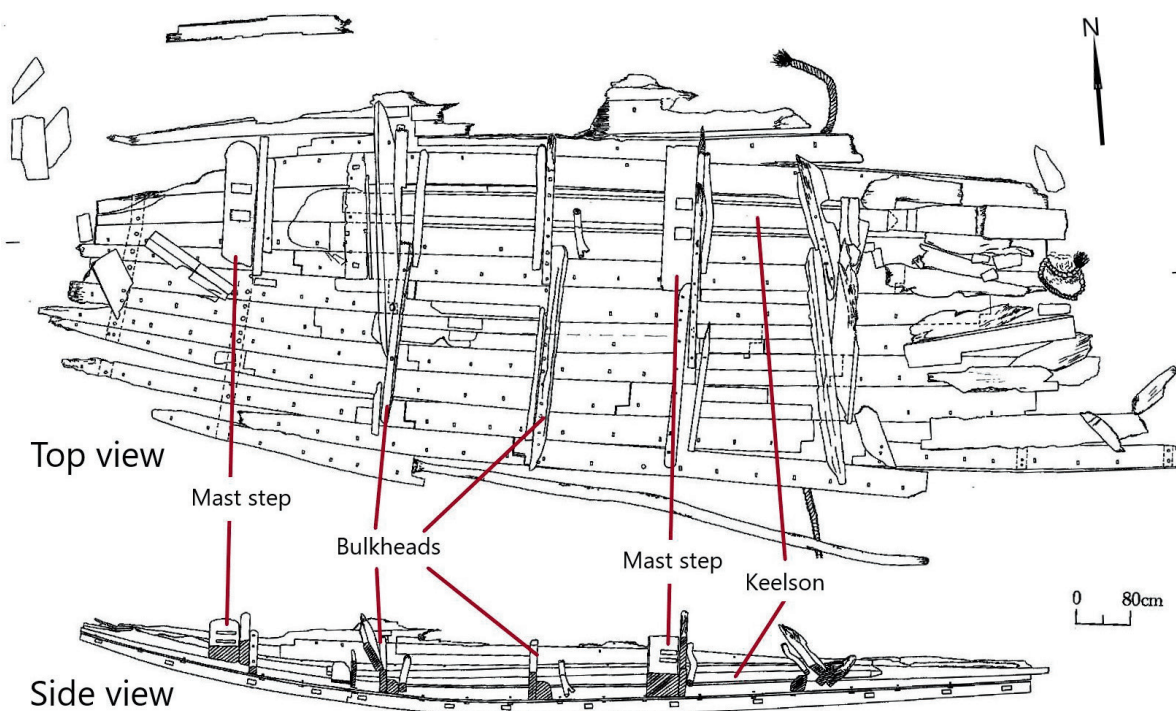


Fig. 3: Remains of the Penglai 3 shipwreck (from CR&AISP 2006, p. 36).



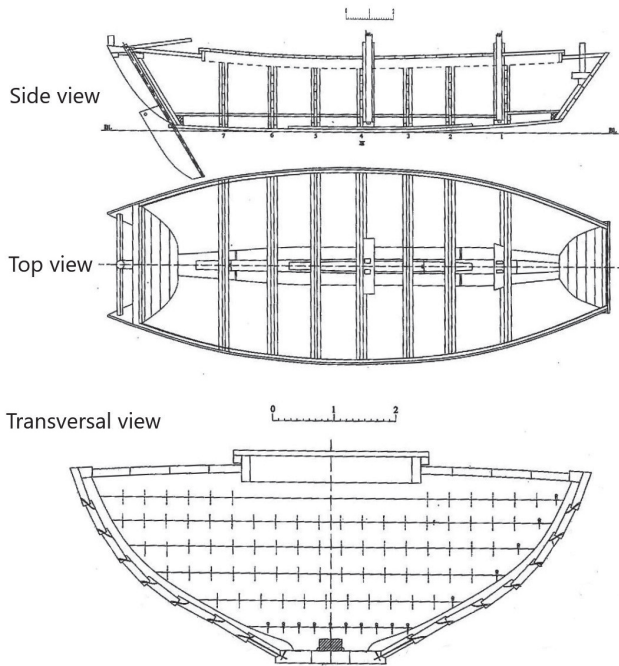


Fig. 4: Reconstruction of the Penglai 3 shipwreck (from CR&AISP 2006, p. 118).

In summary, even though most of the features found on the Penglai 3 shipwreck can be traced back to Chinese and Japanese shipbuilding, some of them are also present on other Korean shipwrecks of the same time period, hinting at the fact that these innovations were not restricted to the Penglai 3, nor were they necessarily particular to oceangoing ships, but were in fact the result of a broader current within Korean society. It is thus essential, in order to explain the characteristics of the Penglai 3, to look deeper into the historical background of the late Koryŏ and early Chosŏn era.

### 3. EVOLUTION OF SHIPBUILDING IN THE LATE 14<sup>TH</sup> AND EARLY 15<sup>TH</sup> CENTURY

In the second half of the 14<sup>th</sup> century, the Korean peninsula was faced with an unprecedented challenge coming from across the seas: Japanese pirate fleets, gathering sometimes up to several hundred ships, raided the Korean coast year after year, rampaging and plundering villages, temples, towns, military outposts and of course ships, and capturing the populations to be sold as slaves on Japanese markets. The Koreans soon realized that their navy was ill equipped to fend off these attacks and started building new warships from the 1370s and 1380s onwards, progressively taking back control of their waters. These efforts were carried on into the new Chosŏn dynasty (1392-1910). In this process of rebuilding its naval might, the Korean court started paying a great deal of attention to Chinese and Japanese shipbuilding techniques and comparing them to their own, especially during the first half of the 15<sup>th</sup> century. They would compare the structure of the hull, the materials used for the sails and anchors (CWS: 1446.9.9 [2]), the types of wood (CWS: 1430.5.24 [1]), etc.

However, the curiosity for foreign shipbuilding techniques did not stop at mere observation. Indeed, Korean authorities

invited Japanese shipwrights to Korea, and had them build ships there (CWS: 1417.5.19 [2]). These ships were not meant to replace indigenous shipbuilding, but rather were used to conduct various experiments. For example, in 1413, the king ordered the conduct of speed comparisons between Japanese and Korean ships. As it turned out, the Japanese ship outsailed its Korean counterpart by 30 to 40 paces when sailing with the current, and over 100 paces when going against (CWS: 1413.1.14 [1]). The Korean authorities thus paid a great deal of attention to the strengths and weaknesses of their own ships compared to foreign vessels and tried to bridge the gap whenever possible. They also used them for experiments in naval warfare, and the development of techniques to counter Japanese tactics, such as the creation in 1415 of “turtle ships” (*kwisŏn*), warships whose upper deck was covered with a spiked roof to serve as protection against projectiles and to prevent the enemy from boarding (CWS: 1415.7.16 [2]). In other instances, Japanese ships built in Korea were also used as target practice for the newly developed cannons (CWS: 1445.9.22 [2]).

Scholars who have studied the Penglai 3 usually assume that the iron nails were introduced to Korea from China, but one cannot rule out the influence of Japanese shipbuilding in this regard. For instance, in 1421, local authorities in Kyŏngsang Province asked that the 34 Japanese ships captured in Japan two years prior be dismantled and their iron nails taken out to be used for the construction of new warships (CWS: 1421.3.14 [7]). Japanese nails were indeed highly praised by the Koreans, as evidenced by several texts. It is therefore quite possible that the introduction of such nails as seen on both the Penglai 3 and the Mado 4 were, in fact, the result of experimenting with Japanese shipbuilding techniques in the early Chosŏn period.

Evidently, however, Japanese shipbuilding was by no means the only source of inspiration for Korean shipwrights. Chinese techniques, being the most advanced in East Asia at the time, were also the focus of Korean enquiries and experiments. This trend can be traced back to the year 1415, when the king mandated two Chinese men, Liu Siyi and Li Xuan, to conduct experiments with Chinese shipbuilding, because “the military ships in each province before long get eaten by worms and have to be rebuilt after a few years. Not only is it taxing on the workforce, but [Korean] timber resources cannot keep up” (CWS: 1415.11.19 [4]). It is interesting to note that this event occurred roughly around the same time as the Penglai 3 was built. One cannot but wonder if this ship was not, in fact, the direct product of those experiments.

It is quite clear that one of the aspects of Chinese shipbuilding which appealed the most to Korean authorities was durability. The rebuilding of the navy had almost depleted the timber resources of the peninsula, to the point that the Chosŏn court had to create state forests all along the coast in 1448 (CWS: 1448.8.27[1]). Chinese ships had the reputation of lasting much longer than their Korean counterparts, in part due to the use of double planking, a technique with which the Korean court also experimented in the 1430s and 1440s (CWS: 1430.5.24 [1]). This particular experiment was eventually discontinued in 1451 since it was not producing the desired effect, while being more costly than single-layer planking (CWS: 1451.6.12 [4])<sup>4</sup>.

4. Interestingly enough, the Koreans tried to build a double-planked hull during the initial construction of the ship (see for example CWS: 1451.5.25 [3]), while Chinese shipwrights tended to add outer layers of planking later in the life of the ship, as the first layer became worn.

## 4. CONCLUSION

In conclusion, the peculiar appearance of the Penglai 3 shipwreck cannot be separated from the specific historical context in which it was built. It was not the result of technology transfers in the late 13<sup>th</sup> century nor a typical oceangoing Korean vessel, as much as it was the product of the numerous experiments conducted by Korean authorities in the early 15<sup>th</sup> century, as evidenced by the fact that some of its unusual features have also been found on other contemporaneous ships excavated in Korean waters.

The enthusiasm of Korean authorities for such innovation and experimentation started to wane in the second half of the 15<sup>th</sup> century. Many of the techniques newly introduced, such as double planking for the hull, iron anchors, and indeed most of the hybrid features found on the Penglai 3, seem to have been abandoned thereafter. Some of them, however, were retained by Korean shipwrights, and remained an integral part of Korean shipbuilding until the early 20<sup>th</sup> century. Indeed, although no Korean wreck later than the early 15<sup>th</sup> century has been discovered so far, we know from pictorial and textual evidence from the 18<sup>th</sup> and 19<sup>th</sup> centuries that some of the features adopted in the early Chosŏn period became the norm, such as the use of iron nails as a supplement to wooden pegs (NRIMCH 2016, p. 388), and the construction of two-masted ships, which seem to have become common for middle-sized and larger ships for

most of the Chosŏn period, from fishing vessels to warships (NRIMCH 2012, p. 139-158). In this respect, it seems fair to say that the late 14<sup>th</sup> and early 15<sup>th</sup> centuries were a defining period for Korean shipbuilding.

## ACKNOWLEDGMENTS

The participation of the author in the ISBSA conference in Marseille was made possible by the *Seafaring: Maritime knowledge in the South China Seas* project (ANR/Ecole française d'Extrême-Orient, Paris/Academia Sinica, Taipei).

## LIST OF ABBREVIATIONS

CR&AISP: Cultural Relics & Archaeological Institute of Shandong Province, based in the city of Penglai, China.

CWS: *Chosŏn Wangjo Sillok (Veritable Records of the Chosŏn Dynasty)*.

KRS: *Koryŏsa (History of Koryŏ)*, compiled in 1451.

NMM: National Maritime Museum, present day National Research Institute of Maritime Cultural Heritage (see below).

NRIMCH: National Research Institute of Maritime Cultural Heritage, based in the city of Mokp'o (South Korea).

## REFERENCES

### CULTURAL RELICS & ARCHAEOLOGICAL INSTITUTE OF SHANDONG PROVINCE

2006 *Penglai guchuan* ("Ancient ships from Penglai"), Beijing, Wenwu Chubanshe.

### KIM SŌNGBŌM

2009 Chungguk Pongnae susŏng ch'ult'o Koryŏsŏn ("Koryŏ shipwrecks excavated in the Penglai Shuicheng in China"), in *Hanguk Chungsesa Yŏn'gu* 27, p. 233-284.

### MUN KYŒNGHO

2014 *Koryŏ sidae chounjedo yŏn'gu* ("Research on the Koryŏ Era Tax Transport System"), Seoul, Hyeon.

### NATIONAL MARITIME MUSEUM

2006 *Anjwasŏn palgul pogosŏ* ("Excavation report of the Anjwa shipwreck"), Mokp'o.

### NATIONAL RESEARCH INSTITUTE OF MARITIME CULTURAL HERITAGE

2012 *Chounsŏn – Chŏnt'ong sŏnbak chosŏn kisul* ("Tax transport ships – Traditional shipbuilding techniques"), Mokp'o.

2015 *Koryŏ sidae chounsŏn (Mado Ihosŏn) pog'wŏn pogosŏ* ("Report on the Reconstruction of a Tax Transport Ship (Mado n<sup>o</sup>1) of the Koryŏ Era"), Mokp'o.

2016 *T'aeon Mado 4hosŏn sujung palgul chosa pogosŏ* ("The Mado 4 shipwreck in T'aeon – Underwater excavation report"), Mokp'o.

### YUAN XIAOCHUN

2011 *Pongnae Koryŏ (Chosŏn) kosŏn-ŭi kujo-wa t'ŭkchŏng* ("Structure and specificities of the Penglai Korean ships"), in National Research Institute of Maritime Cultural Heritage (ed.), *Koryŏ-ŭi nanp'asŏn-gwa munhwasa* ("Koryŏ Shipwrecks and Cultural History"), Mokp'o, Research Centre for Island Culture, p. 45-65.

### LEE CHUL-HAN, SASAKI RANDALL

2010 Goryeo Dynasty (918-1392) shipwrecks in Korea, in Kimura Jun (ed.), *Shipwreck ASIA: Thematic Studies in East Asian Maritime Archaeology*, Adelaide, Shipwreck ASIA, p. 56-73.



# A ROMAN SHIP SCUTTLED NEAR SALONA IN THE GULF OF KAŠTELA, CROATIA

David RUFF, Irena RADIĆ ROSSI, Cemal PULAK and Nili LIPHSCHITZ

## Abstract

In 2002, the recovery of a 1000-litre perforated *dolium* in the Trstenik section of Kaštel Sućurac, near Split, Croatia, attracted the attention of archaeologists to significant Roman remains submerged near the shore. A return visit to the site in 2006 identified the outline of a wooden ship scuttled alongside a submerged wooden wall: in 2015, the ship was uncovered and labelled, recorded via photogrammetry and extensively sampled, then preserved *in situ*. Reconstruction determined the ship to be a flat-floored, mortise-and-tenon constructed ship, dated to approximately the late 1<sup>st</sup> century AD, suitable for the transport of heavy cargo.

## Keywords

*Dolium*, flat floor, mortise-and-tenon, Roman Dalmatia

## Résumé

En 2002, la récupération d'un *dolium* perforé d'une capacité de 1000 litres à Trstenik, Kaštel Sućurac près de Split en Croatie, a attiré l'attention des archéologues sur d'importants vestiges romains immergés près du rivage. Une expertise sur le site en 2006 a permis d'identifier les contours d'un navire coulé volontairement le long d'une paroi en bois. C'est finalement en 2015 que le navire a fait l'objet d'un dégagement et d'un marquage avant d'être enregistré par photogrammétrie et largement échantillonné, puis conservé *in situ*. Le travail de reconstruction a permis de déterminer que ce navire assemblé à tenons et mortaises, daté approximativement de la fin du 1<sup>er</sup> siècle apr. J.-C., possédait un fond plat et était adapté au transport d'une cargaison pondéreuse.

## Mots clés

*Dolium*, membrure plate, assemblage à tenon et mortaise, Dalmatie romaine

The geographical region of modern Dalmatia, one of four major regions of modern Croatia, is significantly smaller than the Imperial province of Roman Dalmatia, which was formed in approximately 9 AD by the division of Illyricum into two provinces: Pannonia and Dalmatia (Wilkes 1969, p. 78-80). While the border of Roman Dalmatia is not precisely known, figure 1 overlays the approximate ancient boundary upon a modern map of the Balkan countries. The capital of Roman Dalmatia, Salona (near present-day Split, Croatia), was originally an Illyrian city with Greek presence, taken over by the Delmatae as they pushed westward in approximately the 3<sup>rd</sup> century BCE, and ultimately conquered by Republican Rome in 76 BCE (Stipčević 1977, p. 55-59). Salona, with its central location in Roman Dalmatia coupled with a protected harbour in the eastern Gulf of Kaštela and a connection to the hinterlands through the mountain pass of Klis, was the natural choice for the location of the provincial capital.

Roman underwater archaeological remains have been known in the Gulf of Kaštela since the late 19<sup>th</sup> century, when Roman sarcophagi were located along the Vranjic peninsula, southwest of Salona (fig. 2) (Bulić 1900). Other underwater finds include an accumulation of Dressel 20 and North African cylindrical amphorae discovered near Split in 1958 (Cambi 1975; Radić Rossi 2008), and extensive coastal excavations of the Hellenistic/Roman site of Siculi in the Resnik area of Kaštel Štafilić, in the western part of the Gulf of Kaštela towards Trogir (Kamenjarin, Šuta 2011).

Archaeological attention was attracted to Trstenik, a section of Kaštel Sućurac adjacent to ancient Salona, with the report of "large jars" just off the coast in the muddy bottom of the sea. In October 2002, a seven-day underwater campaign recovered a

1000-liter perforated *dolium* (to date the only complete/unfragmented perforated *dolium* known in the Mediterranean) and identified an accumulation of Dressel 20 amphorae, as well as a 50 m length of ancient wooden sea wall (Radić Rossi 2003). In 2006, during the recovery of Dressel 20 amphorae, the outline of a wooden ship approximately 12 m in length was noted alongside the wooden wall, filled with rocks and scuttled at a depth of about 1,5 m (Radić Rossi 2006, 2007). In 2012, after partial excavation (Radić Rossi, Lete 2012), the hull was found to be in excellent condition, and a complete uncovering with hull photogrammetry was planned for 2015.

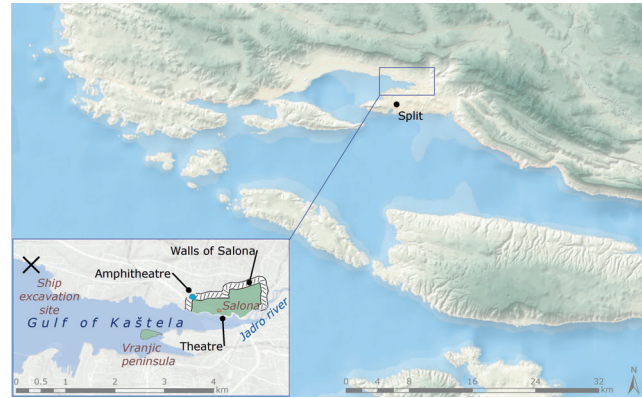
## 1. EXCAVATION AND PHOTOGRAMMETRY

Excavation was conducted in April and May of 2015 by a joint international team, co-directed by Irena Radić Rossi, archaeologist at University of Zadar and David Ruff, PhD candidate at Texas A&M University (Ruff, Radić Rossi 2015). The work was performed by scuba divers entering from shore, with an aluminium grid suspended over the wreck site to support the removal of rocks and overburden both manually and by dredge. Any small artefacts found (a total of 236, the vast majority of which were ceramic shards) were assigned a sequential artefact number, photographed, and described in an artefact log. Many times, removal of rock used to scuttle the ship resulted in 'floating wood,' damaged ship components that began to float away as soon as they were no longer weighed down. When possible, these pieces were reattached to support photogrammetry: if too damaged or the original location was





**Fig. 1:** The boundary of Roman Dalmatia overlaid on the present-day Balkans. Modern Dalmatia is shown in orange (drawing V. Butorac).



**Fig. 2:** Salona in the Gulf of Kaštela. The excavation site is 3 km west of ancient Salona's city walls (drawing V. Butorac).

unknown, they were removed to shore for study and consideration for sampling.

After the ship's hull was uncovered, major components were labelled to support detailed photogrammetry, and additional construction features were enhanced for photogrammetry purposes, including placing white thumbtacks on treenails, yellow thumbtacks on pegs in mortise-and-tenon joints, and white electrical wire into seams to enhance the visibility of planking joints. Photogrammetry was performed three separate times to record the progress of the excavation as different components were revealed, for example before and after the removal of stringers (ceiling planking). By placing metre sticks in the field of view, a scaled three-dimensional model could subsequently be generated using the Agisoft PhotoScan computer programme, allowing for extensive measurement and hull analysis during post-processing. To facilitate photogrammetry, the aluminium grid was lifted and removed from the site prior to taking pictures, then returned before the continuation of work.

Following photographic documentation, construction details of the hull were recorded by hand, and extensive sampling of hull components for wood species was undertaken (Lipshitz *et al.* 2018). The ship was then reburied and covered with geotextile, sand and rock to preserve it *in situ* for potential future investigation.

## 2. HULL REMAINS

The Trstenik ship was scuttled in an east-west orientation against a wooden sea wall, with its bow tentatively identified to the east based on two observations, the presence of a space between the frames on the western end that often is reserved for the bilge pump and the multiple notched frames to the east which would have supported the missing mast step. The wall preserved the curvature of the (port) hull to the north, while the weight of the rocks broke and flattened the (starboard) hull to the south, extending the total number of strakes preserved for analysis. The ship was built shell-first, the planking being assembled by pegged mortise-and-tenon joints. The keel-stem-sternpost assembly was made of three timbers securely scarfed together: the shell construction began with laying 11 strakes,

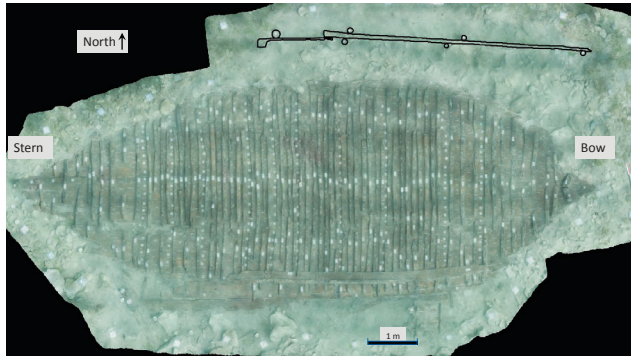
then an alternating wale/strake/wale/strake/wale pattern. Limited remains prevent exact determination of the number of strakes installed above the third wale. The ship had a total of 69 preserved frames (numbered from 11 aft to 79 forward), most with a single limber hole over the keel, attached to the planking with treenails driven from the outside of the hull. No frames were attached to the keel/stem/sternpost timber assembly. Stringers were nailed and treenailed longitudinally across the frame tops for internal support. The mast step was not present in the remains: apparently it was removed prior to scuttling for possible reuposing.

### 2.1. KEEL-STEM-STERNPOST ASSEMBLY

The keel-stem-sternpost assembly of the Trstenik ship consisted of three timbers scarfed together: a 1.8 m section of sternpost made of ash (*Fraxinus excelsior*), an 8.7 m length of beech (*Fagus sylvatica*) that composed the keel, and a 1.7 m section of stem fashioned from elm (*Ulmus campestris*). It is likely that an additional timber was scarfed onto the surviving stem and sternpost pieces to complete the curvature and add the required height for hull construction, but no archaeological evidence for them has survived. The width of the assembly varied from 10 to 12 cm with the thickest section amidships: as the ship was not fully excavated and dismantled, the depth of the assembly and the details of the rabbet for the attachment of the garboard strakes could not be determined. While the two scarfs (one directly underneath frame 17, the other between frames 75 and 76) were not disassembled for study, there was no visual evidence for any bolt or vertical locking device or key. This lack of bolting a floor timber directly through the keel scarfs in the Trstenik ship is consistent with the ship predating the 2<sup>nd</sup> century AD "Western Roman Imperial" tradition, which is characterised by bolted frames often associated with a keel scarf to provide reinforcement (Pomey *et al.* 2012, p. 237, 306).

### 2.2. STRAKES AND WALES

The hull of the ship was formed by planks scarfed together with mortise-and-tenon joinery. Strake widths vary, with typical



**Fig. 3:** The Trstenik ship with stringers removed except for stringer S23. The ship was scuttled on an east-west axis. North is to the top, as is the shoreline (50 m distant today) and the ancient wooden wall (black lines at top): bow to right (orthophotograph D. Ruff).

widths between 16 and 18 cm: some narrow sections are as thin as 13 cm and the widest section measured 23 cm. Strake thickness measured at the ship's edges was 4-5 cm, although this requires confirmation by disassembling and measuring the planking in multiple zones of the ship. Samples taken for tree species identification determined that the majority of the hull was constructed from Aleppo pine (*Pinus halepensis*) and black pine (*Pinus nigra*), with a lesser contribution from cypress (*Cupressus sempervirens*): one sample each of Scots pine (*Pinus sylvestris*) and stone pine (*Pinus pinea*) were also noted. There was no obvious pattern to the selection of wood for use in planking, and the choice of wood for stringers was very similar to that of the strakes. Due to dense framing and an internal coating of pitch obscuring strake joinery, evaluation of the mortise spacing pattern and consistency requires additional study following hull disassembly, measurements, and statistical analysis. Two hull repairs were noted, one in the after section of the second strake and one amidships in the third strake, both on the port side. Additional repairs are likely to be noted in the future upon re-examining the hull after the dense framing amidships and the pitch coating the interior of the planking are removed.

The Trstenik hull displays three surviving wales on the starboard and two on the port sides, with varying degrees of completeness. The cross sections of the five wales appear to be fairly regular and consistent, measuring approximately 10 cm wide, and roughly 5 cm in thickness where measurements could be taken. The wales are flush mounted with the planking inside the ship but protrude beyond the hull planking externally. Each of the five surviving wales was sampled, and all are made of stone pine (*Pinus pinea*). This is a noteworthy result, as only one frame component and one strake length were made of stone pine. Thus, this particular tree species was preferred for the long run of wales, yet it was not a commonly used species elsewhere in the ship. No scarfs were observed in any of the wales.

### 2.3. FRAMES

The Trstenik ship had a total of 69 surviving frames, and 214 frame components were individually labelled with unique numbers (fig. 3). These 214 frame components were all 'stand-alone' pieces. Although some frame components were physically touching one another, in no case was a frame component scarfed

or connected to an adjacent frame component. Lengths of the frame components varied widely, with the shortest at 20 cm and the longest over 2 m. While frame height above the hull planking was typically 6-8 cm (moulded), frame widths varied more widely, from 4-10 cm (sided). The frames numbered from 15 to 74, for a total of 60 consecutive frames, all consist of floor timbers: 11 of these floor timbers have notches cut over the keel, some of which must have keyed into the ship's mast step. The frames are attached to the hull by treenails: no iron nails were noted attaching frames, and no frames are attached to the keel. Of 27 treenails sampled, 19 were made of sycamore (*Acer pseudoplatanus*). With few exceptions, the centreline floor frames have a semicircular limber hole notched directly over the keel, typically 4-6 cm in width.

There are two distinct patterns of frame density visible in the Trstenik ship. The central section of the ship based on frame density stretches from frame 21 to frame 67. These 47 frames span over a length of 5.9 m, with an average centre-to-centre spacing of 12.8 cm. With the average width of frames approximately 6.5 cm (sided), visually and mathematically half of the central portion of the ship's hull is covered by these frame components. The gaps between frames in the central section of the hull vary, from as little as 2.5 cm to over 7 cm. In contrast, the stern of the ship, stretching 2.25 m between frames 11 and 21, has an average frame spacing of 22.5 cm, and the bow, stretching 2.6 m between frames 67 and 79, has an average spacing of 21.7 cm. This wider spacing forward and aft produces much wider gaps: for example, the gap between the edges of frame components F69 and F70 is 20 cm. The forward-most frame (frame 79) is a robust cant frame, with two sections sawn from the same piece of ash (*Fraxinus excelsior*): visible staining on the hull interior aft of the after-most frame would indicate a similarly large frame that did not survive.

The selection of tree species from which the Trstenik ship's frames were fashioned is by no means homogeneous, consistent, or repetitive. Of the 214 surviving frame components, 182 were sampled for tree species identification (resulting in 13 different species of wood), of which 100 are softwoods (conifers) and 82 are hardwoods. Aleppo pine was clearly the workhorse frame material selected when building the Trstenik ship, comprising 46% of the total frame components sampled. Among those sampled, there are more Aleppo pine frame components (84) than from all deciduous tree sources combined (82). The most common hardwood is sweet chestnut (*Castanea sativa*, 23 samples), followed by ash (*Fraxinus excelsior*), sessile oak (*Quercus petraea*) and Turkey oak (*Quercus cerris*) each with 14 samples. A total of 17 different tree species were identified on the Trstenik ship. This large diversity may hint at a timber acquisition or supply problem, lesser construction care, or a combination of both factors (Guibal, Pomey 2003, p. 38, 41).

### 2.4. STRINGERS

Multiple lengths of timber were nailed longitudinally across the tops of frames. This internal planking, termed stringers here but also known as ceiling, or ceiling planking, protected the hull from direct contact with cargo, and also likely provided attachment points for the fastening of ship's equipment, such as deck support stanchions or a bilge pump. These stringers provided some amount of longitudinal stiffening as well as internal support structure to protect the frames from the cargo. The

stringers were attached to the frames with both treenails and nails, some of which may have been of iron based on rust stains. The wood species used are very similar for both strakes and stringers, suggesting that the lumber supplied for both strakes and stringers came from a common source.

## 2.5. RADIOCARBON DATING

Two samples submitted to the University of Georgia Center for Applied Isotope Studies for radiocarbon dating resulted in a date range of 24-134 AD, at  $2\sigma$  (95.4%) confidence level. Additional radiocarbon samples, coupled with tree-ring analysis, are required to narrow down the Trstenik ship's construction and operational life span beyond mid-1<sup>st</sup> to early 2<sup>nd</sup> century AD.

## 3. SHIP RECONSTRUCTION

To support a computer reconstruction of the ship's hull, 20 ancient mortise-and-tenon assembled ships were reviewed based on their sharing one or more characteristics with the Trstenik ship, including age, multiple consecutive flat-floored

frames, two or more wales, or a set of reconstructed ship's lines (table 1). The reconstruction was undertaken by importing the photogrammetry model of the Trstenik ship's hull into the Rhinoceros 3D modelling program. Cross sections of the model were taken, including notation of strake seam locations. As the port side of the ship had better preserved its original hull curvature by resting against the wooden sea wall, the starboard hull remains were mirrored on the port side and angled upwards to match the preserved curvature. Strake seams were then connected vertically to create a reconstructed cross section for each location, which were then connected longitudinally to define a reconstructed hull. The hull was then smoothed and extended to the height of a hypothetical caprail. Calculation of the hull displacement was based on the draught of the reconstructed hull, and the results are shown in figure 4. The computer model resulted in a hull that displaced 25.1 metric tons at a draft of 0.9 m.

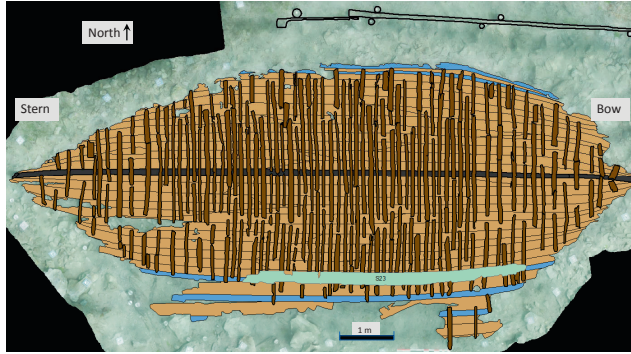
## 4. CONCLUSION

The wooden remains found at Trstenik are from a mortise-and-tenon constructed ship that operated in the mid to late 1<sup>st</sup> or early 2<sup>nd</sup> century AD. Its heavy frame construction was suitable for the transport of heavy cargo at sea, which may have

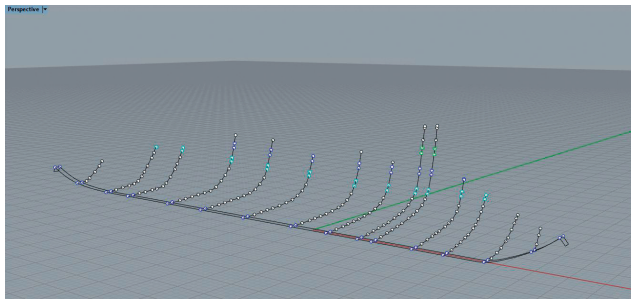
**Table 1:** Trstenik ship reconstruction compendium

|    | Shipwreck         | Contemporaneous with Trstenik +/- 100 years | Multiple consecutive flat-floored frames | Two or more wales | Reconstructed ship's lines | References                                     |
|----|-------------------|---|--|-------------------|----------------------------|--|
| 1  | Laurons 2         |   |  | X                 |                            | Gassend et al. 1984                            |
| 2  | Baie de l'Amitié  | X   | X  |                   |                            | Wicha 2002; Jézégou 2003                       |
| 3  | Balise de Rabiou  | X   |  |                   |                            | Joncheray, Joncheray 2009                      |
| 4  | Barthélemy B      | X   |  |                   |                            | Joncheray, Joncheray 2004a                     |
| 5  | Calanque de l'Âne | X   |  |                   |                            | Ximénès, Moerman 1994, 1998                    |
| 6  | Cavalière         | X   |  |                   | X                          | Charlin <i>et al.</i> 1978                     |
| 7  | Chrétienne C      |   | X  |                   | X                          | Joncheray 1975a                                |
| 8  | Dramont E         |   |  | X                 | X                          | Santamaria 1995; Poveda 2008, 2012             |
| 9  | Dramont F         |   | X  |                   |                            | Joncheray 1975b, 1977                          |
| 10 | Dramont I         | X   |  | X                 |                            | Joncheray, Joncheray 1997                      |
| 11 | Fiumicino 1       |   |  |                   | X                          | Boetto 2000, 2001, 2003, 2008                  |
| 12 | Grado             | X   |  |                   |                            | Beltrame, Gaddi 2007                           |
| 13 | La Bourse         |   |  | X                 | X                          | Gassend 1982                                   |
| 14 | La Giraglia       | X   | X  |                   |                            | Marlier, Sibella 2002; Marlier, Sciallano 2008 |
| 15 | Ladispoli A       | X   | X  |                   |                            | Carre 1993                                     |
| 16 | Lardier 4         | X   | X  |                   |                            | Joncheray, Joncheray 2004b                     |
| 17 | Napoli A          | X   | X  | X                 | X                          | Boetto 2005; Boetto, Poveda 2018               |
| 18 | Pointe de Luque B |   |  | X                 |                            | Clerc, Negrel 1973; Marlier, Sciallano 2008    |
| 19 | Saint-Gervais 3   | X   |  | X                 | X                          | Liou <i>et al.</i> 1990                        |
| 20 | Sud-Lavezzi 2     | X   | X  |                   |                            | Liou, Domergue 1990                            |



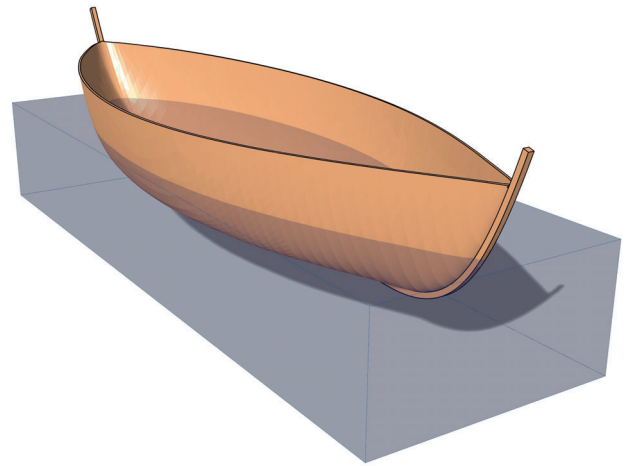


**Fig. 4:** Frame site plan, showing doubled frame density in the centre of ship. Wales are shown in light blue: stringer S23 in light green. North is up: bow to right (drawing D. Ruff).



**Fig. 5:** Reconstructed hull points and lines for each of the 14 sections cut from the photogrammetry model. Coloured section points indicate wales. Bow to right (elaboration D. Ruff).

included raw materials such as construction stone or rough-hewn sarcophagi from the nearby quarries, as well as other heavy loads such as roof tiles or amphorae, into the shallow waters of the Gulf of Kaštela. Its flat-floored design is similar to other contemporary Roman-built ships used for transporting dense cargo such as *dolia* or metal ingots. Since most of the ship's usable components were removed prior to its scuttling and repurposing for use as a sea wall support, its operational



**Fig. 6:** Computer generated reconstruction of hull shape. Displacement can be determined by specifying a draught for the ship and calculating the displaced volume in the computer ocean. Bow to right (elaboration A. Harrell).

employment remains unknown. The 17 different species of wood identified in the remains indicate that its construction was likely performed using whatever wood happened to be available at the time: the exact construction location cannot be determined with certainty based on the tree species used. The vessel was repaired many times during its long operational life and was repurposed to support a wooden sea wall upon the end of its career afloat.

## ACKNOWLEDGEMENTS

This excavation was made possible by the 2015 Claude Duthuit Archaeology Grant from the Institute of Nautical Archaeology (INA). Additional support was provided by Texas A&M University and the University of Zadar. The study of the hull was performed in the framework of the AdriaS Project (IP-09-2014-8211) funded by the Croatian Science Foundation.

## REFERENCES

- BELTRAME C., GADDI D.  
 2007 Preliminary Analysis of the Hull of the Roman Ship from Grado, Gorizia, Italy, *IJNA* 36.1, p. 138-147.
- BOETTO G.  
 2000 New Technological and Historical Observations on the Fiumicino 1 Wreck from Portus Claudius (Fiumicino, Rome), in J. Litwin (ed.), *Down the River to the Sea, Proceedings of the Eighth International Symposium on Boat and Ship Archaeology (ISBSA 8), Gdańsk 1997*, Gdańsk, National Maritime Museum, p. 99-102.  
 2001 Les navires de Fiumicino, in J. Descoedres (ed.), *Ostia, port et porte de la Rome antique*, Genève, Musées d'art et d'histoire, p. 121-129.  
 2003 The Late-Roman Fiumicino 1 Wreck: Reconstructing the Hull, in C. Beltrame (ed.), *Boats, Ships and Shipyards, Proceedings of the Ninth International Symposium on Boat and Ship Archaeology (ISBSA 9), Venice 2000*, Oxford, Oxbow Books, p. 66-70.
- 2005 Le navi romane di Napoli, in D. Giampaola *et al.*, *La scoperta del porto di Neapolis: dalla ricostruzione topografica allo scavo e al recupero dei relitti*, *Archaeologia Maritima Mediterranea* 2, p. 47-91.
- 2008 L'épave de l'Antiquité tardive Fiumicino 1: analyse de la structure et étude fonctionnelle, *Archaeonautica* 15, p. 29-62.
- BOETTO G., POVEDA P.  
 2018 *Napoli A*, un voilier abandonné dans le port de Neapolis à la fin du 1<sup>er</sup> siècle: architecture, fonction, restitution et espace de navigation, in G. Boetto, E. Rieth (eds), *De re navali. Pérégrinations nautiques entre Méditerranée et océan Indien. Mélanges en l'honneur de Patrice Pomey*, Paris, CNRS éditions, *Archaeonautica* 20, p. 19-56.



- BULIĆ F.  
1900 Ritrovamenti risguardanti i sarcofaghi romani sotto il livello del mare nel villaggio di Vranjic presso Salona, *Bullettino di archeologia e storia dalmata* 23, p. 141-2.
- CAMBI N.  
1975 Spanish Amphorae Found Near Split, *Arheoloski vestnik* 26, p. 115-24.
- CARRE M.-B.  
1993 L'épave à *dolia* de Ladispoli (Etrurie Méridionale), *Archaeonautica* 11, p. 29-39.
- CHARLIN G., GASSEND J.-M., LEQUEMENT R.  
1978 L'épave antique de la baie de Cavalière (Le Lavandou, Var), *Archaeonautica* 2, p. 9-93.
- CLERC J., NEGREL J.-C.  
1973 Premiers résultats de la campagne de fouilles 1971 sur l'épave B de la Pointe de la Luque, *Cahiers d'archéologie subaquatique* 2, p. 61-71.
- GASSEND J.-M.  
1982 *Le navire antique du Lacydon*, Marseille, Musée d'Histoire.
- GASSEND J.-M., LIOU B., XIMÉNÈS S.  
1984 L'épave 2 de l'anse des Laurons (Martigues, Bouches-du-Rhône), *Archaeonautica* 4, p. 75-105.
- GUIBAL F., POMEY P.  
2003 Timber Supply and Ancient Naval Architecture, in C. Beltrame (ed.) *Boats, Ships and Shipyards, Proceedings of the Ninth International Symposium on Boat and Ship Archaeology (ISBSA 9), Venice 2000*, Oxford, Oxbow Books, p. 35-41.
- JÉZÉGOU M.-P.  
2003 Epave *Baie de l'Amitié*, in Bilan Scientifique du BRASSM 1998, Paris, Ministère de la Culture et de la Communication, p. 28-29.
- JONCHERAY J.-P.  
1975a *L'épave «C» de la Chrétienne*, Fréjus, Cahiers d'archéologie Subaquatique 1<sup>er</sup> Suppl.  
1975b Une épave de bas empire: Dramont F, *Cahiers d'archéologie subaquatique* 4, p. 91-140.  
1977 Mediterranean Hull Types Compared 2. Wreck F from Cape Dramont (Var), France, *IJNA* 6.1, p. 3-7.
- JONCHERAY A., JONCHERAY J.-P.  
1997 Dramont I, description et étude de la coque d'une épave de marbres d'Asie Mineure du premier siècle après J.-C., *Cahiers d'archéologie subaquatique* 13, p. 165-195.  
2004a L'Épave Barthélemy B, à Saint-Raphael (Var, France), *Cahiers d'archéologie subaquatique* 15, p. 7-72.  
2004b L'épave Lardier 4, à la Croix-Valmer (Var, France), *Cahiers d'archéologie subaquatique* 15, p. 73-117.  
2009 L'épave romaine de la Rabiou, Saint-Tropez (Var), *Cahiers d'archéologie subaquatique* 17, p. 63-102.
- KAMENJARIN I., ŠUTA I.  
2011 *Antički Sikuli: Katalog Izložbe*, Kaštel Lukšić, Muzej grada Kaštela.
- LIOU B.  
1973 Recherches archéologiques sous-marines, *Gallia* 31, 2, p. 571-608.  
1975 Recherches archéologiques sous-marines, *Gallia* 33, 2, p. 571-605.
- LIOU B., DOMERGUE C.  
1990 Le commerce de la Bétique au 1<sup>er</sup> siècle de notre ère. L'épave *Sud-Lavezzi* 2 (Bonifacio, Corse du Sud), *Archaeonautica* 10, p. 11-123.
- LIOU B., GASSEND J.-M., ROMAN R.  
1990 L'épave *Saint-Gervais 3* à Fos-sur-Mer (milieu du 1<sup>er</sup> siècle ap. J.-C). Inscriptions peintes sur amphores de Bétique. Vestiges de la coque, *Archaeonautica* 10, p. 157-264.
- LIPHSCHITZ N., RADIĆ ROSSI I., PULAK C., RUFF D.  
2018 The Roman Ship found at Trstenik (Gulf of Kaštela, Croatia): The Determination of Wood Species, *Skyllis* 17.2, p. 148-152.
- MARLIER S., SCIALLANO M.  
2008 L'épave à *dolia* de l'île de la Giraglia (Haute-Corse), *Archaeonautica* 15, p. 113-121.
- MARLIER S., SIBELLA P.  
2002 La Giraglia, a *Dolia* Wreck of the 1<sup>st</sup> Century BC from Corsica, France. Study of Its Hull Remains, *IJNA* 31.2, p. 161-171.
- POMEY P., KAHANOV Y., RIETH E.  
2012 Transition from Shell to Skeleton in Ancient Mediterranean Ship-Construction: Analysis, Problems, and Future Research, *IJNA* 41.2, p. 235-314.
- POVEDA P.  
2012 Hypothetical Reconstruction of the *Dramont E* Shipwreck, in N. Günserin (ed.) *Between Continents, Proceedings of the Twelfth Symposium on Boat and Ship Archaeology (ISBSA 12), Istanbul 2009*, Istanbul, Ege Yayınlar, p. 331-336.  
2017 Les modèles tridimensionnels de l'épave *Dramont E*. Hydrostatique et réalité virtuelle au service de la restitution en archéologie navale, *Archaeonautica* 19, p. 27-40.
- RADIĆ ROSSI I.  
2003 Potonuli Tragovi Rimskoga Gospodarskog Kompleksa u Kaštel Sućurcu, *Kaštelanski zbornik* 7, p. 153-177.  
2006 Kaštel Sućurac: Trstenik, *Hrvatski arheoloski godišnjak* 3, p. 402-404.  
2007 Kaštel Sućurac: Trstenik, *Hrvatski arheoloski godišnjak* 4, p. 456-458.  
2008 Recenti scoperte sottomarine nella baia di Kaštela, in R. Auriemma, S. Karinja (eds), *Terre di mare: L'archeologia dei paesaggi costiere e le variazioni climatiche*, Trieste, Università degli studi di Trieste, p. 285-298.
- RADIĆ ROSSI I., LETE N.  
2012 Kaštel Sućurac: Trstenik, *Hrvatski arheoloski godišnjak* 9, p. 718-721.
- RUFF D., RADIĆ ROSSI I.  
2015 Excavation of an Early Imperial Roman Ship at Trstenik in the Gulf of Kaštela, Croatia, *INA Quarterly* 42.4, p. 10-17.
- SANTAMARIA C.  
1995 *L'épave Dramont 'E' à Saint-Raphaël (1<sup>er</sup> siècle ap. J.-C.)*, Paris, éditions du CNRS, *Archaeonautica* 13.
- STIPČEVIĆ A.  
1977 *The Illyrians: History and Culture*, Park Ridge NJ, Noyes Press.
- WICHA S.  
2002 Hérault. Au large d'Agde. Épave *Baie de l'Amitié*, Bilan Scientifique du DRASSM 2001, Paris, Ministère de la Culture et de la Communication p. 43-44.
- WILKES J.  
1969 *Dalmatia*, Cambridge (USA), Harvard University Press.
- XIMÉNÈS S., MOERMAN M.  
1994 La fouille de l'épave 1 de la calanque de l'Âne, *Cahiers d'archéologie subaquatique* 12, p. 95-112.  
1998 Fouille de l'épave de la Calanque de l'Âne (Marseille), in P. Pomey, E. Rieth (eds), *Construction navale maritime et fluviale. Approches archéologique, historique et ethnologique, Actes du 7<sup>e</sup> Colloque international d'Archéologie navale (ISBSA 7), île Tatihou 1994*, Paris, éditions du CNRS, *Archaeonautica* 14, p. 299-302.

# INITIAL CONSTRUCTION EVIDENCE OF THE BOU FERRER SHIPWRECK, A LARGE VESSEL OF THE EARLY ROMAN EMPIRE

Carlos DE JUAN and Franca CIBECCHINI

## Abstract

We present a basic summary of the research conducted on the Bou Ferrer shipwreck since 2006, which has provided interesting new data about a *navis oneraria* well dated to the second half of the 1<sup>st</sup> century AD. Despite that fact that only one major trench was excavated up until 2017, about 55 m<sup>2</sup> of wooden structures in a good state of preservation have been revealed, providing information about her construction. There are construction elements that may be considered common for Roman Period wrecks, as well as others with fewer archaeological parallels. The presence of a double garboard is not unprecedented in the 1<sup>st</sup> century AD, but deserves further study. Many hull pieces, from the lower wale to another that we consider as an upper wale, are sufficient elements to propose a preliminary measurement of width amidships. These lines, combined with the stowed amphorae carrying fish sauces, open the possibility that a third perishable cargo might also have been transported.

## Keywords

*Baetica*, Dressel 7-11 amphorae, Roman shipbuilding, shipwreck

## Résumé

Cet article présente un résumé des recherches menées sur l'épave Bou Ferrer depuis 2006. Les premières campagnes ont fourni de nouvelles données sur une *navis oneraria* bien datée de la seconde moitié du 1<sup>er</sup> siècle apr. J.-C. En dépit du fait qu'une seule grande tranchée ait été fouillée jusqu'en 2017, ce sont environ 55 m<sup>2</sup> de structures en bois, en bon état de conservation, qui ont été mis au jour, fournissant d'importantes informations sur la construction du navire. Si certaines caractéristiques de la construction se rencontrent communément sur les épaves de la période romaine, d'autres offrent moins de parallèles archéologiques. La présence d'un double galbord n'est pas sans précédent au 1<sup>er</sup> siècle apr. J.-C. mais mérite une étude plus approfondie. De nombreuses pièces de la coque, conservées de la préceinte basse à la probable préceinte haute, permettent de proposer une première évaluation de la largeur d'origine au maître couple. Cette estimation des dimensions, combinée au calcul de l'encombrement des amphores contenant des sauces de poisson, pose la question de la présence éventuelle d'une troisième cargaison périssable qui aurait disparu.

## Mots clés

Bétique, amphores Dressel 7-11, construction navale romaine, épave

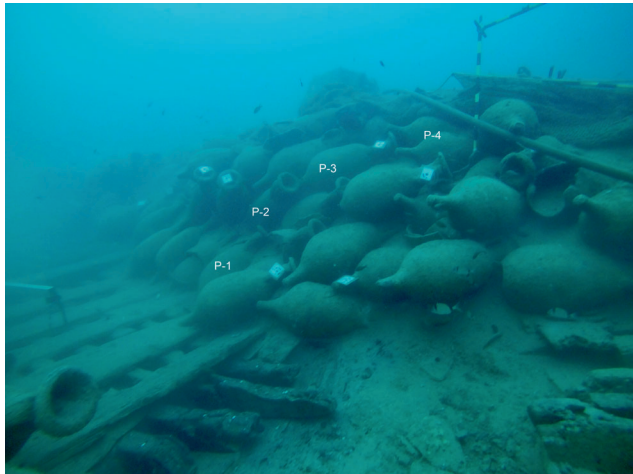
## 1. HISTORY OF THE RESEARCH

The Bou Ferrer shipwreck is situated at a depth of approximately 25 m off the coast of La Vila Joiosa, Alicante, Spain (Cibecchini *et al.* 2006). The modern city corresponds to ancient Allon, situated in the southern maritime zone of the Cap de la Nao, a geographical feature that divided the sea routes heading to Ibiza in antiquity and the *Tarraconensis* in the Early Empire, with the influential areas of *Tarraco* in the north and *Carthago Nova* in the south. At the time of its discovery by two sports divers, after whom the underwater archaeological site is named (De Juan *et al.* 2008, p. 270), the wreck occupied an oval area of roughly 24 x 8 m on the seafloor. The relatively poor conditions for recreational diving in the area in which the Bou Ferrer is located have contributed to the excellent state of preservation of the shipwreck, which remained free from looting and largely intact (with the exception of some remains of more recent fishing equipment) until it was ultimately discovered.

The wreck is unique among those so far discovered along the Spanish coast due to its size, accessibility, and state of preservation. From the beginning of the excavation (Cibecchini *et al.*

2006), we have suggested that the ship most likely did not sink while hugging a coastal route, which would have been unsafe and difficult for a large merchant vessel. Instead, we believe that the Bou Ferrer was driven from its route in the open sea by strong easterly winds while on a heading to the Strait of Bonifacio.

Based on the results of amphorae studies to date, the Bou Ferrer was an Early Imperial merchant vessel. The 'tumulus' dimensions, verified by tests, have shown larger dimensions than other known wrecks of the period, as we shall present later. When the vessel sank, it was carrying a homogeneous cargo of Dressel 7-11 amphorae, whose number is currently under discussion, and which F. Cibecchini has differentiated into four main subtypes with parallels from workshops like that of Villanueva de Puerto Real in Cádiz (García Vargas 2000; De Juan *et al.* 2008, p. 188-189). The majority of this main cargo seems to consist of Dressel 11-type amphorae, stowed in three layers with very likely a fourth (fig. 1), located amidships with each container packed in vine shoots used as dunnage. We have studied, thanks to the contact marks apparent on a large number of amphorae, how they were stowed in a quincunx pattern. According to this, we propose that four layers of amphorae would reach a height of about 2.10 m (De Juan 2018b, p. 137-141).

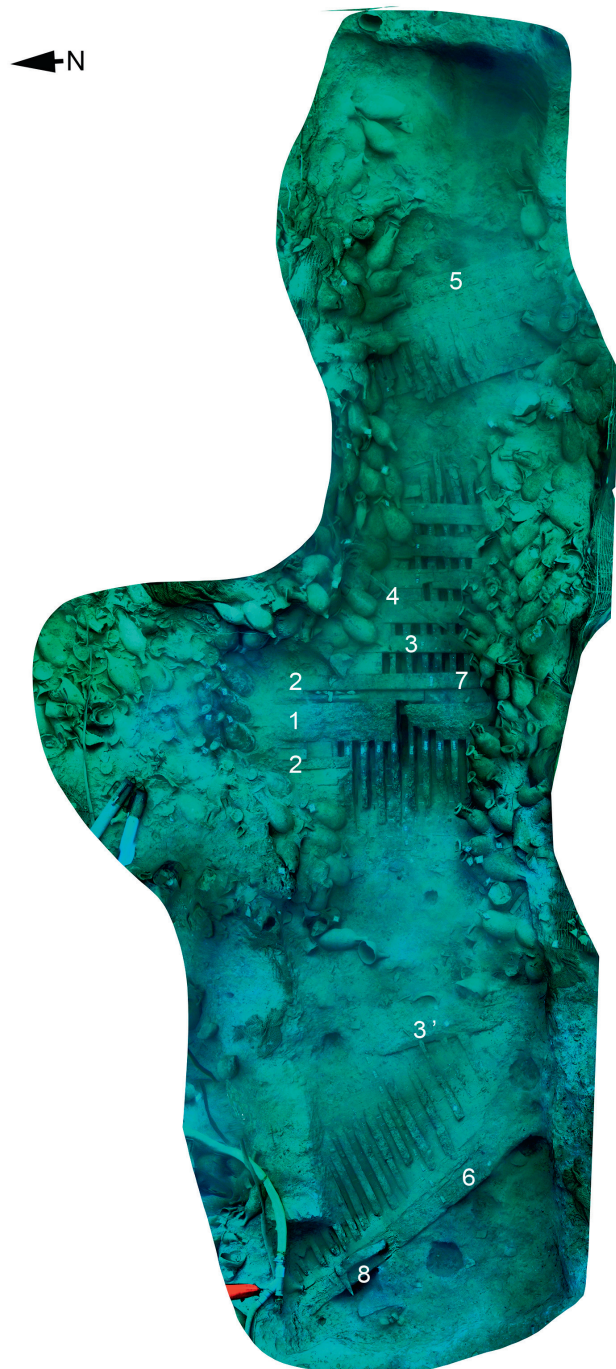


**Fig. 1:** View from the southeast of the slope of amphorae in the northern section of the central trench. Four levels of amphorae are clearly visible: the layers have been numbered (photograph C. De Juan).

Regarding the content of the amphorae<sup>1</sup>, we found the remains of what was a highly refined, semi-liquid fish sauce, obtained through the filtering of a product that was made with a large variety of small fish and others of larger size (De Juan *et al.* 2008, p. 190). Fish sauces and their derivatives, such as *garum*, *muria*, *liquamen* and *hallec*, from the Roman province of Baetica were sought-after trade products, some of them of great value in Roman gastronomy. In addition, there is a complementary cargo of lead ingots with a triangular section<sup>2</sup> stowed at the bottom of the ship along its axis (De Juan *et al.* 2014, De Juan 2018). The weight of each single ingot is close to 200 Roman pounds<sup>3</sup> (65.5 kg). They have a rich collection of hammered epigraphic stamps (IMP AVG GER NER CA), which according to Christian Rico, means *Imperator Augustus Germanicus Nero Caesar*. This could be a mark of ownership<sup>4</sup>.

Based on the excavations carried out in the 2017 season, during which we revised the measurable extent of the wreck site to be an oval of approximately 31 x 22 m, we wondered whether Bou Ferrer could be one of the big vessels of its period. Strabo refers to these when he mentions the excellence of exports from *Turdetania (Baetica)* to Rome and Italy, describing the vessels as the largest of all the cargo ships that come to Puteoli and Ostia (the port of Rome), and in numbers nearly equal to those arriving from Africa (Strabo, III, 2, 5-6).

Over the course of the 2017 campaign, we completed a large transversal trench (fig. 2) that bisected the vessel where the tumulus of amphorae exhibited its maximum width at the level of the seabed. The slow work of underwater excavation had started in 2006 with an initial survey of 3 x 3 m to assess the state of conservation of the wreck after some unfortunate episodes of looting. We continued in 2007 with the excavation of an area of 8 x 8 m. As a result of those first two campaigns,



**Fig. 2:** Orthophotograph of the central trench (22 x 6 m), from where close to 700 amphorae were removed to the surface, showing the portion of the investigated hull (about 55 m<sup>2</sup>) (C. De Juan modified from Moya 2019, p. 307).

we were able to develop a clearer picture of the magnitude of the archaeological site, and we realised that extended excavation by 'horizontal layers' was not a reasonable approach. After the scientific discussions that followed those campaigns and the subsequent economic crisis that made funding extremely difficult, we resumed excavations in 2012 with the goal of enlarging the 2006 trench to the east and west, producing the aforementioned transversal trench of 22 x 6 x 3 m, which was not a perfect size given the nature of the cargo, from which we recovered close to 700 amphorae. This work, often entailing excavating

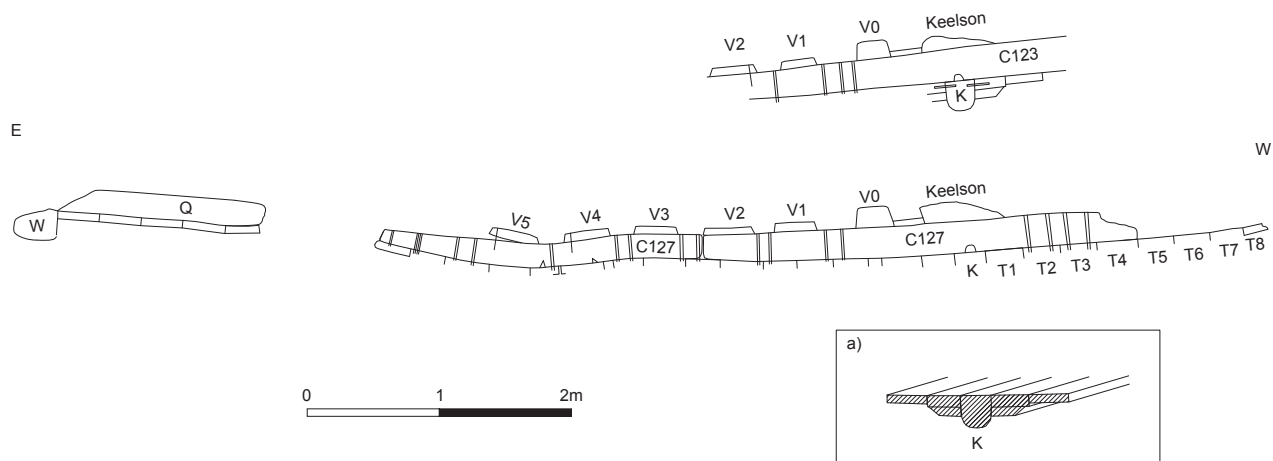
1. A systematic analysis of the amphorae contents by Gaël Piques (CNRS-Lattes) is currently underway.

2. Study conducted by Christian Rico and Claude Domergue (University of Toulouse).

3. Roman pound of 327 g.

4. This matter is discussed in a dedicated paper presented by Ch. Rico and the authors to the *Instrumenta Inscripta VIII* Congress held in Barcelona in 2019.





**Fig. 3:** Cross section of frame C123, from which samples were taken, and C127, the longest preserved frame: a) represents a proposed reconstruction of the Bou Ferrer's axial carpentry (drawing R. Geli and C. De Juan).

more than of 1.5-2 m below the level of the seafloor, required the investment of numerous man-hours. It has, however, produced significant information with a large amount of archaeological data for the interpretation of the site.

The study of two coins that were discovered in the 2017 campaign, (one *dupondius* and one *sestertius*) conducted by Tomás Hurtado (University of València), has given us a *terminus post quem* for the wreck of 66 AD, a date that is consistent with numerous other aspects of the wreck, such as amphorae typology, ingot epigraphy and pottery related to the crew. Taking all of the data into consideration, we propose that the wreck event occurred prior to the end of Nero's reign (54-68 AD), giving us a *terminus ante quem* of 68 AD, and allowing us to assign a date range to the shipwreck between 66 and 68 AD.

## 2. PRELIMINARY STUDY OF THE ARCHITECTURE OF THE SHIP

The east/west cross trench excavation (fig. 2) situated in the amidships area has provided a lot of information about the architecture of the ship, since about 55 m<sup>2</sup> of wooden structures were recorded. A new cross trench under excavation from 2017 to 2019, 14 m north of this amidships trench, revealed mariners' pottery<sup>5</sup> that could be associated to a store or kitchen area, where three bilge pump wood plungers appeared. These elements suggest that the stern area of the ship is towards the north.

### 2.1. THE KEEL AND THE PLANKING

The hull of the Bou Ferrer ship is assembled by standard Roman mortise-and-tenon shipbuilding technique within a shell-first construction principle and process (Pomey 2004a). The plank widths are between 22-29 cm and the average thickness is 6 cm, with some planks reaching 8 cm. Only a few measurements

were taken on the assemblages: the mortises are 9.5 cm wide, 1 cm thick, and 10 cm deep. The mortises edge-to-edge distance is 10 cm. The centre-to-centre average distance of pegs is 18 cm. The inner average diameter of pegs is 1.4 cm, while along the keel their diameter is bigger (2 cm). In some parts of the hull, a resin or pitch is preserved (analysis pending), demonstrating that the hull was internally protected by this material.

In 2012 a sample of the keelson was retrieved from the site of frame C123, and in 2017, taking advantage of that previous intervention, it was possible to sample the keel, the starboard side garboard and the second strake<sup>6</sup>. The keel (*Quercus ilex*<sup>7</sup>) was in a good state of preservation, but we did not expect to find a double garboard on both keel sides, as has previously been found all along the keel on the 1<sup>st</sup> century AD Ses Llumetes wreck at Porto Cristo (Munar *et al.* 2018). The Bou Ferrer keel has no rabbets or chamfered works. There is a kind of step, 3-4 mm deep, only on one side of the keel for the lower garboard. As the samples were only about 15 cm long, there is no way to verify whether the double garboard will appear along the entire keel or just in the amidships area, maybe as a kind of reinforcement to fix unknown issues in standard garboards or even as a repair<sup>8</sup>. Further research to check for the presence or absence of the double garboard along the whole keel is absolutely necessary.

The keel section is 26.5 x 22.5 cm, while mortises are 11 cm deep and 1.1 cm thick. The upper garboard is 8.5 cm thick and rectangular in cross section. The second strakes joined to it. It is 6 cm thick and the difference from the upper garboard creates a profile previously seen in other wrecks of the period (fig. 3). The lower garboard is 7 cm thick where it touches the keel and the sample showed a bevelled surface towards the second strake, as seen in the Ses Llumetes wreck (Munar *et al.* 2018). As the samples were taken between frames, it was also possible to check treenails in frames C123 and C124 in an attempt to understand the shipbuilding sequence along the ship's axis.

6. The samples are under treatment: the keelson by ARQUA Tech-Murcia; the keel, the starboard side garboard and second strake by CASC-Girona.

7. Alba Ferreira (Aix Marseille University, CNRS, CCJ, France) carried out the identification of the wood species of the Bou Ferrer structures within a research programme led by Paul Salay (USC Los Angeles).

8. We thank Prof C. Pulak for his suggestion.

5. The pottery, under study, shows only two products from port markets: Rome and *Gades*.



The study of the keel and the garboard cross section gave us the opportunity not only to carefully analyse these structures, but also to advance comparisons with other Western 1<sup>st</sup> century AD wrecks with a flat bottom and round turn of the bilge .

## 2.2. A WALE AND A POSSIBLE BULWARK

In the eastern part of the trench, the preserved wood ends at the vessel's lower wale (fig. 2-5). It is a massive piece with rounded inner and outer surfaces, 31 cm wide and 20 cm thick. Rounded inner faces for wales are not very common. In the Bou Ferrer wreck, despite the damage caused by *Teredo navalis*, it was possible to record the beginning of the arc in the cross section (fig. 3): this is visible in the orthophoto (fig. 2-5). Unfortunately, frames were not preserved at this spot.

An imperfectly preserved longitudinal piece that looks like an upper wale or even a bulwark appeared at the end of the western sector (starboard). Another element, which could be interpreted as 90° knee, appeared to be associated with it, as well as five aligned wooden sail rings underneath the wale (fig. 2-6). The piece is 29 cm wide and 20 cm thick, and on most of it there appears to be no evidence of mortise-and-tenon joinery with another plank, which would support a bulwark hypothesis, but towards the stern it is joined to massive pieces, not just planking, which are too eroded to be fully understood. The timbers continue towards the northwest under 1.5 m of sediment. Since it is possible to retrieve more information from this sector, new excavations are necessary to understand the role of this piece.

## 2.3. FRAMES AND BEAMS

The frames seem particularly robust in the excavated area: floor timbers are placed consecutively without the presence of half-frames. Although alternating floor timbers and half-frames are common in the Graeco-Roman framing pattern, there are other examples which do not follow this arrangement, for example, the 1<sup>st</sup> century AD Sud-Lavezzi 2 shipwreck (Liou, Domergue 1991, p. 121). In the Bou Ferrer wreck, the frames are 12 cm sided and 25 cm moulded under the keelson, lowering in height to 15 cm towards the turn of the bilge. Room and space measurement is 12 cm on average. The joining system of frames to hull is by treenails, 1.8-2 cm in upper diameter, driven from outside, combined with blind iron nails also driven from outside, set 10 cm apart on average. The nails are probably made of iron (not yet analysed) until the portside strake 15, before the turn of the bilge curve, thereafter they are copper (analysis completed). The floor timbers have a round central limber hole above the keel, about 7 cm wide and 5 cm high. Other triangular limber holes are situated close to the turn of the bilge at the level of strakes 9-11 (fig. 3).

There is no precise evidence of beams, but we were able to propose the position of a beam, which could connect the sides between the lower wales (fig. 2-5). In 2013, excavations of the stowed amphorae documented an empty transversal row between the second and third tilted cargo layers. This empty amphora row matches the position of a stanchion mortise (fig. 2-7), recorded in 2014, in the thicker portside stringer above frame C128. Therefore, we propose that a transversal piece, such as a beam, might have run through the amphorae.

Lower beams are apparent in the contemporaneous *Naevoleia Tyche* bas-relief (Basch 1987, p. 457) and in Caligula's Nemi wrecks (Ucelli 1950, tav. 2). Maybe an upper beam could be related to the 90° knee that appears beneath the upper wale/bulwark (fig. 2-8).

## 2.4. THE KEELSON AND THE CEILING

The keelson (fig. 2-1) probably played the role of a mast step and was set directly on the frames, as in other 1<sup>st</sup> century AD wrecks, for example, Sud-Perduto 2 (Bernard 2008)<sup>9</sup>. The keelson has a trapezoidal profile with its upper surface wider than the lower. Its lateral surfaces have the precise inclination to perfectly stow the rows of triangular lead ingots, which are in direct contact with the keelson sides. Two thicker stringers (fig. 2-2) also helped to hold them in place (De Juan 2018b).

Despite the fact that the upper surface of the keelson is badly damaged by *Teredo navalis*, thanks to a sample, it was possible to measure the trapezoidal cross section, which has a maximum width of 60 cm, and a minimum of 50 cm on its lower surface. The keelson gently tapers longitudinally towards the stern (fig. 2). Given the position of the trunk centre and following the growth rings observed in the sample, we propose its height to be 30 cm. The system for fixing it to the floor timber upper surfaces, following the Hellenistic and Roman Republican tradition (Pomey 2004b; Pomey, Rieth 2005, p. 163-164), is through a series of notches in its lower face to allow coupling with the floor timbers, and resulting in a precise fit. The craftsmanship on the lower face recalls that observed on the Madrague de Giens shipwreck (Pomey 1982) and other similar examples of the same date.

As was common in Roman times, the internal carpentry is composed of stringers and movable planks. The stringers are quincunx nailed to the frames (figs 1 and 2-3) by iron square section nails (now disappeared). The stringers are placed alternately with rows of shorter and thinner movable planks, which could be dismantled if necessary (fig. 2-4). The stringers have a trapezoidal profile, with a 30 cm upper surface and 35 cm lower, for a thickness of 6 cm. The movable planks have a complementary inverse trapezoidal profile, 17 cm for the upper face width and 15 cm for lower, and 4 cm thick, which made them fit perfectly between the stringers. From both sides of the keelson, the first row of movable planks held lead ingots, which were placed longitudinally. The two rows of ingots, on the starboard and port sides of the keelson, are flanked by two thicker stringers (fig. 2-2), 15 cm in height. No nails or treenails have been found in their upper surfaces, nor recesses in the lower surfaces. The thicker stringers also have a slight trapezoidal profile, with an upper face 22 cm wide and lower 25 cm wide. The keelson and the thicker stringers create two parallel longitudinal channels to hold the lead ingots and restrict their movement. A stanchion mortise for supporting a beam was observed in the thicker port stringer above frame C128. The Bou Ferrer timbers, creating a longitudinal channel to stow the ingots between the keelson and

9. Due to this and other characteristics, we propose (De Juan 2013) that 1<sup>st</sup> century AD shipbuilding in the Western Mediterranean should not be considered as within the western Roman Imperial tradition, which developed from the 2<sup>nd</sup> century AD and is characterised by a long mast step/keelson set on two sister keelsons (Pomey, Rieth 2005, p. 166-167; Pomey *et al.* 2012).

thicker stringers, are unusual in Roman shipbuilding, without any another architectural example to compare with.

From the thicker stringers and towards the turn of the bilge, movable planks and regular stringers alternate (fig. 3). There is a kind of stringer in the west sector (starboard) with an angled orientation (fig 2-3') related to transversal carpentry, very well set above the frames thanks to grooves in its lower surface. This piece is still under study and a sample is necessary to understand it.

### 3. FIRST RECONSTRUCTION OF THE CROSS SECTION AMIDSHIPS

The Bou Ferrer wreck dimensions are still uncertain, given that the size of the tumulus at seafloor level (22 x 8 x 1.5 m) does not correspond to its dimensions, since the ship is hidden under almost 2 m of mud. The width of the tilted amphora mound exceeds 22 m, with a height of almost 2.5 m in the central part that protrudes from the substrate. The test trenches made on the axis of the keel have revealed the presence of amphorae 14 m to the north from frame C120 and 17 m in a southeast direction, representing a spindle or oval shape of 31 x 22 m for the tumulus.

We must logically assess these measurements, which correspond to the dispersion of the cargo, also recently provoked by fishing activities, and do not indicate the original dimensions of the ship. On the longitudinal plane, those 31 m may be close to the real length of the ship, either more or less, but logically we must interpret the transversal width as the result of the opening of the sides, due to the fracture of the hull as documented in the portside turn of the bilge (fig. 3), and amphorae falling to both starboard and port where a large number of them appear upside down.

With other 1<sup>st</sup> century AD wrecks in mind, we would like to address two specific and separate issues: the architectural system, in particular, the internal axial carpentry; and the ship shape.

The observations of preserved amidships structures in the transversal trench excavated in 2017 (fig. 2) have allowed us to compare the Bou Ferrer with other ships which show similar features, such as a flat bottom with rectangular cross section garboards, a rounded turn of the bilge which ends in a lower wale, and a large beam with respect to length.

The Bou Ferrer shapes, though not necessarily the longitudinal timbers and mast system, might be closer to a group of ships composed of the Saint Gervais 3 (length to beam ratio or LTBR = 2.24-2.28), Tiboulén de Maire (LTBR = 2.55), La Bourse (LTBR = 2.55) and even Port Vendres 1 (LTBR = 2.05): but not to those like the Madrague de Giens (LTBR = 4.4). This specific vessel group belongs to Pomey's Western Roman Imperial tradition dated from the 2<sup>nd</sup> to the 5<sup>th</sup> century AD. Their shapes provided nautical capacities allowing long open sea routes, and also fluvio-maritime navigation in the deltas of the Tiber, the Guadalquivir and others rivers of the Baetican region. All these zones were dangerous due to shallow waters and sand barriers. The Bou Ferrer ship probably also plied this transport zone, connecting the ports of Rome and Gades.

With all the cross section drawings done in the 2017 trench (fig. 2), we have been able to fix manually, according to our personal perspective and after going over the reference group

with their amidships cross section archaeological drawings and reconstructions, all the deformations in the frames caused by the passage of time (fig. 4-2.1). The mortise-and-tenon shipbuilding technique does not allow abrupt hull line changes, but involves drawing smooth lines from the ship's bottom to the sides, giving rise to the characteristic rounded turn of the bilge of known Roman sailing ships. We made a sketch using circles to help us to draw the smooth arcs of the turn of the bilges (fig. 4-3), matching them in our initial drawings with the archaeological cross section wood pieces, and orienting and placing the drawings accordingly.

This exercise suggested that Bou Ferrer's maximum breadth might be 12.08 m. Seeing a coherence in the forms with the arcs that we drew (fig. 4-4), mostly in the turn of the bilge area, we examined the reconstructions of the shipwrecks La Bourse (Gassend *et al.* 1974), Laurons 2 (Gassend *et al.* 1984) and Port Vendres 1 (Liou 1974; Roman 1997), as well the archaeological cross section drawings of Saint Gervais III (Liou *et al.* 1990) and Tiboulén de Maire (Poveda *et al.* 2016). In La Bourse, Gassend worked with the radius of a circle multiplied by four to get the beam as a ratio, in accordance with the proportions he observed in the wreck. In the case of the Bou Ferrer wreck, we realised that 12.08 m was very close to 11.82 m, which equals

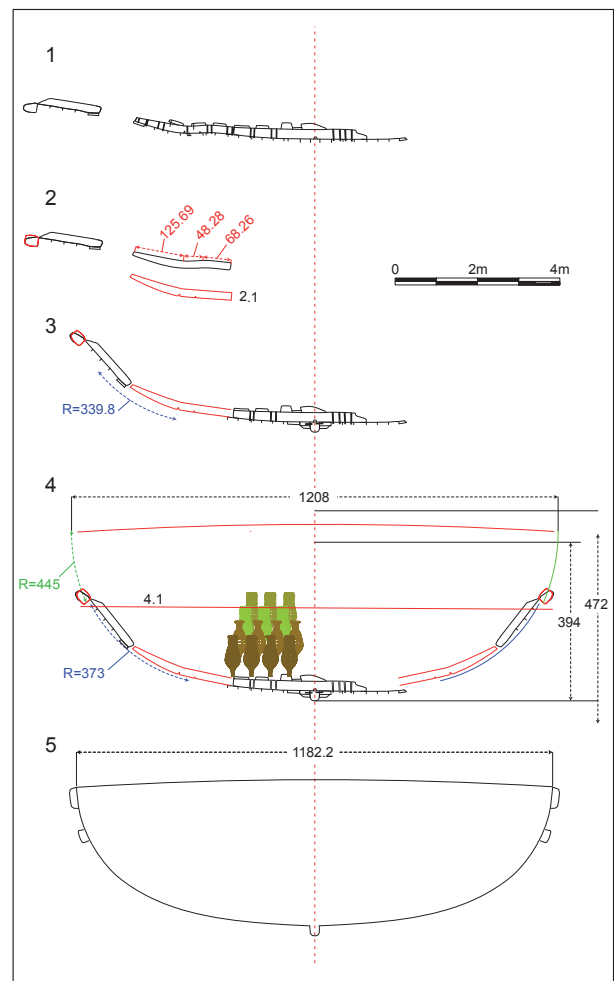


Fig. 4: Proposed breadth and depth measurements of the Bou Ferrer shipwreck, developed from cross section drawings, based on the author's personal opinion (drawing De Juan).

40 Roman feet of 29.57 cm. According to Gassend's radius and circle reconstruction device, it is perhaps possible to advance the hypothesis that the unit (*regula*) of a radius of 10 Roman feet was used to establish the Bou Ferrer maximum beam breadth of 40 Roman feet (fig. 4). In our opinion, these matters deserve more research in the future before trying to reach any kind of conclusion.

From the previously mentioned examples, we think that the LTBR of 2.5 of La Bourse and Tiboulen de Maire ships (Poveda *et al.* 2016), due to their proximity in shape and chronology, can be referents to assess the possible ratio of LTBR proportions for the Bou Ferrer ship. Using the Roman foot as a unit of measurement, and our theoretical 40 Roman feet beam multiplied by 2.5 LTBR gives a length of 100 Roman feet (29.57 m) for the ship. This value could fit with the dimensions of the tumulus we have recorded on the site.

As regards the depth, we have no archaeological data yet, only our theoretical proposal of three or four layers of amphora cargo and its 2.10 m maximum height, so our argument is incomplete. A depth/beam ratio for the Bou Ferrer could stretch between 0.5 (1/2) as proposed by Pomey and Tchernia (1978, p. 234) for the Madrague de Giens ship, which has a higher LTBR ratio than the Bou Ferrer, and between 0.33 (1/3) or 0.4 (2/5) as proposed by Gassend *et al.* 1974. Using the first ratio of 0.5, we would get a depth of 5.91 m, and between 3.94 m and 4.72 m if using a lower depth/beam ratio (fig. 4), which we thought would fit our proposal. We are not able to see any equivalence in Roman measurements in Gassend's values.

The 18<sup>th</sup> century French navy cargo weight formula used to estimate the tonnage of old ships (Pomey, Rieth 2005, p. 44) would calculate the Bou Ferrer tonnage as between 310 and 375 tons following Gassend's depth/beam ratio, and 468 tons following Pomey and Tchernia's. The latter, using a 0.5 ratio, is probably outside the plausible range, because such a depth ratio might not apply to *navis rotunda*, which had an absolutely different shape than a merchantman like the Madrague de Giens.

In any case, this does not mean that 100% of the usable cargo space in the vessel had to be occupied with amphorae<sup>10</sup>, as we

10. The lowest amphorae layer has the mechanical strength to support the weight of consecutive upper layers. At this stage of the research, three layers of amphorae are perfectly reasonable since we have archaeological evidence from other shipwrecks (Pomey, Tchernia 1978). In the Bou Ferrer amidships zone it would be possible to imagine four layers (fig. 1).

understood after superimposing the reconstituted cargo load (2.10 m in height) upon the proposed cross section of the Bou Ferrer (depth between 3.94 m and 4.72 m) (fig. 4).

The amphorae cargo would be placed low in the hold, helping to lower the vessel's centre of gravity, and thus improving safety in bad maritime weather conditions. On the other hand, the commercial agents, the shipowner or the sailors themselves would not be keen to leave a large volume of hold completely empty. A complementary cargo may well have occupied part of that space. Classical sources talk about other very common exports from Baetica in the 1<sup>st</sup> century AD, which we know will not be preserved underwater. Such goods could have been transported above the amphorae (Pliny, *NH*, 27.94 and 31.86; Strabo, III.4.6): some of them are large in volume relative to weight, like wool.

#### 4. CONCLUSION

The Bou Ferrer is a very interesting shipwreck and an aid in the study of Early Imperial shipbuilding traditions in the western Mediterranean. From the structural point of view, Bou Ferrer together with other vessels of the same date (around the 1<sup>st</sup> century AD) shares some hull characteristics with the Roman Republican shipbuilding tradition, and others with the Western Roman Imperial shipbuilding tradition. This evidence suggests that these ships could belong to a hypothetical transitional tradition between the two well-defined traditions mentioned. This Early Imperial shipbuilding tradition developed in the western Mediterranean between the end of 1<sup>st</sup> century BC and the beginning of the 2<sup>nd</sup> century AD.

Thanks to the data obtained through the ongoing excavation of the Bou Ferrer shipwreck, we hope to be able to reconstruct a set of hull lines drawings, to estimate the total number of amphorae stowed in the ship, and to estimate the weight of the ship structure. Thereafter, we should be able to calculate different displacements with different loads. In this way, and taking the lower wale preserved in the wreck as an important mark of the most suitable waterline, it will be possible to figure out the different possible draughts of the Bou Ferrer ship as was recently done for the 1<sup>st</sup> century AD vessel, Napoli A (Boetto, Poveda 2018).

#### REFERENCES

- BASCH L.  
1987 *Le musée imaginaire de la marine antique*, Athènes, Institut hellénique pour la préservation de la tradition nautique.
- BERNARD H.  
2008 Nouvelles épaves hispaniques de Corse: Sud Perduto 2 (Bonifacio) et Marina di Fiori (Porto Vecchio), in J. Perez Ballester, G. Berlanga (eds), *Comercio, redistribución y fondeaderos: la navegación a vela en el Mediterráneo*, V Jornadas Internacionales de Arqueología Subacuática, Gandia 2006, València, Universitat de València, Servei de Publicacions, p. 461-471.
- BOETTO G., PAVEDA P.  
2018 *Napoli A*, un voilier abandonné dans le port de *Neapolis* à la fin du 1<sup>er</sup> siècle : architecture, fonction, restitution et espace de navigation, in G. Boetto, E. Rieth (eds.), *De re navali. Pérégrinations nautiques entre Méditerranée et océan Indien. Mélanges en l'honneur de Patrice Pomey*, Paris, CNRS éditions, *Archaeonautica* 20, p. 19-56.
- CIBECCHINI F., DE JUAN C., VENTO E.  
2006 Il Bou-Ferrer: protezione e studio di un relitto affondato nel I secolo nelle acque di Villajoyosa (Alicante-Spagna), *Archaeologia*

- Maritima Mediterranea, An International Journal on Underwater Archaeology* 3, p. 43-56.
- DE JUAN C.  
2013 *Los veleros de comercio romano del Mediterráneo Occidental: análisis de familias y firmas arquitecturales (s. III a.C. – II d.C.)*, PhD thesis, University of Valencia, Department of Prehistory and Archaeology, unpublished.
- 2018 Una interpretación náutica a la estiba del cargamento en el pecio Bou Ferrer, in J.M. López Ballesta, M. M. Ros Sala (eds), *Navegar el Mediterráneo: Phicaria, VI Encuentros Internacionales del Mediterráneo*, Mazarrón, Universidad Popular de Mazarrón, p. 132-145.
- DE JUAN C., CIBECCHINI F., MIRALLES J.S.  
2014 El pecio Bou Ferrer (La Vila Joiosa-Alicante). Nuevos datos sobre su cargamento y primeras evidencias de la arquitectura naval, in X. Nieto Prieto, M. Bethencourt Nuñez (eds), *Actas del I Congreso de Arqueología Náutica y Subacuática Española, Cartagena 2013*, Cádiz, Universidad de Cádiz, Editorial UCA, vol. 1, p. 113-124.
- DE JUAN C., CIBECCHINI F., VENTO E.  
2008 Intervención arqueológica subacuática en el pecio Bou-Ferrer (Alicante, España): resultados preliminares de la campaña 2006, in J. Perez Ballester, G. Berlanga (eds), *Comercio, redistribución y fondeaderos: la navegación a vela en el Mediterráneo, V Jornadas Internacionales de Arqueología Subacuática, Gandia 2006*, València, Universitat de València, Servei de Publicacions, p. 269-277.
- GARCÍA VARGAS, E.  
2000 La producción de ánforas romanas en el sur de Hispania. República y Alto Imperio, in G. Chic Garcia (ed.), *Congreso Internacional ex Baetica Amphorae: conservas, aceite y vino de la Bética en el Imperio Romano, Écija-Sevilla 1998*, vol. 1, Ecija, Editorial Graficas Sol, p. 57-174.
- GASSEND J.-M., LIOU B., XIMÉNÈS S.  
1984 L'épave 2 de l'anse des Laurons (Martigues, Bouches-du-Rhône), *Archaeonautica* 4, p. 75-105.
- GASSEND J.-M., CUOMO J.-P., DROCOURT D., MOREL-DELEDALLE M., TERRER D.  
1974 *Le navire antique du Lacydon*, Marseille, Musée Historie de Marseille.
- LIOU B.  
1974 L'épave romaine de l'anse Gerbal (Port-Vendres), *CRAI*, p. 414-433.
- LIOU B., DOMERGUE C.  
1990 Le commerce de la Bétique au 1<sup>er</sup> siècle de notre ère. Notes sur l'épave *Sud-Lavezzi* 2, *Archaeonautica* 10, p. 125-155.
- LIOU B., GASSEND J.-M., ROMAN R.  
1990 L'épave *Saint Gervais* 3 à Fos-Sur-Mer (milieu du 1<sup>er</sup> siècle ap. J.-C.). Inscriptions peintes sur amphores de Bétique. Vestiges de la coque, *Archaeonautica* 10, p. 157-264.
- MOYA J.A.  
2019 *La comunicación en la gestión del patrimonio cultural sumergido: estrategias y técnicas visuales aplicadas en medios sociales*, Dir. R. Azuar and E. Feliu. Unpublished PhD Thesis, Universidad de Alicante.
- MUNAR S., DE JUAN C., MARTÍN A., RODRÍGUEZ J.  
2018 Ses Llumetes: excavación arqueológica subacuática de una nave romana del siglo I d.C. en la playa de Porto Cristo, in *VII Jornades d'Arqueologia de les Illes Balears, Maó 2016*, Menorca, Consell Insular de Menorca, p. 217-224.
- POMEY P.  
1982 Le navire romain de la Madrague de Giens, *CRAI*, janvier-mars, p. 133-154.
- 2004a Principles and Methods of Construction in Ancient Naval Architecture, in F. M. Hocker, C. A. Ward (eds), *The Philosophy of Shipbuilding*, College Station, T&A University Press, p. 25-36.
- 2004b La structure du navire de la Madrague de Giens et le type hellénistique, *Ligures, Rivista di Archeologia, Storia, Arte e Cultura Figure* 2, p. 370-373.
- POMEY P., RIETH E.  
2005 *L'archéologie navale*, Paris, Errance.
- POMEY P., TCHERNIA A.  
1978 Le tonnage maximum des navires de commerce romains, *Archaeonautica* 2, p. 233-251.
- POMEY P., KAHANOV Y., RIETH E.  
2012 Transition from Shell to Skeleton in Ancient Mediterranean Ship-Construction: analysis, problems, and future research, *IJNA* 41.2, p. 235-314.
- POVEDA P., SABASTIA A., XIMÉNÈS S.  
2016 Étude Architecturale de l'épave *Tiboulen de Maire*, *Cahiers d'Archéologie Subaquatique* XXIII, p. 13-33.
- ROMAN R.  
1997 *Étude architecturale comparative de sept navires de commerce gréco-romains et byzantins*, unpublished PhD Thesis, Université de Provence, Aix-en-Provence.
- UCELLI G.  
1950 *Le navi di Nemi*, Roma, Istituto Poligrafico e Zecca dello Stato.





# THE GRANDE PASSE 1 SHIPWRECK, 2<sup>ND</sup> CENTURY BC, HYÈRES, FRANCE: NEW DATA ON ITS CARGO, NAUTICAL EQUIPMENT AND WOODEN REMAINS

Alex SABASTIA

## Abstract

The Grande Passe 1 shipwreck lies 45 m deep off the coast of Porquerolles Island, Hyères, southern France. Discovered in 1975, new fieldwork campaigns in 2017 and 2018 brought to light a part of the hull (keel, planking, frames), indications of its cargo from the 2<sup>nd</sup> century BC (Graeco-Italic amphorae), and three well preserved iron anchors. This paper provides a first archaeological analysis of the wreck.

## Keywords

Graeco-Italic amphorae, shipwreck, iron anchor

## Résumé

L'épave *Grande Passe 1* se trouve à 45 m de profondeur au large de l'île de Porquerolles, à Hyères (Var), sur la côte méditerranéenne française. Elle a été découverte en 1975 et de nouvelles campagnes de terrain en 2017 et 2018 ont mis au jour une partie de la coque (quille, bordé et membrure) et trois ancres en fer en bon état de conservation. Quelques amphores gréco-italiques, qui faisaient partie de la cargaison, sont datables du 1<sup>er</sup> s. av. J.-C. Cet article propose une première analyse de l'épave.

## Mots clés

Amphores gréco-italiques, épave, ancre en fer

The Grande Passe 1 shipwreck lies 45 m deep off the coast of Porquerolles Island, in the Hyères archipelago, southern France (fig. 1), a region where many ancient wrecks have been discovered (Long 2004). The Grande Passe 1 wreck has been known since 1975, when two local divers reported an area of 100m<sup>2</sup> covered with amphora shards to the French Department of sub-aquatic and submarine archaeological research (DRASSM). Since its discovery, the site has been heavily visited, and some of the looters' equipment can still be seen on the bottom. The site was gradually forgotten by looters and had never been evaluated by archaeologists until its rediscovery in 2016 during a survey conducted by Bernard Pasqualini (Iero Diving Centre, Hyères). Because of its potential, it was decided to conduct a documentation campaign in 2017, and then an excavation in 2018.

The wreck lies on a sandy bottom, seasonally covered by algae. The site measures 10 m long and 5 m wide. This includes the excavated remains of the wreck, the anchors and some cargo fragments (fig. 2).

## 1. THE CARGO

Although the site has been looted, the excavation brought to light a few Graeco-Italic amphorae (one complete, two necks and some shards), dating the wreck to the 2<sup>nd</sup> century BC. We presume these are part of the cargo and not the ship's own equipment, even if we cannot establish the cargo's size. Effectively, the ship can be linked to a great number of wrecks with similar cargo discovered on the maritime route going from the Italian

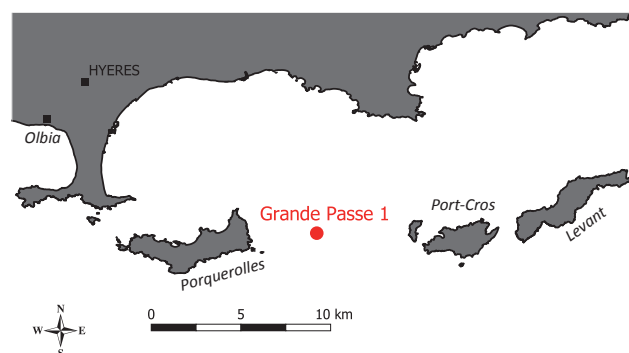


Fig. 1: Geographic location of the wreck (drawing A. Sabastia, AMU/CCJ).

peninsula towards the coast of Gaul off the eastern side of Corsica (Cibecchini 2008, 2015). Most of the ships were around 20 m long, with a maximum cargo of about 30 tons (Cibecchini 2008).

A few other artefacts could be linked to crew equipment: a lid, pieces of cooking ware (*lopas*), Campanian A ware of the type Lamboglia 36/Morel 1310 (Morel 1981, pl. 11-13) and a *catillus* of a manual millstone in basalt. A few pieces of *imbrices* and *tegulae* might belong to the hearth.

## 2. ANCHORS

The wreck revealed two types of anchor: iron anchors in a good state of preservation, and a wooden anchor with lead stock.

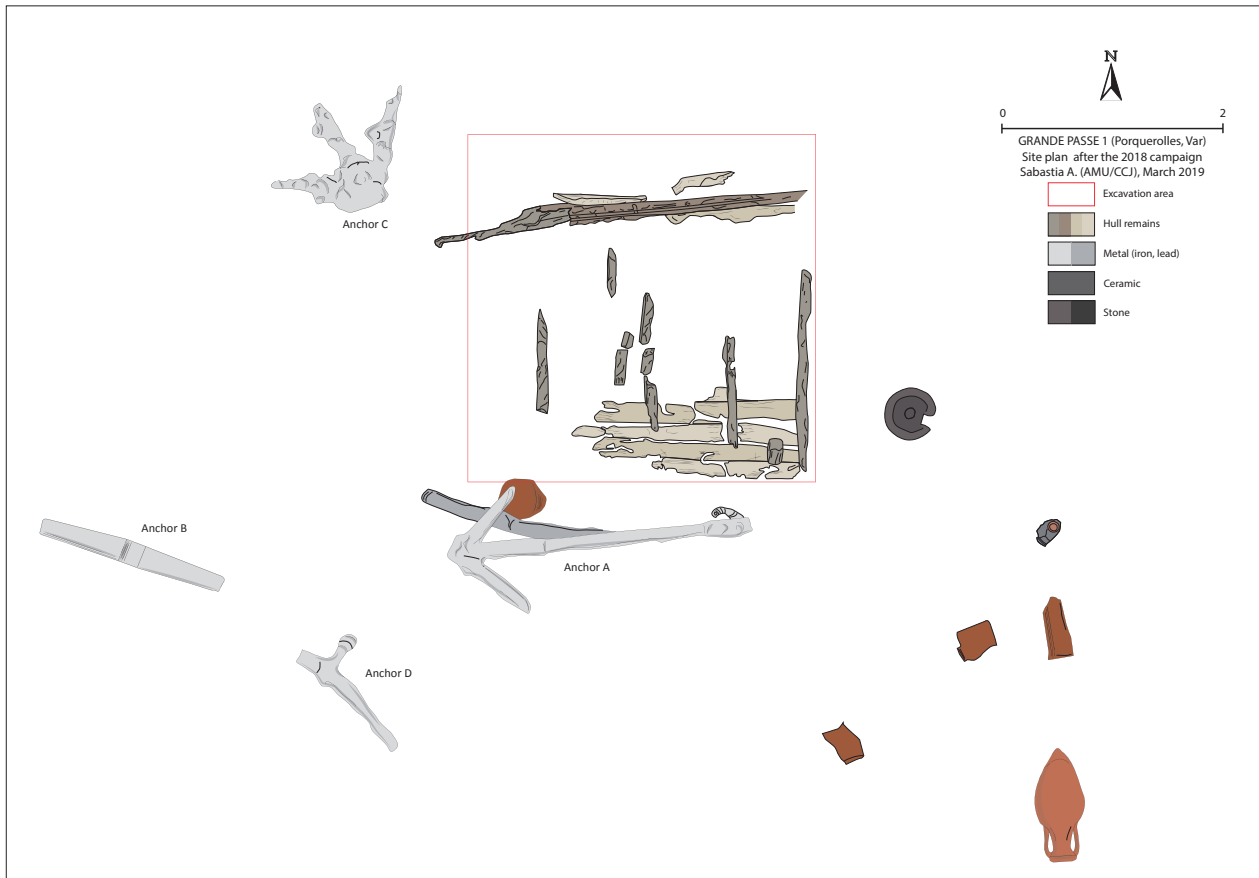


Fig. 2: Plan of the site (drawing A. Sabastia, AMU/CCJ).

The lead stock (Anchor B), belonging to a wooden anchor, which has not been preserved, measures 134 cm in length with a 7 x 24 cm cross section. The box for the shank is rectangular with rounded edges, 21 cm long and 17 cm wide. We can estimate its weight to be around 150 kg.

The three iron anchors each had a removable stock (Kapitan 1984, p. 34). The best preserved (Anchor A) measures 231 cm from crown to its extremity (fig. 3). The arms are 68 cm long and at their furthest are separated from each other by 88 cm, forming a clear V shape. Iron concretions obscure the crown, which does not seem to have a tripping ring. The arm tips are not visible. The shank section is rectangular at its lower extremity (10 cm wide, 17 cm thick), becomes rounded for most of its 117 cm length, and then becomes rectangular again at its upper extremity. The ring is partly preserved, with the remaining part measuring 28 cm in length. The 110 cm-long arched stock is preserved under the shank.

Two other anchor pieces are visible on the site. The lower part of an iron anchor (Anchor C) is preserved. The distance between the arm tips is 115 cm, and the arms are 80 cm long, longer than Anchor A. The shank section is rectangular, measuring 8 cm wide and 7 cm thick.

The third example (Anchor D) is the upper part of an anchor with the head, the ring (6-7 cm diameter), and the stock. The stock is lightly arched and measures 123 cm in length. Its rectangular section is 12 cm wide and 8 cm thick.

V-shaped anchors are characteristic of the Republican period, as shown by Kapitän (1984, p. 42-43), but only a few

comparisons are possible especially in this good state of preservation. From the Cannonier-du-Sud shipwreck (2<sup>nd</sup> century BC), only the mould of the lower part of an iron anchor has been preserved: it is exhibited in the Musée des docks remains in Marseilles (Benoit 1958, p. 25). That anchor's shank is slightly different, with two different sections and two protrusions on its sides, maybe to improve strength. These can also be seen on the Pompeii anchor (Ucelli 1950, p. 239), but not on anchors discovered in a maritime context, mainly because of oxidation.

### 3. THE HULL

A part of the hull was excavated and studied in 2018. The trench, located near Anchor A, brought to light a part of the hull in a fair state of preservation. Much of the structure has disappeared, but a part of the keel and its post, nine planks and seven pieces of frame could be studied (fig. 2). Each piece was measured *in situ*, the documentation being completed by photography and sampling (wood, pitch). Each piece has been sampled but the wood identification has not yet been conducted.

#### 3.1. KEEL AND TRANSITIONAL TIMBER

A 2.8 m-long part of the longitudinal axis of the ship was excavated. The keel and a transitional timber are partly preserved.

The pieces are assembled together by a hook scarf (25 cm in length), locked by a wooden key that is not preserved (fig. 4). The transitional timber is broken on its western part, arched and measures 97 cm in length. Its section is 13 cm wide and 15 cm high.

The keel is also 13 cm wide and 15 cm high in section. The top face is rabbeted (4.5 cm wide and high) in order for the garboard to be assembled onto the keel. The two rabbets are only 3.5 cm distant from each other. The profile of the keel gives the bottom of the hull a clear wineglass shape.

### 3.2. PLANKING

Nine pieces of planking are preserved. Planks P1 to P5 are preserved to the south of the remains, while P6 to P9 are pieces of garboard still connected to the keel. The planks are 12 to 16 cm in width and 3.5 cm thick. The garboards are thicker and, judging by plank P7, narrower (10 cm). The carved garboards give the hull a wineglass section.

Planks are assembled to each other by pegged tenon-and-mortise joints. The pegs are 1.1 cm in diameter (internal face). On the keel, tenons are 4 cm wide and spaced on average at 18 cm. Copper nails are driven from outside the hull into the keel to reinforce the assemblages.

### 3.3. FRAMES

Six frames are preserved in place, and a seventh (F102) has been moved. None of them are preserved on the top of the keel, thus it is impossible to determine if there were floor timbers.



Fig. 3: Anchor A, the best preserved on the site (photograph T. Seguin).



Fig. 4: The scarf between the keel (left) and the post (right): the garboard in the foreground (photograph L. Damelet, CNRS/CCJ).

The frames are 5.5 to 9 cm wide and 4 to 9 cm high. They are attached to the planking by treenails, sometimes reinforced by copper nails. F104 is attached to the planking by only one treenail. Nails are driven from outside the hull, and clenched on the top of the frames. Unlike the *Kyrenia* shipwreck (4<sup>th</sup> century BC, Steffy 1985, p. 84), they are clenched only once, not twice. A few nails were discovered around the ship remains. The best preserved is 11 cm long and its head is 1.5 cm in diameter.

## 4. DISCUSSION

Grande Passe 1 was carrying Graeco-Italic amphorae from the Italian peninsula to a northwestern Mediterranean harbour (*Massalia*?). After passing the eastern coast of Corsica, it sank in the Hyères archipelago. This route is well known from a large number of shipwrecks, some found at great depths (Cibecchini 2008; Cibecchini, Capelli 2013).

The latest campaigns brought to light elements from the crew's equipment. The Campanian ware, the millstone and the cookware show that the galley was in this part of the ship. The *tegulae* and *imbrices* might belong to the hearth.

The hull remains are from one extremity of the ship, perhaps the prow, as shown by the anchors and the hearth<sup>1</sup>. The hull probably had a wineglass section, a typical shape for a hull bottom in the Hellenistic and Romano-Republican periods (Pomey 2004). The carved garboards and the frame size help to visualise the conception and construction of this shell-first vessel (Pomey, Rieth 2005, p. 29-31).

The gear of the Grande Passe 1 ship includes anchors of different types and sizes. This was also the case on the *Dramont D* (1<sup>st</sup> century BC, Joncheray 1975, p. 13-16) where three iron anchors and a lead stock were found, as well on the *Grand Rouveau* shipwreck (1<sup>st</sup> century BC, Corsi-Sciallano, Liou 1985, p. 65) where one iron anchor and two lead stocks were found.

1. As a comparison, the hearth is located in the forepart of the ship in the *Caska 2* shipwreck (Boetto 2016, p. 1409; Boetto, Radić Rossi 2017, p. 285). The shipwreck of *Pakoštane* (Croatia, 4<sup>th</sup>-5<sup>th</sup> century AD) also shows this type of galley remains (Boetto *et al.* 2012, p. 111-112). For others examples, see Beltrame 2002, p. 60-65.



It was quite usual for ships to carry several anchors (Gianfrotta, Pomey 1981, p. 297-309). The heavier were used for mooring and, in case of loss, could be replaced by the others. In case of bad weather, several anchors could be useful to secure the ship. The small anchors could also be used for manoeuvres in an area where using the sail could be risky (harbours, small bays etc.).

The Grande Passe 1 anchors might indicate the size of the ship. By analogy with the Cap de l'Esterel shipwreck (2<sup>nd</sup>-1<sup>st</sup> century BC, Pomey, Guibal 2001), where iron anchors and a 140 cm lead stock were excavated, we can estimate that the Grande Passe 1 ship might be at least 15 m long<sup>2</sup>.

## 5. CONCLUSION

Despite the poor condition of the archaeological material, especially the hull, the Grande Passe 1 shipwreck displays an interesting set of anchors. Anchor A, one of the best-preserved

2. Among other details, the size of the anchors provides an indication regarding the size of the ship, even if we cannot be as precise in our estimate as other scholars might claim (Tour Fondue, 3<sup>rd</sup> century BC, Dangréaux *et al.* 2012, p. 21).

examples of its kind for this period, has only a few parallels. The anchors, their number and dimensions, as well as the dimension of the architectural pieces excavated are consistent with a 15 m-long vessel, but the data is not sufficiently complete to define precisely the original dimensions of the ship.

Future campaigns will focus on the keel and its original length, as well as on the general characteristics of the architecture (planking, frames, and assemblages). New elements from the stern area or the crew kitchen could help to define the date of the sinking as well as the maritime route and the origin of the ship.

## ACKNOWLEDGEMENTS

The work carried out on the shipwreck received the scientific and financial support of the Centre Camille Jullian (Aix-Marseille University, CNRS), the French Ministry of Culture and the Institute of Nautical Archaeology. Arkaeos, the Iero Diving Centre and the National Park of Port-Cros also provided great support. M. Sadania (DRASSM, French Ministry of Culture) provided scientific support and advice for the anchor studies.

## REFERENCES

- BELTRAME C.  
2002 *Vita di bordo in età romana*, Roma, Poligrafico e Zecca dello Stato.
- BOETTO G.  
2016 Recherches d'archéologie navale en adriatique orientale, *CRAI*, p. 1401-1422.
- BOETTO G., RADIĆ ROSSI I.  
2017 Ancient ships from the bay of Caska (Island of Pag, Croatia), in J. Litwin (ed.), *Baltic and Beyond, Change and continuity in shipbuilding, Proceedings of the Fourteenth International Symposium on Boat and Ship Archaeology (ISBSA 14), Gdansk 2015*, Gdansk, National Maritime Museum, p. 279-288.
- BOETTO G., RADIĆ ROSSI I., MARLIER S., BRUSIĆ Z. (EDS)  
2012 L'épave de Pakoštane, Croatie (fin IV<sup>e</sup> – début V<sup>e</sup> siècle apr. J.-C.): résultats d'un projet de recherche franco-croate, *Archaeonautica* 17, p. 105-152.
- BENOIT F.  
1958 Nouvelles épaves de Provence, *Gallia* 16, p. 5-39.
- CIBECCHINI F.  
2008 Tonnellaggi e rotte in età repubblicana: il contributo dei relitti del Mediterraneo Occidentale, in J. Pérez Ballester, G. Pascual Berlanga (eds), *Comercio, redistribución y fondeaderos: la navegación a Vela en el Mediterráneo, Actas de la V jornadas internacionales de arqueología subacuática, Gandía 2006*, València, Departament de prehistòria i d'arqueologia de la Universitat de València, p. 483-499.
- 2015 Les épaves antiques à grande profondeur en Corse, *Bulletin de la Société des Sciences Historiques et Naturelles de la Corse* 748-749, p. 7-23.
- CIBECCHINI F., CAPELLI C.  
2013 Nuovi dati archeologici e archeometrici sulle anfore greco-italiche: i relitti di III secolo del Mediterraneo occidentale e la possibilità di una nuova classificazione, in F. Olmer (ed.), *Itinéraires des vins romains en Gaule, III<sup>e</sup> – I<sup>er</sup> siècles avant J.-C. Confrontation de faciès, Actes du Colloque, Lattes 2007*, Lattes, CNRS Editions, p. 423-451.
- CORSI-SCIALLANO M., LIOU B.  
1985 *Les épaves de Tarraconaise à chargement d'amphores Dressel 2-4*, Paris, CNRS Editions, Archaeonautica 5.
- DANGRÉAUX B., FRANÇOIS S., GUIBAL F., WICHA S., GENTRIC G.  
2012 L'épave de la Tour Fondue (Presqu'île de Giens, Var), Un bâtiment de cabotage dans la seconde moitié du III<sup>e</sup> s. av. J.-C., *Cahiers d'Archéologie Subaquatique* 19, p. 5-36.
- GIANFROTTA P. A., POMEY P.  
1981 *Archeologia subacquea: storia, tecniche, scoperte e relitti*, Milano, Arnoldo Mondadori.
- JONCHERAY J.-P.  
1975 Etude de l'épave Dramont D : IV, les objets métalliques, *Cahiers d'archéologie subaquatique* 4, p. 5-18.
- KAPITÄN G.  
1984 Ancient Anchors – Technology and Classification, *IJNA* 13.1, p. 33-44.
- LONG L.  
2004 Epaves et sites submergés de la région d'Hyères de la préhistoire à l'époque moderne, *Scientific Report of Port-Cros national Park* 18, p. 47-96.
- MOREL J.-P.  
1981 *La Céramique Campanienne* : Rome, Ecole Française de Rome, BEFAR 244.
- POMEY P.  
2004 La structure du navire de la Madrague de Giens et le type hellénistique, *Ligures, Rivista di Archeologia, Storia, Arte e Cultura Figura* 2, p. 370-373.

POMEY P., GUIBAL F.

2001 Dendrochronologie et dendromorphologie des épaves antiques de Méditerranée (Bouches-du-Rhône et Var), *Gallia Information 1988-1999 : l'archéologie des régions : PACA, Département des Recherches archéologiques subaquatiques et sous-marines*, Paris, CNRS, éditions (CD-Rom).

POMEY P., RIETH E.

2005 *L'archéologie navale*, Paris, Errance.

STEFFY J. R.

1985 The Kyrenia Ship: An Interim Report on Its Hull Construction, *AJA* 89, p. 71-101.

UCELLI G.

1950 *Le Navi di Nemi*, Roma, Poligrafico e Zecca dello Stato.



# THE MA'AGAN MIKHAEL B SHIPWRECK: A SUMMARY OF FOUR EXCAVATION SEASONS

Maayan COHEN, Michelle CREISHER and Deborah CVIKEL

---

## Abstract

The Ma'agan Mikhael B shipwreck was discovered off the Mediterranean coast of Israel in 2005. The hull remains are in a good state of preservation, comprising the endposts, aprons, framing timbers, hull planks, stringers, mast step assembly and bulkheads. The most significant finds are the ceramic shards and the complete amphorae. Other finds include bricks, rigging elements, wooden artefacts, coins, organic finds and animal bones. The ship was dated to the 7<sup>th</sup>-8<sup>th</sup> centuries AD – a good reason to excavate it in order to evaluate its significance in the period of transition in ship construction from shell-first to frame-first.

## Keywords

Late antiquity, Late Roman amphorae, transition in ship construction, shipwreck

## Résumé

L'épave *Ma'agan Mikhael B* a été découverte au large des côtes israéliennes en 2005. Les vestiges de sa coque, très bien conservés, comprennent les massifs d'étrave et d'étambot ainsi que leurs renforts, des membrures, une partie du bordé, des serres, l'emplanture de mât et des cloisons. Des fragments de céramique et des amphores complètes figurent parmi les découvertes les plus importantes. Des briques, des éléments de gréement, des artefacts en bois, des pièces de monnaie, des éléments organiques et des os d'animaux ont été recueillis. Le navire a été daté aux alentours des VII<sup>e</sup> – VIII<sup>e</sup> apr. J.C.; les objectifs de la fouille étaient d'évaluer son importance dans la période de transition de la construction navale entre bordé premier et membrure première.

## Mots clés

Antiquité tardive, amphores romaines tardives, période de transition en architecture navale, épave

---

Kibbutz Ma'agan Mikhael is located on the Mediterranean coast of Israel, about 35 km south of Haifa (fig. 1). It is known for the 400 BC Ma'agan Mikhael ship, discovered in 1985 (Linder 2003; Kahanov 2011). About 150 m south of this shipwreck site, another shipwreck was discovered by chance in 2005 by two local divers, Nathan Helfman and Yossi Batzir, who reported seeing framing timbers, ceramic shards and stones. In May 2015, this information was verified by a sub-bottom profiler survey conducted in collaboration with Drs Grøn and Boldreel of the University of Copenhagen, Denmark. The shipwreck was identified in 1.5 m of water, under 1.5 m of sand, about 70 m from the shoreline, and designated Ma'agan Mikhael B. In August 2015, a water-jetting survey exposed fragments of wood, rope and a pine cone (Cvikel *et al.* 2017).

Wood and organic samples were dated preliminarily by <sup>14</sup>C analyses to the 7<sup>th</sup>–8<sup>th</sup> centuries AD, which is the Late Byzantine – Early Islamic Period in the region. Eight samples were sent for dendrochronology to Prof Manning and Dr Lorentzen at Cornell University, and are currently being studied. Typological studies of the ceramics and amphorae have identified at least four types of Late Roman transport vessels, including LRA 1, 4, 5 and 13, dated to the 7<sup>th</sup> century.

The main reason for excavating the Ma'agan Mikhael B shipwreck was its date: to evaluate the significance of the technology of its construction in the period of transition in hull construction from shell-first to frame-based. Every shipwreck of this period can provide valuable new insights into the process of change in Mediterranean shipbuilding techniques, which took place during the second half of the first millennium

AD. Until about 20 years ago, it was widely accepted that the first ship found of pure frame-based construction was the *Serçe Limani*, dated to 1025 AD. However, the Byzantine and Islamic Period shipwrecks at Dor (Tantura) lagoon, have provided evidence of earlier frame-based ships (Pomey *et al.* 2012).

A long-term programme of underwater excavation and research of the Ma'agan Mikhael B shipwreck was initiated. Four seasons of underwater excavations were conducted in May and December 2016, September 2017 and May 2018 by the Leon Recanati Institute for Maritime Studies of the University of Haifa (fig. 2). The site's location was challenging, due to a small island, which creates a meeting point between the offshore (southwest) current and a local (northwest) current in all but calm weather. This fact, and inclement weather, allowed only 27 excavation days out of the 59 planned. In the course of the excavation seasons the well-preserved hull was partly exposed, documented, and some components retrieved for further study.

The shipwreck remains, oriented roughly east/west (110°–290°), are 19.6 m long between extremities, and a maximum 4.9 m wide. The maximum depth reached was 3 m, and the keelson and keel have not yet been exposed. Among the hull remains in a good state of preservation are endposts, aprons, framing timbers, hull planks, stringers, the mast step assembly and bulkheads (fig. 3). A wide variety of finds were found: ceramic shards and complete amphorae, bricks, rigging elements and ropes, wooden artefacts, copper-lead alloy coins, food remains and animal bones. After documentation and careful consideration, some items were retrieved for further study.



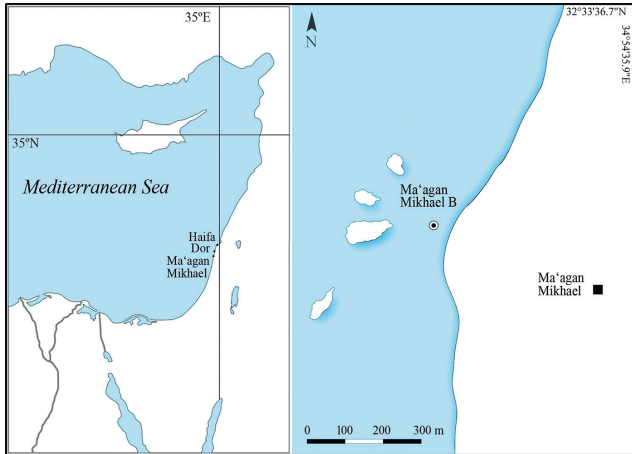


Fig. 1: Location of Kibbutz Ma'agan Mikhael and the Ma'agan Mikhael B shipwreck site (drawing N. Yoselevich).

## 1. HULL REMAINS

### 1.1. ENDPPOSTS

The eastern endpost was composed of two timbers connected by an elaborate scarf, a variation of the 'Jupiter' scarf. The upper timber was made of Aleppo or Turkish (Calabrian) pine (*Pinus halepensis/brutia*), and the lower timber was of walnut (*Juglans regia*). The endpost has been exposed for 186 cm. The maximum dimensions of these components are 12.5 cm sided and 23.5 cm moulded.

The upper timber of the western endpost is missing. The lower timber, made of walnut, was partially accessible for documentation. About 25 cm of its length was exposed. It is 13 cm sided and 12 cm moulded at the lowest exposed point, tapering to 10 cm at the top end.

### 1.2. APRONS

Adjacent to each endpost were installed what seem to have been aprons, although their relation to the keel is as yet unknown. These timbers, made of walnut, were definitely used as internal reinforcements. About 40 cm of the eastern apron was exposed. Its dimensions are 24 cm sided and 22 cm moulded. The western apron was exposed for 49 cm, and it seems to be almost round, with a diameter of about 8 cm.

### 1.3. FRAMING TIMBERS

Well-preserved framing timbers were found on both sides of the hull, comprising at least 30 frame stations. They were made of walnut, except for one, which was of holly oak (*Quercus ilex*), with no clear indication of it being a repair. On average the framing timbers were 13.3 cm sided and 12.3 moulded, with an average room and space of 44 cm. About 1 m of the framing timbers was exposed, and it was seen that the moulded dimension increased towards the keel. The cross-sections of the timbers varied: some were made of partially worked thick branches; others were trapezoidal or rectangular. The faces that were

connected to an adjacent frame or to a hull plank were carefully worked. On some of the framing timbers coating material and tool marks, perhaps of an adze, were visible.

### 1.4. HULL PLANKS

Sixteen hull planks made of fir (*Abies* sp.) were exposed. On average the hull planks were 17.6 cm wide and 3.2 cm thick. Many of the planks had scorch marks on their inner side, which might indicate 'char-bending'. A single butt joint was detected with traces of two iron nails, one from each side: perhaps a repair. Apart from this, no planking edge joints were found.

### 1.5. STRINGERS

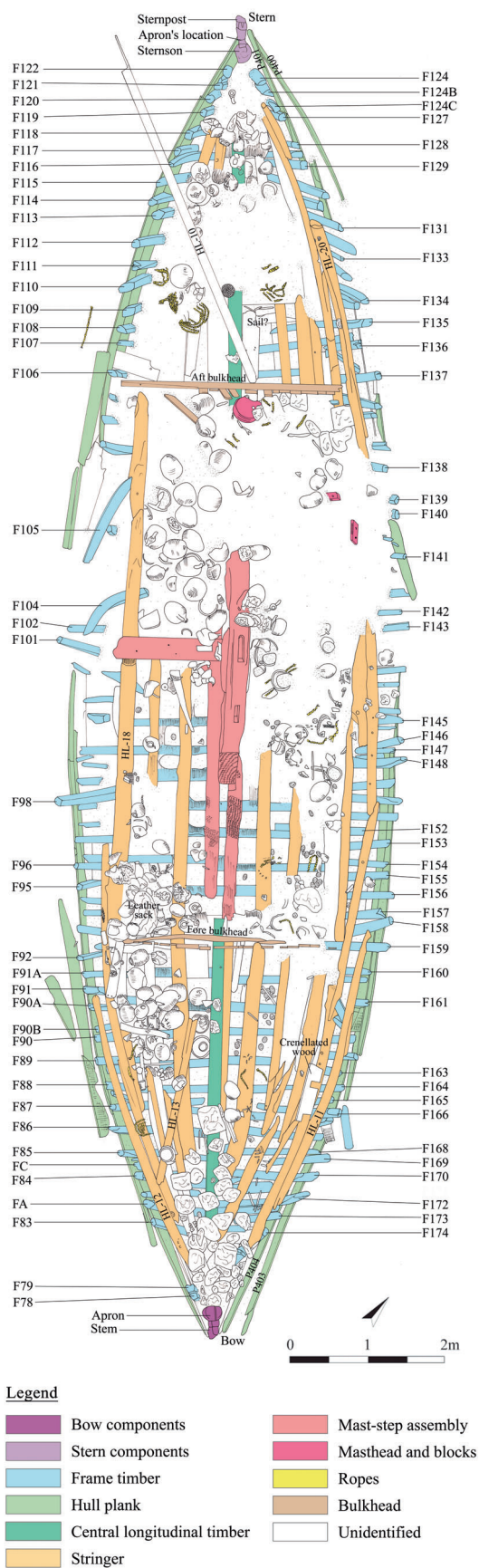
Eight stringers made of fir were found fixed to the framing timbers by iron nails, as confirmed by XRF analysis (Fe 94.4 wt%). They were on average 18.3 cm wide and 10 cm thick. Scorch marks were visible on the worked faces, along with tool marks, which were especially apparent on the chamfered edges close to the eastern endpost. On the round face, facing the interior of the hull, were remnants of branches, most probably cut by an axe, and a thick layer of coating material. One stringer had Greek letters and symbols carved into it, as well as the word *Allah* in Arabic. The purpose of these marks is not known: perhaps they are marks of the shipwrights or crewmembers.

### 1.6. MAST STEP ASSEMBLY

The exposed section of the mast step assembly comprised the mast step itself, longitudinal support timbers and a lateral crutch (fig. 3). The mast step and support timbers were made of walnut, and the crutch of fir. The mast step was exposed for 3.5 m, and it continued further into the sand. It was 25 cm wide and 19 cm thick. Two mortises were cut into its upper surface: the smaller one was 27 × 8 cm, and 12 cm deep,



Fig. 2: A diver on the Ma'agan Mikhael B shipwreck site (photography A. Yurman).



**Fig. 3:** Plan of the Ma'agan Mikhael B shipwreck (drawing P. Sibella, adapted by K. Asulij).

probably housing a stanchion supporting a mast partner. The other mortise, measuring  $37 \times 10$  cm and 6 cm deep, sloped downwards towards the west. This mortise probably housed the mast heel, and the slope suggests that the direction of the bow was towards the east. The crutch had a rectangular recess, about  $32 \times 9$  cm, apparently to house the heel of a stanchion for the mast support.

### 1.7. BULKHEADS

Two transverse sets of vertical planks made of fir were found, most probably bulkheads. The eastern and western bulkheads were located 13.8 m and 5.5 m from the western apron respectively. The planks were typically 15 cm wide and 4 cm thick. The longest plank projected 54 cm above the sand.

## 2. FINDS

Various types of finds were discovered during the excavation seasons. They were documented on site, retrieved and registered, and are currently being studied.

### 2.1 CERAMIC WARE: SHARDS AND COMPLETE AMPHORAE, AND BRICKS

Fifty-five amphorae were identified inside the ship (fig. 4a-b). This primary cargo was composed of six different types of amphora, including the types LRA 1, LRA 4, LRA 5, and LRA 13, as well as two types for which parallels have yet to be found. Thin section petrographic analysis suggests clay from Cyprus, Egypt and the Levant (Goren, personal communication, 2018). Some of the amphorae contained remains of their original contents, including raisins or grapes, olives, dates, pistachios, walnuts and pine nuts. In addition to the amphorae, a large assemblage of shards, juglets, bowls and cooking wares was found in the hull.

Fourteen inscriptions have been found either painted on or incised in the pottery. The inscriptions are of Arabic and Greek letters and Christian symbols, implying a diverse trade network. Both Christian and Arabic symbols appear on one specific type of amphora, the LRA 13, probably produced in Cyprus (Demesticha 2005). The style of the Arabic inscriptions suggests a date in the Umayyad period (660–750 AD) (Abadi, personal communication, 2018).

Two reddish-brown clay bricks (Munsell 5YR 4/4 and 2.5YR 5/6) were discovered near the eastern bulkhead. Both had charring marks, suggesting that they were part of the ship's galley. Petrography of the rectangular brick revealed the origin of the clay to have been in Cyprus or the northern Levant.

### 2.2. RIGGING ELEMENTS AND ROPE

Two rigging elements, apparently turning blocks, were found amidships. They were 35 cm long and 10 cm wide. Both had a rectangular cross section with chamfered edges and showed evidence of tool marks. They comprised a single sheave and





(b)



Fig. 4: Amphorae: (a) Late Roman 13, in situ near the mast step (photography A. Yurman); (b) Late Roman 5 containing walnuts (photography A. Efremov).

contained remains of rope. In addition, five well-preserved pieces of rope were found. All the ropes had three Z-twisted strands with an average diameter of 33 mm. The rope fibres were identified as hemp, coir and bast of unidentifiable species (Rast-Eicher 2016). Further study is needed to gain an understanding of the rigging of the ship.

### 2.3. WOODEN ARTEFACTS

Wooden artefacts were also found: 1) A roundel, 10 cm in diameter and 4 cm thick. Parallels to this were found in the Dor 2006 shipwreck and their use is still undetermined (Navri *et al.* 2013, p. 314); 2) Two worked wooden objects were found at the extremities of the hull, next to the aprons. The length of one of the objects is 20 cm, its maximum width 3.7 cm, tapering to 1.5 cm. Their use is still unknown.

### 2.4. COPPER-LEAD ALLOY COINS

Eleven copper-lead alloy coins were discovered in the shipwreck and retrieved for study. Based on the portraits of Constantine the Great, the coins were dated to the mid-4<sup>th</sup> century AD. These coins were small change in circulation during the 4<sup>th</sup>–6<sup>th</sup> centuries AD. In some cases, they can also be found in contexts of the 7<sup>th</sup> century AD. Since coins are essentially mobile, the ship's origin and dating cannot be determined using this information (Cohen *et al.* 2018).

### 2.5. FOOD REMAINS AND ANIMAL BONES

The food remains, which may hint at various aspects of daily life aboard a ship of this period, consisted of well-preserved

olive pits, walnuts, grape seeds, peach stones, carob pods and pine cones (fig. 4b). Animal bone remains were also found. Among them were bones of goat, donkey, pigeon, chicken, sea turtle and tortoise. The bones most probably indicate food consumption. It is reasonable to suggest that at least some of it was part of the crew's diet.

The Mediterranean diet is based on food that is eaten according to the season. In view of the apparent remnants of fresh fruit found onboard, the ship seems to have sailed between September and December.

## 3. SUGGESTED RECONSTRUCTION OF THE ORIGINAL SHIP

Preliminary dating, based on <sup>14</sup>C analysis and the typology of the amphorae and ceramics, places the shipwreck in the 7<sup>th</sup>–8<sup>th</sup> centuries AD. The dimensions of the Ma'agan Mikhael B's components can be compared to other shipwrecks of the period (table 1). Considering the archaeological evidence, it may be concluded that Ma'agan Mikhael B was smaller than Pantano Longarini (31.5 m), but larger than Yassi Ada 1 (20.5 m). She was perhaps closer in dimensions to those of the Dor 2006. Based on the archaeological remains, it is suggested that the ship was originally about 25 m long, with a beam of about 7 m and draught about 3.5 m, and therefore capable of carrying about 150 tons of cargo.

There is insufficient information as to the geometry of the cross section of the hull to suggest the construction tradition of the ship in the context of the transition from shell-first to frame-based. No planking edge joints have so far been found. As the study of the hull construction continues, the picture will become clearer and shed more light on the transition in ship construction.

**Table 1:** Comparative study.

| Shipwreck                | Date (century, AD)                                 | Estimated original length (m) | Planks: width, thickness (mm) | Frames: sided, moulded, room & space (mm) | Stringers: number, width, thickness (mm)                       | Concept and construction method (based on Pomey et al. 2012)  | References  |
|--------------------------|--|-------------------------------|-------------------------------|---|--|---|---|
| Dor D                    | 350-621  | 15-19                         | 200, 30                       | 100-110, unspecified, 230                 | Not present  | Shell hull concept, mixed structural concept and construction | Kahanov, Royal 2001; Royal, Kahanov 2005; Kahanov 2011a, p. 169-178; Pomey et al., 2012, p. 287 table 1                                   |
| Tantura A                | End 5 <sup>th</sup> – beginning of 6 <sup>th</sup> | 12                            | 38-260, 25                    | 90, 95, 324                               | Not present  | Frame concept and construction                                | Kahanov 2001; Kahanov et al. 2004, p. 113-118; Kahanov 2011b, p. 139-143; 2011a, p. 169-178; Pomey et al. 2012, p. 286, table 1.          |
| Dor 2001/1               | First third of 6 <sup>th</sup>                     | 16.9                          | 50-206, 20-33                 | 75-90, 85-120, 240                        | Two, 125, 82.5   | Frame concept and construction                                | Mor, Kahanov 2006; Kahanov 2011a, p. 169-178; Pomey et al. 2012, p. 287 table 1; Kahanov, Mor 2014  |
| Dor 2006                 | Mid-6 <sup>th</sup> – beginning of 7 <sup>th</sup> | 25                            | 75-227, 20-40                 | 65-250, 64-480, 240                       | Four, 227, 89  | Mixed shell-and-frame concept and construction                | Barkan et al. 2013; Navri et al. 2013; Kahanov et al. 2015  |
| Yassi Ada 1              | 625  | 20.5                          | 130-250, 35-42                | 140, 140, 300-350                         | Unspecified, 80, unspecified                                   | Mixed concept and construction                                | Steffy 1982, p. 65-86; van Doorninck 1982, p. 32-64; Pomey et al. 2012, p. 287, table 1   |
| Pantano Longarini        | Early 7 <sup>th</sup>                              | 31.5                          | 140-540, 50                   | 180-250, 180-250, 350                     | Two large and several light, dimensions and number unspecified | Mixed concept and construction                                | Throckmorton, Kapitän 1968; Throckmorton, Throckmorton 1973; Kampbell 2007; Pomey et al. 2012, p. 287, table 1                            |
| St Gervais 2             | Second half of 7 <sup>th</sup>                     | 15-18                         | 70-260, 25-30                 | 110-175, 160-335, 250                     | Two, 90, 190   | Skeleton concept and construction, based on frames            | Jézégou 1985, 1989; Pomey et al. 2012, p. 287, table 1  |
| Tantura F                | Mid-7 <sup>th</sup> – end 8 <sup>th</sup>          | 15.7                          | 80-200, 25                    | 80, 110, 310                              | Six, 150, 60   | Skeleton concept based on frames and construction             | Barkai, Kahanov 2007; Kahanov 2011b, p. 143-144; 2011a, p. 169-178; Pomey et al. 2012, p. 287, table 1; Barkai, Kahanov 2016              |
| <b>Ma'agan Mikhael B</b> | 7 <sup>th</sup> -8 <sup>th</sup>                   | 25                            | 120-230, 30-34                | 120, 120, 440                             | Eight, 182.7, 100.5  | To be determined  |   |
| Tantura E                | 7 <sup>th</sup> -9 <sup>th</sup>                   | 12.5                          | 100-210, 22-28                | 100, 120, 260                             | Eight, 102.1, 45.3   | Skeleton concept and construction based on frames             | Wachsmann, Kahanov 1997; Royal, Kahanov 2000; Kahanov 2011b, p. 145-146; 2011c; Pomey et al. 2012, p. 287, table 1; Israeli, Kahanov 2014 |
| Tantura B                | Beginning of 9 <sup>th</sup>                       | 18-23                         | 40-360, 30                    | 92, 94, 260                               | Two, 125, 82.5   | Skeleton concept and construction based on frames             | Wachsmann et al. 1997; Kahanov 2000; Kahanov et al. 2004; Kahanov 2011b, p. 146-150; Pomey et al. 2012, p. 287, table 1                   |
| Bozburun                 | 874  | 14.3                          | 30-40, 40                     | 120-170, 140-220, 300-400                 | Two starboard stringers, dimensions unspecified                | Frame concept, mixed construction                             | Harpster 2002, 2005; Pomey et al. 2012, p. 287, table 1   |

#### 4. CONCLUSIONS

The ship was a 25-m long merchantman with a cargo of amphorae originating from various places, including Egypt and Cyprus. The circumstances of the wrecking event are yet to be determined. The Ma'agan Mikhael B shipwreck promises to be an exceptional source of information regarding various aspects of ship construction, trading and economic activity, daily life,

and seamanship and seafaring in the Mediterranean in the late 7<sup>th</sup>-early 8<sup>th</sup> centuries AD.

#### ACKNOWLEDGMENTS

The underwater excavations (IAA permits G-41/2016, G-40/2017 and G-26/2018) and research of the Ma'agan



Mikhael B shipwreck are supported by the Israel Science Foundation (grant no. 1891/16), the Honor Frost Foundation, a Dov Shafir Fellowship, a Natan Rotenstreich Scholarship, a Sir Maurice Hatter Fellowship, the Research Authority of the

University of Haifa, and anonymous donors, to whom the authors are grateful. The authors would like to thank B. Lorentzen, S. Manning, R. Yeshurun, I. Abadi and Y. Goren for their valuable assistance, and J.B. Tresman for the English editing.

## REFERENCES

- BARKAI O., KAHANOV Y.  
 2007 The Tantura F shipwreck, Israel, *IJNA* 36.1, p. 6-28.  
 2016 The Tantura F shipwreck: hull remains and finds-final report, *IJNA* 45.1, p. 6-28.
- BARKAN D., YASUR-LANDAU A., MOMMSEN H., BEN-SHLOMO D., KAHANOV Y.  
 2013 The 'Dor 2006' shipwreck: The ceramic material, *Tel Aviv* 40.1, p. 117-143.
- COHEN M., ASHKENAZI D., BIJOVSKY I.G., INBERG A., KLEIN S., CVIKEL D.  
 2018 Copper alloy coins from the Byzantine-period Ma'agan Mikhael B shipwreck, Israel: metallurgical characterization, *Metallography Microstructure and Analysis* 7.5, p. 542-560.
- CVIKEL D., GRØN O., BOLDREEL O.L.  
 2017 Detecting the Ma'agan Mikhael B shipwreck, *Underwater Technology* 34.2, p. 93-98.
- DEMESTICHA S.  
 2005 Some thoughts on the production and presence of the Late Roman Amphora 13 on Cyprus, in M. Berg Briese, L.E. Vaag (eds), *Trade relations in the Eastern Mediterranean from the Late Hellenistic Period to Late Antiquity: the ceramic evidence*, Odense, University Press of Southern Denmark, Haliarnassian Studies 3, p. 169-178.
- DOORNINCK VAN F. H. JR.  
 1982 The Hull Remains, in G.F. Bass, F.H. van Doorninck Jr. (eds), *Yassi Ada Volume 1. A Seventh-century Byzantine Shipwreck*, College Station, Texas A&M University Press, p. 32-64.
- HARPSTER M.  
 2002 A preliminary report on the 9<sup>th</sup> century AD hull found near Bozburun, Turkey, in H. Tzalas (ed.), *Tropis VII, Proceedings of the 7<sup>th</sup> International Symposium on Ship Construction in Antiquity, Pylos 1999*, Athens, Institute for the Preservation of Nautical Tradition, vol. I, p. 409-418.  
 2005 Dowels as a means of edge-to-edge joinery in the 9<sup>th</sup>-century AD vessel from Bozburun, Turkey, *IJNA* 34.1, p. 88-94.
- ISRAELI E., KAHANOV Y.  
 2014 The 7<sup>th</sup>-9<sup>th</sup> century Tantura E shipwreck, Israel: construction and reconstruction, *IJNA* 43.2, p. 369-388.
- JÉZÉGOU M.-P.  
 1985 Eléments de construction sur couples observés sur une épave du haut Moyen-Âge découverte à Fos-sur-Mer (Bouches-du-Rhône), in *VI Congreso internacional de arqueología submarina, Cartagena 1982*, Madrid, Ministerio de Educación Cultura y Deporte, p. 351-356.  
 1989 L'épave II de l'anse Saint-Gervais à Fos-sur-Mer (Bouches-du-Rhône) : un navire du haut Moyen-Âge construit sur squelette, in H. Tzalas (ed.), *Tropis I, Proceedings of the 1<sup>st</sup> International Symposium on Ship Construction in Antiquity, Piraeus 1985*, Athens, Institute for the Preservation of Nautical Tradition, p. 139-146.
- KAHANOV Y.  
 2000 Tantura B shipwreck, A preliminary report on its hull construction, in J. Litwin (ed.), *Down the River into the Sea, Proceedings of the Eighth International Symposium on Boat and Ship Archaeology (ISBSA 8), Gdańsk 1997*, Gdańsk, National Maritime Museum, p. 151-154.  
 2001 A Byzantine shipwreck ('Tantura A') in Tantura Lagoon, Israel. Its hull construction, in H. Tzalas (ed.), *Tropis VI, Proceedings of the 6<sup>th</sup> International Symposium on Ship Construction in Antiquity, Lamia 1996*, Athens, Institute for the Preservation of Nautical Tradition, p. 265-271.  
 2011a Ship reconstruction, documentation, and *in situ* recording, in A. Catambis, B. Ford, D. Hamilton (eds), *Oxford Handbook of Maritime Archaeology*, Oxford, Oxford University Press, p. 161-181.  
 2011b The Dor/Tantura Shipwrecks: Clues to their Construction Tradition, *Archaeologia Maritima Mediterranea* 8, p. 137-151.  
 2011c Shipwrecks from Dor (Tantura) Lagoon: their contribution to the 'transition in construction', *Skyllis* 11.1, p. 46-50.
- KAHANOV Y., MOR H.  
 2014 The Dor 2001/1 Byzantine shipwreck, Israel: final report, *IJNA* 43.1, p. 41-65.
- KAHANOV Y., ROYAL J.G.  
 2001 Analysis of hull remains of the Dor D vessel, Tantura Lagoon, Israel, *IJNA* 30.2, p. 257-265.
- KAHANOV Y., ROYAL J.G., HALL J.  
 2004 The Tantura wrecks and ancient Mediterranean shipbuilding, in F.M. Hocker, C.A. Ward (eds), *The Philosophy of Shipbuilding: Conceptual Approaches to the Study of Wooden Ships*, College Station, Texas A&M University Press, p. 113-127.
- KAHANOV Y., ASHKENAZI D., CVIKEL D., KLEIN S., NAVRI R., STERN A.  
 2015 Archaeometallurgical Analysis of Metal Remains from the Dor 2006 Shipwreck: A Clue to the Understanding of the Transition in Ship Construction, *Journal of Archaeological Science: Reports* 2, p. 321-332.
- KAMPBELL S. M.  
 2007 *The Pantano Longarini Shipwreck: A Reanalysis*, unpublished MA thesis, Texas A&M University, College Station.
- LINDER E.  
 2003, The Discovery and preliminary exploration of the site, in E. Linder, Y. Kahanov, *The Ma'agan Mikhael Ship. The Recovery of a 2400-Year-Old Merchantman. Final Report, Volume I*, Jerusalem, Israel Exploration Society and the University of Haifa, p. 3-7.
- MOR H., KAHANOV Y.  
 2006 The Dor 2001/1 shipwreck, Israel – a summary of the excavation, *IJNA* 35.2, p. 274-289.  
*Munsell Soil Color Book*, 2013, Grand Rapids, MI Munsell Color.
- NAVRI R., KAHANOV Y., CVIKEL D.  
 2013 The Byzantine-period Dor 2006 shipwreck, Israel: preliminary hull construction report, *IJNA* 42.2, p. 305-325.

- POMEY P., KAHANOV Y., RIETH E.  
 2012 Transition from shell to skeleton in ancient Mediterranean ship-construction: analysis, problems, and future research, *IJNA* 41.2, p. 235-314.
- RAST-EICHER A.  
 2016 *Fibre samples*, Bern, Büro für archäologische Textilien, unpublished report.
- ROYAL J. G., KAHANOV Y.  
 2000 An Arab-period merchant vessel at Tantura lagoon, Israel (Trench 9), *IJNA* 29.1, p. 151-153.  
 2005, New dating and contextual evidence for the fragmentary timber remains located in the Dor D site, Israel, *IJNA* 34.2, p. 308-313.
- STEFFY J.R.  
 1982, Reconstructing the Hull, in G. F. Bass, F. H. van Doorninck Jr. (eds), *Yassi Ada Volume 1. A Seventh-Century Byzantine Shipwreck*, 65–86, College Station, Texas A&M University Press.
- THROCKMORTON P., KAPITÄN G.  
 1968 An Ancient Shipwreck at Pantano Longarini, *Archaeology* 21.1, p. 182-187.
- THROCKMORTON P., THROCKMORTON J.  
 1973 The Roman wreck at Pantano Longarini, *IJNA* 2.2, p. 243-266.
- WACHSMANN S., KAHANOV Y.  
 1997, The INA/CMS Joint Expedition to Tantura Lagoon, Israel, *INA Quarterly* 24.1, p. 3-18.
- WACHSMANN S., KAHANOV Y., HALL J.  
 1997 The Tantura B Shipwreck: The 1996 INA/CMS Joint Expedition to Tantura Lagoon, *INA Quarterly* 24.4, p. 3-15.



# A BYZANTINE PERIOD MERCHANT SHIP FROM THE BLACK SEA

Kroum BATCHVAROV

---

## Abstract

During three seasons of fieldwork, the Black Sea Maritime Archaeology Project (BSMAP) documented more than 60 shipwrecks, spanning the last 2500 years of seafaring history. Among the finds was BSMAP\_2016\_STR\_WRK\_002, a vessel dated to the end of the 9<sup>th</sup> or beginning of the 10<sup>th</sup> century AD. This paper offers a preliminary description of the find.

## Keywords

Black Sea, BlackSeaMAP, Byzantine, hull, shipwreck

## Résumé

Lors de trois campagnes de terrain, le Projet d'Archéologie Maritime de la mer Noire (BSMAP) a permis de documenter plus de 60 épaves, représentant près de 2 500 ans d'histoire de la navigation. Parmi les nombreuses découvertes, figurait BSMAP\_2016\_STR\_WRK\_002, un navire daté de la fin du IX<sup>e</sup> ou du début du X<sup>e</sup> siècle apr. J.-C.

Cet article propose une description préliminaire de la découverte.

## Mots clés

Mer Noire, BlackSeaMAP, époque byzantine, coque, épave

---

Between 2015 and 2017 an intensive programme of archaeological research was undertaken in Bulgaria's Black Sea territorial waters and exclusive economic zone. The Black Sea Maritime Archaeological Project (BSMAP) had a wide scope of activity, including: reconstruction of the quaternary paleo-landscapes of the Bulgarian shelf; investigating evidence of human response to Pleistocene and Holocene water level changes; locating, mapping and recording any evidence of pre-historic and historic human activity; enhancing the existing sea level curves for the Black Sea; and investigating maritime connectivity. In the process of the intensive geophysical remote-sensing survey more than 60 shipwreck sites were located.

Among the most significant sites was BSMAP\_2016\_STR\_WRK\_002, which was carbon-14 dated to the end of the 9<sup>th</sup>-beginning of the 10<sup>th</sup> century AD based on samples of wood and the main halyard. An amphora found in the bow and construction characteristics also assisted dating.

The core of the method used to document the sites consisted of high-resolution video and photographic surveys, from which were created three-dimensional photogrammetric models of the archaeological features.

## 1. DESCRIPTION OF THE SITE

BSMAP\_2016\_STR\_WRK\_002 lies about 92 to 96 m deep. It is located above the anoxic layer and therefore is less well preserved in comparison with deeper sites. It is also within the depth at which fishing vessels practice bottom trawling: although a few of the recorded shipwrecks had become victims of this destructive activity, BSMAP\_2016\_STR\_WRK\_002 has hitherto avoided the attention of the trawlers (fig. 1).

The wreck debris extends over 28 m, but the coherent observable ship structure is about 22 m long with a surviving breadth of 7-8 m.

Although the outline of the vessel is clear from the tops of frames protruding from the sediment, the upper works of the ship have mostly disintegrated. Much of the ship structure has fallen around the wreck and is buried by the sediment. The bow, recognisable by a stack of three anchors, is pointing to the northeast. All three of the anchors' crowns are orientated towards the stern.

Two pairs of futtocks, to port and starboard, are still standing about even with the forward end of the anchors' shanks. They are no longer vertical and have fallen out and aft, but their heels are likely to be close to their original position.

Forward of the frames, on the centreline of the wreck, protrudes the stump of a broken timber that is probably the stem.

Following the general curve of the site and the breadth between the surviving futtocks, it would appear likely that two or more metres separated the anchors from the stem.

Numerous timbers, probably futtocks, have fallen in the general area and are likely to have been part of the frames and bow structure. An amphora was found on the centreline of the vessel just forward of the frames.

The frames survive to a fairly uniform height above the bottom. Observed room and space varies between a low of 47 cm and a high of 72 cm, but the average is 55-57 cm. Nine futtocks survive to their original height. Two to three pairs in the extreme bow that have opened up but survive intact have a concave curvature, evidence of a surprisingly sharp entry. A matching pair of frames survives at an aft bulkhead. Both are still standing vertically in their original position and extend to a height of 2.5-2.6 m (fig. 2). One more futtock, in the stern to starboard, survives to a height of 2.45 m and also stands near its original position, though it is now leaning outwards. The corresponding futtock on the larboard side survives to a height of 1.2 m. The visible length of the futtock curves inwards, consistent with the run of the ship. In the observable part, the curvature is convex, with no visible reversal. The distribution of the surviving, standing frames is noteworthy and can possibly be



explained by pre-assembly, which may imply a frame-based, rather than shell-based construction.

Planking, still attached to the frames, survives below the level of the mud. A sondage more than 2 m in length, to a depth of 60-70 cm, was excavated along the starboard side which allowed the project director, Prof. Jonathan Adams, to study the area during two dives on the site. No mortise-and-tenon joints were observed at this height above the keel. This does not exclude their presence further down, similar to the ones found on the 7<sup>th</sup>-century Yassi Ada wreck, but it is clear that the strength of the hull could not have depended on mortises and tenons. Evidence for this is that the planking had fallen off where the iron fasteners that held it to the frames had rusted through. This is in strong contrast to what was observed on the earlier-period vessels discovered by the expedition, dated between the 5<sup>th</sup> century BC and 3-4<sup>th</sup> century AD, where mortises and tenons were used and the hull planking survived intact (or nearly intact) to the original height of the sides. Therefore, it is clear that the strength of BSMAP\_2016\_STR\_WRK\_002 was not derived from a mortise-and-tenon planking technique and therefore, following Pomey, the vessel must be considered conceptually a frame-based hull (Pomey 2004, p. 25-36).

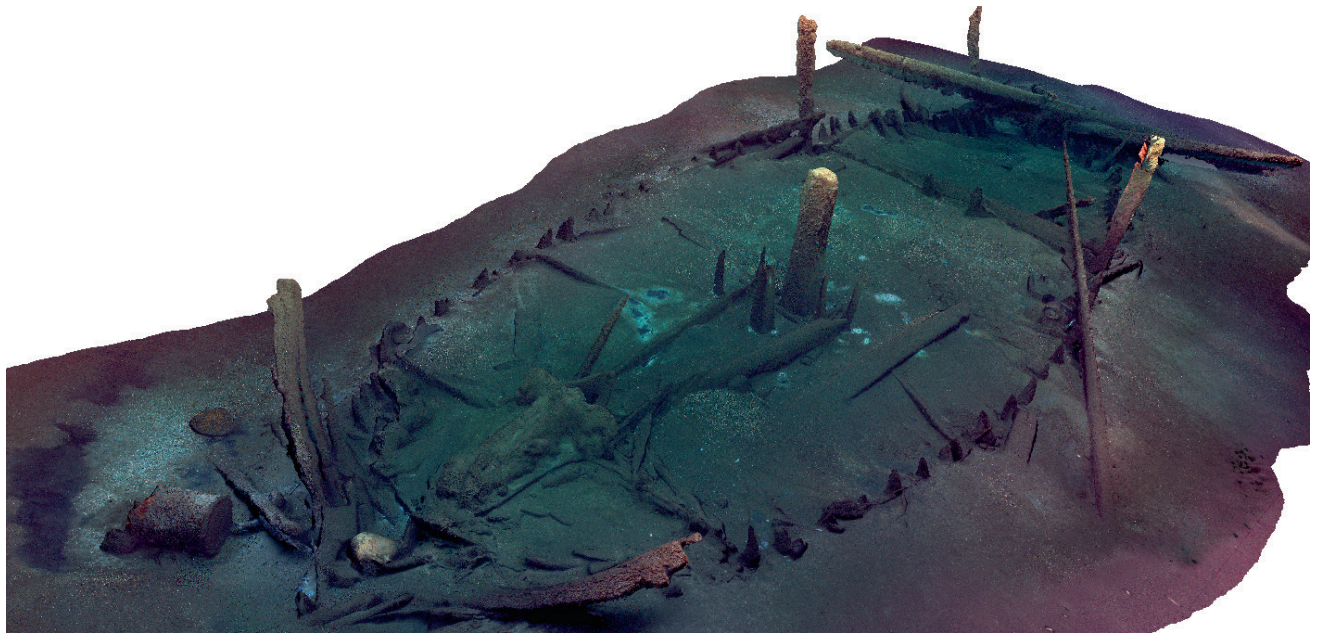
A beam lies athwartships, under the anchors' crowns, which was probably part of the foredeck and which collapsed with the disintegration of the ship (figs 1 & 2). Immediately aft of the anchors, further timber debris is visible on the centreline standing more or less upright. Unfortunately, not enough of it is observable, so it is hard to determine the purpose. The most likely explanation, based on location and overall dimensions, is that it may have been part of riding bitts.

The stump of a mast stands about 9 m from the remains of the stem. Between it and the anchors lies a jumble of timbers. They are more or less covered by overburden so it is not always possible to determine their shape, length or what part of the structure they formed. Some are oriented roughly across the wreck, and may be the remains of deck beams. Others are longitudinally oriented and appear to be planks, and thus are probably the remains of deck planking. Although an open hold cannot be excluded, some circumstantial evidence in addition to these timbers suggests this to be unlikely. Two timbers, oriented parallel to the centreline of the wreck, have notches cut in the faces lying upwards. One spans the entire distance between the aft beam of the collapsed bow platform and the mast area: the other one, fragmentary, lies to port of the mast. The notches into the timbers appear to be about equal in dimensions and to be equidistant from each other. This implies that they supported pieces lying at 90 degrees to them: ledges, perhaps. A broadly similar structure, though either more massive or better preserved, was also observed by the expedition on three of the Roman wrecks discovered.

On either side and forward of the mast are four vertical posts which may have formed an enclosure, similar to pump wells on later ships (fig. 3). The two forward posts are in line with a stanchion, forming part of the mast support, and the other two are in line with the mast further aft. Neither of them has their original surface, but surviving dimensions are about 16-20 cm square. The best preserved of the four reaches a height of about 1 m above the bottom, while the shortest is half this height. Both notched timbers reach them and it is possible that originally they were connected in some way. Forward of the mast itself, and on the centreline of the vessel, is a rectangular vertical timber or stanchion. The mast and the stanchion are separated by a gap of about 40 to 45 cm, which was probably originally filled by a transversal beam, though this



Fig. 1: Orthophoto mosaic plan of the site. Bow to the right (author R. Pacheco-Ruiz).



**Fig. 2:** Port bow view of the site with S-shape of bow frames and anchors visible to the left. The mast and stanchions are in the centre and the bulkhead is visible in the background (author K. Batchvarov after R. Pacheco-Ruiz).

either does not survive or is not visible above the overburden. Lateen-rigged vessels from around the Mediterranean sported this arrangement to the end of the 19<sup>th</sup> century: the mast is separated from the stanchion by a beam and is lashed under the beam to the stanchion, which is stepped on the keelson.

The mast is located at about 40% of the length of the vessel. Evidently the ship was single-masted, despite an overall length of 22-25 m. The lower part of the mast survives to a height of over 2 m above the bottom. Compared to the height of the frames still standing nearby and surviving to their original height, it would appear that the break point is about the height of the deck. The diameter of the mast is uncertain due to erosion, but is about 55 cm. A large round tapering timber lies in the aft quarter of the wreck and, based on its dimensions, it is most probably the broken upper part of the mast. Its length is at least 14.5 m, though the top is buried in the mud and may even be a little longer. It is hard to estimate the original length of the mast, but it appears probable that it was around 16-18 m (fig. 4).

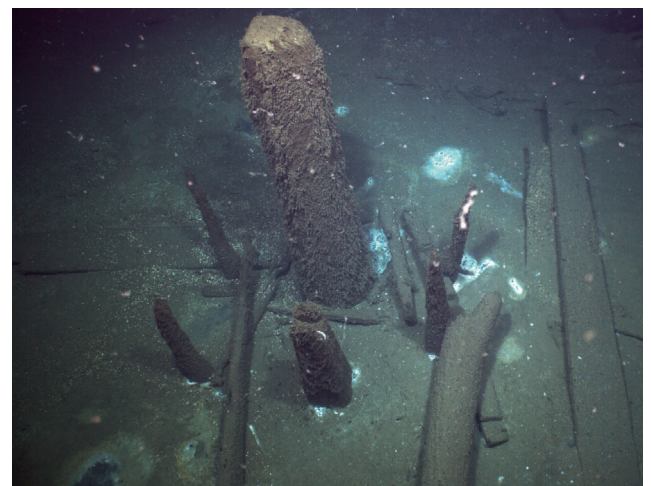
A long tapering timber, broken in the middle, lies across the wreck from the starboard stern quarter toward the port bow area. Its length is more than 17 m. Judging by its position across the wreck, close to the mast pieces, its length and the heavy taper from the thicker forward end towards the stern end, this appears to be the lateen yard of the ship.

At a distance of 4.5 m aft of the mast, the remains of a transversal bulkhead are visible. This was the second area of direct diver observation after a test excavation undertaken by a work class ROV. The excavation concentrated on one side and uncovered the excellent state of preservation of the vertically-planked bulkhead. Based on the test sounding, it is estimated that the hull remains extend to another 1 to 1.5 m below the mud level.

Two vertical posts of square section are located at the centre of the bulkhead. It is likely that they framed the entrance to the stern cabin, aft of the bulkhead. This area is completely covered by the overburden, but planks are visible in places. From these, it can be concluded that the sole of the stern cabin was oriented

athwartships, rather than fore and aft. Either an L-shaped timber, or a plank lying on edge forming right angles with the first plank of the sole, is positioned on the aft face of the bulkhead. In the centre of this athwartship-oriented plank, two notches are visible immediately next to the vertical posts. They may have been associated with a ladder leading to a hatch on the deck, or perhaps with hinges for a door closing the cabin from the hold area.

Further aft, a frame timber still stands *in situ* to starboard, while immediately adjacent and crossing each other lie the upper part of the yard, the broken mast, and a cambered timber that retains enough structural strength to protrude at an angle from the bottom to port. The other side of it disappears into the bottom on the starboard side of the hull. Some variation in interpreting this element has been encountered within the expedition, but here



**Fig. 3:** Mast stump in situ with support post in front and stanchions surrounding. The mast is about 55 cm in diameter: the post is about 40-45 cm a side (author K. Batchvarov after R. Pacheco-Ruiz).



it is proposed that the find is a through beam, which once formed part of the support for the steering oars. Off the starboard side and half way between the bulkhead and the beam, a fragment of a round, worked timber is visible, the dimensions and location of which may identify it as the shaft of the starboard steering oar.

## 2. FINDS

Few artefacts have been seen on the surface of the site. A single amphora was found forward, in the bow. Its shape seems to match best E. Todorova's Type VII (Todorova 2012, p. 15 and 23), which dates to the end of the 9<sup>th</sup> or first half of the 10<sup>th</sup> century AD. Notably, her classification system and chronology were also found to best match the evidence from the Yenikapi excavations (U. Koçabas, personal communication). N. Günsenin was open to a date earlier than the 10<sup>th</sup> century, which also agrees with the carbon-14 date (personal communication).

Three anchors lie on top of each other in the bow, most likely on a now collapsed platform or forecastle. They are concreted together, but the shape is discernible and dimensions of 2 m length from crown to cable ring and about 1.2 m spread at the arms can be estimated. As far as the author is aware, this is only the second example of Y-shaped anchors of known and secure provenance after those found at Serçe Limanı, a vessel that sank around AD 1025 (Bass *et al.* 2004, p. 189-241). A small broken Y-shaped anchor is also held in the Sozopol Museum of Archaeology, Bulgaria, but the find has no provenance and is thus not useful for establishing a chronology.

Just forward of the bulkhead and adjacent to the port frames, the mouth of a ceramic vessel, identified as a *dolium* (D. Garbov, personal communication), is visible. As it is mostly buried in the overburden, nothing can be said about it.

Further aft and in close proximity to the presumed lateen yard, two double-sheaved blocks were found. One of the blocks was recovered by the divers for further documentation and analysis. During the cleaning, remains of rope were found

around the sheaves, which are flat without a groove for the line. Such a sheave was also found on the wreck from Serçe Limanı (RG 12, Bass *et al.* 2004, p. 175, figs 11-6).

## 3. DISCUSSION

Shipwreck BSMAP\_2016\_STR\_WRK\_002 lies at a depth of 95 m with the bow pointing to the northeast. Enough of the hull structure survives to draw some general conclusions about it. Its length is likely to have been about 22-25 m overall with a beam of around 7.5-8 m. A few frames survive to their original height of 2.5 m above the current level of the bottom. Test excavations amidships inside and outside the hull indicate that the buried part of the ship is at least another 1 m deep, thus giving the ship a minimum depth of 3.5 m amidships.

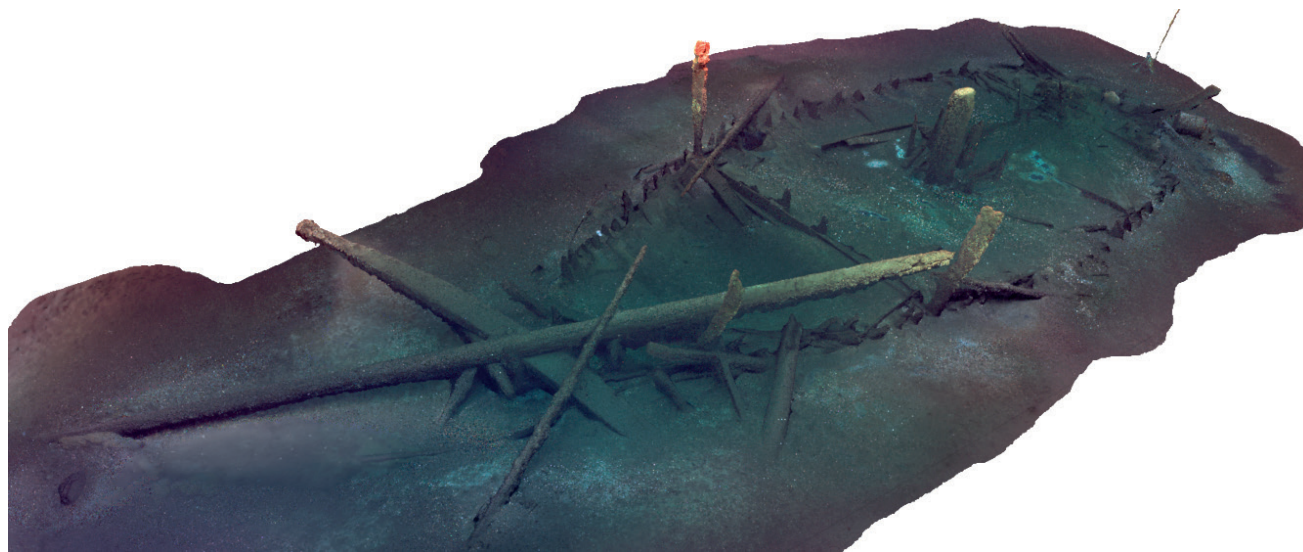
The position of the mast and the stanchion would suggest that the vessel was single-masted and lateen rigged.

The frames surviving in the bow and in the stern of the ship imply a sharp entry and fair run, with less curvature amidships and in the topsides. The collapse of the upper works imply that the ship was not built with mortise and tenon joints, a conclusion supported by diver observation of *in situ* planking.

The remains of a stern transversal bulkhead were observed. A similar arrangement, holding the ship's galley, was inferred from artefact distribution on the 7<sup>th</sup>-century Yassi Ada shipwreck (Bass, van Doorninck 1982, p. 87-121). The purpose of the stern compartment on the BSMAP\_2016\_STR\_WRK\_002 is unknown, but it may well have contained the galley too.

No evidence for a cargo of amphorae has emerged during the investigation of the site with ROV and divers. Thus, it can only be hypothesised what the ship was intended to carry, but a perishable material such as grain or other organic materials is most likely.

The wreck bears comparison with the Byzantine wreck from Yassi Ada and the Bulgar wreck from Serçe Limanı. The bow and stern frames of the ship are closer to the finer shape of the



**Fig. 4:** View from starboard aft quarter. Note the through beam, mast and yard and the possible loom of a quarter rudder in the foreground of the image (author K. Batchvarov after R. Pacheco-Ruiz).

Yassi Ada wreck than to the somewhat cruder shape of the Serçe Limanı vessel. Both ships share clearly defined stern sections separated from the hold. The overall shape of the ship, however, may be closer to the Serçe Limanı example. One is tempted to see in the symmetrical pair of frames standing to original height on the Black Sea ship, a pre-assembled pair, which may be indicative of an early version of whole-moulding. Such a system has been identified on the Serçe Limanı vessel and the late 9<sup>th</sup> century wreck from Bozburun, which is closer in date and also originated from the Black Sea (Bass *et al.* 2004, p. 153-170; Harpster 2005).

#### 4. CONCLUSION

The 9<sup>th</sup> and 10<sup>th</sup> centuries AD were an interesting period in the history of the Black Sea region. Most of the littoral was controlled by the Eastern Roman Empire, but this period also saw the First Bulgarian Empire reach its zenith under powerful rulers like Kanasubigi Krum and Tsar Simeon the Great who brought significant ports on the western shore of the Black Sea under Bulgar control. By the middle of the 10<sup>th</sup> century, the Kievan principality was also becoming a growing power in the region.

In this historical context a ship, either empty or carrying perishable, probably agricultural, cargo, sank towards the end of

the 9<sup>th</sup> or beginning of the 10<sup>th</sup> century. The expedition referred to the wreck BSMAP\_2016\_STR\_WRK\_002 as a “Byzantine” ship, but in truth there is virtually no way to establish political or ethnic association without complete excavation of the site. The similarities of the vessel with other shipwrecks associated with the Byzantine world makes it likely that the ship originated within the Empire. However, in the light of the find of Serçe Limanı, a Bulgar origin cannot be completely excluded, especially since western Pontic ports were in Bulgar hands at the time of its loss (van Doorninck 2012, p. 127-134).

What caused the sinking of the ship is also open to debate, but it is likely that it was overwhelmed by a storm while steering a course to the north or northeast. The mast was broken off approximately at deck level: at the time the vessel reached the bottom, the yard was lying on top of the broken mast, which suggests that the ship was sailing on the port tack and was caught aback, or was attempting to tack and shift the yard to the other side of the mast. The upper part of the mast lies oriented from NE to SSW. This supports the thesis of sudden change in wind direction from north to ENE or NE, which caught the sail aback and caused the dismasting. It is possible that in the process of dismasting, the ship capsized.

It has been indicated that the ship lies with the bow pointing to the northeast. Thus, it is likely that it was on a voyage originating in Constantinople and was probably heading to Byzantine Crimea. Trade with that region is attested by other wrecks, such as the Yassi Ada and Bozburun.

#### REFERENCES

- BASS G., VAN DOORNINCK F. H.  
1982 *Yassi Ada I: A Seventh-Century Byzantine Shipwreck*, College Station, Texas A&M University Press.
- BASS G., MATHEWS S., STEFFY J. R., VAN DOORNINCK F. H.  
2004 *Serçe Limanı: An Eleventh-Century Shipwreck*, Vol. I, College Station, Texas A&M University Press.
- DOORNINCK VAN F.H.  
2012 Ethnicity and Sphere of Activity of the 11<sup>th</sup>-Century Serçe Limanı Ship: Some Tentative Observations, in N. Günsenin (ed.), *Between Continents, Proceedings of the Twelfth International Symposium on Boat and Ship Archaeology (ISBSA 12), Istanbul 2009*, Istanbul, Ege Yayınları, p. 127-134.
- HARPSTER M.  
2005 *A Re-Assembly and Reconstruction of the 9<sup>th</sup>-Century AD Vessel Wrecked off the Coast of Bozburun, Turkey*, PhD dissertation, College Station, Texas A&M University.
- POMEY P.  
2004 Principles and Methods of Construction in Ancient Naval Architecture, in F. Hocker, C. Ward (eds), *The Philosophy of Shipbuilding*, College Station, Texas A&M University Press, p. 25-36.
- TODOROVA E.  
2012 *Амфорите От Територията На България (7ми-14ти Век) / The Amphorae from Bulgaria (7<sup>th</sup>-14<sup>th</sup> Centuries AD)*, PhD dissertation, Sofia, Sofia University St Kliment Ohridski.





# THE PARAGAN 1 SHIPWRECK, CORSICA: A 17<sup>TH</sup>-18<sup>TH</sup> CENTURY COASTER

Eric RIETH and Franca CIBECCHINI

## Abstract

The wreck is located in the Bay of Paragan near Bonifacio, southern Corsica and was discovered in 2015. It has been dated by Ligurian faïence to the end of the 17<sup>th</sup>-beginning of the 18<sup>th</sup> century. Since 2016, the wreck has been the object of an underwater excavation within the framework of the MoMArch international training school (A\*Midex, Aix-Marseille University, CCJ, DRASSM). The wreck displays several “architectural fingerprints” that are characteristic of the practices of Mediterranean frame-first construction and which have been attested archaeologically since the Middle Ages. One objective of the excavation is to provide answers relating to the architectural principles and building processes of the ship. Another objective is to restore the shape of the hull and rigging with the aim of identifying the architectural type of the Paragan 1 ship in the technical context of coasters of the western Mediterranean basin.

## Keywords

Carvel shipbuilding, Corsica, Mediterranean frame-first construction

## Résumé

L'épave, située dans la baie de Paragan près de Bonifacio (Corse du Sud), a été découverte en 2015. La faïence de la côte ligure retrouvée sur l'épave permet de la dater de la fin du xvii<sup>e</sup>-début du xviii<sup>e</sup> siècle. De 2016 à 2019, elle a fait l'objet d'une fouille sous-marine dans le cadre de l'école internationale de formation du Master « MoMArch » (A\*Midex, Aix-Marseille Université, CCJ, DRASSM). L'épave présente plusieurs « empreintes architecturales » caractéristiques des pratiques de construction méditerranéenne sur membrures attestées archéologiquement depuis le Moyen Âge. L'un des objectifs de la fouille est de fournir des réponses sur les principes et les processus de construction du navire, un autre, de parvenir, grâce à la restitution de la forme de la coque et du gréement, à l'identification du type architectural du navire dans le contexte technique des caboteurs du bassin méditerranéen occidental.

## Mots-clés

Construction à carvel, Corse, construction sur membrure

In June 2015, a Corsican diver from Bonifacio, Jérôme Poggi, discovered along the coast of the little Bay of Paragan, Corsica, a well-preserved hull exposed on the surface of the seabed at only 2.5 m depth (fig. 1).

A team of experts was quickly organised in July 2015 by F. Cibecchini, Corsica regional responsible of the French Department of subaquatic and submarine archaeological research (DRASSM). Several shards of Ligurian faïence, cooking pottery from Savona and other ceramics of the Provençal coast were found, dating the wreck to between the end of the 17<sup>th</sup> century and the beginning of the 18<sup>th</sup> century.

In April 2016, a fieldwork school began on the wreck as part the International Master of Maritime and Coastal Archaeology (MoMArch) course, led by Aix-Marseille University (AMU) and DRASSM. The excavation is co-directed by the two authors<sup>1</sup>. Three excavation campaigns, of two weeks each, have been carried out so far on the wreck (fig. 2)<sup>2</sup>.

1. In addition to the two authors of the article, the archaeological team is composed of H. Botcazou (AMU/LA3M-Ipso Facto), B. Debrand (Ipsio Facto), S. Greck (Ipsio Facto), D. Peloso (Ipsio Facto), S. Legrand (DRASSM), L. Roux (CNRS/CCJ), A. Sabastia (AMU/CCJ), M. El Amouri (Ipsio Facto), K. Baïka (AMU/CCJ), S. Marlier (Musée départemental d'Arles Antique) also participated in the first campaign in 2016. Only MoMArch Master's students, up to a maximum of eight people, can participate in the field school excavation.

2. The excavation of the Paragan wreck is financed by the AMidex\* Foundation of Aix Marseille University and by DRASSM, with the collaboration of the municipality of Bonifacio. The Natural Reserve of the Strait of Bonifacio has provided valuable help by providing a boat and the personnel necessary for transporting the material to the archaeological site.

Beyond its educational objective of training MoMArch students in the methods and techniques of excavating a wreck, the excavation of the Paragan 1 also has precisely determined scientific objectives. These are part of a research programme on the medieval and post-medieval history of Mediterranean naval architecture.

This nautical archaeology research initiative is based on archaeological sources, as well as written and ethno-archaeological sources, and is conducted along two main axes: “thinking” the ship and “making” the ship. First, it is a question of studying the processes of designing the structure and the geometry of the hull forms within the concept of a frame-first principle of shipbuilding. Secondly, it is a question of analysing construction methods and practices by revealing, in particular, a corpus of “architectural signatures” specific to western Mediterranean shipyards.

The latest campaign, April 2018, focused on the front part of the wreck, where the galley was probably located. In this area, which may well have felt the impact with the rocks, the wooden structures of the ship are dislocated and collapsed, effectively protecting the underlying layers, which are rich in archaeological material. Particular mention should be made of a wooden box containing more than ten jugs of Ligurian faïence. In the same zone, various kitchen pottery items from Savona, Liguria, coarse and glazed ceramics from the south of France (Huveaune Valley and Frejus), fragments of bricks, and some elements of charcoal and firewood clearly indicate the presence of the galley in this area. The recovered pottery confirms a date for the shipwreck at the very end of the 17<sup>th</sup> to the beginning of the 18<sup>th</sup> century.



Fig. 1: Geographical location of the wreck in Paragan Bay near Bonifacio, Corsica (drawing F. Cibecchini, DRASSM).

The ballast present inside the hull has been sampled and analysed. It is mainly composed of serpentinite pebbles that are found both in Cap Corse and in Liguria.

## 1. ARCHITECTURAL STUDY

### 1.1. STRATEGY AND SEARCH AREAS

As part of a multi-year excavation programme (2017-2019), and following a survey to assess the wreck (2016), the excavation strategy was based on a dual choice. Firstly, it was decided to operate by sectors. The three limited areas selected (north, middle, south) were however representative enough to provide an initial approach to the general architectural characteristics of the shipwreck. Secondly, a decision was made not to dismantle the architectural elements, except for a limited area around the master frame in order to obtain an integral cross section of this particularly significant part of the hull. It should be noted that this scientific choice was also linked to the need to protect the archaeological remains, which are endangered by the shallowness of the site and the risk of degradation in the event of a storm.

In this paper, we will limit our remarks to the most important architectural aspects: the general arrangement of the frames, the area of the master frame, the mast step, and the lower element of the sternpost. First of all, it is important to remember that among the various architectural signatures observed, two are very revealing of the practices and methods of the Mediterranean frame-first tradition of shipbuilding. These are, firstly, the systematic assembly of the carvel planks (4 cm thick) to the frames by two nails per frame as a rule, and more generally the assembly of the various architectural elements with iron nails and bolts. (In the current state of progress of the excavation, no assembly with treenails has been observed.) The second signature to be noted is the existence of a removable transverse ceiling between the keelson and the stringers. This transverse ceiling, *palhol* in Mediterranean terminology (Fourquin, Rigaud 1993, p. 269), extends the entire length of the keelson. The ends of the ceiling planks rest on half-lap longitudinal joints in the keelson and the stringers.



Fig. 2: The three areas of excavation 2016-2018 (photographs L. Roux, CNRS/CCJ; orthophotography D. Peloso, Ipso Facto).



## 1.2. THE GENERAL ARRANGEMENT OF THE FRAMES

In the entire wreck, only the floor timbers, *madiers* in French Mediterranean vocabulary (Fourquin Rigaud 1993, p. 230-231), and the first futtocks, *estamenaires* (Fourquin Rigaud 1993, p. 158-159), are preserved. Their average dimensions are 9.5 to 10.5 cm wide (sided) by 9 to 10 cm high (moulded). These elements of the framing have two main characteristics.

Firstly, in the aft and fore areas, the floor timbers are systematically oriented to face the centre of the wreck, i.e. towards the master frame, with the first futtocks of the south area fixed to the aft face of the floor timbers, and those of the north area fixed to the fore side of the floor timbers. There is, therefore, a regular arrangement of all the preserved frames on either side of the master frame, which represents the transverse centre of symmetry of the framing in both the conceptual and structural plans.

Secondly, in the aft part (south) of the wreck between the master frame and the aft end, i.e. on a length of 8.50 m, two sets of frames were identified at the level of the connection between the floor timbers and the first futtocks. A first set located towards the aft and fore ends of the wreck consists of frames whose first futtocks are simply fixed, without scarfs, to the floor timbers. A second set, located towards the centre of the wreck, is composed of frames whose first futtocks are joined by a hook scarf to the floor timbers. This double morphology of the assembly nailed between the floor timbers, and the first futtocks as architectural signatures refers directly to the design process of the geometry of the frames. The set of frames with a hook scarf definitely corresponds to predetermined and pre-moulded frames: and the set of frames assembled without a scarf corresponds to the frames that were shaped during construction, probably using ribbands. In this architectural context, the frames F 106 / F 107 must correspond to the aft tail frame.

In the fore part (north) of the wreck, the excavation revealed within the limits of the studied surface only non-predetermined frames, which are characterised by a simple assembly without scarf between the floor timber and the first futtock. Logically, the continuation of the excavation of this zone towards the master frame should reveal an organisation of the frames in two sets (assembly with hook scarf and without scarf), identical to those of the aft part of the wreck.

This design of the connection between the floor timbers and the first futtocks, very different from that with dovetail joints characteristic of the Ibero-Atlantic tradition (Oertling 2001, 2005), represents an architectural signature, among others, peculiar to the practices of Mediterranean shipyards: the so-called ‘whole moulding Mediterranean method’, the French method *du maître-gabarit, de la tablette et du trebuchet*, i.e. master mould, rising square and scale for narrowing the breadth (Rieth 1996). The oldest archaeological evidence of this method of design to be found so far is the Culip VI shipwreck in Spain, dating from the late 13<sup>th</sup>-early 14<sup>th</sup> century (Rieth, Pujol i Hamelink 1998), and one of the most recent (late 18<sup>th</sup>-early 19<sup>th</sup> century) is that of Kitten, Bulgaria, in the Black Sea (Batchvarov 2014), which represents a kind of ‘memory’ of Mediterranean technical culture of medieval and post-medieval shipbuilders.

## 1.3. THE AREA OF THE MASTER FRAME

The area of the master frame, which is particularly important in terms of design principle (shape and structure) and construction process (*chaîne opératoire*), is characterised by two floor timbers, the *madiers jumeaux* (Fourquin, Rigaud 1993, p. 230), which have a very small room and space of 6 cm. The average room and space between floor timbers is between 24.5 and 26 cm, characteristic of Mediterranean shipbuilding practices with a relatively light framing (fig. 3). The first futtocks are fixed to these two floor timbers by a hook scarf and horizontal nailing. The first futtocks of one of the master floor timbers are assembled on one side of the first floor timber, and the other first futtocks are assembled on the opposite side of the second floor timber. There is therefore a reversal of the position of the first futtocks determining the two sets of predetermined and pre-moulded frames in the fore and aft parts of the hull. This double master frame, located nearly 1.50 m forward of the middle of the presumed length of the keel, conforms to Type 2 of Rieth’s typology of the Mediterranean master frame (Rieth, forthcoming), of which the oldest archaeological evidence is that of the Boccalama galley wreck in the Venetian lagoon dated to the 14<sup>th</sup> century (Fozzati 2002). We should remember that Type 1 is characterised by a floor timber with hook scarfs at both ends, and that Type 3 is characterised by a floor timber with first futtocks connected by a hook scarf at each end.

The architectural recording of the cross section of the master frame revealed a flat floor timber, without any rising, with only a very slight deadrise of about 3 cm at the presumed *point d’escou* (start of the turn of the bilge) and the length of the floor line between the two presumed *points d’escou* measuring 2.32 m (fig. 4). This design of a flat floor timber with a bilge displaying a wide curvature radius, whose theoretical mould has been restored, is characteristic of a large Mediterranean family of boats and ships: local Mediterranean trading and fishing vessels whose shallow draught allowed easy access to the shore and facilitated beaching. As a research theory, three preliminary sketches for the reconstruction of the master frame up to the level of the greatest breadth were proposed. They are characterised by a beam between 4.40 m and 5.60 m, and a depth in hold from 2.10 m to 2.70 m.

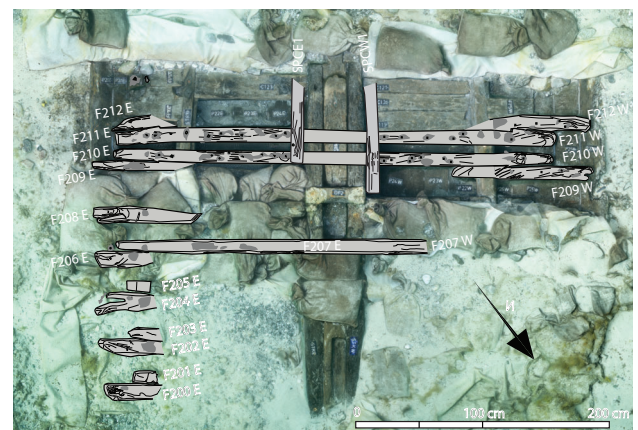


Fig. 3: The area of the two master frames (photographs L. Roux, CNRS/CCJ; orthophotography D. Peloso, Ipso Facto; drawing H. Botcazou, CNRS/LA3M, Ipso Facto).



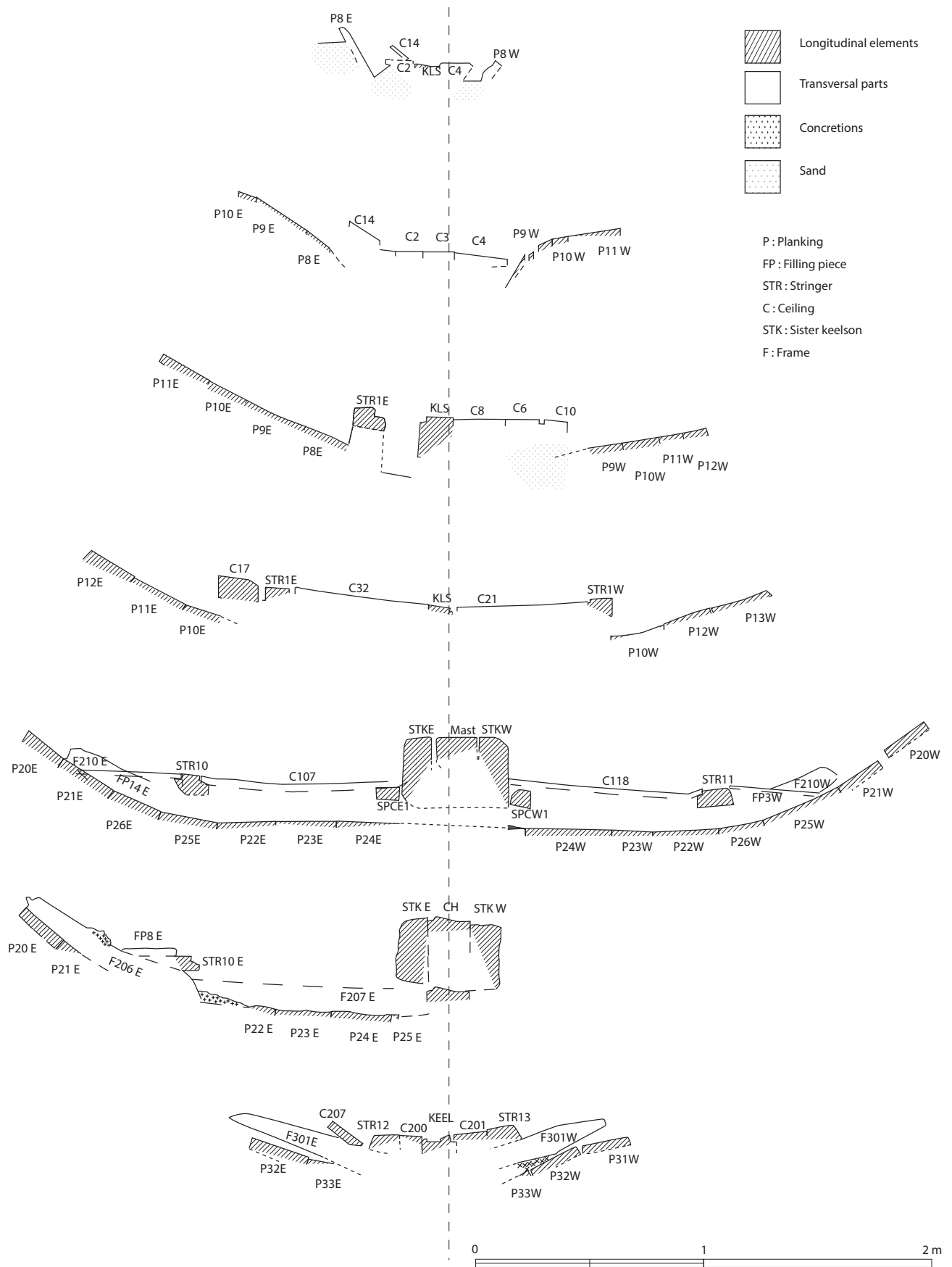


Fig. 4: The transverse sections of the wreck (drawing S. Greck, Ipso Facto, H. Botcazou, AMU/LA3M, Ipso Facto).



Fig. 5: The mast step (photograph L. Roux, CNRS/CCJ).

#### 1.4. THE MAST STEP

The mast step consists of a set of elements constituting a particularly solid composite structure (fig. 5). The keelson is doubled by a reinforcement nearly 2.80 m long, in which the tenon of the mast heel rested. On either side of this longitudinal element are sister keelsons of 2.60 m long, 30 cm high and 14 cm wide. The two sister keelsons, the *escasses* (Fourquin, Rigaud 1993, p. 152), which constitute the walls of the mast step are not sunk into the floor timbers. They are only connected and nailed together at the lower part of the keelson. Each sister keelson is reinforced transversely by two buttresses, the *coignets d'escasse* (Fourquin, Rigaud 1993, p. 105), located between the sister keelson and the stringers. Each buttress, 95 cm long, 30 cm high at the level of the sister keelson, and 10 cm wide, rests on a floor timber. The two starboard (eastern) buttresses delimit the lateral partitions of the pump well of which only a few lower elements (planks and corner posts) are preserved. Two wooden cleats, 46 cm long, 13 cm wide and 6 cm thick, are dovetailed into the top of the sister keelsons. Both cleats are nailed to the sister keelsons. The mast step mortise, 62 cm long, 16 cm wide, 14 cm deep, which held the foot of the mast is blocked by two chocks. This massive composite mast step corresponding to the position of the mainmast is, by its composite structure, one of the most representative architectural signatures specific to Mediterranean shipyards, the oldest archaeological evidence of which is that of the medieval wreck of Culip VI. It should be added that in the current state of the excavation, no data suggests the existence of a second mast, neither near the bow, nor near the stern.

#### 1.5. THE LOWER ELEMENT OF THE STEMPOST

This element is not connected with the main structure of the shipwreck. It lies along the longitudinal axis of the remains of the hull, about 20 cm from the northern end of the keelson. It is fully preserved at 3.35 m long. It consists of a stem element, 30 cm wide, and a false stem element, 18 cm wide, which were scarfed with other elements (a gripe in particular), which were not preserved (fig. 6). The main characteristic, very rarely found in a wreck, is the presence of four underlined Roman numerals – V to VIII – separated by a line in the middle of the interval, interpreted as draught marks. Two anomalous characteristics

should be noted: the irregularity of the intervals and the orientation of the lines, which, if they are in fact draught marks, should be parallel to the waterline. Two main questions arise: the first is that of the value of the interval, which is decisive for indicating the draught; the second is that of the restoration of the position of this lower element of the stem. The average interval between the engraved numerals is 26.2 cm. Cautiously taking into account the irregularity of the intervals, this average value appears to match the 'palm' of Cagliari and Sassari, which was defined officially in the 17<sup>th</sup>–18<sup>th</sup> century at 26.23 cm (Zupko 1981, p. 183-184). This hypothesis implies that the minimum light draught would be of the order of 1.30 m, and the fully loaded draught, in the state of conservation of the element, would be 2.30 m. The presumed value of the minimum draught, 1.30 m, is also an essential reference for restoring, as a preliminary working hypothesis, the original position of this stem element.

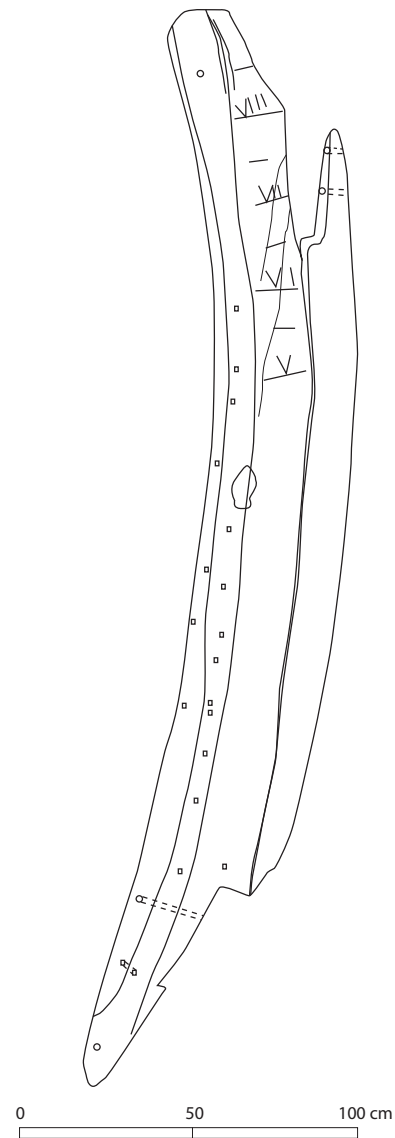


Fig. 6: The lower element of the stem and the false stem with the draught marks engraved in the wood (drawing H. Botcazou, AMU/LA3M, *Ipsa Facto*, A. Sabastia AMU/CCJ).

## 2. CONCLUSION

In concluding this paper about the main results of three excavation campaigns, we can state that the data acquired provide an ‘anatomical portrait’ of the Paragan shipwreck, revealing practices and a cultural technique specific to medieval and post-medieval Mediterranean shipyards. If questions remain, one thing is however certain: xylological analysis, conducted by S. Greck of Ipso Facto, has shown the use of a single species of wood – deciduous oak (*Quercus* sp.) – for the frames, the planks and for the main parts of the hull. This exclusive choice of oak for major elements of the architectural structure is logically an indication of a quality construction.

The Paragan 1 shipwreck, a vessel no doubt designed for regional trading, is particularly representative of the fleet of

coasters that was the basis of the sea transport economy in the various ‘Mediterraneans’, as in the inspired phrase of the French historian Fernand Braudel, “... la Méditerranée, plus qu’une masse maritime unique, est un complexe de mers” (Braudel 1966, p. 21). As such, it represents an important archaeological research laboratory for investigating the history of Mediterranean naval architecture, and will be the subject of at least one new excavation campaign in 2019.

## ACKNOWLEDGMENTS

Thanks to Deborah Cvikel, University of Haifa, for proof-reading the translation.

## REFERENCES

- BRAUDEL F.  
1966 *La Méditerranée et le monde méditerranéen à l’époque de Philippe II*, Paris, Armand Colin (2<sup>nd</sup> ed.).
- BATCHVAROV K.  
2014 The Hull Remains of a Post Medieval Black Sea Merchantman from Kitten, Bulgaria, *IJNA* 43.2, p. 397-412.
- FOURQUIN N., RIGAUD PH.  
1993 *De la nave au pointu. Glossaire nautique de la langue d’oc (Provence, Languedoc). Des origines à nos jours*, Saint-Tropez / Toulon, Objectif mer.
- FOZZATI L. (ED.)  
2002 La galea, in L. Fozzati (ed.), *La galea ritrovata. Origine delle cose di Venezia*, Venise, Consorzio Venezia Nuova.
- OERTLING T.  
2001 The concept of the Atlantic Vessel, in F. Alves (ed.), *Proceedings of the International Symposium of the Archaeology of Medieval and Modern Ships of Iberian Atlantic Tradition*, Lisbon, IPA, p. 213-228.
- 2005 Characteristics of Fifteenth and Sixteenth-Century Iberian Ships, in F. M. Hocker, C. A. Ward (eds), *The Philosophy of Shipbuilding*, College Station, Texas A&M University Press, p. 129-136.
- RIETH E.  
1996 *Le maître-gabarit, la tablette et le trébuchet. Essai sur la conception non-graphique des carènes du Moyen-Age au xx<sup>e</sup> siècle*, Paris, CTHS.
- Forthcoming, *Typology of the Mediterranean master-frame*.
- RIETH E., PUJOL I HAMELINK M.  
1998 L’arquitectura naval, in H. Palou, E. Rieth, M. Izaguirre *et al.*, *Excavacions arqueològiques subaquàtiques a Cala Culip.2, Culip VI*, Monografies del CASC 1, Girona, Museu d’Arqueologia de Catalunya-CASC, p. 115-189.
- ZUPKO R. E.  
1981 *Italian Weights and Measures from the Middle Ages to the Nineteenth Century*, Philadelphia, American Philosophical Society.

# THE MEDIEVAL SHIPWRECK FROM KALVEREV SYD, DENMARK

Mikkel H. THOMSEN

## Abstract

Prior to the building of a new bridge across the Storstrømmen sound the Viking Ship Museum excavated a section of a clinker-built vessel with external waterproofing laths and *sintels*, dendrochronologically dated to *circa* AD 1250-1255. The find was documented *in situ* using 3D photogrammetry and subsequently salvaged for further 3D laser scan documentation and conservation. This paper presents the sparse vessel remains and places them in the context of medieval shipbuilding traditions as they are currently understood. A comprehensive programme of scientific analyses provides insight into the working life and perhaps even the internal arrangement of the vessel.

## Keywords

Clinker-built, environmental archaeology, 13<sup>th</sup> century, waterproofing method

## Résumé

Avant la construction d'un nouveau pont sur le détroit de Storstrømmen, le Musée des Navires Vikings de Roskilde a été amené à fouiller une partie d'un navire construit à clin, daté dendrochronologiquement vers 1250-1255 apr. J.-C., et pourvu d'un système d'étanchéité externe constitué de lattes et de *sintels*. La découverte a été documentée *in situ* par la photogrammétrie 3D et par la suite récupérée pour une documentation par balayage laser 3D et pour sa conservation. Cet article présente les rares vestiges du navire et les replace dans le contexte des traditions de construction navale médiévales telles qu'elles sont actuellement connues. Un programme complet d'analyses scientifiques donne un aperçu de la vie à bord et peut-être même de l'organisation des différents espaces de chargement du navire.

## Mots-clés

Construction à clin, archéologie environnementale, XIII<sup>e</sup> siècle, méthode d'étanchéité

## 1. SITE HISTORY AND RECORDING METHODOLOGY

The shipwreck presented here was identified during archaeological surveys ahead of the construction of a new rail and road bridge across the Storstrømmen sound between the Danish islands of Masnedø and Falster (fig. 1).

It was found on the south bank of the shallow reef *Kalverev* where it lay covered by up to 1.5 m of sediment – on top of which lay a modern wreck. It was only discovered because the area was also suspected to hold Stone Age remains on a fossil terrain even deeper in the sediment. It was during a mechanical test excavation targeting these remains (and in the process removing the modern wreck) that medieval ship timbers were dug up. As it turned out, the wreck physically obstructed the intended construction works, necessitating full excavation, investigation, and removal (Thomsen 2017). This planned destruction of the site necessitated a particular focus on detailed and accurate documentation, as well as the fullest possible harvesting of information, in order to best preserve the research potential of the site.

The wreck was recorded *in situ* using 3D photogrammetry controlled by a trilateration network, key points of which were georeferenced by means of RTK-GPS survey.

Later, the salvaged parts were recorded individually using 3D laser scanning in combination with contact digitising of features not readily visible or identifiable in the scanned surface.

Thirdly, as much environmental evidence as possible was secured for subsequent analysis<sup>1</sup>.

## 2. VESSEL REMAINS

As it turned out, a lot of features of the wreck proved to be illustrative of developments in medieval shipbuilding, making it suitable for future museum display, education, and dissemination. Therefore it was decided to conserve and keep the timbers (and the waterproofing material), and they are currently undergoing conservation treatment at the National Museum of Denmark.

The wreck remains, dated to *circa* AD 1250-1255 (Daly 2017), constitute the aft end of the port side of the bottom of a clinker-built ship made entirely of oak (*Quercus* sp.) timbers and iron rivets. Planks are preserved from the fifth or possibly sixth (loose) port strake over the keel to the second starboard strake (fig. 2).

Four floor timbers are partly preserved and the positions of a further eleven are evident from treenails and from impressions in the tar conglomerate covering the inboard face of the planking. It is currently thought that the preserved remains span from the sternpost to somewhere just ahead of midships.

1. The site history and methodology is described in a forthcoming publication by Matko Čvrlijak and the author.



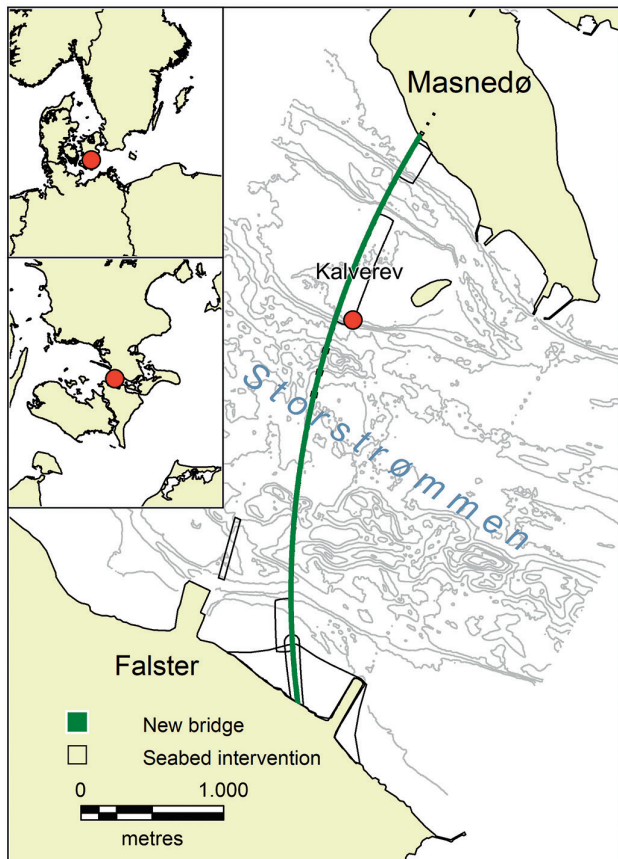


Fig. 1: Location of the wreck site in the Storstrømmen sound (drawing M. Thomsen).

## 2.1. CONSTRUCTION

The ship was built on a seemingly straight, (presumably double-) tapered keel with a marked T-shaped cross section. To this, plank strakes were attached with round-shafted iron clinker nails, *circa* 6.5 mm in shaft diameter, and square-to-rhombic roves. The planks were of varying length, up to 34 cm wide and *circa* 2 cm thick, radially cleft, and of relatively good quality although somewhat crudely finished. A single, short length of plank seems to have been replaced during the original construction phase, after which only routine overhaul, in the form of surplus clinker nails, is evident. Individual planks were joined in relatively long oblique scarfs (up to *circa* 19 cm), although without the protruding ‘ledge’ typical of the high/late medieval, long plank scarf (Bill 1995, p. 200, fig. 3) The scarfs were waterproofed with a wad of wool and assembled with iron clinker nails.

The plank seams were waterproofed by an inlaid, usually Z-spun, strand of medium-coarse wool/animal hair during assembly, supplemented on the outside by a strand of *Spaghnum cuspidatum* moss (Petersen A. H. 2018). The latter could either have been laid in during construction or driven in after plank assembly. This was held in place on the outboard side by a narrow waterproofing lath of oak (Baittinger 2018) with lentil-shaped cross section, secured with iron *sintels*. Judging from the odd rust impression here and there, the *sintels* were of Vlierman’s type B/C (Vlierman 1996, p. 55,

fig. 25, p. 58, table II). Their lower leg was driven approximately halfway through the thickness of the lower plank and their upper leg directly into the narrow edge of the upper plank.

Three preserved aft hood ends reveal the angle and relative position of the preserved lower part of the sternpost, even if its direct connection to the keel is missing. The keel terminates aft in a simple vertical scarf, and the lower end of the sternpost is broken just at the heel, not revealing whether it was in effect a long stern knee extending forward all the way to the keel scarf or whether there was a separate section of keel in between. On the better preserved downward-facing port side of the sternpost it can be observed that the lowest four strakes terminated in a stepped rabbet, whereas the upper strakes spanned the entire face of the triangular post.

The floor timbers, almost square in cross section, were connected to the hull planks with treenails and to now missing futtocks in a simple horizontal scarf. Their spacing is regular, *circa* 50 cm, except for the section aft of frame station 13 (fig. 2).

There were no preserved traces of keelson, stringers, ceiling or any other internal timbers.

## 2.2. BUILDING TRADITION

All in all the remains bear a striking resemblance to Wreck I from Slottsfrjärden, Kalmar, Sweden, excavated by Harald Åkerlund in the 1930s. The Kalverev Syd vessel, though probably some 10% bigger, has the same keel and sternpost shape, hood end fastening, framing pattern, and probably also a similar afterdeck arrangement, including the irregular frame spacing underneath (Åkerlund 1951, p. 27-50, pls 4-9). The waterproofing method, however, seems to differ.

Many of these features have in the past been regarded as chronological or geographical markers or as markers of a certain technological paradigm. In our current understanding the vessel places itself neatly in the chronology of the so-called Nordic clinker-building tradition, the development of which has been laid out rather convincingly by Jan Bill (1995).

Some features, such as the T-shaped keel, the majority of long planks, the plank width and conversion, and the ironwork are traditionally thought of as ‘archaic’ for the mid-13<sup>th</sup> century, whereas others, such as the crude plank finish, the scarfs, the framing system and (with some caution, as this feature is rarely preserved in typical shipwrecks) the sternpost assembly point to changes happening gradually through the 12<sup>th</sup> to 14<sup>th</sup> century (Bill 1995, p. 198-202).

So, the vessel was in many ways a truly ‘contemporary’ Nordic clinker-ship, however, the waterproofing method seems to be the odd exception. In Scandinavia, this method is usually associated with the so-called cog (or bottom-based) building tradition. The same can be said for the use of moss as waterproofing material (although south of the Baltic Sea it was also commonly used in wholly clinker-built vessels).

This begs the question: what is a ‘tradition’? And how do traditions interact? Through transfer or through assimilation? And should we regard the development of clinker shipbuilding as a gradual progression, or is there room for regression and diversification? And what drives the changes? Is it the commodities traded? The trade routes and waters? Or is it profit, as implied in Bill’s 1995 title?

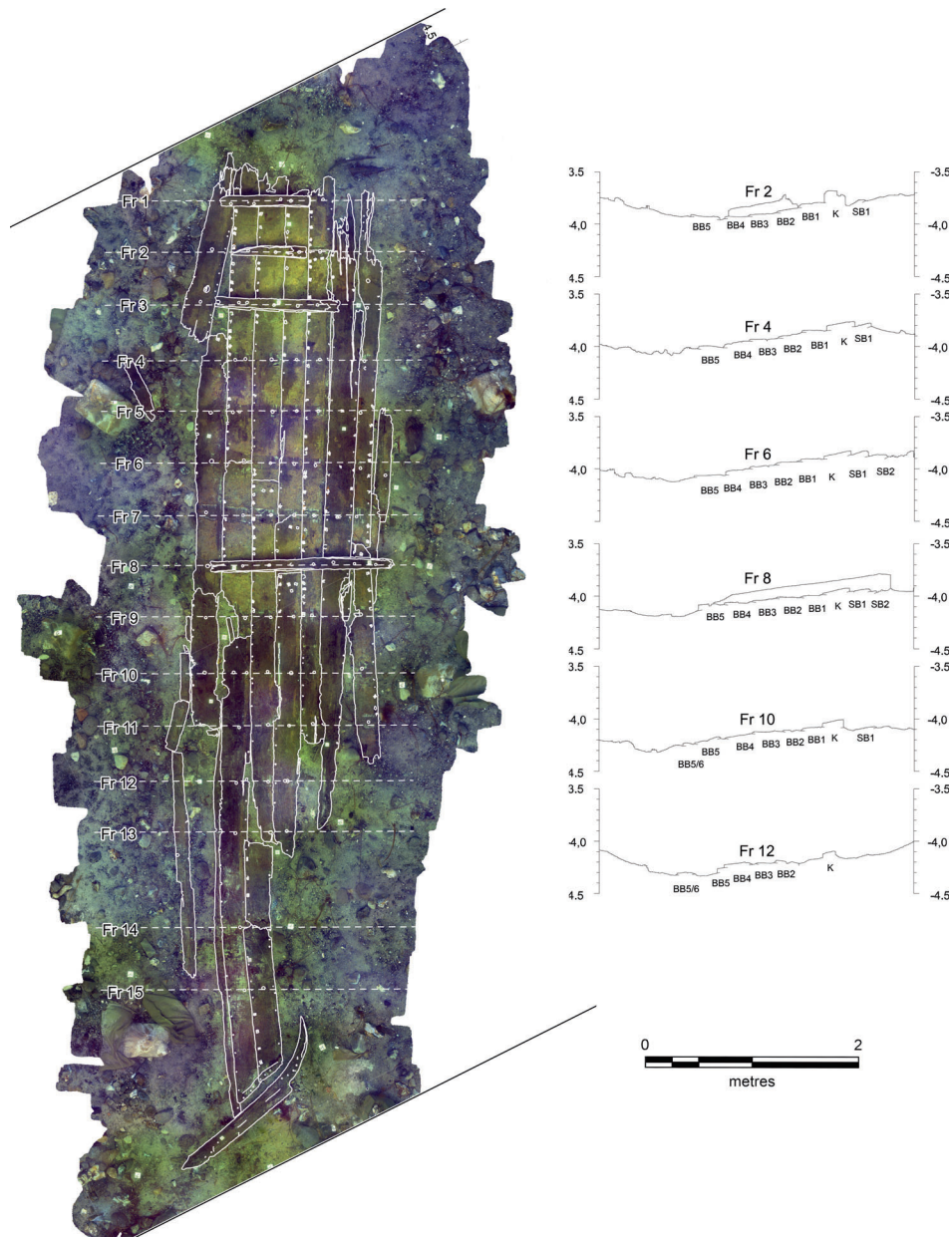


Fig. 2: Site plan: photogrammetry overlaid with traced timbers and frame stations (photogrammetry M. Čvrlijak, drawing M. Thomsen).

### 2.3. DATE AND PROVENANCE

Central to this question is, of course, the timber provenance of the ship. This, however, is not entirely clear.

Two of the ten datable dendrochronological samples (representing seven individual trees) have a clear match with South Jutland chronologies, whereas the remainder match east and west Danish chronologies equally well (Daly 2017). If this reflects procurement of timber from non-local sources in the 13<sup>th</sup> century it is highly interesting in its own right, but for the purpose of investigating building traditions it will suffice to say that the ship was Danish built. Did the seemingly uncommon waterproofing method come along with building materials from South Jutland – the same region as the dendro-provenance of early cogs (e.g. Hocker, Daly 2006; Daly 2015)? Or did it flow into the Nordic clinker paradigm from trade partners south of the Baltic?

### 3. ENVIRONMENTAL REMAINS

In order to investigate this last question further it would be convenient if the wreck presented some clues to its past cargo and other remains of life on board. While there is not a single artefact found in the wreck, we are lucky that, on a microscopic level, a layer accumulating environmental evidence throughout the ship's construction and operation is preserved: namely a thick conglomerate of tar, sand, wood chips and also micro- and macrofossils adhering to the inside faces of the hull planks (Henriksen *et al.* 2018).

The conglomerate is clearly visible as a yellowish substance terminating, in the port side, rather abruptly at frame station 9, whereas it continues at least to frame station 12 in the starboard side. The extent of the conglomerate may be an indication of the cargo hold. Another such clue is the frame spacing mentioned above, indicating, perhaps, that a deck existed aft of frame station 13 (fig. 2).

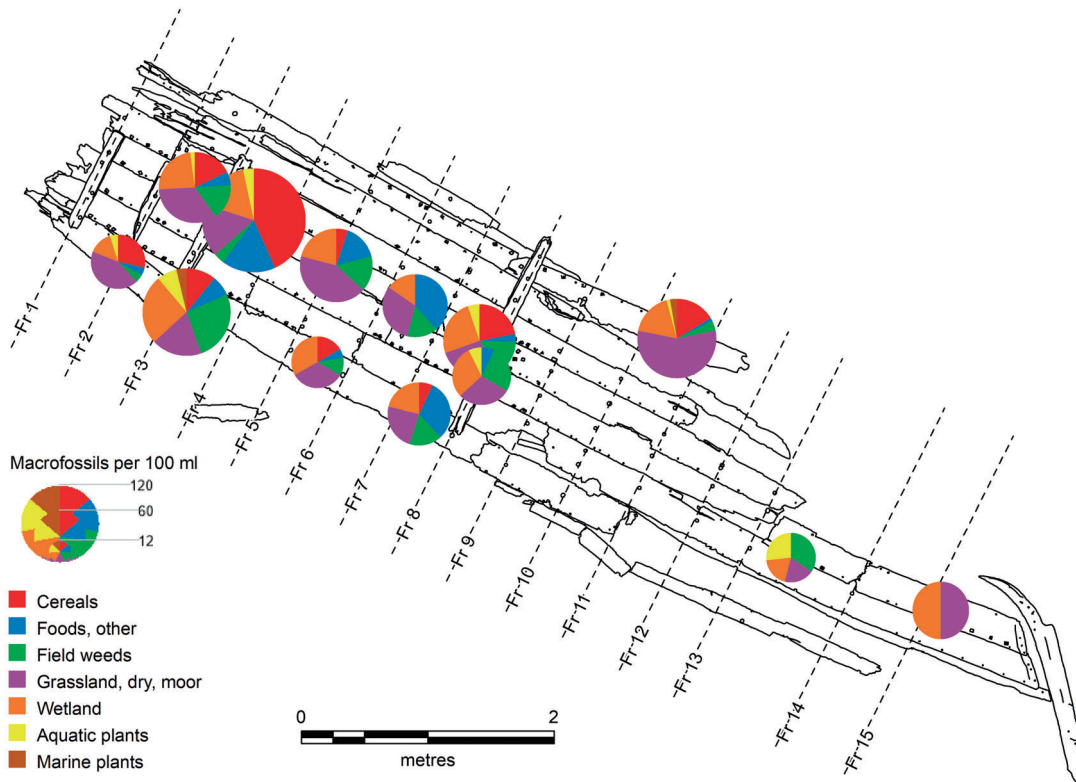


Fig. 3: Distribution of botanical macrofossils (drawing M. Thomsen after data from Henriksen et al. 2018).

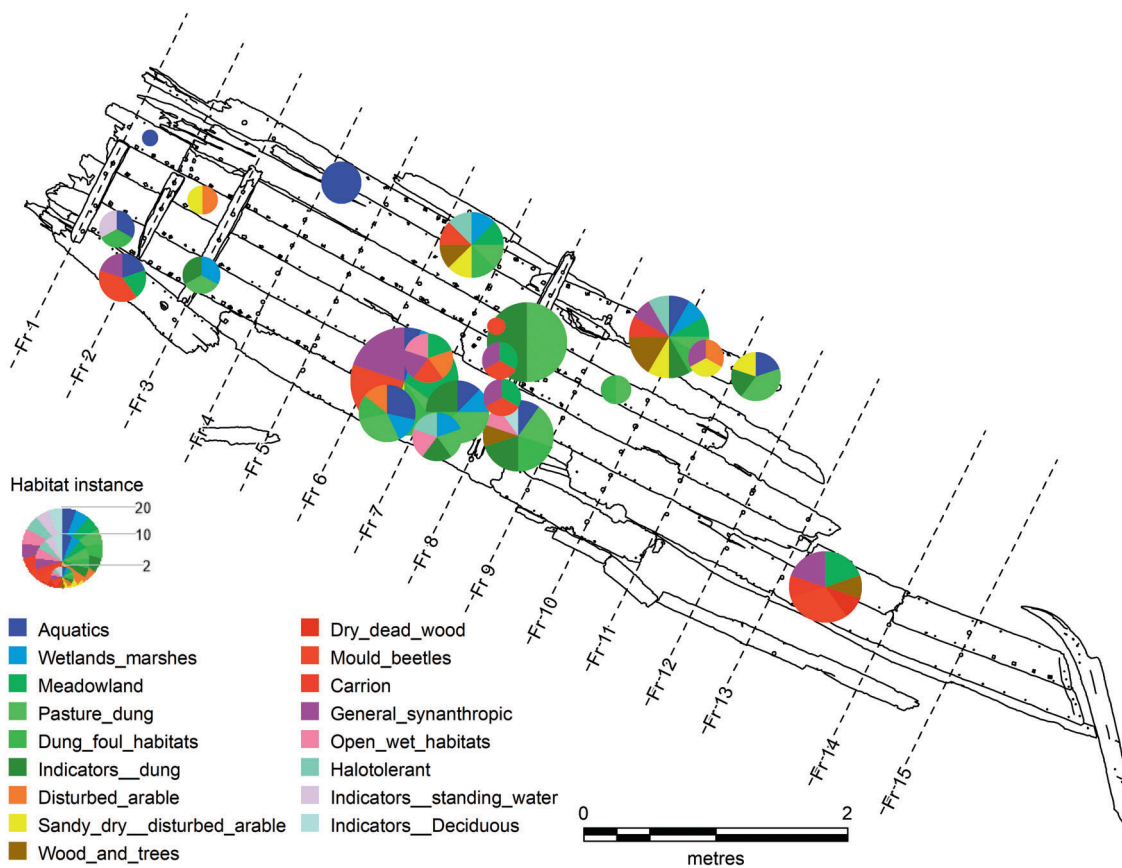


Fig. 4: Distribution of insects by habitat (drawing M. Thomsen after data from Petersen, J. 2018a).



### 3.1. BOTANICAL MICRO- AND MACROFOSSILS

The botanical macrofossils, summarised in fig. 3, seem to confirm a functional distinction between the area with massive conglomerate and the presumed decked area: cereals and other edible plants are only present forward of frame station 13 (additionally, aft of frame station 15 even field weeds – a possible proxy for cereals – disappear from the record). The apparent absence of conglomerate in the port side between frame station 9 and 13 cannot be explained through similar analysis due to the very scarcity of sample material. It would have been intriguing to know if perhaps there was a longitudinal functional division of this part of the ship. Was it, for example, kept clear of cargo to maintain access to the area below the afterdeck?

Besides being clues to the ship's arrangement, the macrofossils also provide an indication of activities on board and cargo carried. The general picture is of a ship carrying agricultural products, but what is perhaps more interesting is that they seem to have been unprocessed. Rye (*Secale cereale*), for example, was carried not just as threshed grains but also including the ears of the plant, indicating that the rye was transported as sheaves, inefficient as it may seem. The same was most likely the case for barley (*Hordeum vulgare*), as suggested by pollen analysis. Barley self-pollenates, leaving the pollen inside the chaff until threshing, so the presence of barley pollen indicates that the grain was transported before threshing. Also, hay may have been carried this way. Other products include bog myrtle (*Myrica gale*) and hemp (*Cannabis sativa*) or, more unlikely, male hops (*Humulus lupulus*). Incidentally, all of these products appear on lists of various forms of tax, duty or tithe from the medieval period (Porsmose 1988, p. 307-314).

Other botanical specimens are thought to be the remains of food supply onboard: apple (*Malus* sp.), raspberry (*Rubus idaeus*) and elderberry (*Sambucus nigra*) seeds, and – most conspicuous – a large number of humanly cracked hazelnut (*Corylus avellana*) shells.

### 3.2. ZOOLOGICAL MACROFOSSILS

The macrofossils also contained a variety of zoological specimens, mainly insects (Petersen J. 2018a, 2018b). Not only do they support the botanical evidence for the transport of grain, but the majority of specimens are actually associated with livestock, living in either the pastures or the dung (in which case the aforementioned hay and rye may be interpreted as fodder for the voyage).

The dark mealworm beetle (*Tenebrio obscurus*) is an example of the former, but it may also serve as an indication that the many down and feather fragments also found in the conglomerate are indeed from live animals carried on board at times and not just debris blown into the wet tar by the spring winds.

The dung beetle (*Aphodius sphacelatus*) – along with flies (e.g. *Scathophaga stercoraria*) – is perhaps the best-known example of the latter.

Also powderpost beetles (*Lyctus linearis*) were found. As no traces of their so-called shot holes (from which the larvae emerge) are found in the ship timbers, the vessel was almost certainly at times engaged in the transport of firewood – another major shipping commodity during the pre-industrial era. Firewood may also explain the presence of a few bones from

the least weasel (*Mustela nivalis*), wood piles being one of its preferred habitats.

It should be noted that the zoological evidence is somewhat conjectural and should mostly be seen in conjunction with other evidence. Some species may reflect more than one habitat, in which case all habitats are represented in fig. 4. Furthermore, one individual may be destroyed and the parts dispersed, resulting in more than one specimen per individual. Last but not least, the small sample volume naturally affects the statistical significance of the results.

This being said, it may still be possible to observe distribution patterns. Samples with species relating to animal dung (habitats *Pasture\_dung* and *Indicators\_dung* in fig. 4) are – except for one single fly pupa in a sample taken underneath frame 3 – confined to the area between frame stations 6 and 12, supporting the botanical and constructional evidence for an afterdeck but maybe even indicating a sub-division of the cargo hold. Frame 6 is currently suspected to be the midship frame as it is the central of three frame stations marked with incisions on the top face of the keel (figs 2-4). If the cargo hold was indeed divided in two compartments, the midship frame would be a likely place to divide it.

## 4. INTERPRETATION

All in all, the environmental evidence points to the ship tramping along rather locally, most likely collecting taxes from the rural population for a feudal, royal, or ecclesiastical landlord – perhaps victualing for the nearby royal castle of Vordingborg – as opposed to a ship involved in the export of what must be presumed to be processed and more effectively packaged agricultural products, for example from Zealand to the Hanseatic towns south of the Baltic, a trade that was quite substantial during the Middle Ages.

A mundane vessel such as this does not appear to be the most likely place to expect (perceived) 'foreign' building traditions to gain a foothold, serving as a reminder that shipbuilding was and is a lot more open to influence and technology transfer than perhaps often thought.

## ACKNOWLEDGEMENTS

Warm thanks to the excavation and documentation team: Thomas N. Andersen, Andreas G. Binder, Andreas K. Bloch, Sigurd A. B. Bohr, Matko Čvrlijak, Daniel P. Dalicsek, Massimiliano Ditta, Frederik D. Hyttel, Morten Johansen, Marie E. Jonsson, Tine V. Karlsen, Werner Karrasch, Nilas H. Møller, Tom Nicolajsen & Ines Šelendić, as well as a range of experts each contributing their particular area of expertise, often well beyond their contractual obligation: Claudia Baittinger, Mads C. Christensen, Peter S. Henriksen, Martin N. Mortensen, Morten Fischer Mortensen, Thora G. Nyborg, Anette H. Petersen & Kristiane Strætkvern (National Museum of Denmark), Aoife Daly (dendro.dk), Jesper Petersen (Natural History Museum of Denmark). The survey, excavation, and essential post-processing are financed by the Danish Road Directorate (Vejdirektoratet).



## REFERENCES

- BAITTINGER C.  
2018 *Ved anatomisk analyse af træliste fra Kalverev Syd VIR2794*, Brede, NNU report 24/2018.
- BILL J.  
1995 Getting into business. Reflections of a market economy in medieval Scandinavian shipbuilding, in O. Olsen, J. Skamby Madsen, F. Rieck (eds), *Shipshape. Essays for Ole Crumlin-Pedersen*, Roskilde, Viking Ship Museum, p. 195-202.
- DALY A.  
2015 Dendrochronological analysis of medieval cargo ships from Danish waters, in A. Englert, *Large Cargo Ships from Danish Waters, 1000-1250*, Roskilde, Viking Ship Museum, Ships and Boats of the North 7, p. 356-374.  
2017 *Dendrochronological analysis of timbers from a boat found at Kalve Rev, Denmark*, København, dendro.dk report 35/2017.
- HENRIKSEN P. S., MORTENSEN M. F., MORTENSEN M. N. CHRISTENSEN M. C., TAUBE M.  
2018 *Makrofossil- pollen- og tjæreundersøgelser af prøver fra Kalverev Syd-vraget*, Brede, NNU report 17/2018.
- HOCKER F., DALY A.  
2006 Early cogs, Jutland boatbuilders, and the connection between East and West before AD 1250, in L. Blue, F. Hocker, A. Englert (eds), *Connected by the Sea, Proceedings of the Tenth International Symposium on Boat and Ship Archaeology (ISBSA 10)*, Roskilde 2003, Oxford, Oxbow books, p. 187-194.
- PETERSEN A. H.  
2018 *Undersøgelse af kalfatringerne fra Kalverev Syd vraget VIR 2794*, Brede, NNU report.
- PETERSEN J.  
2018a *Insektanalyse af Kaverev Syd skibsvraget (VIR 2794)*, ArchaeoScience vol. XXI, Copenhagen, report.  
2018b Insects from tar patches in a medieval shipwreck from Kalverev Syd, Denmark, *Quaternary Entomology Dispatch*, p. 3-4.
- PORSMOSE E.  
1988 Middelalder o. 1000-1536, in C. Bjørn, T. Dahlerup, S.P. Jensen, E. H. Pedersen (eds), *Det danske landbrugs historie I. Oldtid og middelalder*, Odense, Landbohøjskole Selskab, p. 205-417.
- THOMSEN M.H.  
2017 *Kalverev Syd. Beretning for udgravning af middelalderlig vragedel*, Roskilde, excavation report.
- VLIERMAN K.  
1996 *... Van Zintelen, van Zintelroeden ende Mossen... Een breekmethode als hulpmiddel bij het dateren van scheepswrakken uit de Hanzetijd*, Lelystad, Ministerie van Verkeer en Waterstaat, Lelystad, Nederlands Instituut voor Scheeps- en onderwater-Archeologie, Scheepsarcheologie I, Flevovericht 386.
- ÅKERLUND H.  
1951 *Fartygsfynden i den forna hamnen i Kalmar: Kulturhistoriska undersökningar vid Kalmar slott utförda under ledning av Martin Olsson*, Uppsala, Almqvist & Wiksells boktr.

# THE 'BIG SHIP' OF WISMAR: A WELL-PRESERVED 12<sup>TH</sup>-CENTURY CARGO VESSEL FROM THE HARBOUR OF WISMAR

Massimiliano DITTA and Jens AUER

## Abstract

In December 2017, maritime archaeologists from the state department for archaeology in Mecklenburg Western Pomerania excavated, recovered, and documented a shipwreck in the seaport of Wismar. The wreck of a clinker-built cargo vessel was one of three medieval vessels found during the extension of the commercial port. With riveted outer planking and the presence of *bitis*, the wreck can be placed in the Nordic shipbuilding tradition. The results of the dendrochronological analysis show that the vessel was built from oak and pine sourced from western Sweden in the period AD 1184-1190. The construction shows striking similarities with a number of large 12<sup>th</sup>-century cargo vessels found in northern Germany and Scandinavia.

## Keywords

Excavation, Mecklenburg Western Pomerania, shipwreck, 12<sup>th</sup> century, Wismar

## Résumé

En décembre 2017, des archéologues maritimes du Département d'Archéologie de la région de Mecklembourg-Poméranie occidentale ont fouillé, récupéré et documenté une épave dans le port de Wismar. Cette épave d'un cargo bordé à clin était celle de l'un des trois navires médiévaux découverts lors de l'extension du port de commerce. Avec des bordés extérieurs rivetés et la présence de *bitis*, l'épave peut être replacée au sein de la tradition de construction navale nordique. Les résultats de l'analyse dendrochronologique montrent que le navire a été construit à partir de chênes et de pins provenant de l'ouest de la Suède, entre 1184 et 1190 apr. J.-C. La construction présente des similitudes frappantes avec un certain nombre de grands navires de charge du XI<sup>e</sup> siècle trouvés dans le nord de l'Allemagne et en Scandinavie.

## Mots clés

Fouille, Mecklembourg Poméranie occidentale, épave, XI<sup>e</sup> siècle, Wismar

## 1. THREE SHIPS IN WISMAR HARBOUR

The city of Wismar is located in the northwestern part of Mecklenburg Western Pomerania on the Baltic Sea. With its sheltered location at the end of a bay, Wismar served as a port from at least the early 13<sup>th</sup> century onwards (Radohs 2016) and was an early member of the Hanseatic League (fig. 1).

In 2016, the planned extension of the modern seaport led to extensive construction work east of the existing commercial harbour. During the unexploded ordnance survey of the same year two medieval shipwrecks dating to the 13<sup>th</sup> century were discovered and subsequently excavated and recovered by an archaeological contractor. During the excavation of the second wreck (Wismar, Ostsee II, Fpl. 30), a third wreck was encountered in April 2017. This new site, designated Wismar, Ostsee II, Fpl. 32, was partially covered by the overlying wreck Fpl. 30. The excavation of the first two sites was completed in August 2017 and the third wreck was protected by an exclusion zone pending a decision about its future.

In November 2018 the state authority for culture and monuments (Landesamt für Kultur und Denkmalpflege Mecklenburg-Vorpommern, LAKD) was tasked with the excavation and documentation of the site. For the construction work to continue, the wreck and all associated material had to be lifted from the seabed. The recovered timbers were to be documented on the

surface and subsequently wet-stored until conservation treatment could be started.

## 2. EXCAVATION AND RECORDING OF THE WRECK WISMAR, OSTSEE II, FPL. 32

The excavation was carried out over a period of 26 days in November and December 2017. As the wreck was located in 2.5 m of water close to the shoreline, the dive team of six archaeologists was based on a shallow draught MPV with spud legs. All diving was conducted using surface air supply. A layer of compact silt up to 1.5 m thick covering parts of the wreck site was removed using water dredges. Once the wreck was fully exposed, the timbers were systematically removed following the reverse order of construction and lifted to the surface. Each stage of the excavation was documented using photogrammetry. As the visibility on site was limited, a GoPro Hero 5 camera with additional lighting system was used to obtain the necessary footage. The survey data for each layer was processed overnight with the goal of producing a basic site plan, which could be used to reference the timbers that were lifted to the surface (fig. 2). Upon recovery, the timbers were moved into a wet storage basin in the port of Wismar and finally to the LAKD conservation facilities in Schwerin.



Fig. 1: Map of the site location showing the Bay of Wismar (Ditta 2019).

Following the excavation, the ship timbers were recorded in 3D using an Artec EVA structured light scanner. Each timber was cleaned, sampled and subsequently scanned. The resulting 3D models were imported into Rhinoceros3D, where they could be annotated. A written description and photographs of details were then added in order to compile the final catalogue entry for each timber (Auer, Ditta, 2019; Van Damme in this volume).

### 3. THE 'BIG SHIP' OF WISMAR

The 19.8 m-long and 5.3 m-wide wreck was resting in the soft bottom sediment at a 20 to 25 degree angle to the port side, where 17 strakes of outer planking were preserved. On the starboard side only four strakes survived *in situ*. Neither keel nor posts were found. Inside the wreck, 28 frame stations were preserved with their associated timbers. Apart from the intact keelson, stringers and part of the deck construction aft could be recorded (fig. 3).

The survival of garboard strakes, post wings forward and aft and the well-preserved aft scarf on the aftmost outer planks point to an intentional removal of keel and posts at the time the vessel was abandoned.

The majority of the lapstrake outer planking was radially cleft from straight-grown oak trees. From the thirteenth strake upwards, a number of pine planks were used. Most notable are large carved pine planks in the fourteenth and fifteenth strake, which might have served as a longitudinal reinforcement and outer hull protection. The oak planks vary between 2.4 m and 6.8 m in length and have an average width of 30 cm in the midship area. The pine planks are generally longer and thicker than those of oak. Planks within a strake were connected with short (9 cm to 15 cm) vertical scarf joints, which were sealed with mats of sheep wool and tar. Adjoining strakes were sealed with strands of sheep, goat and cattle hair and wood tar and fastened to one another with round-shafted clinker nails with round heads, which were clenched over rectangular rove plates on the inside. Where

clenching on the inside was not possible due to a lack of space, the clinker nails were inserted inside out. An interesting detail in the outer planking is the reversal of the scarf direction above the waterline. While scarfs in the lower part of the vessel were oriented with the opening facing aft to prevent water ingress, they faced forward from strake 14 upwards.

The framing system with joggled floor timbers, *bitis* and *biti* knees is characteristic of the Nordic shipbuilding tradition from the late Viking Age and high medieval period. Towards the stern, in relation to the aft deck, the *bitis* and *biti* knees are combined in a single piece and the timber sequence continues with shelf clamps, beams and beam knees.

The frame spacing is relatively regular with an average distance of 51 cm. The spacing between the second and third frame station and the twenty-second and twenty-third frame station from the bow is above average, with 86 cm and 87 cm, and defines the extension of the open hold.

The floor timbers were boxed from oak crotches and follow the pronounced V-shape of the underwater hull. The arms have a rectangular section with a moulded dimension in the range of 9 cm to 11 cm and a sided dimension in the range of 10 cm to 12 cm. The timbers were not secured to keel or garboard strakes. The floor timber at the first frame station has a rounded tip on the inboard surface, giving it a characteristic W-shape. Similar frames are known from other ship finds (Englert 2015, p. 163). In the case of the Danish find Lynæs 1 (1140 AD), the W-shaped floor timber is believed to mark the end of the keel or hold (Englert 2015, p. 164).

The majority of the preserved *bitis* were boxed from straight-grown pine, whereas the *biti* knees are made of compassed oak. The timbers are rectangular in section with a moulded dimension in the range of 13.5 cm to 18 cm, and a sided dimension in the range of 8.5 cm to 12 cm. On the underside, the preserved *bitis* are furnished with two elegant arches, besides the joggles for receiving up to five strakes. The first arch is used to lodge the floor timber into the *biti*, while the second arch probably has a decorative function or was used for weight reduction. Along the centreline of the vessel, the *bitis* were notched to fit over the oak keelson. The *bitis* at the eleventh and twelfth frame station were cut out to receive the foot of the mast and thus served as an extension of the mast step.

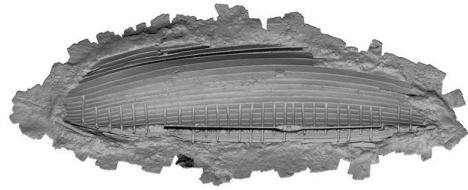
Both in the floor timbers and *bitis*, small triangular notches at the end of each joggle functioned as limber holes.

The frames and other internal timbers are fastened to the strakes with pine treenails of 30 mm diameter. The treenails have protruding dome-shaped heads and were expanded with large irregular pine wedges on the inboard side.

Four types of internal longitudinal strengthening timbers or stringers are found across the hull. The lowest stringers are a set of short pine blocks positioned on the fourth strake on both sides of the vessel fore and aft of the keelson. These lowest stringers served as continuations of the keelson, but allowed access to the top of the keel, presumably for the placement of a bilge pump. Partially preserved on the port side, an oak stringer was placed on the eighth strake and for the entire length of the keelson. A third oak stringer was placed on the sixteenth strake, above the height of the aft deck, and likely extended across the entire length of the vessel. This stringer is also partly preserved on the port side. The fourth type of stringer is also made of oak and is partially preserved on the port side. This so-called inwale runs on the inner upper edge of the seventeenth strake, which is the last strake of the vessel.



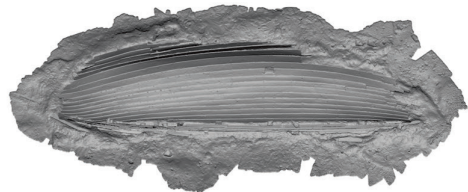
Stage 1: Before the excavation



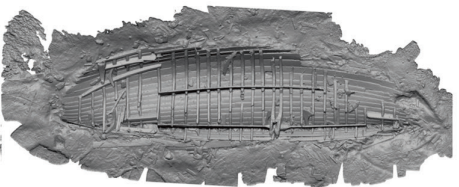
Stage 4: Bits and longitudinal timbers removed



Stage 2: During the excavation



Stage 5: Outer planking



Stage 3: Wreck fully exposed



Stage 6: Wreck removed, underlying timbers

Fig. 2: MatCap renders of the six stages of excavation of the shipwreck (Auer and Ditta 2018).

The deck construction of the vessel can be traced on the port side aft (fig. 4). Here, a preserved beam shelf and a number of oak knees provided the substructure for a half-deck. The beam shelf is made of pine and stretched from the end of the keelson up to the twenty-eighth frame station, clearly defining the extension of the deck. The fore end was fastened starting at the thirteenth strake, while the aft end was fastened at the eleventh strake.

A massive knee in lime wood (*Tilia sp.*) at the twenty-sixth frame station served as a bearing for the windlass. While this type of windlass bearing finds a comparison in the much smaller Elling Å ship dated AD 1163 (Bill 1997), a corresponding windlass for this type of arrangement was found in connection with the 'Big Ship of Bergen' dated AD 1187/88 (Christensen 1985, p. 180).

A 22 × 22 cm rectangular opening in the sixteenth strake at the height of the twenty-second frame station suggests the presence of a through beam. This is also confirmed by a recess in the underside of the third stringer, which would have been notched on the beam.

Through beams are known from the Bryggen excavations (Christensen 1985, p. 66) and at least two of these beams could be linked to the find context of the 'Big Ship of Bergen'. The largest beam found in Bergen had a square section of 20 × 20 cm. Also, the much smaller Kalmar 1 wreck from the first half of the 13<sup>th</sup> century had through beams (Åkerlund 1951, p. 32).

Another interesting feature is a smaller opening measuring 10 × 16 cm above the third stringer and just aft of the through

beam. The position above the deck and behind the end of the keelson suggests that this might be a scupper hole. A similar solution can be found in the Kalmar V wreck, a small merchant ship from the early 16<sup>th</sup> century. Here, a hollowed-out beam at the aft end of the keelson above the deck led the bilge water to a round scupper hole in the ship's side. The gutter beam was associated with a primitive bilge pump (Åkerlund 1951, p. 74).

Most probably the Wismar ship was also equipped with a similar pump arrangement. The position of the lowest two stringers in continuation of the keelson allows free access to the lowest point in the ship between the twenty-second and twenty-third frame stations.

The oak trees used for the construction of the vessel were felled in the period AD 1184-90 in the area of the Swedish west coast (Daly 2018). Based on the fact that neither the analysis of the construction timbers, nor the dendrochronological data produced any evidence for repairs, and that the outer planking was in a very good overall state, it is likely that the ship was only used for a short period of time. The artefacts found in the sediment above the wreck date to the early 13<sup>th</sup> century and suggest that the ship was wrecked or abandoned in the first part of the 13<sup>th</sup> century.

#### 4. THE 'BIG SHIP' OF WISMAR IN CONTEXT

Based on the archaeological evidence, the 'Big Ship' of Wismar was a sizeable cargo vessel of about 26 m length,



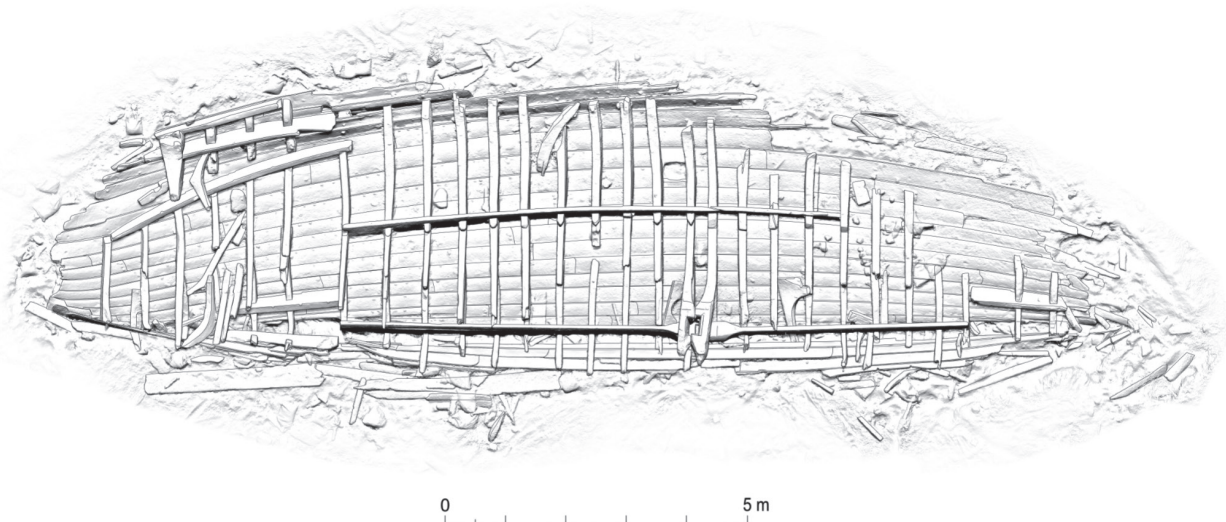


Fig. 3: Plan drawing of the Wismar wreck in the third stage of excavation (Ditta 2018).

which was built in the Nordic clinker tradition. Although a full reconstruction is pending, the beam can be estimated as 8 m. The vessel was remarkably symmetrical in its construction. It was probably double ended and had a single mast. An open hold stretched over the whole length of the keelson. A series of beams and through beams just forward of the mast provided stability. While the bow section is not preserved, a 3.5 m long half-deck could be reconstructed aft. The deck space was used to operate the large windlass, which stretched from one side of the vessel to the other, as well as the bilge pump, which was located aft of the keelson. The preserved structure indicates the existence of another, higher deck further aft, which might have been the position of the helmsman. Altogether, the 'Big Ship' of Wismar can be characterised as a large, well-built, seagoing merchant vessel, which was constructed in the Nordic clinker tradition. While many features recall the Scandinavian ship finds from earlier periods, the vessel shows some modern traits, such as the use of through beams and the existence of a bilge pump.

In general, the preserved material shows strong analogies between the Wismar ship and the Danish wreck Lynæs 1. The similarities range from general layout and frame spacing to the presence of rubbing strakes and W-shaped floor timbers. Another common element between the two ship finds is close correspondence in the origin of the oak timbers. Differences include the regular use of pine wood for long and straight elements in the Wismar ship and the lack of evidence for mast *bitis* or through beams in Lynæs 1. However, considering the age difference of 40 to 50 years between the two ship finds, these features could also be a later phenomenon. The 'Big Ship of Bergen' and the Karschau wreck (AD 1145) can also be added to this comparative group. In the Karschau wreck (Englert 2015, p. 191) both the mast *bitis* and the W-shaped floor timbers were present. The wreck, however, was not sufficiently preserved to provide evidence of rubbing strakes or through beams. The Bergen find, on the other hand, not only dates to the same period as the Wismar ship, but the preserved elements also indicate strong similarities in the construction. The 'Big Ship of Bergen' was, however, a larger version of the Wismar ship and all preserved timbers are made of pine.

## 5. CONCLUSION

To conclude, the Wismar wreck fits perfectly into the comparative study presented by A. Englert (2015) on large clinker-built ships of the Middle Ages in Danish waters. Englert describes the very similar Lynæs 1 ship as a "sophisticated tool of a long-distance trade operated by professional merchants" (Englert 2015, p. 189) and interprets the ships in his study as indicators of professional trade. The 'Big Ship' of Wismar can also be seen in this context. Construction and use of the vessel fall into the reign of the Danish kings Knut VI and Valdemar II, during which the area around Wismar formed part of the Danish kingdom.

The Wismar wreck thus adds to our knowledge of Scandinavian shipbuilding in the late 12<sup>th</sup> century. While the documentation of the recovered material and the primary analysis of the ship construction have been completed, the timbers of the Wismar find are currently awaiting conservation in Schwerin. Further planned steps in the investigation include a full comparative analysis of the wreck find and a digital reconstruction of the ship.

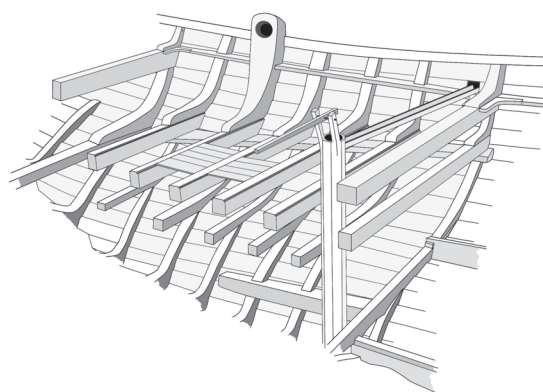


Fig. 4: Reconstruction of the aft deck between the through beam at the twenty-second frame station and the beam at the twenty-eighth frame station. The massive lime wood knee served as a bearing for the windlass (Ditta 2019).

## REFERENCES

AUER J., DITTA M.

2019 *Bergung und Dokumentation des Bodendenkmals Wismar, Ostsee II, Fpl. 32 im Rahmen des Projektes „Seehafen Wismar, Fpl. 32“* (3544-5504), Ref. 3544-5504.01, Landesamt für Kultur und Denkmalpflege, Schwerin, report.

BILL J.

1997 *Small Scale Seafaring*, PhD thesis, University of Copenhagen, unpublished.

CHRISTENSEN A.E.

1985 *Boat finds from Bryggen*, in A. E. Herteig (ed.), *The Bryggen Papers, Main Series*, Oslo, Universitetsforlaget, p. 47-278.

DALY A.

2018 *Dendrochronological analysis of timbers from a shipwreck found at Wismar Wendorf Fpl32*, Copenhagen, dendro.dk report 2018:32.

ENGLERT A.

2015 *Large cargo ships in Danish waters 1000-1250: evidence of specialised merchant seafaring prior to the Hanseatic Period*, Roskilde, The Viking Ship Museum, Ships & Boats of the North 7.

RADOHS L.

2016 *Vom portus Wissemers zur Hansestadt Wismar – Untersuchungen zur Stadtentstehung Wismars im 13. Jahrhundert auf Grundlage der archäologischen Quellen*, Masterarbeit, Otto-Friedrich Universität Bamberg.

ÅKERLUND H.

1951 *Fartygsfynden i den forna hamnen i Kalmar: Kulturhistoriska undersökningar vid Kalmar slott utförda under ledning av Martin Olsson*, Uppsala, Almqvist & Wiksells boktr.



# A RECENTLY DISCOVERED WRECK WITH DOUBLE PLANKING IN THE BAY OF PUCK. MEASUREMENTS, RECORDING AND POSITIONING OF THE SITE WITH THE USE OF A 3D PHOTOGRAMMETRY MODEL AND A MULTIBEAM ECHOSOUNDER

Tomasz BEDNARZ

---

## Abstract

The F32.8 wreck was discovered in 2014 at a depth of 4.5 m in the waters of the Bay of Puck, Poland. The wreck consists of a fragment of the port side of a vessel with a characteristic double, clinker and carvel, planking. The site is 9.5 m long and 2.8 m wide. The wreck is composed of pine strakes for the outside carvel planking; levelling pine strakes, triangular in a cross section; oak strakes for the inside clinker planking; oak frames; pine treenails of three different diameters. The vessel was built after 1789 with wood from the region of Norway.

## Keywords

Double planking, multibeam echosounder, photogrammetry, underwater archaeology, wreck

## Résumé

L'épave F32.8 a été découverte en 2014 à une profondeur de 4,5 m dans les eaux de la baie de Puck, en Pologne. Elle est constituée d'un fragment du flanc bâbord d'un navire présentant un double bordage, l'un à clin et l'autre à franc-bord. Le site mesure 9,5 m de long sur 2,8 m de large.

Le bordé extérieur, à franc-bord, est en pin. Il présente des bordés de comblement de section triangulaire, également en pin. Le bordé intérieur à clin est construit en chêne tout comme la membrure. Les gournables, de trois diamètres différents, ont été confectionnées en pin. Le navire a été construit après 1789 avec du bois provenant de Norvège.

## Mots clés

Double bordé, échosondeur multifaisceaux, photogrammétrie, archéologie sous-marine, épave

---

The F32.8 wreck was discovered in 2014 by staff of the Maritime Office in Gdynia. It lies at a depth of 4.5 m in the Bay of Puck, approximately 850 m to the north of the Rewa headland (fig. 1). Maritime Museum archaeologists conducted the first identification of the site in 2015, and detailed cataloguing works were performed in 2017.

The archaeological research work on the wreck was conducted as part of the project entitled "Virtual Open-Air Museum of Wrecks in the Gulf of Gdańsk. Documentation and cataloguing of underwater archaeological heritage".

No artefacts were recovered from the F32.8 wreck and its minimal immersion in the sea bottom and fragmentary preservation of its structure may indicate that it has shifted from its original position. The wreck still lies under water and its recording was conducted with the use of photogrammetry to obtain a 3D model of the remains (fig. 2), and a multibeam echosounder (Bednarz 2017).

Measurements made with the multibeam echosounder were also applied for accurate positioning of the F32.8 underwater site and its 3D model. After archaeological work on the wreck, staff of the Maritime Measurement Department of the Maritime

Office in Gdynia made measurements and site imaging with the use of a Sonic 2024 multibeam echosounder with a R330 GNSS receiver and HydrINS III flow meter. This equipment was installed on the hydrographical vessel *Hydrograf 10* enabling measurements of geographical position to be made at sea with an accuracy range of 2 cm. Accurate positioning of nine characteristic elements of the wreck with the use of an echosounder, identified and indicated on a 3D model, made it possible to determine the real geographical position and orientation to the north of the F32.8 site's 3D model (fig. 3). This data can be used in the GIS software and, due to the information contained in the software, it is possible to conduct precise measurements as well as create cross sections and projections of the site.

## 1. DESCRIPTION

The wreck consists of a fragment of the vessel's port side from the sternpost extremity with a characteristic double clinker





Fig. 1: Location of the wreck F32.8 (drawing K. Treder).

and flush-laid planking. The site measures 9.5 m in length and 2.8 m in width (fig. 3).

The identified structure of the wreck is comprised of (fig. 4):

- twelve oak stakes of the inner clinker planking, 3-3.5 cm thick and 18-22 cm wide;

- levelling pine planks, triangular in cross section, used to fill the space between the clinker and the flush-laid planking, max. 3 cm thick and up to 18 cm wide;

- eight pine stakes of the outer flush-laid planking, 3 cm thick and 21-26 cm wide;

- oak frames, 10 cm thick and 10-14 cm wide, located at 24-72 cm intervals. There are a total of 13 frames on the wreck and two frames were identified outside the structure. A few frames have futtocks fastened to them;

- pine trenails of three different diameters are used for joining clinker planks (diam. 1.5 cm), for joining oak and pine planking (2 cm), and for fastening the planking to frames (3 cm);

- a few rectangular oak and pine inserts (covers) were also identified. These are wood fills placed under frames, additional reinforcement and probably also repair of the hull;

- traces of iron nails were also detected in several places.

A total of 13 wood samples were obtained from structural elements of the wreck for dendrochronological analysis. Three samples were extracted from pine planking and the remaining ten from oak structural elements of the vessel. None of the samples had a sapwood layer. Thanks to the assistance of Dr Aoife Daly of the University of Copenhagen, absolute dating was achieved for seven oak samples extracted from frames and clinker planks based on the chronology of Norwegian ships. It was determined that the vessel was built after 1789 from wood which most probably came from the territory of Norway. This fact implies that it is unlikely that the vessel was built in the southern Baltic Sea since wood was not imported from Norwegian territory to the Bay of Gdansk.

Additionally, carbon-14 analysis was conducted on a wood sample collected from the wreck. As a result, it was determined that the most probable period of the vessel's construction ranges from the second half of the 17<sup>th</sup> to the end of 18<sup>th</sup> century (Krapiec 2017).

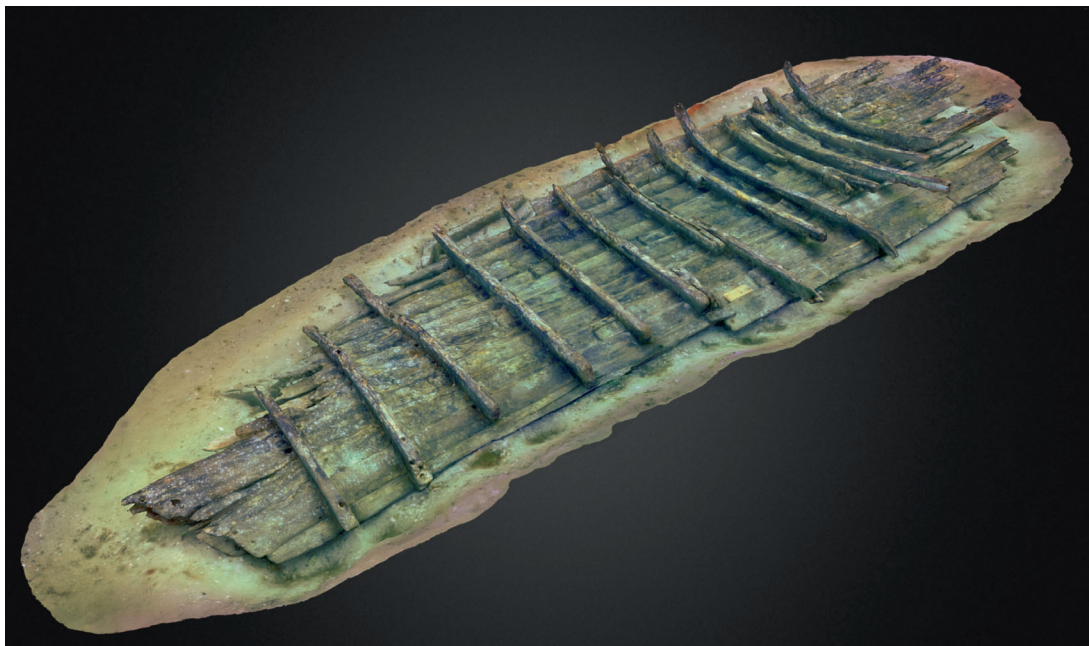
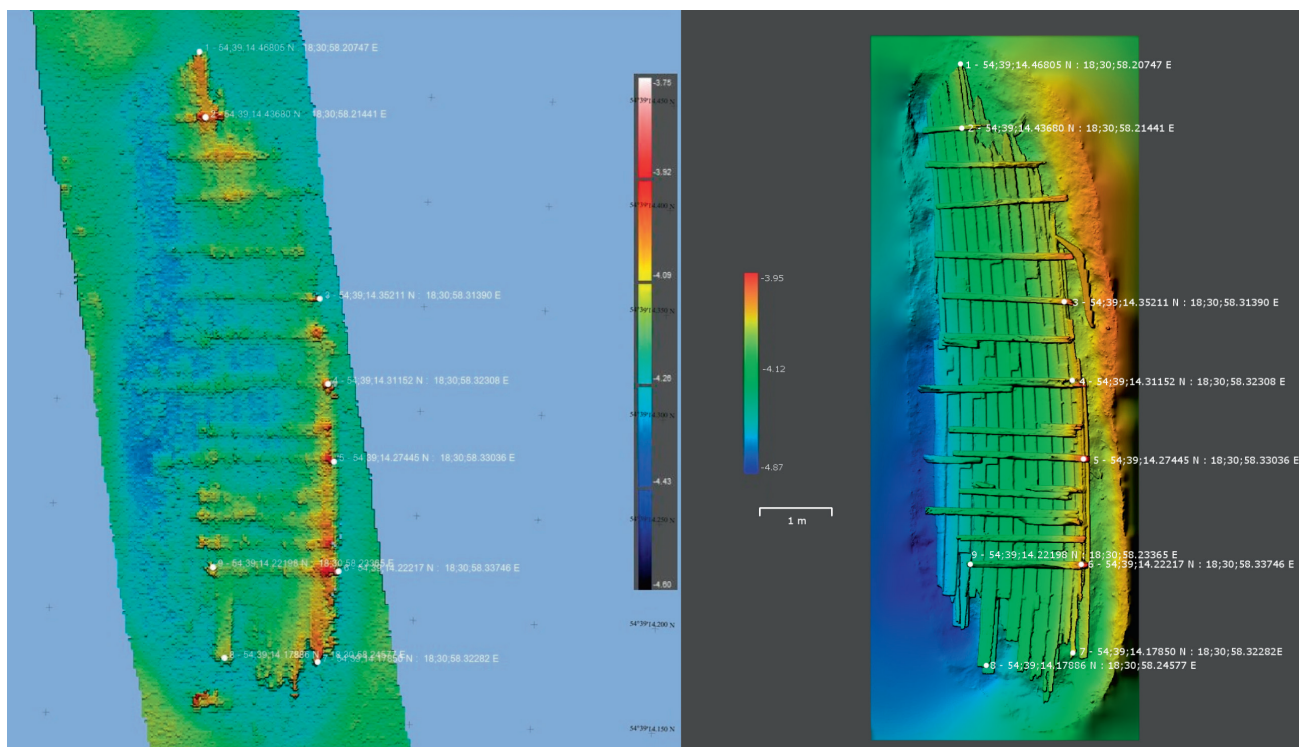


Fig. 2: 3D model of the wreck F32.8 (K. Treder, T. Bednarz).



**Fig. 3:** Geographic positioning of wreck F32.8 indicated on multibeam echosounder image (left) and digital elevation model (right) (GUM, K. Treder, T. Bednarz).

## 2. COMPARISONS

Thus far, three other double-planked wrecks have been discovered and researched on the Polish shore of the Baltic Sea, including two from the Bay of Gdańsk.

Two wrecks of wooden sailing vessels with characteristic double planking, named W-34 and W-36 respectively, were discovered in the Bay of Gdańsk area, near Redłowo and Orłowo areas in Gdynia.

The W-36 wreck constitutes the remains of a small sailing vessel discovered in 2001, approximately 250 m from the shore in Gdynia-Orłowo area at a depth of 2.7 m. Structural fragments of 8.8 m in length (stern section of the vessel) and characteristic double planking of the hull have been preserved. The vessel's inner planking constructed from oak wood based on a traditional clinker technique is fastened to the keel, which has a T-shaped cross section. Levelling pine planks and outer flush-laid pine planking were fastened to the inner planking. The vessel was built after 1596 from wood coming from the area of the Vistula Lagoon. Bricks, which constituted the ship's cargo, as well as pieces of ceramics and clay pipes, were lying on the wreck (Ossowski 2006).

In 1999, the museum's research team conducted archaeological research on the W-34 wreck. It lay at a depth of approximately 1.5 m, 150 m from the shore near the Gdynia-Redłowo area, measured 13 × 4 m, and was covered with rocks. A small number of artefacts, fragments of clay pipes and ceramics, as well as a few buttons were recovered from the wreck. In 2011, elements of the W-34 wreck were washed ashore near Redłowo. Thus it was possible to better analyse the structure of the wreck, which was identified as a double-planked vessel built with the use of different techniques. The wood used for construction of

the ship came from the area of Gdańsk Pomerania. The youngest preserved tree rings in the analysed samples date back to the 1680s and 1690s, thus indicating that the vessel was built most likely in the first decade of the 18<sup>th</sup> century. The outer flush-laid planking was built later than the internal clinker planks (Bednarz 2015; Grabowski 2018).

Another example of a double-planked vessel discovered on the Polish Baltic shore is the F10.Y.1 wreck washed ashore in 2002, approximately 2 km to the east of Dębki. The wreck constitutes the remains of the bow part of a hull bottom, and measures 9.2 m in length and 3.5 m in beam. Dendrochronological analysis indicated that the vessel was most probably built in the 1660s from wood grown in the area of Hamburg and that both layers of its planking were built at the same time (Ossowski 2006).

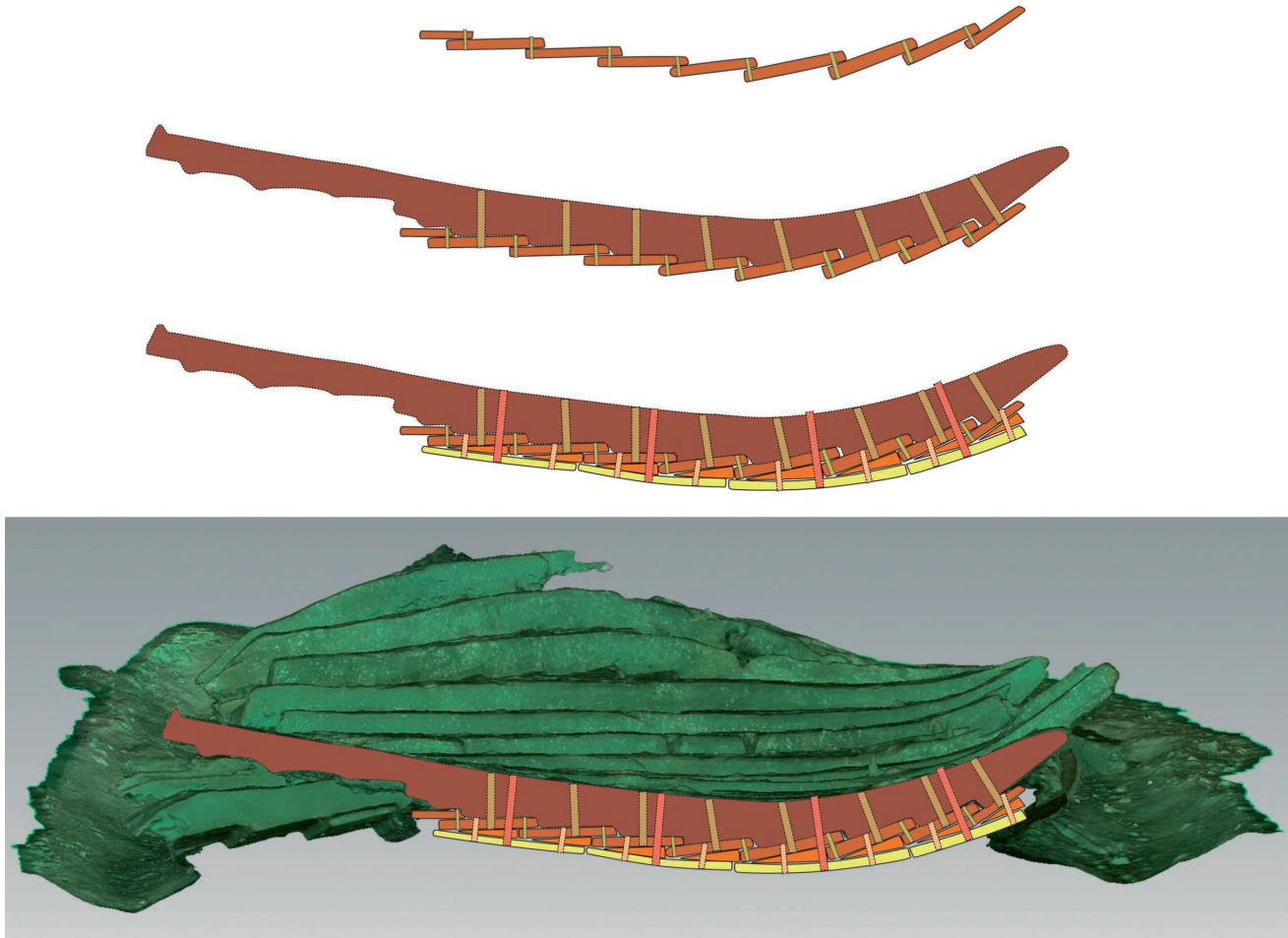
Other double-planked wrecks have been discovered in the Baltic Sea outside Polish territorial waters.

The Massilin wreck from Estonia discovered in 1987 constitutes the remains of a single-masted ship dating to the middle of the 16<sup>th</sup> century that was used in local navigation. Its double planking was built at the same time (Mass 1994; Ossowski 2006).

In 1996 the remains of double-planked (clinker/carvel) were discovered in Gellen, near Stralsund, and named *Hiddensee 12*. The vessel was built after 1804 with timber from the Finland area (Daly, Belasus 2016).

The FPL 77 wreck was discovered in 2009 on the beach of the Fischland-Darss-Zingst Peninsula. The vessel was built around 1590 from wood of the Oresund area for the clinker planking and of the Lübeck area for the outer carvel planking (Auer 2010).

The Finnish schooner *Pettu* built in 1865 sank in 1893 off the coast of Denmark. Here, only the bottom part of the hull was clinker built, and a second planking was applied at a later time (Auer, Ditta 2016).



**Fig. 4:** Theoretical reconstruction of hull construction stages of the vessel F32.8: clinker planking (top); carvel planking applied to the construction (middle); hull of the vessel inserted into the 3D model cross section (bottom) (drawing K. Treder, T. Bednarz).

Finally, in 1981 the Nors A wreck was discovered to the north of Klitmøller, Denmark. It is part of a ship with a double clinker/flush-laid planking. The remains were identified as those of a *sandskude* (sand punt), used for the transportation of grain and wood between Denmark and Norway. Vessels of this type were used in that area between the 17<sup>th</sup> and 19<sup>th</sup> centuries (Gothche 1985; Ossowski 2006).

### 3. DISCUSSION

As can be seen, double-planked vessels are quite rare but they differ quite markedly from one another. According to the researchers, some of them were originally built with double planking while the rest represent vessels that, after being used as clinker-planked ships, had outer carvel planking added in order to reinforce and seal the structure. The chronology of the above sites is also interesting. The oldest ones date back to the middle of the 16<sup>th</sup> century while the youngest date to the 19<sup>th</sup> century. Most of them constitute the remains of relatively small vessels, between 10 and 20 m in length, used in local navigation. The exception is the 14<sup>th</sup> century wreck from Gellen measuring approximately 28 m. As previously mentioned, there were two construction phases identified in the case of this

vessel. Another case is the 19<sup>th</sup> century *Pettu* wreck, which is a remnant of a “rural” *shooner* with a double clinker and carvel planking.

In conclusion, it should be noted that the presence in the Bay of Puck of a vessel built in Norway indicates that it was suitable for longer Baltic navigation. Presumably, the length of the ship’s hull was about 15-18 m. This unit could also have been used for some time in local transport in the Gulf of Gdańsk.

Its double planking reinforced the structure and enabled safe operation on sandy and rocky shores as well as in provisional harbours at the turn of the 18<sup>th</sup> and 19<sup>th</sup> centuries in the Gulf of Gdańsk and other waters.

At the current stage of research, as the pine carvel planking is not dated, it is difficult to determine whether the pine carvel planking was built at the same time as the oak clinker planking or later during repair or rebuilding.

The irregular placement of treenails fastening the outer planking and, in a few places, large treenails piercing the planking outside the frames indicate that the cover was added later in relation to the internal. However, this is not definitively confirmed. The possibility that the outer carvel cover was added in the area of the Gulf of Gdańsk where the vessel was still in use should also not be excluded.



Fragmentary preservation does not allow for full and precise interpretation of the site, however, it contributes to advancing knowledge on characteristic double-planked vessels in the Baltic Sea and the eastern part of the North Sea. The wreck is still located underwater and its excavation in the near future seems necessary, along with precise analysis of its structural elements in the course of onshore recording work.

In the 19<sup>th</sup> century, clinker-built vessels constructed in Gdańsk Pomerania were commonly used in the area of the Bay of Gdańsk.

The F53.31 Rock wreck discovered in 2013 is an example of this historic fact. Built after 1831, the ship sank with a cargo of granite stone near the Gdynia-Orłowo area. It is most probable that she was one of the “Rewa szkut” (punt) type of small vessels between 12 and 18 m in length with various structures used mainly for the transport of construction materials and other local products between the ports of the Bay of Gdańsk (Bednarz, Różycki 2017). The vessel whose wreck is designated F32.8 could have been used in the same way in the Bay of Gdańsk.

## REFERENCES

- AUER J.  
2010 *Survey Report Prerow FPL 17*, Esbjerg, Maritime Archaeology Programme, University of Southern Denmark.
- AUER J., DITTA M.  
2016 The Wreck of the Pettu as an Example for Nineteenth Century Rural Shipbuilding in South-Western Finland, *Journal of Maritime Archaeology* 11.2, p. 231–249.
- BEDNARZ T.  
2015 *De Jonge Seerp. Badania historyczno – archeologiczne niderlandzkiego statku z końca XVIII wieku*, Gdańsk, PhD thesis, University of Gdansk.  
2017 *Sprawozdanie z badań archeologicznych przeprowadzonych w roku 2017 na wrakach F53.18, F53.26, F32.6, F32.8, F53.30 z Zatoki Gdańskiej*, Gdańsk, Departament Kultury UMWP.
- BEDNARZ T., RÓŻYCKI J.  
2017 Research of the wrecks in the Gulf of Gdańsk using photogrammetric 3D documentation, in J. Litwin (ed.), *Baltic and Beyond: change and continuity in shipbuilding, Proceedings of the Fourteenth Symposium on Boat and Ship Archaeology (ISBSA 14), Gdańsk 2015*, Gdańsk, National Maritime Museum, p. 27–32.
- DALY A., BELASUS M.  
2016 The Dating of Poel 11 and Hiddensee 12, Mecklenburg-West Pomerania, Germany, *IJNA* 45.1, p. 170-174.
- GOTHCHE M.  
1985 *Sandskuder vessel for trade between Norway and Denmark in the 18<sup>th</sup> and 19<sup>th</sup> centuries*, in C. O. Cederlund (ed.), *Postmedieval Boat and Ship Archaeology, Proceedings of the Third International Symposium on Boat and Ship Archaeology, Stockholm 1982*, Oxford, BAR publishing, BAR International Series 256, p. 299-314.
- GRABOWSKI M.  
2018 Konstrukcja wraka W-34. Przykład lokalnego wytworu skutniczego dostosowanego do warunków żeglugi przybrzeżnej w rejonie Zatoki Gdańskiej, *Pomorania Antiqua* XXVII, p. 217 -234.
- KRĄPIEC M.  
2017 *Wyniki analizy dendrologicznej i dendrochronologicznej próbek drewna z wraków F32.6, F32.8, F53.18 i F53.26*, Kraków.
- MASS V.  
1994 A unique 16<sup>th</sup>-century Estonian ship find, in C. Westerdahl (ed.), *Crossroads in Ancient Shipbuilding, Proceedings of the Sixth Symposium on Boat and Ship Archaeology (ISBSA 6), Roskilde 1991*, Oxford, Oxbow, Oxbow Monograph 40, p. 189-194.
- OSSOWSKI W.  
2006 Two double-planked wrecks from Poland, in L. Blue, F. Hocker, A. Englert (eds), *Connected by the Sea, Proceedings of Tenth International Symposium on Boat and Ship Archaeology (ISBSA 10), Roskilde 2003*, Oxford, Oxbow Books, p. 259-265.





# A LATE 17<sup>TH</sup>-CENTURY ‘DOUBLE DUTCH’ CONSTRUCTION IN THE NORTH FRISIAN WADDEN SEA: THE CASE OF THE HÖRNUM ODDE WRECK ON THE ISLAND OF SYLT, GERMANY

Daniel ZWICK

---

## Abstract

In October 2016 a previously unknown shipwreck emerged at the southern spit of the island of Sylt as a consequence of an ongoing coastal erosion process. Aside from its double-layered carvel planking, several other features reminiscent of 17<sup>th</sup>-century Dutch shell-first shipbuilding were observed. With a *terminus post quem* of 1690, this is the latest ‘Double Dutch’ construction hitherto known, casting doubt on the long-held belief that this peculiar method of construction was a fleeting phenomenon of the early 17<sup>th</sup> century. Due to tidal currents and erosion, the sea swiftly reclaimed the wreck shortly after the investigation.

## Keywords

Carvel, Double Dutch, Dutch flush, North Sea, 17<sup>th</sup> century

## Résumé

En octobre 2016, une épave jusque-là inconnue est apparue à la pointe sud de l’île de Sylt à la suite d’un processus d’érosion côtière en cours. Mis à part son double bordé à clin, plusieurs autres caractéristiques rappelant la construction navale néerlandaise du xvii<sup>e</sup> siècle ont été observées. Avec un *terminus post quem* de 1690, il s’agit de la dernière construction « Double Dutch » connue à ce jour, remettant en cause la croyance de longue date que cette méthode de construction particulière aurait été un phénomène éphémère du début du xvii<sup>e</sup> siècle. En raison des courants de marée et de l’érosion, la mer a rapidement détruit l’épave peu après son enregistrement.

## Mots-clés

Carvel, Double Dutch, bordé de doublage, mer du Nord, xvii<sup>e</sup> siècle

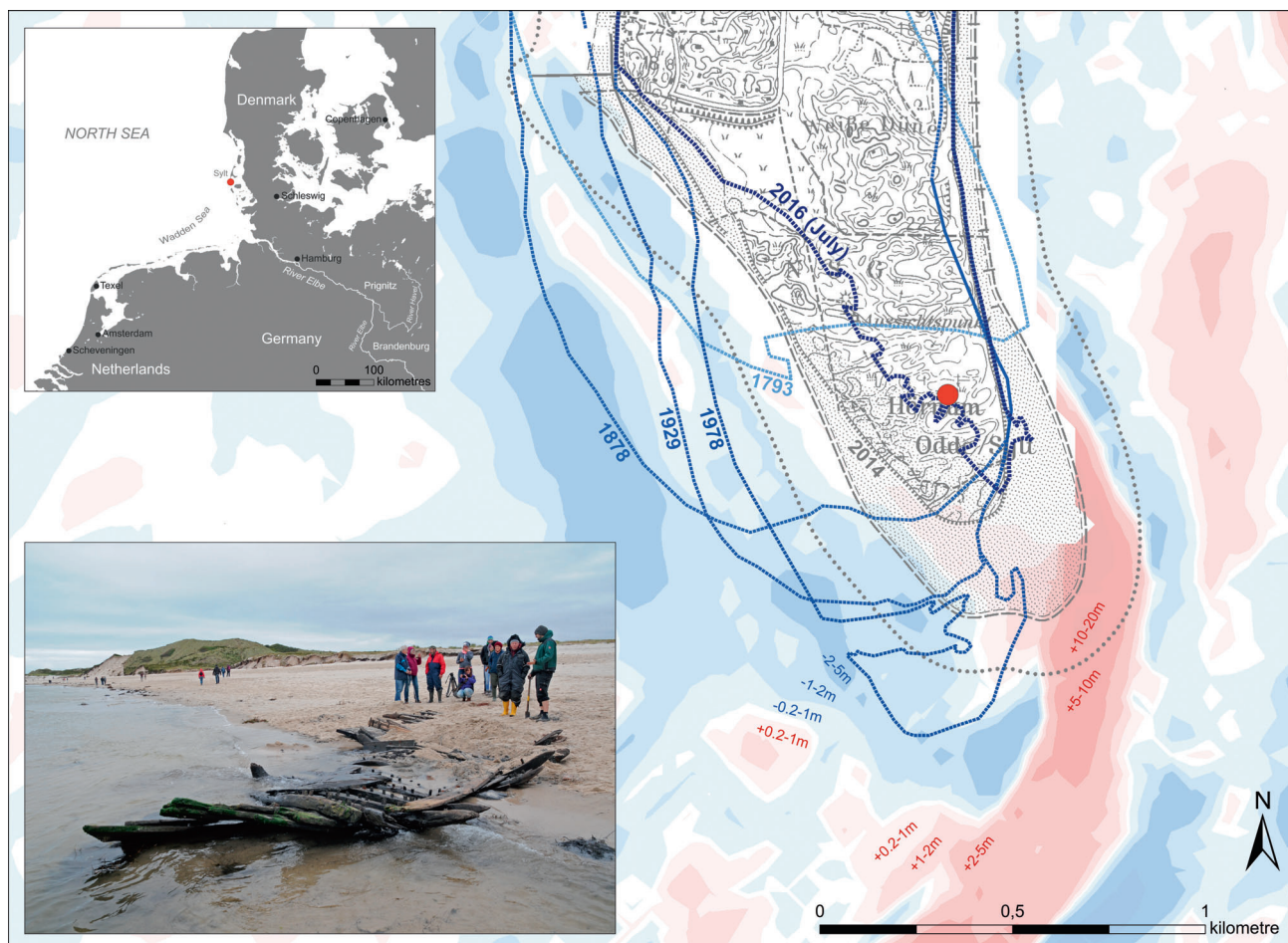
---

On 3 October 2016, a local resident reported a previously unknown shipwreck at Hörnum Odde on Sylt’s southern tip to the State Archaeology Department of Schleswig-Holstein (ALSH). The substantial hull remains came to light as a result of strong tidal currents and an underlying erosion process. The site was located at the outer extent of the intertidal zone and only accessible at low tide in offshore winds. Thus, the location of the site imposed a special challenge as its location in the surf zone permitted neither an underwater survey, nor a proper terrestrial excavation. Therefore, the recording method had to be extremely time-efficient in order to gather as much data as possible within a very short time frame.

## 1. METHODOLOGY

In view of the challenges described above, the first investigation was scheduled for 6 October when low tide coincided with offshore winds. This provided optimal working conditions, as the wreck remains were clear of the water for about an hour. The wreck’s outline was measured with a DGPS device on the basis of SAPOS, a German nationwide satellite-based reference networked service, which decreases the margin of error in real time surveying, reducing deviations to a maximum of 10-20 cm for the

device used by the ALSH. Over 200 photos were taken, to be used later for Structure from Motion (SfM) photogrammetry. Several test pits were dug to find the keel, but to no avail. A number of samples were taken from both the planks and the frames for later dendrochronological analysis, and a piece of a plank was salvaged for detailed *ex situ* documentation. The stormy season made it difficult to find an adequate date for a follow-up investigation in which all prerequisites were met, i.e. low tide around midday, offshore winds and availability of field staff. In the meantime the ALSH received reports and photos of the wreck site from its established local contacts. Based on this information it became clear that the wreck site was subject to considerable mechanical destruction whenever the site was turned into a surf zone with each incoming tide. Thus, it was decided not to wait any longer for optimum conditions and to visit the site again on 9 December, when a different section of the wreck could be observed, while the previously investigated section was no longer visible, having been washed away. Due to unfavourable onshore winds, the wreck site remained inundated at low tide and so photographic documentation suited for an SfM model was out of question. The wreck was only accessible by wading into the water, which permitted only SAPOS surveying and manual recording. Only two pieces of timber could be sampled at this time. Although the circumstances of the December investigation were very unfavourable, the effort



**Fig. 1:** The find location of the Hörnum Odde wreck (red dot) in the regional context (top left) and georeferenced in the digital topographic map of 2014 (background). As the historical coastline of 1793 (mean sea water level) and the dune edges of 1878, 1929, 1978, 2014 and 2016 indicate, Sylt's Odde has been subject to erosion along its western shore and sand aggradation at its southern spit for centuries. A shift towards a more southeasterly deposition of sediments in more recent times is reflected by geomorphological data, as indicated by the different shades of blue (= erosion) and red (= sedimentation) for the period of 1982-2012 with the total values of depth differences. This underlying process explains the rapid land loss at the wreck site itself. While the dune edge has advanced closely above the wreck site by July 2016, it has moved considerably further inland at the time of the discovery of the wreck in early October of the same year, when the photo (bottom left) was taken (graphics D. Zwick; photograph ALSH / DTK25-map LKN-SH; geomorphological data GDI-BSH).

was worthwhile, since by the New Year the entire wreck site was reported missing. It was reclaimed by the sea as a result of coastal erosion and winter storms.

The post-excavation involved georeferencing both wreck sections with ArcGIS, drawing a wreck plan on the basis of the SfM-generated orthophoto, observations from photo details as well as the *in situ* manual recording of the inundated wreck section. The desk-based assessment of the geomorphological changes, the wreck's construction details, the drawing of the retrieved plank fragment, as well as research carried out to contextualise the wreck took up the greatest portion of the time. An archival study of recorded historical strandings in search of the vessel's identity has yielded no match so far.

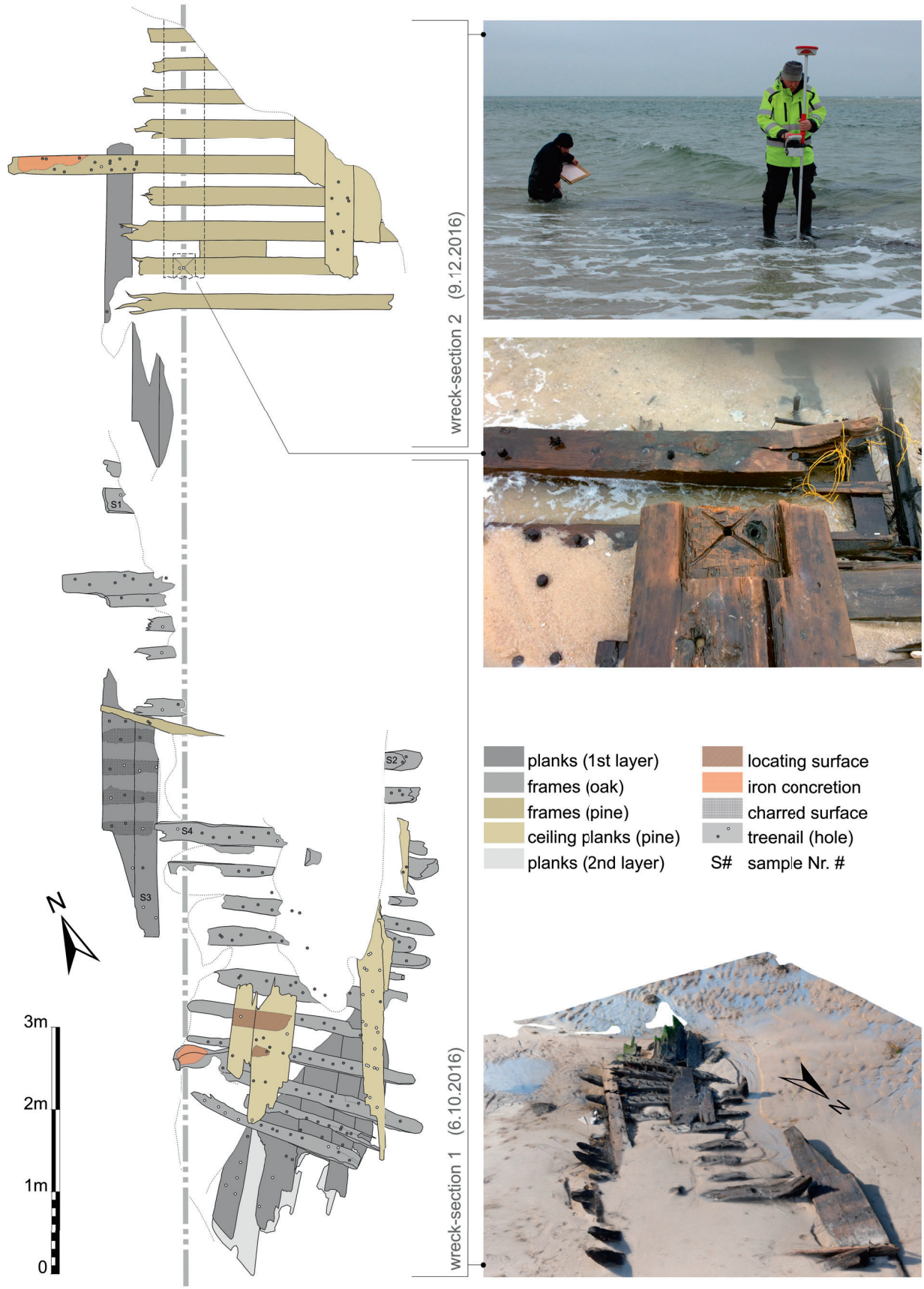
## 2. THE FIND LOCATION

Upon georeferencing the wreck site it came as something of a surprise that the site was evidently situated in the middle of the Hörnum Odde dune (fig. 1). As it turned out, the fairly recent update of the digital topographic map from 2014 was not

recent enough to keep up with the dramatic changes to Sylt's coastline. A comparison with a more recent aerial orthophoto taken in July 2016 confirmed that the location of the wreck in relation to the shoreline was indeed accurate and not the result of a measuring error. By July the dune edge had advanced close above the wreck site and by October it had moved already some 50 m further inland beyond the wreck site.

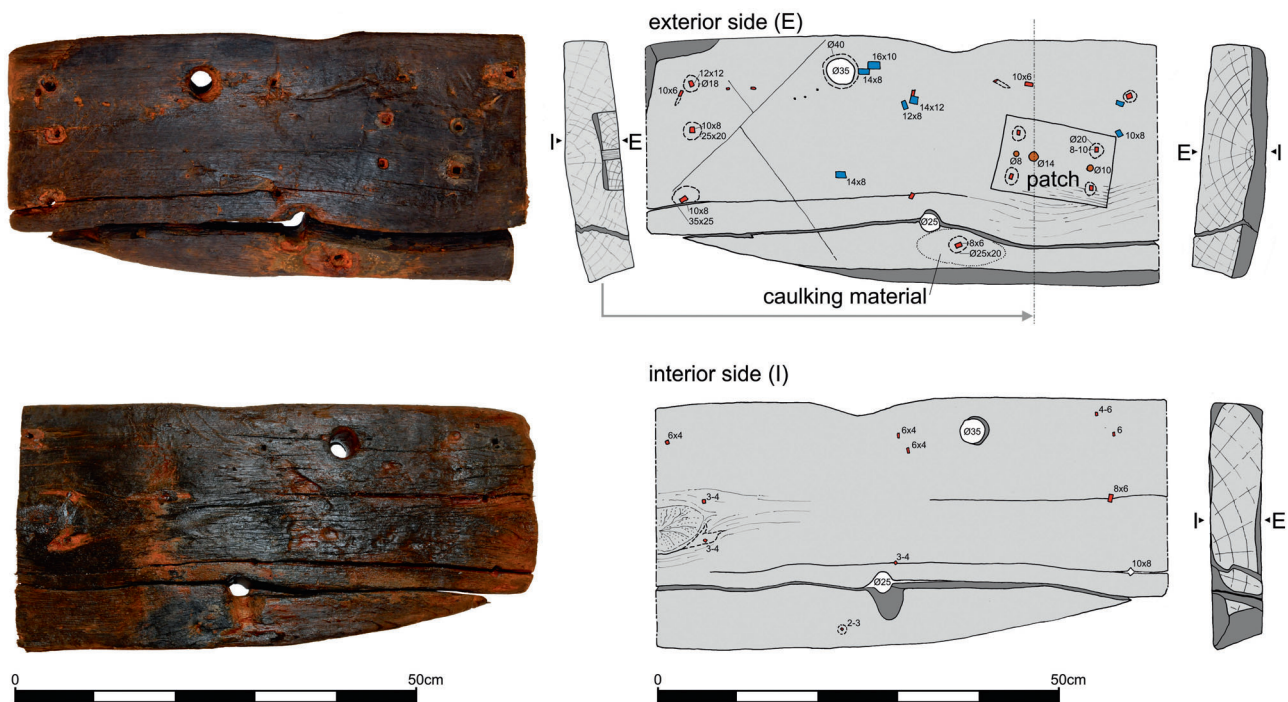
The great coastal erosion process on Sylt's western shoreline is not a new phenomenon. It is an ongoing process that has taken place for centuries if compared to historical coastlines (Ahrendt, Köster 1998, p. 39). The gradual erosion process along the western coast goes hand in hand with a sedimentation process to the south, forming a sandy spit – the *Odde*. When compared to a long-term 30-year geomorphological model based on depth measurements between the years 1982 and 2012, the erosion of the western coastline has remained a constant feature with a shift of the sedimentation process to the east. Between the years 2013 and 2016 some 30 to 60 m of coastline was lost annually due to this process (LKN-SH), evidently reaching full peak in 2016 as the maximum annual value of 60 m corresponds to the erosion of 10 m as evidenced by the gap between the two wreck sections visited in a two month interval (fig. 2).





**Fig. 2:** The wreck site as recorded on 6 October and 9 December 2016. The dotted line indicates the position of the missing keel. An SfM model (bottom right) was generated for wreck section 1, while wreck section 2 (inundated at the time of the in situ documentation) is based on a hand sketch, in which the treenail arrangement was recorded for two exemplary segments. The locating surface may indicate the position of a bulkhead (graphics D. Zwick; photograph ALSH; SfM-model J. Enzmann, F. Wilkes).





**Fig. 3:** Drawing of a plank fragment (sample 3) retrieved from the garboard strake, with the tapering edge of the scarf visible. This piece features a number of diagnostic characteristics like the *spijkerpennen* (blue), treenail holes, rectangular iron nail shafts (red) and nail head impressions (dotted line around the nail shafts), and dowels (brown) in the patch, which was fastened with four iron nails. The plank sample was sawn through at the patch: its cross section revealed that the inner recess had a conic plane, probably due to the difficulty in applying the tool horizontally in this restricted space. As indicated by the knot on the interior, the insertion of the patch over the same on the exterior can be ascribed to an effort to make the vessel watertight. Moreover, residues of caulking material were present on the exterior surface of the plank, fused in by an iron concretion. All measurements and diameters are provided in mm (graphic D. Zwijk; photograph ALSH).

The geomorphological process explains the location of the wreck in the middle of the dune. Based on this data alone, one could infer that the shipwreck could not have occurred much later than 1793, providing a rough *terminus ante quem*.

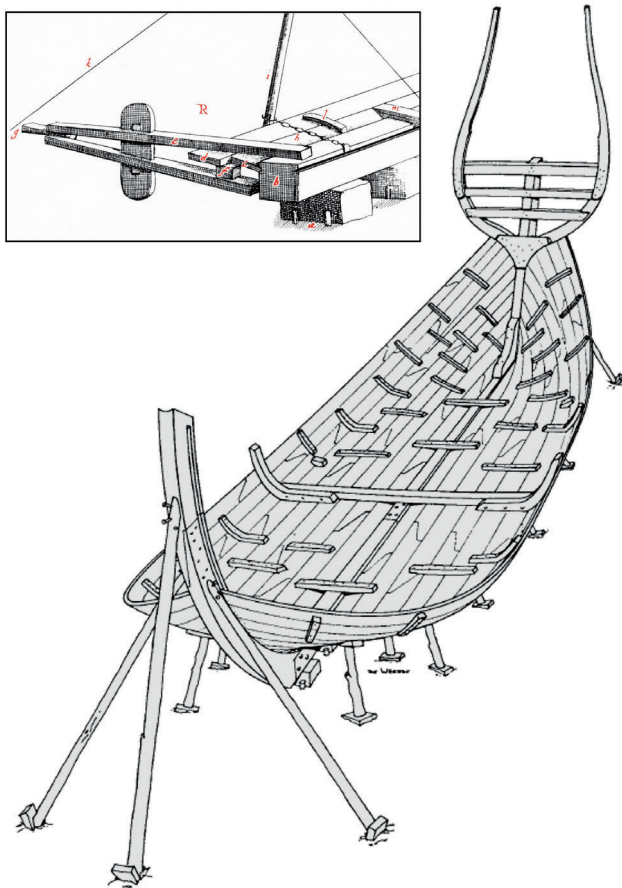
### 3. DESCRIPTION AND CONSTRUCTION ANALYSIS OF THE WRECK

The unearthed portion of the wreck covered an area of *circa* 16 by 5 m (fig. 2). The wreck was situated in a north-northeasterly direction, with loose hood ends observable in the southern part (section 1) indicating one of the ship's extremities, tentatively addressed as the stern section. The northern part (section 2) corresponds to the midship section and continued beneath the sandy beach. The full length of the wreck site remains unknown.

#### 3.1. GENERAL OBSERVATIONS

The floor timbers are not interconnected with futtocks and are only fastened to the planks with wedged treenails of 35 mm as the most common diameter. In the chine area, floor timbers and futtocks form a parallel, alternating pattern. Some of the observed futtocks display an articulated chamfered edge shortly above the turn of the bilge, so these could be

more appropriately described as bilge futtocks, known by Dutch shipbuilders as *zitters* (Hoving 2012, p. 64). The scantlings of the frames are quite modest, with moulded dimensions of around 15 cm and sided dimensions of around 30 cm in the amidships section (section 2), gradually decreasing to 20 cm +/- 5 cm for the V-frames in the stern section (section 1). The modest scantlings are contrasted by the massive dimensions of the oak planks, with widths between 24-35 cm and thicknesses of 6-7 cm. Similarly, the ceiling planks of pine have great widths of 35-38 cm and a regular thickness of 3 cm. The planks of a strake were connected with flat scarfs with stopwaters. The retrieved plank fragment (sample 3, figs. 2-3) contained a multitude of further diagnostic features. One was the observation of rectangular wooden plugs of pine, which were referred to as *spijkerpennen* by the contemporary Cornelis van Yk (1697, p. 41). *Spijkerpennen* are diagnostic for the so-called 'Dutch flush' construction method, which occurs in connection with the abovementioned irregular, modestly dimensioned, non-interconnected framing system (Maarleverld 1992, 2013). This method is a shell-first construction method with flush-laid planks: a 'carvel' in appearance only. The flush-laid planking is temporarily held together by cleats nailed onto the planks from both sides of the hull (fig. 4), only to be removed later once the framing has been inserted, with the nail holes eventually plugged with *spijkerpennen*. Similar to clinker constructions, other devices were used to control the run of the strakes, such as large planking tongs, referred to as *boeitang* by Nicolaes Witsen (1671, p. 169). The fact that there



**Fig. 4:** Demonstration of the Dutch flush method, where the flush-laid shell was assembled prior to the erection of the skeleton. Temporary cleats held the shell together, which were removed once the frames were inserted and their nail holes plugged with spijkerpennen. As Nicolaes Witsen demonstrated (top left), not only cleats (l) were used but also boeitangs (e) and other aids (drawing after Hoving 2012, fig. 2.55 courtesy of G.A. de Weerd; top left, after Witsen 1691, p. 168, modified D. Zwick).

is no discrete term for this tong in a seafaring nation like England, as reflected by the circumscription “a sort of pincers to join the planks” in a Dutch-English dictionary (Sewel, Buys 1766, p. 127), highlights the uniqueness of this device in Dutch shipbuilding. Further characteristics also point to a Dutch construction, like what appears to be the charred inner surface of a plank (fig. 2, S3) beneath the frames. Despite the massive thickness of the oak planks, they had to be bent, and the process of making planks more malleable by charring the surface was also described by Nicolaes Witsen (Witsen 1671, p. 207; Hoving 2012, p. 23). Charring can also be seen as a typical feature of Dutch 17<sup>th</sup>-century shipbuilding: it was later replaced by steaming.

The choice of wood species is of particular interest. While the framing timber and planks of the stern section are almost entirely of oak, with the exception of the pine ceiling, the frames in the amidships section are all of pine. This is a clear indication that this is the wreck of a merchantman, since portions of the hull which were under less stress were often completed with a lighter coniferous species to reduce the deadweight of the hull, thereby increasing its cargo carrying capacity (Hoving 2012, p. 22).

### 3.2. INDICATIONS OF ‘DOUBLE DUTCH’

The stern section features four strakes of planking that appear to be doubled. Although this could be interpreted as a repair or later addition, the impression of a vessel built with two layers of planking was further corroborated by truncated treenails, which were particularly apparent in the midship section (fig. 2, wreck section 2). The reason for the truncation was described by Thijs Maarleveld (1994, p. 153) in the context of the building sequence of what he dubbed the ‘Double Dutch’ method: a first row of treenail holes was bored to connect the planks with the inserted frames, then a second layer of planks added and fastened once again with an additional set of treenails, now protruding through all layers of the hull; the first and the second layer of planks, the frame and the ceiling planks. In several cases the new treenail holes truncated the earlier treenail insertions. Another feature of the ‘Double Dutch’ method is the ample use of waterproofing material applied broadly between the first and the second layer of planking (Maarleveld 1994, p. 153), which, according to a contemporary Dutch source, contained wax and resinous matter onto which a matting of animal hair was applied as filling material before the second layer of planking was added (van Yk 1697, p. 91). On the outer side of the retrieved plank (fig. 3), probably the garboard of the first layer of planking, were indeed traces of waterproofing material identified as animal hair, which survived thanks to an iron nail concretion. An effort to make the inner planking watertight is also reflected by a patch inserted over a knot.

### 3.3. EVIDENCE OF SHIP SCRAPPING

In early December a local resident sent photos of the keelson to the ALSH. A few days later, on 9 December, the keelson had already gone missing, so all observations could only be inferred from the photos. The keelson measured approximately 50 cm in width and had an integrated mast step, with a carved diagonal cross at its base with a protruding hole in the centre, probably a drain. The position of the keelson and mast step could be reconstructed precisely by a protruding treenail observed on 9 December and thus confidently integrated into the general plan (fig. 2). The mast step featured chop marks and the wreck had evidently been scrapped. The scrapping of wrecks was a welcome source of income for the local population and ducal edicts specified shares and penalties to deter beachcombers and illegal wreckers (Kühn 1999, p. 10-11, 29). According to the *Gottorfische Strandordnung*, a ducal edict of 1712, stranded crews had only three tides to get their vessel either afloat again or to save their belongings before the wreck site was cleared for scrapping and salvage (Englert 1997, p. 47-48).

## 4. DENDROCHRONOLOGICAL RESULTS

The following results are based on the analyses carried out by Dr Karl-Uwe Heußner of the German Archaeological Institute in Berlin. Two samples taken from oak floor timbers (fig. 2, S1, S2) contained sapwood and date to 1684 and 1690. Another two samples taken from oak planks (fig. 2, S3, S5) without sapwood have the years 1647 and 1649 as last tree rings, respectively. The chronological discrepancy can be

explained by the absence of sapwood rings and waste of material, which is common for planks due to their pre-specified widths. Thus, 1690 is the *terminus post quem*, indicating a ship construction date in the same year or shortly thereafter.

The framing timber originated from the central Havel or Prignitz region in Brandenburg. Given that there are separate reference curves for both regions, the modest t-value of 5.7 should not be underrated (Karl-Uwe Heußner, personal communication). The planks correspond to timber chronologies in northern Poland. The pine timber of the amidships section was unfortunately not accessible for sampling, but it could be surmised that it would have added a third discrete provenance.

The regional discrepancy of provenances is not surprising, because different construction elements necessitated timber products of various species, qualities and properties. These were commonly imported by citizens of the Republic of the Seven United Netherlands, which was almost entirely deforested and yet operated the largest merchant fleet in the world at that time. Framing timber from Brandenburg would have been imported as 'Hamburg timber', since Hamburg was the point of transshipment for oak timber cut in Brandenburg and floated down the Havel and Elbe rivers. At that time, Hamburg was known as one of the most important ports for acquiring compass timber (Hoving 2012, p. 22), probably because 'Hamburg timber' was appreciated as particularly resistant and durable due to its high content of heartwood (Karl-Uwe Heußner, personal communication). The Dutch were amongst the main importers of 'Hamburg timber' and became very engaged in the oak timber trade in Brandenburg from 1650 (van Tussenbroek 2006). The planks were most likely transshipped via Danzig (Gdańsk), which remained one of the most important Baltic Sea ports for timber exports next to Königsberg (Kaliningrad) and Courland in the 17<sup>th</sup> century (Bonde *et al.* 1997, p. 203).

## 5. CONTEXTUALISING AND INTERPRETING THE WRECK

Although the Hörnum Odde wreck has several constructional features in common with other 17<sup>th</sup>-century wrecks from the North Frisian Wadden Sea (Zwick, Kloob 2018, p. 212-213), which was an area under heavy Dutch influence, its most striking feature is the 'Double Dutch' construction. The earliest known wreck featuring such construction is the Scheurrak SOI of *circa* 1590 from the Netherlands, thus, with the Hörnum Odde wreck of 1690, the longevity of the 'Double Dutch' phenomenon can be attested for a century. Aside from the Scheurrak SOI, most 'Double Dutch' wrecks hitherto identified were owned by the *Vereenigde Oost-Indische Compagnie* (VOC), or Dutch East India Company, which usually had an additional third layer of pine as sacrificial planking. These wrecks are the *Mauritius* (1594/1602), *Batavia* (1628), *Avondster* (*circa* 1641), the Angra C wreck (17<sup>th</sup> century) and the B&W 2 wreck (1606); the latter being a Dutch-built Danish East Indiaman (van Duivenvoorde 2015a, p. 147). There can be no doubt that the 'Double Dutch' technique was 'phenotypical' for the VOC from 1602. This is reflected in a 1643 letter addressed to the VOC Chamber of Enkhuizen, which sought to reduce shipyard maintenance time in the colonies and therefore recommended an

addition of pine planks to protect oak planks from shipworm (van Duivenvoorde 2012, p. 247).

Based on the comparative evidence, an interpretation of the Hörnum Odde wreck as a VOC ship seems possible. Its find location is not problematic, as VOC ships often chose a detour through the North Sea circumnavigating the British Isles as evidenced by VOC wrecks like the *Kennemerland*, sunk in 1664 off the Shetland Islands (Muckelroy 1976), or the *Adelaar*, wrecked in 1728 off the Outer Hebrides (Martin 2005). Particularly during the Nine Years' War (1688-1697), in which the Dutch Republic was part of an alliance against France, VOC ships avoided the English Channel in fear of French privateers. In 1690 alone, two returning VOC ships wrecked off the Shetland Islands (Bruijn *et al.* 1979b, p. 133). There is also a historical record of a VOC fluyt, which foundered off the coast of Sylt, but its date does not match with that of the Hörnum wreck. It was the VOC fluyt *Amstelland*, built in 1750, set sail from Texel on 7 September 1751, but ran ashore on Sylt 11 days later (Bruijn *et al.* 1979a, p. 534).

However, a VOC association is not the only possible interpretation, as a historical document of 1660 mentions that Dutch whalers sailing to Spitsbergen also fitted out their ships with two layers of oak planking (van Duivenvoorde 2015b, p. 359). An additional sheathing would have made sense not only against marine borers, but also as structural reinforcement against ice floes.

Last but not least, such reinforcement would have also been beneficial when beaching ships on a tidal shore to stevedore at low tide, which was a common practice in the Wadden Sea area. On the Danish west coast such vessels were called *sandskuder* and were also often double-planked, but in contrast to 'Double Dutch' constructions, *sandskuders* received the second layer of planking not from the beginning, but during a later rebuild after the hull had worn out and become leaky (Gøthche 1985, p. 304). Dutch fishermen kept the practice of beaching ships alive well into the 19<sup>th</sup> century, and the process inspired the British painter Edward William Cooke to numerous paintings in which the *pincks* of Scheveningen served as a common motif. Thus, the Hörnum wreck could also be interpreted in a very regional context and may not even necessarily reflect an accidentally stranded wreck, but possibly a vessel that fell dry at low tide but could not get afloat again due to a strong onshore gale, or the influence of a neap tide, while the hull was settling deeper into the sediments with each missed tide, until it was cleared for salvage.

## 6. CONCLUSION

Despite the adverse site conditions, a number of significant details could be observed and documented, which allowed an unequivocal identification of the shipbuilding tradition fulfilling all the criteria of 'Dutch flush' and 'Double Dutch'. The question of the ship type or even the ship's actual identity can not yet be clarified, but the dimensions of the vessel certainly suggest that this must have been a multi-masted ship, perhaps a fluyt or pinnace. At the conference, one participant advocated to drop the term 'Double Dutch' in view of double-planked vessels of other shipbuilding traditions, but this author believes that 'Double Dutch' remains a useful term to refer specifically to double-planked vessels built in the idiosyncratic Dutch shell-first method.



## ACKNOWLEDGEMENTS

I wish to thank my colleague Dr Stefanie Kloß for the organisation of the fieldwork and for tasking me with the documentation, research and publication of this fascinating wreck. I also wish to thank my other ALSH colleagues, Jan Fischer, Linda

Hermannsen and Heiner Menzel for the pleasant cooperation. I am grateful to Dr Karl-Uwe Heußner for the swift dendro-chronological analysis and for providing further comments, and to Jonas Enzmann and Feiko Wilkes for generating an SfM model with Agisoft Photoscan. Karsten Bracker, Dr Anton Englert and particularly Dr Wendy van Duivenvoorde provided interesting details and literature, which helped to contextualise this wreck.

## REFERENCES

- AHRENDT K., KÖSTER P.  
1998 Sylt – einst und jetzt, in J. Kohlus, H. Küpper (eds.), *Umweltatlas Wattenmeer: Nordfriesisches und Dithmarscher Wattenmeer, Landesamt für den Nationalpark Schleswig-Holsteinisches Wattenmeer Umweltbundesamt*, Stuttgart, Ulmer, p. 38-39.
- BONDE N., TYERS I, WAZNY T.,  
1997 Where Does the Timber Come From? Dendrochronological Evidence of the Timber Trade in Northern Europe, in A. Sinclair, E. A. Slater, J. Gowlett (eds), *Archaeological Sciences 1995, Proceedings of a Conference on the Application of Scientific Techniques to the Study of Archaeology*, Liverpool 1995, Oxford, Oxbow books, p. 201-204.
- BRUIJN J. R., GAASTRA F. S., SCHÖFFER I.,  
1979a *Dutch-Asiatic Shipping in the 17<sup>th</sup> & 18<sup>th</sup> Centuries (Vol. II): Outward-bound voyages from the Netherlands to Asia and the Cape (1595-1794)*, The Hague, Martinus Nijhoff.  
1979b *Dutch-Asiatic Shipping in the 17<sup>th</sup> & 18<sup>th</sup> Centuries (Vol. III): Homeward-bound voyages from Asia and the Cape to the Netherlands (1597-1795)*, The Hague, Martinus Nijhoff.
- DUIVENVOORDE VAN W.  
2012 Use of Pine Sheathing on Dutch East India Company Ships, in N. Günsenin (ed.) *Between Continents, Proceedings of the Twelfth Symposium on Boat and Ship Archaeology (ISBSA 12), Istanbul 2009*, Istanbul, Ege Yayinlari, p. 241-252.  
2015a *Dutch East India Company Shipbuilding. The Archaeological Study of Batavia and Other Seventeenth-Century VOC Ships*, College Station, Texas A&M University Press.  
2015b The Use of Copper and Lead Sheathing in VOC Shipbuilding, *IJNA* 44.2, p. 349-361.
- ENGLERT A.  
1997 *Das neuzeitliche Wrack aus dem Hedwigenkoog, Kr. Dithmarschen*, Bonn, Habelt, Universitätsforschungen zur Prähistorische Archäologie 41.
- GØTHCHE M.  
1985 *Sandskuder – vessels for trade between Norway and Denmark in the 18<sup>th</sup> and 19<sup>th</sup> century*, in C. O. Cederlund (ed.), *Postmedieval Boat and Ship Archaeology, Proceedings of the Third International Symposium on Boat and Ship Archaeology (ISBSA 3), Stockholm 1982*, Oxford, BAR Int. Series 256, p. 299-314.
- HOVING A. J.  
2012 *Nicolaes Witsen and shipbuilding in the Dutch Golden Age*, College Station, Texas A&M University Press.
- KÜHN H.-J.  
1999 *Gestrandet bei Uelvesbüll – Wrackarchäologie in Nordfriesland*, Husum, Husum Verlag.
- MAARLEVELD T. J.  
1992 Archaeology and early modern merchant ships, building sequences and consequences: an introductory view, in A. Carmiggelt (ed.), *Rotterdam Papers*, VII, p. 153-173.  
1994 Double Dutch Solutions in Flush-Planked Shipbuilding: Continuity and Adaptations at the Start of Modern History, in C. Westerdahl (ed.), *Crossroads in Ancient Shipbuilding. Proceedings of the Sixth International Symposium on Boat and Ship Archaeology (ISBSA 6), Roskilde 1991*, Oxford, Oxbow book, p. 153-163.  
2013 Early Modern Merchant Ships, Nicolaes Witsen and a Dutch-Flush Index, *IJNA* 42.2, p. 348-357.
- MARTIN C. J. M.  
2005 The Adelaar: a Dutch East-Indiaman wrecked in 1728 off Barra, Outer Hebrides, Scotland, *IJNA* 34.2, p. 179-210.
- MUCKELROY K.  
1976 The integration of historical and archaeological data concerning an historic wreck site: the Kennemerland, *World Archaeology* 7.3, p. 180-289.
- SEWEL W., BUYS E.  
1766 *A Compleat Dictionary English and Dutch / Volkomen Woordenboek der Engelsche en Nederduitsche Taalen*, Amsterdam.
- TUSSENBROEK VAN G.  
2006 Michiel Matthijsz Smids (1626-1692). Kurfürstlicher Baumeister in Brandenburg, *Architectura – Zeitschrift für Geschichte der Baukunst* 36.1, p. 60-83.
- WITSEN N.  
1671 *Aeoude en Hedendaegsche Scheepsbouw en bestier*, Amsterdam.
- YK VAN C.  
1697 *De Nederlandsche scheepsbouwkunst Open Gestelt*, Amsterdam.
- ZWICK D., KLOOSS S.  
2017 Das frühneuzeitliche Schiffswrack von Hörnum Odde, Sylt, *Skyllis* 17.2, p. 204-216.
- Other sources**
- GDI-BSH  
2009 AufMod Morphodynamics, in *Geodateninfrastruktur des Bundesamtes für Seeschifffahrt und Hydrographie*, [https://gdiwiki.bsh.de/wiki/index.php/AufMod\\_Morphodynamics](https://gdiwiki.bsh.de/wiki/index.php/AufMod_Morphodynamics) (accessed July 2019).
- LKN-SH  
2016 *Landesbetrieb für Küstenschutz, Nationalpark und Meeresschutz Schleswig-Holstein, Fachplan Küstenschutz Sylt: Kartierung der Sturmflutschäden*, [http://www.schleswig-holstein.de/DE/Fachinhalte/K/kuestenschutz\\_fachplaene/Sylt/Downloads/FP\\_Sylt\\_2-3b\\_Sturmfluten.pdf](http://www.schleswig-holstein.de/DE/Fachinhalte/K/kuestenschutz_fachplaene/Sylt/Downloads/FP_Sylt_2-3b_Sturmfluten.pdf) (accessed April 2017).





# THE FAHRDORF WRECK: ANOTHER LARGE 12<sup>TH</sup>-CENTURY CARGO SHIP IN THE SCHLEI, NORTHERN GERMANY

Jonas ENZMANN, Fritz JÜRGENS and Feiko WILKES

---

## Abstract

In 2014 an accidentally raised construction timber turned out to be a part of a medieval shipwreck resting in the murky waters of the Schlei inlet of the Baltic Sea in northern Germany. The Study Group for Maritime and Limnic Archaeology (AMLA) of the Christian-Albrechts University (CAU) at Kiel has examined and documented the remains using computer vision photogrammetry over recent years. Based on these campaigns it has been possible to date the wreck and determine its function as a large cargo sailing vessel, which testifies to the importance of the Schlei as a trading route for the cities of Hedeby and Schleswig.

## Keywords

Computer vision photogrammetry, large trading ship, medieval, Nordic shipbuilding tradition, northern Germany

## Résumé

En 2014, un élément de bois de construction, mis au jour de façon accidentelle, a été attribué à une épave médiévale reposant dans les eaux troubles du Schlei en mer Baltique, dans le nord de l'Allemagne. Au cours des dernières années, le Groupe d'étude pour l'archéologie maritime et lacustre (AMLA) de l'Université Christian-Albrechts (CAU) à Kiel a procédé à l'étude et à la documentation des vestiges en faisant notamment usage de la photogrammétrie numérique. Il a ainsi été possible de dater l'épave du XII<sup>e</sup> siècle et de déterminer qu'il devait s'agir d'un grand cargo à voile, témoignage de l'importance du Schlei comme voie commerciale pour les villes de Hedeby et de Schleswig.

## Mots clés

Photogrammétrie, grand navire de commerce, Moyen-Age, tradition de la construction navale nordique, nord de l'Allemagne

---

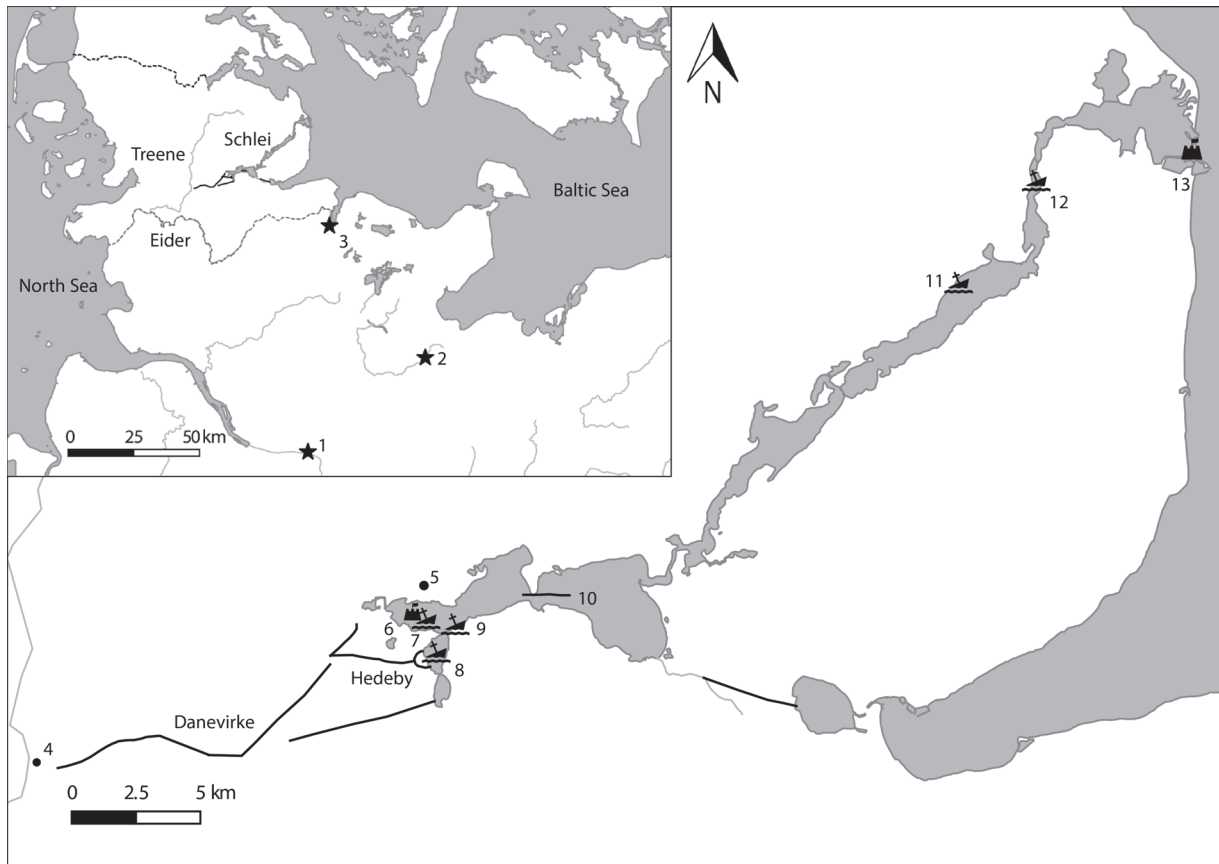
The site is located near the marina of the village of Fährdorf opposite Schleswig on the southern banks of the Schlei at a depth of *circa* 2 m (fig. 1) and very close to the famous Viking-age settlement of Hedeby. The Schlei is a 42 km long inlet that stretches from the Baltic Sea to the town of Schleswig. In combination with the Rivers Treene and Eider and a land passage, the Schlei functioned as the main exchange route between the Baltic and the North Sea in the Viking Age and early medieval times (Brandt 2000, p. 319). Its importance is documented by over 40 wrecks from different periods, which have so far been found in its waters (Nakoinz 2014, p. 104).

In August 2014 a fisherman, J. Ross, accidentally recovered a very well-preserved floor timber and reported the potential wreck site to the Archaeological State Department of Schleswig-Holstein (ALSH) (fig. 2). Two professional divers, G. and R. Lorenz, conducted a survey of the site in September 2014, under the supervision of J. Fischer from the ALSH, O. Nakoinz from the Institute of Pre- and Protohistoric Archaeology of the CAU in Kiel and S. Hartz of the Archaeological State Museum in Schleswig. The survey confirmed the potential of the site by lifting several loose timbers including a complete knee. Due to the poor visibility that day, no pictures or videos of the site could be taken. Based on the examination of the finds lifted, O. Nakoinz suggested a clinker-built vessel which he preliminary dated to the 11<sup>th</sup> or 12<sup>th</sup> century AD. Up to this point there was no precise data regarding the extent of the wreck site and due to fishing activities and erosion the site was endangered. While preparing for the field school Maritime Archaeological

Programme (MAP) of the Syddansk University in Esbjerg and the ALSH on the Viking-age barrier at Reesholm in summer 2015, the company Innomar from Rostock surveyed the wreck site with a parametric sub-bottom profiling system. Furthermore, the Department of Geophysics of the Institute of Geoscience of the CAU Kiel experimented on the site with a new 3D marine reflection seismic system called *PingPong* (Wilken *et al.* 2019). The results showed an approximately 20 m-long anomaly in the area of the site. Additionally, some measurements of the site were taken with a total station during the field school in summer 2015. The measurements of fragile frame heads roughly confirmed the extent of the site.

## 1. THE PROJECT

Due to the high archaeological potential of the Schlei, the AMLA of the CAU at Kiel, composed mostly of European certified scientific divers studying prehistorical and historical archaeology, concentrated their research on this region. In 2014, five members of the AMLA examined and documented a logboat, most likely from the medieval or early modern period, near the town Kappeln (Steffensen, Wilkes 2016, p. 16-19). Fortunately, the visibility of more than 1 m was extraordinarily good during that project. In summer 2015, the AMLA joined the aforementioned field school of the Maritime Archaeological Programme (MAP) of the Syddansk University in Esbjerg and the ALSH.



**Fig. 1:** Map of the Schleswig isthmus region: 1. Hamburg, 2. Lübeck, 3. Kiel, 4. Hollingstedt, 5. Schleswig, 6. Jürgensburg, 7. Möweninsel wreck, 8. Haithabu 3 wreck, 9. Fahrdorf wreck, 10. Reesholm Barrier, 11. Karschau wreck, 12. Kappeln logboat, 13. Olsburg (J. Enzmann)

Thus, in autumn 2015 the AMLA began working on the Fahrdorf wreck as a project on a voluntary basis. The timbers found up to this date were not suitable for dendrochronological dating. In agreement with the ALSH, AMLA returned to the site in October 2015. The survey and dendro-sampling turned out to be highly successful this time, due to unexpectedly good visibility of *circa* 0.30 m. Fortunately, one of the divers took a GoPro video camera on the dive and filmed parts of the site. Afterwards F. Wilkes was able to generate a 3D model and a photomosaic from these short clips using the software Agisoft Photoscan. The results turned out to be extraordinarily helpful.

A plan was therefore established to develop this method further and test it at different sites. Because of the good results AMLA achieved with this method, the ALSH supported the idea and made it possible to conduct a systematic video survey of the Fahrdorf wreck site. Assuming that the visibility on site is strongly connected to the seasons, the AMLA returned to the site in mid-December. Because different cameras and settings were tried, two dive days were necessary to fully document 11 × 4 m of seafloor with visibility between 30 and 40 cm, while the visible parts of the wreck covered an area of 9 × 4 m. All exposed timbers were marked with bright yellow, numbered plastic discs. The georeferenced photomosaic was combined with the results of the parametric sub-bottom profiler and the *PingPong* 3D system data (as mentioned above) by using the four measured corners and aligned well with the recorded anomaly.

From February 15 to 16, 2017 the AMLA started a new campaign on the wreck. The aim was to check the preservation and

sedimentation conditions of the wreck by filming it again and comparing the generated pictures and models to the old ones. In addition, more dendrochronological samples were taken because no sample had so far provided a date. To validate some ideas about the construction and position of the wreck, a small sondage on the southern end of the wreck site was dug.

The first objective was to establish a reference system for the diver. Luckily, only one of the markers from the previous investigation was lost, and it was possible to georeference the new video material with the other markers and the positions taken by total station in 2015. In addition to the already marked timbers, some new timbers between the old ones but further to the east could be documented. Subsequently, two divers started to excavate the sondage area, which was then filmed the next day when the water was clear of the disturbed sediment. On the basis of the video material, new 3D models and orthophotos of the visible timbers of the whole wreck site and the test trench were produced (fig. 3) Additionally, two new samples for dendrochronology were obtained from eroded planks at the southern end of the wreck.

### 1.1. THE CONSTRUCTION AND POSITION

The Fahrdorf wreck is largely covered with sandy sediment and soil. Only some timbers are visible and rise up to 15 cm above the sea floor. The known length from the excavated and visible timbers is nearly 9 m. Up to the 2017 survey, eight



Fig. 2: The floor timber that was raised in 2014 by a fisherman and led to the discovery of the *Fahrdorf* wreck (ALSH/Jonas Enzmann)

parallel floor timbers had been discovered on the seabed. They are orientated east/west, which means that the wreck's orientation is exactly north/south (fig. 4). A few plank fragments and both preserved ends of the southern two timbers are visible on the surface of the sediment. This area was excavated during the 2017 campaign and thus the southern quarter of the wreck could be documented. The exposing of a floor timber revealed that the ship heeled nearly 20 degrees to the east (fig. 4). It was not possible to evaluate if the excavated end is the bow or the stern. To accommodate the absence of bow and stern, port and starboard, the strakes were numbered from the keel to east (E) and west (W) and the frames from south to north. The regular interval of the frames revealed that two timbers are missing, so the last timber to the north is numbered 10, although there are only eight visible on the seafloor. Most likely one of the missing floor timbers (04 or 08) is the one that was lifted during the exploration of the wreck in 2014 (fig. 2). This lifted floor timber extended over six strakes on the right-hand side of the photo whereas on the left-hand, broken side only four strakes are visible. The central part shows a W-shaped cross section. At the position of the second and third strakes of the right-hand side two treenails remain in place. The georeferenced 3D model (fig. 3) shows that floor timber 02 had a visible length of 150 cm and is 13 cm wide at its thickest part.

As the previously recovered parts had already shown, the vessel was clinker-built. The boards, with dimensions of 20 × 2.5 cm, were made from radially cleft oak and finished with axes, as is indicated by tool marks. Only the fifth strake (E05) is smaller, with a width of 10 cm: it is possibly a repair plank. Iron rivets and rectangular roves were used to clench the individual planks at a constant interval of 18 cm. Because of the poor preservation it has not yet been possible to take detailed measurements of the rivets. The planking is luted with animal hair. Because of the wreck's list, only two strakes (W01, W02) are preserved on the west side, whereas on the east seven (E02-E08) could be excavated. E01, the first eastern plank on the keel, is missing. Additionally, the extent of the surface frame heads indicates that twice as many strakes could still be concealed in the sediment.

The floor timbers were axe-cut out of compass timbers and were furnished with notches to house the planks. They are fixed with treenails, which have a diameter of approximately 3 cm. The timbers span symmetrically across the keel and are notched for the first six (01 and 04/08) or seven (02) strakes. The distance

between the frames is consistently 70 cm. Floor timber 02 has a preserved length of 157 cm. Its cross section has the dimensions of 12 by 12 cm. A previously salvaged knee and a special *biti*-stanchion already indicated the typical Nordic frame construction of floor timbers and above positioned lower beams, known as *bitis*. The test trench of the 2017 survey revealed two treenails in the planking east of, or rather above floor timber 02, which must have held such a *biti* construction in position. It is conspicuous that there is no hole in the floor timber, which could house a *biti*-stanchion. Maybe these stanchions are only used further forward, or respectively aft. Two timbers in the east of the wreck, in line with frames 04 and 05, are interpreted as futtocks, but one cannot say yet if they are used as part of a *biti* construction in the midships area. There are two limber holes on the bottom of the frames, which allowed the bilge water to run above the keel. The keel itself has not yet been found. It might lie deeper in the sediment, but more likely it is missing in the southern part of the wreck, as indicated by the absent strake E01. As is customary in Nordic shipbuilding, the keel was not fixed to the frames, so no nail holes are visible in timber 02.

The length of the wreckage, known through the excavated and surface visible timbers, is nearly 9 m, but the curvature of the uncovered two floor timbers of the south end of the hull reveals that the position of the missing bow or stern must be a minimum of 3 m further to the south. A comparison of the dimensions and the shape of these floor timbers with those of the *Karschau* wreck, which is presented below, indicates that

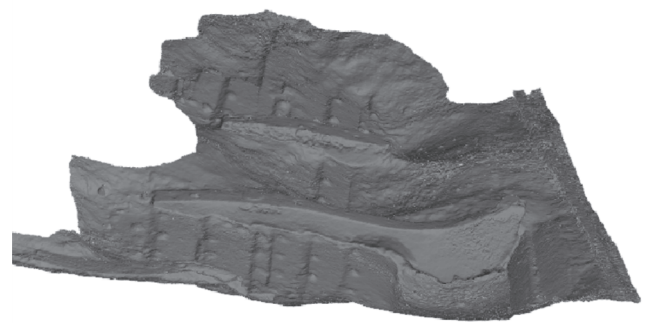


Fig. 3: 3D model of the area excavated in 2017 generated from videos (F. Wilkes)



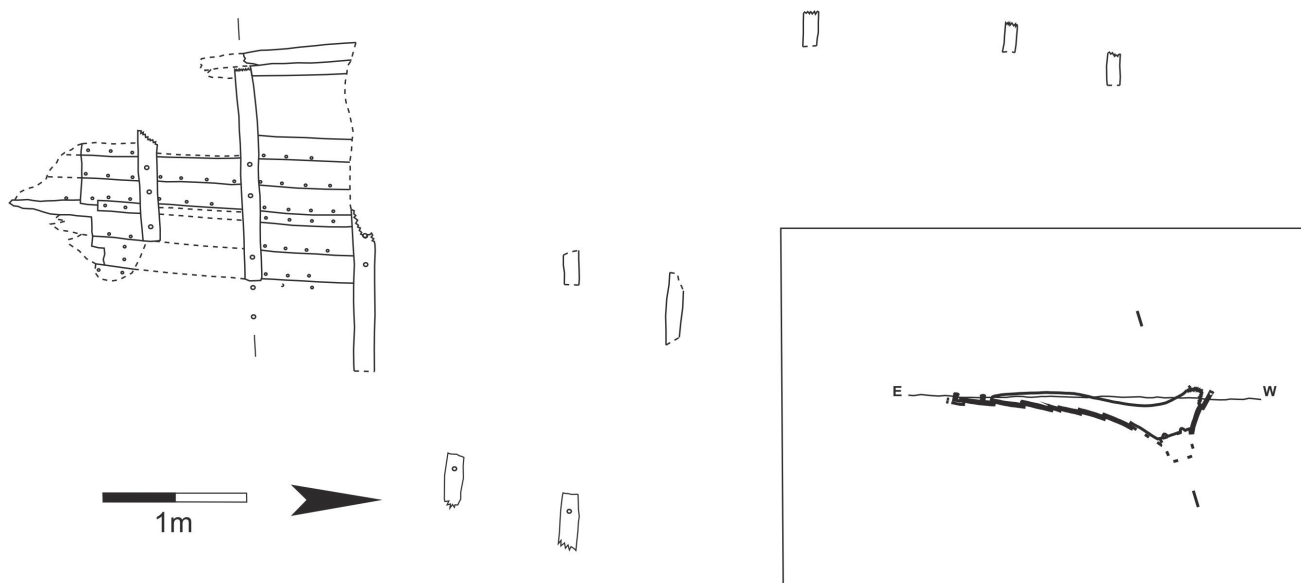


Fig. 4: Overview of the currently documented features of the wreck based on computer vision photogrammetry (F. Jürgens)

the original ship was approximately 20 m long and 6 m wide: the proportions of a large cargo sailing vessel. The cargo-carrying capacity of such ships is an estimated 50 tonnes (Kühn 2009, p. 82).

Until now there is no evidence of the nature of the ship's load. A brick found near the wreck seems to be a later addition. The position of the wreck in shallow water near the village of Fahrtdorf and the absence of small finds, as with the (partly) missing keel, would indicate that the ship broke up near this place. A plank fragment containing a repaired leak, salvaged in 2015, suggests that the ship was used over a long period.

## 1.2. DATING

The first three wood samples obtained in 2014 were found to contain too few tree rings, making it impossible to date them (Daly 2015). However, by adding the new samples taken in 2017, all samples could be dated due to the cross matching of some tree rings. Even sapwood was preserved on one sample. The result is a cutting date between AD 1106 and 1121 (Daly 2017). This dating fits well with the first typological classification based on the lifted timbers in 2014 by O. Nakoinz. All samples are from planks made of oak (*Quercus spec.*). Based on an average curve of all samples, a length of 110 years could be compared to provenance curves. The highest correlations are achieved with curves from Schleswig-Holstein and Southern Jutland, indicating a local provenance for the Fahrtdorf wreck.

## 2. COMPARISONS

Three additional wrecks from the 11<sup>th</sup> and 12<sup>th</sup> centuries are known in the Schlei inlet, giving an excellent impression of the medieval cargo shipping in this region.

The first is the Karschau wreck, which was discovered during extreme low water in 2000 near Arnis (fig. 1). In 2001, the partly preserved portside and the keel were fully excavated, lifted and documented on land. The wreckage was 12.5 m long and had several features – floor timbers, *biti*-stanchion and frame spacing – similar to the Fahrtdorf wreck (Englert 2015). Even the proportions and size are analogous. Only the surface ornamentation with grooves present on the wreck could not be found on the Fahrtdorf wreck. The Karschau wreck was dated by A. Daly to a cutting date around 1145 AD. In addition, the Haithabu 3 wreck is similar in size at 22.1 m long and 6.25 m wide: it is the oldest of this ship type and was built around 1025 (Rösch 2018, p. 219). It was found in Haddebyer Noor, near the former Viking centre of Hedeby (fig. 1).

Another wreck was found even closer to Schleswig and Fahrtdorf at the Möweninsel (fig. 1). The wreck's condition was very poor: the longest preserved part was the keel at 9.5 m, next to a small part (4 × 1.8 m) of the hull. This ship, with a reconstructed length of 15 m and a width of 4 m (Belasus 2009, p. 96), belongs to a medium-sized class of cargo vessels (Crumlin-Pedersen 1999, p. 18). It was built after 1163 AD, as indicated by dendrochronological dating. Similar to the Karschau wreck, it is ornamented with grooves on some planks and timbers. Particularly noticeable is that the distance between the frames on the Möweninsel wreck is only 51 cm, while it is 70 cm on the Fahrtdorf example. This indicates a typological development in Nordic shipbuilding, since the older ships, relating to the Viking period, had a frame space of 0.9-1 m (Belasus 2009, p. 93-94). This change in construction might be due to the greater carrying capacity of these cargo vessels.

All in all, the wrecks of Karschau, Möweninsel, Haithabu 3 and now Fahrtdorf are a singular inventory that testifies to the rise of medieval cargo shipping in the Baltic. These ships represent the latest development in the Nordic shipbuilding tradition, starting in the Viking Age. Specific features of Nordic shipbuilding, like the *bitis*, vanished shortly afterwards (Nakoinz 2014, p. 109-113).

### 3. CONCLUSION

Discovered by chance, pursued by the interests of students, the Fahrtdorf wreck has grown to become an extensive research subject for the AMLA. What makes the present project so unique is that only a few have so far applied computer vision photogrammetry in waters with such poor visibility and with affordable camera equipment (Van Damme 2015). The success of the method enables underwater archaeologists to

document features invisible to the diver's eye. This possibility will undoubtedly form a future focal point in the works of the AMLA.

The wreck itself fits right into an already well-outlined historical context. It is a large cargo ship from the end of the development process of the Nordic shipbuilding tradition. The preservation of nearly one complete side of the ship gives hope that there are plenty of discoveries left on the seafloor and that these discoveries might eventually lead to answering questions such as why and how shipbuilding changed in this region.

### REFERENCES

- BELASUS M.  
2009 Das hochmittelalterliche Schiff vor der Möweninsel bei Schleswig, in U. Müller, S. Kleingärtner, F. Huber (eds), *Zwischen Nord- und Ostsee 1997-2007: Zehn Jahre Arbeitsgruppe für maritime und limnische Archäologie (AMLA) in Schleswig-Holstein*, Bonn, R. Habelt, Universitätsforschungen zur Prähistorischen Archäologie 165, p. 89-98.
- BRANDT K.  
2000 Der Handel über die Schleswiger Landenge und die Bedeutung der Flüsse Eider und Treene für die Entwicklung von Siedlung und Wirtschaft, in H. Beer, Ch. Börker, Th. Förster, F. Lüth, M. Mainberger, O. Nakoinz, J. Riederer, H. Schlichtherle, U. Schoknecht (eds), *Schutz des Kulturerbes unter Wasser: Veränderungen europäischer Lebenskultur durch Fluß- und Seehandel, Beiträge zum Internationalen Kongress für Unterwasserarchäologie (IKUWA ,99) 18-21. Februar 1999 in Saßnitz auf Rügen*, Lübstorf, Beiträge zur Ur- und Frühgeschichte Mecklenburg-Vorpommerns 35, p. 319.
- CRUMLIN-PEDERSEN O.  
1999 Ships as Indicators of Trade in Northern Europe 600-1200, in J. Bill, B.L. Clausen (eds), *Maritime Topography and the Medieval Town*, Copenhagen, Stud. Arch. and Hist. 4, p. 11-20.
- DALY A.  
2015 Dendrochronological analysis of timbers from a shipwreck at Fahrtdorf, Schleswig, *dendro.dk* report 2015, p. 4, Copenhagen.  
2017 Dendrochronological analysis of timbers from a boat at Fahrtdorf, Schleswig, *dendro.dk* report 2017, p. 17, Copenhagen.
- VAN DAMME T.  
2015 Computer vision photogrammetry for underwater archaeological site recording in a low-visibility environment, *The International Archives of the Photogrammetry, Remote Sensing and Spatial Information Sciences* Volume XL-5/W5, (DOI 10.5194/isprsarchives-XL-5-W5-231-2015), p. 231-238.
- ENGLERT A.  
2015 Large Cargo Ships in Danish Waters 1000-1250: evidence of specialised merchant seafaring prior to the Hanseatic Period, *Ships and Boats of the North* 7, Roskilde, The Viking Ship Museum.
- KÜHN H.J.  
2009 Frachtsegler und Fährre: Zwei bedeutende Wracks des 12. Jahrhunderts aus der Schlei, in U. Müller, S. Kleingärtner, F. Huber (eds), *Zwischen Nord- und Ostsee 1997-2007: Zehn Jahre Arbeitsgruppe für maritime und limnische Archäologie (AMLA) in Schleswig-Holstein*, Bonn, R. Habelt, Universitätsforschungen zur Prähistorischen Archäologie 165, p. 81-88.
- NAKOINZ O.  
2014 Die Schlei, in F. Huber, S. Kleingärtner (eds), *Gestrandet – Versenkt – Versunken: Faszination Unterwasserarchäologie*, Neumünster/Hamburg, Wachholtz, p. 102-121.
- RÖSCH F.  
2018 *Das Schleswiger Hafenviertel im Hochmittelalter: Entstehung – Entwicklung – Topographie*, Bonn, R. Habelt, Zeitschrift für Archäologie des Mittelalters, Beiheft 26.
- STEFFENSEN F., WILKES F.  
2016 Two recent AMLA projects: excerpt of the lecture at the N.E.R.D. Conference: A logboat in the Schlei fjord/Underwater prospecting on the mesolithic site Strande LA 163, in M. Christ, J. Enzmann, F. Jürgens, F. Steffensen, J. Ulrich, F. Wilkes (eds), *N.E.R.D. New European Researches and Discoveries in Underwater Archaeology Conference: Beiträge der internationalen Konferenz der Arbeitsgruppe für maritime und limnische Archäologie, 21.-23. November 2014 in Kiel*, Bonn, R. Habelt, Universitätsforschungen zur Prähistorischen Archäologie 291, p. 16-23.
- WILKEN D., WUNDERLICH T., HOLLMANN H., SCHWARDT M., RABEL W., MOHR C., SCHULTE-KORTNACK D., NAKOINZ O., ENZMANN J., JÜRGENS F., WILKES F.  
2019 Imaging a medieval shipwreck with the new PingPong 3D marine reflection seismic system, *Archaeological Prospection*, 263, p. 211-223 (<https://doi.org/10.1002/arp.1735>, p. 1-22).



# TWO SHIPS UNDER ROCKS: A GLIMPSE INTO RURAL SHIPBUILDING IN WESTERN POMERANIA

Jens AUER

---

## Abstract

The wrecks of two clinker-built vessels were excavated and lifted off the coast of Mecklenburg-Western Pomerania in northern Germany as part of the archaeological mitigation procedures for the Nord Stream 2 gas pipeline project.

The ships formed part of an underwater barrier created by Swedish forces during the Great Northern War in 1715. As a result of the excavation carried out by the state authority for culture and monuments in Mecklenburg-Western Pomerania, both wrecks were documented underwater, disassembled, lifted and studied on the surface. All ship timbers were recorded in detail using a structured-light scanner and photogrammetry before the wrecks were moved into temporary wet storage.

After completion of the marine construction project, the wrecks will be re-deposited near their original locations.

## Keywords

Excavation, 18<sup>th</sup> century, Great Northern War, Mecklenburg-Western Pomerania, shipwreck

## Résumé

Les épaves de deux navires à clin ont été fouillées et renflouées au large des côtes du Mecklembourg-Poméranie occidentale dans le nord de l'Allemagne, dans le cadre des fouilles préventives réalisées pour le projet de gazoduc Nord Stream 2.

Les navires appartenaient à un barrage sous-marin édifié par les forces suédoises pendant la Grande guerre du Nord en 1715. À la suite des fouilles, réalisées sous la direction de l'autorité régionale en charge de la culture et du patrimoine de Mecklembourg-Poméranie occidentale, les deux épaves ont été documentées sous l'eau, démontées, renflouées et étudiées en surface. Tous les bois des navires ont été enregistrés en détail à l'aide d'un scanner à lumière structurée et d'une photogrammétrie avant que les épaves ne soient déplacées dans une zone de stockage humide temporaire. Une fois la construction du gazoduc achevée, les épaves seront ré-enfouies près de leur emplacement d'origine.

## Mots clés

Fouille préventive, XVIII<sup>e</sup> siècle, grande guerre du Nord, Mecklembourg-Poméranie-Occidentale, épave

---

## 1. HISTORICAL CONTEXT

The Great Northern War (1700-1721) was fought between Sweden and Denmark and its allies, Saxony-Poland, Prussia and Russia. In the early phases of the war Sweden was successful and forced both Denmark (1700) and Poland (1706) to peace agreements. However, after Swedish troops suffered a devastating defeat against the Russians at Poltava in 1709, both Denmark and Saxony-Poland re-entered the war. Between 1710 and 1716 the theatre of war shifted towards the Swedish territories in present-day northern Germany. Although initial attempts to take the Swedish strongholds along the northern German coast failed, the campaign gained impetus again when Prussia joined the alliance in 1714.

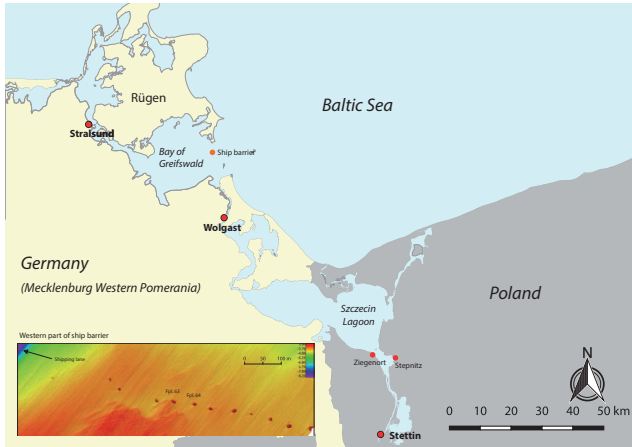
In May 1715, Swedish forces under Charles XII held Stralsund and Wismar, as well as Rügen and Usedom, and prepared for defence against the allies. Both sides were aware that control of Rügen and the Bay of Greifswald were the key to taking Stralsund. However, Charles XII was well prepared. The two entrances to the Bay of Greifswald, which were suitable for larger vessels, *Westertief* or *Neutief* and *Osttief*, were difficult to navigate at the best of times. The eastern passage could easily be covered by artillery from redoubts at Peenemünde and on the island of Ruden. The western passage was only partially covered by a battery on the southern tip of the island of Rügen.

In order to prevent the enemy from passing, the Swedes scuttled ships in the navigable channel and established the so-called

ship barrier (fig. 1). It is not known when exactly the ships were sunk, however, as the barrier is mentioned in historical sources from mid-July 1715 (Friedländer 1902, p. 343; Krüger, Schaake 2015, p. 278), it can be assumed that it was created earlier the same month. However, the barrier did not stop the allies. Guided by a renegade Swedish pilot named Peter Holländer, the Danish Admiral Sehestedt managed to thread his way through the western passage on September 25, 1715, and the Swedish navy was successfully attacked and defeated (Tuxen, With-Seidelin 1922, p. 160-162; Friedländer 1902, p. 388). Sehestedt's victory laid the foundation for the successful invasion of Rügen in November 1715 and finally also the fall of Stralsund on December 24, 1715.

After the events of 1715, the barrier remained in place. Reports from pilots in 1730 and 1734 show that it was considered a dangerous hazard to navigation (Dwars 1958, p. 21). It is unclear whether any salvage took place at all and the barrier remained charted until 1932, even though a new shipping channel, the *Landtief*, was in use from 1814 at the latest (Bierhals 1939, p. 18). The barrier was then forgotten until members of the local society for underwater archaeology (*Verein für Unterwasserarchäologie Mecklenburg-Vorpommern*) were made aware of its presence in 1995. Since then the barrier has been subject to a series of smaller surveys and excavations, with work intensifying in the planning phases for submarine power cables and the Nord Stream 1 gas pipeline (see, for example, Förster *et al.* 2002, p. 372; Scherer 2003; Schaake *et al.* 2012 and Belasus 2013).





**Fig. 1:** Location map of the site showing the Bay of Greifswald and the surrounding area with places mentioned in the text. In the inset, the locations of wrecks Mönchgut, Ostsee VII, Fpl. 63 and Fpl. 64 are indicated over multibeam data of the western part of the barrier (author J. Auer 2019).

Based on the current state of knowledge, the ship barrier consists of 15 sites, stretching from Ostsee VII, Mönchgut, Fpl. 81 in the west (115 m east of the *Landtief* shipping channel) over a distance of 838 m in a W / ESE direction to Fpl. 73 in the east. On the two outermost sites (Fpl. 81 and Fpl. 73), only stone mounds without any visible timbers were encountered. It is currently unclear whether these stone mounds are the remains of shipwrecks in the barrier. They do, however, stand out from the surrounding seabed and are aligned with the other wrecks in the barrier. Most of the 13 wreck sites, which form the main part of the barrier, consist of the lower hulls of medium-sized wooden vessels with keel lengths between 11.5 m and 20 m, which are covered by stones and boulders. While the distance between individual sites generally varies between 40 m and 60 m, there are noticeable gaps between site Fpl. 81 in the west and site Fpl. 80 (155 m) and between site Fpl. 79 and site Fpl. 46 (102 m). The state of preservation of individual wreck sites varies, as does the state of investigation (fig. 2).

## 2. EXCAVATING TWO SHIPS UNDER ROCKS

During the archaeological mitigation procedures for the Nord Stream 2 gas pipeline from Ust-Luga in Russia to Lubmin in the Bay of Greifswald, the ship barrier came into focus again. With avoidance not an option, it was decided to excavate two of the wrecks in the barrier, Mönchgut, Ostsee VII, Fpl. 63 and Fpl. 64, and to remove them from the seabed. Detailed recording of all individual timbers was to be conducted on shore before the wrecks were to be wet-stored in preparation for a later re-deposition near their original location.

The project was carried out by a team of up to 14 marine archaeologists from the state authority for culture and monuments in Mecklenburg-Western Pomerania (Landesamt für Kultur und Denkmalpflege Mecklenburg-Vorpommern) and took a total of three months.

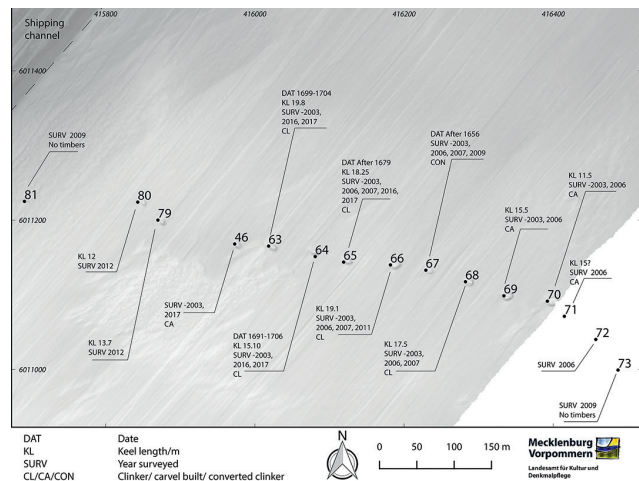
The team was based on a 27.7 m Multi Cat with two cranes and sufficient deck space for the dive control container and the recovered material. The shallow draught of the vessel allowed

for safe operations around the shipwrecks, which were located in only 3.5 m of water.

Timber recording took place in a temporary workshop, which was set up in the port of Lubmin in the Bay of Greifswald. Most of the diving was undertaken using surface air supply to full-face masks. As both wreck sites were covered by a mound of boulders up to 1 m high, the first phase of work entailed the removal of the stones (fig. 3). This was done manually in order not to damage the underlying timbers. A total of 74 tons of stones were recovered from both sites and lifted to the surface in big bags. Following the removal of the stone cover, the wreck timbers were carefully exposed with water dredges, labelled and subsequently removed. While ceiling planks could generally just be lifted up, as the wooden fasteners had deteriorated severely, frames had to be chocked up with plastic chocks. This created a gap of sufficient size to cut through the treenail joints with a handsaw. The timbers were then moved onto a dedicated cradle and lifted to the surface by crane. They were transported to the recording laboratory in the harbour, where wet-storage facilities in the form of 10 m × 15 m collapsible water basins were set up.

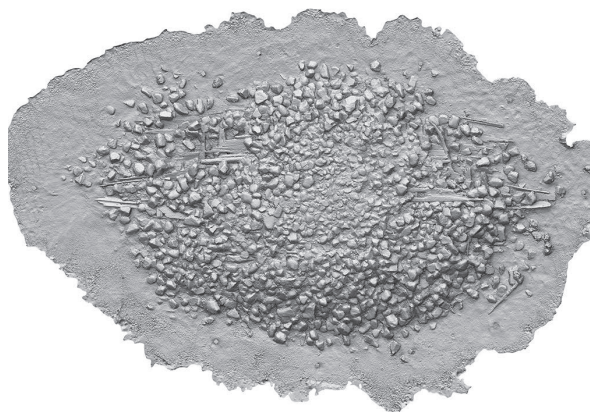
All underwater recording was done using computer vision photogrammetry. Depending on site conditions, data was either captured as high-resolution raw image files or 4K video footage. A network of control points around each site was used to align the different recording phases. After initial image enhancement, the photogrammetry reconstruction was done using Agisoft Photoscan Pro (now called Metashape Pro). Dense models and textures were generated in RealityCapture. Two-dimensional orthophotos and top view MatCap (Material Capture)<sup>1</sup> renders were used to visualise the wreck sites and served as a basis for the creation of technical site plans in 1:10 scale.

The detailed recording of ship timbers was done using a combination of structured-light scanning and computer vision photogrammetry. After cleaning and initial sampling, all ship timbers were recorded in detail using either an Artec EVA

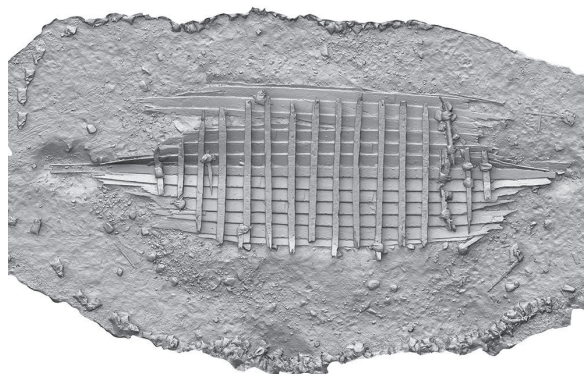


**Fig. 2:** Overview of the current state of knowledge on the ship barrier showing dendrochronological dating (DAT), keel length (KL), years of investigation (SURV) and construction type (Clinker (CL), Carvel (CA), Converted Clinker (CON)) (author J. Auer 2017).

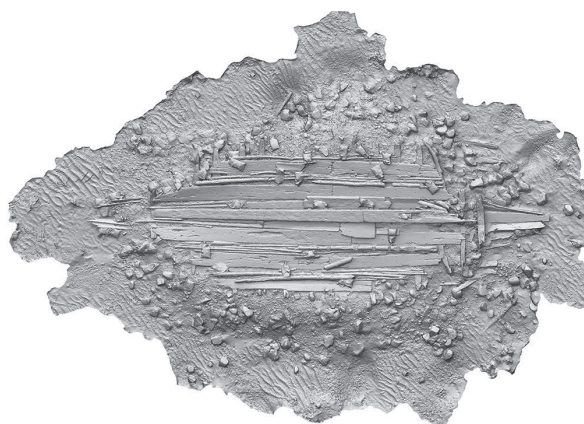
1. Material capture renders increase the three-dimensional impression of the scene and thus highlight small details.



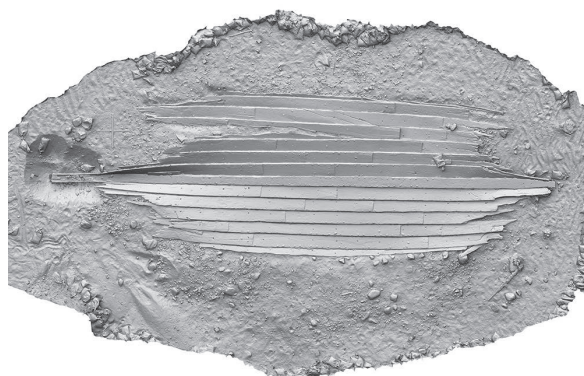
Stage 1: Before excavation



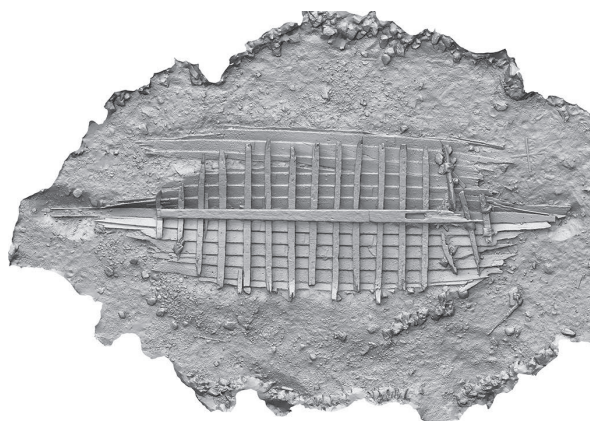
Stage 4: Framing



Stage 2: Ceiling planking



Stage 5: Outer planking



Stage 3: Keelson



Stage 6: Wreck fully removed

**Fig. 3:** Series of rendered images showing the sequence of excavation of wreck Fpl. 64 from the stone removal phase to full excavation and removal of the entire wreck (author J. Auer 2017, based on T. Van Damme 2017).

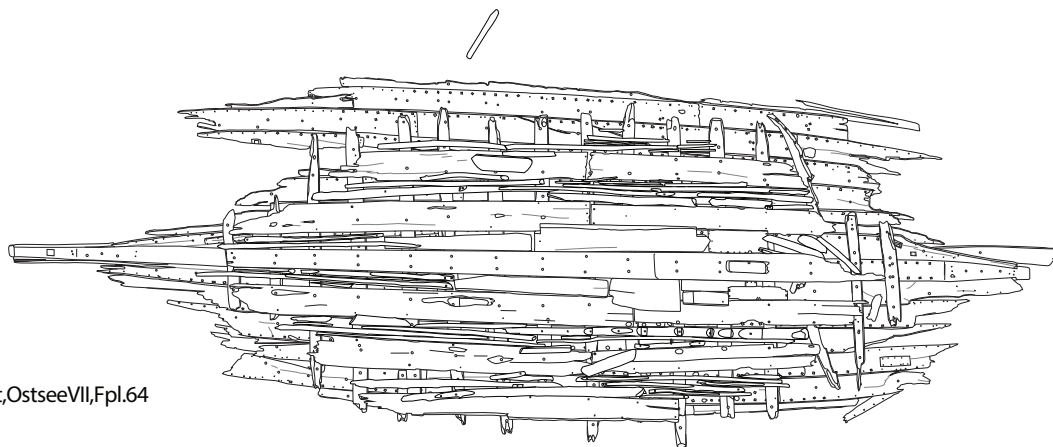
structured-light scanner or computer vision photogrammetry. With the timbers still present, the resulting scans were then annotated in the 3D modelling software Rhinoceros 3D. At the same time, a short catalogue description was compiled by the recorder. The description of each timber, as well as 2D outputs in the form of an annotated technical drawing and a textured image were then combined to form entries in the final timber catalogue (Auer *et al.* 2018, see also the paper of Thomas Van Damme in this volume for further information on this process).

### 3. THE SHIPS UNDER THE ROCKS

The two wreck sites were situated in the central part of the barrier at a depth of around 3.5 m. The slightly larger wreck, Mönchgut, Ostsee VII, Fpl. 63, was located approximately 40 m west of the smaller Fpl. 64. Both ships were lying on even keel mostly covered by large boulders and oriented with the bow facing west to southwest.



Mönchgut, Ostsee VII, Fpl. 64



0 1 2 3 4 5m

Mönchgut, Ostsee VII, Fpl. 63

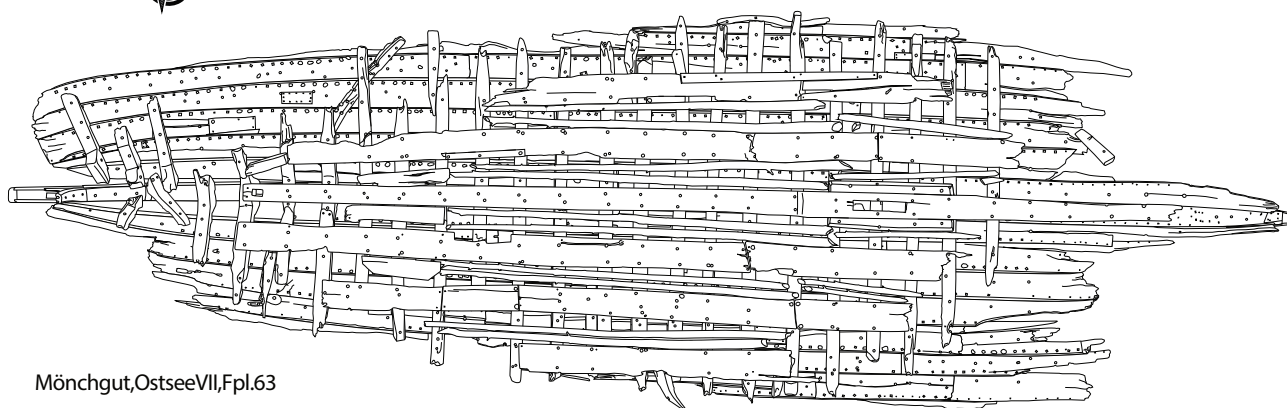


Fig. 4: Overview plans of wreck Fpl. 63 and Fpl. 64 with the ceiling in place (author M. Couwenberg 2017, based on tracings by M. Grabowski and T. Van Damme 2017).

Underneath the stone cover the ship timbers were preserved up to the turn of the bilge, while the rest of the vessel was lost to erosion. The preserved structure of both wrecks consists of an intact keel, outer planking, floor timbers and in a few cases the lower parts of futtocks, the keelson and a layer of ceiling planking (fig. 4).

Both ships were clinker built from oak. On the larger wreck Fpl. 63, the 19 m-long keel was composed of two parts which were joined with a flat diagonal scarf with vertical nibs. The keel of Fpl. 64 was heart-boxed from a single 15.1 m-long straight grown oak trunk. The keels differ slightly in shape but are generally fairly shallow<sup>2</sup>. Both keels display a considerable degree of hogging. The posts are not preserved, but rectangular mortises in the upper aft surface of both keels show that the sternposts were stepped onto the keel on both wrecks. Both, stem- and sternpost were supported by knees, which were fastened to the inboard surfaces of the keels with treenails.

The outer planks of both wrecks were sawn from oak. Planks within a strake were joined with long flat diagonal scarfs<sup>3</sup>, which were sealed with sphagnum and tar. Adjoining strakes were fastened to one another at the lands with square-shafted

iron clinker nails with round heads. The nails were clenched over rectangular roves on the inboard side. A mixture of animal hair and tar was used as waterproofing in the lands.

The substantial framing elements were either boxed or box-halved from compass oak. The frames were sawn out and the joggles on the outboard surface were cut with axes and adzes. The majority of the floor timbers on both sites were generously recessed to fit over the keel. Care was taken to leave enough space for the bilge water to pass through the gaps on either side of the keel. Only the forwardmost and aftmost floor timbers were positioned on top of the keel and feature pronounced limber holes. Floor timbers were evenly spaced at an average distance of 57 cm (Fpl. 63) and 66 cm (Fpl. 64). During construction, large iron nails were placed in roughly cut notches along the forward and aft surfaces of the floor timbers to keep them in place until they could be permanently fastened to the hull planking with treenails of 30 mm diameter. Some of the treenails extended to the ceiling planking and were secured with wedges on the inboard side. Only about one third of all treenails were secured with wedges on the outboard side.

The keelsons were preserved on both wrecks. On the larger Fpl. 63, the 13.89 m-long keelson was made from a single piece of heart-boxed oak and furnished with two mast steps. The keelson of Fpl. 64 is likewise made from oak. It is only preserved over a length of 9.7 m and has a single mast step cut into the inboard surface 1.1 m aft of the eroded forward end. Both keelsons were notched on

2. Fpl. 63: maximum sided dimension 34 cm, maximum moulded dimension 24 cm; Fpl. 64: maximum sided dimension 32 cm, maximum moulded dimension 20 cm.

3. The average length on Fpl. 63 is 75 cm, while the scarfs are on average 65 cm long on Fpl. 64.

the outboard side to fit over the floor timbers. The outboard face of the keelson was chamfered in the space between notches, likely to make access to the area below the keelson easier and to allow bilge water to flow freely from one side of the vessel to the other. The keelsons on both wrecks were fastened to the underlying floor timbers with blind treenails which did not penetrate into the keel. On wreck Fpl. 63 the main mast step was supported with two additional mast step supports on either side of the keelson.

The ceiling on both wrecks consisted of regular ceiling planks which were fastened to the floor timbers and loose timbers and roughly cut logs which were used to fill the gaps between the ceiling planks, probably in order to protect the hull structure from the weight of the stones which were piled into the hold of the vessel prior to scuttling.

Considering how the ships met their end, it is not surprising that very few artefacts were recovered during the excavation. One notable find, however, is a silver coin, a 1618 Pomerania-Wolgast Doppelschilling in the sternpost mortise on site Fpl. 64. The coin probably served as a token of good luck. The date range for the felling of the timbers used for the construction of the vessels was 1699-1704 (Fpl. 63) and 1691-1706 (Fpl. 64). The dendrochronological samples correspond best with tree-ring datasets for northern Germany, indicating that the construction timbers were sourced locally.

Even the brief overview of construction details in this section illustrates that although the two ships differ in size they show an interesting correspondence in construction, down to details such as the use of tools and practices of temporary fastening. It would therefore not seem unlikely that the same workforce was involved in the construction of both ships. To sum up, the two vessels, which were scuttled side by side, were clinker-built from oak timber sourced from northern Germany. Wreck Fpl. 63, the larger of the two ships, would have had a length of over 19 m and a beam of at least 5.7 m, likely more. The vessel was fairly flat-bottomed with a moderately fine entry and run, and a shallow, almost plank-like keel. The vessel was equipped with two masts, a main mast in the forward third of the ship and a smaller mizzen mast at the aft end of the keelson, only about 3.7 m from the aft end of the keel. The distribution of stones on top of the wreck does allow for some conclusions regarding the division of space or layout of the vessel. As there were hardly any stones on the forward part of the wreck, this area might have been covered by a half-deck and could have been the living quarters for the crew. The discovery of the remains of the ship's galley near the bow supports this assumption. Wreck Fpl. 64 was slightly smaller with a length of over 15.5 m and a beam of at least 5.2 m, probably almost 6 m. Just as Fpl. 63, it was flat-bottomed with a moderately fine entry and run. The keel was again fairly shallow, making the vessel suitable for use in shoal waters. Fpl. 64 only had a single mast in the forward third of the vessel.

Although designed for shallow water, both ships would have been capable of navigating the open sea as well. Size and construction point to a use as merchant vessels for the coastal and Baltic trade.

#### 4. TIMBER TRADERS FROM SZCZECIN LAGOON?

Thus we have the archaeological evidence: questions however remain as to how the ships to be scuttled were chosen by the Swedes and what they were originally built and used for.

According to historical sources, two of the wrecks in the barrier were from Ziegenort (today Trzebież) in Pomerania on the western shore of Szczecin Lagoon and were used in the timber trade between western Pomerania and Copenhagen (Bierhals 1941, p. 24). In documents in the National Archives in Copenhagen, seven of the scuttled ships are described as galiots (Krüger, Schaake 2015, p. 281), however, as ship types were hardly ever clearly defined in the 18<sup>th</sup> century and terms such as galiot were used liberally for a wide range of vessels of differing size, rigging and construction, this denomination does not help with the characterisation of the ships in question. Nevertheless, the mention of Ziegenort as the home port of two of the scuttled vessels provides an interesting pointer. In his article on rural shipping in Pomerania (Bierhals 1941), Paul Bierhals describes the shipping activities of rural shipowners in the area around Szczecin Lagoon, both in the Swedish part on the western shore and in the Brandenburg part along the eastern shore. According to Bierhals, there was a rise in the construction of larger vessels in the villages around Stepenitz (today Stepnica) after this area came under Brandenburg control as a result of the Scanian War in 1679. The main reason seems to have been the profitable timber export trade, mostly to Copenhagen.

With prices for timber increasing, this trade expanded further in the 1690s. A complaint from the city of Stralsund from 1692 allows this timber exportation to be quantified. The city was in dire need of construction timber. In the complaint, records from the city of Wolgast are cited to prove that timber was being exported to Denmark rather than being sold in Stralsund. In the years 1689-1697, a total of 567 ships with a cargo of timber were cleared to sail abroad, mostly to Copenhagen (Bierhals 1941, p. 23). Many of these ships came from the villages around Szczecin Lagoon, not only from areas under Brandenburg control, such as Stepenitz, but also from villages in Swedish Pomerania, such as Ziegenort. The trade was in fact so lucrative that many rural villages, which did not have the right to build larger vessels, started to construct ships solely for the timber export. A complaint from the city of Stettin (Szczecin) mentions the construction of more than 100 ships of 60 to 100 last in the years 1696-1702, all built for the Copenhagen timber trade in villages around Szczecin Lagoon. Even Swedish embargoes did not stop the timber export, which continued with few interruptions until the Great Northern War reached Pomerania again in 1715.

Although the connection between the Pomeranian timber trade and the wrecks in the barrier relies on a single historical source stating that two ships from Ziegenort were scuttled in the *Westtief* in 1715, the archaeological evidence is consistent with the limited historical data available on provincial timber traders from Szczecin Lagoon. Fpl. 63 and Fpl. 64 were both clinker-built and fairly flat-bottomed sailing vessels of a size comparable to the larger clinker vessels mentioned by Bierhals. The larger vessel Fpl. 63 had at least a half-deck and two masts, while the smaller Fpl. 64 could have been open. Both vessels were built from northern German or western Polish timber. The link to the area is further reinforced by the coin from Pomerania-Wolgast in the mast step of Fpl. 64.

Altogether, the two wrecks under the rocks provide an interesting archaeological insight into the construction of small local and possibly rural merchant vessels in Pomerania at the end of the 17<sup>th</sup> century.



## REFERENCES

- AUER J., GRABOWSKI M., VAN DAMME T.  
 2018 *Excavation and recovery of wrecks Ostsee Bereich VII, Mönchgut Fpl. 63 (7070) and Fpl. 64 (7071) and in situ protection of wreck Fpl. 65 (7072). Archaeological Diving Operation, Ref. 3544-5409.01*, Schwerin, Landesamt für Kultur und Denkmalpflege.
- BELASUS M.  
 2013 *The Great Northern War underwater: A Swedish ship barrier of 1715 in Northeast Germany*, in N. Mehler (ed.), *Historical Archaeology in Central Europe*, Rockville, Society for Historical Archaeology.
- BIERHALS P.  
 1939 'Jasmundstein' und 'Neues Tief', *Monatsblätter der Gesellschaft für Pommersche Geschichte und Altertumskunde* 53, p. 16-18.  
 1941 Zur Geschichte der bäuerlichen Schifffahrt in Pommern vom 16. bis 18. Jahrhundert, *Monatsblätter der Gesellschaft für Pommersche Geschichte und Altertumskunde* 55, p. 16-25.
- DWARS F.-W.  
 1958 Der angebliche Landzusammenhang zwischen Rügen und dem Ruden in historischer Zeit und die Entstehung der Einfahrten am Ostrand des Greifswalder Boddens, *Baltische Studien Neue Folge* 45, p. 9-26.
- FÖRSTER T., KRÜGER J., SCHERER T.  
 2002 *Die schwedische Schifffsperrre von 1715 – Taucharchäologische Untersuchungen im Greifswalder Bodden*, in U. Masemann (ed.), *Forschungen zur Archäologie und Geschichte in Norddeutschland, Festschrift für Wolf-Dieter Tempel zum 65 Geburtstag*, Rotenburg, Selbstverlag der Archäologischen Gesellschaft im Landkreis Rotenburg (Wümme) e.V., p. 371-388.
- FRIEDLÄNDER E. (ED.)  
 1902 *Berliner geschriebene Zeitungen aus den Jahren 1713 bis 1717 und 1735*, Berlin, Verlag des Vereins für die Geschichte Berlins.
- KRÜGER J., SCHAAKE K.  
 2015 *Wrecks of the Great Northern War near the island of Rügen*, in R. Bleile, J. Krüger (eds), *'Princess Hedvig Sofia' and the Great Northern War*, Schleswig, Sandstein Verlag, p. 271-281.
- SCHAAKE K., KRÜGER J., GÖHLER R.  
 2012 A Swedish barrier of sunken ships from 1715, *Skyllis: Zeitschrift für maritime und limnische Archäologie und Kulturgeschichte* 12.2, p. 148-154.
- SCHERER T.  
 2003 *Vier untersuchte Klinkerschiffe einer schwedischen Schifffsperrre von 1715 im Greifswalder Bodden*, Master Thesis Bamberg, Otto-Friedrich-Universität Bamberg.
- TUXEN A.P., WITH-SEIDELIN C.L.  
 1922 *Erobringen af Sveriges tyske Provinser 1715–1716*, Copenhagen, Gyldendalske boghandel, Nordisk forlag.

# SEWN-PLANK CONSTRUCTION TECHNIQUES IN THE WESTERN INDIAN OCEAN: EVIDENCE FROM THE TIMBERS OF AL BALEED, OMAN

Alessandro GHIDONI

---

## Abstract

The boat timbers discovered in the Islamic port of Al Baleed in southern Oman constitute a unique collection within the context of the Indian Ocean's maritime technology between the 10<sup>th</sup> and 15<sup>th</sup> centuries AD (Belfioretti, Vosmer 2010). The timbers consist of planks from sewn-boats that have been recycled in the site's buildings, and include preserved ropes, caulking material and decorative motifs. A study of the remains reveals a variety of forms, techniques and materials used for the construction of the sewn vessels involved in Indian Ocean maritime trade during the Middle Islamic period.

## Keywords

Al Baleed, Indian Ocean, Islamic ships, maritime technology, sewn-plank construction

## Abstract

Les bois de bateau découverts dans le port islamique d'Al Baleed, dans le sud d'Oman, constituent une collection unique dans le contexte de la technologie maritime de l'océan Indien entre le x<sup>e</sup> et le xv<sup>e</sup> siècle apr. J.-C. (Belfioretti, Vosmer 2010). Les bois proviennent de bordés de bateaux cousus qui ont été recyclés dans les bâtiments du site et qui présentent encore leurs coutures, du matériel de calfatage et des motifs décoratifs. L'étude des vestiges révèle une grande variété de formes, de techniques et de matériaux utilisés pour la construction des navires cousus impliqués dans le commerce maritime de l'océan Indien pendant la période islamique moyenne.

## Mots clés

Al Baleed, océan Indien, navires islamiques, technologie maritime, bateaux cousus

Archaeological excavations at the Islamic site of Al Baleed have brought to light numerous ships' timbers dating to the medieval period (Belfioretti, Vosmer 2010). The site, facing the Arabian Sea and located near the modern city of Salalah, southern Oman, was an important maritime trading centre in the Indian Ocean during the 11<sup>th</sup>-16<sup>th</sup> centuries AD (Zarins 2007, p. 316). Called Zafar in historical sources, Al Baleed was renowned for exporting Arab horses to India and for the production and trade of frankincense (Zarins, Newton 2017, p. 65-66; Costa 1979, p. 111).

Following the preliminary study by Belfioretti and Vosmer (2010) of five timbers discovered between 2006 and 2009, recent archaeological excavations, which resumed in 2016, have brought to light more ships' remains, raising the number in the collection to over 50 specimens. Overall, the timbers discovered at Al Baleed exhibit the distinctive features of the western Indian Ocean sewn-plank technique: continuous sewing through holes drilled along the edge of the planks, fibre cordage, dowels, decoration and luting material (Prins 1986, p. 100, 163). The timbers were removed from sewn watercraft that sailed off the coast of Al Baleed during the 10<sup>th</sup>-15<sup>th</sup> centuries and reused as structural components, such as lintels, shelves, beams and ceilings in the buildings of Al Baleed's citadel (*husn*).

## 1. SEWN-BOATS OF THE INDIAN OCEAN

Knowledge of vessels that sailed the Indian Ocean during the pre-modern Islamic era (622-1500 CE) is still relatively limited and mostly relies on textual descriptions of European, Arab and

Chinese travellers who journeyed through the region during this period. Their accounts are unanimous in describing sewing as the primary fastening method of western Indian Ocean ships (Procopius, *Bell. Pers.* I, 19, 23-25, translated by Dewing 1914, p. 183; Mookerji 1912, p. 31; Moreland 1939, p. 66-74; Prins 1986, p. 66-67; Agius 2008, p. 161), but are often vague and provide little details. References to sewn vessels appear as early as the 1st century AD when they were recorded in Azania (East Africa) and Omana, along the Makran coast, by the anonymous author of the *Periplus Maris Erythraei* (Casson 1989, p. 63, 141).

In the 9<sup>th</sup> century, the geographer Al-Ya'qubi stated that sewn ships sailed the long journey from Ubulla to China (Agius 2008, p. 162), while a century later, the historian Al-Masudi describes Abyssinian watercraft that were fastened with fibre ropes (De Meynard, De Courteille 1861, p. 365).

Later, in the 13<sup>th</sup> and 14<sup>th</sup> centuries, accounts of missionaries, merchants and travellers supply further descriptions of sewn-plank vessel construction in the region. Marco Polo provides one of the most detailed, but also the most dismissive account of sewn boats used by the merchants of Hormuz (Moule, Pelliot 1938, p. 36). During the same period, Ibn Battuta describes the process of making the coir ropes that were used as fastening cordage in the hulls of boats in Yemen (Agius 2008, p. 163).

A transition in fastening techniques, from sewn to nailed construction, is generally assumed to have gradually taken place from the 16<sup>th</sup> century, following Portuguese expansion in the Indian Ocean (Johnstone, Muir 1962; Moreland 1939, p. 179; Hourani 1963, p. 93). However, references to sewn watercraft in the region continue well into the 20<sup>th</sup> century (Foster 1949, p. 73; Markham 1877, p. 6; Pâris 1843; Villiers 1952, p. 40).

Iconography is also scarce and consists of a few stylised images of vessels, the most famous of which are the 13<sup>th</sup>-century illustrations from the *Maqamat Al-Hariri* (Hourani 1963, p. 8, fig. 7; BNF, MS Arabe 5847).

To date, archaeological work related to sewn boats has also been relatively limited. The most relevant is the 9<sup>th</sup>-century Belitung shipwreck, which Michael Flecker surveyed for six weeks during salvage operations in 1999 (Flecker 2000, 2010). In Egypt, a few Islamic sewn-ships' timbers were discovered during the excavation of the medieval necropolis of Quseir al-Qadim, in 1999–2003 (Blue 2006; Blue *et al.* 2011). In addition, a recently discovered wreck in Thailand, known as the Phanom-Surin wreck, promises to provide interesting information, but excavations have currently been stopped and very little has been published (Guy 2017; Jumprom 2014; 2019).

## 2. DESCRIPTION OF THE TIMBERS

One of the most significant bodies of evidence in Oman, which has previously received little attention, is the collection of timbers at the site of Al Baleed. These consist of over 50 remains, 36 of which have been identified as hull planks.

None of the planks in the Al Baleed collection is entirely preserved. Their surviving length ranges between 230–2500 mm with the major part (79%) measuring between 500–800 mm. Planks Wo98A, Wo98B and Wo98C are the longest and are located in the eastern wall of the citadel where they were re-used in the locking system of the gate. Unfortunately, no accurate measurement could be made due to limited access, but the estimated length of the recess in the wall is 3.4 m (Belfioretti, Vosmer 2010, p. 115). Only two timbers have preserved one of their original ends, entirely in the case of BA0604128.73 and partially in Wo86. BA0604128.73 is a portion of a composite assemblage of three planks sewn together (Belfioretti, Vosmer 2010, p. 114). These planks, which are on the same strake, are connected at their edges with a plain scarf at an angle of 167° with a blunt shoulder (nib) at one of its ends. Timber Wo86 is the only other sample of the dataset displaying one end forming an angle of 152° with the plank's edge (fig. 1a). The overall thickness range of the Al Baleed planks is between 22–59 mm. Planks between 20–30 mm and 40–50 mm thick are the most common, with 11 samples (28%) each.

Only ten planks in the collection have retained both edges, and they have a width of between 90–303 mm. The remaining planks, which have either only one edge preserved or no original edges at all, range between 60–285 mm in width. They were probably cut prior to reuse in the citadel, or they had gone through a process of deterioration.

### 2.1. PLANK-TO-PLANK SEWING HOLES

Holes in planks can be distinguished between those drilled along the edges, which are used in plank-to-plank sewing, and those in the centre, which are used for frame lashing. The diameter of plank-to-plank sewing holes often varies both between planks and within the same plank, and measures between 6 and 15 mm. The majority of the planks (78%: 28 planks) have holes between 10 and 13 mm in size, with 12 mm being the most common (22%: eight planks). Spacing between holes ranges

between 32 and 113 mm. Fifteen planks, representing 42% of the collection, have holes 70–80 mm apart, and their distance from the edge of a plank can vary considerably. Wo82 displays the longest distance, at around 70 mm, while the closest holes to the edges are those on BA1104065.450 and BA1104065.454 with a 14 mm average.

Planks can be distinguished between those exhibiting rebates small channels on one of their surfaces, which are associated with the sewing holes (fig. 1a), and those without such rebates, illustrated by BA01.11.01 (fig. 1b). Rebates are carved perpendicularly from the holes to the edge of the plank in 31 planks (86%), and stitching ropes and fibre are still visible recessed in them. Their width is always smaller than the hole diameter and ranges between 3 and 10 mm. The average depth of the rebates can also vary significantly within the timbers, measuring between 4 and 19 mm. Wooden pegs, used for plugging the sewing holes and locking the cordage ropes in place, are preserved in many of the timbers (72%: 26 planks).

### 2.2. SEWING TECHNIQUE

Two timbers (BA0604128.73 and BA0604128.74) retain portions of sewing, providing information about the fastening technique, technology and materials (fig. 2). The sewing cord used in plank BA0604128.73 consists of three ropes with a diameter of 4 mm. The cordage is threaded through matching holes drilled along the edge of adjacent planks in continuous sewing. On one side, the sewing cord is recessed in rebates carved between the holes and the edge of the plank, forming a pattern of vertical disconnected stitches (IIII). On the opposite side, a thick caulking roll (wadding) is firmly compressed over the seams of the planks by a series of vertical and crisscross stitches (IXIXIXI). The wadding, measuring 43–54 mm in width and 12–16 mm thick, is made of approximately 20 ropes running longitudinally along the plank seam.

### 2.3 FRAME-LASHING HOLES

Twenty-five of the Al Baleed timbers display patterns of holes in the centre of the plank between the two rows of plank-to-plank sewing holes (fig. 3). These are drilled perpendicular to the plank's surface and are arranged in pairs aligned transversally to the plank's length. The holes are generally connected by vertical rebates and always share the same timber's surface with the recesses of the sewing holes along the edge, and occasionally display ropes and fibres *in situ*. The hole diameter varies between 6 and 20 mm, with 11–12 mm, the most frequent, being observed in 14 planks (56%). The distance between all the closest pairs of holes ranges between 36 mm, recorded in BA1104065.454, and 215 mm displayed on Wo63. The most common distance is between 81 and 100 mm (40%: ten specimens). The distance between these sets of holes ranges between 373 mm in Wo83 and 55 mm in BA01.11.01, with the most significant number (30%) between 143 and 171 mm.

### 2.4. DOWELS

The vast majority of the planks (89%: 31 timbers) display dowels or their channels on the plank's edge. These were driven

obliquely from the outside of one plank into the adjacent one through their faying edges. Their ends, protruding from each side of the hull, were cut flush with the plank's surface. The diameter of the dowels varies between 5 and 22 mm, with 11 mm being the most frequently observed in 16 dowels (21%).

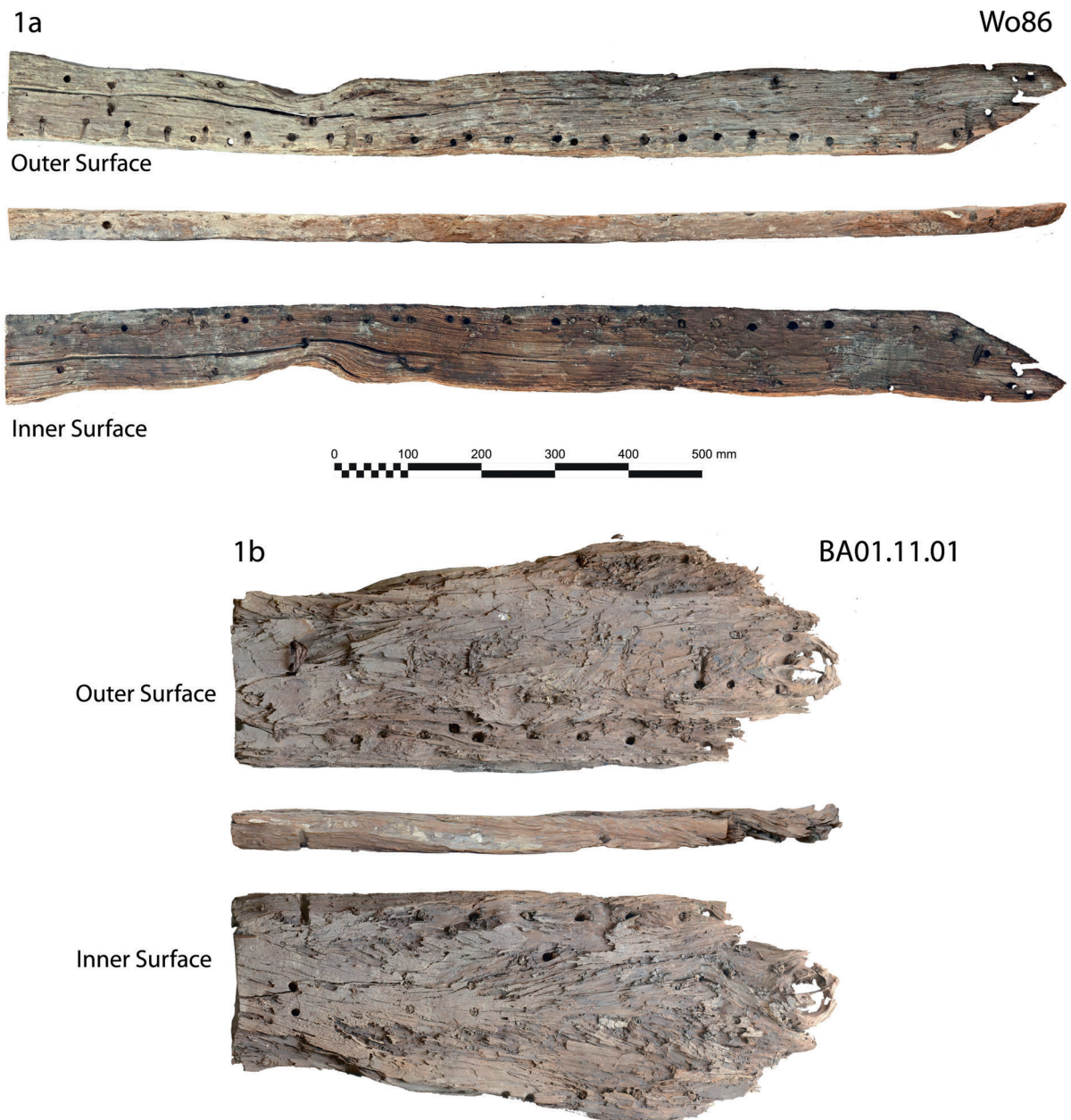
## 2.5. SUBSTANCES

Traces of a black substance are visible on 14 planks (41%), and usually located on the faying edge of the timbers and between the stitching holes and the edge of the planks on the surface without rebates. In a few cases, this material was smeared on both the whole surfaces of the planks. The best examples are

BA1104065.454 and BA0604145.175, which have a thickness ranging between 2 and 5 mm (fig. 4). Chemical analysis carried out by Dr Jacques Connan at the Laboratoire de Géochimie Bioorganique Louis Pasteur, University of Strasbourg, confirmed the identification of the substance extracted from seven planks as bitumen (Belfioretti, Vosmer 2010, p. 113; Jacques Connan, personal communication 02/04/19).

## 2.6. MATERIALS

Species identification analysis carried out on 11 samples reveals a variety of materials including teak (*Tectona grandis*), palm (*Palmae*: species unspecified), *Terminalia* Sp., *Ziziphus*



**Fig. 1:** A) Timber Wo86 displaying holes evenly spaced along the edge of the plank associated with rebates, and an oblique end. B) Timber BA01.11.01 showing sewing holes without rebates.



BA0604128.73

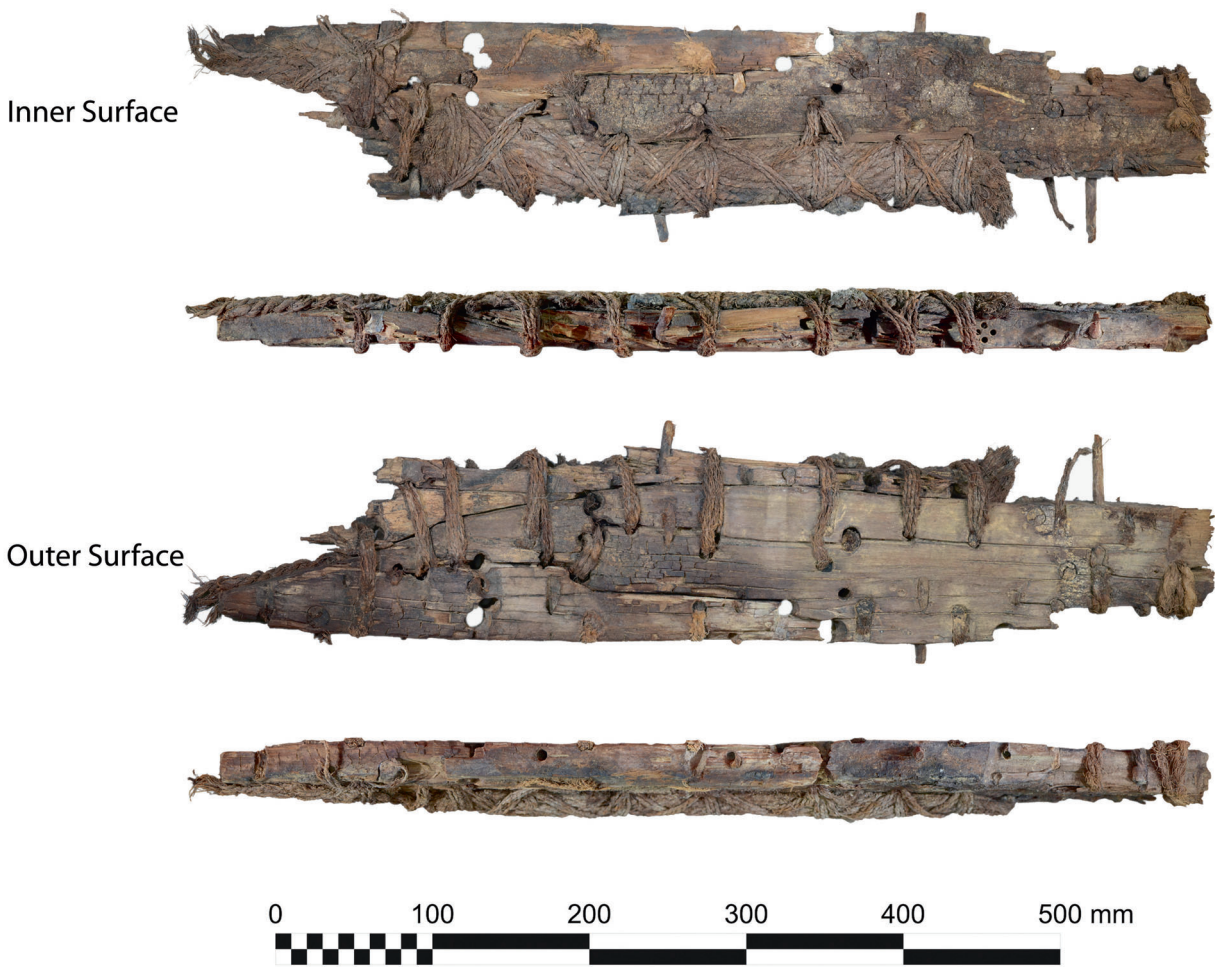


Fig. 2: The section of the sewing preserved on timber BA0604128.73.

*mauritania* (jujube) and *Leguminosae Cisalpinaceae* for the planking, with the cordage material resembling coconut fibre (*Cocos nucifera*) (Belfioretti, Vosmer 2010, p. 111-112; Capretti *et al.* 2010).

### 2.7. DATING THE TIMBERS

Fourteen timbers have been radiocarbon dated by Beta Analytic Radiocarbon Dating Laboratory, Miami, Florida, showing a period between the 10<sup>th</sup> and 15<sup>th</sup> centuries AD (Belfioretti, Vosmer 2010, p. 114). Interestingly, the planks without rebates appear to be the earliest of the dataset and do not occur after the first quarter of the 13<sup>th</sup> century (Vosmer 2017, p. 199).

### 3. DISCUSSION

Traditional boatbuilding techniques have persisted in the Indian Ocean and ethnographic studies have provided

information on more modern sewn-plank boats of the region, e.g. Yemen, Somalia, East Africa, India and Oman. Recent sewn watercraft allow the identification of the Al Baleed timbers as ships' planks and offer insight into the interpretation of their features.

The first noticeable characteristic is the continuous sewing technique, as indicated by the holes spaced along the edges of the planking and by two planks displaying part of the sewing. The presence of fibre cordage, most likely coir, finds confirmation in historical sources, which are unanimous in describing it as the material used to hold planks together. However, despite mentioning the presence of sewn vessels in the region, textual sources provide very little detail regarding the fastening technique. The closest reference to continuous sewing is reported by the missionary Friar John of Montecorvino in the 14<sup>th</sup> century, who remarked that the ships of the Arabian Sea were "sewn like clothes" (Yule 1914, p. 66).

Analysis of timber features suggests two types of sewing patterns. Planks with rebates indicate the most commonly recorded in the western Indian Ocean, a technique consisting of wadding under the stitching on the inside of the hull, and ropes recessed in rebates on the other side. This sewing method is ubiquitous

Wo54

Outer Surface



Frame Lashings



Inner Surface



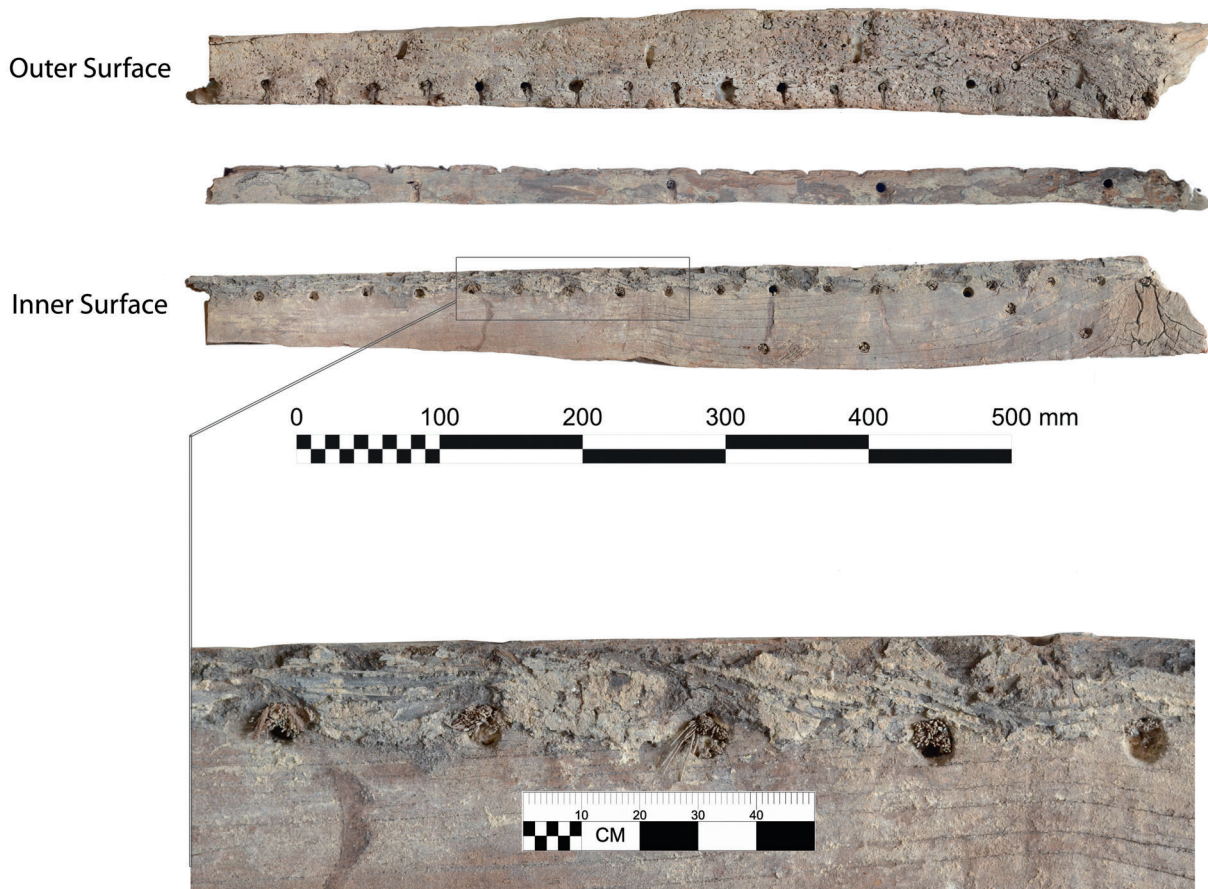
Fig. 3: Timber Wo54 with series of vertical stitches in the centre of the plank's outer surface, indicating frame lashings.

in the western Indian Ocean and recorded in sewn boats from Oman (Pâris 1843, pl. 8; Vosmer 1997, p. 232-234), Yemen (Bowen 1952, p. 205; Prados 1996, p. 102), Somalia (Chittick 1980), East Africa (Hornell 1941, p. 60; Prins 1982, p. 94-98) and India (Varadarajan 1998, p. 58-60; Shaikh *et al.* 2012, p. 152-153). Since rebates are generally found outboard on recently built sewn vessels, with the purpose of protecting the sewing cordage against chafe (Prins 1986, p. 89; Severin 1985, p. 283), the surface with rebates on the timbers from Al Baleed would likely indicate the outside of the hull. Unfortunately, the planks are all straight and show no curvature that might help to determine the outer surface. This is due to their short length, rarely exceeding 1 m, and, perhaps, because the builders of the site of Al Baleed intentionally chose flat and straight timbers more suitable for being recycled as ceiling planks or shelves in the buildings of the site. A few planks of the dataset display the small tunnels created by shipworms (*Teredo navalis*) on the same surface displaying the rebates, further strengthening the hypothesis that these were carved outboard.

Planks without rebates point to a different sewing method, and although the relevant timbers have no preserved portions of stitching, the lack of rebates suggests the presence of the wadding above the seam of the planking on both sides of the hull, which is known as a double-wadding pattern (Vosmer 2017, p. 200) or double web (Kentley 2003, p. 163). This pattern was observed on the 9<sup>th</sup>-century Belitung wreck, discovered in Indonesia and interpreted as an Arab/Indian/Persian vessel (Flecker 2000). The fact that planks without rebates are earlier than those with rebates might hint at a development from the double-wadding to the single-wadding technique (Vosmer 2017, p. 200).

Another distinctive feature of the Al Baleed timbers is the presence of dowels, which underlines their primary role in sewn-plank construction in the Indian Ocean. Usually spaced evenly apart, they served the purpose of aligning and locking the planks into place during the assembling of the hull. Dowels were also employed to reduce longitudinal movement of the planks caused by hogging of the hull, which could result in water leakage (Coates 1985, p. 18).





**Fig. 4:** Timber BA1104065.454 with traces of bitumen between the sewing holes and the edge on the inside of the plank. The bitumen luting bore the impressions of the vegetal material used for the wadding, composed of grass or leaves.

There are no frames in the Al Baleed collection of timbers, however, sets of holes drilled at the centre of planks point to their lashings and provide information regarding their size (sided dimension) and spacing. Overall, frames have a variety of thicknesses ranging from 36-210 mm and are spaced between 55 and 373 mm apart, which points to light framing that is widely spaced, reveals the flexible nature of a sewn vessel, and highlights the importance of other elements, such as the sewing, dowels and beams, in providing structural integrity to the hull. By describing the ships he observed in Cananor (Kannur), southern India, in the 16<sup>th</sup> century, Correa reports the only reference to frames in historical sources, stating these vessels had only a few ribs sewn to the hull (Stanley 1869, p. 240).

Traces of a bituminous amalgam, and perhaps other substances such as resin, on the edge and surface of the timbers indicate the practice of luting and coating the hulls of vessels. Ancient boatbuilders smeared bitumen on the edge of the planks to seal the seams and waterproof the hull. Correa described this practice in the 16<sup>th</sup> century in the construction of Indian vessels (Stanley 1869, p. 241), and it is still employed today using resin by builders of the sewn-plank boats of Goa (Shaikh *et al.* 2012, p. 152).

Bitumen on both the inner and outer surfaces of the timbers suggests that the vessels were coated to protect them against

marine pest organisms, such as shipworms (*Teredo navalis*) and barnacles, as well as to improve the watertightness of the hull.

As remarked by Belfioretti and Vosmer (2010, p. 116), a comparison with archaeological and ethnographic data provides an opportunity to speculate on the size of the ships from which the timbers had been removed. Several planks from Al Baleed exceed the thickness of 40 mm recorded in the Belitung shipwreck, which had an estimated length of 20-22 m (Flecker 2000, p. 205, 209). Thinner planks (20-30 mm) could have been employed in 8-10 m sewn boats, similar to Omani *kambāri* (Vosmer 1997), Somali *beden* (Chittick 1980) or the sewn *sanbuq* of Yemen (Prados 1996; Bowen 1952). The evidence from Al Baleed may indicate a variety of vessel sizes ranging from large cargo ships, measuring 20 to 30 m, to small coastal fishing and lightering vessels, ranging from 6 to 10 m in length.

#### 4. CONCLUSION

In light of still-limited information yielded by other archaeological evidence, the study of the Al Baleed timbers reveals interesting insights into Indian Ocean maritime technology in the medieval Islamic period. On the one hand, the timbers share

similarities with archaeological evidence and 19<sup>th</sup>-20<sup>th</sup> century of sewn boats recorded in the region, while, on the other, they reveal a variety of forms and techniques.

Although the timbers themselves cannot confirm what the vessels looked like or give any indication of either their cargo or their route, their features provide a wealth of information about different sewn boats and boatbuilding technologies over a considerable period, allowing speculation about evolutionary trends in construction techniques and technology.

The advantage of a collection of planks from different vessels covering a period of more than 500 years, such as that from Al Baleed, is that they offer a chance to identify building materials. Future wood identification analyses may furnish hints about the origin of the vessels, possible connections between the materials used and construction techniques, and boat size or function. Variations in wood species used for boat construction over time can offer exciting insights regarding material trade, furthering deepening understanding of fundamental maritime connections in the Indian Ocean during this period.

## ACKNOWLEDGEMENTS

I am thankful to H.E. Abdul-Aziz bin Mohammed Al Rowas, Adviser to His Majesty the Sultan for Cultural Affairs for providing the opportunity to study the timbers from Al Baleed, and to all his staff, particularly Dr Said al-Salmi and Hassan al-Jaberi for their support in Muscat, and to Ghanem Al Shanfari and Ali al Kathiri for their assistance at the Museum of Frankincense Land in Salalah, where the timbers are stored. I would like to thank IASA (International Association for the Study of Arabia, former British Foundation for the Study of Arabia) and the Barakat Trust for providing financial support to my research with the Small Research Grant and the ŞADAQA JĀRIYA grant. A special thanks is due to Alexia Pavan, director of the excavation in Al Baleed, for her help and generosity in sharing the information regarding the context of the timbers. Finally, I am extremely grateful to Tom Vosmer and Eric Staples for their invaluable comments and advice about the maritime technologies, traditions and history of the Indian Ocean.

## REFERENCES

- AGIUS D. A.  
2008 *Classic Ships of Islam – From Mesopotamia to the Indian Ocean*, Amsterdam, Brill, Handbook of Oriental Studies Section 1 – The Near and Middle East 92.
- BELFIORETTI L., VOSMER T.  
2010 Al-Balid Ship Timbers: Preliminary Overview and Comparisons, *Proceedings of the Seminar for Arabian Studies* 40, p. 111-118.
- BLUE L.  
2006 Sewn Boat Timbers from the Medieval Islamic Port of Quseir al-Qadim on the Red Sea Coast of Egypt, in L. Blue, F. Hocker, A. Engler (eds), *Connected by the Sea, Proceedings of the Tenth International Symposium on Boat and Ship Archaeology (Roskilde 10), Roskilde 2003*, Oxford, Oxbow Books, p. 598-610.
- BLUE L., WHITEWRIGHT J., THOMAS R.  
2011 Ships and Ships' Fittings, in L. Blue, D. Peacock (eds), *Myos Hormos – Quseir al-Qadim, Roman and Islamic ports on the Red Sea, volume 2: Finds from the excavation 1999-2003*, Oxford, Archaeopress, University of Southampton, Series in Archaeology 6, BAR International Series 2286, p. 179-209.
- BOWEN R. L. J.  
1952 Primitive Watercraft of Arabia, *The American Neptune* 12, p. 186-221.
- CAPRETTI C., GIACHI G., MACCHIONI N.  
2010 *Determination of Species of archaeological Wood Samples from al-Balid*. Unpublished report, Office of the Adviser to His Majesty the Sultan for Cultural Affairs, Sultanate of Oman.
- CASSON L.  
1989 *The Periplus Maris Erythraei*, Princeton, Princeton University Press.
- CHITTICK H. N.  
1980 Sewn boats in the western Indian Ocean, and a survival in Somalia, *IJNA* 9.4, p. 297-309.
- COATES J.  
1985 Some structural models for sewn boats, in S. McGrail, E. Kentley (eds), *Sewn Plank Boats: Archaeological and Ethnographic Papers Based on those Presented to a Conference at Greenwich in November, 1984*, Oxford, BAR International Series 276, p. 9-18.
- COSTA P.  
1979 The study of the city of Zafar, *Journal of Oman Studies* 5, p. 111-150.
- DEWING H. B.  
1914 *Procopius, History of the Persian Wars*, Book I, London, Heinemann.
- FLECKER M.  
2000 A 9<sup>th</sup>-century Arab or Indian shipwreck in Indonesian waters, *IJNA* 29.2, p. 199-217.  
2010 A Ninth-Century Arab Shipwreck in Indonesia, in R. Krahl, J. Guy, J.K. Wilson, J. Raby (eds), *Shipwrecked. Tang Treasure and Monsoon Winds*, Washington, Smithsonian Books, p. 101-119.
- FOSTER W.  
1949 *The Red Sea and Adjacent Countries at the Close of the Seventeenth Century as Described by Joseph Pitts, William Daniel and Charles Jacques Poncet*, London, Hakluyt Society.
- GUY J.  
2017 The Phanom Surin Shipwreck, a Pahlavi Inscription, and their Significance for the History of Early Lower Central Thailand, *Journal of the Siam Society* 105, p. 179-196.
- HORNELL J.  
1941 The Sea-going Mtepe and Dáu of the Lamu Archipelago, *The Mariner's Mirror* 27.1, p. 54-68.
- HOURLANI G. F.  
1963 *Arab Seafaring in the Indian Ocean in Ancient and Early Medieval Times*, Beirut, Khayats.



- JOHNSTONE M. T., MUIR J.  
1962 Portuguese Influences on Shipbuilding in the Persian Gulf, *The Mariner's Mirror* 48.1, p. 58-63.
- JUMPROM J.  
2014 The Phanom Surin Shipwreck: New Discovery of an Arab-style Shipwreck in Central Thailand, *Southeast Asian Ceramics Museum Newsletter* VIII, p. 1-14.  
2019 Recovery of a Lost Arab-styled Ship at Phanom-Surin, the Wetland Excavation Site in Central Thailand, in S. A & W. Giessler (eds.), *Ancient Maritime Cross-cultural Exchanges*, Bangkok, Fine Arts Department, p. 226-247.
- KENTLEY E.  
2003 The *masula* – A sewn plank surf boat of India's Eastern Coast, in S. McGrail (ed.) *Boats of South Asia*, New York, Routledge, p. 120-166.
- MARKHAM C. R.  
1877 *The Voyages of Sir James Lancaster to the East Indies*, London, Hakluyt Society.
- DE MEYNARD C. B., DE COURTEILLE P.  
1861 *Maçoudi. Les Prairies d'Or*, Paris, Imprimerie Impériale.
- MOOKERJI R.  
1912 *Indian Shipping. A History of the Seaborne Trade and Maritime Activity of the Indians from the Earliest Times*, London, Longmans Green.
- MORELAND W. H.  
1939 The Ships of the Arabian Sea about A.D. 1500, *The Journal of the Royal Asiatic Society of Great Britain and Ireland* 1, p. 63-74.
- MOULE A. C., PELLIOT P.  
1938 *Marco Polo. The Description of the World*, London, Routledge.
- PÂRIS F. E.  
1843 *Essai sur la construction navale des peuples extra-européens ou collection des navires et pirogues*, Paris, Arthus Bertrand.
- PRADOS E.  
1996 Traditional Fishing Craft of the Tihamah and Southwestern Arabian Coast, *The American Neptune* 56.2, p. 89-115.
- PRINS A. H. J.  
1982 The Mtepe of Lamu, Mombasa and the Zanzibar Sea, *Paideuma* 28, p. 85-100.
- 1986 *A Handbook of Sewn Boats: The Ethnography and Archaeology of Archaic Plank-Built Craft*, London, Trustees of the National Maritime Museum.
- SEVERIN T.  
1985 Constructing the Omani Boom Sohar, in S. McGrail, E. Kentley (eds), *Sewn Plank Boats: Archaeological and Ethnographic Papers Based on those Presented to a Conference at Greenwich in November, 1984*, Oxford, BAR International Series 276, p. 279-287.
- SHAIKH A. A., TRIPATI S., SHINDE V.  
2012 Study of sewn plank built boats of Goa, India, *IJNA* 41.1, p. 148-157.
- STANLEY H. E. J.  
1869 *The Three Voyages of Vasco da Gama, and his Viceroyalty. From the Lendas da India of Gaspar Correa*, London, Hakluyt Society.
- VARADARAJAN L.  
1998 *Sewn Boats of Lakshadweep*, Singapore, National Institute of Oceanography.
- VILLIERS A.  
1952 *The Indian Ocean*, London, Museum Press.
- VOSMER T.  
1997 Indigenous fishing craft of Oman, *IJNA* 26.3, p. 217-235.  
2017 The Development of Boatbuilding Technologies and Typologies, in A. Al-Salimi, E. Staples (eds), *Oman: A Maritime History*, Hildesheim, Zürich and New York, Georg Olms Verlag, Studies on Ibadism and Oman, p. 185-222.
- YULE H.  
1914 *Cathay and the Way Thither: Being a Collection of Medieval Notices of China*, Vol. III, London, Hakluyt Society.
- ZARINS J.  
2007 Aspects of recent archaeological work at al-Balīd (Zafār), Sultanate of Oman, *Proceedings of the Seminar for Arabian Studies* 37, p. 309-324.
- ZARINS J., NEWTON L.  
2017 Northern Indian Ocean Islamic Seaports and the Interior of the Arabian Peninsula, in A. Al-Salimi, E. Staples (eds), *The Ports of Oman*, Hildesheim, Zürich and New York, Georg Olms Verlag, Studies on Ibadism and Oman, p. 57-88.

# BARK CANOES: SEWING, LASHING AND FOLDING

Béat ARNOLD

---

## Abstract

Bark canoes are characterised by their envelope, which consists of a sheet, or sometimes several sheets of bark. The bark used is of different thicknesses depending on the available tree species and its own specific rigidity. These parameters necessitate the insertion of a number of elements to reinforce the shape of the canoe and stabilise the upper opening.

The implementation of folds on the sides and ends of the canoe avoids the use of a system for ensuring watertightness, but few canoes are of this type (such canoes are found above all in Mozambique and in the Amazonia/Guyana region). The great majority of bark canoes display ends that are pressed together and sealed by a lashing (short ropes) or sewing (long ropes). The sewing techniques used on Australian canoes demonstrate exceptional diversity, and are sometimes characterised by remarkable complexity.

Bark canoes are therefore typically shell-first constructions, resulting from highly developed concepts and fundamentally dependent on the thickness of the bark and its mechanical characteristics.

## Keywords

Canoe, bark, folding, sewing, needle, watertightness

## Résumé

Les canoës d'écorce se caractérisent par leur enveloppe constituée d'une ou plusieurs plaques d'écorce. L'épaisseur de l'écorce utilisée est fonction des essences d'arbres disponibles et de leur rigidité spécifique. Ces différents paramètres conduisent à l'insertion de plusieurs éléments pour consolider le canoë dans ses formes et stabiliser l'ouverture supérieure.

La réalisation de plis sur les côtés et les extrémités du canoë en assure l'étanchéité sans avoir recours à un autre système, mais peu de canoës sont de ce type (on en trouve surtout au Mozambique et dans la région Amazonie/Guyane). La grande majorité des pirogues en écorce présentent des extrémités qui sont pressées l'une contre l'autre et scellées par des ligatures (cordes courtes) ou une couture (cordes longues). Les techniques de couture utilisées sur les pirogues australiennes font preuve d'une exceptionnelle diversité et se révèlent parfois d'une remarquable complexité.

Les canoës à écorce sont donc typiquement des constructions « sur bordé », résultant de concepts très développés et fondamentalement dépendantes de l'épaisseur de l'écorce et de ses caractéristiques mécaniques.

## Mots clés

Canoë, écorce, pliage, couture, aiguille, étanchéité

---

While undoubtedly of remarkable complexity, studies – almost exclusively focused on North American paper birch bark canoes (Roberts, Shackleton 1983; Jennings 2002; Neuzil, Sims 2016) – have ultimately masked the specific characteristics of these latter in comparison with other nautical spaces, such as Australia, East Africa and South America<sup>1</sup>.

Our recent studies, centred on these three spaces, have enabled us to highlight a number of key features. Thus, the Australian canoes are characterised by remarkable development in sewing techniques, equalling or even exceeding those used in North America (fig. 1)<sup>2</sup>. However, in Amazonia/Guyana on the one hand, and in East Africa on the other, the canoes are distinguished by intensive, if not exclusive, employment of folding techniques (fig. 3/2-9), strongly influenced by the sometimes very great thickness of the bark collected. These folding techniques made it possible for the constructors to avoid the challenges related to watertightness.

---

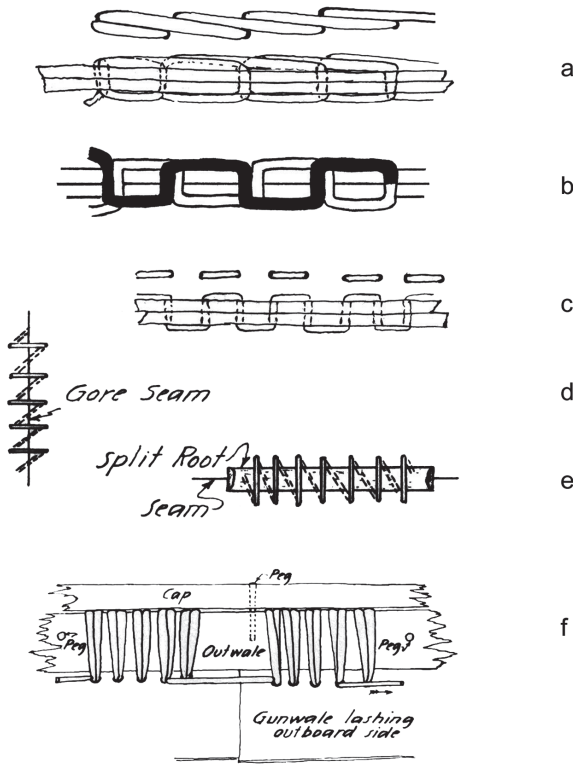
1. In North America, beyond the natural range of the paper birch, other bark types have been used, such as the white elm, red elm, spruce, hickory, brasswood and chestnut. The use of some of these wood species and the rapid construction processes involved makes these craft comparable with canoes constructed on other continents.

2. Basic data collected from the innumerable detailed sketches inserted in the figures published in Adney, Chapelle 1964, but also from the collection of models produced by T. Adney (Jennings 2004).

Depending on the tree species, the bark can sometimes be very thick (up to 40 mm). In this case, an ogival-shaped piece of bark is cut directly from part of the unfelled tree, which survives the process (Upper Xingú, Amazonia; Murray River Basin, Australia). Alternatively, for thinner bark (8-15 mm or less), it is entirely removed in the form of a split cylinder, which generally leads to the death of the tree. A circular slit is cut at the base of the tree, with another at a height corresponding to the length of the planned canoe, and the two slits are connected by a further, vertical cut. The inherent thickness and rigidity of the bark also directly influence the form and type of the canoe produced. This rigidity is often temporarily reduced by heating the bark or, for example in East Africa, sometimes by soaking it in water for several days.

In North America, as in Siberia, the entire construction has been influenced by the preferential – not to say exclusive – use of birch bark. This bark is characterised by being extremely durable though it is also extremely thin, lacking intrinsic rigidity, and thus requires the insertion of a range of elements to make the structure rigid and to mechanically protect the bark.

In Australia, in many cases, it can be observed that the bark has been inverted, with the internal face constituting the exterior of the hull. This is also the case with the thin birch bark, which is used for the majority of canoes in North America. However, the bark is never inverted for canoes in East Africa and Amazonia.



**Fig. 1:** Seams observed on North American canoes: a) back stitch; b) harness stitch; c) running stitch; d-e) half cross stitch; f) overcast lashing with a series of 4-6 double (or sometimes triple) loops and a space intended for the insertion of a rib end (after Adney, Chapelle 1964).

### 1. FOLDING TECHNIQUES

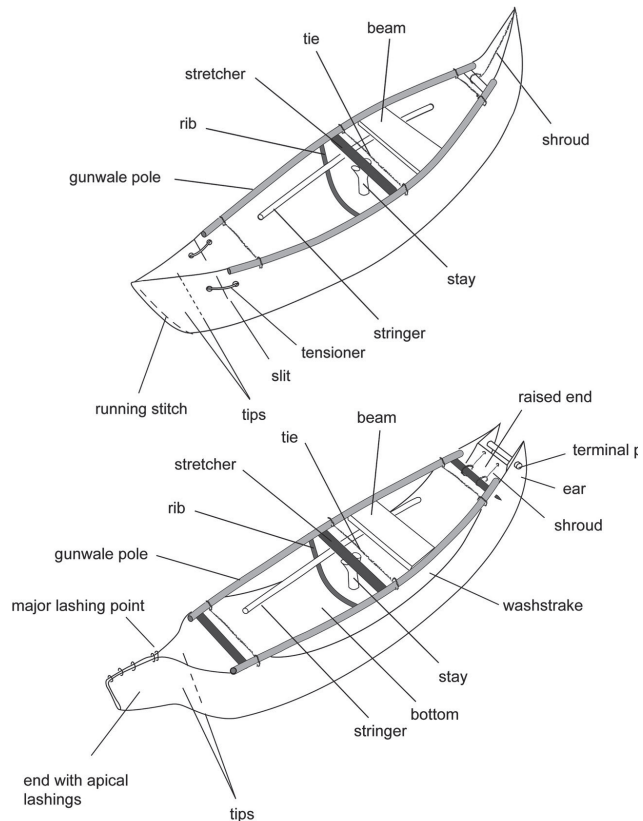
The simplest folding technique consists of placing the tips (fig. 2) against each other: in other words, the sides of the ends of the removed cylinder of bark (fig. 3/12). This area must then be made watertight. Another technique involves maintaining the tips together by apical lashings and inserting a stretcher of a very specific length close to the tips. This enables the end of the canoe to be raised by virtue of its geometry to above the flotation line, with the end taking on the form of the spout of a teapot (fig. 3/11). No process to ensure watertightness is then required. Such canoes are found on the Rivers Purus and Madeira, tributaries of the Amazon (Arnold 2017a, fig. 19), and are exemplified by the *kapepe* canoes of Tanzania (Arnold 2014, fig. p. 37).

Along the southeastern coast of Australia, the aboriginal canoe (the tied bark canoe) presents folded, crumpled ends, located above the flotation line and maintained in place by a single extensive lashing (Arnold 2015, figs 20-30). In South America, on the frontier zone between Brazil and French Guiana, we note the presence of a canoe constructed by the Oyampi people with raised, shaped ends, maintained in place by a strong lashing. And finally, in the north of Mozambique spikes are used (fig. 3/5; Arnold 2019, fig. 22).

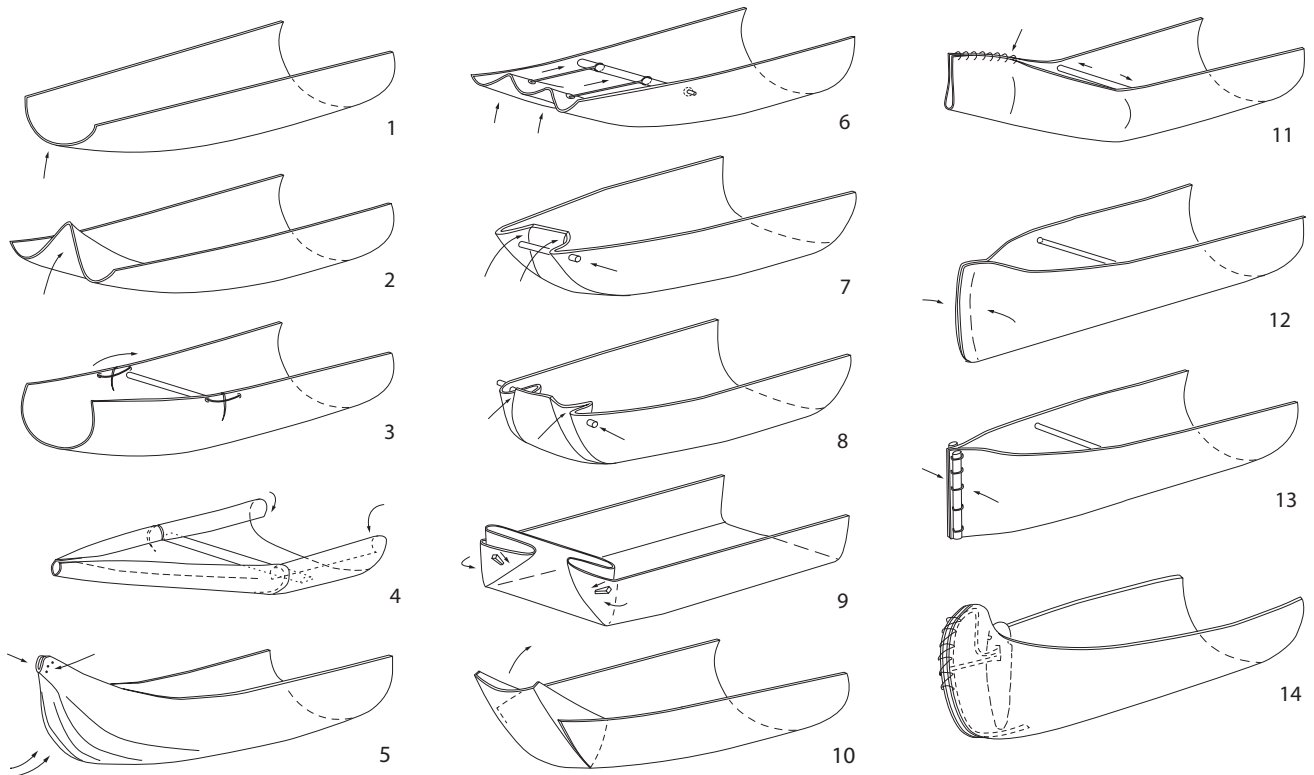
The bark is sometimes so thick that it is not possible to press the tips against each other. The rigidity of the bark sheet is then such that heating enables the ends to be raised only very slightly, bringing them a little above the flotation line, and no particular reinforcement of the hull is required (fig. 3/1). This is the case

in the canoes used on the Murray and Darling Rivers in the State of Victoria (Arnold 2015, figs 12-18), or on the Rio Biá in the Amazon Basin (Arnold 2017a, figs 30-32). On the Upper Xingú (Amazon Basin), after heating the widest end, the central area of the bark cylinder is raised and pressed inwards, this area then taking on a V or W shape (fig. 3/2). A similar technique is often employed on the numerous rectangular canoes on the interior waters of Mozambique (fig. 3/6-9). The lateral parts are sometimes folded against the raised area and secured using bamboo spikes (fig. 3/9; Arnold 2017b, fig. 5). In other cases, the raised part is simply maintained in place with shrouds (fig. 3/6; Arnold 2019, fig. 60-62), or a horizontal closing pole inserted through the protruding end of the sides, which are known as ears (fig. 3/7; Arnold 2019, fig. 67-72).

In many woodskins from Guyana, fashioned from medium thickness bark, the sides at the point where the ends begin to angle upwards present a slit halfway through the thickness of the bark, enabling the ends to be raised with an S or Z fold while preserving the original watertightness of this area (figs 3/3 and 4a). A rope, which we have called a tensioner, straddles the slit and maintains the raised end in position. This tensioner is sometimes consolidated by a sophisticated lashing of overlapping oblong cross stitch type (Arnold 2017a, figs 55-56): a lashing which has been observed on only one other occasion, to assemble the tips on two canoes used in Australia, one of which was collected on Melville Island in Arnhem Land (Arnold 2015, figs 75-78). This type of slit to halfway through the bark has also been observed on a model canoe in elm made



**Fig. 2:** Technical terms used (hybrid sketch adapted to the canoes of South America 1, and Mozambique 2).



**Fig. 3:** Types of single sheet canoe (1-14).

1) Simple bark-canoe, with lowered or raised sides (à une plaque brute et flancs réduits ou élevés); 2) with one end pushed inward (à extrémité enfoncée); 3) open-ended woodskin (woodskin à extrémités ouvertes); 4) rolled bark woodskin (woodskin à écorce enroulée); 5) with longitudinally folded ends (à levées plissées longitudinalement); 6) with shrouds (à haubans); 7) with ears (à oreilles); 8) with closing stem (avec une tige de fermeture); 9) with spikes (à fiches); 10) with independent raised ends (à levées indépendantes); 11) with apical lashings (à ligatures sommitales); 12) with distal seams (à couture distale); 13) with distal seams reinforced by a simple or 14) complex rectilinear structure (à couture distale renforcée par une structure rectiligne simple ou complexe) (CAD illustration: Maeva Arnold; after Arnold 2017a, fig. 164, 2019, fig. 15).

by the Iroquois on Lake Huron, prior to 1831 (fig. 4b; Fenton, Dodge 1949, p. 185-188).

And finally, a specific type of woodskin, which we have designated as a 'rolled-bark' woodskin (fig. 3/4), is characterised by the use of bark that rolls in on itself very significantly as it dries, progressively reducing the initial depth of the canoe to half (Arnold 2017a, fig. 73), a process similar to that involved in folding. This part then forms a type of split cylinder on either side of the canoe, very significantly reinforcing the longitudinal rigidity of the craft.

## 2. PRESSED TIP CANOES AND MULTI-SHEET BARK CANOES

With medium thickness barks – those between 8 and 15 mm – the tips are often pressed against each other and maintained together with a vertical seam. If it is not raised, this area must clearly be made watertight.

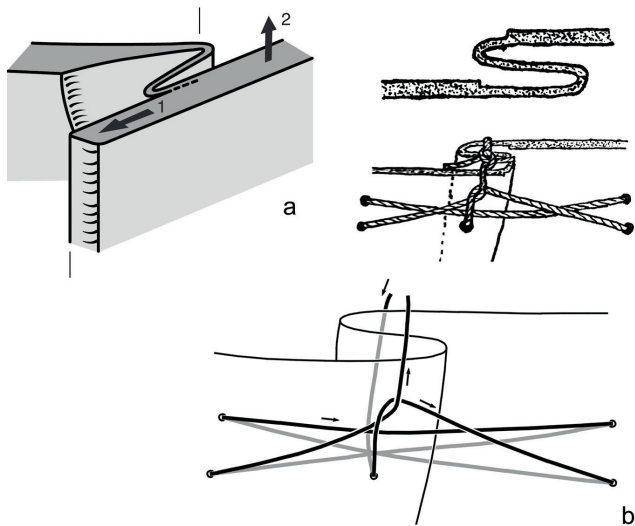
The tops of the sides are generally reinforced by a long stem lashed or sewn to the top of the bark (the gunwale pole). The spread of the hull is ensured by short transverse elements (stretchers), which prevent the sides from closing and, in parallel, ropes or ties enabling the opening to be controlled.

With the exception of the edges of the sheet, no element pierces the bark of the hull. This prevents it from tearing at these points as a result of variations in tension and thus to cracks in the bark. Numerous canoes of this type have been used in Australia, but also in an area corresponding to the median strip of southern Africa. The rectangular canoes of Mozambique are, however, often characterised by very compact bark in which the stretchers end in a pointed shoulder, which is forced through the bark (fig. 3/6).

These canoes are characterised by the speed of construction: half to one day for the removal of the bark and the same again for the creation of the canoe. As for the duration of use, this can sometimes be just a few days or months, but can be two or three years. This is, therefore, an object produced rapidly and discarded as quickly. Such canoes (in elm, hickory, basswood etc.; Jennings 2004) are also present in North America. In the current case, the tip areas are consolidated by inserting them between two more or less vertical stems.

A large assemblage of canoes present in North America, but also in eastern Siberia, is characterised by the use of exceptionally thin bark (less than 4 mm). In North America, these are constructed from the paper birch (*Betula papyrifera*). The thinness of this bark and its intrinsic lack of rigidity lead to the use of exceptional and complex procedures with the installation of a peripheral set of stakes supporting the thin bark during the





**Fig. 4:** a) Z-shaped fold made by a slit into the thickness of the bark and partial release of the internal bark on one side (1) in order to raise (2) the ends of a woodskin from Guyana (Arnold 2017a, fig. 54); b) S fold to half way through the bark, observed on the model in elm of an Iroquois canoe (created before 1831) and view of the consolidation on the inside of the canoe (after Fenton, Dodge 1949, fig. 1).

construction, the insertion of a support structure in the ends (fig. 3/13-14), and the installation of thin sheathing planks and thin broad ribs. It takes two weeks to complete this type of canoe, which can be used for a decade or even up to half a century.

In the Amur Basin, the gunwale poles are attached to the sheet placed flat on the ground, supplemented if necessary by other fragments of bark sheets. The longitudinal seam is of running stitch type with a very short section on the exterior face, this section being covered by a single dot of black mastic to make it watertight, the whole providing a type of decoration on the hull by means of a set of large dots (fig. 5)<sup>3</sup>. After this, longitudinal sheathing planks and a network of interlaced or transverse thin planks are inserted. Sometimes the entire assembly is complemented by intercalary bark sheets, after which the generally cylindrical shape of the canoe is formed by transversely folding the structure with ropes. Finally, the extremities of the bark are cut obliquely, in the direction of the central area and up to the gunwale poles. The bark is then edged with a stem (Ling 1970, p. 51, 73, fig. 12, pl. 15; Levin, Potapov 1964, fig. p. 704). The end thus takes on a form resembling a spur or sturgeon nose.

For a multi-sheet bark canoe, the bark sheets along the longitudinal seams are assembled edge-to-edge or overlapping and enclose watertight bundles (with the exception of those of North America and Siberia). These bundles also act as shock absorbers for the ropes, not to protect the latter as is the case in sewn plank boats, but to protect the bark and prevent it from tearing (Arnold 2004). Here, the ropes are generally passed through holes punched in the bark and thus of lenticular form. Making these locations watertight is initially carried out by sealing



**Fig. 5:** Running stitch seam with short segments on the outer face of the canoe. Each short segment is made watertight by covering it with a large dot of black mastic (Yakut canoe, Siberia) (photography B. Arnold).

them using mastic often based on beeswax or, in Africa, plugged with fragments of thin fabric or cotton extracted from wild species. Three types of multi-sheet bark canoe can be identified: those with washstrakes, the two-shell type (*bivalve*; Arnold 2015, p. 56-61), the three-piece type (*bipyramidal*) with sheets assembled using the clinker technique (Arnold 2015, p. 52-55) or flush-laid (Arnold 2017a, p. 77, 81, 85).

### 3. SEWING, LASHING AND ROPES

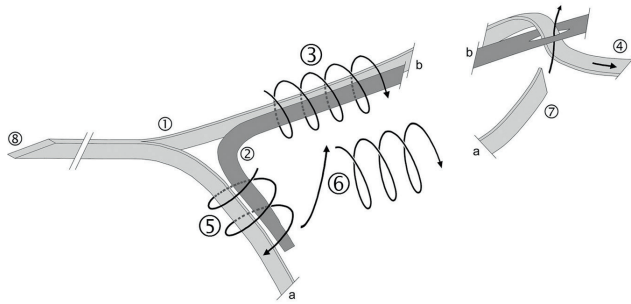
Unlike the canoes created by folding alone, the procedures employed for sewing constitute one of the key elements in the construction of bark canoes, even those formed from a single sheet of bark and with pressed tips. With the development of sewing techniques, there is a gradual movement from folding to assemblage, and thus to the use of techniques based on caulking, luting, sealing and watertight bundles.

Depending on the thickness of the bark, the addition of hull reinforcement elements, particularly in the apical area, also plays an important role in obtaining a stable form. These elements consist of stems of varying lengths maintained in place by lashing (short ropes) or sewing (long ropes). Finally, the relative fragility of the bark requires all of the attachments to be positioned in the peripheral areas of the bark sheet, at the edges, and never through the central area.

These are normally executed using thin, compact and very long elements presenting good longitudinal cohesion and trimmed into a point thus obviating the use of a needle: lianas, roots (subterranean or aerial), strips or shaped ribbons of bark or wood, or cuts from whalebone.

The use of cord made from fibres, and thus presenting no longitudinal rigidity, leads to a series of new problems. Such cord has to be manufactured in advance, and around 50 m is required for a single *muterere*, of about 3-3.5 m, from the region of the Island of Mozambique. The use of such cord essentially requires the employment of large needles (Arnold 2019, p. 87-89). For the *muterere*, this is not a traditional needle with

3. See also Mason, Hill 1901, bottom of pl. 4. The images at the bottom of pl. 3 and 4 have been reversed. See also the numerous bark canoes in the reserves of the Russian Museum of Ethnography in Saint Petersburg.



**Fig. 6:** Muterere canoe: method for attaching the needle (light grey: 1) to the folded cord (dark grey: 2) by three successive twists: 3, 5 and 6 (Arnold 2019, fig. 239).

an eye, made from bone or metal, but a leaflet from the compound frond of a palm tree attached to the cord by means of three successive twists (fig. 6). An intervention taking just a few seconds is required for the point of the leaflet to be used as a needle.

#### 4. CONCLUSION

This brief overview of bark canoes highlights their similarities and differences on the basis of the presence of trees

enabling the extraction of large bark sheets, the thickness of the latter and their inherent rigidity, the exclusive use of folding techniques in order to avoid resolving problems of watertightness, or on the contrary the development of sometimes very sophisticated sewing techniques associated with the use of processes to ensure watertightness. The straps are almost systematically made from a single piece presenting good longitudinal cohesion, trimmed to a point, requiring almost no preparatory work (except keeping them humid and thus flexible). In this context, the use of a needle is exceptional.

The canoes present a specific structure, characterised by extreme rapidity of manufacture. As for the duration of use, with the exception of those in paper birch, this is exceptionally short and the canoe corresponds to a consumer product with a brief lifespan: manufactured quickly, used for a very brief period then abandoned. This is not the case for the birch bark canoes of North America.

It should also be noted that these bark canoes are the result of highly developed concepts, whether using folding or sewing techniques. Therefore, they fundamentally differ from other assemblages of raft type, boats consisting of assembled planks, a framework covered by a flexible envelope or a hollowed trunk. Often, even the simplest bark canoes provide considerable evidence of the exceptional expertise of indigenous craftsmen and of their knowledge of the properties of the natural elements surrounding them. Finally, these canoes require an in-depth analytical approach in order to understand the specific details of their construction, which are often highly developed, but sometimes difficult to identify.

Translated by Jane Davis

#### REFERENCES

- ADNEY E. T., CHAPELLE H. I.  
1964 *The bark canoes and skin boats of North America*, Washington, Smithsonian Institution, Museum Bulletin 230.
- ARNOLD B.  
2004 Dover to Bevaix, from the Middle Bronze Age to Gallo-Roman times, from lashing to nailing: a page of naval archaeology illustrated by the evolution of techniques, tools and the discovery of new materials, in P. Clark (ed.), *The Dover Bronze Age boat in context: society and water transport in prehistoric Europe*, Oxford, Oxbow Books, p. 82-89.
- 2014 *Les pirogues kapepe, l'espace nautique du bassin de la rivière Malagarasi (Tanzanie) et quelques observations sur les pirogues en écorce d'Afrique orientale*, Le Locle, Editions G d'Encre (English translation of the text: <https://www.alphil.com/index.php/alphil-diffusion/le-tour-du-monde-en-80-pirogues/les-pirogues-kapepe-l-espace-nautique-du-bassin-de-la-riviere-malagarasi-tanzanie-et-quelques-observations-sur-le-s-pirogues-en-ecorce-d-afrique-orientale.html>).
- 2015 *Canoës en écorce d'Australie et d'Asie du Sud-Est*, Le Locle, Editions G d'Encre (English translation of the text: <https://www.alphil.com/index.php/alphil-diffusion/le-tour-du-monde-en-80-pirogues/canoes-en-ecorce-d-australie-et-d-asie-du-sud-est.html>).
- 2017a *Les canoës en écorce d'Amérique du Sud: de l'Amazonie à la Terre de Feu*, Le Locle, Editions G d'Encre (English translation of the text: <https://www.alphil.com/index.php/alphil-diffusion/le-tour-du-monde-en-80-pirogues/les-canoes-en-ecorce-d-amerique-du-sud-de-l-amazonie-a-la-terre-de-feu.html>).
- 2017b Bark-canoes of East Africa: typology and construction techniques, in J. Litwin (ed.), *Baltic and beyond. Change and continuity in shipbuilding, Proceedings of the Fourteenth International Symposium on Boat and Ship Archaeology, Gdańsk 2015*, Gdańsk, National Maritime Museum, p. 251-256.
- 2019 *Canoës en écorce du Mozambique: une tradition vivante*, Neuchâtel, Editions Alphil (English translation of the text: <https://www.alphil.com/index.php/alphil-diffusion/le-tour-du-monde-en-80-pirogues/canoes-en-ecorce-du-mozambique-une-tradition-vivante.html>).
- FENTON W. N., DODGE E. S.  
1949 An elm bark canoe in the Peabody Museum of Salem, *The American Neptune* 9.3, p. 185-206.
- JENNINGS J. (ED.)  
2002 *The canoe: a living tradition*, Toronto, Firefly Books.
- JENNINGS J.  
2004 *Bark canoes: the art and obsession of Tappan Adney*, Richmond Hill, Firefly Books.
- LEVIN M. G., POTAPOV L. P. (EDS)  
1964 *The Peoples of Siberia*, Chicago/London, University of Chicago Press.

LING S.-S.

- 1970 *A study of the raft, outrigger, double and deck canoes of Ancient China, the Pacific and the Indian Oceans*, Taipei, Institute of Ethnology, Academia Sinica Monograph 16.

LUUKKANEN H.

- 2010 On the diffusion of the bark canoes, skin boats and expanded log boats in Eurasian North, in Ch. Westerdhal (ed.), *A circumpolar reappraisal: the legacy of Gutorm Gjessing (1906-1979)*, Oxford, BAR International Series 2154, p. 189-217.

MASON O. T., HILL M. S.

- 1901 Pointed bark canoes of the Kutenai and Amur, *Report of U. S. National Museum for 1899* (Washington), p. 523-537.

NEUZIL M., SIMS N.

- 2016 *Canoes. A natural history in North America*, Minneapolis, University of Minnesota Press.

ROBERTS K., SHACKLETON PH.

- 1983 *The canoe. A history of the craft from Panama to the Arctic*, Toronto, Macmillan.

# INDIGENOUS NAVIGATION IN THE CARIBBEAN BASIN: A HISTORICAL, ETHNOARCHAEOLOGICAL AND EXPERIMENTAL APPROACH TO THE CARIBBEAN-GUYANESE KANAWA

Benoît BÉRARD and Alexandra BIAR

---

## Abstract

The early human occupation of the Antilles was based on the manufacture and use of expanded and extended dugout canoes named *kanawa*. The same boat type is also associated with the Carib linguistic family groups precolonial expansion along the coasts from Brazil to Venezuela. This paper describes this type of boat and its construction process in a comparative approach to archaeological and ethnohistorical data related to the Antillean archipelago and an ethnoarchaeological study of the contemporary construction process of the *kanawa* by the Kali'na Amerindians of Guiana (French Guiana/Suriname). Lastly, an experimental maritime archaeology programme carried out in the Antilles over several years allows us to discuss the nature of navigation permitted by this type of boat.

## Keywords

Caribbean, dugout canoe, experimentation, Guiana, maritime technology

## Résumé

La première occupation humaine des Antilles a été rendue possible par la fabrication et l'utilisation de pirogues expansées désignées sous le nom de *kanawa*. Ce même type d'embarcation est également associé à l'expansion précoloniale des groupes de la famille linguistique caraïbe le long des côtes du Brésil et du Venezuela. Cet article décrit ce type de bateau et sa technique de construction dans une approche comparative des données archéologiques et ethno-historiques liées à l'archipel antillais. Il inclut ensuite une étude ethnoarchéologique du processus de construction contemporain du *kanawa* par les Amérindiens Kali'na de Guyane et du Suriname. Enfin, un programme expérimental d'archéologie maritime mené aux Antilles sur plusieurs années permet de discuter des capacités de navigation de ce type de bateau.

## Mots clés

Caraïbes, pirogue monoxyle, expérimentation, Guyane, technologie maritime

---

The Caribbean Sea forms a kind of 'American Mediterranean' with the Gulf of Mexico. The Antillean Islands that separate it from the Atlantic Ocean extend over 4000 km between the north coast of South America and Florida (fig. 1). The Amerindian peopling of the archipelago took place in several waves (Keegan *et al.* 2013; Rouse 1992). The presence of archaic groups, whose origin could be Mesoamerican, was identified in the Greater Antilles as early as the fifth millennium BC. Later (end of the fourth millennium BC) groups of maritime nomads crisscrossed the northern Lesser Antilles and the Virgin Islands (Bonnissent 2013; Hofman *et al.* 2006). Are they the descendants of groups that were present earlier in the Greater Antilles or the result of a new migration of populations from northern South America? There is currently no consensus within the Caribbean archaeological community on this issue (Callaghan 2010). During the second half of the first millennium BC, a new population influx from northern South America (Orinoco Basin) marked the beginning of the development of formative societies in the archipelago. They were particularly characterised by the establishment of important networks of inter-island exchange, as well as between the islands and the continent (Berard 2013a). Finally, important links with the Guiana Shield, probably associated with a population influx,

have been documented (Boomert 1986; Hofman, Hoogland 2012). Their dating as well as their exact modalities have still to be established (Bérard 2011).

As regards navigation conditions in the West Indies, outside the hurricane season, the wind regime is dominated by trade winds blowing from the northeast. The currents are permanent and significant, mainly linked to the entry of Atlantic waters through the channels that separate the islands from each other and especially between the southern end of the archipelago and the continental coasts (South Equatorial current). The relative narrowness of these channels means that, with one exception (the Anegada Passage between Anguilla and the Virgin Islands), the islands are visible to one another (Torres, Rodríguez Ramos 2008): hence the metaphor of stepping stones that has been used by archaeologists to describe the archipelago. In any case, the precolonial human occupation of the Antilles is one of the rare examples of early human occupation of an oceanic archipelago, and a large set of archaeological data has demonstrated the capacity of all those groups to create and maintain important exchange networks inside the archipelago and with several continental areas (Hofman, van Duijvenbode 2011; Curet, Hauser 2011).

Therefore, an evaluation of the navigation capacities of pre-Columbian populations is central for any archaeologist





Fig. 1: Map of the Caribbean Sea and of the Guiana Shield (CAD B. Bérard). Modern distribution of Kali'na groups in grey.

working on the indigenous peoples and cultures that inhabit the Antillean archipelago. However, surprising as it may be, until the past decade only a few research works have been dedicated to this topic. This has led us to develop a long-term programme aimed at addressing the issue. Our multidisciplinary programme was divided into three parts:

- a wide-reaching review of the available archaeological and ethnohistorical data;
- an ethnoarchaeological programme dedicated to the building of large oceanic canoes conforming to historical descriptions;
- an experimental navigation programme.

Understanding the navigational capacities of the pre-Columbian populations of the Caribbean islands is central to many issues that occupy the scientific community. These include: the nature of the technical means developed; the impact of environmental factors; the possible connections between the islands of the Caribbean arc and between this latter and different areas of the American continent; the routes followed by the different migrations that led to the settlement of the archipelago (Fitzpatrick 2013).

The project we set up was not primarily intended to answer all these questions. It originates from within a broader project whose objective was to develop a social geography of the territories (Di Méo 1998) of the first agro-ceramic groups in the Caribbean archipelago (Bérard 2018). This type of approach could not avoid a serious assessment of the technical capacity of these populations to develop and maintain regular relations and exchanges between the different islands. Very quickly, the studies we had carried out on the ancient ceramic occupations of Martinique (Bérard 2004) and Dominica (Bérard 2013b) had shown that it was imperative to try to identify and define these territories by leaving a terrestrial and insular approach and adopting a more maritime and archipelagic perspective.

## 1. ARCHAEOLOGICAL AND HISTORICAL APPROACH TO PRECOLONIAL AND CONTACT PERIOD INDIGENOUS NAVIGATION TECHNIQUES IN THE ANTILLES

Until now very few remains of pre-Columbian canoes have been found in the Antilles. One of these is the so-called Stargate canoe found in a blue hole off Andros Island, Bahamas (Callaghan, Schwabe 2001). This is a very small, simple, dugout canoe, only 1.5 m long. The remains of two other canoes have been found during excavations of the Los Buchillones site in Cuba. The first one is also a simple dugout while the second has been described as a fragment of a large oceanic canoe, possibly an expanded and extended dugout (Cooper 2004). Our knowledge of pre-Columbian Antillean paddles is more extensive<sup>1</sup>. Eight complete paddles and preforms have been discovered sharing approximately the same shape (Bérard *et al.* 2016a, fig. 6). They are composed of a crosspiece, a shaft, and a lanceolate blade. This sort of blade, with a relatively reduced surface, is generally used for long distance navigation in deep water (Warren, Gidmark 2001; Fitzpatrick 2013). Due to this scarcity of direct archaeological evidence, we decided to complement our review with an analysis of the large set of historical European sources dating from the contact period (Bérard *et al.* 2016a). This provided us with a description of the Kalinago Amerindian vessels, composed of four general types. The most basic was a simple balsa (*Ochroma pyramidale*) trunk used for leisure purposes as a sort of archaic bodyboard (Breton 1665). The second was a pumpwood (*Cecropia scheberiana*) raft known as *boùlali* (Breton 1665), and used for fishing in calm waters near the coast. The first canoe built by the Antillean Amerindian groups was called *kuliala*. This was a simple dugout utilised mainly for fishing and coastal navigation. The second type of sea craft was called *kanawa* (fig. 2). It was a large boat capable of transporting up to 40 people and was more specifically dedicated to inter-island navigation. The *kanawa* can be characterised as a dugout canoe expanded by firing and extended by framing and planking. The quality of the historical sources has allowed us to reconstruct the entire operational chain for the construction of this type of boat, from the decision to implement the process to the naming of the new canoe (Bérard *et al.* 2016a).

## 2. BOAT CONSTRUCTION BY THE KALI'NA OF FRENCH GUIANA

Having collected and studied the available archaeological and historical data, we hoped to give substance to this information by constructing a *kanawa*, which would be the basis for developing an experimental navigation programme. To this end, we approached the last remaining marine carpenters of the Kali'na indigenous community in French Guiana. At the beginning of the 17<sup>th</sup> century, the Kali'na, named Galibi by the first European travellers, were family groups of farmers, hunters and fishermen, renowned for their imposing maritime fleets composed of large dugout canoes adapted to coastal and

1. There is no precolonial use of sail in the Antilles (Bérard *et al.* 2016a).



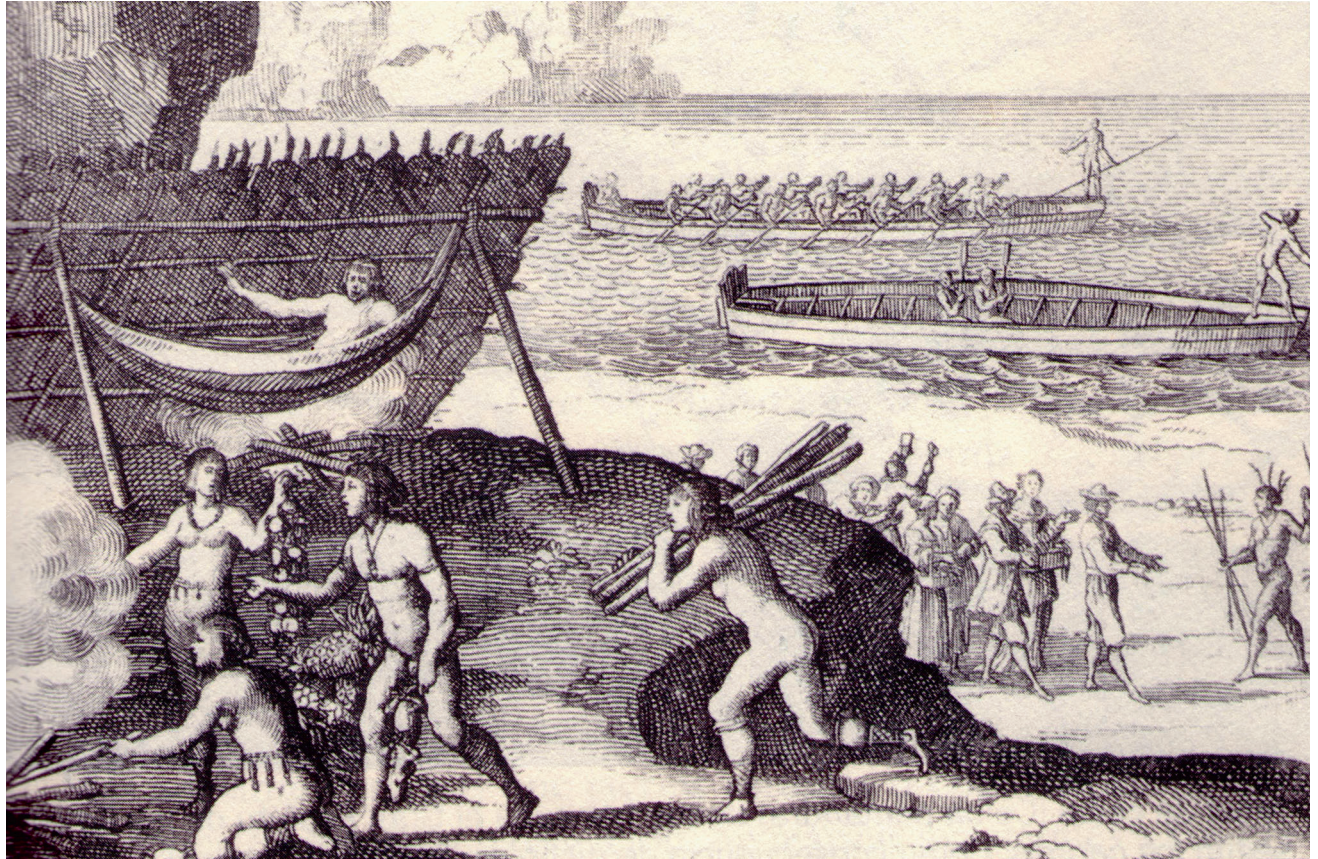


Fig. 2: Representation of a Kalinago kanawa, Lesser Antilles (from Du Tertre 1667, vol. 2, p. 395; source Gallica).

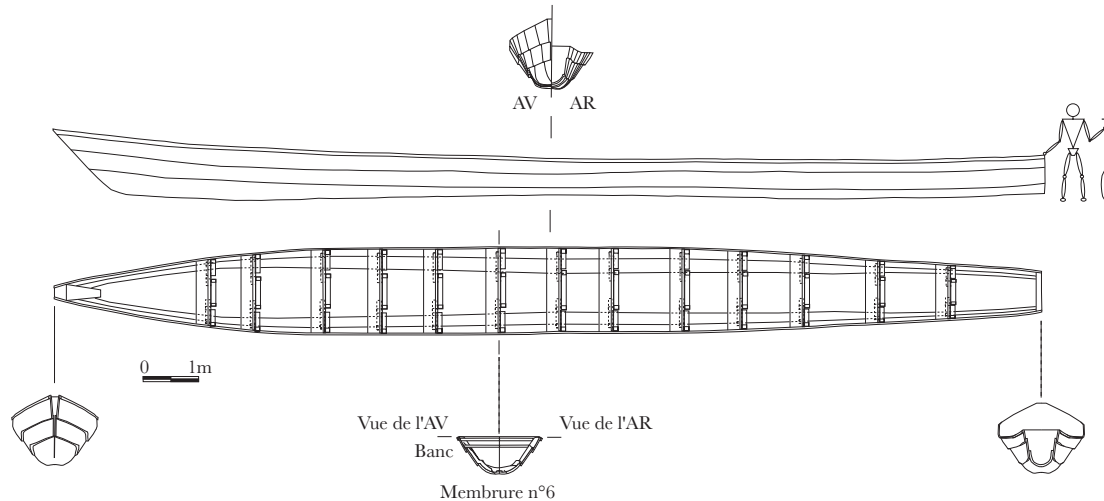
open-sea navigation. Scattered along the coast of the Guiana Shield, Kali'na people settled over a vast area currently divided among the modern countries of Venezuela, Guyana, Suriname, French Guiana and as far as the western bank of the Oyapock River in Brazil (fig. 1). Such an expansion explains why, at the end of the 16<sup>th</sup> century, Kali'na people were among the first indigenous groups of the region to establish contact with Europeans. Today, the communities attached to the Kali'na are still scattered along a coastal fringe stretching from the Brazilian Amazon to the Orinoco Delta. Some elders still possess knowledge inherited from their long maritime tradition, which is doomed to disappear if it is not passed on to the younger generations. The construction of two *kanawa* took place over a period of three months under the direction of Felix Brickman, a Kali'na marine carpenter from Suriname. The construction process followed the steps and principles drawn from the study of archaeological and ethnohistorical data and was enhanced by using Kali'na know-how. Thus, the building process was the result of technical exchanges between the experts of the scientific team and the Amerindian experts in charge of boat construction. To provide a framework for these exchanges, the documentation of the construction process was supplemented by a series of ethnographic interviews. The construction team, but also a larger part of the population, was interviewed using a semi-structured questionnaire. The latter sought to acquire technical information, but also ethnological testimonies, essential to the understanding of traditional navigation and how these boats are an important element in their own conception of Kali'na cultural identity.

The *kanawa* presented here was named *Akayouman* (fig. 3), which means “The spirit of the grandfather snake”. Its dimensions are: length, 17.52 m; width, 1.5 m; minimum planking height, 74 cm. It weighs 1.4 tons empty and its maximum displacement was 8 tons, which leaves numerous theories regarding capacity to be considered. Examinations carried out on its hull in 2008 showed that the monoxyle element followed the shape of the original trunk. The canoe has a maximum flaring around 3 m from the bow. The dugout structure has a residual thickness that varies between 5 and 8 cm, except for the solid front. It has an 8 cm-thick solid transom with notches to hold the *pagalle*, a large steering paddle, as well as a footrest and backrest crossbar. The structure is reinforced by 13 frames, spaced from 1 to 1.2 m apart. The monoxyle element is connected to a stem post limited to the upper part of the bow linking the washboards forwards. Each frame is composed of a floor timber (sided dimension 6 cm) with limber hole and futtock (sided dimension 5 cm), which maintains the washboard (average thickness 2.5 cm). Screws and nails arranged as close as possible to the presumed line of the former vegetable fibre stitching provide the connections. Finally, tropical plant fibres and bitumen are used for caulking.

### 3. THE EXPERIMENTAL NAVIGATION PROGRAMME

The final part of the project was dedicated to an experimental navigation programme (Bérard *et al.* 2016b). First, we had to





### THE KANAWA "AKAYOUMAN"



Fig. 3: The kanawa "Akayouman" (CAD B. Bérard; photography Association Karisko).

train a crew and reconstitute, step by step, the set of skills associated with navigating this very specific type of boat. We gathered and collated the knowledge and know-how that has been preserved until the present day by native and Creole societies in the West Indies. We also benefited from the support of an experienced *va'a* instructor from French Polynesia. After a long preparation and training process, we conducted four expeditions in the Lesser Antilles between 2008 and 2011 (fig. 4).

The first was a one-day navigation dedicated to crossing the 24 nautical mile channel between Martinique and Dominica. Carried out in exceptionally calm conditions, it took us 6 hours and 48 minutes. The second was a nine-day trip including seven navigation days and two rest days. By paddling for almost 44 hours over 139 nautical miles, we reached English Harbour, Antigua, from northern Martinique. The third expedition in May 2010 took us from Grenada to Martinique (31 h 37 for 82 NM) in eight navigation days. Finally, in 2011, we again made the crossing between Martinique and Dominica but with crew changes.

*Akayouman's* standard crew consists of 28 people: 26 paddlers, a boatswain at the front in charge of the rhythm, and a steersman at the stern. One of the forward paddlers occasionally assists the steering in difficult seas or when mooring by acting as a 'bow thruster'. Between December 2007 and May

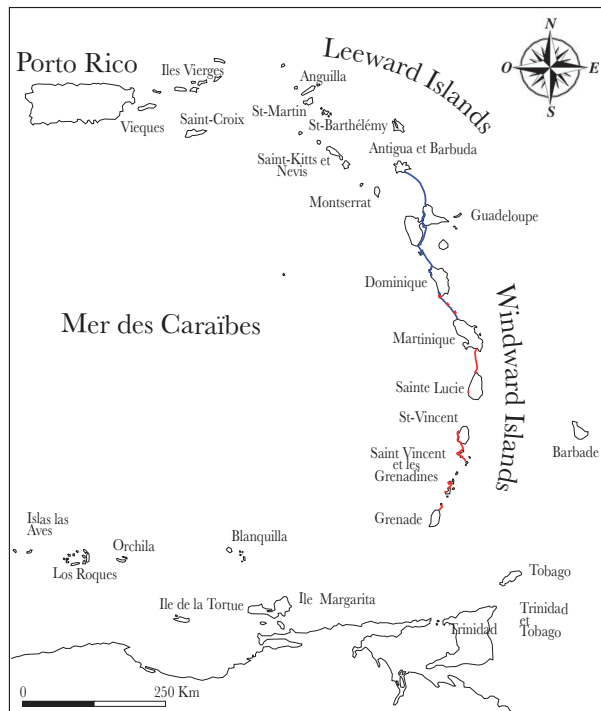


Fig. 4: The expedition routes: red dotted line, Martinique-Dominica 2008; blue line, Martinique-Antigua 2009; red line, Grenada-Martinique 2010 (CAD B. Bérard).

2011, during which time the quantitative data were collected<sup>2</sup> the personnel of this crew obviously changed, but we were able to benefit from a small stable core of crewmembers. The general principle of crew composition did not change. Indeed, the objective of our programme was to assess the navigational capacities of pre-Columbian Caribbean populations in the context of migratory phenomena or economic and/or social trips. Thus, during the first three expeditions, our crew always included women and men, whose ages ranged from 18 to nearly 70 years. In 2011, in order to test the impact of crew composition on the data collected, we modified the composition. The new crew was almost exclusively male and composed of young soldiers from the 1st RSMA<sup>3</sup>, who had undergone several months of training comparable to those preparing for the other expeditions. Despite the change, the data collected were very similar to those obtained in May 2008 and May 2009 on the same route. The distance of 23.7 nautical miles was covered in 6 hours and 37 minutes.

In addition to the information gathered during the various inter-island expeditions, data from various navigations along the coasts of Martinique were also collected for a total distance of 140 nautical miles. Therefore, we have been able to constitute a corpus of quantitative data (route, surface speed, ground speed, environmental data – current, wind and waves) based on a total of 410 nautical miles of navigation. This allowed us to estimate the average speed of these boats at 3 knots. This experimental navigation programme has been complemented by a hydrostatic study of the *Akayouman* (Billard *et al.* 2009) that has provided major data about its cargo capacity, which can reach 1 ton in calm waters. This study also demonstrated that *kanawa* that are not outriggered must carry a significant amount of ballast to ensure their stability. We made our various crossings with a load of about 500 kg as ballast. Thus, with an average speed of 3 knot for a crew of 27 people and a load of 500 kg, i.e. a displacement of 4 t and a draught of 0.41 m, we have been able to estimate the power developed by the crew at about 1/2 hp.

2. Qualitative data collection was never completed, since the use of the *kanawa* continues to this day in the activities of the *Karisko* society. It has even spread to the Guadeloupe archipelago through the activities of the *Association K'nawa*, to which we have sold one of the two boats built in French Guiana.

3. Régiment du Service Militaire Adapté.

## 5. DISCUSSION AND CONCLUSION

The *kanawa* is an expanded and extended dugout canoe for which navigation on the high seas does not present any major difficulty. However, the morphology, as well as the mode of propulsion, the paddle, impose certain limitations. The first and probably the most important of these is the need in rough seas to maintain permanent forward movement in order to ensure the boat's stability. Given that we were reasonably able to estimate cruising speed at 3 knots, the combination of these two elements, with regard to a crew's ability to maintain paddling effort, allows us to approach a limit of navigation in a *kanawa*. A further limitation is related to environmental conditions. The most constraining factor at this level is the swell, however, it is a complex system that integrates wave height, frequency and direction with respect to route. Some conditions would require a change of course and therefore an extension of the route, others simply act against navigation. Nonetheless, observation of meteorological data shows that it is possible to navigate between the islands of the West Indies most days of the year. Concerning navigation between the islands of the archipelago, the navigation capacities of the *kanawa* make it possible to envisage a high frequency of trips. In addition, with two exceptions, each channel can be crossed during one day. Lastly, each trip allows the transport of many passengers and a large cargo. This navigation capacity has not only made it possible to make the archipelago a real specific space of civilisation (Keegan, Hofman 2017) but has also served as a basis for the development of important exchange networks (Hofman, Hoogland 2011; Knippenberg 2006) and the creation of inter-island micro-territories (Bérard 2018).

Compared to previous work based on drift models (Altes 2011; Callaghan 2001, 2010, 2011 and 2013), our research allows us to move from what is possible in terms of pre-Columbian navigation to what is probable by reintegrating the human factor through practical experience. Thus, the experimental data collected have recently been integrated into a new type of simulation (Slayton 2018) allowing much more detailed evaluation than in previous work. All the same, the production of new experimental data still seems necessary, particularly when it comes to designing hypotheses based on longer navigations, in particular, direct navigations between continental areas and the heart of the archipelago. For this reason we are preparing a new expedition between the Yucatan peninsula and the western tip of Cuba (115 NM) for July 2022.

## REFERENCES

- ALTES C.  
2011 A brief note on currents, current archaeologists, and ancient fire-tempered pots, *The Florida Anthropologist* 64.2, p. 113-118.
- BÉRARD B.  
2004 *Les premières occupations agricoles de l'arc antillais, migrations et insularité*, Oxford, Archaeopress, BAR International series 1299, Paris Monographs in American Archaeology 15.  
2011 A la recherche des Caraïbes archéologiques, in B. Grunberg (ed.), *Les Indiens des Petites Antilles. Des premiers peuples aux débuts de la colonisation européenne*, Paris, L'Harmattan, Cahiers d'Histoire de l'Amérique Coloniale 5, p. 27-36.
- 2013a The Saladoïd, in W. Keegan, C. Hofman, R. Rodriguez Ramos (eds), *The Oxford Handbook of Caribbean Archaeology*, Oxford, Oxford University Press, Oxford Handbooks of Archaeology, p. 184-197.  
2013b L'occupation saladoïde ancienne de la Dominique, vers une nouvelle définition des territoires culturels précolombiens, in B. Bérard (ed.), *Martinique, terre amérindienne. Une approche pluridisciplinaire*, Leiden, Sidestones Press, p. 235-246.



- 2018 *Essai d'archéogéographie sociale des territoires amérindiens dans l'archipel antillais 300 av. J.-C./400 apr. J.-C.*, Mémoire original, Habilitation à diriger les recherches, Université de Paris 1 Panthéon-La Sorbonne.
- BÉRARD B., BILLARD J.-Y., L'ÉTANG TH., LALUBIE G., NICOLIZAS C., RAMSTEIN B., SLAYTON E.
- 2016a Technologie du fait maritime chez les Kalinago des Petites Antilles aux XVI<sup>e</sup> et XVII<sup>e</sup> siècles, *Journal de la société des Américanistes* 102.1, p. 129-158.
- 2016b Approche expérimentale de la navigation précolombienne dans les Antilles, *Journal de la Société des Américanistes* 102.2, p. 171-204.
- BILLARD J.-Y., BÉRARD B., RAMSTEIN B.
- 2009 Apports de l'hydrostatique à l'archéologie expérimentale. Étude d'une pirogue de haute mer (*kanawa*), in *Actes du 19<sup>e</sup> Congrès français de mécanique, Marseille 2009*, <http://documents.irevues.inist.fr/bitstream/handle/2042/36639/772.pdf?sequence=1>, consulted on 09/12/16).
- BONNISSENT D. (ED.)
- 2013 *Les gisements précolombiens de la Baie Orientale*, Paris, Maison des Sciences de l'Homme, DAF.
- BOOMERT A.
- 1986 The Cayo complex of St. Vincent: Ethnohistorical and archaeological aspects of the Island Carib problem, *Anthropologica* 66, p. 3-68.
- BRETON R.
- 1665 *Dictionnaire caraïbe-français meslé de quantité de Remarques historiques pour l'esclaircissement de la Langue*, Auxerre, Gilles Bouquet.
- CALLAGHAN R.
- 2001 Ceramic age seafaring and interaction potential in the Antilles. A computer simulation, *Current Anthropology* 42.2, p. 11-22.
- 2010 Crossing the Guadeloupe passage in the archaic age, in S.M. Fitzpatrick, A. Ross (eds), *Island shores, distant pasts*, Gainesville, University Press of Florida, p. 127-147.
- 2011 Patterns of contact between the islands of the Caribbean and the surrounding mainland as a navigation problem, in L.A. Curet, M.W. Hauser (eds), *Islands at the crossroads: migration, seafaring, and interaction in the Caribbean*, Tuscaloosa, University of Alabama Press, p. 59-72.
- 2013 Archaeological views of seafaring in the Caribbean, in W.F. Keegan, C.L. Hofman, R. Rodríguez Ramos (eds), *The Oxford Handbook of Caribbean Archaeology*, Oxford, Oxford University Press, Oxford Handbooks of Archaeology, p. 283-295.
- CALLAGHAN R., SCHWABE S.
- 2001 Watercraft of the islands, in *Actes du XVIII<sup>e</sup> congrès de l'Association internationale d'archéologie de la Caraïbe, St. George, Grenade 1999*, Basse-Terre, AIAC/Région Guadeloupe – Mission archéologique, p. 231-242.
- COOPER J.
- 2004 Islas y Isleños en el Caribe: Interacción a través del paisaje, *El Caribe Arqueológico* 8, p. 91-96.
- CURET L.A., HAUSER M.W. (EDS)
- 2011 *Islands at the crossroads: migration, seafaring, and interaction in the Caribbean*, Tuscaloosa, University of Alabama Press.
- DI MÉO G.
- 1998 *Géographie sociale et territoires*, Paris, Nathan.
- DU TERTRE J.-B.
- 1667-1971 *Histoire Générale des Antilles habitées par les Français*, Paris, Thomas Jolly, 4 vol.
- FITZPATRICK S.M.
- 2013 Seafaring capacities in the Pre-Columbian Caribbean, *Journal of Maritime Archaeology* 8.1, p. 101-138.
- HOFMAN C., BRIGHT A., HOOGLAND M.
- 2006 Archipelagic resource procurement and mobility in the Northern Lesser Antilles: the view from a 3000-years-old tropical forest campsite on Saba, *Journal of Island and Coastal Archaeology* 1.2, p. 145-164.
- HOFMAN C. L., VAN DUIJVENBODE A. (EDS)
- 2011 *Communities in contact. Essays in archaeology, ethnohistory and ethnography of the Amerindian circum-Caribbean*, Leiden, Sidestone Press.
- HOFMAN C.L., HOOGLAND M.
- 2011 Unravelling the multi-scale networks of mobility and exchange in the pre-colonial circum-Caribbean, in C.L. Hofman, A. van Duijvenbode (eds), *Communities in contact. Essays in Archaeology, Ethnohistory and Ethnography of the Amerindian circum-Caribbean*, Leiden, Sidestone Press, p. 15-43.
- 2012 Caribbean encounters: Rescue excavation at the early colonial Carib site of Argyle, St. Vincent, *Analecta Praehistorica Leidensia* 43-44, p. 63-76.
- KEEGAN W., HOFMAN C.L.
- 2017 *The Caribbean Before Columbus*, New York, Oxford University Press.
- KEEGAN W., HOFMAN C., RODRIGUEZ RAMOS R. (EDS)
- 2013 *The Oxford Handbook of Caribbean Archaeology*, Oxford, Oxford University Press, Oxford Handbooks of Archaeology.
- KNIPPENBERG S.
- 2006 *Stone artefact production and exchange among the Northern Lesser Antilles*, PhD dissertation, Faculty of Archaeology, Leiden University.
- ROUSE I.
- 1992 *The Taïnos*, New Haven and London, Yale University Press.
- SLAYTON E.
- 2018 *Seascape corridors*, Leiden, Sidestone Press Dissertations.
- TORRES J., RODRIGUEZ RAMOS R.
- 2008 The Caribbean. A continent divided by water, in B. A. Reid (ed.), *Archaeology and Geoinformatics. Case studies from the Caribbean*, Tuscaloosa, University of Alabama Press, p. 13-29.
- WARREN G., GIDMARK D.
- 2001 *Canoe paddles*, Richmond Hill, Firefly Books Ltd.

# AN OVERVIEW OF THREE DECADES OF DENDROCHRONOLOGY APPLIED TO ANCIENT MEDITERRANEAN SHIPWRECKS IN SOUTHEASTERN FRANCE

Frédéric GUIBAL, Alba Ferreira DOMÍNGUEZ, Giulia BOETTO, Lisa SHINDO, Sandra GRECK and Patrice POMEY

---

## Abstract

Three decades of dendrochronology applied to ancient Mediterranean shipwrecks in southeastern France have resulted in a considerable improvement in knowledge about the wood resources used in ancient shipbuilding. However, in terms of dating, the success rate of dendrochronological analyses is still very low. The possible causes of this low rate are discussed through two case studies: the first pertaining to the shipwrecks from the ancient harbour of Toulon (1<sup>st</sup>-3<sup>rd</sup> centuries AD); the second to a couple of fluvial barges discovered in the Rhône River (mid 1<sup>st</sup>-beginning of the 2<sup>nd</sup> centuries AD).

## Keywords

Dendrochronology, Mediterranean, Rhône River, Roman, shipbuilding, Toulon

## Résumé

Trois décennies de dendrochronologie appliquée aux épaves antiques de Méditerranée dans le sud-est de la France ont permis une amélioration considérable de nos connaissances sur les ressources en bois utilisées dans la construction navale antique. Cependant, en termes de datation, le taux de réussite des analyses dendrochronologiques est encore très faible. Les causes possibles de ce faible taux sont discutées à travers deux études de cas: la première concerne les épaves du port antique de Toulon (I<sup>er</sup>-III<sup>e</sup> siècles apr. J.-C.); la seconde s'intéresse à un couple de barges fluviales découvertes dans le Rhône (milieu du I<sup>er</sup>-début du II<sup>e</sup> siècle apr. J.-C.).

## Mots clés

Dendrochronologie, Méditerranée, Rhône, époque romaine, construction navale, Toulon

---

Any study of the ships that shaped the world would be incomplete without an understanding of the materials required to build these ships, more particularly, wood (Pomey, Rieth 2005, p. 133-134; Creasman 2010). Wood has been the commonest material by far for most of the material culture from early prehistory to the present. In studies of boat and ship architecture wood anatomy supplies information on the selection of tree species: the study of wood anatomy and wood morphology is also extremely relevant to extracting cultural information from ship timbers. The age of wooden objects can be determined by means of dendrochronology, which makes it possible to accurately date the formation of tree-rings and the felling of the tree from which wooden pieces were produced (Farrell, Baillie 1976; Baillie 1982).

Dendrochronology has been applied for the last 30 years on more or less well preserved remains from ancient ships located along the French Mediterranean coastline and also in French Mediterranean inland waters (Guibal, Pomey 2009). Indeed, it was in 1991 that the first dendrochronological and dendromorphological study programme on ancient shipwrecks of the Mediterranean was launched by the Centre Camille Jullian and the Mediterranean Institute for Marine and Terrestrial Biodiversity and Ecology, with the support of the DRASSM (Département des recherches archéologiques subaquatiques et sous-marines) (Guibal, Pomey 2002, 2003, 2004). Totally innovative for the time, this programme has since given

rise to systematic dendrochronological studies on ancient shipwrecks.

If they are not too badly damaged by shipworms (*Teredo navalis* or other wood borers) shipwrecks will yield suitable timbers for dendrochronological analysis. The aims of these studies are (i) to date the felling of the trees used for ship construction, (ii) to estimate the geographical origin of the timber, and (iii) to implement dendromorphological analyses. These latter analyses are intended to assess how timber was processed and to understand basic wood economy patterns by paying particular attention to timber ages, timber volumes and timber conversion.

In total, during the last three decades, dendrochronology has been applied to more than 60 ancient shipwrecks located along the southeastern coast of France, of which only 5% have been so far successfully dendro-dated. The purpose of this article is to review the reasons why this success rate is so low.

## 1. SOME POSSIBLE EXPLANATORY FACTORS

It must never be forgotten that dendrochronology dating is an iterative process, which makes it a constantly evolving process. Indeed, when the dating attempt of a mean site chronology is not successful at time *t*, it is considered a failure because the chronology remains floating. Later, however, as a result of

the improvement and extension of floating and/or master chronologies, this mean site chronology may be dated.

First, we shall consider the usual causes that hamper the chances of successful dating. On the one hand, a low number of tree rings makes the chronologies too short to obtain reliable statistical correlations between ring-width series. Long series with high environmental sensitivity generally have a higher potential for dating than short and complacent series (Haneca *et al.* 2005). On the other hand, too few pieces of wood may be insufficient to build up a representative mean site chronology. And even when the number of elementary series included in a mean site chronology is high, the representativeness of the latter is sometimes low due to the fact that most of the elementary series may come from a single tree, as often happens for most of the strakes that make up the hull. This was deliberately practiced by ancient shipbuilders in order to optimise the timber conversion (Guibal, Pomey 2004).

Second, there is the very nature of the object that is analysed: ships are mobile objects which may have sailed long distances from their places of origin and, wherever the site of the wreck may be located, the place where the ship was built and the geographical origin of the wood might remain unknown (Farrell, Baillie 1976; Pomey, Rieth 2005, p. 139-142). Bridge (2011) reports a few examples in which dendrochronology has provided evidence of an unsuspected geographical origin of ship timbers. Moreover, ships could be built with timber from different tree species originating from different, sometimes distant, geographical areas, and they may also contain reused or refitted timbers. Accordingly, wood from different species, periods, and geographical areas could be present in the same shipwreck (Domínguez-Delmás *et al.* 2018).

Third, we must recognise the specificity of Mediterranean dendrochronology in relation to Mediterranean biogeography. Considered as a biodiversity “hot spot” (Médail, Diadema 2006), the Mediterranean basin shelters more than 100 tree species in an area that represents only 1.8% of forests worldwide. Comparatively, European temperate forests contain less than 30 tree species over an area that is four times as large (Fady-Welterlen 2005). Although not all of these tree species occur in Mediterranean shipbuilding, our studies reveal that a large amount of species were used in ancient times for ship construction. Twenty-eight species representative of three biogeographical units have been identified. Among these species, 22 are suitable for dendrochronological studies (Guibal, Pomey 2002). Similarly, Allevato *et al.* (2010) found 15 species used in the architectural elements of three Roman shipwrecks discovered in *Neapolis* harbour (Naples). A number of species was also identified in ancient shipbuilding along the Mediterranean coast of Israel (Lipshitz 2012). In Turkey, the Yenikapi (Istanbul) ancient ships have also revealed a high number of tree species used in ship construction during the Byzantine Period (Lipshitz, Pulak 2007-2008; Akkemik, Kocabaş 2013).

Consequently, the key to the success of the dendro-dating process, *i.e.* the construction of master chronologies, is somewhat problematic. Indeed, given this multiplicity of tree species and bioclimatic conditions, the number of master chronologies to build is much higher than in other geographical areas.

Lastly, there is some analogy between timber supply in the Mediterranean area and ships, in the sense that both are mobile. Timber has been imported, generally by floating on rivers, for centuries into the Mediterranean area because of the early



Fig. 1: Location of the case studies in southern France (map G. Boetto).

historic depletion of Mediterranean forests (Meiggs 1982). This timber importation explains how mountain and subalpine tree species may be found in ancient shipbuilding. Therefore, cross-dating tests must be carried out, not only against local tree species master chronologies, but also against extra-Mediterranean master chronologies. This increases the complexity of the study and these specificities make Mediterranean ancient shipwrecks a most challenging research object.

As already mentioned above, the dendro-dating success rate in the Mediterranean is low. In addition, even the cross-dating success among different ancient shipwrecks is also low (Guibal, Pomey 2009).

## 2. TOULON SHIPWRECKS: DATING FAILURE AND PROVENANCE HYPOTHESES

An illustrative example of this ship timber diversity is provided by the five shipwrecks that were found in 1987-1988 during the excavation of the ancient harbour of Toulon (Brun 1999) (fig. 1). Toulon 1 and 2 were rowing boats, 6 and 8 m long, scuttled and filled with stones before being reused for the construction of a jetty at the end of the 1<sup>st</sup> century AD. Due to their transom bows, these boats belonged to the *horeia* type vessel family and were working boats. The three other wrecks, Toulon 3-4, 6 and 7, were small sailing ships, 15-20 m in length, that were abandoned in the harbour basin in the first half of the 3<sup>rd</sup> century AD (Boetto 2009, forthcoming). Following the notion of architectural types and the concepts of principles and methods of construction (Pomey 2004; Pomey, Rieth 2005, p. 29-33; Pomey *et al.* 2012, 2013), all the wrecks belonged to keeled vessels with flush-laid carvel planking and mortise-and-tenon joints. Their construction principle was based on a shell concept for the hull structure, and on a longitudinal strake-oriented concept for their shape, while the building process was shell-first.

For conservation reasons, by the time of the excavation, dendrochronological analysis was not allowed because the wrecks were intended for restoration and later display in a museum

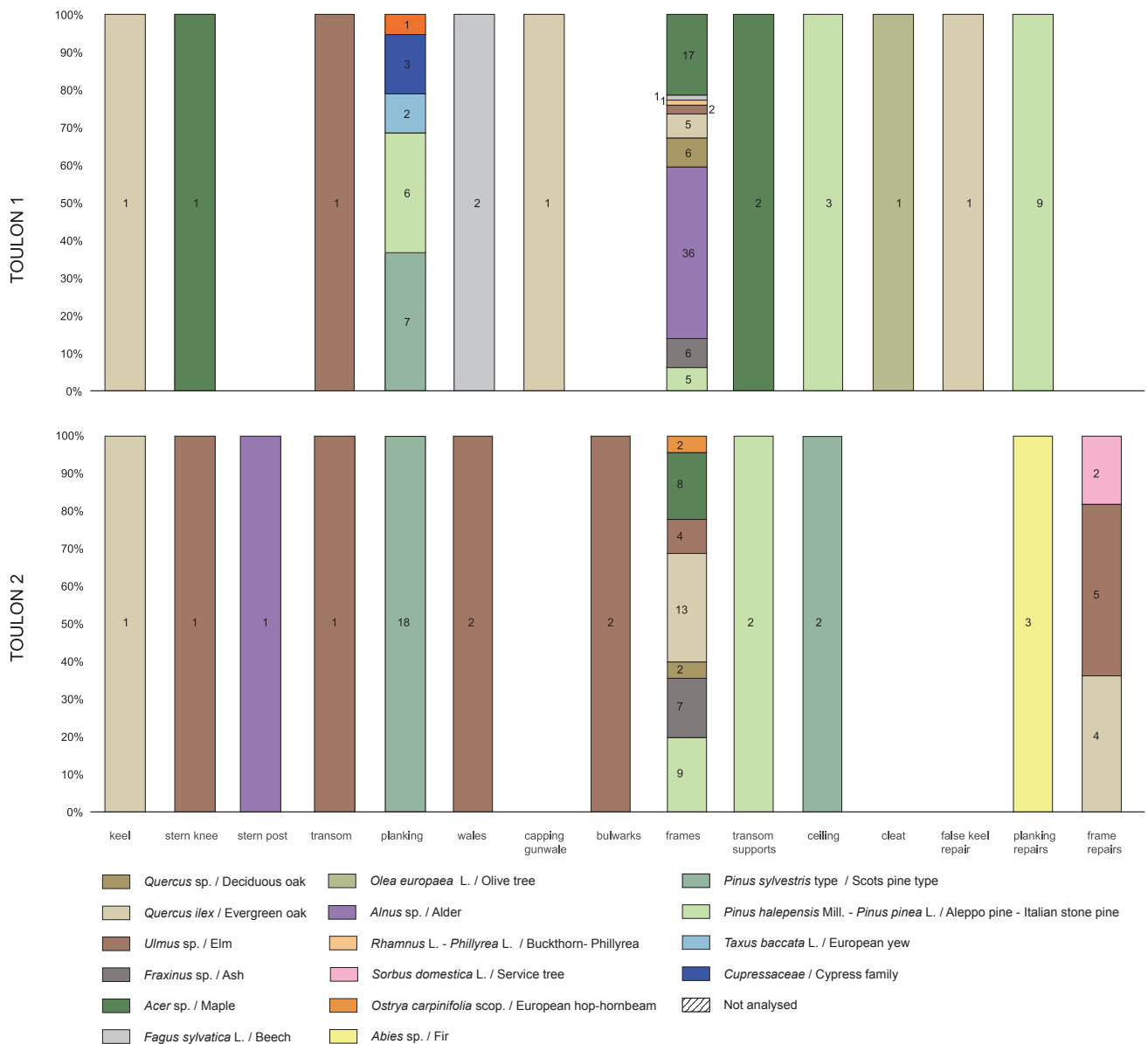


Fig. 2: The wood species identified on Toulon 1 and 2 (graphic A. Ferreira Domínguez).

(Pasqualini *et al.*, forthcoming). The wrecks were treated with polyethylene glycol (PEG) then freeze-dried in the ARC-Nucléart restoration laboratory at Grenoble, and in 2008 the dismantled architectural pieces came back to Aix-en-Provence for long-term storage, awaiting a future display project. Nearly 30 years after the ships' excavation, as part of a project for the final publication of the harbour excavation, the systematic wood identification analysis and the dendrochronological analysis of the vessels were performed. As a consequence of the conservation process, wood identification was hindered and some anatomical uncertainties remained (Ferreira Domínguez 2014; Ferreira Domínguez *et al.* forthcoming) (fig. 2).

Only two of the Toulon wrecks offered the sample quality that would allow a dendrochronological study. Indeed, too few timbers and too few rings were available among the three other shipwrecks. Tree-ring series were analysed for the ships Toulon 2 and Toulon 3-4. In total, three mean chronologies

were constructed: Toulon 2 provided an oak mean chronology, 167 years long, and a type Scots pine<sup>1</sup> chronology, 151 years long. Toulon 3-4 provided a fir/spruce chronology 138 years long.

So, three rather long mean chronologies were built, but no significant cross-correlation could be obtained between them. In fact, even if there may be some overlap between the ring series, no cross-dating was obtained because the ecological requirements of these three tree species are too different and their ring patterns are obviously also different. Attempts have been made to cross-match these mean chronologies with others from marine or continental (western Provence) sites, but so far they have failed (Shindo, Guibal forthcoming).

1. Because it is impossible to distinguish the anatomy of the wood of Scots pine (*Pinus sylvestris* L.), black pine (*Pinus nigra* Arnold) and Swiss mountain pine (*Pinus uncinata* Ramond) these species are hereby gathered under the term 'type Scots pine'.



For Toulon 2 and 3-4, due to the limited dendrochronological study and the failure of cross-dating, it was impossible to determine the origin of the timber used for shipbuilding. Nevertheless, at least for Toulon 1 and 2, given the current distribution of tree species in the mountainous and hilly areas situated in a range of 20-40 km to the north and northwest of Toulon (for example, on the north slopes of the Sainte-Baume ridge or in the Esterel mountains), it is probable that the wood used for their construction was locally grown and transported to a coastal shipyard (fig. 2). Given the ease of transporting all these woods to a shipyard situated near the ancient port of Toulon, and taking into account the small size and function of these boats, the use of local wood originating from the surrounding areas of *Telo Martius* seems quite probable. Thus, the results obtained from the analysis of the wood used in the construction of Toulon 1 and 2 confirm the assumption of a local origin of these ships, agreeing with the theory previously proposed from analysis of their construction characteristics coupled with consideration of their function as harbour lighters or for fishing (Boetto 2009, forthcoming).

### 3. ARLES SHIPWRECKS: DATING AND TIMBER PROVENANCE SUCCESS

The rare French Mediterranean study cases in which dendro-dating succeeded involve two shipwrecks both located in the Rhône River in the city of Arles: Arles-Rhône 3 and 5. Arles-Rhône 3, a 30-m long barge transporting a cargo of building stones during its last voyage, sunk in the river in the middle of the 1<sup>st</sup> century AD (Marlier 2014a). Arles-Rhône 5, a similar barge, 30-35 m in length, was probably abandoned in a ship graveyard located downstream, the fluvial harbour dump of the city (Marlier *et al.* 2019).

These Gallo-Roman barges were built according to a flat-bottom principle with a construction process in which the shape and the structure were dictated by and organised around the flat bottom, which was laid first with carved bilge planks (or carved transition strakes). Perhaps built in the same shipyard, Arles-Rhône 3 and 5 belong to the Rhône-Saone shipbuilding tradition (Pomey 2011; Rieth 2011) characterised by Mediterranean maritime influences on a specific continental shipbuilding tradition (Marlier *et al.* 2019, p. 487-489).

Arles-Rhône 3 involves oak and fir chronologies (Guibal, Greck 2014a), and Arles-Rhône 5 involves oak chronology (Marlier *et al.* 2019, p. 473). Felling ranges of the trees were 50-60 AD and 110-140 AD, respectively. All of these mean chronologies could be dated against oak and fir master chronologies representative of more northerly regions (eastern and northeastern France). Arles, situated in the lower Rhône valley, held a strategic position for the river trade on the Rhône River. It was there that merchandise from Rome, the Iberian Peninsula and North Africa was stored before being loaded onto other fluvial vessels sailing up the Rhône River to Lyon and forwarded to the northern provinces or to Geneva. Conversely, the Rhône River, and in extension its confluent the Saône River, made the whole corridor to Arles a way of supplying materials such as timber from the hinterland.

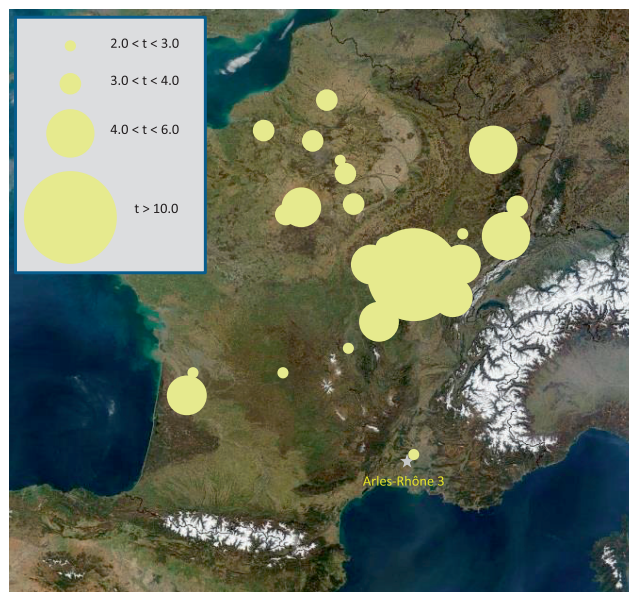


Fig. 3: Arles-Rhône 3 barge. Map showing the distribution of correlation (*t*-values) achieved between the mean for Arles-Rhône 3 and site chronologies from Northern Europe (F. Guibal).

The analysis for Arles-Rhône 3 went well beyond dating the felling of the trees, and confirmed that dendrochronology can successfully serve as a tool to determine the origin of timber used for shipbuilding (Bonde *et al.* 1997; Wazny 2002; Haneca *et al.* 2005; Daly 2007; Domínguez-Delmás *et al.* 2018; Rich *et al.* 2017). Dendroprovenancing was successful: thanks to a gradient in correlation coefficients (fig. 3), a geographical origin of timber utilised could be determined, attesting an origin in the Burgundy part of the Saône valley, 350 km north of Arles (Guibal, Greck 2014b). Timbers could have been floated downstream and used for the construction of the Arles-Rhône 3 barge. Thanks to a multi-proxy analysis, it is probable that this shipyard was situated in Arles or its surroundings (Marlier 2014b).

### 4. CONCLUSION

Shipwrecks are the last chapter of a complex story and much of the information unrelated to a ship's final voyage remains a mystery. However, a part of that mystery can be exposed by an examination of the timbers (Creasman 2010). Dendrochronology has become well established in the field of nautical archaeology studies because it is able to provide answers to the crucial research questions of place and date of the building of a ship. The date and geographical origin of timber utilised for ship construction can provide valuable information on the building period of the ship and the wood resources used. In the north-western Mediterranean area, despite the progress that has been made during the last decades, the success rate of ship dendrochronological analyses is still very low. More site chronologies that cover the period of the last 25 centuries are needed in countries around the Mediterranean Sea. This requires the supplementary systematic application of dendrochronology in Mediterranean boat and ship archaeology.

## ACKNOWLEDGEMENTS

The authors acknowledge the French Ministry of Culture for financial support of the programme “Dendrochronology and

Dendromorphology of Ancient Mediterranean Shipwrecks”. They also express gratitude to all the participants involved in the archaeological projects mentioned in the text.

## REFERENCES

- AKKEMIK, Ü., KOCABAŞ U.  
2013 Woods of the old galleys of Yenikapı, Istanbul, *Mediterranean Archaeology and Archaeometry* 13. 2, p. 3141.
- ALLEVATO E., RUSSO ERMOLLI E., BOETTO G., DI PASQUALE G.  
2010 Pollen-wood analysis at the *Neapolis* harbour site (1<sup>st</sup>-3<sup>rd</sup> century AD, southern Italy) and its archaeobotanical implications, *Journal of Archaeological Science* 37, p. 2365-2375.
- BAILLIE M. G. L.  
1982 *Tree-Ring Dating and Archaeology*, London, Croom Helm.
- BOETTO G.  
2009 New archaeological evidences of the *Horeia*-type vessels: the Roman Napoli C shipwreck from Naples (Italy) and the boats of Toulon (France) compared, in R. Bockius (ed.), *Between the seas. Transfer and Exchange in Nautical Technology, Proceedings of the Eleventh International Symposium of Boat and Ship Archaeology (ISBSA 11), Mainz 2006*, Mainz, Verlag des römisch-germanischen Zentralmuseums, RGZM-Tagungen Bd 3, p. 289-296.  
Forthcoming Les épaves du port antique de Toulon, in Pasqualini, Brun, Boetto Forthcoming
- BONDE N., TYERS I., WAZNY T.  
1997 Where does the timber come from? Dendrochronological evidence of the timber trade in Northern Europe, in A. Sinclair, E. Slater, J. Gowlett (eds), *Archaeological Sciences 1995*, Oxford, Oxbow books, Oxbow Monograph 64, p. 201-204.
- BRIDGE M.  
2011 Resource Exploitation and Wood Mobility in Northern European Oak: dendroprovenancing of individual timbers from the Mary Rose (1510/11-1545), *IJNA* 40.2, p. 417-423.
- BRUN J.-P.  
1999 *Le Var*, Paris, Académie des Inscriptions et Belles-Lettres, Carte archéologique de la Gaule 83/2.
- CREASMAN P. P.  
2010 *Extracting cultural information from ship timber*, PhD thesis, Texas A&M. University.
- DALY A.  
2007 *Timber, Trade and Tree-rings: A Dendrochronological Analysis of Structural Oak Timber in Northern Europe, c. AD 1000 to c. AD 1650*, PhD thesis, Esbjerg, University of Southern Denmark.
- DOMÍNGUEZ-DELMÁS M., RICH S., DALY A., NAYLING N., HANECA K.  
2018 Selecting and Sampling Shipwreck Timbers for Dendrochronological Research: practical guidance, *IJNA* 48.1, p. 231-244.
- FADY-WELTERLEN B.  
2005 Is there really more biodiversity in Mediterranean forest ecosystems? *Taxon* 54.4, p. 905-910.
- FARRELL A. W., BAILLIE M. G. L.  
1976. The use of dendrochronology in nautical archaeology, *Irish Archaeological Research Forum* III, 2, p. 45-55.
- Dendromorphology of Ancient Mediterranean Shipwrecks”. They also express gratitude to all the participants involved in the archaeological projects mentioned in the text.
- FERREIRA DOMÍNGUEZ A.  
2014 *Etude xylogologique des barques de type horeia Toulon 1 et Toulon 2*, Master's thesis, Aix-en-Provence, Université Aix Marseille, unpublished.
- FERREIRA DOMÍNGUEZ A., GUIBAL F., BOETTO G.  
Forthcoming Le bois employé dans la construction des embarcations de Toulon, in Pasqualini, Brun, Boetto Forthcoming
- GUIBAL F., GRECK S.  
2014a La datation dendrochronologique, in Marlier 2014a, p. 260-263.  
2014b L'origine géographique des arbres, in Marlier 2014a, p. 267-268.
- GUIBAL F., POMEY P.  
2002 Essences et qualité des bois utilisés dans la construction navale antique. L'apport de l'étude anatomique et dendrochronologique, *Forêt Méditerranéenne* XXIII, 2, p. 91-104.  
2003 Timber Supply and Ancient Naval Architecture, in C. Beltrame (ed.), *Boats, Ships and Shipyards, Proceedings of the Ninth International Symposium on Boat and Ship Archaeology (ISBSA 9), Venice 2000*, Oxford, Oxbow books, p. 35-41.  
2004 Dendrochronologie et construction navale antique, *Revue d'Archéométrie* 28, p. 35-42.  
2009 Ancient shipwrecks, naval architecture and dendrochronology in the western Mediterranean, in R. Bockius (ed.), *Between the seas. Transfer and Exchange in Nautical Technology, Proceedings of the Eleventh International Symposium of Boat and Ship Archaeology (ISBSA 11), Mainz 2006*, Mainz, Verlag des römisch-germanischen Zentralmuseums, RGZM-Tagungen Bd 3, p. 219-226.
- HANECA K., WAZNY T., VAN ACKER J., BEECKMAN H.  
2005 Provenancing Baltic timber from art historical objects: success and limitations, *Journal of Archaeological Science* 32, p. 261-271.
- LIPHSCHITZ N.  
2012 Dendroarchaeology of shipwrecks in Israel, *Bocconea* 24, p. 95-104.
- LIPHSCHITZ N., PULAK C.  
2007-2008 Wood species used in ancient shipbuilding in Turkey: evidence from dendroarchaeological studies, *Skyllis* 8, p. 73-82.
- MARLIER S. (ED.)  
2014a Arles-Rhône 3, un chaland gallo-romain du 1<sup>er</sup> siècle après Jésus-Christ, Paris, CNRS éditions, *Archaeonautica* 18.
- MARLIER S.  
2014b Conclusions sur le lieu de construction présumé, in Marlier 2014a, p. 268-270.
- MARLIER S., GRECK S., DJAOUI D., DE VIVIÉS PH., BAYLE M., MÉDARD F., GUIBAL F., ANDRIEU-PONEL V., LATTUATI-DERIEUX, LANGLOIS J., CENZON-SALVAYRE C., TILLIER M., RIETH É.  
2019 L'épave Arles-Rhône 5, un nouveau chaland gallo-romain, in D. Djaoui, M. Heijmans (eds), *Archéologie et histoire en territoire arlésien. Mélanges offerts à Jean Piton*, Drémil Lafage, éditions Mergoïl, *Archéologie Histoire Romaine* 42, p. 439-493.

- MÉDAIL F., DIADEMA K.  
2006 Biodiversité végétale méditerranéenne, *Annales de Géographie* 115, 651, p. 618-640.
- MEIGGS R.  
1982 *Trees and Timber in the Ancient Mediterranean World*, Oxford, Clarendon Press.
- PASQUALINI M., BRUN J.-P., BOETTO G. (EDS)  
Forthcoming Telo Martius. *Une agglomération portuaire de la cité d'Arles (Recherches 1978-1988)*, Aix-en-Provence, PUP-CCJ, BiAMA.
- POMEY P.  
2004 Principles and methods of construction in ancient naval architecture, in F. M. Hocker, C. A., Ward (eds), *The Philosophy of Shipbuilding. Conceptual approaches to the study of wooden ships*, College Station, Texas A&M. University, p. 25-36.  
2011 Introduction. Nouvelles perspectives de recherche sur la batellerie gallo-romaine, in G. Boetto, P. Pomey, A Tchernia (eds), *Batellerie gallo-romaine. Pratiques régionales et influences maritimes méditerranéennes*, Aix-en-Provence / Paris, Centre Camille Jullian / Errance, BiAMA 9, p. 9-15.
- POMEY P., RIETH E.  
2005 *L'archéologie navale*, Paris, Errance.
- POMEY P., KAHANOV Y., RIETH É.  
2012 Transition from Shell to Skeleton in Ancient Mediterranean Ship-Construction: analysis, problems, and future research, *IJNA* 41, 2, p. 235-314.  
2013 On the Transition from Shell to Skeleton, *IJNA* 42, 2, p. 434-438.
- RICH S., NAYLING N., MOMBER G., SOLANA A.C.  
2017 *Shipwrecks and Provenance: in-situ timber sampling protocols with a focus on wrecks of the Iberian shipbuilding tradition*, Oxford, Archaeopress.
- RIETH É.  
2011 L'épave du chaland gallo-romain de la place Tolozan à Lyon: approche d'une tradition régionale de construction "sur sole" en relation avec l'architecture navale maritime méditerranéenne, in G. Boetto, P. Pomey, A Tchernia (eds), *Batellerie gallo-romaine. Pratiques régionales et influences maritimes méditerranéennes*, Aix-en-Provence / Paris, Centre Camille Jullian / Errance, BiAMA 9, p. 63-72.
- SHINDO L., GUIBAL F.  
Forthcoming Analyse dendrochronologique des épaves *Toulon 2 et 3-4*, in Pasqualini, Brun, Boetto Forthcoming
- WAZNY T.  
2002 Baltic timber in Western European – an exciting dendrochronological question, *Dendrochronologia* 20.3, p. 313-320.

# PRELIMINARY RESULTS OF THE WOOD ANALYSES OF THE ROMAN VESSELS OF CASKA, ISLAND OF PAG, CROATIA

Alba FERREIRA DOMÍNGUEZ, Frédéric GUIBAL, Giulia BOETTO and Irena RADIĆ ROSSI

## Abstract

Two assemblages compose the scuttled Roman vessels discovered in Caska inlet (Pag Island, Croatia): three sewn boats (Caska 1, 3 and 4) and one mortise-and-tenon constructed ship (Caska 2). While the wood species used for the construction of the sewn boats are quite similar (beech trunks split radially for planking), the construction of Caska 2 shows greater heterogeneity and more common use of conifer species for planking. The systematic identification of the wood species, the analysis of the morphological characteristics and the tree-ring dating of a large number of ship's components provide new insight into ancient Adriatic shipbuilding traditions.

## Keywords

Caska, dendrochronology, Pag Island, wood species, wood technology

## Résumé

Deux méthodes d'assemblages ont été observées sur les embarcations, coulées volontairement, découvertes à Caska (île de Pag, Croatie) : trois bateaux sont cousus (Caska 1, 3 et 4) et un quatrième est assemblé à tenons et mortaises (Caska 2). Si les essences de bois utilisées pour la construction des bateaux cousus sont assez similaires (troncs de hêtre fendus radialement pour le bordage), la construction de Caska 2 se révèle plus hétérogène et l'on observe une utilisation plus commune d'essences résineuses pour le bordé. L'identification systématique des essences de bois, l'analyse de leurs caractéristiques morphologiques et la datation des cernes d'un grand nombre des éléments des embarcations offrent un nouvel aperçu des traditions de la construction navale antique en Adriatique.

## Mots clés

Caska, dendrochronologie, île de Pag, essences de bois, technologie du bois

As part of the international project entitled CissAntiqua developed in 2009 by the University of Zadar (Croatia) and the University of Aix-Marseille, CNRS, Centre Camille Jullian (France), recent archaeological research in the Roman settlement of Caska, Pag Island, Croatia, has provided evidence of intense building activities, which occurred from the 1<sup>st</sup> century BC and lasted until the 4<sup>th</sup> century AD. The project, mainly focused on the submerged coastal structures, has led to the discovery of a remarkable group of vessels that were deliberately sunk after being filled with stones as part of the harbour construction. The group of scuttled vessels is composed of three sewn boats (Caska 1, 3 and 4) and one mortise-and-tenon constructed ship (Caska 2) (Boetto, Radić Rossi 2015, p. 279; Radić Rossi, Boetto 2020) (fig. 1).

During the underwater archaeological campaigns, the preserved ship elements were systematically sampled in order to study their morphology, to reconstruct the parent trunks and the way they were fashioned, and to identify the tree species. As the shipwrecks were devoid of cargo and the rare ceramic shards found in association with them belonged to the reuse phase of the vessels and offered a too wide chronological range, it was decided to carry out dendrochronological and accelerator mass spectrometry (AMS) dating in an attempt to date the felling of the trees used in the ship construction. Currently, the identification of the wood species has been completed, while dendromorphological, dendrochronological and AMS dating analyses are still in progress.

## 1. THE SEWN BOATS

Only the bottom of the hull of Caska 1 and 4 survived to a length of 8 m and 7 m respectively. Some parts of the former's sides were found nearby, broken and detached from the main structure, while the latter was particularly damaged. A large piece, 3.25 m long, and some detached fragments of a third sewn boat, Caska 3, were identified among the wooden elements of various origin thrown into the hold of a mortise-and-tenon constructed ship, Caska 2, before the fill of rocks. Caska 3, although poorly preserved, was similar to Caska 1.

Caska 1 and 4 are characterised by similar structural features (keels without chamfers, keyed-hook scarfs locked by vertical dowels, flush-laid strakes with simple overedge vegetal stiches (/// pattern), a wadding pad of vegetal fibres, crenelated frames, sequences of floor timbers without alternation with half-frames) and cross section (flat bottom with round turn of the bilge). The main differences concerned the arrangement of the frames (loose futtocks in Caska 1, futtocks scarfed and locked to the floor timbers in Caska 4), the system of assembly between frame and planking (treenails in Caska 1 and 3, external lashings in Caska 4), the larger room and space of the frame, and the addition of textile wadding pads in Caska 4.

Although it is difficult to reconstruct the original shape of the sewn boats from Caska due to the lack of information about their longitudinal form at the extremities, the original length of Caska 1, which was the best preserved of the group, could be estimated to 9-10 m. The boat could probably have been



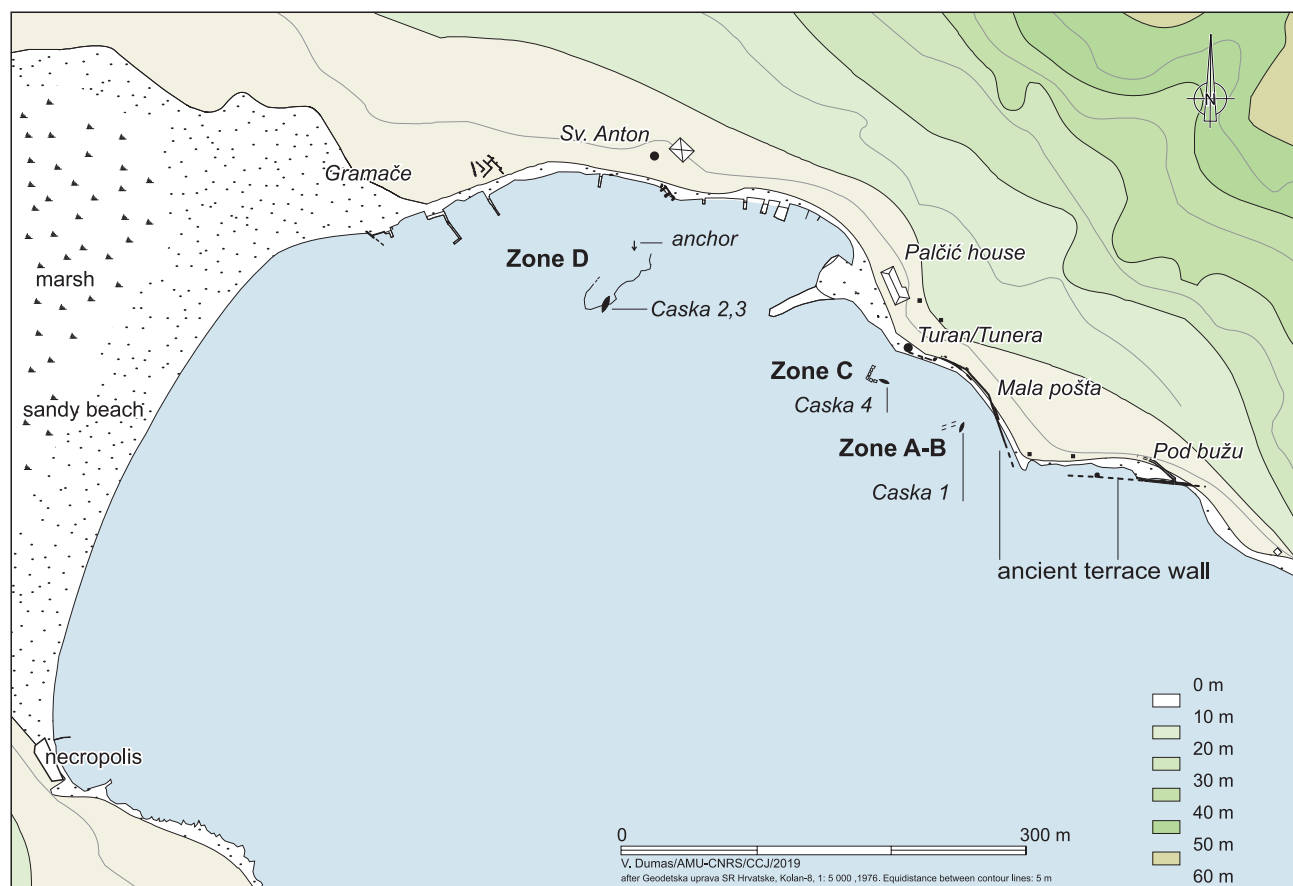


Fig. 1: Site plan of the archaeological evidence in Caska inlet (V. Dumas, AMU, CNRS, CCJ).

propelled either by sail or oars, although no trace of the propulsion system or steering devices was discovered on the shipwreck. It was a multipurpose boat, used in regional navigation for the transport of goods, animals and people, and for fishing.

The three sewn boats from Caska, according to their dimensions and architectural characteristics, were built and used locally or in the nearby region and belong to a local indigenous sewn-boat tradition. According to Pomey and Boetto (2019, p. 11-19), this northeastern Adriatic tradition of sewn boatbuilding dates back to the Late Bronze Age (Zambratija shipwreck) and survives into Roman times in connection with a well-defined sailing space, characterised by a multitude of islands and an indented coastline.

### 1.1. WOOD SPECIES

Twelve different wood species were identified, six belonging to broadleaved hardwood and six to softwoods trees (fig. 2). The correlation of wood species with different structural pieces is quite similar in the three boats.

Holm oak (*Quercus ilex* L.) was used for the keels of Caska 1 and 4. The transitional timber of Caska 1 was also made of holm oak, while the two transitional timbers of Caska 4 were made of deciduous oak (*Quercus* sp.)<sup>1</sup> and maple (*Acer* sp.). The

1. The wood of deciduous *Quercus* species cannot be differentiated on the basis of their wood anatomy (Schweingruber 1978, p. 144).

horizontal keys of the keel scarfs of Caska 1 and 4 were made, respectively, of holm oak and of beech. The three vertical dowels locking the keel scarfs of Caska 4 were made of dogwood (*Cornus* sp.).

The planking was homogeneously made of beech (*Fagus sylvatica* L.) (fig. 3). The sole fragment of wale preserved in the group belonging to Caska 1 was made of holm oak. Fir (*Abies* sp.) was systematically used for the small pegs locking the stitching of the planking, and other conifers were also used, in particular in Caska 4.

In Caska 1, the frames were mostly made of deciduous oak with one exception for the detached V-shaped floor timber of beech. In the frame of Caska 4, holm oak was dominant with a few pieces made of deciduous oak. Olive wood (*Olea europaea* L.), beech and holm oak/kermes oak (*Quercus ilex* L./*Q. coccifera* L.)<sup>2</sup> were used for the trenails of Caska 1 and 3. The external lashing of Caska 4 employed different wood species for the pegs locking the stiches (dogwood, beech, fir).

2. The anatomy of holm oak and kermes oak cannot be differentiated (Akkemik, Yaman, 2012, p. 176). The assignment to one or another species of oak is possible on the basis the type and the size of the ship element. For example, due to the shape and dimensions of the kermes oak, it is impossible that this wood would be used for the keels or the frames. On the other hand, for the small assembly elements, such as trenails, tenons or pegs, its use cannot be excluded.

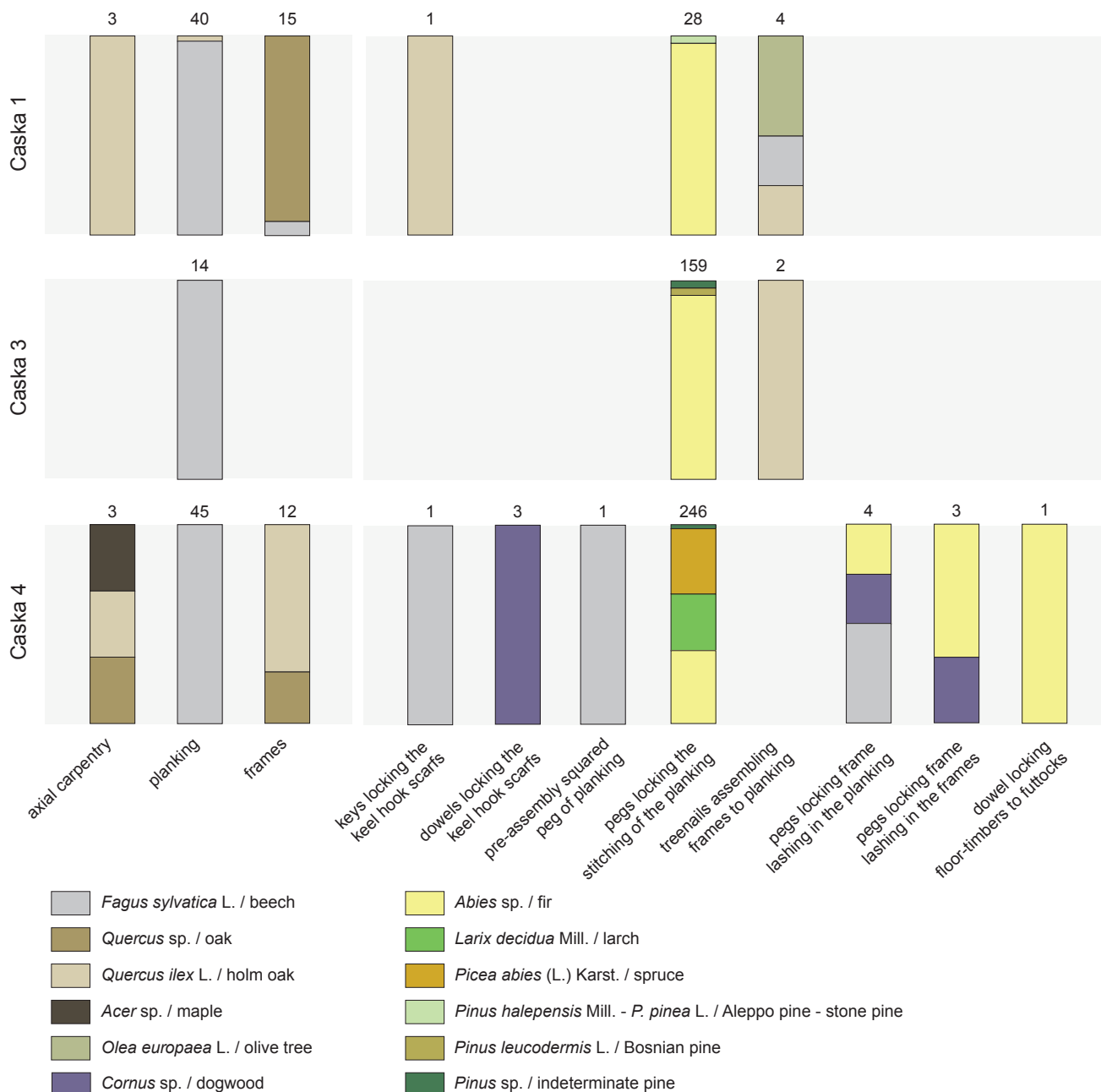


Fig. 2: Distribution of the different wood species of the sewn boats from Caska (A. Ferreira Domínguez, AMU, CNRS, CCJ).

## 1.2. WOOD TECHNOLOGY

An examination of the morphology of the architectural pieces of the three sewn boats and measurements of the ring-widths allow us to point out interesting similarities in the construction and in the selection of trees.

The keels and transitional timbers were made from squared trunks, using trees of around 11-14 cm in diameter, and about 60 years old. The planks were produced from beech trunks split radially, pith and bark being systematically removed. Marks of squaring axes confirm the radial splitting, probably by using wedges and maces. Parent logs were about 10-44 cm in diameter, and length would exceed 8 m, which is the minimum length of some of the preserved planks. The trees were older than 183 (Caska 1), 172 (Caska 3) and 142 years (Caska 4).

The presence of pith, sapwood, and sometimes bark in these frames allow us to calculate their initial diameter and thus the age of the parent log. Young branches or coppiced tree trunks of deciduous or holm oaks were hewn into halves or quarters for the frames. These branches or coppiced tree trunks were between 20 and 50 years old with an average diameter of 10 cm.

## 2. THE MORTISE-AND-TENON CONSTRUCTED SHIP, CASKA 2, AND ITS WOODEN FILL ELEMENTS

The remains of Caska 2 were 13 m long and consisted of a keel, nine strakes on each side (the ninth strake was the lower

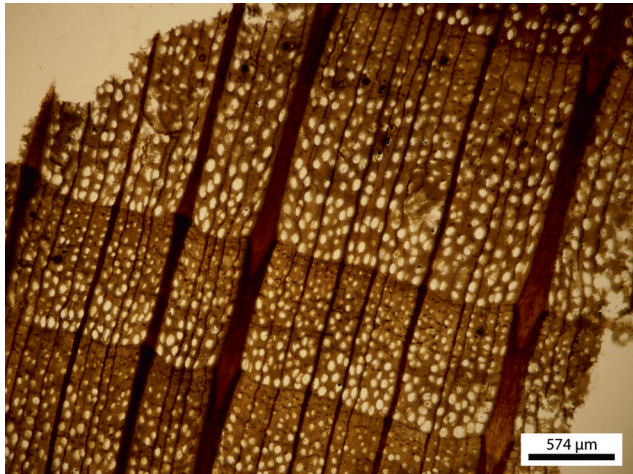


Fig. 3: Transversal section of beech wood (*Fagus sylvatica* L.) from Caska 3 (plank P7-1) (A. Ferreira Dominguez, AMU, CNRS, CCJ).

wale) connected to each other by mortise-and-tenon joints, 24 frames, a keelson/mast step and some stringers. Two of these stringers were planks with mortise-and-tenon joints reused from a scuttled ship. A hearth of mortar, tiles and bricks used for cooking was situated in the bow and settled on planks above the keelson and the frame. During its life, the hull underwent several refits as testified by patch tenons, graving pieces in the planking, and other internal reinforcements and frame repairs.

When scuttled, the bottom of Caska 2 was reinforced with wooden elements of various origins thrown into the hold before the filling of rocks. As previously mentioned, the sewn boat Caska 3 was found in this assemblage of wooden elements.

Caska 2 was a small sailing ship of around 15 m in length. It could have been used for the transport of different kinds of goods and could undertake longer voyages as demonstrated also by the presence of a hearth for cooking onboard. It is not possible to establish with any certainty the location of the place where the ship was built.

## 2.1. WOOD SPECIES

Eleven species were identified in the mortise-and-tenon constructed Caska 2: five hardwood and six softwood (fig. 4).

The keel and the stern transitional timber of Caska 2 were made of holm oak, and the stem transitional timber was made of Aleppo/stone pine (*Pinus halepensis* Mill./*P. pinea* L.)<sup>3</sup>. The planking was built mainly from Scots pine type (*Pinus t. sylvestris*)<sup>4</sup> and Aleppo pine/stone pine. Due to the presence of patch tenons in six of the planks of Aleppo pine/stone pine, it is possible that all the planks built with this wood species were repairs. Other planks in Bosnian pine (*Pinus leucodermis* L.) and an undetermined pine (*Pinus* sp.) could also be repairs. Three of the five identified graving pieces were made of Aleppo

3. As pointed out by Akkemik, Yaman (2012, p. 46), Aleppo pine and stone pine are difficult to differentiate due to their great anatomical similarity, thus we prefer to use a double classification.

4. The Scots pine (*Pinus sylvestris* L.), mountain pine (*Pinus uncinata* Ramond) and black pine (*Pinus nigra* Arnold) cannot be distinguished on the basis of their wood anatomy (Schweingruber 1978, p. 62, 1990, p. 129, 131).

pine/stone pine and elm (*Ulmus* sp.). Frames were mostly made from holm oak, with a few of them from deciduous oak, Aleppo pine/stone pine and Scots pine type. The frame repairs were made from holm oak, spruce (*Picea abies* (L.) Karst.) and from an indeterminate gymnosperm, while the internal reinforcements were from holm oak, elm and Aleppo pine/stone pine. The ceiling was built in Scots pine type, spruce, elm, poplar (*Populus* sp.) and fir. Holm oak/kermes oak was employed for tenons and treenails, and ash (*Fraxinus* sp.) for the small pegs locking the tenons. Finally, the planks used as a foundation for the hearth were made of Aleppo pine/stone pine, Scots pine type and fir.

Several softwood and hardwood species were also identified in the large number of discarded pieces thrown into the hold of the ship before scuttling. However, most of the planks (complete or fragmentary) without assemblages were homogeneously made of fir, only a few were made of spruce, holm oak and indeterminate pine. Other various pieces, such as stanchions, beams or bulkheads, small and big logs, and a pole were made of different types of woods species already attested in the other fill elements or in the ship structure.

The five fragments of planks with tenon-and-mortise joints discovered in the fill and not identified as ceiling were made of Scots pine type, elm, fir and indeterminate pine.

## 2.2. WOOD TECHNOLOGY

Dendromorphological analyses were carried out only on four frames of Caska 2 due to the lack of sampling and the difficulties of *in situ* analysis. As for the sewn boats, the presence of pith and sapwood rings allows a reliable reconstruction of the initial diameter and age of the parent logs. Branches or coppiced tree trunks were hewn into halves or quarters, offering between 26 and 55 rings for a diameter of about 8-12 cm.

The majority of samples were collected from the fir planks without assemblages belonging to the filling of Caska 2. Radial cuts were generally identified with a few exceptions involving tangential splitting. Trees used were up to 166 years old and at least 44 cm in diameter.

## 3. DATING

Only Caska 1 has been dated, to between 42 and 102 AD on the basis of the synchronisation on the <sup>14</sup>C calibration curve using a wiggle-matching method (Pearson 1986, p. 295-296) of six AMS dates on six samples taken on the same beech plank (P3)<sup>5</sup>. In the current state of the research, the dates of construction of the three other vessels found in Caska are still not precisely established.

In the sewn boats, planks were the most convenient for dendrochronology because they provided long tree-ring series. In addition, the radial splitting made it possible to measure the almost complete ring series formed by the trees. So, we were able to build four mean chronologies for beech: a 197 year-long

5. Laboratory codes Lyon-9267 (SacA29517), Lyon-9272 (SacA29522). We thank Christine Oberlin, Centre de Datation par le Radiocarbone (Lyon), who prepared the samples for the AMS dates through the ARTEMIS programme of the CNRS.

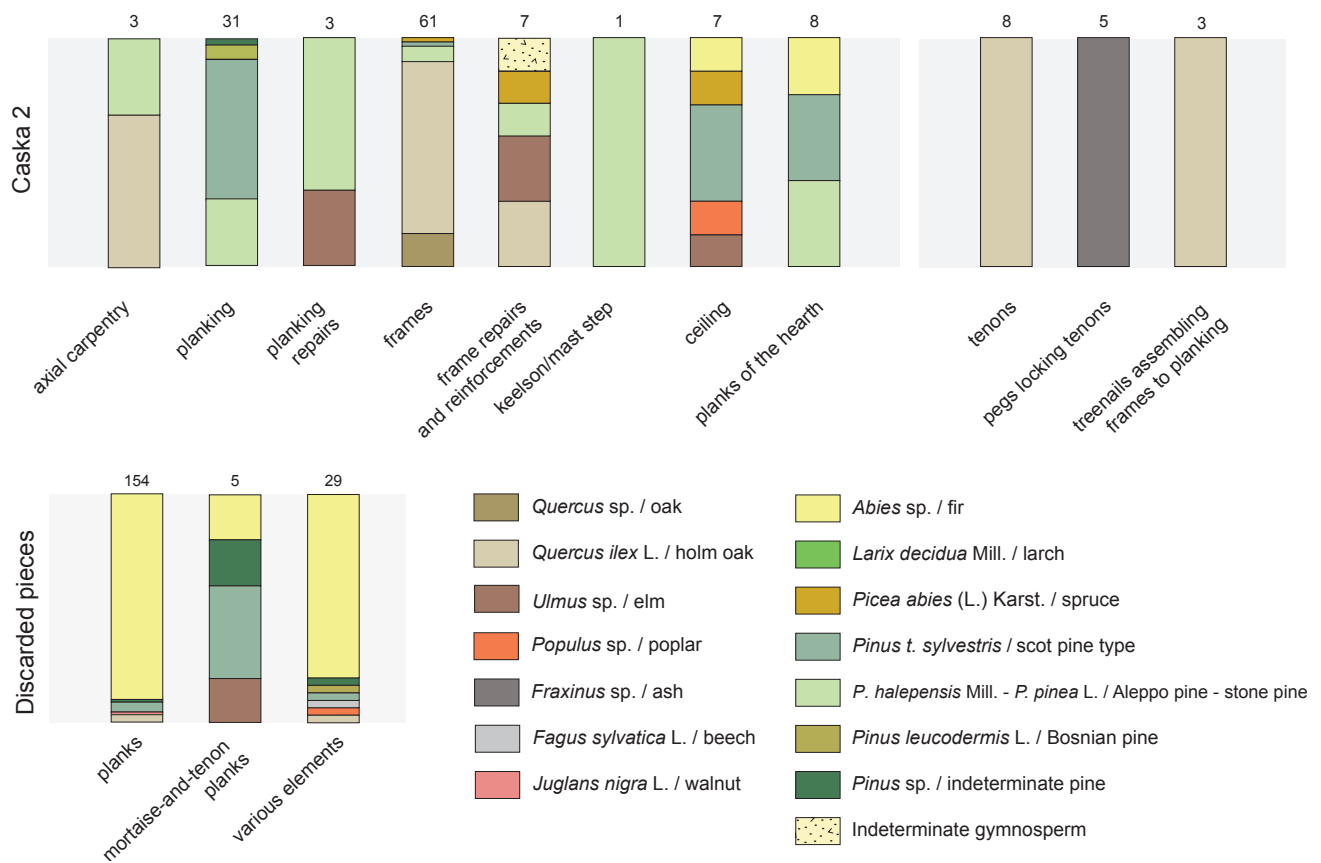


Fig. 4: Distribution of the different wood species of Caska 2 and of the discarded pieces (A. Ferreira Domínguez, AMU, CNRS, CCJ).

chronology for Caska 1, a 165 and a 200 year-long chronologies for Caska 3, and a 163 year-long chronology for Caska 4.

In addition to that, the analysis of the radial-cut planks belonging to the internal fill of Caska 2 allowed us to build up a fir mean chronology 197 years long.

Statistical tests aimed at cross-dating ring-width of the Caska series are in progress. Given the absence of a Croatian dendro-chronological database for Antiquity, we will try to cross-correlate our series with datasets developed in Slovenia, northern Italy, and Austria. If our attempts are unsuccessful, we will try to date our mean chronologies by combining AMS <sup>14</sup>C dates with the wiggle-matching method.

#### 4. CONCLUSION

In the current stage of the research, the most interesting results come from the analysis of the types and morphologies of wood species used in the construction, coupled with the study of their occurrence and distribution within the ship construction.

All the species identified in the tenon-and-mortise ship Caska 2 are commonly attested in Greek-Roman Mediterranean shipbuilding. Their distribution within the ship structure is in accordance with specific choices that prefer conifer species for planking due to their elasticity, which makes them flexible enough to be shaped according to shell-first processes (Guibal, Pomey 1998, p. 435-436, 2003, p. 36), and hardwood species

(such as deciduous or holm oaks) for keels, frames and assemblages due to their high resistance qualities (Rival 1991, p. 54; Guibal, Pomey 1998, p. 432-435, 2003, p. 36 and 38).

Besides the common use of hardwoods for keel and frame, the sewn boats of Caska show the particularity of planking entirely built from beech wood, despite its bad resistance to humid conditions (Teissier du Cros *et al.* 1981, p. 384-385; Bary-Lenger *et al.* 1988, p. 160). Consequently, it is probable that a number of different reasons other than wood quality played a role in the selection of beech for the sewn boats. Since beech is particularly suitable for radial splitting, shipbuilders precisely selected this type of wood because they could obtain long and straight planks with mechanical properties (Rival 1991, p. 125) well adapted to the characteristics sought for the sewn boats they were building. In addition, it is probable that beech forests of northern Dalmatia were then larger than today and located closer to the coast, therefore the availability of the wood resource surely had an impact on the choice of ancient shipbuilders: they could easily supply their shipyards. Another particularity of the sewn boats consists in the specific use of fir or, to a lesser extent, other conifer species for the small pegs locking the planking stitching assemblies.

Lastly, it is worth noting that the same type and distribution of wood species have also been recorded in the Pula 2 sewn boat found in the Roman harbour of Pula (Istria, Croatia), which is quite similar from an architectural point of view to the Caska 1 (Boetto *et al.* 2017, p. 196; Pomey, Boetto 2019, p. 10).

As previously underlined, the sewn boats of Caska belong to a strong local shipbuilding tradition. Thus, the existence of



local shipyards building sewn boats in Dalmatia is certain. From the wood analysis it is possible to advance the hypothesis that these local shipyards imported timber from mountainous areas located near the Dalmatian coast, such as the Velebit, Učka or Čičarija mountains, where forests of beech, fir and spruce are still nowadays particularly abundant (Nikolić *et al.* 2010, p. 426, 445; Nikolić 2015).

Dendromorphological and dendrochronological analyses show the variety of timbers used and how they were worked. On the one hand, for frames and axial carpentry, young logs, branches or coppiced trees were very slightly squared, keeping the original diameters. On the other hand, century-old beech or fir trees were radially split to obtain straight planks. Before

shaping, the trunks used could easily reach 200 years of age and 50 cm in diameter.

In conclusion, it is expected that our study will make it possible to better understand the development of the northeastern Adriatic sewn-boat tradition and, perhaps, its relationships with other different shipbuilding traditions, such as that attested on the Caska 2 shipwreck. Our research also underlines the necessity of setting up a dendrochronological database in Croatia. This country, with its exceptional wealth of well-preserved ancient shipwrecks and other wooden structures, will certainly supply new data through the systematic combination of underwater research, nautical and maritime studies, and wood analyses.

## REFERENCES

- AKKEMIK U., YAMAN B.  
2012 *Wood anatomy of eastern Mediterranean species*, Remagen, Kessel Publishing House.
- BARY-LENGER A., EVRARD R., GATHY P.  
1988 *La forêt*, Liège, Editions du Perron (3<sup>rd</sup> ed.).
- BOETTO G., RADIĆ ROSSI I.,  
2017 Ancient Ships from the Bay of Caska (Island of Pag, Croatia), in J. Litwin (ed.), *Baltic and Beyond, Change and Continuity in shipbuilding, Proceedings of the Fourteenth International Symposium on Boat and Ship Archaeology (ISBSA 14), Gdańsk 2015*, Gdańsk, National Maritime Museum, p. 279-288.
- BOETTO G., KONCANI UHAČ I., UHAČ M.  
2017 Sewn Ships from Istria (Croatia): the shipwrecks of Zambratija and Pula, in J. Litwin (ed.), *Baltic and Beyond, Change and Continuity in Shipbuilding, Proceedings of the Fourteenth International Symposium on Boat and Ship Archaeology (ISBSA 14), Gdańsk 2015*, Gdańsk, National Maritime Museum, p. 189-198.
- GUIBAL F., POMEY P.  
1998 Dendrochronologie et dendromorphologie, in G. Volpe (ed.), *Archeologia Subacquea, VIII Ciclo di lezioni sulla ricerca applicata in archeologia, Certosa di Pontignano, Siena 1996*, Firenze, Edizioni All'Insegna del Giglio, p. 425-446.
- 2003 Timber Supply and Ancient Naval Architecture, in C. Beltrame (ed.), *Boats, Ships and Shipyards, Proceedings of the Ninth International Symposium on Boat and Ship Archaeology (ISBSA 9), Venice 2000*, Oxford, Oxbow books, p. 35-41.
- NIKOLIĆ T.  
2015 *Flora Croatica Database*, Faculty of Science, University of Zagreb. <http://hirc.botanic.hr/fcd>
- NIKOLIĆ T., TOPIĆ J., VUKOVIĆ N.  
2010 *Botanički važna područja Hrvatske*, Zagreb, Školska knjiga i Prirodoslovno-matematički fakultet.
- PEARSON G.W.  
1986 Precise calendrical dating of known growth-period samples using a "curve fitting" technique, *Radiocarbon* 28, p. 292-299.
- POMEY P., BOETTO G.  
2019 Ancient Mediterranean Sewn-Boat Traditions, *IJNA* 48.1, p. 5-51.
- RADIĆ ROSSI I., BOETTO G.  
2020 The Roman Scuttled Ships and Harbour Structures of Caska, Pag Island, Croatia in their Cultural and Historical Context, *IJNA* 49.2, p. 263-290.
- RAMEAU J.-C., MANSION D., DUMÉ G., GAUBERVILLE C.  
2008 *Flore forestière française, Tome 3, Région méditerranéenne*, Paris, IDF.
- RIVAL M.  
1991 *La charpenterie navale romaine : matériaux, méthodes, moyens*, Paris, Editions du CNRS, Travaux du Centre Camille Jullian 4.
- SCHWEINGRUBER F.H.  
1978 *Mikroskopische Holz-anatomie, Anatomie microscopique des bois, Microscopic wood anatomy*, Zug, Zürcher AG.
- 1990 *Anatomie europäischer Hölzer, Anatomy of European Woods*, Bern und Stuttgart, Haupt.
- TEISSIER DU CROS E., LE TACON F., NEPVEU G., PARDÉ J., PERRIN R., TIMBAL J.  
1981 *Le Hêtre. Monographie*, Paris, INRA, Département des Recherches Forestières.

# THE BREMEN-COG: ENVIRONMENTAL ISSUES

Mike BELASUS, Aoife DALY and Adolfo Miguel MARTINS

---

## Abstract

The Bremen-Cog was dated by dendrochronology in the 1960s when the discipline was in its infancy. The felling date of winter 1378/79 in the Weser Uplands was established and confirmed in 2007. In 2016 a new comprehensive analysis of the ship was made possible. All analysed samples are from trees likely felled in the last quarter of the 14<sup>th</sup> century in the direct hinterlands of Bremen. Furthermore, an attempt at tree morphology reconstruction and a detailed investigation into the trees' growing features were carried out, revealing a poor timber quality, which was originally not necessarily intended for the purpose of shipbuilding.

## Keywords

Dendrochronology, dendroprovenance, northwest Europe, medieval ship, timber quality

## Résumé

La cogue de Brême avait été datée par dendrochronologie dans les années 1960, alors que la discipline en était encore à ses balbutiements. On avait pu alors établir une date d'abattage des arbres pendant l'hiver 1378/79 dans les Weser Uplands, ce qui a été confirmé en 2007. En 2016, une nouvelle analyse complète du navire a été réalisée. Tous les échantillons analysés proviennent d'arbres probablement abattus dans le dernier quart du xiv<sup>e</sup> siècle dans l'arrière-pays proche de Brême. En outre, une tentative de reconstruction de la morphologie des arbres et une enquête détaillée sur leurs caractéristiques de croissance ont révélé la mauvaise qualité du bois, qui ne semblait pas destiné, à l'origine, à la construction navale.

## Mots clés

Dendrochronologie, provenance du bois, Europe nord occidentale, navire médiéval, qualité du bois

---

After its recovery from the Weser River in 1962 just 4 km west of Bremen's medieval centre, the Bremen-Cog, a late 14<sup>th</sup>-century ship built according to the "Bremen-Type" shipbuilding method<sup>1</sup>, was primarily seen as a technical monument from the heydays of the Hanseatic League. Even though it was reconstructed within the German Maritime Museum in Bremerhaven, which opened its gates in 1975, it took many years before the construction of the ship was analysed following an archaeological approach.

During the project entitled "From the North Sea to the Norwegian Sea – Interdisciplinary research on the Hanse" funded by the Leibniz Association at the German Maritime Museum, the ship became the focus of archaeological investigation, when the question about the technical basis of Low German shipwrights for the building of seagoing ships was raised. A generous contribution from the support society of the museum (Förderverein Deutsches Schifffahrtsmuseum e.V.) enabled a comprehensive dendrochronological analysis of the ship's timbers. This analysis was linked to the ERC-funded project "TIMBER", within which research on the ship is currently continuing, and was extended with the analyses of the timber quality and an attempted reconstruction of tree morphology patterns based on the outboard planking.

Apart from still being the best preserved late medieval cargo vessel in northwest Europe more than 50 years after its discovery, and the basis for the technical definition of a particular shipbuilding method, the Bremen ship also played a role in the development of a reliable oak chronology in this part of the

continent. While dendrochronology here was in its infancy during the 1960s, the Bremen-Cog turned out to be the first archaeological find of the area whose timber's provenance could be established on the base of dendrochronology (Haneca *et al.* 2009, p. 6).

## 1. EARLY DENDROCHRONOLOGY

At that point in time there were no reliable chronologies for the North German Plain. While in southern Germany climate signals were distinctly visible in the ring growth pattern of oak trees, the situation in the north proved to be more difficult and at the time of the ship's discovery there was no reliable coverage of master chronologies.

Nevertheless, three samples from the ship could be dated on the basis of the, at the time, recently constructed south German master chronology, which was made using more than 1000 analysed dendrochronology samples from upper and lower Franconia and Hesse (fig. 1). From these samples, one provided a bark edge dated to winter 1378/79. The comparison with a site chronology from Ziegenhain/Kassel (Bauch 1969, p. 125), and a historical investigation by J. Delfs (1952), which gives evidence for timber rafting on the Weser to Bremen already during the 13<sup>th</sup> century, narrowed the origin of the dated construction components down to the Weser Uplands about 200 km upstream from Bremen (Liese, Bauch 1965; Bauch 1969). In 2007 the published data on this early analysis was reanalysed on the basis of a widely extended base of chronologies and confirmed dating and provenance for two of the three early dated samples (Daly 2007, p. 115-116).

---

1. "Bremen-Type" refers to the shipbuilding method defined on the basis of the Bremen-Cog. It is used here to avoid the term "Cog/Kogge" as an archaeological/technical definition, which can lead to contradictions and misunderstandings (Belasus 2017a).

## 2. NEW DENDROCHRONOLOGY AND INVESTIGATIONS INTO TIMBER MORPHOLOGY

During archaeological investigations between 2015 and 2018 the opportunity was taken to carry out new comprehensive dendrochronological analyses of the ship's timbers that benefitted from an extensive coverage of oak chronologies for the North German Plain. This had been developed over a period of more than 50 years since the original dating of the ship (Daly 2017). The aim of these new analyses was to discover information on timber procurement for shipbuilding purposes in Bremen.

The strategy for the new analysis of the Bremen ship was to sample as much as possible a wide variety of the ship's construction components. Sampling was carried out by coring, using a specially designed borer that bores a 16 mm diameter hole in the timber, to a maximum depth of 30 cm. The core extracted is 6 mm wide. The position of the coring is aimed at maximising the number of rings retained in the core, from the outermost towards the original centre of the tree. The timbers are assembled in the reconstructed ship, so sampling took place during April 19-22, 2016, on *in situ* timbers chiefly inboard of the hull: a few were also taken from outboard hull planks. Care was taken to spread the sampling around the hull so that a representative sample of timbers was achieved.

Of 78 analysed timbers, 55 were successfully dated (including the three from Bauch's analysis). Only heartwood was observed in most timbers, and the estimated felling date of the trees from which the samples came was in agreement with Bauch's estimated building date of the Bremen ship at around AD 1380. In other words, no evidence of later additions to the ship has emerged in this analysis. This underlines the interpretation that this ship was not an old ship when it sank.

Of all the dated samples, just three have sapwood preserved. One of the timbers sampled by Bauch had complete sapwood to bark edge, but this was not the case for any timbers examined in this analysis.

Using the correlation between every dated tree-ring curve with every other, the material can be divided into a small number

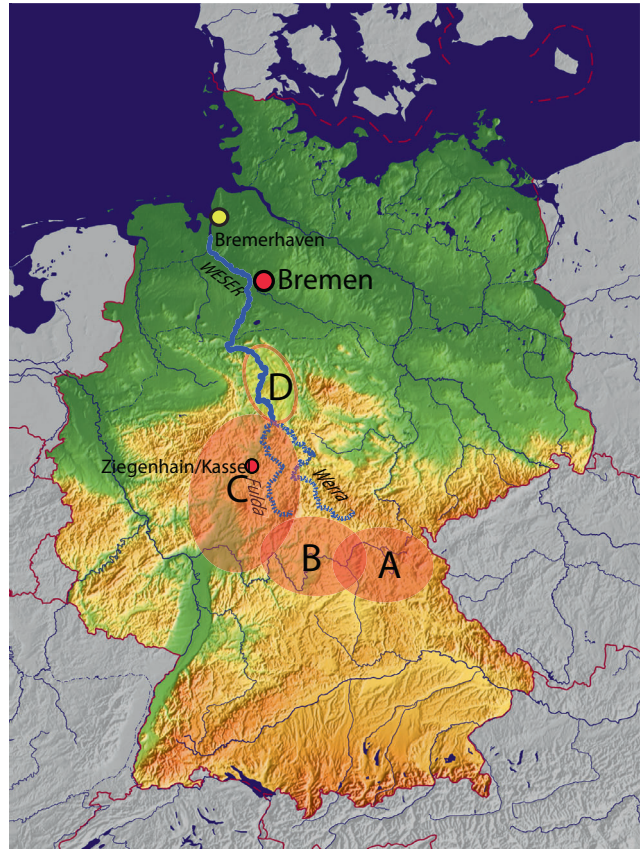


Fig. 1: Map of Germany with the Weser passing through Bremen and Bremerhaven in the North German Plain. The headstreams, Fulda and Werra, unite in the southern part of the Weser Uplands (D). The regions producing the samples for the south German main curve are Upper Franconia (A), Lower Franconia (B) and Hesse (C) with Ziegenhain/Kassel (Drawing M. Belasus using a ginkgomaps.com base map).

of groups. Averages for each group have been calculated. The groups are a mixture of different components from the ship. No apparent differentiation can be made between the outer planks of the hull and its inner timbers.

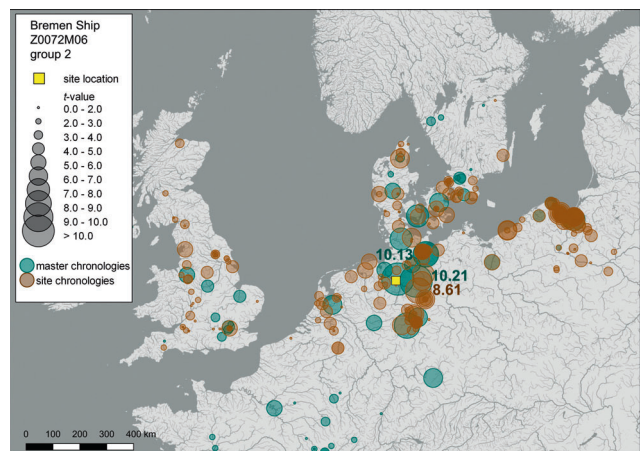
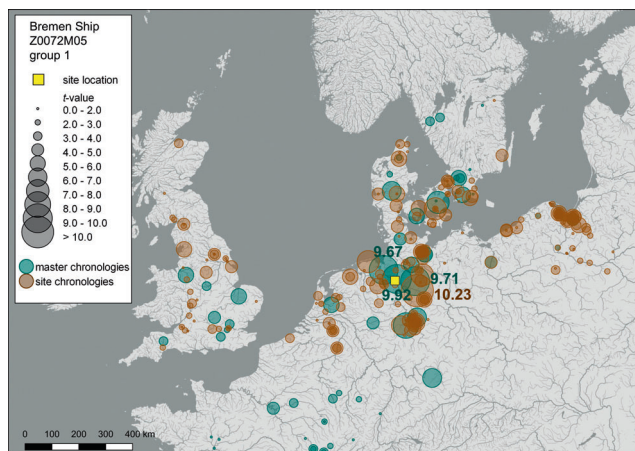
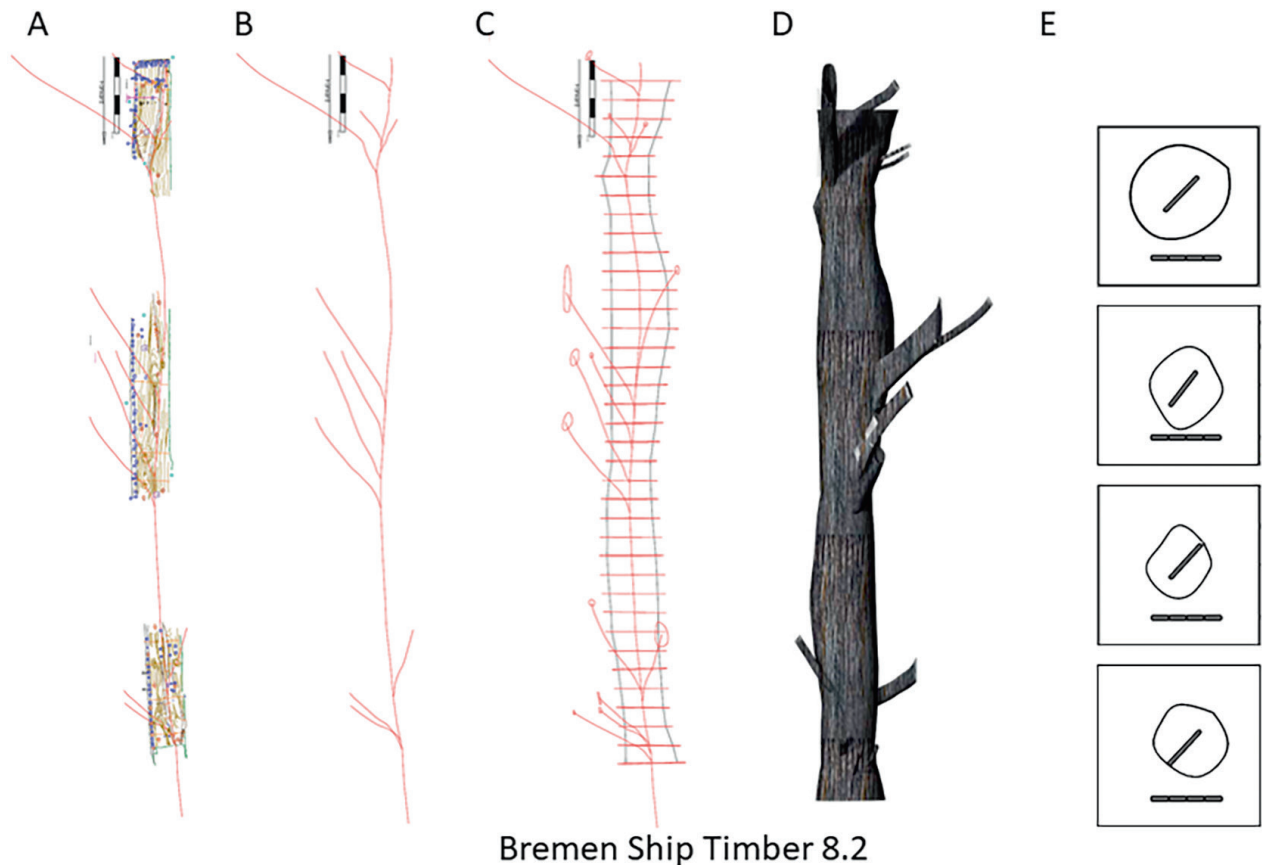


Fig. 2: Maps showing the correlation between the two dendrochronological groupings of timbers from the Bremen Ship (A: Group 1; B: group 2). The correlation statistic, Student's t-test, is plotted using circles. The higher the t-value, the larger is the circle. The average for each group is compared with an extensive tree-ring dataset for oak in Northern Europe. The turquoise circles represent large regional master chronologies while the brown circles represent local site chronologies (See Daly 2007 for a detailed explanation of the method). The river data is from Lehner & Grill (2013, [www.hydrosheds.org](http://www.hydrosheds.org), accessed 3 March 2020). (Drawing A. Daly).





### Bremen Ship Timber 8.2

**Fig. 3:** An example of the reconstruction of a tree's morphology from a plank. In this example, a portable coordinate-measuring machine (Faro-Arm) was applied to document all the important features where they were accessible (A). The positions of branches and their growing directions are established (B). The shape and circumference of the original tree trunk is estimated (C) and combined with the assumed size of the evident branches at the time of the trees felling (D). From this information, the position of the plank in the original tree is established (E). (Drawing A. M. Martins).

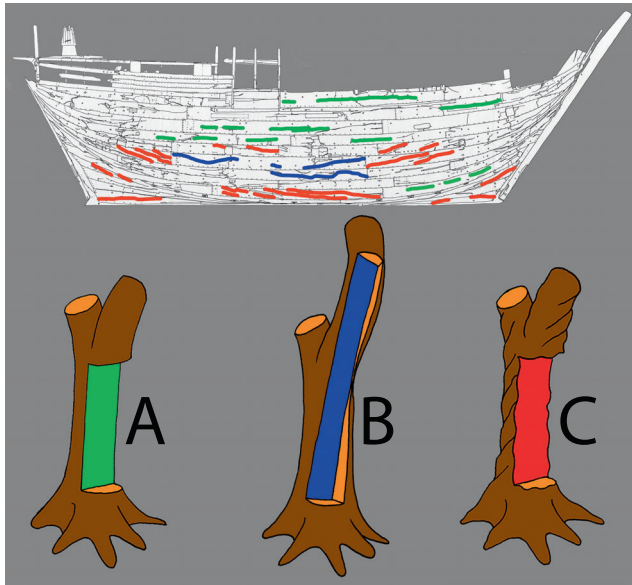
Group 1 is the largest group and it is made from the tree-ring curves of 34 timbers. It is 243 years in full length, but a version of the average version is made with a minimum of five trees in depth, and this is 164 years in length, and covers the period AD 1186 to 1349. The correlation between the average for this group and a wide range of site and master chronologies is mapped in fig. 2A. The group achieves the highest correlation with datasets around the Bremen hinterland. This seems to indicate that the bulk of the timber for building the ship was harvested in the locality of the shipbuilding site.

Group 2 is made from just ten trees: most are framing timbers, but a pair of ceiling planks are also assigned to this group. The full length of the average for Group 2 is 262 years, but again a reduced version, only including the period where at least five trees are represented, is made and this is 156 years long, covering the period AD 1163 to 1318. As the correlation between this group and site and master chronologies indicates, a source area within the Bremen hinterland is again most likely (fig. 2B). The remaining timbers that have not been assigned to a group are all dated with chronologies for Lower Saxony. To conclude, the provenance analysis of the Bremen ship presents no evidence of long distance transport of timber for its construction, apart from the two earlier analysed timbers by Bauch. Rather, we are seeing that the Bremen ship is chiefly built of timber from the Bremen hinterland.

The results of the dendrochronological analyses prompted questions about the available timber quality and tree morphology in the direct hinterland of a town like Bremen.

With the aid of structure-from-motion technology (a reflex camera and AGISOFT software), a portable coordinate measuring machine (Faro-Arm) and 3D modelling software (Rhinoceros 3D), three selected planks from the ship were documented and their morphological features (grain direction, tree rings, position of the pith and traces of branches) used to reconstruct a general morphology of the original trees and to allow us to describe their original nature (fig. 3) (Martins 2017; Colson 2017). The results of this attempt at reconstructing trees from planks gave enough information to characterise the trees' morphology and shed light on their growing conditions. The main characteristic is the number and position of branches, which are distributed all over the trunk. A tree creates branches to have its leaves catch sunlight for photosynthesis. In a dense population of trees the branches would be concentrated in the upper part of the trunk. The lower part would be for the most part branchless, as leaves here would not get enough light to thrive. When a tree grows in a rather open landscape and catches light from all directions it will produce branches all over its trunk, as is the case with the trees used for building the Bremen ship. It is therefore assumed that the trees present in the ship's outer planking were growing in a rather open landscape. However, the trees were not short but rather tall





**Fig. 4:** Distribution of different grain courses in the tangentially sawn planks of the Bremen ship and their origins in the tree. A: Planks sawn from the trunk of a straight-grained tree. B: Planks sawn from a crooked tree or a cut that was extended into a main trunk for the production of longer planks. C: Planks cut from trees with spiral grain (Graphic: M. Belasus using the 1980 University of Hannover's/German Maritime Museum's photogrammetry recording of the ship).

and wide, offering enough material for the production of planks with an average width of 0.506 m and up to 9.52 m long.

Further detailed investigation of the outer planking revealed a poor timber quality. From the detailed descriptions of all surviving timbers by Werner Lahn (1992), it had already become clear that over 50% of the outer hull planking was repaired during the building process. In some cases dead branches (knots) were cut out and a rectangular patch was placed to fill the hole, waterproofed with the aid of moss caulking and secured with clamps. Other repairs were needed on cracks that appeared in the planks. These were repaired using moss caulking and iron clamps. The investigation showed that not all dead branches were patched up and these fell out at a later point. They are evidence of ingrown deadwood, which occurs when it takes a tree too long to incorporate a broken or cut off branch. In other areas, the trees produced clusters of branches, giving evidence of the repeated removal of branches from the same spot. Apart from creating a weakness in the planks' strength, all branches divert the tree's grain in a straight trunk. When the tree is converted into about 0.05 m thick planks by means of tangential sawing, the fibres are cut regardless of their direction. The cut fibres create weaknesses, which often cause the planks to crack, and, if they are built into a ship's construction while the timber is still green (unseasoned), tension is created as they shrink during the drying process. The cracks follow the direction of the fibre.

That cracks occurring in the outer planking have been repaired is not an unusual observation on tangentially produced planks and this can also be seen in other ship finds, e.g. in Doel 1 or Poel 11. While Doel 1 is built from tangentially sawn oak planks, Poel 11's planks were produced from tangentially cleft pine trunks (Vermeersch, Haneca 2015; Belasus 2017b). In most cases these cracks appear longitudinal and rather straight and can easily be repaired without greater consequences. In the case of the Bremen ship longitudinal cracks appear to be a minority

(fig. 4 A). Other repaired cracks appear curvy, indicating a crooked trunk, or they are straight until they curve away at one end revealing the extension of the planks by cutting well into an adjacent main branch (fig. 4 B). However, the most numerous cracks in the ship's construction are the most disturbing. These cracks travel diagonally through the planks, in the worst cases cutting the plank in two from the overlapping plank above to the overlapped plank below, reducing the longitudinal strength the strake should have given to the hull structure and remaining inaccessible for proper repair. These cracks are the result of the twisted growth of the oak it was cut from (fig. 4 C). The twisted growth of trees is a phenomenon that can be genetic, however, it is often the result of severe injury to the trees phloem, a thin layer of cells just under the bark, the purpose of which is to conduct water and nutrients vertically from the roots up to the branches. When this phloem is cut in one area, the tree is able to prevent the parts of the tree directly above the injury from being deprived of nutrients by creating alternative diagonal cell connections to bridge the injury. This causes a 're-programming' of the phloem's cell structure. Each new layer in the following years will circle diagonally around the trunk. The phloem becomes sapwood and, in the years to follow, hardwood with twisted grain (Kubler 1991). Spiral grain does not necessarily weaken the timber: as long as it is used as a full block and the angle of the twist does not exceed 37°, it can even add strength to the timber (Leelavanichkul, Cherkaev 2004, p. 134). This is, for example, the case with the recovered capstan of the vessel.

### 3. CONCLUSIONS

The recently carried out extensive dendrochronological analyses of the building timbers of the Bremen-Cog did not change the previous date of a felling in winter 1378/79. Neither did the components of the ship, which were successfully analysed before, experience a change in their provenance in the Weser Uplands during the re-examination of their published curves. Nevertheless, now that we have a massively extended dataset of regional oak chronologies for the North German Plain, we can state that all trees in the new analysis have their origin in the hinterland of Bremen, an area that was directly influenced by the town's interests.

The trees were far from being ideal for shipbuilding. The reconstruction of their basic morphology with branches all over their trunks from below to above places them in a rather well-lit park-like landscape. Their considerable size, indicated by the lengths and widths within the planks, indicate their location at the edge of a forest or in small patches of woods in the countryside. Ingrown deadwood, indicated by the dead, patched up or fallen out dead branches, confirm that they received no maintenance to ensure quality timber. However, the trees were most likely used during their growth. Clusters of knots confirm repeated removal of branches or twigs, and the evidence of twisted grain in many of the outer planks suggest severe damage to the trunks already early in their life.

The evidence speaks for woods whose main purpose was not as a source of quality timber but for other purposes, e.g. providing acorns to feed pig herds, as a hunting ground, or for collecting firewood. Why they were finally felled and converted into planks, and if these planks were originally intended for the purpose of shipbuilding is still unknown.

## ACKNOWLEDGEMENTS

The research presented in this paper is a result of activities within three research projects. Daly and Belasus are currently funded by the project entitled “Northern Europe’s timber resource – chronology, origin and exploitation (TIMBER)” (2016-2021), which has received funding from the European Research Council (ERC) under the European Union’s Horizon 2020 research and innovation programme (grant agreement No. 677152). Belasus was previously funded by the project “From the North Sea to the Norwegian Sea – Interdisciplinary research on the Hanse” (2015-2018), which received financing through

the Leibniz Competition 2015, funding line 4: “Promoting women for academic leadership positions” by the Leibniz Foundation, Germany, during which the dendrochronological analysis was generously financed by the support association of the German Maritime Museum (Förderverein Deutsches Schiffahrtsmuseum e.V.). Martins was funded through the project “ForSeaDiscovery”, supported by the People Programme (Marie Curie Actions) of the European Union’s Seventh Framework Programme (FP72007-2013) under REA grant agreement no. PITN-GA 2013-607545. The authors are very grateful to the German Maritime Museum for their generosity in allowing us to examine the Bremen ship.

## REFERENCES

- BAUCH W.  
1969 Die Bauzeit der Bremer Kogge, in Die Wittheit zu Bremen (eds), *Die Bremer Hanse-Kogge: ein Schlüssel zur Schiffahrtsgeschichte; Fund, Konservierung, Forschung*, Bremen, Röver, p. 123-126.
- BAUCH J., LIESE W., ECKSTEIN D.  
1967 Über die Altersbestimmung von Eichenholz in Norddeutschland mit Hilfe der Dendrochronologie, *Holz als Roh- und Werkstoff* 25, 8, p. 285-291.
- BELASUS M.  
2017a Historical Ship Archaeology in the Shadow of Historism and Nationalism. A German Perspective, in A. Brooks, N. Mehler (eds), *The Country where my Heart is: Historical Archaeologies of Nationalism and National Identity*, Gainesville, University Press of Florida, p. 222-241.  
2017b Connecting maritime landscapes. Or early modern news from two former ‘Baltic Cogs’ (Mecklenburg-West Pomerania, Germany), in J. Gawronski, A. van Holk, J. Schokkenbroek (eds), *Ships and Maritime Landscapes. Proceedings of the Thirteenth International Symposium on Boat and Ship Archaeology (ISBSA 13), Amsterdam 2012*, Eelde, Barhuis Publishing, p. 179-184.
- COLSON A.  
2017 Digital Documentation of Ships in Cultural Heritage: A European Review, in *International Archives of the Photogrammetry, Remote Sensing and Spatial Information Sciences*, Volume XLII-2/W5, p. 129-134.
- DALY A.  
2007 *Timber, Trade and Tree-rings. A dendrochronological analysis of structural oak timber in Northern Europe, c. AD 1000 to c. AD 1650*, PhD thesis, University of Southern Denmark.  
2017 Dendrochronological analysis of timbers from the Bremen Ship, Germany, *Dendro.dk Report* 46, Copenhagen (on line: at the German Maritime Museum, Bremerhaven, Germany).
- DELFS J.  
1952 *Die Floesserei im Stromgebiet der Weser*, Bremen, Dorn, Schriften der wirtschaftswissenschaftlichen Gesellschaft zum Studium Niedersachsens e.V. 34.
- HANECA K., ČUFAR K., BEECKMAN H.  
2009 Oaks, tree-rings and wooden cultural heritage: a review of the main characteristics and applications of oak dendrochronology in Europe, *Journal of Archaeological Science* 36, p. 1-11.
- KUBLER H.  
1991 Function of spiral grain in trees, *Trees* 5, p. 125-135.
- LAHN W.  
1992 *Die Bremer Kogge I*, Hamburg, Ernst Kabel Verlag, Schriften des Deutschen Schiffahrtsmuseums 30.
- LEELAVANICHKUL S., CHERKAEV A.  
2004 Why the grain in tree trunks spirals: a mechanical perspective, *Structural and Multidisciplinary Optimization* 28, p. 127-135.
- LEHNER B., GRILL G.  
2013 Global river hydrography and network routing: baseline data and new approaches to study the world’s large river systems, *Hydrological Processes* 27.15, p. 2171-2186. On line : [www.hydrosheds.org](http://www.hydrosheds.org).
- LIESE W., BAUCH J.  
1965 Das Alter der Bremer-Kogge, *Bremisches Jahrbuch*, p. 38-42.
- MARTINS A. M.  
2017 Reconstructing Trees from Ship Timbers: Data analysis and schematics, in R. Valera Gomes, K. Trápaga Monch (eds), *Árvores, Barcos e Homes na Península Ibérica (Séculos XVI-XVIII)*, Zaragoza, Instituto de Arqueologia e Paleociências da U.N.L., p. 63-76.
- VERMEERSCH J., HANECA K.  
2015 Construction Features of Doel 1, a 14<sup>th</sup>-Century Cog found in Flanders, *IJNA* 44.1, p. 111-131.



# TIMBER SUPPLY FOR *VASA*: NEW DISCOVERIES

Aoife DALY

---

## Abstract

Purchase records tell us that timber for building the *Vasa*, completed in Stockholm in 1628, was bought from southeastern Sweden, Königsberg and Amsterdam (Cederlund 1966). An extensive tree-ring analysis of the timbers used to build *Vasa* is revealing details of the use of timbers in the hull from different sources. As part of the project entitled “Northern Europe’s timber resource – chronology, origin and exploitation (TIMBER)” the study of the timber for *Vasa* can be directly compared to the historical record of timber purchases, so that details of the volumes of timber that were supplied from the different sources can be outlined.

## Keywords

Baltic oak, dendroprovenance, timber, trade, warship

## Résumé

Les registres d’achat des bois pour la construction du *Vasa*, achevé à Stockholm en 1628, révèlent que ceux-ci ont été achetés dans le sud-est de la Suède, à Königsberg, ainsi qu’à Amsterdam (Cederlund 1966). Une analyse approfondie des cernes des bois du *Vasa* révèle cependant une utilisation, dans la coque, de bois de provenances très diverses. Dans le cadre du projet intitulé « Les ressources en bois de l’Europe du Nord – chronologie, origine et exploitation (TIMBER) », l’étude dendrologique du *Vasa* est directement mise en rapport avec les registres d’achat des bois, de telle sorte que l’on peut détailler les volumes de bois provenant des divers lieux d’approvisionnement.

## Mots clés

Chêne baltique, provenance, bois d’œuvre, commerce, navire de guerre

---

Purchase records tell us that timber for building the *Vasa*, completed in Stockholm in 1628, was bought from Småland (southeastern Sweden), from Königsberg and from Amsterdam (Cederlund 1966). In terms of the dendroarchaeological evidence for a northern European timber trade in the early 17<sup>th</sup> century, each of these timber sources presents different stories. It is perhaps not surprising in a country dominated by extensive forest that timber from the wider hinterland of Stockholm is exploited. Timber was purchased from south of Stockholm, from estates between Kalmar and Norrköping, and from estates around Lake Mälaren, inland from Stockholm (Hocker 2011). In light of this, why would timber also be imported from abroad?

Let us look at the timber from Königsberg: we know that extensive export of timber, especially oak, took place from the towns along the southern and eastern Baltic coastline from the mid-14<sup>th</sup> to mid-17<sup>th</sup> centuries. The wood was most often converted into products ranging from clapboards, firewood, wainscots, boards and planks. Gdańsk dominated as a timber export hub, but other towns also supplied timber to be loaded onto ships to bring the product to the West. We see this trade in the dendrochronological record, particularly oak panels that were produced as an essential artists’ material for ecclesiastical sculpture and for fine art (e.g. Hillam, Tyers 1995; Wazny 2002; Daly, Streeton 2017). By the 17<sup>th</sup> century, we also see this so-called Baltic oak used for shipbuilding. The forests that were exploited seem to have been from a very extensive region. While several oak tree-ring datasets have been built for around the Vistula River, with its port of Gdańsk, and for historic sites around the Gulf of Gdańsk, that allow us to identify Baltic oak in Western Europe, we still do not know precisely where a large amount of this Baltic timber originally grew. Through the dendrochronological analysis of oak panels that are the supports for paintings by many of the artists working during the time of the Dutch and Flemish Golden Age, groups of oak panels

whose tree rings match well together have been identified. It was in the 1980s, after the construction of chronologies for northern Poland, that the Baltic source of this wood was identified (Baillie *et al.* 1985; Eckstein *et al.* 1986). The groups from the paintings have been dubbed Baltic 1, Baltic 2 and Baltic 3 and these can be separated probably because they are from different locations in the wider Baltic region (Hillam, Tyers 1995). As we do not have extensive oak tree-ring datasets for the vast region east of the Baltic Sea coast, we still cannot say where the forests were that supplied the art market and indeed the shipbuilding market in the 17<sup>th</sup> century. With the uniquely detailed purchase records for *Vasa*, stating that rough-sawn oak planks were purchased in Königsberg and Riga (Hocker 2011), we might examine, through dendrochronological analysis, for which parts of the ship these Baltic planks were used, and to which Baltic group they belong.

Furthermore, according to the records, oak planks were purchased in Amsterdam. By the time of the building of *Vasa*, Amsterdam was importing all its timber. For example, *Batavia*, built in Amsterdam by the Dutch East India Company, and completed in 1628 (precisely the same year as *Vasa*) was made from timber from at least three sources: the planks are from the southern or eastern Baltic and from around Lübeck, and the frames are from Lower Saxony (Daly *et al.* forthcoming). If timber was purchased in Amsterdam for *Vasa*, where did this timber actually grow?

## 1. MATERIAL ANALYSIS

Evidently, in spite of detailed historical records of timber purchases, there are many questions. Therefore, an analysis of the actual ship timbers of *Vasa* was initiated, with a view to identifying the origin of each timber through dendrochronology.





**Fig. 1:** One of the gunports on *Vasa*: access to the end grain of hull planks and ceiling planks is possible. Furthermore, when the oak sill is removed (it can be seen lying on the deck) the cross sections of the sill and the frames can also be accessed (photography A. Daly).

*Vasa*'s hull is built of oak, while pine is used for some of the decks. The chief reason for performing extensive tree-ring analysis of the timbers used to build *Vasa* was to examine details of the specific use of timbers in the hull, from these different sources. The analysis is a major part of the project entitled "Northern Europe's timber resource – chronology, origin and exploitation (TIMBER)", in which scientific techniques for determining the provenance of timber (dendrochronology, stable isotopes and aDNA) are combined with archaeological and historical study. The opportunity to study the timber for *Vasa* allows us to directly compare the material evidence with the historical record of timber purchases, thus adding detail to the history of the logistics for a major shipbuilding endeavour in the early 17<sup>th</sup> century. The tree-ring analysis would also provide us with details of the volumes of timber that were supplied from the different sources and where the different timbers were used in the ship. Also, the differences in timber conversion can be correlated with the identification of source, giving us insight into timber availability from different regions. Finally, when it is possible to identify timbers from the same parent tree, some insight into the operational chain of the shipbuilders is possible.

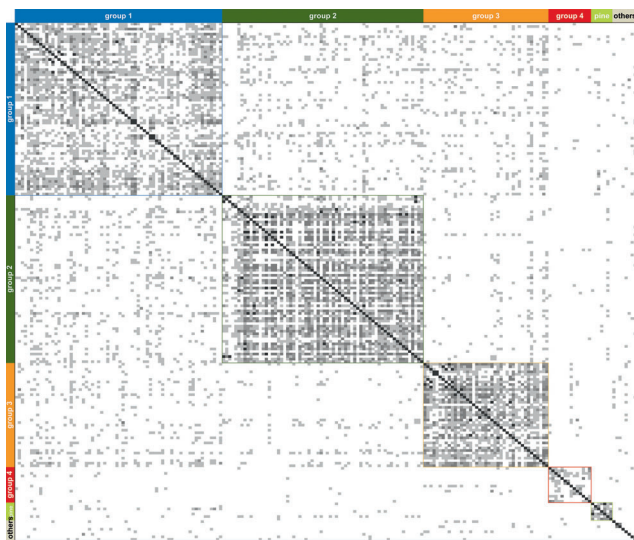
## 2. ATTAINING MEASUREMENTS

There are many ways to gain access to a cross section of historic timbers, to enable an uninterrupted series of measurements through the annual growth rings of timber, from the innermost to the outermost preserved rings. For *Vasa* we wished to make a minimally invasive analysis. I adopted the technique that is employed when analysing panel paintings, where the end grain of the panel is gently cleaned and the measurements are gained directly, using

a magnifier, or photographed for later measurement. Particularly at the gunports on the upper and lower gundecks the cross section of the tree could be accessed for the ceilings and the outer hull planks (fig. 1). Also, by removing the oak sill, the cross sections of the sill itself and the frames, all oak, could be cleaned, photographed and later measured on computer screen. At the same time that I have been working through the *Vasa* timbers (chiefly during 2017), a team from the Museum has also been onboard replacing all the iron bolts that secure the wreck. Because of this, several deck planks had been lifted to enable access through the decks for the bolt replacement team and their equipment. Thus, cross sections of a number of these (oaks on the upper and lower gundecks and pine deck planks on the orlop deck) could also be accessed for tree-ring analysis. Various other locations onboard *Vasa* allowed access to timber cross sections, but as the work progressed it became clear that this sampling strategy meant that timber in the ship's uppers were analysed, while the lower decks were underrepresented. So, 42 timbers, chiefly in the lowest hull, were sampled by coring, using a dry-wood borer from the Rinntech company. Of these, 39 cores are analysed.

## 3. RESULTS

At the time of writing, 229 timbers (220 oak and nine pine) have been analysed, and of these, 203 timbers (195 oak and eight pine) have been dated. On the basis of the correlation between each timber's tree-ring curve with each other (at their dated positions), four distinct oak groups can be identified (fig. 2). These have been designated Group 1 (blue), Group 2 (green), Group 3 (orange) and Group 4 (red). The pines form their own distinct group (lime green).



**Fig. 2:** The tree-ring curves from each timber analysed from *Vasa* are compared with each other (correlation). The grey shades indicate the correlation values, but in order to simplify the illustration these values are not presented. Four main groups have been identified.

The tree-ring curves in each group are averaged, so that one curve represents each group. The provenance of each group is examined by mapping the correlation between each group average and a large network of master and site chronologies for oak for Northern Europe (fig. 3).

### 3.1. PROVENANCE GROUPS 1 AND 2

The Group 1 average is 220 years in length, and covers the period AD 1404-1623. It achieves the highest correlation ( $t$ -value) with a wide spread of chronologies but none of the  $t$ -values are greater than just under 6.00 (fig. 3A). It is highly possible that this group represents timber purchased in eastern Sweden, as mentioned in the written sources.

The average for Group 2 is 296 years long and covers the period AD 1330-1625. It is made from 47 timbers in Group 2 that form a core of highly correlated tree-ring curves in the group. This group is dating broadly with tree-ring datasets but it does not achieve correlations high enough to allow a firm identification of the timber source.

The averages for Groups 1 and 2 match well together ( $t = 5.15$ ). It is probable that Group 2 also represents trees that grew in eastern Sweden. It has proven difficult to confirm this however, because there are no extensive chronologies for oak for eastern Sweden from the period. Therefore, in the TIMBER project we are working on ways to solve this. One way is to build chronologies from the region if oaks from historical buildings can be located. We are looking to see if other scientific techniques can help, particularly stable isotopes that might indicate provenance. This technique has been applied, for example, in studies at Hedeby/Schleswig in northern Germany (e.g. Grupe *et al.* 2011) and on timber from ships (e.g. Rich *et al.* 2016; Hajj *et al.* 2017).

In the meantime, as luck would have it, in 2017, remains of a large ship were excavated at Skeppsholmen in Stockholm, by Jim Hansson (see Hansson in this volume). Eleven oak and two pine samples were dendrochronologically dated by the author demonstrating that oaks for the ship were felled in spring 1613

and winter 1613-14 (Daly 2017) and pine sheathing was added after AD 1623 (Daly 2018). This allowed the identification of the ship as *Scepter*, built in 1615 for Sweden's King Gustav II Adolf. The ship ran aground in 1621, so the pine sheathing might have been a necessary addition after that (see Hansson in this volume). The tree-ring curves from the oak timbers from *Scepter* cross-date with many of the timbers from *Vasa*, particularly with *Vasa* Groups 1 and 2 (see table 1). This indicates one source for the timbers for building *Scepter* and some parts of *Vasa*. The written sources tell us that *Scepter* was built at Biskops Arnö in Lake Mälaren (see Hansson in this volume), and we might assume that the timber for *Scepter* was harvested around that lake. Now we know that some timber for *Vasa* was purchased from estates around Lake Mälaren, the same area in which *Scepter* was built. The tree-ring data we have extracted from the *Scepter* show us that *Vasa* Groups 1 or 2 indeed represent the timbers for *Vasa* that were purchased in eastern Sweden.

Indeed these analyses also link us to another ship, *Batavia*, built in 1628. One single timber from *Batavia* (out of 53 dated timbers) matches best with the *Vasa* and *Scepter* tree-ring datasets (Daly *et al.* forthcoming).

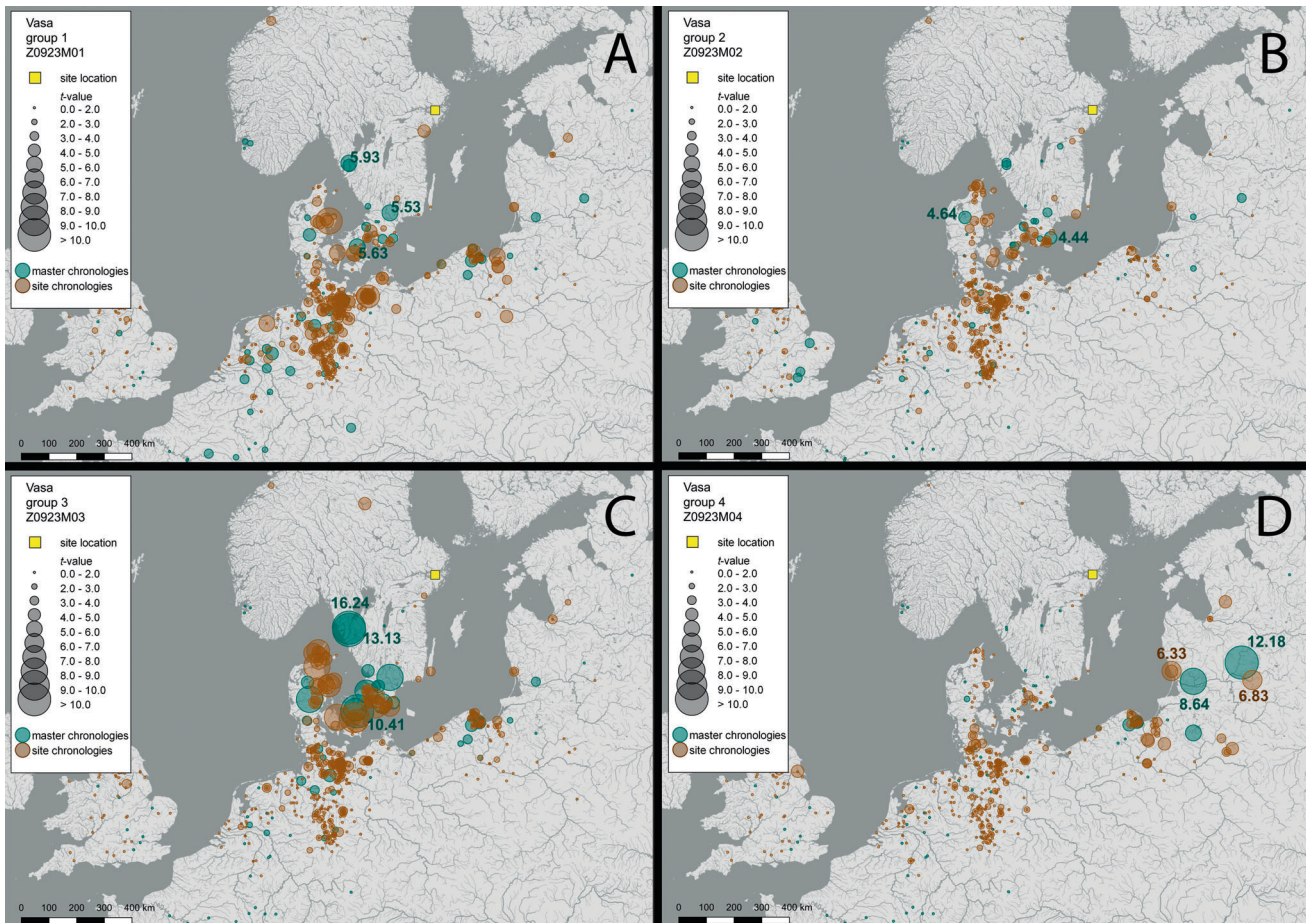
### 3.2. PROVENANCE GROUP 3

The average for Group 3 consists of 41 timber elements, representing 31 trees (some trees supplied several timber components in the ship, as the analysis has indicated). The average is 291 years long, covering the period AD 1328-1618. The map of the correlations between the Group 3 average and master and site chronologies is shown in fig 3C. Particularly high correlations ( $t$ -values) appear with tree-ring datasets for the region around Gothenburg in western Sweden. Thinking back to the written record for timber purchases for *Vasa*, mentioned above, there is no mention that timber was purchased from this region, nor from the adjacent territories of Halland or Bohuslän, which at the time belonged to Denmark or Denmark/Norway. It is highly probable that the timber that belongs to Group 3 are the timbers that were bought in Amsterdam. The main oak chronology that allows us to identify this timber source is one built by Bråthen (1982). This covers the period AD 1225-1720, and is based on archaeological timbers from the hinterland of Gothenburg (Bråthen 1982). In fact, in the dendrochronological record, we see many instances of timber that dates strongly against this chronology, including timbers from mid-16<sup>th</sup> century Aalborg (e.g. Sankelmarksgade, Daly 2016) and timber from Odense on Funen (Daly 2015). Timbers in Stirling Castle in Scotland from a building phase in 1592, also seem to come from this source (Crone 2008). Even elements of an altarpiece, dating to 1555, from as far away as Seville in Spain were built with west Swedish timber (Rodríguez-Trobajo, Domínguez-Delmás 2015). It seems clear that extensive trade in oak timber from western Swedish territory was taking place in the 16<sup>th</sup> and into the 17<sup>th</sup> century, and this timber is encountered in a wide range of contexts. That Amsterdam was a hub for timber from west Sweden eventually reaching Stockholm for the building of *Vasa* seems a very likely interpretation of these results.

### 3.3. PROVENANCE GROUP 4

Thirteen of the 14 timbers that are assigned to Group 4 are included in the tree-ring average for this group. The average is





**Fig. 3:** The four maps show the correlation between the averages for the four Vasa groups and a range of oak master and site chronologies for Northern Europe. A – Group 1 (blue), B – Group 2 (green), C – Group 3 (orange) and D – Group 4 (red). The river data is from Lehner & Grill (2013, [www.hydrosheds.org](http://www.hydrosheds.org), accessed 3<sup>rd</sup> March 2020).

244 years long and covers AD 1354-1597. The distribution of correlation for this group is shown in fig. 3D. High correlations appear with chronologies from the eastern Baltic. The highest  $t$ -values are  $t = 8.64$  with the so-called ‘Baltic 1’ art chronology and  $t = 12.18$  with the ‘Baltic 3’ art chronology. On the map the placement of these art chronologies is conjectural. Other chronologies that Vasa’s group 4 match with ( $t = 6.83$ ) include an oak site chronology from Vilnius (Rūtilė Pukienė pers. comm.). Vasa’s purchase records mention planks bought in Riga and Königsberg, so the combination of the historical evidence with the dendrochronological allows us take the evidence to the next level and suggest that the Baltic 3 art group might represent oaks from the east Baltic, rather than from Gdańsk and the Vistula. This is the first time we have come anywhere close to identifying the origin of one of these art-historical chronologies since the 1980s, when the Baltic origin of them was first discovered (Baillie *et al.* 1985; Eckstein *et al.* 1986).

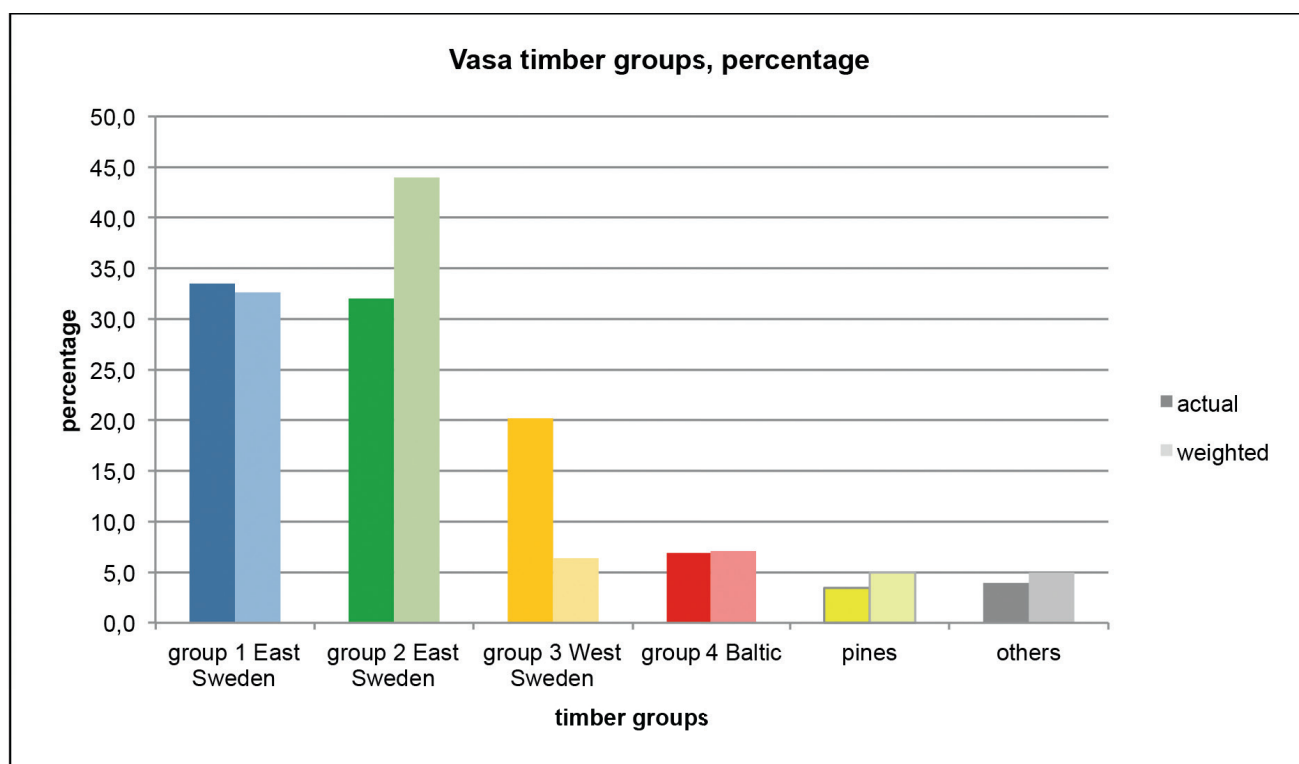
### 3.4. TIMBER PERCENTAGES FROM THE FOUR MAIN SOURCES

To sum up the timber sources for Vasa we might look at the proportion of timber used in the ship from each group. This is

presented in fig. 4 illustrated as percentages. The colours represent the colours assigned to each group in fig. 2 and the solid colouring shows the percentage of all timbers dated. However, many of the timbers that have been analysed from Vasa in this study are small pieces, like the sills that finished the gunports and the short ceilings inserted at the level of the gunports after the ports were cut through the hull. We might categorise these pieces as offcuts from larger timbers: so, in order to make a weighted count of the timber groups, I have taken these ‘offcuts’ out of the count to achieve an indication of the volume of timber for each group shown using a lighter shade of the group colour codes. In the weighted count, we see that by far the greatest source of timber for Vasa is the two east Sweden groups, at 32.6% and 44% respectively. The timber from west Sweden, which came to Stockholm via Amsterdam, represents 6.4%, and the timber (all planks) from the eastern Baltic region just 7.1%.

## 4. CONCLUSION

The dendrochronological analysis of the Vasa timbers is an enormous undertaking, and this short article can only present the highlights of the research. Details of the various discoveries



**Fig. 4:** Diagram showing the percentage of timbers dated from Vasa from each group. The darker colours represent the percentage of all timbers analysed. The lighter colours show the percentage of full-length timbers in the different groups. The sills at the gunports and some other smaller timbers are, for this exercise, considered offcuts.

**Table 1:** Skeppsholmen, Stockholm (*Scepter*): correlation between the oak average curve for *Scepter* and diverse site chronologies and individual trees.

| Filenames         | –       | –       | <i>Scepter</i> Ship all Z207M004 |  |
|-------------------|---------|---------|----------------------------------|--|
| –                 | start   | dates   | AD 1413                          |  |
| –                 | dates   | end     | AD 1613                          |  |
| Site chronologies |         |         |                                  |  |
| Z0923M01          | AD 1404 | AD 1623 | 6.04                             | Vasa group 1 63 timbers (Daly, forthcoming)                      |
| Z0923M02          | AD 1330 | AD 1625 | 6.01                             | Vasa group 2 47 timbers (Daly, forthcoming)                      |
| Z109M001          | AD 1437 | AD 1597 | 5.83                             | Barcode ship 1 BC01 Oslo 4 timbers (Daly 2013)                   |
| 6094M002          | AD 1450 | AD 1660 | 5.66                             | Funder kirke later material 4 timbers (Daly 2002)                |
| Single trees      |         |         |                                  |  |
| Z092101b          | AD 1424 | AD 1607 | 7.06                             | Vasa ship bitt midships aft upper canon deck (Daly, forthcoming) |
| Z092114a          | AD 1357 | AD 1612 | 7.06                             | Vasa frame at GP9 D37 lower gundeck sb (Daly, forthcoming)       |
| Z092118a          | AD 1452 | AD 1568 | 6.95                             | Vasa outer hull plank GP20 D16 (Daly, forthcoming)               |
| Z0921179          | AD 1470 | AD 1593 | 6.82                             | Vasa outer hull plank GP20 D15 (Daly, forthcoming)               |
| Z092150a          | AD 1436 | AD 1608 | 6.81                             | Vasa D51 ceiling right side GP4 ÖB ps (Daly, forthcoming)        |
| BAT6047a          | AD 1426 | AD 1586 | 6.56                             | Batavia Western Australia 6047 frame (Daly et al, forthcoming)   |
| Z092236a          | AD 1502 | AD 1625 | 6.41                             | Vasa D137 frame GP16 NB ps (Daly, forthcoming)                   |
| Z092148a          | AD 1509 | AD 1622 | 6.36                             | Vasa D49 frame GP4 ÖB ps (Daly, forthcoming)                     |
| Z092120a          | AD 1477 | AD 1607 | 6.12                             | Vasa D18 ceiling plank GP12 top left (Daly, forthcoming)         |
| Z092111a          | AD 1440 | AD 1593 | 5.94                             | Vasa outer plank GP24 D13 upper gundeck (Daly, forthcoming)      |
| Z092198a          | AD 1454 | AD 1588 | 5.70                             | Vasa D99 sill GP1 ÖB sb (Daly, forthcoming)                      |
| Z092241a          | AD 1433 | AD 1614 | 5.69                             | Vasa D142 frame GP20 NB ps (Daly, forthcoming)                   |

that have emerged are in preparation for publication, and the many aspects that I cover here will be expanded. The possibility to combine the details from written sources of timber procurement with the material analysis using dendroprovenance is rare.

It allows us an insight into the logistics of assembling the resources for shipbuilding in a region dominated by forest in the early 17<sup>th</sup> century, demonstrating that the ways that this resource was attained were far from simple.



## ACKNOWLEDGEMENTS

The TIMBER project has received funding from the European Research Council (ERC) under the European Union's Horizon 2020 research and innovation programme (grant agreement

No. 677152), and Vasamuseet has kindly facilitated access to their collection. Thanks to Fred Hocker for many useful discussions during many trips to Stockholm, and to both Fred and Emma Hocker for their hospitality. Thanks also to Jim Hansson for giving me the opportunity to analyse timbers from the shipwreck in Stockholm harbour, subsequently identified as *Scepter*.

## REFERENCES

- BAILLIE M.G.L., HILLAM J., BRIFFA K.R., BROWN D.M.  
1985 Re-dating the English art-historical tree-ring chronologies, *Nature* 315, p. 317-319.
- BRÄTHEN A.  
1982 Dendrokronologisk serie från västra Sverige 813-1975, *Rapport Riksantikvarieämbetet och Statens historiska museer* 1, Stockholm.
- CEDERLUND C. O.  
1966 *Stockholms skeppsgård 1605-1640. Personalens struktur och organisation*, SSHM internal report.
- CRONE B. A.  
2008 Dendrochronological analysis of the oak and pine timbers, in *Stirling Castle Palace; archaeological and historical research 2004-2008*, Historic Scotland, <http://sparc.scran.ac.uk/publications/level%20II/level2PublicationsMajor.html>
- DALY A.  
2002 Dendrokronologisk undersøgelse af tømmer fra Funder kirke, Århus amt, *Nationalmuseets Naturvidenskabelige Undersøgelser rapport* 19, Copenhagen.  
2013 Dendrochronological analysis of timbers from three ships – BC01, BC03 & BC10, from Barcode, Oslo, *Dendro.dk report* 233, Copenhagen.  
2015 Dendrokronologiske undersøgelse af tømmer fra Nørregade Fjernvarme, Asylgade, Odense, OBM6564, *Dendro.dk rapport* 8, Copenhagen.  
2016 Dendrokronologisk undersøgelse af tømmer fra Sankelmarksgade, Aalborg, NJM6539, *Dendro.dk rapport* 14, Copenhagen.  
2017 Dendrochronological analysis of timbers from a shipwreck and waterfront at Skeppsholmen, Stockholm, *Dendro.dk report* 54, Copenhagen.  
2018 Dendrochronological analysis of additional timbers from a shipwreck at Skeppsholmen, Stockholm, *Dendro.dk report* 5, Copenhagen.
- DALY A., STREETON N. L. W.  
2017 Non-invasive dendrochronology of late-medieval objects in Oslo: refinement of a technique and discoveries, *Applied Physics A* 123, 431, doi: 10.1007/s00339-017-1019-x
- DALY A., DOMÍNGUEZ-DELMÁS M., VAN DUIVENVOORDE W.  
Forthcoming *Batavia* shipwreck timbers reveal the key to Dutch success in 17<sup>th</sup>-century world trade.
- ECKSTEIN D., WAZNY T., BAUCH J., KLEIN P.  
1986 New evidence for the dendrochronological dating of Netherlandish paintings, *Nature* 320, p. 465-466.
- GRUPE G., VON CARNAP-BORNHEIM C., SÖLLNER F.  
2011 Stable strontium isotope mapping for provenance studies in archaeology – different material, different signals? *Bulletin de la Société Suisse d'Anthropologie* 17, p. 67-76.
- HAJ F., POSZWA A., BOUCHEZ J., GUÉROLD F.  
2017 Radiogenic and 'stable' strontium isotopes in provenance studies: A review and first results on archaeological wood from shipwrecks, *Journal of Archaeological Science* 86, p. 24-49.
- HILLAM J., TYERS I.  
1995 Reliability and repeatability in dendrochronological analysis: tests using the Fletcher archive of panel-painting data, *Archaeometry* 37, p. 395-405.
- HOCKER F.  
2011 *Vasa: A Swedish Warship*, Stockholm, Medströms Bokförlag and National Maritime Museums in Sweden.
- LEHNER B., GRILL G.  
2013 Global river hydrography and network routing: baseline data and new approaches to study the world's large river systems, *Hydrological Processes* 27.15, p. 2171-2186. (Data is available at [www.hydrosheds.org](http://www.hydrosheds.org)).
- RICH S., MANNING S. W., DEGRYSE P., VANHAECKE F., LATRUWE K., VAN LERBERGHE K.  
2016 To put a cedar ship in a bottle: Dendroprovenancing three ancient East Mediterranean watercraft with the 87Sr/86Sr isotope ratio, *Journal of Archaeological Science: Reports* 9, p. 514-521.
- RODRÍGUEZ-TROBAJO E., DOMÍNGUEZ-DELMÁS M.  
2015 Swedish oak, planks and panels: dendroarchaeological investigations on the 16<sup>th</sup> century Evangelistas altarpiece at Seville Cathedral (Spain), *Journal of Archaeological Science* 54, p. 148-161.
- WAZNY T.  
2002 Baltic timber in Western Europe – an exciting dendrochronological question, *Dendrochronologia* 20.3, p. 313-320.

# SHIP TIMBER FROM THE BALTIC WITH A SPECIAL EMPHASIS ON WOOD FROM OLD PRUSSIA AND POLAND

Maik-Jens SPRINGMANN

---

## Abstract

Many dendrochronological analyses of shipwrecks in Europe indicate that timber from Prussia was used for shipbuilding far from its point of origin. This suggests that the export of timber for shipbuilding to Western Europe was very important, especially in a period from the 14<sup>th</sup> to the 17<sup>th</sup> century. But how can we identify such products and in what quality and quantity were they shipped? This short paper and the Timber Project at the University of Copenhagen in Denmark try to provide some answers.

## Keywords

*Delen, forestry, Koggenborten, Prussia, quality, ship timber*

## Résumé

De nombreuses analyses dendrochronologiques d'épaves européennes indiquent que le bois de Prusse était utilisé pour la construction navale loin de son lieu d'abattage. Cela suggère que l'exportation, vers l'Europe occidentale, de bois pour la construction navale était très importante, en particulier durant la période allant du XIV<sup>e</sup> au XVII<sup>e</sup> siècle. Mais comment identifier ces produits? Et comment déterminer la quantité ainsi que la qualité des bois exportés? Ce court article, tout comme l'ensemble du projet Timber de l'Université de Copenhague au Danemark, dont il est issu, tente d'apporter des réponses à ces différentes questions.

## Mots-clés

*Delen, sylviculture, Koggenborten, Prusse, qualité, bois de navire*

---

In 1412, the so-called Tagfahrt, an annual meeting of the towns of the German Hanse, featured a particular problem on the agenda that had increasingly influenced sea trade and the general prosperity of the Hanse: a problem termed *rokeloser buwynghe der schepe* – the worst way to build ships (Koppmann 1889, p. 88). Researchers of the past discuss this problem mainly from the technological point of view. They argue that shipbuilders were not sufficiently overseen because of the closed character of the shipbuilding guilds (Olechnowitz 1960, p. 9; Krause 2010, p. 127). However, if today we examine it more from a resource orientated viewpoint and consider the changing of the natural rural landscape to a more managed, urbanised landscape, especially around the “big” harbour towns and shipbuilding centres (Rackham 2006, p. 305), then it seems that this problem was also and might mainly have been a problem of material supply. Thus the more the size of ships increased from the beginning of the 15<sup>th</sup> century, the more material was needed, especially for the framing (Timmermann 1966, p. 288). This also means that, increasingly, larger trees were required for construction. Wider planks began to be used, when compared with the shipbuilding of the Viking Age. Here we might, for example, mention the width of up to 65 cm of the already tangentially-sawn planks of the Bremen ship from 1380 (Lahn 1992, p. 35; Belasus *et al.* in this volume). Another enormous step forward, also and especially from the resource oriented point of view, is visible in the 16<sup>th</sup> century. With the globalisation of shipping through the great discoveries and the establishment of war fleets in the newly consolidated states in Europe, a remarkable early industrialisation of shipbuilding occurred, particularly in the Baltic (Olechnowitz 1960; Glete 1993). This goes in parallel with the exchange of shipbuilding knowledge,

both theoretical (Barker 2007) and practical. The need for material for these multi-masted, multi-deck ships and the speed of the transition to large vessels would have been unexpected. Take the reconstruction on the basis of the Ebersdorfer model from the beginning of the 15<sup>th</sup> century: the reconstruction team needed around 180 oak trees (Springmann, Schreier 2008). Even if Sombart's (1913, p. 1140) account of 4000 oak trunks for a 174-foot 18<sup>th</sup>-century warships is a bit too high, it shows the enormous need for material to build such big ships. It also demonstrates to us the exponential development in the exploitation of natural resources. This attains a much higher relevance if we follow Paul Heinsius (1986, p. 141) and take into consideration that the raw forest material was four times greater than the net material in the finished ship.

The challenges shipbuilders, timber traders and other timber related craftspeople faced during such times of transition were great. In the mid-17<sup>th</sup> century, Witsen (1972, p. 157-158) states that 85% of the whole cost of a ship was for material. In the 14<sup>th</sup> century, a ship was just a hull in which loads are transported safely. The responsibility for the way in which goods were stored so that they would not be destroyed, get wet or rot during a voyage did not lie with the shipbuilders (Jahnke, Grasmann 2003, p. 70; Springmann 2017b, p. 221). Different packaging and containers were used for most of the goods. In comparison with shipbuilders, coopers were already under strong quality control (Techen 1925, p. 67-128). More or less everything was transported in barrels or *pipen*. Medieval ships with open laid decks were mainly used for the so-called *trade* or *cabotage* (coastal trade), normally short single-day journeys. Therefore, the delegation of the quality control of ships into the hands of the shipbuilders was statistically not of great relevance and did

not lead to big trading problems. Traders often required a general quality simply mentioned as a “*datselfe ghude schipp*” (Stein 1899, p. 653). This changed rapidly in the 15<sup>th</sup> century due to the increase in the number of ships (Vogel 1915b, p. 268-334), longer journeys without any land contact, internationalisation of shipping and the repression of protectionism inside and outside the German *Hanse* as one of the influential trading societies in medieval Europe. Through line shipping, especially to the west with grain and returning with sea salt as bulk trade, merchants demanded ships with a watertight deck (Stein 1907, p. 665, Springmann 2014, p. 485-493).

This led, in the mid-16<sup>th</sup> century, to much more detailed descriptions or contracts between the shipbuilder and the customer. Some of the contracts were even two to three pages long. They not only mentioned in quite considerable detail how big the ship should be built and therefore how much storage space the merchant could use after the ship was launched (Springmann 2015, 2017a, 2017b), we also find clauses which were clearly dedicated to the amount, shape and quality of ship timber. In the Dutch context these *Bestecke*, also called charters or in German *Zerter*, could be seen as a contract between trader and shipbuilder. In the Baltic they became increasingly a list of material and work pieces in the sense of a quotation to describe how much timber was needed, sometimes what it looked like and what it cost. This should not surprise us because a lot of shipbuilding material was delivered as semi-finished products, mostly planks, or *Delen*, from the Baltic to the timber markets in Western Europe, often to Amsterdam. It should also be noted that in the second half of the 16<sup>th</sup> century, traders from Western and Southern Europe, especially from the Zeeland, ask agents in the Baltic how much it costs to build a ship directly in Danzig, Königsberg, Memel or Riga (Heckmann 1993, p. 7; Springmann 2014, p. 1009-1016).

The so-called *Bestecke* are not the only documents that refer to ship timber quality. We also see in early ship building treatises, from the 15<sup>th</sup> and 16<sup>th</sup> centuries, that apart from the technology in the construction process, the authors also reflect on the material itself, as well as forestry (Lavanha, Barker 1996, p. 140-146).

## 1. QUALITY OF REGIONS?

Wendy van Duivenvoorde (2015, p. 16) refers to the high quality of planks coming from the Baltic and used in ships of the Dutch East India Company (VOC), a quality which contrasts with what can be recognised in the timber of the Bremen vessel, dated to around 1380 and built with timber harvested in the hinterland of Bremen (Belasus *et al.* in this volume). Generally, I have not found any distinct indications of a categorisation of the quality of ship timbers. “*Primo an alden koghen boerten 931 bo<sup>r</sup>rte. Item an alden wrag koghen bo<sup>r</sup>rtien 541 bo<sup>r</sup>rte*” (Link, Sarnowsky 2008, p. 56), from 24 March 1404, indicates that a general quality control including ship timber took place in Danzig by the *Bracker* (a controller and sorter) (Hirsch 1858, p. 116): this was also stipulated in the *Danziger Willkiir* from 1455 (Simson 1904, p. 43).

Conceivably, the quality management of ‘wainscot’, a highly prized product in the medieval timber trade and mostly produced in Prussia, influenced the quality management of all the timber that was marketed and transported to the West, and therefore

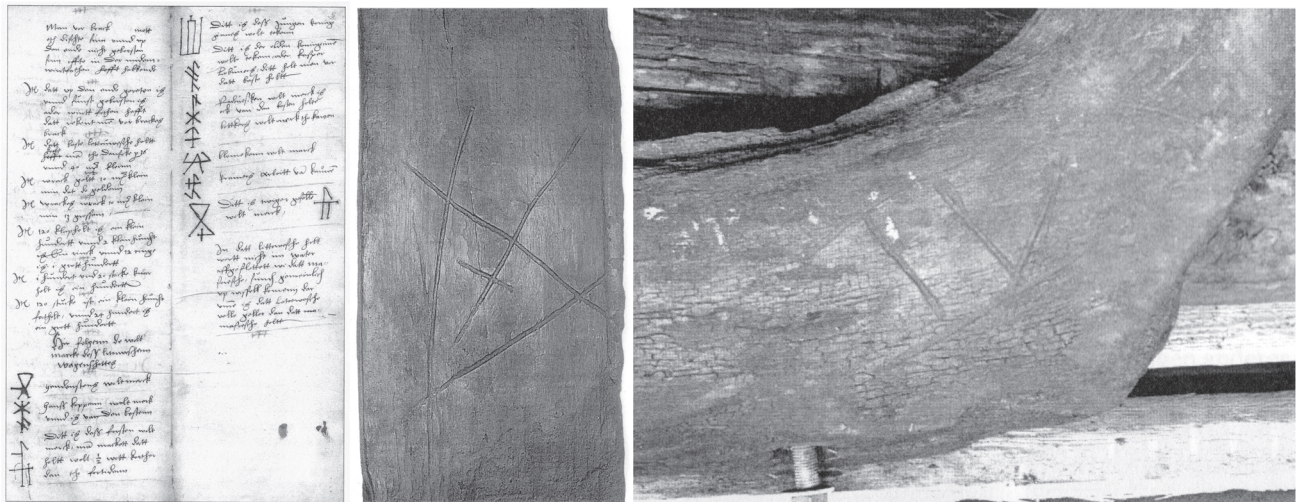
it also influenced the quality of ship timber as well (Hirsch 1858, p. 253-256; Jenks 2012; Springmann 2018a, p. 273-274, 2018b). Therefore, we can see that apart from ordinary *delen*, so-called *brack delen* and *gude delen* left the harbour of Danzig, in 1409. *Delen* was used as a synonym for ship planks, but was also used for ordinary building timber (Sattler 1887, p. 15). It seems, however, that this general quality categorisation did not influence the West European timber market that much.

The quality of ship timber, especially in the Dutch shipbuilding context, was related mostly to the region where such timber came from (Porsius, de Munck 2002, p. 137-152). However, ‘region’ should not only be understood as a geographical marker, it could also mean a special place for harvesting wood, like a special geomorphological growth site. Therefore Witsen (1972, p. 179) states that the so-called *Bergholz* (strong wales), which strengthened the hull of the ship, come from wood harvested on sandy hills (in German *Berg* means mountain). Apart from the fact that we should reserve some doubts regarding the knowledge of the authors of such early treatises, especially Witsen (Hoving 2012), there is mention that special ship construction features needed special qualities, which were connected with special geographical regions. According to Witsen (1972 p. 179) “*Koninkbergen [currently Kaliningrad] geeft ons de best Planken zoo green als Eichen*”, and *Hamburger Planken* were used to lay decks. He also mentioned that crooked wood in the 15<sup>th</sup> and 16<sup>th</sup> century, which could not be found among goods traded from Prussia, came from Westphalia from Deventer, Bellijn (Berlin-Brandenburg?), Oldenburg and Wesel (Ketting 1981, p. 18). For the hull, the Dutch in the 17<sup>th</sup> century preferred Königsberg planks. *Rechthouten* (baulks) came from Riga (Zunde 1999, p. 122-123). For the superstructure (*Verdeck*), Dutch shipbuilders generally preferred *Noortsche Deelen* (ZA Middleburg, inv. n. 6213). A building contract from 1591 made it even more detailed: “*Eene overlop gestreecken van goede wel drooghe Denemarckse delen daer van alle blau hut geweert*”<sup>1</sup>. This *wel drooghe* – good dried wood (Springmann 2014, Appendix p. 1017) – gives us another criterion for quality, which said that a ship should not “*med het bijl gemackt*” (Olechnowitz 1960, p. 116), a paraphrase for green wood. For the *overloep* (the upper deck) of a caravel ship, in 1578, a Dutch shipbuilder preferred *Prussche Deelen* (ZA Middleburg, inv. n. 6213). Van Yk (1697, p. 39 and 42) mentions that quite a large amount of timber also came from Pomerania (mostly near Stettin), Livland and Kurland. Already in 1697, Pieter van Dam, a VOC lawyer, connects the quality of timber with a geographical region (Porsius 1996, p. 1). Despite the fact that the VOC sent two ships expressly to Danzig and Königsberg to get masts (van Duivenvoorde 2015, p. 216), Witsen (1972, p. 179) remarks that the best masts came from Norway and Russia. In the 16<sup>th</sup> century, Osterode (today Ostróda in Poland), especially the *Taberbrücker Revier*, was very well known for the production of masts, and *Rahnen* (round wood for yards) and *Riemen* (oars) also came from there (Mager 1960, vol. 2, p. 16).

It should also be stated that, according to Witsen (1972, p. 179), no shipbuilder should take the trees harvested in the wetlands around Bremen (Helm 1955, p. 178). There is some

1. “A deck is laid of good and dry Danish planks which should not have any blue (fungal) disease” (translation by the author).





**Fig. 1:** Left: Lithuanian forestry marks on a letter from the Hanseatic trader Jakob Stöver sent to his trading partners (after Schulte 1937, p. 46); center: The only trading mark found on the 96 wainscots from the Copper Ship, which sank at the beginning of the 15<sup>th</sup> century; right: A mark on a frame of the Swedish flagship *Elefant*, built in 1554 in Stockholm (photographs M. Springmann).

recorded information as to how timber traders cheated customers. Sometimes they closed holes with a plug and put bran and clay over it: reputedly some of the worst timbers came from this region (van Yk 1697, p. 36).

The question must therefore arise as to how shipbuilders could trust timber merchants when they could not go to the forests themselves, which was especially the case in the Netherlands but also in Prussia of the 15<sup>th</sup> century (Ziesemer 1911, p. 221). Some answers bring us back to wainscot again, which is often connected with shipbuilding, but for the hull of special ships, like yachts (ZA Middleburg, inv. n. 6285), or for very specific uses, like superstructure and planking (ZA Middleburg, inv. n. 6213, Statens Riksarkivet Stockholm, Skeppsgårdhandlingar SE/RA/51308; Ellmers 2006, p. 71). We can assume that in the 16<sup>th</sup> century, timber traders had some doubt about quality management in Prussia and especially in Danzig. This was perhaps the reason why the Hanseatic trader, Jakob Stöver, sent an extra list with Lithuanian forestry marks to his trading partners (Schulte 1937, p. 40-72) (fig. 1 left, center). This kind of mark could also sometimes be found on ship timbers all over Europe (for a summary of such marks, see Springmann 2014, p. 526-530) (fig. 1 right).

Let us re-examine the period where Witsen and van Yk mention their “regions of quality”. The place where the timber was traded on the wood market and where it was loaded aboard ships was already no longer the region where the timber was harvested. Especially in such far away regions as Königsberg, it seems that *Königsberger Planken* no longer came from Königsberg but from further away from the coast. Timber was sometimes floated or shipped from the Lithuanian hinterland via the Memel River downstream to the Curonian Lagoon to Labiau (Polesk): and from there by the Deime and the Pregel to Königsberg, through the Vistula Lagoon and the Nogat, timber could reach the *Delenmarkt*, the so-called *Klapperholzwiese* and the *Mastfeld* (City Archive of Gdańsk, DAPG 300, No. 16-21, 23-25), parts of the Danzig timber market (Kapfenberger 2003, p. 21, fig. 6). In general, from the 16<sup>th</sup> century onwards, more timber was harvested in the Polish

hinterlands (Masowia and Podlasia) some hundreds of kilometres away from the harbour towns. Sometimes the regions changed because of wars and political circumstances, as was the case during the Swedish-Polish war at the beginning of the 17<sup>th</sup> century, during which Swedish traders dealt more with agents in Livland, especially in Riga (Wendt 1950 p. 56).

## 2. FORESTRY AND FOREST TECHNOLOGY

In some of the forest regions not only is management of the raw material quality verifiable, but also quality management in the sense of early forestry had started by looking after young trees, because tree quality of a 150-year-old tree trunk is and was a project across generations (Epperlein 1993, p. 27). Even then nobody could guarantee that the tree trunk would not become hollow from the inside.

In forests near harbour towns, a procedure involving the drilling of a hole from outside was developed, for which a special allowance was given (Grautoff 1881, p. 256). This was important because felling a tree was a risky job, which began by pruning the treetop: otherwise the tree could easily splinter and destroy other trees as it fell (fig. 2). This should not happen in vain. We do not know yet where these regulations and procedures were first developed, but it seems that such early forestry was not seen in the Prussian wilderness, far away from the shipbuilding and urban entrepôts.

D. Ellmers (2018a, p. 320) has mentioned the so-called *Kahneiche* (boat trees) and *Mastbaum* (mast trees), already specially controlled for shipbuilding purposes in the high medieval period in Central Europe. But it seems that the requirements of quality developed in tandem with the availability of timber, and especially for shipbuilding purposes, particularly if one thinks of the material needs of organisations like the VOC, the East India Company (EIC) and the Royal Navy (Albion 1952, p. 4-22). Further consideration is needed, however, if we are to take Richard Unger’s statement about the economically determined change from shell to skeleton





**Fig. 2:** *The cutting of trees from the Chroniques de Hainault by Jean de Guise, showing that forestry technology in Europe in the 15<sup>th</sup> and 16<sup>th</sup> centuries differs only very little from those of the 18<sup>th</sup> century (Bibliothèque Royale de Belgique).*

construction in Mediterranean shipbuilding in the 6<sup>th</sup> century (Unger 1980, p. 42) as the background to assert that the Dutch practised the shell-based tradition for longer, into the 17<sup>th</sup> century, because this saved timber. The shortage of timber arose everywhere in Europe. Therefore wood, even ship masts, was shipped from the Baltic to Portugal and Spain (Simson 1913, nr. 3355, 3397, 1590; Glete 2010, p. 369). The shortage also reached the wild Prussian hinterland in the middle of the 17<sup>th</sup> century. By then it is stated that planks were already being made from the upper parts of trees, using the whole tree and not only the trunk (GSTA Berlin, Tit. V. Nr, fol. 18/19, 58/59, 145, 148 and 150/151).

### 3. QUANTITY AND THE INVENTION OF SAWMILLS

There is no doubt that the desired quantity of planks for the West European market could not have been produced through the laborious splitting of oak. Following A. Bugge (1928, p. 354), the implementation of sawing techniques was a “revolution” in the timber trade. R.W. Unger (1980, p. 143) summarised it as follows: “It took less time to saw a log than to split it

and the saw was more accurate than the axe and adze. The greater precision compensated in part for the loss in strength of the wood. The final consideration was the sharp decrease in waste when the saw was used. Much less wood had to be thrown away”. This also strengthens the argument that questions of resource availability promoted the implementation of the saw. Saws, incidentally, had already been developed in Roman times and were used in Mediterranean shipbuilding from 600 onwards (Unger 1980, p. 142). Following Old Prussian sources from the 14<sup>th</sup> and 15<sup>th</sup> centuries, ship and boatbuilders commissioned by the Teutonic Order used handsaws to build several vessels (Ziesemer 1911, p. 190). Indeed, D. Ellmers (2006, p. 68) even suggests that the planks of the Bremen ship, from 1380, were hand-sawn. I would argue that the large amount of Prussian planks and *Delen* used in the West could not only be hand-sawn, which implies the early erection of water-powered sawmills in the Baltic and especially in Prussia. Bugge (1928, p. 353) mentions that already in 1206 the first watermill was erected in Skaalavik between Kvarven and Bergen, which is contrary to the theories of other specialist in that field (Jänichen 1966-1967; Jüttemann 1982; Gaebeler 2006, p. 1-4). Around 1300, the horizontal, so-called *Kvaernkall* was replaced by a vertical wheelstick saw in Scandinavia, which brought further increase in production (Finsterbusch, Thiele 1987). It is not



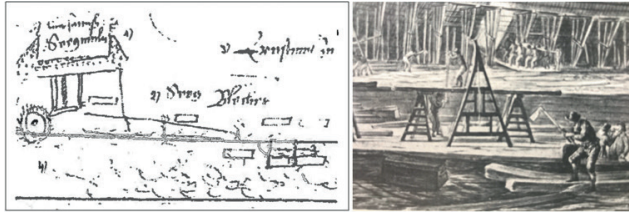


Fig. 3: Left: one blade saw mill 1516 Basel (Gaebeler 2006, p. 16). Right: Planks sawn out of blocks at one of the shipyards in Rotterdam in the 18<sup>th</sup> century (after Porsius 1941, p. 56).

astonishing that Prussia especially played a great role in the establishment of sawmills, and it is no wonder either that the first water-powered sawmill in Prussia was already installed in Danzig in 1338 (Ludwig, Schmidtchen 1992, p. 96) with others following soon thereafter (Laczny, Sarnowsky, p. 142-149, n. 1281, 1831, 1868, 1943).

We have also noticed that, even in the 17<sup>th</sup> century, large trunks reached the shipbuilding locations (Rålamb 1691, appendix V) and were hand sawn at the yard with the frame saw already in the 16<sup>th</sup> century (Springmann 2015, p. 124). For technical reasons, the first products of these sawmills were blocks (big baulks) (Hirsch 1858, p. 253-256) from which planks were sawn at the shipbuilding sites and elsewhere (fig. 3), but, of course, also for other construction purposes. Blocks were certainly the important product to leave the mills, but looking at the quantities in the pound toll book for the years 1409 and 1411, there is no doubt that the export goods were pre-sawn *Delen*, not blocks (Senks 2012). Sawing a plank out of a large block or an old trunk was not an easy thing, as an examination of the Bremen ship from 1380 suggests (Lahn 1992, p. 34). People often complained about too thick and too small planks even in the 16<sup>th</sup> century where the sawing technique had already been implemented in Europe for a long time (Springmann 2015, p. 150).

#### 4. SHIPBUILDING AND A CHANGE OF LANDSCAPE

This huge demand for timber in Europe led to a profound change in the landscape and the water table of some regions (Küster 1998). Certainly the demands of shipbuilding played a big role in this change process from wild to canopy forests, especially around harbour towns. It is not surprising that the aldermen of Stettin's merchants complained, in 1556, that all forests were being devastated through shipbuilding, and they asked the town council of Stettin to prohibit shipbuilding for foreigners (Zur Geschichte 1909, p. 21). But this craft – still carried out on a pre-industrial level in the 17<sup>th</sup> century – was not the only one to have an impact on the landscape. All the construction in which wood was used, along with more effective technologies in forest exploitation especially around big towns on the coast, led to forest decline. An evaluation, from 24 January 1722, remarks that 276 oak trees are needed to build one ordinary farmhouse (Pfeil 2003, p. 16). It also seems that

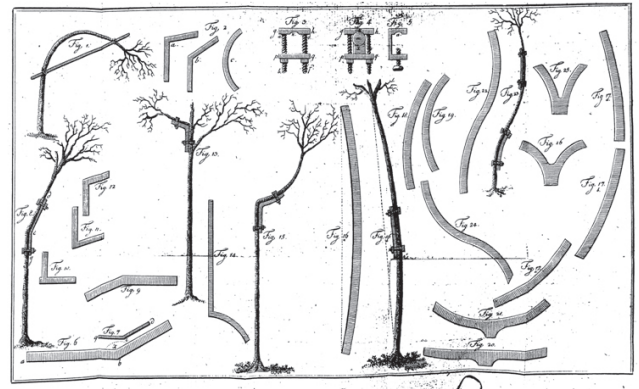


Fig. 4: Bending young trees to make crooked wood (after Becker 1804, Appendix).

the original forest changed from a primary forest to a park-like forest, and these were used in several ways by the rural population in competition with shipbuilding needs (Schwappach 1892 p. 47-49; Klemm 1954, p. 56). These 'park trees' looked different from those growing in the wild and it was certainly a major problem to saw good planks out of such trunks with branches often growing from very near the foot of a tree (see Belasus *et al.* in this volume; Hilfs, Rörig 2003).

The people dealing with the forest were not blind to the worst developments and tried to fight against the devastation of the landscape. This would not be noticed to any great extent in the Prussian wilderness where the local dukes, even in the mid 17<sup>th</sup> century, saw an endless supply of wood (GSTA Berlin, Tit. V. Nr. fol. 18/19). But it should be noted that farsighted Hanseatic councillors, for example, in Rostock (Mecklenburgisches Urkundenbuch 1865, 25. März 1252, Nr. 686, p. 14-15) and Lübeck (Unger, 1953-1954, p. 439, Klöcking 1941, p. 1-16) tried to save the forests near the Hanseatic towns especially for shipbuilding purposes. Early treatises on forestry and related laws do not refer to replanting and sustainable forest management, nor do early treatises on shipbuilding deal with such matters. Sometimes even shipbuilding technology had a great impact on forest technology, as H.F. Becker's prize essay (Becker 1804) and R.A. Barker's latest paper concerning the shaping of branches to produce crooked wood recently pointed out (fig. 4) (Barker 2019, p. 205-231).

#### 5. CONCLUSION

This short paper could not cover all the details that can be gathered on the history of ship timber supply. Transport and quantity are certainly aspects that could not be considered here. We have attempted to show that the picture which exists of the shipbuilder going into the forest with his templates looking for the right material (Bruns 2008, p. 165) should be not generalised. Apart from the fact that shipbuilding technology and forest technology influenced each other, a clear regional differentiation can be detected. Shortage in some regions was the reason why ship timbers were often harvested some great distance from where they were used to build ships.

## ACKNOWLEDGEMENTS

I would like to thank: Richard Barker for his great help and discussion of the text; Werner Ulrich who provided me with the source material from the Zeeuws Archief Middleburg; the peer reviewer for picking up any mistakes in the text; and especially Giulia Boetto who has done such a great job in editing the article. This paper was written as part of a project entitled “Northern Europe’s timber resource – chronology, origin and exploitation (TIMBER)”, led by Aoife Daly at the University of Copenhagen. The project has received funding from the European Research Council (ERC) under the European Union’s Horizon 2020 research and innovation programme (grant agreement No. 677152).

## ARCHIVES

City Archive of Gdańsk, DAPG 300, No. 16-21, 23-25.  
Statens Riksarkivet Stockholm, Skeppsgårdhandlingar SE/RA/51308.  
GSTA Berlin: Geheimes Staatsarchiv Berlin, Gen. Forstdep. Ostpr. Tit. V. Nr, fol. 18/19, 58/59, 145, 148 and 150/151.  
ZA Middleburg: ZA Middleburg, Zeeuws Archief Middleburg, Rekenkamer C, Toegang 508, inv. n. 6213, n. 6285.

## REFERENCES

- ALBION R. G.  
1926 *Forests and Seapower, The Timber Problem of the Royal Navy 1652- 1862*, Cambridge, Harvard University Press.
- BARKER R.  
2007 Two architectures – a view of sources and issues, in H. Nowacki, W. Lefèvre (eds), *Creating shapes in Civil and Naval Architecture: a Cross-Disciplinary Comparison, Max Planck Institut for History of Science, Workshop, Berlin 2006*, Berlin, Max-Planck-Institut für Wissenschaftsgeschichte, Vol. 1, Preprint series 338, p. 41-133.  
2019 Seeking the truth of Yarranton’s 17<sup>th</sup> century Hamburg Krummholz: the supply of ship timber in and from Germany, in R. Domżał, M. Dyrka, A. Ciemińska (eds), *Opus Opificem Probat. This Commemorative Book is dedicated to Jerzy Litwin*, Gdańsk, National Maritime Museum, p. 205-231.
- BECKER H.F.  
1804 *Über Cultur, künstliche Bildung und Fällung des Schiffsbauholzes*, Leipzig, Preisschrift.
- BÖHMER J. F., TECHEN F. (EDS)  
1845 *Urkundenbuch der Stadt Lübeck*, Vol. 3, Lübeck.
- BUGGE, A.  
1928 *Den Norske Traelastrandels Historie, I. Fra de aeldste Tider indtil Freden i Speier 1544*, Skien, Frem- skridts Boktrykker.
- BRUNS W.  
2008 Sovereign of the Seas – Versuch einer Annäherung, *Das Logbuch* 4, p. 167-181.
- ELLMERS D.  
2006 Hansischer Handel mit Schiffbauholz. Ein Beitrag zur Wörter- und Sachen- Forschung, in H.-P. Baum, R. Leng, J. Schneider (eds), *Wirtschaft-Gesellschaft-Mentalitäten im Mittelalter, Festschrift zum 75. Geburtstag von Rolf Sprandel*, Stuttgart, Steiner, p. 63-78.  
2018a *Die Hanse der deutschen Kaufleute und ausgewählte Beiträge zur Geschichte der Seefahrt*, Wismar, Callidus, Verlag wissenschaftlicher Publikationen, Hansische Studien 26.
- EPPERLEIN, S.,  
1993 *Waldnutzung, Waldstreitigkeiten und Waldschutz in Deutschland im hohen Mittelalter*, Stuttgart, Steiner Verlag.
- FINSTERBUSCH E., THIELE W.  
1987 *Vom Steinbeil zum Sägegatter. Ein Streifzug durch die Geschichte der Holzverarbeitung*, Leipzig, Fachbuchverlag.
- GAEBELER J.  
2006 *Die Frühgeschichte der Sägemühlen als Folge der Mühlendiversifikation*, Remagen, Kessel.
- GLETE J.  
1993 *Navies and Nations: Warships, Navies and State Building in Europe and America, 1500-1860*, Stockholm, Almqvist & Wiksell Int., Stockholm Studies in History 48.
- GRAUTOFF S.  
1881 *Lübeckisches Urkundenbuch*, Vol. 6 [1417–1526], Lübeck.
- HECKMANN D. (ED.)  
1993 *Von Königsberg an die Loire, Quellen zu Handelsreisen des herzoglich-preussischen Faktors Antoine Maillet nach Frankreich in den Jahren 1562 bis 1564*, Köln/Weimar/Wien, Böhlau, Veröffentlichungen des Archivs Preußischer Kulturbesitz 33.
- HELM K.  
1955 Bremens Holzschiffbau vom Mittelalter bis zum Ausgang des 19. Jahrhunderts, *Bremisches Jahrbuch* 44, p. 175-243.
- HEINSIUS P.  
1986 *Das Schiff der Hansischen Frühzeit*. Köln, Weimar, Wien, Böhlau Verlag.
- HILFS R.B., RÖRIG F.  
2003 *Wald und Weidwerk in Geschichte und Gegenwart*, Potsdam, Aula-Verlag (reprint).
- HIRSCH T.  
1858 *Danzigs Handels- und Gewerbsgeschichte unter der Herrschaft des Deutschen Ordens: gekrönte Preisschrift*, Leipzig, Hirzel.
- HOVING A.J.  
2012 *Nicolaes Witsen and Shipbuilding in the Dutch Golden Age*, College Station, Texas A&M. University Press.
- JAHNKE C., GRASMANN A. (EDS)  
2003 *Seerecht im Hanseraum des 15. Jahrhunderts. Edition und Kommentar zum Flandrischen Copiar Nr. 9, Veröffentlichungen zur Geschichte der Hansestadt Lübeck herausgegeben vom Archiv der Hansestadt, Reihe B*, Vol. 36, Lübeck, Verlag Schmidt-Römhild.
- JÄNICHEN H.  
1966-1967 Zur Geschichte der Sägemühlen im Mittelalter, *Alemannisches Jahrbuch*, p. 317-329.

- JENKS S. (ED)  
2012 *Das Danziger Pfundzollbuch von 1409 und 1411*, Köln/Weimar/Wien, Böhlau, Quellen und Darstellungen zur hansischen Geschichte N.F. 63.
- JÜTTEMANN H.  
1982 *Wassergetriebene Bauernsägen in Mitteleuropa, insbesondere im Schwarzwald bis etwa zum Jahre 1850*, Dissertation, University of Karlsruhe, Karlsruhe.
- KAPFENBERGER D.  
2003 *Holz und Holzhandel in Preußen 1393-1403*, unpublished Staatsexamenarbeit, Universität Erlangen.
- KETTING H.  
1981 *Prins Willem. Ein Ostindienfahrer des 17. Jahrhunderts*, Rostock, VEB Hinstorff Verlag.
- KLEMM F.  
1954 *Technik, Eine Geschichte ihrer Probleme*, Freiburg, Alber Verlag.
- KLÖCKING J.  
1941 Der alte Lübecker Handel mit heimischen Holz, *Mitteilungen des Vereins für Lübeckische Geschichte* 16, p. 1-16.
- KOPPMANN K. (ED.)  
1889 *Hanserecense*, Abt. I. Band 6, 1411-1418, Leipzig, Duncker & Humblot.
- KRAUSE G.  
2010 *Handelsschiffahrt der Hanse*, Rostock, Klatschmohn Verlag.
- KÜSTER H.  
1998 *Geschichte des Waldes. Von der Urzeit bis zur Gegenwart*, München, Verlag C. H. Beck.
- LAHN W.  
1992 *Die Kogge von Bremen Bd. 1: Bauteile und Bauablauf*, Bremerhaven/Hamburg, Deutsches Schiffahrtsmuseum/Ernst Kabel Verlag, Schriften des Deutschen Schiffahrtsmuseums 30.
- LAVANHA J.B.  
1996 *Livro Primeiro da Architectura Naval*, Lisboa, Academia de Marinha (transcription and translation into English by R. Barker).
- LACZNY J., SARNOWSKY J.  
2013 *Die Schuldbücher und Rechnungen der Großschäffer und Lieger des Deutschen Ordens in Preußen, Bd. 2: Großschäfferei Königsberg II (Ordensfolianten 142-149 und Zusatzmaterial)*, Köln/Weimar/Wien, Böhlau, Quellen und Darstellungen zur hansischen Geschichte N.F. 59, 2; Veröffentlichungen aus den Archiven Preußischer Kulturbesitz 62, 2.
- LINK C., SARNOWSKY J. (EDS)  
2008 *Die Schuldbücher und Rechnungen der Großschäffer des Deutschen Ordens in Preußen, Bd. 3: Großschäfferei Marienburg*, Köln/Weimar/Wien, Böhlau, Quellen und Darstellungen zur hansischen Geschichte N.F. 59, 3; Veröffentlichungen aus den Archiven Preußischer Kulturbesitz 62, 3.
- LUDWIG K.-H., SCHMIDTCHEN V.  
1992 *Propyläen Technikgeschichte / Metalle und Macht: 1000 bis 1600*, Berlin, Propyläen-Verl.
- MAGER F.  
1960 *Der Wald in Altpreußen als Wirtschaftsraum*, Vol. 1- 2, Köln/Graz, Böhlau-Verlag.
- MECKLENBURGISCHES URKUNDENBUCH  
1865 Mecklenburgisches Urkundenbuch, vol II, *Verein für mecklenburgische Geschichte und Altertumskunde*, Schwerin.
- OLECHNOWITZ K.-F.  
1960 *Der Schiffbau der hansischen Spätzeit: eine Untersuchung zur Sozial- und Wirtschaftsgeschichte der Hanse*, Köln, Weimar, Wien, Böhlau Verlag.
- PFEIL W.  
2003 *Die Forstgeschichte Preußens bis zum Jahre 1806*, Remagen, Verlag Kessel (reprint).
- PORSIUS N.  
1996 De toepassing van hout, de kwaliteitsbeoordeling en de maatvoering in het verleden, *Met Stoom* 24.
- PORSIUS N., DE MUNCK E.  
2002 Over hout, de herkomst, de kwaliteitseisen en de bewerking daarvan, in W. Dobber, P. Ceas (eds), *Cornelis Corneliszoon van Uitgeest: Uitvinder aan de basis van de Gouden Eeuw*, Walburg, Zutphen, p. 137-152.
- RÅLAMB C.,  
1691 *Skepsbyggerij eller adelig öfnings tionde tom*, Stockholm, Malmö (reprint 1943).
- RACKHAM O.  
2006 *Woodlands. New Naturalist series*, London, Woodlands Paperback.
- SATTLER C. (ED.)  
1887 *Handelsrechnungen des Deutschen Ordens – Im Auftrage des Vereins für die Geschichte von Ost- und Westpreussen*, Leipzig, Duncker & Humblot.
- SCHULTE E.  
1937 Das Danziger Kontorbuch des Jakob Stöve aus Münster (Hansische Maße, Münzen, Waren, Wege um 1560), *Hansische Geschichtsblätter* 62, p. 40-72.
- SCHWAPPACH A.  
1892 *Grundriss der Forst- und Jagdgeschichte Deutschlands*, Leipzig, Verlag der Wissenschaften (reprint).
- SIMSON P. (ED.)  
1904 *Geschichte der Danziger Willkür. Quellen und Darstellungen zur Geschichte Westpreußens Nr. 3*, Danzig, Neudruck (reprint Münster, Nicolaus-Copernicus-Verlag 2006).  
1913 *Danziger Inventar (1531-1591). Inventare der Hansischer Archive des 16. Jahrhunderts, Vom Verein für Hansische Geschichte*, 3 Vol, München/Leipzig.
- SOMBART W.  
1913 *Der moderne Kapitalismus*, vol. 2, Leipzig, Verlag von Duncker & Humblot.
- SPRINGMANN M.-J.  
2014 *Schiffahrt und Schiffbau im Übergang zur Frühen Neuzeit im Ostseeraum, Tradition versus Innovation (1450-1600)*, Dissertation, Ernst-Moritz-Arndt-Universität Greifswald.  
2015 Der Schiffbau und die Handelstransaktionen Johann Albrechts I. von Mecklenburg nach Portugal im Lichte der tiefgreifenden Veränderungen im Schiffbau und der Schiffahrt zu Beginn der Frühen Neuzeit, *Deutsches Schifffahrtsarchiv* 38, p. 97-180.  
2017a The Building and Metrology of Ships in the Transition from Medieval to Early Modern Times – free creativeness or constructional and standardised building? in J. Litwin (ed.), *Baltic and beyond, Change and Continuity in Shipbuilding, Proceedings of the Fourteenth International Symposium of Boat and Ship Archaeology (ISBSA 14), Gdańsk 2015*, Gdańsk, National Maritime Museum, p. 75-86.  
2017b Normierung und Standardisierung im Schiffbau zur Zeit des Überganges zur Frühen Neuzeit: Eine vornehmlich auf den Frachtraum gerichtete Untersuchung und ein Beitrag zum Verständnis der tiefgreifenden Umwälzungen der Schifffahrtsverhältnisse im Ostseeraum, *Hansische Geschichtsblätter* 134, p. 219-286.



- 2018a The Schlüsselfeld ship model from 1503, Nürnberg, is the focus of profound changes in shipping and seafaring on the eve of early modern times in northern Europe, in R. Domżał, M. Dyrka, A. Ciemińska (eds.), *This Commemorative Book is dedicated to Jerzy Litwin*, Gdańsk, National Maritime Museum, p. 255-289.
- 2018b Lemma in the Hanselexikon: <https://www.hansischergeschichtsverein.de/lexikon?suche=Wagenschos>
- SPRINGMANN M.-J., SCHREIER S.
- 2008 The Ebersdorfer Cog Model as a basis for a reconstruction of a late medieval sailing vessel, in H. Wernicke, M.-J. Springmann (eds), *Historical Boat and Ship Replicas, Conference Proceedings on the Scientific Perspectives and the Limits of Boat and Ship Replicas, Torgelow 2007*, Friedland, Steffen Verlag, p. 105-116.
- TECHEN F.
- 1925 Die Böttcher in den Wendischen Städten, besonders in Wismar, *Hansische Geschichtsblätter* 30, p. 67-128.
- TIMMERMANN G.
- 1966 Schiffbauprobleme zur Hansezeit, *Handels- og Søfartsmuseet på Kronborg Årbog*, p. 267-303.
- UNGER M.
- 1953-1954 Zum Barbarossaprivileg für Lübeck, *Wissenschaftliche Zeitschrift der Karl Marx Universität* 3, p. 439-443.
- UNGER R. W.
- 1980 *The Ship in the Medieval Economy, 600-1600*, London/ Montreal, Croom Helm/McGill-Queens University Press.
- VAN DUIVENVOORDE W.
- 2015 *Dutch East India Company Shipbuilding: The Archaeological Study of Batavia and Other Seventeenth-Century VOC Ships*, College Station, Texas A&M University Press, Rachal Series in Nautical Archaeology.
- VAN YK C.
- 1697 *De Nederlandsche Scheepsbouwkonst open gestalt*, Delft.
- VOGEL W.
- 1915a *Geschichte der deutschen Seeschiffahrt. Von der Urzeit bis zum Ende des XV. Jahrhunderts*, Berlin, Salzwasser-Verlag.
- 1915b Zur Größe der europäischen Handelsflotten im 15, 16. und 17. Jahrhundert, in *Forschungen und Versuche zur Geschichte des Mittelalters und der Neuzeit, Festschrift für Dietrich Schäfer*, Jena, Fischer, p. 268-334.
- WENDT E.
- 1950 *Amiralitetskollegiets Historia (1634-1695)*, Stockholm, Lindbergs.
- WITSEN N.,
- 1972 *Aeloude en Hedendaegsche Scheepsbouw en Bestier*, Amsterdam (reprint).
- ZIESEMER W. (ED.)
- 1911 *Das Ausgabebuch des Marienburger Hauskomturs für die Jahre 1410-1420*, Königsberg.
- ZUNDE M.
- 1999 Timber export from medieval Riga and its impact on dendro-chronological dating in Europe, *Dendrochronologia* 16-17, p. 119-130.
- ZUR GESCHICHTE
- 1909 Zur Geschichte des Schiffbaus in Stettin, *Monatsblätter der Gesellschaft für Pommersche Geschichte und Altertumskunde* 23, p. 21-28.

# SAILING MA'AGAN MIKHAEL II

Yochai PALZUR and Deborah CVIKEL

---

## Abstract

The Ma'agan Mikhael ship, dated to 400 BC, was built shell-first. Due to its significance, the archaeological find was completely excavated, retrieved from the seabed, conserved, and is now displayed in the Hecht Museum at the University of Haifa. The construction of a sailing replica of the ship took two years (2014–2016), using the techniques of the ancient shipwrights. The replica was launched in December 2016, and since then has made more than 50 sailings along the Israeli coast, which have provided essential information on ancient sailing techniques.

## Keywords

Ma'agan Mikhael ship, replica, square sail

## Résumé

La réplique de l'épave de Ma'agan Mikhael, datée de 400 avant n.è, a été construite selon la technique « bordé premier ». En raison du caractère exceptionnel de ses vestiges, l'épave a fait l'objet d'une fouille exhaustive avant d'être renflouée et de subir un traitement de conservation en vue de son exposition au sein des collections du musée Hecht de l'Université de Haïfa. La construction d'une réplique aura pris deux ans (2014–2016), en utilisant les techniques des charpentiers de marine de l'Antiquité. La réplique a été lancée en décembre 2016 et a depuis effectué plus de 50 navigations le long des côtes israéliennes, qui ont fourni des informations essentielles sur les techniques de navigation anciennes.

## Mots-clés

Ma'agan Mikhael, réplique, voile carrée

---

## 1. THE MA'AGAN MIKHAEL SHIP

The Ma'agan Mikhael shipwreck was discovered in 1985, 70 m from the shoreline of Kibbutz Ma'agan Mikhael, which is located 30 km south of Haifa on the Mediterranean coast of Israel. It was found at a depth of 1.5 m, and buried under a 1.5 m-thick layer of sand. Three seasons of underwater excavations were carried out at the site during autumn 1988 and spring and autumn 1989 by the Leon Recanati Institute for Maritime Studies at the University of Haifa, with the late Dr Elisha Linder as project head. Jay Rosloff of Texas A&M University led the excavation team. The surviving timbers, which occupied an area of 11.15 m long, 3.11 m wide and 1.5 m deep, comprised a considerable fraction of the original hull. The existing hull components were the keel, false keel and central stringer, parts of 14 full frames, sections of strakes (12 on the starboard side and 7 on the port side), the mast step, knees in the stem and stern and various internal components. These timbers were of Turkish pine (*Pinus brutia*), except for the tenons, pegs and false keel, which were of oak (*Quercus* sp.) (Kahanov 2003, p. 53-113, 2011, p. 162-163; Kahanov, Pomey 2004, p. 6-13).

The hull had a wineglass-shaped cross-section, and was built by the shell-first method. Starting from the keel and endposts, the hull planks were first joined edge-to-edge by pegged mortise-and-tenon joints creating the outer shell, and the frames were then fastened to the shell by double-clenched copper nails. It also had sewing at the bow and stern, which was a Greek shipbuilding tradition, well attested in both Aegean and Phocaean contexts (Kahanov 2003, p. 113-119; Kahanov, Pomey 2004). In addition to the hull remains, the excavators retrieved 12.5 tons of stone, mostly blue schist with some gabbro (basalt), laid on a bed of dunnage, some 70 items of pottery, a one-armed wooden anchor, a whetstone, several sizes of ropes of various plant fibres, decorative wooden artefacts,

food remains, a lead ingot, and a basket of carpenter's tools, which included bow drills, rulers and a square, wooden nails and ready-to-use tenons (Kahanov 2011, p. 162-163).

The ship has been dated to about 400 BC by <sup>14</sup>C analysis and the ceramic finds (Artzy, Lyon 2003). After the ship and its contents were completely excavated, the hull was dismantled underwater and the timber sections were retrieved from the seabed and conserved at the laboratory of the Leon Recanati Institute. The hull was reassembled at the University of Haifa, where it is now on display in the Hecht Museum (Votruba 2004; Segal *et al.* 2009; Kahanov 2011, p. 163-167). The late Professor Yaacov Kahanov of the Leon Recanati Institute for Maritime Studies directed the conservation, research and reconstruction of the ship, and initiated and directed the construction of the full-scale sailing replica of the ship.

## 2. MA'AGAN MIKHAEL II: A REPLICA SHIP

A sailing replica of the Ma'agan Mikhael ship was an objective from the moment the ship was discovered and its significance understood. The original inspiration for the project came from the late Dr Elisha Linder, who was succeeded by the late Professor Yaacov Kahanov. The project became viable at the beginning of 2014 with a generous private donation. The replica was constructed at the Israel Nautical College at Akko, and the keel-laying ceremony took place in July 2014. The research objectives were twofold: in-depth research of ancient ship construction by the shell-first method, using mortise-and-tenon joints and sewing; and testing the ship's sailing capabilities while learning about life on board (Ben Zeev *et al.* 2009, p. 1; Kahanov 2011, p. 169).

The archaeological evidence served as the primary source of information. All the components were recorded down to the

smallest detail, such as wood grain, knots, nails, tool marks, holes and the like. The same tree species were used as in the original ship, and timber was supplied by the Jewish National Fund (KKL) from planted forests in Galilee. Planks were cut from straight trunks, and frames were cut from trunks and branches growing naturally in the shapes required to match the curves of individual frames. The builders of the replica used chisels, mallets, hand saws, and measuring, scribing and marking tools similar to those used by the ancient shipwrights. However, where a simple feature, such as the mortise, was repeated, modern electrical tools, such as a band saw, planes, drills and even a mortise-cutting machine, were used.

The builders of the replica followed the shell-first principles and method in an attempt to replicate the archaeological data. The hull planks were manufactured based on the archaeological data and were as similar as possible to the originals. The archaeological information of the planking was only complete up to Strake 3 on both sides. From Strake 4 and upwards, the archaeological information decreased as the remains became shorter and shorter, which forced the builders to make decisions in extrapolating the missing parts. Practically, it was found that above about Strake 6, matching planking to frames gave the best result in replicating the archaeological data. Therefore, floor timbers and futtocks were installed before planking from Strakes 6 and 7 and upward. Thus, up to Strakes 6 and 7, the replica hull was built shell-first, and the floor timbers were shaped to match the installed strakes. From Strakes 6 and 7 the dimensions of the planks were dictated by the frames, as far as they survived, and also by battens corresponding to missing frames and the reconstructed hull lines. The angle of deadrise was constantly checked in order to maintain the symmetry between the two sides of the hull. Mortise-and-tenon joints for fastening planking throughout, and sewing in specific areas, were employed as in the original hull.

No caulking remains were evident in the shipwreck. However, the hull timbers were found to be coated with a mixture of pine resin and esparto wax or beeswax (Glastrup, Padfield, 2004). Therefore, all the hull components of the replica were coated with a mixture of beeswax and pine resin at a 1:1 ratio. Under the waterline, charcoal powder was added to this mixture, giving the underside of the hull its dark colour. In addition, where gaps in the seams were found to be more than 2 mm wide, a traditional caulking material (*Desmostachya bipinnata*) was also used. The hull proved to be practically watertight after allowing the planking to absorb water.

Construction was completed in November 2016. The final dimensions of the replica are 16.6 m overall length, with a beam of 4.3 m over frames. The replica was lowered into the water in the Israel Shipyards dry dock on 16 December 2016, and towed to her temporary mooring at the Kishon Marina in Haifa. The official launching ceremony took place on 17 March 2017, and the ship was named *Ma'agan Mikhael II*. After her arrival at the Kishon in December 2016, the hydrostatic characteristics of the ship were tested, and found to comply with present-day requirements for stability and seaworthiness. This allowed the ship to receive its seaworthiness certificate from the Ministry of Transport, and the replica team to carry out a series of sailings in Haifa Bay and along the Israeli coast. The goal of these sailings was to acquaint the crew with the ship, handling the square sail and quarter rudders, manoeuvring and anchoring (fig. 1a).

### 3. THE RIGGING SYSTEM OF MA'AGAN MIKHAEL II

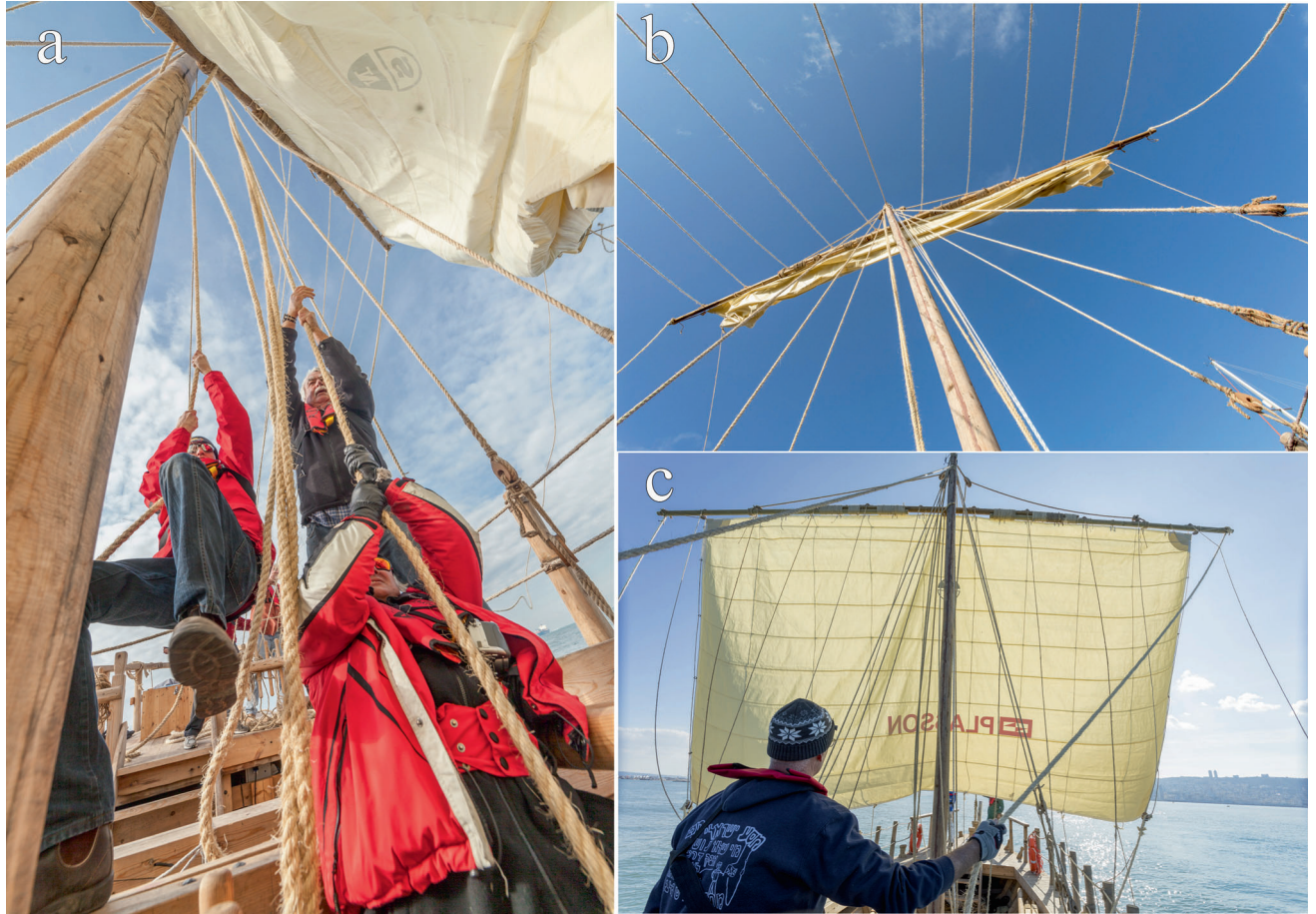
Apart from the mast step, mast partner beams, and some toggles, no archaeological evidence of the mast, yard, sail or rigging has survived. Thus the mast step was the only surviving timber that could provide a hint of the dimensions of the mast and its location amidships. Two vertical boards, which were fitted into grooves alongside the mast socket, supported the mast. The minimum distance between these boards was 20 cm, which gave an indication of the mast's diameter (Kahanov 2003, p. 99-106). Where the archaeological evidence was missing, iconography (Basch 1987; Ben Zeev *et al.* 2009) and replicas of nearly contemporary ships, such as the *Kyrenia II* (Katzev, Katzev 1989, p. 172-174), *Kyrenia Liberty* and *Jules-Verne 7* and *9* (Pomey 2003, 2017; Pomey, Poveda 2018), were consulted to supplement the missing information. The reconstruction of the ship assumes that she was originally rigged with a single mast carrying a square sail.

The 10.7 m-tall mast is made of cypress (*Cupressus* sp.), tapering from 20 cm diameter at its foot to about 10 cm at the top. It is supported by three shrouds per side, one backstay and one forestay (fig. 1b). A running 'baby' stay is also used when sailing on a close or beam reach. The yard, 11.7 m long, is composed of three overlapping round cross-section pine timbers, connected only by sisal rope lashings. The central piece is 12 cm in diameter and 6.7 m long, while the two side timbers are each 9.5 cm in diameter and 5 m long. It was decided to make the 60 m<sup>2</sup> practice sail of durable synthetic fabric (Dacron) due to the possibility of damaging a natural fabric sail before gaining experience in handling a square sail. It has a sisal (a readily available natural fibre) bolt rope sewn around it to prevent tearing, and five rows of reefing rings. The sail has two sheets and two braces for trimming it to the wind, and ten brails are used for reefing and furling. One halyard and two lifts are led from deck level to the masthead (fig. 1c). A cotton sail has been made for the 2020 sailing season. Once all the elements were complete, several trials were conducted on land in order to study how to raise and step the mast, operate the running rigging and handle the sail. During these trials it was noticed that the heel of the mast shifted towards the bow when the mast was raised. This was prevented by the addition of a 'stopper', which in the original ship apparently was held in place by three small mortises on the mast step (fig. 2). This was an important lesson learned from experience combined with interpretation of the archaeological evidence. After consulting with the project's naval engineer, and due to time constraints, it was decided not to use the two vertical boards alongside the mast socket.

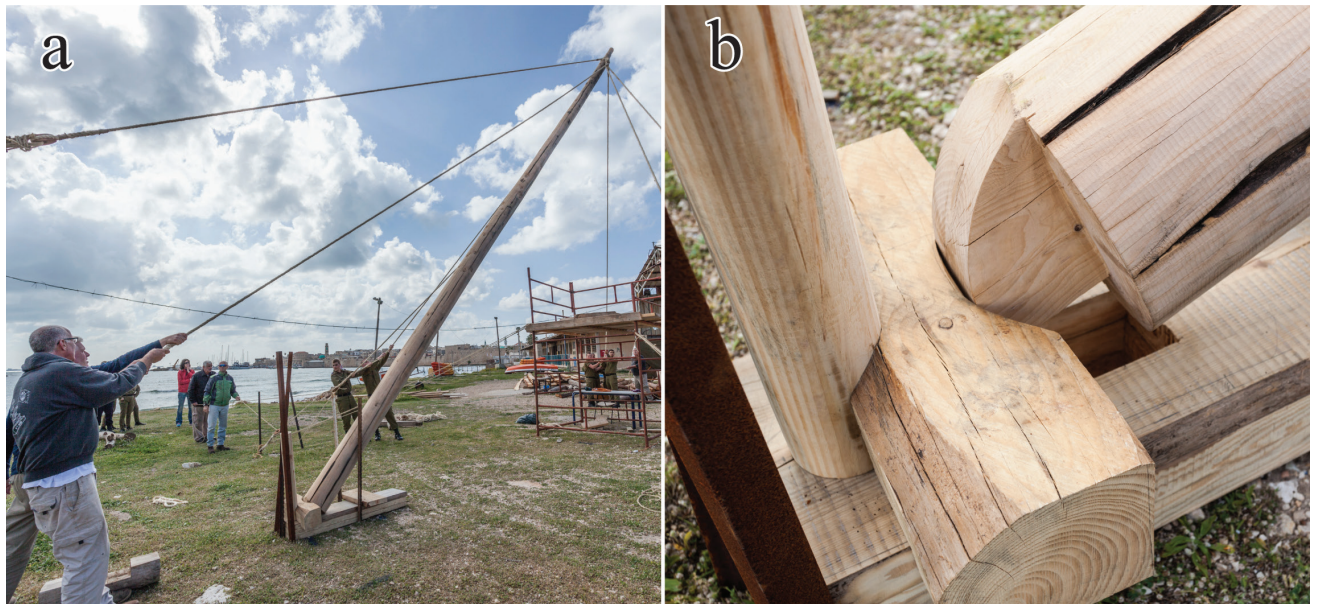
### 4. SAILING EXPERIMENTS

The major challenge in sailing with a square sail is making way to windward. Experimental sailings were conducted along the Israeli coast from December 2016. The ship is equipped with measuring instruments, including GPS and wind sensors, to record and document all the sailing parameters, and the recorded wind and ship data were used to create and update the polar diagram of the ship.





**Fig. 1:** The rigging system of Ma'agan Mikhael II: a) the crew handling the square sail; b) the mast and rigging; c) the sail and its rigging (photographs E. Efremov)



**Fig. 2:** The mast: a) trial conducted on land to study how to raise and step the mast; b) the 'stopper' (photographs E. Efremov)



The first sailings of the ship were conducted in and around Haifa Bay, with the objective of training the crew in the basic tasks of towing the ship and being towed, tying up and securing the ship at the jetty, anchoring and controlling the square rig. The basics of controlling the square rig were learned and practised in the protected bay area with winds less than 10 knots, and with the wind only on broad reaches and runs (fig. 3). From the first sailing the ship was found to have good longitudinal stability, and was easy to sail with a crew of four or five.

In spite of the calm sailing conditions, several rigging failures occurred. One of the quarter rudders broke, and it was decided to replace both by new ones with thicker shafts. The yard also broke on one of the first sailings as a result of incorrect handling. The outer timbers of the yard were replaced, the lashing points were changed, and the braces were attached at different points.

As more experience was gained, we started to sail on beam reaches and close-hauled with the sheet and brace led forward: the sheet fed through a deadeye, which was secured to a stanchion. This enabled tensioning the forward leech of the sail, and improved close-hauled performance. Positioning the yard fore-and-aft for sailing on a beam reach and close-hauled caused the sail to stretch over the forestay. To remedy this, a

running 'baby' stay was added, which was tensioned after securing the yard fore-and-aft, and then slackening the forestay to achieve a better sail shape. The ship displayed a strong tendency to gripe, and this was countered by brailing up the aft part of the sail.

After six months of sailing in Haifa Bay, the skills to handle the rig and steer the ship were achieved, and tested on a four-day voyage south to Jaffa and back, a distance of more than 50 nautical miles (NM) each way. The main objective was to examine the possibility of coastal sailing and exploiting the early morning land breeze to advance northward in small hops, until the prevailing north-westerly winds set in about noon. On the first day there was a north-westerly wind of 10-18 knots, and the 52.6 NM to Jaffa were covered at an average speed of 2.8 knots. The return voyage spanned three days: from Jaffa to Herzliya, about 8 NM, at an average speed of 2 knots; from Herzliya to Hadera (22 NM) at an average speed of 3 knots; and from Hadera to Haifa (32.6 NM) at an average speed of 3 knots. Data of all sailings were recorded by a Maretron 100VDR voyage data recorder. This was used to analyse the ship's sailing performance in all the wind conditions encountered. The ship was found to have excellent sailing capabilities, and attained a maximum recorded speed of 5.8 knots while running before a wind of 12 knots.



Fig. 3: The Ma'agan Mikhael II under sail on a broad reach. The two quarter rudders can be seen (photography E. Efremov).

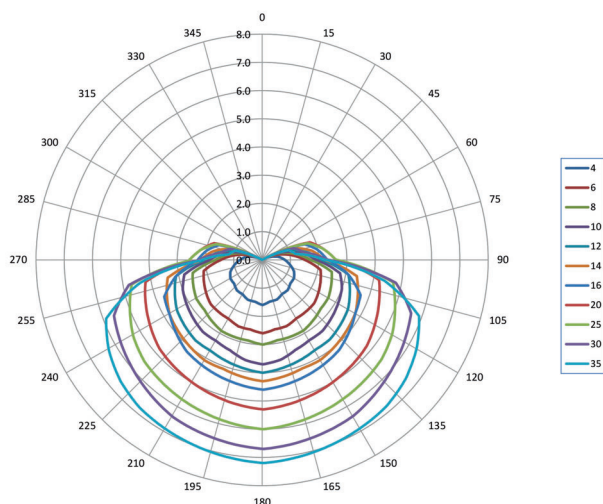


Fig. 4: The polar diagram of Ma'agan Mikhael II (diagram D. Gal)

During the second year (2018) graduate students, schoolchildren, guests and groups of sailors shared the sailing experiences and deepened their connection to the sea and to heritage vessels. In this year, sailing from Haifa to Ashqelon, a distance of 80 NM each way, including overnight sailing, was preparation for a longer voyage to Cyprus and back planned for 2019.

The ship's polar diagram (fig. 4) shows ship speed of roughly 50% of the wind velocity on a full run, and about 25% of the wind velocity at 80 degrees off the true wind. The polar diagram indicates the Speed Through Water that the ship can achieve at various values of True Wind Speed and True Wind Angle to the ship's heading. Leeway was not included in the polar diagram and it is added to the heading to calculate the Course Made Good. When sailing close to the wind, leeway varied between 10 and 20 degrees.

A sailing model was generated with the assistance of the project's meteorologist, David Gal. This model is based on applying modern meteorological data and the ship's polar diagram to a weather-routing simulator. The model was run concurrently with sailing along the Israeli coast from Haifa to Jaffa and further south to Ashqelon and back, which allowed us to verify the model's accuracy. The sailing model was used to conduct a

study on the possible routes and seasons in which a ship such as *Ma'agan Mikhael II* could have made a voyage from the Levant to Greece and back. This is in light of the prevailing north-westerly winds at all seasons of the year. Ten years of gridded wind data at 54 km linear resolution and 6 hours' temporal resolution was used. In all, 40,000 simulated voyages were modelled (Gal, personal communication, 2018).

Several possible sailing routes were examined, and results show the probabilities of a 'good' voyage in every calendar month for each of the routes. The study further examined the synoptic patterns that existed on each potential departure day to try to understand if the ancient Greek sailors would have been able to judge the departure day as a 'good' one. Coastal sailing possibilities were also modelled, using high-resolution gridded data (1 km). The results show the potential of exploiting the morning land breeze to advance some 10-30 NM before the onset of the noon sea breeze or prevailing wind prevented sailing further.

## 5. CONCLUSIONS

The significance of the Ma'agan Mikhael replica project is in reproducing the conditions of the practical sailing and navigating of an ancient ship. From her first sailing the *Ma'agan Mikhael II* has proven her stability and excellent sailing capabilities, easily carrying 10 to 15 personnel and supplies. The next challenge will be to sail across the eastern Mediterranean from Israel to Cyprus.

## ACKNOWLEDGEMENTS

The construction and sailing of the *Ma'agan Mikhael II* replica ship was made possible by the generosity of private donors, the Israel Nautical College, Akko, the Jewish National Fund, the Israel Antiquities Authority, the support of the Honor Frost Foundation, and the Israel Science Foundation (grant no. 1890/16). We are grateful to them all. We wish to dedicate this article to the replica team, and especially to the inspiring leader of the project, the late Professor Yaacov Kahanov.

## REFERENCES

- ARTZY M., LYON J.  
2003 The Ceramics, in E. Linder, Y. Kahanov, *The Ma'agan Mikhael Ship: The Recovery of a 2400-Year-Old Merchantman, Volume I*, Jerusalem, Israel Exploration Society and University of Haifa, p. 183-202.
- BASCH L.  
1987 *Le Musée imaginaire de la marine antique*, Athens, Hellenic Institute for the Preservation of Nautical Tradition.
- BEN ZEEV A., KAHANOV Y., TRESMAN J., ARTZY M.  
2009 *The Ma'agan Mikhael Ship. Volume III, A Reconstruction of the Hull*, Haifa, Israel Exploration Society, Leon Recanati Institute for Maritime Studies, University of Haifa.
- GLASTRUP J., PADFIELD J.  
2004 Analysis of Paint, in Y. Kahanov, E. Linder, *The Ma'agan Mikhael Ship: The Recovery of a 2400-Year-Old Merchantman, Volume II*, Jerusalem, Israel Exploration Society and University of Haifa, p. 138-142.
- KAHANOV Y.  
2003 The Hull, in E. Linder, Y. Kahanov, *The Ma'agan Mikhael Ship: The Recovery of a 2400-Year-Old Merchantman, Volume I*, Jerusalem, Israel Exploration Society and University of Haifa, p. 53-129.  
2011 Ship reconstruction, documentation, and *in situ* recording, in A. Catambis, B. Ford, D.L. Hamilton (eds), *Oxford Handbook of*

- Maritime Archaeology*, Oxford, Oxford University Press, p. 161-181.
- KAHANOV Y., POMEY P.
- 2004 The Greek sewn shipbuilding tradition and the Ma'agan Mikhael ship: A comparison with Mediterranean parallels from the sixth to the fourth centuries BC, *The Mariner's Mirror* 90.1, p. 6-28.
- KATZEV M. L., KATZEV S. W.
- 1989 "Kyrenia II": Building a Replica of an Ancient Greek Merchantman, in H. Tzalas (ed.), *Tropis I, Proceedings of the 1<sup>st</sup> International Symposium on Ship Construction in Antiquity, Piraeus 1985*, Athens, Hellenic Institute for the Preservation of Nautical Tradition, p. 163-175.
- POMEY P.
- 2003 Reconstruction of Marseilles 6<sup>th</sup> century BC Greek ships, in C. Beltrame (ed.), *Boats, Ships and Shipyards, Proceedings of the Ninth International Symposium on Boat and Ship Archaeology (ISBSA 9), Venice 2000*, Oxford, Oxbow Books, p. 57-65.
- 2017 The Protis Project (Marseilles, France). The Construction of a Sailing Replica of an Archaic Greek Boat, in J. Gawronski, A. van Holk, J. Schokkenbroek (eds), *Ships and Maritime Landscapes, Proceedings of the Thirteenth International Symposium on Boat and Ship Archaeology (ISBSA 13), Amsterdam 2012*, Eelde, Bakhuis, p. 484-489.
- POMEY P., POVEDA P.
- 2018 *Gyptis*: Sailing Replica of a 6<sup>th</sup>-century-BC Archaic Greek Sewn Boat, *IJNA* 47.1, p. 45-56.
- SEGAL H., KAHANOV Y., TRESMAN J., EISEN S. M.
- 2009 *The Ma'agan Mikhael Ship: Monitoring the Conservation of the Hull*, Haifa, Leon Recanati Institute for Maritime Studies, University of Haifa, Schulich Faculty of Chemistry, Technion, Israel Institute of Technology.
- VOTRUBA G. F.
- 2004 Reassembly of the Hull, in Y. Kahanov, E. Linder, *The Ma'agan Mikhael Ship: The Recovery of a 2400-Year-Old Merchantman, Volume II*. Jerusalem, Israel Exploration Society and University of Haifa, p. 211-220.

# RECONSTRUCTION OF THE BYZANTINE SHIPWRECK YENIKAPI 12

Işıl ÖZSAIT-KOCABAŞ

## Abstract

Yenikapı 12 was discovered at the Yenikapı site in Istanbul, Turkey. The shipwreck has been dated to the 9<sup>th</sup> century AD. According to the reconstruction, Yenikapı 12 was a small merchantman, approximately 9.24 m long and 2.64 m wide. It was propelled by a single-mast lateen sail and controlled by two quarter rudders. The full-scale sailing replica of the Yenikapı 12 was built based on the archaeological remains. The objective of the reconstruction was to conceive a 9<sup>th</sup> century AD trading vessel in its original form and dimensions, to identify its functionality, performance and capacity.

## Keywords

Byzantine shipwreck, Istanbul, ship reconstruction, sailing replica, Yenikapı, Theodosian harbour

## Résumé

La barque *Yenikapı 12*, découverte sur le site de Yenikapı à Istanbul, a fait naufrage au IX<sup>e</sup> siècle apr. J.-C. La reconstruction a montré que *Yenikapı 12* était un petit bateau de commerce d'environ 9,24 m de long et 2,64 m de large. Il était propulsé par une voile latine grée sur un seul mât et dirigé par deux gouvernails latéraux. La réplique navigante à l'échelle de *Yenikapı 12* a été construite sur la base des vestiges archéologiques. L'objectif de la reconstruction était d'appréhender ce bateau de transport dans sa forme et ses dimensions d'origine, afin de mieux identifier sa fonction, ses performances et sa capacité de charge.

## Mots clés

naufrage, époque byzantine, Istanbul, archéologie expérimentale, réplique navigante, Yenikapı, port de Théodosie

The Yenikapı 12 (YK12) shipwreck with its cargo was discovered in the Yenikapı excavation site by Istanbul Archaeological Museums (IAM). It was uncovered in February 2007 at the east of the Theodosian harbour (Kızıltan 2010; Kocabaş 2015b). The cargo of the shipwreck consists of intact amphorae and amphora fragments in its hold. In addition, cooking utensils and personal artefacts were found in a special compartment close to the stern (Denker *et al.* 2013, p. 204, 209). Based on a coin found within the shipwreck context, the ship has been dated to the 9<sup>th</sup> century AD: results of the radiocarbon analysis of wood samples give a date range between 672 and 870 AD (Kocabaş 2015a, p. 13). Excavation, documentation, lifting and post-excavation studies of YK12 were carried out by an Istanbul University (IU) team under the direction of Ufuk Kocabaş (Özsait-Kocabaş, Kocabaş 2008, p. 112-124; Kocabaş, Türkmenoğlu 2009; Kocabaş 2015a, p. 11-12). The YK12 reconstruction project was conducted by I. Özsait-Kocabaş from the IU Department of Conservation of Marine Archaeological Objects. The construction and building technique of YK12, and its comparative evaluations with other Yenikapı shipwrecks, have been discussed in detail in previous contributions (Özsait-Kocabaş 2012, 2013, 2018). This article is focused on the reconstruction studies and replica of the YK12.

## 1. DOCUMENTATION

After sinking and resting on its keel, YK12 was quickly buried by sand, and most of the timbers beneath the amphorae were preserved in their original places. The shipwreck was documented *in situ* involving 3D total station measurements

(drawings made with AutoCad software), full-scale hand drawings, photography, photomosaics and visual evaluations. *In situ* documentation occurred without disturbing the integrity of the hull (Özsait-Kocabaş 2013, p. 49-50). The hull timbers were disassembled and moved to the IU Yenikapı Shipwrecks Research Centre, where they were documented in full-scale using a FaroArm scanner and Rhinoceros 4 software. A complete catalogue of the hull members was established.

## 2. CONSTRUCTION DETAILS

YK12 vessel was built using a mixed construction technique and is very representative of the transition from shell-based to frame-based construction (Pomey *et al.* 2012). Keel timbers were joined together by keyed hook scarfs. The rockered central keel timber and curved keel timber at the stern have transverse holes, presumably used for hauling the vessel ashore. The garboards were fastened in the keel rabbets with treenails. Long planking was joined together with S-shaped scarfs. Hull planking was uniformly edge-joined with dowels from the garboard up to the first wale. There is a pattern throughout the long planks, and scarf directions alternate from bow to stern. The framing pattern consists of L-shaped flat floor timbers combined with short and long futtocks. They were placed with the long arms alternating to port and starboard. Frames were fastened to the planking with treenails and iron nails. Towards the stern, bulkheads were designed in order to store the personal items of the crew. The mast step was fitted on the floor timbers. The ceiling planks were placed and nailed to some floor timbers inside the hull (Özsait-Kocabaş, Kocabaş 2008,



p. 112-124; Özsait-Kocabaş 2012, p. 115-120, 2018). Considering the properties of the wood used, it can be deduced that the builder consciously selected different species of wood for specific uses on the vessel. Chestnut was used for all the planking. The keel members were made from hornbeam and beech. Oak was used for wales, floor timbers and ceiling planks. Walnut was also used for some floor timbers. Ash was preferred for futtocks, mast step and bulkheads. Plane was used for a repair plank (Akkemik, Kocabaş 2014, p. 321).

### 3. RECONSTRUCTION PROCESS

The reconstruction of YK12 was based on the evidence of the hull remains, which are 7 m in length and 2.3 m in width. The bottom of YK12 was well preserved. The surviving parts of the hull consist of the keel, eight planking strakes on the port side and nine planking strakes on the starboard side, two wales on the starboard side, a piece of the starboard caprail, 25 floor timbers, 15 futtocks, the mast step timber and 43 ceiling planks. In contrast to the hull bottom, which maintained its integrity, the majority of the futtocks, deck and upper elements, mast, rigging, and steering components were not found (fig. 1).

In reconstruction, various methods have been developed according to the hull integrity of the wrecks (Steffy 1994, p. 214-234; Crumlin-Pedersen 1996, p. 110-119, 2006, p. 58-71;

Pomey 2003, p. 57-65; McGrail 2006, p. 53-57). The approaches used in the reconstruction of the missing parts of the shipwreck can be handled in three major ways: evidence from the archaeological remains; corroborated acceptable suggestions; and entirely hypothetical suggestions.

First, the evidence from the archaeological remains was evaluated in an attempt to identify missing parts on the basis of the existence of original hull members, and replicate symmetries of the original parts and extend strake ends and planking seams. For example: the locations of missing floor timbers were determined according to the room and space of existing frames. The positions of missing futtocks were determined according to the marks and nails on the planks. Also, positions of the missing ceiling planks were determined according to the marks and nails on the inner surface of the frames. Moreover, shallow notches were identified on the outer surfaces of some of the floor timbers. Based on this evidence, it was suggested that the second wale was positioned at the loaded waterline (fig. 2). The original location of the third wale was determined due to the correspondence of the frame stations of plank 9 and wale 3. A few different 3D models at 1:10 scale were constructed. Physical 3D research models yielded clues about the shape and dimensions of the missing floor timbers, and of the missing planking and wale ends.

After this work, we conducted comparative studies on vessel for the reconstruction of the missing parts. Our attention focused especially on other Yenikapı shipwrecks,

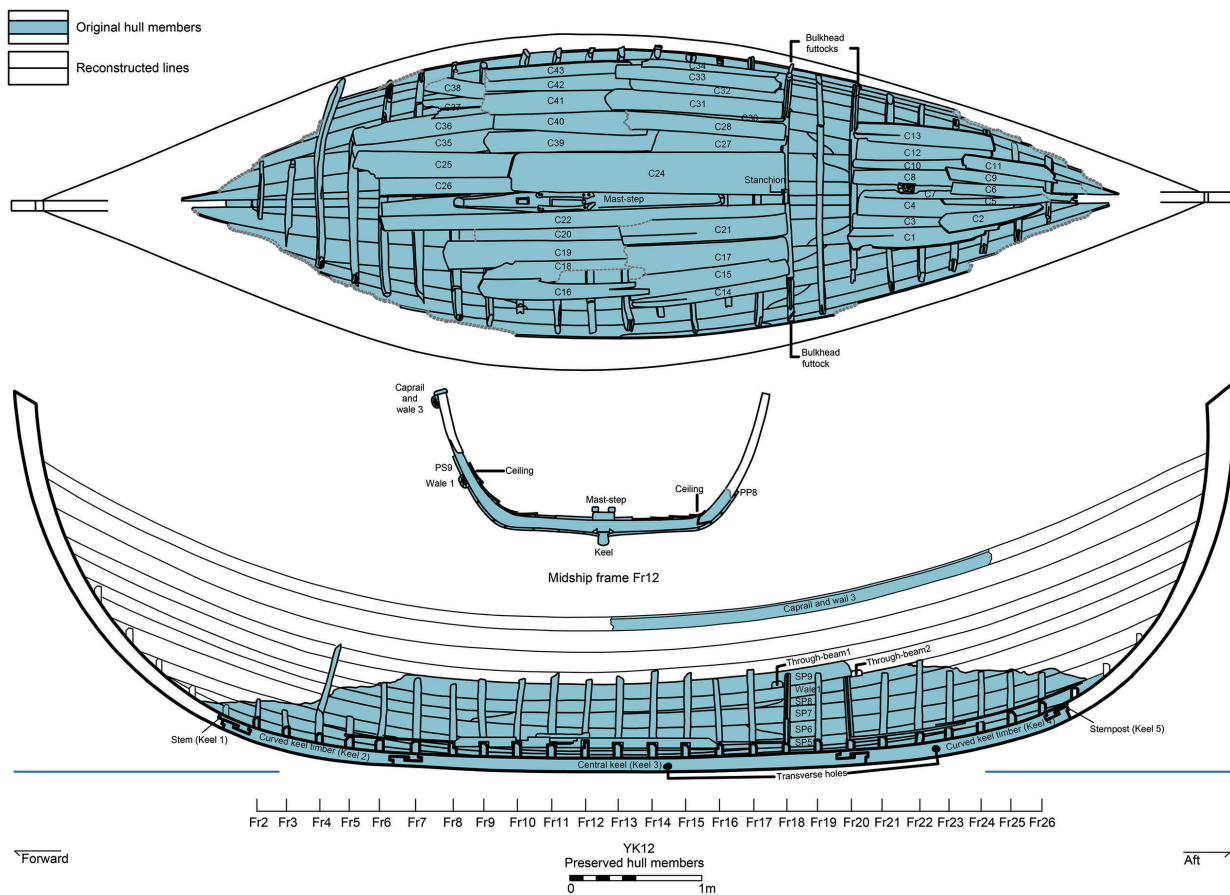


Fig. 1: Preserved hull remains and the reconstructed lines (drawing I. Özsait-Kocabaş, PDV H. Güler and Ç. Şanlıgençler).

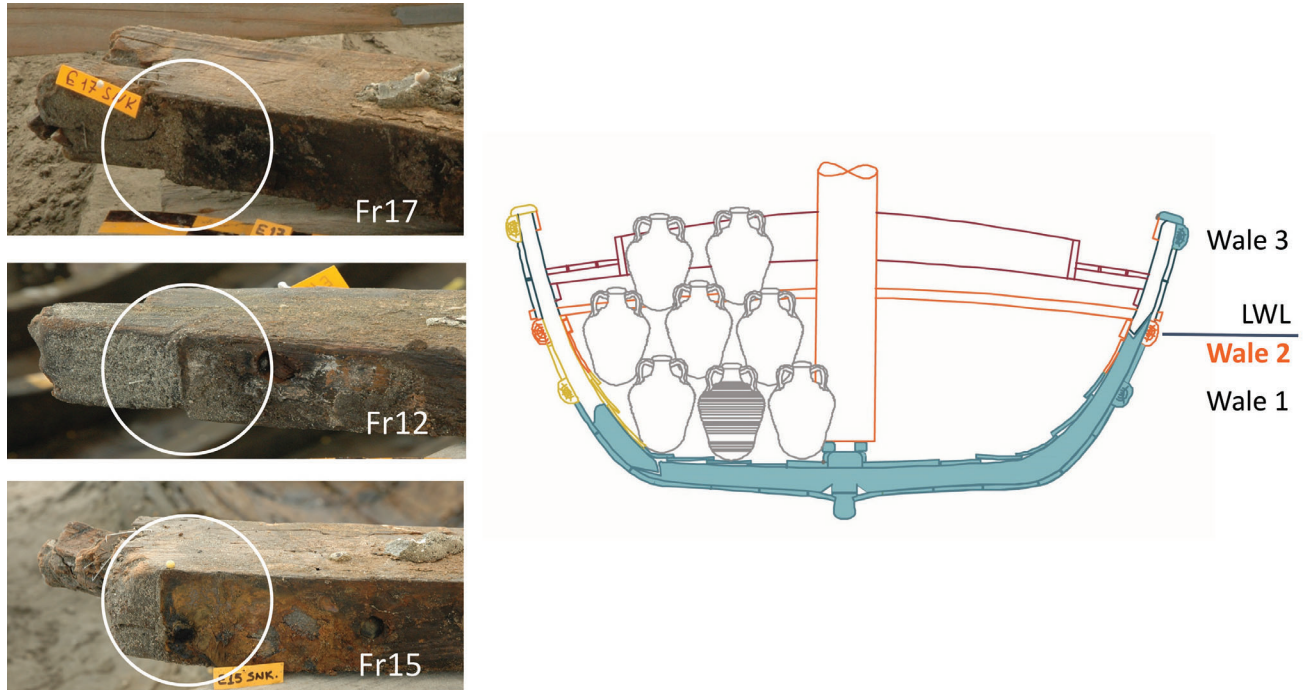


Fig. 2: The evidence of wale 2 on YK12 (drawing I. Özsait-Kocabaş, PDV Ç. Şanlıgençler).

traditional vessels from the Marmara and Black Sea regions (Nutku, Küçük 1963; Turna, Pirim 2015, p. 128-132) and Mediterranean shipwrecks of the same period (Steffy 1982; van Doorninck 1982; Medas 2003; Harpster 2005). The other Yenikapı shipwrecks belonging to the same period, ship type, dimension, function and similar construction tradition helped us a lot. The Yenikapı vessels with plank-edge dowels have many characteristics in common: the majority of these vessels are mostly flat in cross section amidships; diagonal and S-scarfs are used to join planks in a strake; there are transverse holes through the keels amidships and towards the stern, presumably used for hauling the vessels ashore; the framing patterns show long armed floor timbers alternating to port and starboard, except for a few. These vessels date between the 7<sup>th</sup> to the late 10<sup>th</sup> centuries AD.

YK12 can be placed among the small-sized vessels with flat floors and plank-edge dowels, built with chestnut planking (YK 7, YK 8, YK 6, YK 9, and YK 20) (Özsait-Kocabaş, Kocabaş 2008, p. 103-112, 132-139, 2019, p. 325-338; Kocabaş 2015a, p. 8; Güler 2017, p. 280-282). It is suggested that this group belongs to a regional type from the Marmara and Black Sea area. Transverse holes in the keel, a rockered keel, chestnut planks and a bulkhead at the stern are characteristic features of the vessels of these regions (Nutku, Küçük 1963, p. 4).

YK12's lower curve of the posts was deduced from the shapes of the intact planks. Possible forms for the posts at the waterline were estimated by extending the ends of the planks and of the first wale. The third wale and the caprail assisted in increasing the accuracy of the proposed sheer line. For the upper forms of the posts, preserved parts of the other Yenikapı shipwrecks (YK5, YK18, YK29 and YK32) were examined (Özsait-Kocabaş, Kocabaş 2008, p. 140-147; Kocabaş 2015b, p. 100-103, 122-123, 126-127; Pulak *et al.* 2015, p. 55-57).

Ethnographic and other archaeological examples provided some information about the deck of the vessel. Partial decks

are seen on small vessels in the Black Sea and the Marmara Sea. There is no evidence of a full deck, but a mark and a nail hole on frame 6 correspond to a possible stanchion for a partial deck. The mast step timber is the principal indicator of the rigging system. The small size of the vessel and lack of any other mortise on the inner surface of the floor timbers suggests that YK12 had a single mast. In addition, two toggles found inside the hull were evidence of rigging equipment (Denker *et al.* 2013, p. 200). A similar toggle was found in the Tantura B ship, which had a lateen sail and is dated to the 9<sup>th</sup> century AD (Polzer 2008, p. 227). The image of a ship with a lateen sail on an amphora dated to the 9<sup>th</sup> century was discovered in the Yenikapı excavation (Günsenin, Rieth 2012). This particular artefact supplied an important piece of information about our subject. Furthermore, the Yassiada 1 (Steffy 1982, p. 85; Castro *et al.* 2008, p. 351), Bozburun (Harpster 2009, p. 297-298) and Serçe Limanı (Matthews 2004) reconstructions have used archaeological evidence from these ships to suggest lateen sails and a pair of quarter rudders in each case. Byzantine ship images of the era, as hypothetical suggestions, were also used regarding the general hull shape, the lateen sail and the quarter rudders (Omout 1929, pl. CXVII.16, LII; Albani 1997, p. 82, 84; Evgenidou 1997, p. 37-38). YK12 was likely propelled by a single mast, rigged with a lateen sail and steered by two quarter rudders, which were very characteristic of the period. The results suggested a minimum length overall (LOA) of 9.24 m, a beam (Bm) of 2.64 m, and depth (D) of 1.1 m. The reconstructed length-to-beam ratio of the vessel is 3.5 to 1. The hold was 3.20 m long and could carry an average of 210 amphorae and a maximum of 250. Displacement was calculated as *circa* 5.2 tons and the estimated cargo capacity is approximately 3.26 tons at the loaded waterline (Özsait-Kocabaş 2018, p. 386).

These data and their collective evaluation resulted in hand drawings of the lines plan of the vessel, under the supervision



of Prof Dr Abdi Kükner. The drawings also took account of the 3D model studies. The vessel lines were created digitally based on numeric values from offset tables using NAPA software, and the hydrostatic properties were calculated using the same software. The surface and shape of the sail were estimated after initial calculations and tested during the sailing trials of the replica. Since the vessel was to be rebuilt and to be sailed, the reconstruction drawings covered all details of construction. These included: a plan showing the hypothetical hull, together with an elevation and sections drawings; the developed planks necessary for production; scaled drawings of the rigging equipment as well as other elements like the quarter rudders.

#### 4. REPLICA OF YENIKAPI 12

Following the reconstruction studies and the drawing of hull lines and sections, preparations were made for the full-scale sailing replica of YK12. The construction of the replica was completed in collaboration with the RMK Marine shipyard team, experienced carpenters and IU Yenikapı shipwrecks project team. We found financial support from the LIMEN: Cultural Ports from the Aegean to the Black Sea project under the auspices of the European Union. The budget for the construction of the replica was approximately €55,000, however the project only provided financial support for the building of a replica for museum exhibition. Within this limited finance we tried anyway to build a vessel that could sail in the sea. Experimental shipbuilding could not really be conducted because of time and cost limitations: our replica study had been aimed to investigate performance of the vessel at sea.

After the completion of all necessary data, chestnut tree trunks and other timbers were sourced. In order to remove excess water, the sliced chestnut trunks were dried in a controlled procedure. During this two-month procedure, a construction yard about 15 m long and 6 m wide was set up at the RMK Marine shipyard facility. The full-scale drawings of the keel and the frames were printed and moulds were made. These moulds guided shipwrights to cut timbers in the desired forms. Construction began with setting the keel, and thereafter followed the original hull shape, dimensions and tree species. Frame stations on the planking, hook scarfs of keel timbers, S-scarfs of planks and planking pattern were all recreated according to the original vessel. According to prior analyses, turpentine resin had been used for waterproofing the shipwreck, but at this stage we just applied a modern coloured wood protection wax. Once the hull was finished, we started to work on the rudder system. The hypothetical support mechanism and size of the quarter rudders were tested during the first sailing trials in 2017. It has to be noted that the quarter rudders greatly facilitated manoeuvrability in the harbour entrance. For the first sail, the wind was measured at around 22 knots. During this first sailing, there were six people on the boat and about 2 tons of ballast. The replica achieved a maximum average speed of about 5-6 knots in Tuzla harbour. We successfully tacked many times in this large harbour basin.

We sailed a second time in calmer weather for a documentary shooting (figs 3 & 4). After the sailing adventure, the replica was transported to the Istanbul Archaeological Museums garden to be exhibited. In November 2018, Yenikapı 12 was exhibited in the Rahmi M. Koç Museum.



Fig. 3: Sailing the Yenikapı 12 replica (photograph N. Şeralioğlu).



Fig. 4: Sailing the Yenikapı 12 replica (photograph I. Özsait-Kocabaş).

#### 5. CONCLUSIONS

The YK12 reconstruction was realised from the lines plan drawn up on the basis of an overall analysis and comparative study of the YK12 hull remains. This study led us to develop methods that increased the accuracy of ship reconstruction techniques. Suggested hypotheses were tested formally, proportionally and functionally during the YK12 replica's construction and sailing processes. The YK12 reconstruction project aimed at perceiving a 9th century AD ship in its original form and dimensions as a physical visual source. Future exhibitions in both national and international museums and further sailing experiences have been planned.

#### ACKNOWLEDGEMENTS

I would like to extend my sincere thanks to Istanbul Archaeological Museums; to the directors Zeynep Kızıltan

(retired), Rahmi Asal and the experts of the Museum; to the Istanbul University team of Yenikapı shipwrecks and to the project director Prof Ufuk Kocabaş; to Prof Abdi Kükner from ITU; to Prof Ünal Akkemik from IU; to Rahmi Koç, Vera Bulgurlu and Ertuğrul Duru for their contribution to the reconstruction work at RMK Marine Shipyard; to Özgür Numan, Orhan Can, Oğuz Avcı, Mercan Tara Şişman, Tayfun Bilgili, Damla Pay, Dilek Çıracı, Orhan Bağ, Şaban Er, Şaban Tuğtepe, Sercan Koşan from RMK Marine Shipyard; to Orkan

Köyağasioğlu, Seçil Kocabaş and to all the relevant departments at Istanbul University. The Yenikapı Shipwrecks Project was supported by the Istanbul University Scientific Research Projects Units (Projects no 2294, 3907, 7381, 12765). The reconstruction works were supported by the LIMEN Project, in the framework of the Black Sea Basin Programme, co-financed by the European Union through the European Neighbourhood and Partnership Instrument and the Instrument for Pre-Accession Assistance.

## REFERENCES

- AKKEMİK Ü, KOCABAŞ U.  
2014 Woods of Byzantine trade ships of Yenikapı (Istanbul) and changes in wood use from 6<sup>th</sup> to 11<sup>th</sup> century, *Mediterranean Archaeology and Archaeometry* 14. 2, p. 317-327.
- ALBANI J.  
1997 Sea journey, in D. Zafiropoulou (ed.), *Journeys on the Seas of Byzantium*, Athens, Hellenic Ministry of Culture, p. 82-87.
- CASTRO F., FONSECA N., VACAS T., CICILIOT F.  
2008 A quantitative look at Mediterranean lateen- and square-rigged ships (Part 1), *IJNA* 37.2, p. 347-359.
- CRUMLIN-PEDERSEN O.  
1996 Problems of reconstruction and the estimation of performance, in R. Gardiner, A. E. Christensen (eds), *The Earliest Ships, Conway's History of Ships*, London, Naval Institute Press, p. 110-119.  
2006 The Dover Boat – a reconstruction case-study, *IJNA* 35.1, p. 58-71.
- DENKER A., DEMIRKÖK F., KIRAZ M., AKBAYTOGAN T.  
2013 YK12, in Z. Kızıltan (ed.), *Stories from the Hidden Harbor: The Shipwrecks of Yenikapı*, Istanbul, Vehbi Koç Vakfı, p. 197-209.
- EVGENIDOU D.  
1997 Byzantine shipbuilding, in D. Zafiropoulou (ed.), *Journeys on the Seas of Byzantium*, Athens, Hellenic Ministry of Culture, p. 32-39.
- GÜLER T.  
2017 Construction technique of the Yenikapı 20 shipwreck, found in the Harbour of Theodosius (Istanbul, Turkey), in J. Gawronski, A. van Holk, J. Schokkenbroek (eds), *Ships and Maritime Landscapes, Proceedings of the Thirteenth International Symposium on Boat and Ship Archaeology (ISBSA 13), Amsterdam 2012*, Eelde, Barkhuis, p. 280-282.
- GÜNSENİN N., RIETH E.  
2012 Un graffito de bateau à voile latine sur une amphore (1<sup>er</sup> s. ap. J.-C.) du Portus Theodosiacus (Yenikapı), *Anatolia Antiqua* 20.1, p. 157-164.
- HARPSTER M.  
2005 *A Re-assembly and reconstruction of the 9th-century AD vessel wrecked off the coast of Bozburun, Turkey*, PhD dissertation, Texas A&M University, Department of Anthropology, College Station.  
2009 Designing the 9th century-AD vessel from Bozburun, Turkey, *IJNA* 38.2, p. 297-313.
- KIZILTAN Z.  
2010 Excavations at Yenikapı, Sirkeci and Üsküdar within Marmaray and Metro projects, in U. Kocabaş (ed.), *Istanbul Archaeological Museums, Proceedings of the 1<sup>st</sup> Symposium on Marmaray-Metro Salvage Excavations, 2008*, Istanbul, Epsilon, p. 1-16.
- KOCABAŞ U.  
2015a The Yenikapı Byzantine-era shipwrecks, Istanbul, Turkey: A preliminary report and inventory of the 27 wrecks studied by Istanbul University, *IJNA* 44.1, p. 1-35.  
2015b *Geçmişe Açılan Kaptı, Yenikapı Batıkları*, İstanbul, Ege Yayınları.
- KOCABAŞ U., TÜRKMEÑOĞLU E.  
2009 Yenikapı shipwrecks: fieldwork, conservation-restoration procedures and construction features, in X. Nieto, M. A. Cau (eds), *Arqueologia Nàutica Mediterrània*, Girona, CASC-Museu d'Arqueologia de Catalunya, Monografies del CASC 8, p. 235-243.
- MATTHEWS S. D.  
2004 Evidence for the rig of the Serçe Limanı ship, in G. F. Bass, F. H. van Doorninck Jr. (eds), *Yassi Ada, Vol I: A Seventh-Century Byzantine Shipwreck*, College Station, Texas A&M University Press, p. 32-64.
- MCGRAIL S.  
2006 Some principles for the reconstruction of ancient boat structures, *IJNA* 35.1, p. 53-57.
- MEDAS S.  
2003 The Late-Roman Parco di Teodorico wreck, Ravenna, Italy: preliminary remarks on the hull and the shipbuilding, in C. Beltrame (ed.), *Boats, Ship and Shipyards. Proceeding of the Ninth International Symposium on Boat and Ship Archaeology (ISBSA 9), Venice 2000*, Oxford, Oxbow Books, p. 42-48.
- NUTKU A., KÜCÜK F.  
1963 Türk kıyı tekneleri I 'Çektirme' 'Gulet', *ITU Gemi Enstitüsü Bülteni* 8, p. 1-36.
- OMONT H. A.  
1929 *Miniatures des plus anciens manuscrits Grecs de la Bibliothèque Nationale*, Paris Librairie Ancienne Honoré Champion.
- ÖZSAIT-KOCABAŞ I.  
2012 Hull characteristics of the Yenikapı 12 shipwreck, in N. Günsenin (ed.), *Between Continents, Proceeding of the Twelfth International Symposium on Boat and Ship Archaeology (ISBSA 12), Istanbul 2009*, Istanbul, Ege Yayınları, p.115-120.  
2013 The centuries long voyage of ship Yenikapı 12, in Z. Kızıltan (ed.), *Stories from the Hidden Harbor Shipwrecks of Yenikapı*, Istanbul, Vehbi Koç Vakfı, p. 47-55.  
2018 The Yenikapı 12 shipwreck, a 9th century merchantman from the Theodosian Harbour in Istanbul, Turkey: construction and reconstruction, *IJNA* 47.2, p. 357-390.  
2019 The anatomy of a Byzantine vessel: Yenikapı 8 shipwreck, *Art-Sanat* 11, p. 325-338.



ÖZSAIT-KOCABAŞ I., KOCABAŞ U.

2008 Technological and constructional features of Yenikapı shipwrecks: A preliminary evaluation, in U. Kocabaş (ed.), *The 'Old Ships' of the 'New Gate' 1, Yenikapı shipwrecks*, Istanbul, Ege Yayınları, Vol. I, p. 97-186.

POLZER M. E.

2008 Toggles and sails in the ancient world: rigging elements recovered from the Tantura B shipwreck, Israel, *IJNA* 37.2, p. 225-252.

POMEY P.

2003 Reconstruction of Marseilles 6th century BC Greek ship, in C. Beltrame (ed.), *Boats, Ship and Shipyards, Proceeding of the Ninth International Symposium on Boat and Ship Archaeology (ISBSA 9), Venice 2000*, Oxford, Oxbow Books, p. 57-65.

POMEY P., KAHANOV Y., RIETH E.

2012 Transition from Shell to Skeleton in Ancient Mediterranean Ship-construction: analysis, problems, and future research, *IJNA* 41.2, p. 235-314.

PULAK C., INGRAM R., JONES M.

2015 Eight Byzantine shipwrecks from the Theodosian Harbour excavations at Yenikapı in Istanbul, Turkey: an introduction, *IJNA* 44.1, p. 39-73.

STEFFY J.R.

1982 Reconstructing the hull, in G.F. Bass, F.H. van Doorninck. (eds), *Yassı Ada Vol I: Seventh-Century Byzantine Shipwreck*, College Station, Texas A&M University Press, p. 65-86.

1994 *Wooden Ship Building and the Interpretation of Shipwrecks*, College Station, Texas A&M University Press.

TURNA İ., PIRIM A. E.

2015 A study about the brief history of the vessel named 'Çektirme' and its role on the commercial activities of its age. *Sosyal Bilimler Araştırmaları Dergisi* 12, p. 119-135.

DOORNINCK VAN F. H.

1982 The hull remains, in G.F. Bass, F.H. van Doorninck (eds), *Yassı Ada Vol I: Seventh-Century Byzantine Shipwreck*, College Station, Texas A&M University Press, p. 32-64.

# THE OSEBERG SHIP: REFLECTIONS ON THE CHOICE OF METHODOLOGY WHEN TESTING EXPERIMENTAL ARCHAEOLOGICAL RECONSTRUCTIONS

Vibeke BISCHOFF

---

## Abstract

*Saga Oseberg*, a full-scale reconstruction of the Oseberg ship, has been tested using different approaches. First, the principles employed for handling traditional square-rigged boats from Norway were applied. The ship manoeuvred badly, and this was taken as proof that the reconstruction was incorrect. Subsequently, a new programme of test sailing was undertaken using a more investigative approach to the full-scale reconstruction, resulting in a marked improvement in the ship's performance. This paper will present an outline of the methods used, posing critical questions as to the application of more recent sailing traditions to the handling of archaeological reconstructions: is it possible to set one's preconceptions aside to let replicas 'speak' for themselves?

## Keywords

Full-scale reconstruction, Norway, Oseberg, square sail Viking

## Résumé

*Saga Oseberg*, réplique navigante à l'échelle du navire d'Oseberg, a été testée en utilisant différentes approches. On a tout d'abord tenté d'appliquer les principes liés à la marche des bateaux traditionnels à gréement carré de Norvège. La réplique *Saga Oseberg* s'est révélée peu manœuvrante, ce qui a été interprété comme la preuve d'incorrections dans la reconstruction. Par la suite, un nouveau programme d'essai de navigation a été entrepris en portant plus d'attention aux caractéristiques hydrostatiques et hydrodynamiques de la réplique, ce qui a permis une nette amélioration des performances du navire. Cet article présente un aperçu des méthodes utilisées, en posant un regard critique sur l'application des traditions nautiques les plus récentes lors de la manœuvre des répliques: est-il possible de mettre de côté les idées préconçues pour laisser les répliques « parler » d'elles-mêmes?

## Mots clés

Réplique navigante, Norvège, Oseberg, voile carrée Viking

---

The Oseberg ship was built in western Norway in AD 820 and was placed in a burial mound near Tønsberg, Norway, in AD 834 (Bonde 1994, p. 138-141; Bonde, Stylegar 2009, p. 163-164). The 21.5 m-long and 5.1 m-wide ship is the earliest known Viking ship with traces of sail and rigging (Christensen 1997, p. 302). It is therefore an important source in terms of understanding the development and composition of rigging in Viking Age Scandinavia, with a view to exploring the ship's sailing performance (Bischoff 2017, p. 1-5). The ship has previously been interpreted as merely a royal yacht intended for inshore sailing in fair weather (Brøgger, Shetelig 1951, p. 154-156; Christensen *et al.* 1993, p. 149-150; Christensen 1996, p. 83), however, given the locations of its site of construction and subsequent deposition, the ship had obviously sailed in open waters in the North Atlantic, the North Sea, and Skagerrak, and is therefore likely to have performed well under sail.

To date, two full-scale reconstructions of the Oseberg ship have been built. The first, *Dronningen*, (*The Queen*) capsized and sank during the first sea trials in 1988. The second, *Saga Oseberg*, was launched in 2012 and sailed badly until a change of methodology gave very different results. This gave rise to an awareness of what questions to ask – and how to ask them – when test sailing a full-scale reconstruction.

*Dronningen* left a long list of questions in its wake when it capsized (Andersen, Andersen 1989, p. 246-253; Carver 1995, p. 289-304). The full-scale reconstruction was based on drawings of the exhibited ship, so new studies of the archaeological

ship were therefore carried out in 2007. The new reconstruction led to a hull form with more buoyancy, broader bow and greater keel rocker (Bischoff 2012, p. 337-342). A hydrodynamic test carried out in 2008 showed that the new hull form had more stability and improved performance (Prince *et al.* 2008; Bischoff 2012, p. 341-342).

The new hull form resulted in the second full-scale reconstruction of the Oseberg ship, *Saga Oseberg*, which was launched in 2012.

*Saga Oseberg* was built as close to the original ship as was possible, using the same methods, materials and tools as on the original ship (Finderup 2018). It was therefore expected to perform close to what the original ship did. The sail and rigging was reconstructed based on traces of the rigging in the archaeological ship. In the Oseberg ship the mast position is preserved in the keelson and the mast partner, and the tack and sheet positions can be deduced from holes and clamps. These traces of the rigging give a distinct frame for the approximate width of the square sail that the ship originally carried (Bischoff 2017, p. 3-12). Based on iconographic and written sources from AD 700 to AD 1300, *Saga Oseberg* was reconstructed with a right-angled square sail of handwoven wool of the same quality as a fragment found in the original ship (Andersen 1995, p. 249-270; Andersen, Bischoff 2016, p. 137-156; Bischoff 2017, p. 5) (fig. 1)

Before it was launched, the new reconstruction had already been subject to criticism from traditional Norwegian boat-builders, with doubts being raised as to the validity of the new



**Fig. 1:** The Oseberg Ship has an impressive appearance, with high curved stems with beautiful stem ornamentations and woodcarvings. Saga Oseberg was built by The Oseberg Viking Heritage Foundation in Tønsberg, Norway (<http://osebergvikingarv.no/>) (photograph Werner Karrasch, the Viking Ship Museum in Roskilde, Denmark).

hull form, especially its considerably rockered keel. Test sailing the full-scale reconstruction would now show if the changes in the hull form had led to an improvement in sailing performance.

## 1. METHODOLOGY OF TEST SAILING NO. 1

The first test sailing of *Saga Oseberg* was undertaken in Norway in 2013 using the principles employed for handling traditional square-rigged boats from western Norway, more specifically the Nordland boat and the Åfjord boat (Eldjarn, Godal 1988, p. 47-67, 1990, p. 256-299) (fig. 2).

It seemed reasonable to do so because there are striking parallels between these ethnographic boats from the 19<sup>th</sup> century and ship finds from the Viking Age in terms of the hull construction and composition of the rig (Andersen *et al.* 1997, p. 145-151; Andersen, Andersen 1989, p. 53-136; Crumlin-Pedersen 1997, p. 130-140). This has led to the accepted understanding that these boats had developed in a direct line from the Viking Age.

Even though the Nordland boat and Oseberg ship have similarities, the ships also have differences, and these differences might be of greater importance than expected. The Nordland boat has a trapezoidal sail, straight keel, stretched bottom and sides, and a stern rudder, while the Oseberg ship has a rectangular sail, curved keel, curved side and bottom, and a side

rudder. The mast's angle and position in the Oseberg ship was fixed in a keelson and mast partner, while the Nordland boat has an adjustable mast, in the sense that the mast step can be moved, and the heel angle of the mast can be changed: all significant details when it comes to the handling of the boats.

The principles of the test sailing procedure of the Nordland boat were written down in the 1980s, based on interviews with old fishermen, who had sailed these boats for a lifetime (Eldjarn, Godal 1990, p. 68-69; Tordsson 1999, p. 66-72). According to the procedure, the ship should be trimmed 1-1.5 degrees aft, which is considered as being the normal trim condition. After this, the ship is tested under oars in side wind to check if the hull, with the sail lowered, has a tendency to either a lee helm or weather helm. If needed, the ballast is moved longitudinally in the hull, so that the hull moves straight through the water. After this, the ballast position cannot be changed (fig. 3).

## 2. TRIM AND BALANCE

A test sailing inevitably includes theorising about hydro- and aerodynamic forces, and how these affect the ship's trim. This can be briefly explained as follows.

The ship is in trim when it manoeuvres in a balanced manner through the water without lee helm or weather helm. This requires balance between the sail and the hull. When the





**Fig. 2:** The Nordlandsbåd from the 1800 century has many similarities to ships from the Viking Age (photograph Werner Karrasch, the Viking Ship Museum in Roskilde, Denmark).

aerodynamic centre in the sail and the hydrodynamic centre on the hull are vertically aligned, the hull and sail are in balance and the ship in trim. If not, the ship will either have lee helm or weather helm. The balance can be influenced by positioning the sail differently, or trimming the hull with ballast. If the ship is trimmed down in the aft or down in the bow, the ship will turn either away from the wind or towards the wind respectively. The same applies to the sail. If the sail is moved aft, by changing the tack position aft, the ship will have weather helm, or lee helm if done the opposite.

### 3. TEST SAILING NO. 1 IN ACTION

The first test sailing was undertaken by a full crew of experienced sailors – including the author – used to sailing traditional Norwegian square-rigged boats, under the direction of a Norwegian traditional boat researcher, Jon Godal.

The preconception of Godal prior to the test sail was that the Viking ship was expected to behave like the traditional Norwegian boat (Godal 2013, p. 1). Therefore, the stone ballast was placed in *Saga Oseberg* giving a trim at one degree aft, in accordance with traditional boat handling. The following rowing test in side wind showed neither lee nor weather helm on the hull, and the ballast was therefore kept in the tested position, with 2,500 kg in the central area by the mast, and 500 kg in the very aft of the hull.

When the sail was set at the tack position for beating, it quickly became apparent that the ship manoeuvred badly. The ship was unable to tack, and drifted sideways on the course. Since the hull form of *Saga Oseberg* was more rockered than the exhibited Oseberg ship, Godal considered the rudder to be too short and thus it did not go deep enough into the water under the keel. In an attempt to improve the ship's steering, the rudder was replaced with a larger and longer rudder, disregarding the fact that the Oseberg ship was found with the original rudder in place. There was therefore much discussion as to whether or not such a deviation from the archaeological material should be allowed when conducting experimental archaeological research.

According to Godal, the test sailor cannot be expected to relate to the archaeological material, but only to the full scale reconstruction as it is built: and the test sailor's job is to make the ship function. If the ship needs changes in order to function, this is a direct message to the 'reconstructor' that the reconstruction is wrong (Godal 2013, p. 1, 2014, p. 1-2).

In any case, the increased rudder size was not enough to steer the ship. *Saga Oseberg* was still not able to beat to windward, due to the substantial lee helm. It was not possible to obtain balance between the sail and the hull.

*Saga Oseberg's* poor sailing performance was taken as proof that the reconstruction of the hull form was incorrect. Godal presented a series of conclusions, which he saw as explaining the poor performance (Godal 2013, p. 7-8):

- As expected, the rockered keel gave the ship an unstable trim;
  - It was necessary to lengthen the rudder because of the keel rocker. This indicates that the keel was not rockered originally;
  - The sail was too broad or not trapezoidal enough to balance with the hull, because the keel's operational area is too short due to the rocker;
  - The ship had lee helm and was unable to beat to windward. Again, this was interpreted as being a result of the curved keel's short operational area;
  - The ship is not seaworthy when beating and rowing is not possible.
- Godal made some suggestions as to how to experiment with improving *Saga Oseberg's* performance (Godal 2013, p. 8-9):
  - Lengthen the rudder by up to 50 cm more than the original rudder;
  - Make the keel straight on the mid-part by adding a false keel;
  - Let the bow and stern drop down, to make the keel curve straighter;
  - Heel the mast aft in order to move the aerodynamic centre aft to balance with the hull;
  - Redesign the sail to be narrower and trapezoidal.

### 4. DISCUSSION OF TEST SAIL NO. 1

Roughly speaking, these suggestions closely resemble a Nordland boat. Godal did not put aside his own preconceptions, and instead based his conclusions on his knowledge of construction and experience of sailing the Nordland boat. This made him question the rockered keel throughout the whole test sailing process.

The testing of the full-scale reconstruction is not only a direct message to the constructor but is also a direct message to the test sailor. However, Godal's suggestions listed above all focus on changing the reconstruction, instead of the boat handling.

The positioning of the ballast, which trimmed the ship one degree aft, had influenced the trim by moving the hydrodynamic centre of the hull aft. This is the reason why *Saga Oseberg* would manoeuvre better with the mast heeled aft, because by doing so, the aerodynamic centre in the sail also moved further aft and corresponded with the hydrodynamic centre. Making the sail narrower and trapezoidal would have had the same effect, since the aerodynamic centre lies in the front 1/3 of the sail (Andersen, Andersen 1989, p. 127).



From an experimental archaeological point of view, the mast position as well as sail breadth and shape cannot be changed since they are preserved in the original ship. The mast position and angle in the Oseberg ship is fixed between the keelson and the mast partner supporting the mast. It was not meant to be – and cannot be – in any other position or angle. The sail breadth is the ship’s most probable original sail breadth. The iconographic material shows that Viking Age sails were right-angled and not trapezoidal, as those used on boats from the North Atlantic area in more recent times (Bohlmann 2014, p. 113-119; Bischoff 2017, p. 12-22).

## 5. METHODOLOGY AND ACTION OF TEST SAILING NO. 2.

A further series of test sails was undertaken on Roskilde Fjord in 2015 under the direction of the author and using a different methodological approach. The hull, sail and rudder functioned in unison on the original ship and therefore should be able to again without changing their form. In order to work backwards from the archaeological evidence to the possible boat handling of the ship in its own time and context, the original mast, sheet and tack position must be kept when test sailing. Instead of the suggested changes to the archaeological evidence (hull, rudder and sail), boat handling was the primary focus of the second test sailing program.

Based on the firm belief that the archaeological ship embodied experience and knowledge from the 9th century, the rudder was changed back to a reconstruction of the Oseberg ship’s original rudder. The reconstructed rudder functioned better with the ship but did not solve the overall problems of the ship’s manoeuvrability.

The investigation of *Saga Oseberg*’s ability to beat to windward continued. It was clear that the ship had a considerable lee helm with close-hauled sheets, and beating and tacking was almost impossible.

In order to find the right trim of the ship, “off-duty” crewmembers formed a group and moved metre by metre longitudinally in the ship, until the ship had a stable course with the rudder in neutral position. The group of crewmembers (700-800 kg) was standing two metres in front of the mast when the hull and sail finally balanced. The ship’s trim was then measured as 0 degree.

All crewmembers moved to where they would normally be positioned during sailing, and the ballast was adjusted. The 500 kg that was placed far aft in the ship by the rudder during the first test sail – in order to trim the aft down 1 degree – is a tough way of trimming a ship, because the weight arm from the ship’s centre of buoyancy is considerable, and diminishes the crew’s ability to trim the ship longitudinally with their body weight.

In order to place the ballast so that the hull trimmed at 0 degrees, the 500 kg was moved forward to the centre of the ship. In the Oseberg ship, the deck planks were fastened with treenails, except in the centre area around the mast, indicating that the ballast was originally positioned here. The new balance between hull and sail resulted in a very different sailing performance. Suddenly *Saga Oseberg* was able to beat. Tacking and manoeuvring went easily and the boat handling was less heavy for the crew (fig. 3).

All the oars from the Oseberg ship were found complete, but ever since the excavation they have been interpreted as being too short for the ship, compared to more recent oars for open boats. The length of the Oseberg oars varies up to half a metre, so the shorter oars could have been used amidships and the longer oars in the bow and stern, which rise higher above the water. The oars for *Saga Oseberg* were made equivalent to the originals and proved to match the longitudinal curved shape of *Saga Oseberg* due to their individual lengths, and rowing showed that it was possible to row the ship at a speed of 5.0 knots.

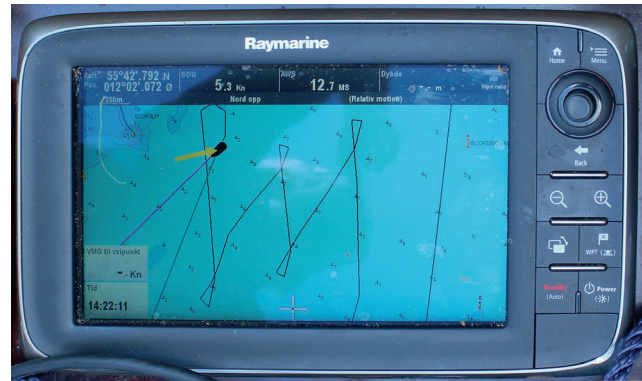


Fig. 3: In wind conditions of 12-14 m/s (force 6) with one reef in the sail *Saga Oseberg* beat 65 degrees to the wind, COG. With full sail 60 degrees is expected, but this has not been documented due to time constraints during the test sailing (photograph Vibeke Bischoff, the Viking Ship Museum in Roskilde, Denmark).

## 6. CONCLUSION

The two test sailing methods gave different results because they were based on different approaches. By choosing a deliberate approach in test sail no. 2 and accepting the archaeological ship, its construction and design as the base for the investigation of the full-scale reconstruction, the second test sailing led to a marked improvement in the ship’s sailing capabilities, and provided information about the capabilities of the Oseberg ship from 820 AD, which was the purpose of the experimental archaeology project.

This shows that the methodology chosen to test a full-scale reconstruction is vital and underlines the need for developing a set of principles for the testing of full-scale reconstructions of archaeological ships, in order to avoid testing from a contemporary, and potentially subjective, perspective.

Prerequisites for the test sailor:

- Experience with trim and balance between the hull and the sail;
- An open and reflective approach towards hull, sail and trim;
- Part of an interdisciplinary team;
- Knowledge of the archaeological foundation;
- Experience with an equivalent type of ship;
- Experience with equivalent rigging;

The key tenets of the methodology:

- The testing follows the experimental archaeological approach defined for the project;
- Focus is kept on the purpose/aim of the project;



**Fig. 4:** When *Saga Oseberg* is in trim, stem ornamentations terminate above the water surface both fore and aft: does the ornamentation mark the ship's original trim? (photograph Werner Karrasch, the Viking Ship Museum in Roskilde, Denmark).

- The ship's details are used analytically to deduce how the ship was originally sailed;
  - The original traces of the rigging set the frame for testing;
  - Experience is used for reflection and for asking relevant questions about ship and boat handling;
  - Presumption is always there: its influence on the given problem must be recognised;
- With the benefit of hindsight, several indications of the Oseberg ship's original trim can be observed on the ship itself. When obtaining balance between hull and sail at 0 degrees, the ship handed down the following characteristics from its former use – a direct greeting from the past:
- The ballast is placed in the only open area in the ship's mid-part;
  - The mast, which is fixed between keelson and mast partner, stands vertically;
  - The ends of the stem ornamentations are right above the waterline both fore and aft (fig. 4);
  - The individual length of the original oars fits the distance from oar holes to the surface;
  - The sail breadth based on the original traces balances with the hull;

- The original rudder functions with the ship;
- The ship manoeuvres well and is able to tack and beat to windward.

The challenges involved in test sailing *Saga Oseberg* have led to a better understanding of how an investigative approach to a full-scale reconstruction and its preserved details can be achieved.

A full-scale reconstruction of an archaeological ship is an unknown product and the test sailor is, as a consequence, a novice on board. Preconceptions and experience are inevitable but should be used indirectly and only to ask the right questions.

It is all about how the ship prefers it and not how the test sailor prefers it. The test sailor is a translator of the implicit knowledge the ship holds. The way this specific ship was handled originally is lost in time, but can be retrieved by studying the details in the original ship's construction and wear in context.

All ships have a personality that will reveal itself with use. If the ship does not manoeuvre effectively, the test sailor must keep asking questions and try to understand the deeper relationships between the ship's parts and details. Doing this means that one must be willing to change one's preconceptions, in order to let reconstructions 'speak' for themselves.



## REFERENCES

- ANDERSEN E.  
 1995 Square sails of wool, in O. Olsen, J. Skamby Madsen, F. Rieck (eds), *Shipshape. Essays for Ole Crumlin-Pedersen*, Roskilde, Viking Ship Museum, p. 249-270.  
 1997 Roar Eges sejl, in E. Andersen, O. Crumlin-Pedersen, S. Vadstrup, M. Vinner (eds), *Roar Ege – Skuldelev 3 skibet som arkæologisk eksperiment*, Roskilde, Vikingskibshallen, p. 141-174.
- ANDERSEN B., ANDERSEN E.  
 1989 *Råsejlet – Dragens Vinge*, Roskilde, Vikingskibshallen.
- ANDERSEN E., BISCHOFF V.  
 2016 Vikingskibsmuseets sejlforskning: Råsejl af uld og plantefibre i vikingetiden, in M. Ravn, L. G. Thomsen, E. A. Strand, H. Lyngstrøm (eds) *Vikingetidens Sejl. Festskrift tilegnet Erik Andersen*, Københavns, Københavns Universitet, Saxo instituttet, Arkæologiske Skrifter 14, p. 137-160.
- BISCHOFF V.  
 2012 Reconstruction of the Oseberg Ship: Evaluation of the Hull Form, in N. Günsenin (ed.), *Between Continents. Proceedings of the Twelfth Symposium on Boat and Ship Archaeology (ISBSA 12), Istanbul 2009*, Istanbul, Ege Yayınları, p. 337-342.  
 2017 Viking Age Sails: Form and Proportions, *Journal of Maritime Archaeology* 12.1, p. 1-24.
- BOHLMANN J.  
 2014 *Segel und ihre Herstellung im 17. Jahrhundert. Rekonstruiert am beispiel eines skandinavischen Lastbootes*, PhD thesis, Norwegische Technisch-Naturwissenschaftliche Universität.
- BONDE N.  
 1994 De Norske Vikingegraves alder. Et vellykket norsk-dansk forskningsprosjekt, *Nationalmuseets Arbejdsmark*, p. 128-148.
- BONDE N., STYLEGAR F.  
 2009 Fra Avaldsnes til Oseberg. Dendrokronologiske undersøkelser av skipsgravene fra Storhaug og Grønhaug på Karmøy, *Viking LXXII*, Norsk arkeologisk årbok, Norsk Arkeologisk Selskap, Oslo, p. 149-168,
- BRØGGER A. W., SHETELIG H.  
 1951 *The Viking ships. Their ancestry and evolution*, Oslo, Dreyer.
- CARVER O. M.  
 1995 On – and off – the Edda, in O. Olsen, J. Skamby Madsen, F. Rieck (eds), *Shipshape. Essays for Ole Crumlin-Pedersen*, Roskilde, Viking Ship Museum, p. 289-304.
- CHRISTENSEN A. E.  
 1996 Proto-Viking, Viking and Norse Craft, in R. Gardiner, A. E. Christensen (eds), *Conway's History of the Ship, The Earliest Ships, The evolution of Boats into Ships*, London, Conway Maritime Press, p. 72-88.  
 1997 Oseberg Ship, in J. Delgado (ed.), *Encyclopaedia of Underwater and Maritime Archaeology*, London, British Museum Press, p. 302-303.
- CHRISTENSEN A. E., INGSTAD A. S., MYHRE B.  
 1993 *Oseberg Dronningens Grav. Vår arkeologiske nasjonalskatt i nytt lys*, Oslo, Chr. Schibsteds Forlag A/S.
- CRUMLIN-PEDERSEN O.  
 1997 *Viking-Age Ships and Ship-building in Hedeby/Haithabu and Schleswig, Schleswig / Roskilde*, Viking Ship Museum, Ships and Boats from the North 2.
- ELDIARN G., GODAL J.  
 1988 *Nordlandsbåten og Åffjordsbåten. Bind 3: Åffjordsbåten*, Lesja, A. Kjellands Forlag A.S.  
 1990 *Nordlandsbåten og Åffjordsbåten. Bind 2. Nordlandsbåten. Byggeteknik og måledata*, Rissa, Båttstikka D/A.
- FINDERUP T. S.  
 2018 *Saga Oseberg. Rekonstruktion af et vikingeskib*, Jyllinge, Veterania.
- GODAL J.  
 2013 *Prøvesegling med Saga Oseberg*, unpublished report.  
 2014 *Osebergskip i fleire varianter*, unpublished report.
- TORDSSON B.  
 1999 *Godt sjømannskap i tradisjonelle bruksbåter*, Oslo, Forbundet kysten.
- PRINCE M., WERENSKIOLD P., MAGNUS R. T.  
 2008 Towing tank tests on two hull variations of the Viking ship Oseberg, *Marintek report no. 530474.00.01*, Trondheim, Marintek, unpublished report.

# THE SKULDELEV 3 RECONSTRUCTION, *ROAR EGE*: FROM RECONSTRUCTION TO RETIREMENT

Martin Rodevad DAEL and Triona SØRENSEN

## Abstract

In 1982, the Viking Ship Museum embarked upon its first full-scale reconstruction of a Viking ship. The vessel in question was based on the remains of Skuldelev 3, an 11<sup>th</sup>-century coastal transport and trading vessel, which had been excavated 20 years previously. The reconstruction, *Roar Ege*, was launched in 1984 and retired from service in 2016, providing a complete data set over the lifespan of a reconstructed Viking ship. This article will present an object biography of *Roar Ege*, from the perspective of both the boatbuilder and archaeologist, detailing the manner in which the hull has deteriorated, and the components involved in its decline.

## Keywords

Denmark, experimental archaeology, shipbuilding, reconstruction, Viking Age

## Résumé

C'est en 1982 que le Musée des Navires Vikings de Roskilde a entrepris sa première reconstruction à grande échelle d'un bateau Viking, basée sur les vestiges de l'épave Skuldelev 3. Ce navire, fouillé deux décennies plus tôt, a été identifié comme une unité de transport et de commerce côtier daté du XI<sup>e</sup> siècle. La réplique baptisée *Roar Ege*, lancée en 1984 et retirée du service en 2016, a fourni un ensemble exhaustif de données sur la durée de vie d'un navire viking. Cet article présente une biographie de la réplique *Roar Ege*, du point de vue du charpentier de marine et de l'archéologue, et détaille la manière dont la coque s'est détériorée et les composants impliqués dans son déclin.

## Mots clés

Danemark, archéologie expérimentale, construction navale, reconstruction, période viking

In 1962, the remains of five late Viking-age ships were excavated near Skuldelev on Roskilde Fjord, on the Danish island of Zealand (Crumlin-Pedersen, Olsen 2002). The excavation and analysis of the Skuldelev ships has been published in depth elsewhere but warrants a brief summary in the context of this paper (Crumlin-Pedersen, Olsen 2002).

The five Skuldelev ships demonstrate the diversity and specialisation of late Viking-age shipbuilding. The find encompasses two warships, one large ocean-going cargo vessel and two smaller cargo/fishing vessels for coastal use (Crumlin-Pedersen, Olsen 2002). The best preserved of the five ships is Skuldelev 3: a 14 m-long cargo/transport ship built in Denmark around AD 1040 (Crumlin-Pedersen 2002, p. 239). The aft section of the ship did not survive but roughly 75% of the hull remained, making it the most complete Viking ship found in Denmark to date (fig. 1).

Twenty years after the initial excavation of the Skuldelev ships, the Viking Ship Museum began the first of a series of reconstructions of archaeological ship-finds, marking the commencement of a programme of experimental archaeological research that would come to define the Museum and its academic endeavours.

## 1. THE *ROAR EGE* PROJECT: SKULDELEV 3 AS AN ARCHAEOLOGICAL EXPERIMENT

Under the direction of a steering committee with Ole Crumlin-Pedersen as chairman, the *Roar Ege* project ran from

1982 to 1984 (Crumlin-Pedersen 1986a, 1986b; Andersen *et al.* 1997, p. 11). As with all archaeological experiments, the *Roar Ege* project also had a clear set of goals, which defined the overall scope of the project:

1) The project would provide the opportunity to conduct scientific investigations into Viking-age shipbuilding and seafaring;

2) Through photos and film, the project would provide a unique insight into Viking ships and how they were handled;

3) The project would create a direct link between the original ship-find as exhibited in the Ship Hall and the full-scale reconstruction for visitors to the Museum;

4) The project would also allow visitors to the Museum to try their hand at various craftwork processes.

From the outset, it was the stated intention of the steering committee that the research-based elements of the project would always take precedence over the education and outreach aspects of the build (Andersen *et al.* 1997, p. 10). As such, the steering committee also laid out the following rules, which provided the basis for the archaeological experiment (Andersen *et al.* 1997, p. 11):

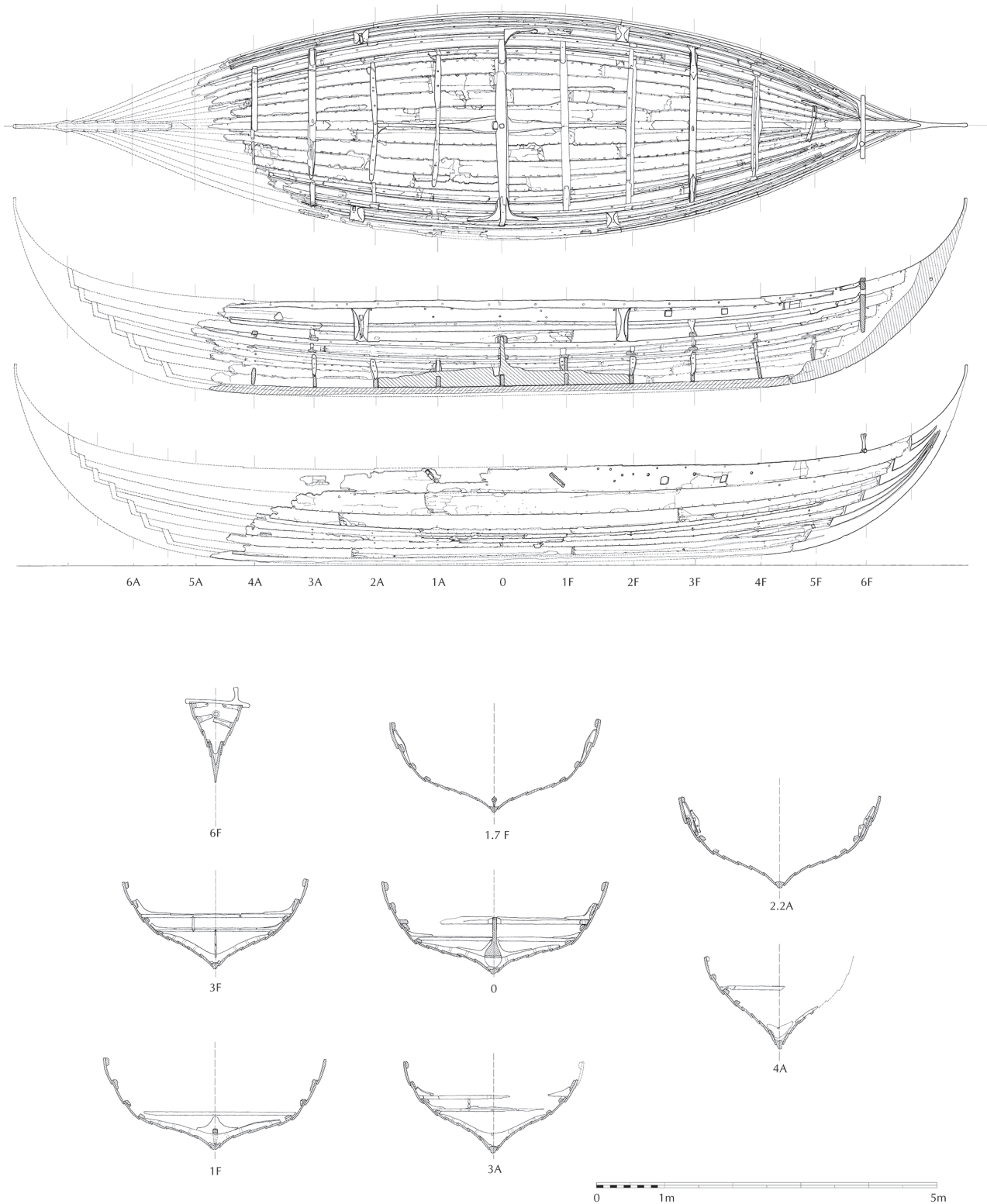
a) The build should be led by a group of specialists within the fields of Viking ship research, shipbuilding, rigging and sailing, with Søren Vadstrup as stem smith, Erik Andersen as rig master and Max Vinner as helmsman;

b) The ship should be built using the same materials and techniques as can be seen on the original find;

c) The ship should be built as an exact reconstruction of the original ship, as it would have appeared when newly built;

d) The entire process should be documented in text and photographs;





**Fig. 1:** Torso-drawing of all preserved parts of the ship-find, Skuldelev 3, assembled to their original context and shape (after Crumlin-Pedersen, Olsen 2002, p. 229, fig. 40)

e) A programme of test-sailing must be undertaken after the launch to establish the ship's sailing capabilities, cargo capacity etc.;

f) The work would be concluded with the publication of the project and its results.

There was one further important tenet in relation to the actual building process itself: the work of building the ship would primarily be carried out by a group of young people with experience from previous ship-reconstruction projects but without formal boatbuilder educations. The philosophy behind

this decision was that modern boatbuilders, even those versed in traditional methods, would be unable to leave their inherent learning and understanding of tools, techniques and materials ‘at the door’. They would inevitably, consciously or otherwise, apply a 20th-century craftsman’s mindset to the task at hand, which could have an impact on the process of rediscovering Viking-age boatbuilding techniques (Andersen *et al.* 1997, p. 80).

During the course of the build, the team became proficient in the use of reconstructed Viking-age woodworking tools and techniques, developing a skill set and an understanding of materials that would go on to become the foundation for all subsequent experimental archaeological reconstruction projects at the Museum’s boatyard.

The construction phase lasted for two years, during which time the entire process was documented in detail. Table 1 gives an overview of the main materials involved in building a reconstruction of Skuldelev 3’s hull.

A total of *circa* 54.21 m<sup>3</sup> of green timber was required to build *Roar Ege*, equating to roughly:

- Ten oaks, varying in diameter from 0.45 m to 1 m, and in length from 4.4 m to 12 m;
- Two pine logs, with diameters of 0.3 m and lengths of 10.5 m;
- Two willow logs, with diameters of 0.4 m and lengths of 4 m;
- 60 pieces of crooked oak for knees;
- 25 pieces of crooked oak for floor timbers.

It lies beyond the remit of this article, but it should be stated that a final tally of materials would include a far broader range of materials and resources: tar for treating the hull, charcoal for the production of rivets and roves, the wooden elements of the rigging, the ropes themselves, the sail, oars and anchor. For the purpose of this article and the examination of *Roar Ege*’s decline, the focus will remain on the hull itself.

*Roar Ege* was launched on August 25, 1984 and the waterborne part of the archaeological experiment could begin (Crumlin-Pedersen 1986b) (fig. 2).

A volunteer boat guild was established and given responsibility for the general maintenance of the ship, as well as for sailing the vessel. This guild was largely comprised of the same group of people who had built the ship, something that instilled a strong sense of ownership and responsibility for *Roar Ege*. This can be seen in the high standard of documentation the guild carried out during the years the ship was in active use, noting everything from where and how far they sailed to when repairs and maintenance were carried out, and by whom.

As with all of the reconstructions in the Museum’s collection, there is a division of labour in terms of the maintenance and repair of vessels. Boat guilds are responsible for the general maintenance – tarring, painting, small repairs to the sail and rig and so on – while any repairs demanding a more experienced hand are carried out by the Museum’s professional boatbuilders.

## 2. LANDS, ROT AND RUST: CLINKER-BUILDING AND ITS INHERENT COMPLICATIONS

Various small running repairs were carried out during the first two decades in which *Roar Ege* was in use. The first major repair came in 2003, when the mast, the two uppermost strakes, stringers, and several knees and futtocks had to be replaced due to rot.

This repair encapsulates one of the major challenges associated with maintaining clinker-built boats. Despite regular attention and care, the construction method itself, the many overlapping components of the hull and the manner in which they are fastened, creates a fertile breeding ground for rot. Additionally, with the passage of time and the wearing of a relatively flexible hull construction, components fastened with treenails tend to become looser, trapping water and organic matter in between the surfaces, again, creating perfect conditions for rot.

The other significant problem we faced was the rate at which the iron rivets rust and expand, creating cracks in the lands.



Fig. 2: Launch of *Roar Ege*, on August 25, 1984 (photography Bo Nielsen, Viking Ship Museum in Roskilde).

Table 1: Materials involved in the construction of *Roar Ege*’s hull.

| Component  | Material type | Quantity of timber material in m <sup>3</sup> | Quantity      |
|--|---------------|---|---------------|
| Keel and stems   | oak           | 6.11  |               |
| Planking material (radially split)                               | oak           | 14.62   |               |
| Planking material (tangentially split), keelson, stringers, deck | oak           | 19.73   |               |
| Frames and knees   | oak           | 11.22   |               |
| Treenails  | willow        | 1.05  |               |
| Mast and yard  | pine          | 1.48  |               |
| Rivets and roves   | iron          |   | 1,204 of each |
| Spikes   | iron          |   | 323           |
| Approx. m <sup>3</sup> timber in total                           |               | 54.21   |               |

*Roar Ege* was fastened using rivets and roves that were hand-forged from Siemens-Martin steel, produced using the open-hearth method in Daval, France (Andersen *et al.* 1997, p. 44). Siemens-Martin steel is a very homogeneous material, which, it could be argued, bears very little resemblance to the heterogeneous bog iron the majority of Viking Age ship's nails were produced from (Lyngstrøm 2008, p. 9). However, the decision to use Siemens-Martin steel was made by the steering committee on the basis of the limited archaeometallurgical analyses of Viking-age ship fastenings that were available at the time. Drawing heavily on Buchwald's analyses of iron finds from the Danish Iron and Viking Ages, the committee decided that Viking-age shipbuilders would have sought the best possible material to use when fastening their ships and that Siemens-Martin steel, with its low carbon content, would be a good match for this hypothetical material (Buchwald 2005; Andersen *et al.* 1997, p. 44).

### 3. THE BIOGRAPHY OF A SHIP RECONSTRUCTION: *Roar Ege*'S 'SERVICE BOOK'

The sequence of maintenance and repair that was carried out on *Roar Ege* since the launch in 1984 has been documented both in text and photos, and represents a unique data set in terms of the experimental archaeological reconstruction of ship-finds. Many archaeological finds are reconstructed in full-scale and used in a manner similar to that in which the original find was employed, but to have this kind of detailed documentation over a time period spanning more than three decades is quite rare, and therefore of some significance in terms of furthering our understanding of Viking-age shipbuilding and seafaring.

The many notes, database entries, photographs and sketches that constitute this documentation have been collated into what is now affectionately known around the Museum boatyard as *Roar Ege*'s 'Service Book'. The list below summarises the primary phases of repair that were carried out on the hull, during the period from 1984-2014:

- 1984-1994: Minor running repairs;
- 1995: Two boards repaired and several knees replaced due to rot;
- 1996: Repairs to treenails;
- 2003: Mast replaced due to rot; 7th and 8th strakes and the stringers and futtocks in both sides replaced due to presence of brown rot and soft rot; ten knees and one breasthook also replaced due to presence of white rot;
- 2004: Treenails replaced at frame stations 0, 1F and 1A;
- 2005: One beam knee replaced; cracked sheer strake repaired; after stem repaired after a collision at sea;
- 2008: Repairs to the rudder;
- 2009: Section of the port side 4th strake replaced;
- 2012: Sections of lead sheathing added to repair cracks in the garboards;
- 2013: New hood ends for the 4th and 6th strakes due to spread of white rot from the second step of the stem; general problems with leaks in the 2nd strake; treenails replaced in the port side middle stringer;
- 2014: 5th and 6th strakes replaced on both sides; six new *biti*, one beam and 17 new knees.

As outlined above, various forms of rot, and the cracks and subsequent leaks caused by the rusting and expansion of iron rivets, are the two main culprits for the manner in which the ship's hull has deteriorated. Table 2 outlines the quantities of materials which have been replaced in order to keep *Roar Ege* seaworthy.

The majority of the repairs were carried out in a manner adhering to the original principles of the project. Others, such

**Table 2:** Materials utilised in repair and maintenance of *Roar Ege*'s hull from 1984 to 2014.

| Component                              | Material    | Replaced during the period from 1984 - 2016 | Quantity involved in repair   | Total in m <sup>3</sup> (wooden components) |
|--|-------------|---|---|---|
| Fore stem                              | oak         | –   | –   | –   |
| After stem                             | oak         | –   | –   | –   |
| Keel                                   | oak         | –   | –   | –   |
| Planking material (radially split)     | oak         | yes   | Section of the 4th strake on both sides. 5th and 6th strakes on both sides. | 4.71  |
| Planking material (tangentially split) | oak         | yes   | 7th and 8th strakes on both sides   | 4.04  |
| Frames                                 | oak         | –   | –   | –   |
| Keelson                                | oak         | –   | –   | –   |
| Stringers x 4                          | oak         | yes   | 4   | 2.36  |
| <i>Biti</i>                            | oak         | yes   | 6 <i>biti</i> produced from leftover planking material                      | –   |
| Cross beams                            | oak         | yes   | 1 cross beam produced using leftover planking material                      | –   |
| Knees                                  | oak         | yes   | 23  | 0.58  |
| Treenails                              | goat willow | yes   | 162   | 0.69  |
| Deck                                   | oak         | yes   | Several boards replaced using leftover planking material                    | –   |
| Mast                                   | pine        | yes   | –   | 0.92  |
| Yard                                   | pine        | –   | –   | –   |
| Rudder                                 | oak         | –   | –   | –   |
| Rivets and roves                       | iron        | yes   | 620 of each   | –   |
| Spikes                                 | iron        | yes   | 92  | –   |
| <b>Cubic meters of timber in total</b> |             |   |   | <b>13.3</b>                                 |



as the addition of lead sheathing to stem leaks below the waterline in 2012, represent a modern compromise but also indicate that further sections of planking would have been replaced, had we adhered strictly to Viking-age boatbuilding methods. The material estimate presented above therefore represents a conservative total.

#### 4. THE RETIREMENT OF ROAR EGE

The last major repair of *Roar Ege* was undertaken in 2014. The 5th and 6th strakes were replaced, along with several of the internal hull components. It had been hoped that this repair would prolong *Roar Ege*'s sailing days by another decade, but this was not to be the case. Despite the endeavours of the boatbuilders, by the spring of 2016, the hull had deteriorated to such an extent that it was impossible to make the hull watertight without replacing even more planking. Such a repair was difficult to justify within the context of the archaeological experiment – it is difficult to imagine that Viking-age boatbuilders would have invested so much time and costly material in an aging ship.

After 32 years of active service, the decision was therefore made to retire *Roar Ege* (fig. 3).

#### 5. THE ARCHAEOLOGICAL EXPERIMENT CONTINUES ON LAND

Skuldelev 3 is estimated to have been between 20 to 30 years old when it was scuttled at the barrier at Peberrenden, a lifespan that tallies neatly with the 32 years *Roar Ege* had in active service (Crumlin-Pedersen, Olsen 2002, p. 333).

The ship had undergone several episodes of repair during its lifetime, where sections of the planking below the waterline were replaced (Crumlin-Pedersen, Olsen 2002, p. 230). What is immediately striking is the disparity between the repairs carried out on Skuldelev 3 and those on *Roar Ege*. The majority of the repairs on Skuldelev 3 are represented by short sections of planking, most likely remedying damage that occurred when taking the ship on land or when anchored up in harbour (fig. 4).

*Roar Ege* on the other hand, presents an opposing picture, where the majority of the repairs, apart from the sheathing



**Fig. 3:** *Roar Ege* was retired permanently on land in the spring of 2016 (photography Werner Karrasch, Viking Ship Museum in Roskilde).

added in 2012 and the general deterioration of the lands in 2016, have been located above the waterline. *Roar Ege*'s hull has also been much more extensively repaired than that of Skuldelev 3.

These issues raise many questions concerning the building and use of reconstructed ship-finds, and they are now the focus of ongoing research at the Museum.

#### 6. PRELIMINARY CONCLUSIONS, AND QUESTIONS FOR FUTURE RESEARCH

*Roar Ege*'s retirement in 2016 marked the end of the lifecycle of the first full-scale, sailing reconstruction of the five Skuldelev ships. However, *Roar Ege*'s contribution to maritime experimental archaeological research is far from over. The collation of *Roar Ege*'s 'Service Book' is the first step in the research programme of a new reconstruction project at the Viking Ship Museum's boatyard – 'Skuldelev 3 Revisited' – which began in 2017 with a reinterpretation of the original ship-find and the commencement of a new full-scale reconstruction.

The data represented in *Roar Ege*'s hull, and in the documentation of the many repairs conducted over the years, is now the subject of further study, as we seek to extract as much information as we can concerning the materials and resources required in sailing and maintaining Viking Age ships.

However, some preliminary conclusions can already be drawn:

- Life span of the hull: *Roar Ege* was retired after 32 years and would appear to have had approximately the same life span as Skuldelev 3, however, *Roar Ege*'s hull displays far more wear and tear than that of Skuldelev 3. The potential reasons for this are still under investigation;

- Life span of the sail: *Roar Ege* was initially equipped with a linen pilot sail which was then replaced by a wool sail 1985, handwoven by a team of weavers at Fosen Folkehøjskole in Norway, under the direction of Solfrid Aune, Yngvild Andersen and Kirsti Godal (Andersen *et al.* 1997, p. 213). This sail has also had minor running repairs over the years but is otherwise still in perfect condition. The sail has therefore outlived the ship. The sail is currently in storage and we plan to continue using the same sail on the new reconstruction of Skuldelev 3, which we aim to launch in 2021, allowing us to continue monitoring the life span of the sail and see this aspect of the archaeological experiment through;

- Material use: a total of *circa* 54.21 m<sup>3</sup> of timber were utilised in constructing *Roar Ege*'s hull. A further 13.3 m<sup>3</sup> were required to maintain the hull over a 30-year period. These totals can now be used to explore issues concerning the control and management of raw materials for shipbuilding in the Viking Age.

The disparity between the level of repair as evidenced in the remains of Skuldelev 3 and in the work carried out in *Roar Ege* will continue to be the focus of research at the Museum boatyard for some time to come. It raises a great many questions, of which the following are just a sample;

- Would iron fastenings produced from bog iron have greater resistance to corrosion, reducing the frequency of the need for replacement of planking? It is hoped that we can build small tender for Skuldelev 3 in 2021, and that this boat will be entirely fastened with rivets and roves of bog iron, allowing us to explore this issue more fully;



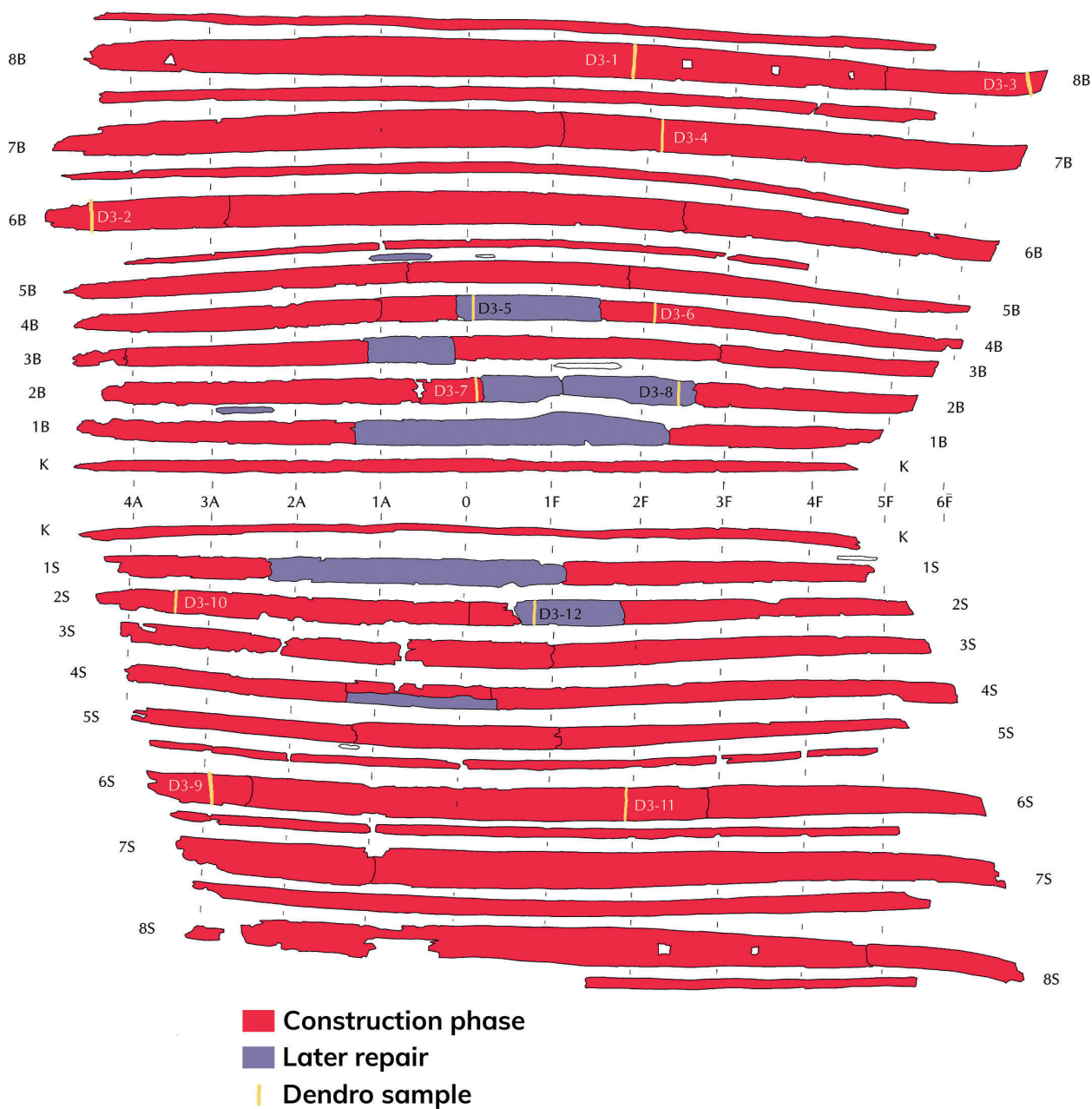


Fig. 4: The planking of Skuldelev 3 with indication of repairs marked in purple (after Crumlin-Pedersen, Olsen 2002, p. 230, fig. 41).

– The oak we use today to build our reconstructions is faster growing than oak in the Viking Age; does this make it more susceptible to rot? And what impact does the surface treatment of the hull with tar have on the ship's life span?

– Our ships lie moored in the harbour, while Skuldelev 3's keel shows evidence of wear and tear due to being dragged on land; would the hull's rate of deterioration been different had it spent more time out of water? Should the new Skuldelev 3 reconstruction be handled differently?

Some of these issues can be addressed promptly while others will require more long-term experimental archaeological analysis, underlining once again the vital importance of the role cross-disciplinary collaboration plays in this field of research. *Roar Ege* was built on a foundation of the shared expertise of maritime archaeologists, craft specialists and sailors. Concluding the research aspects of the *Roar Ege* project will also require the skills and knowledge of each of these groups, ensuring the continuation and development of maritime experimental archaeological practice at the Viking Ship Museum.

## REFERENCES

- ANDERSEN E., CRUMLIN-PEDERSEN O., VADSTRUP S., VINNER M.  
1997 *Roar Ege: Skuldelev 3 skibet som arkæologisk eksperiment*, Roskilde, Vikingskibshallen.
- BUCHWALD V. F.  
2005 *Iron and Steel in ancient times*. København, Det Kongelige Danske Videnskabernes Selskab, Historiske-filosofiske Skrifter 29.
- CRUMLIN-PEDERSEN O.  
1986a The 'Roar' Project, in O. Crumlin-Pedersen, M. Vinner (eds), *Sailing into the Past. Proceedings of the International Seminar on Replicas of Ancient and Medieval Vessels, Roskilde 1984*, Roskilde, Viking Ship Museum in Roskilde, p. 94-103.  
1986b Aspects of Viking-Age Ship-Building in the Light of the Construction and Trials of the Skuldelev Ship-Replicas *Saga Siglar and Roar Ege*, *Journal of Danish Archaeology* 5, p. 209-228.
- CRUMLIN-PEDERSEN O., OLSEN O.  
2002 *The Skuldelev Ships I*, Roskilde, Viking Ship Museum in Roskilde, Ships and Boats of the North 4.1.
- LYNGSTRØM H.  
2008 *Dansk jern. En kulturhistorisk analyse af fremstilling, fordeling og forbrug*, København, Det Kongelige Nordiske Oldskriftselskab Nordiske Fortidsminder Serie 3.5.



# THE 5<sup>TH</sup>-CENTURY AD RIVERINE BOAT OF SANTA MARIA IN PADOVETERE: 3D RECONSTRUCTION OF ITS SHAPE AND CONTEXT

Elisa COSTA and Carlo BELTRAME

---

## Abstract

The digital survey of a 5<sup>th</sup> century AD riverine boat, together with direct measurements and drawings, has led to a complete 3D model of the boat, with deformations corrected, hull lines reconstructed and missing parts recreated. The different construction solutions of this boat (sewing, mortise-and-tenon joints, clinker planks) have been represented in a detailed 1:1 scale for improved study and display. The discovery of this boat in a tributary of the Po River has allowed for some considerations about the environment in which the boat was built, and about riverine navigation in the Po Valley in late antiquity.

## Keywords

Digital survey, Late Roman Period, 3D modelling, sewn boat

## Résumé

Le relevé numérique, les mesures directes et les dessins d'un chaland fluvial du v<sup>e</sup> siècle apr. J.-C. ont conduit à la réalisation d'un modèle 3D complet de ce bateau. Ce modèle permet de corriger les déformations, de restituer le plan de forme et les pièces manquantes de la coque. Les différentes techniques de construction de cette embarcation (couture, tenons et mortaises, planches assemblées à clin) ont été représentées de manière très détaillée à l'échelle, afin de permettre une étude et une présentation précises. La découverte de l'épave dans un affluent du Pô a aussi porté à une réflexion sur l'espace nautique spécifique dans lequel le navire a été construit ainsi que sur la navigation fluviale dans la plaine padane à la fin de l'Antiquité.

## Mots clés

Relevé numérique, Antiquité tardive, modélisation 3D, bateau cousu

---

Digital survey techniques are well established in the field of nautical archaeology for the documentation of wooden ship and boat remains. Multi-image photogrammetry, laser scanning, and video and photograph recording contribute to the elaboration of virtual 3D models that facilitate precise studies of ancient ship construction (Jones *et al.* 2013; Zhukovsky *et al.* 2013; Pulak *et al.* 2014, p. 43-45; Dumas *et al.* 2015; Costa *et al.* 2016; Yamafune *et al.* 2016). Three-dimensional surveys of boats are powerful tools for virtually preserving and protecting the archaeological source, but also for obtaining a 3D reconstruction of the original shape of a boat. In this way, we gain a complete visualisation of the hull, which can be employed for better understanding of the construction technique and hull lines, as well as calculations regarding the hydrostatics and stability of the ship (Poveda 2015, 2017; Tanner 2018; Tanner *et al.* 2020).

The aim of the research was the realisation of a virtual model of the boat of Santa Maria in Padovetere and the environment in which the boat was built and navigated. The remains of the hull were well preserved and included important elements for the identification of the shape: the bottom and the stern to provide the longitudinal shape of the vessel; and the complete starboard side and the frames to provide the shape of the hull in cross section.

## 1. THE SITE AND THE SHIPWRECK

The boat of Santa Maria in Padovetere was investigated in 2014 and 2015, during two seasons of excavations organised by

the Soprintendenza per i Beni Archeologici dell'Emilia Romagna in collaboration with Ca' Foscari University (Beltrame, Costa 2016, p. 253-255). The site is 4.5 km west of the city of Comacchio, in Ferrara province, on the plain of the Po Delta that was reclaimed in the 1950s (Balista *et al.* 2007, p. 19).

The boat was located a few metres south of a chapel dated to the 6<sup>th</sup> century AD, on the northern bank of an ancient river. It was conserved in a thick layer of sand and clay and lays on the starboard side with the flat bottom at roughly 40° to vertical (fig. 1, right). At the end of the excavation, the boat was left *in situ* and reburied.

The 'end of life' of the boat can be dated both by artefacts found within a thick layer of flood sediments covering and in direct contact with the hull, and by the radiocarbon dating of a piece of rope from the hull, providing a *terminus ante quem* in the second half of the 5<sup>th</sup> century AD.

We suspect it sank during a heavy flood that may have ripped the barge from its moorings, but since it lays on a riverbank and the majority of the inner planking was not conserved, we cannot exclude the possibility that it was simply abandoned (Beltrame, Costa 2016, p. 265).

The parts at a lower level (starboard side, stern and part of the bottom) were found in a layer of clay in which anoxic conditions guaranteed perfect preservation of the wood. The portion in the upper level was found in a sandy layer that had compromised and damaged the wood. The deterioration of the upper parts suggests a less rapid covering, which left the wood exposed. Probably, the water level reached the height of the port profile of the bottom, causing the total disappearance of the emerged side, even though



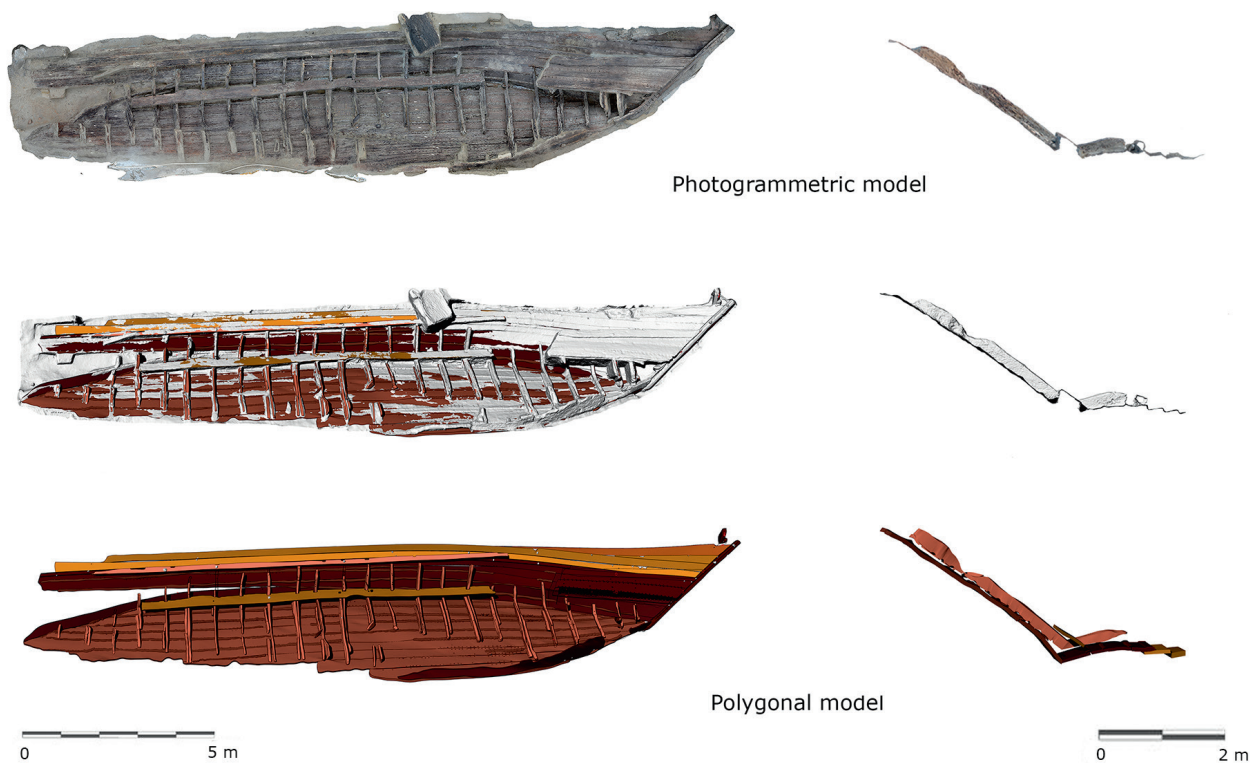


Fig. 1: The development from photogrammetry to polygonal model; on the left, the plan; on the right, the section at frame 11 (E. Costa).

the possibility of an impact from agricultural activity in the following centuries must also be taken into consideration.

The hull measures a maximum of  $17 \times 2.9$  m and the preserved complete starboard side is 1.45 m in height at midships. It is a typical flat-bottom riverine boat with a box-shaped section. The main assembly system used by the shipwright is the sewn technique on a bottom-based construction system. In this technique, the planks are sewn together by running stitches (while the frames are joined to the planking by wooden pegs) and the sewing holds vegetal wadding placed over the seams prior to sewing. This technique was widespread in the area delimited by the coasts and the inland waters of the northern Adriatic where it was the most commonly used technique for the construction of inland boats in the Roman and probably Late Roman Periods (Beltrame 2002; Beltrame, Gaddi 2013; Pomey, Boetto 2019, p. 12-16).

A very original aspect of this boat is the use not only of the sewing technique but also of two other techniques for joining the planking to the sides: mortise-and-tenon joints and a sort of very unusual, at least for the Mediterranean, overlapping of planks (clinker) with iron nails every 1 metre.

## 2. DIGITAL TECHNIQUES

### 2.1. THE SURVEY AND THE 3D MODEL OF THE HULL *IN SITU*

After the production of a digital model of the hull using automatic photogrammetry, integrated with total station surveying

and laser scanning, the first phase of the data elaboration of the virtual model was the realisation of orthophotos in order to develop plans and sections, necessary resources in archaeological interpretation (Costa *et al.* 2016). We then pursued the research with 3D reconstitutions of every single wooden element, and we have reconstructed a virtual textured model perfectly matching the real object.

The polygonal modelling of the boat does not replace the virtual model obtained through the photogrammetry survey, since the two models represent two different types of visualisation: the photogrammetry model is a realistic copy of the subject, with millimetric accuracy and the exact chromaticity of the subject, while the reconstructed model is intentionally schematic to facilitate the operations of reconstruction and the interpretation of the hull shape and structure. In Figure 1, the development from photogrammetry to polygonal model is shown.

The photogrammetry model represents the boat *in situ* with the sediments preventing the collapse of the frames, whereas modelling and reconstruction can highlight hidden elements, make the non-visible parts of the boat accessible, and eliminate details such as cracks in or degradation of the wood. For complete documentation, the boat should be dismantled, but this was not possible without a programme of recovery and restoration (fig. 1).

### 2.2. THE MODELLING AND THE RECONSTRUCTION OF THE HULL

The realisation of the virtual model of a complete side (starboard) and a complete end (stern) led to the reconstruction of

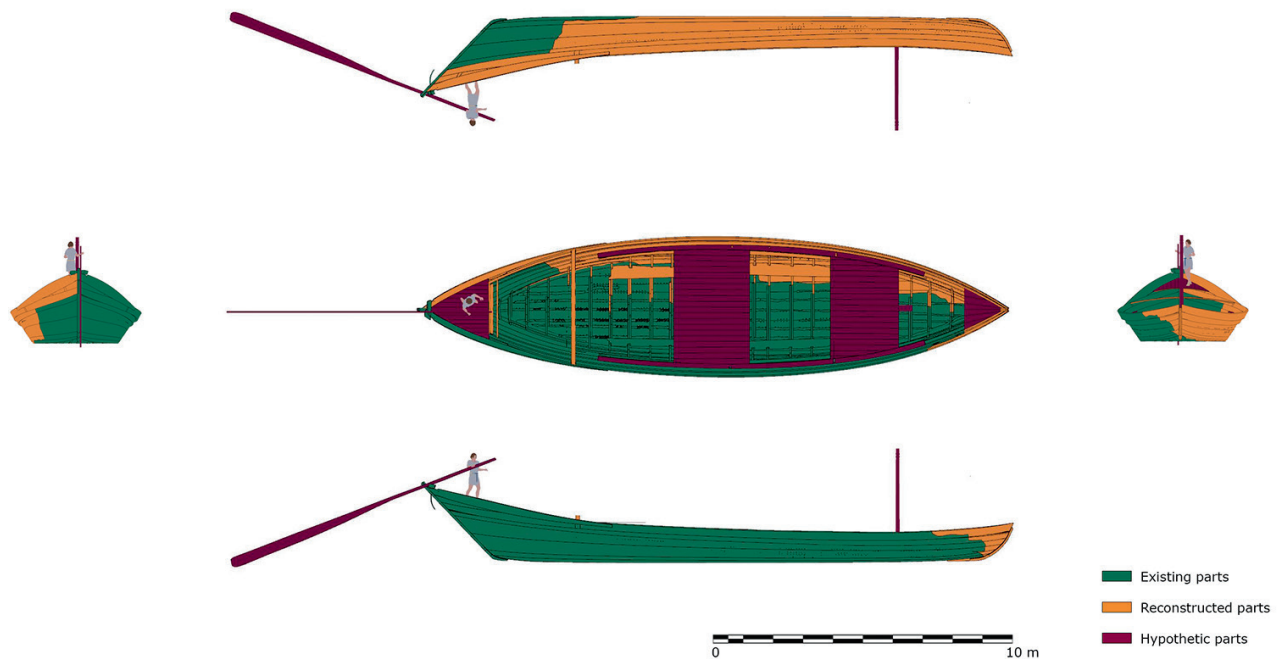


Fig. 2: Model of the existing parts (green), reconstructed parts (yellow), and hypothetical parts (violet) (E. Costa).

the original shape of the boat and the hull lines through the correction of the distortions of the shape (Jones *et al.* 2013, p. 124-125; Poveda 2017, p. 30-31; Tanner 2018, p. 143-144).

The first operation to reconstruct the original hull shapes was the rotation of the hull to the navigation position. Once this operation was completed, the deformation of the bottom planks, longitudinally and transversally, was evident, showing how these were eased down on the bank, losing their original structure. It was necessary to develop and extend the planks to reconstruct the correct shape of the bottom along the horizontal axis without dimensional variations (Ravn 2012, p. 316). The distorted planks of the right side had to be bent, rotated and twisted without modifying the real measurements of the plank. At the stern and the stem, it was not possible to join the first plank of the side with the bottom without bending the bottom itself to connect to the side in a raised position, with a lift of 22 cm at the stem and 12 cm at the stern, acquiring a plausible curvature for correct hydrodynamic functioning. The existing frames were used to evaluate the degree of deformation of the planks due to post-depositional factors, and they were reconstructed, eliminating the deformations, modelling where necessary, and integrating the terminal part of the bottom portion based on the symmetrical twin frame.

An important modelling phase concerned those elements whose shapes and dimensions could be reconstructed on the basis of clear signs of their existence in the hull, such as the stem, the beams and the deck planks. In contrast, other elements, such as the rudder or the bow mast, are hypotheses based on archaeological and ethnographical comparisons (fig. 2) (Casson 1995, p. 329, 336-337; Boetto 2008, p. 46-47; Marlier, Poveda 2014, p. 209, 214-215).

The side planks near the stem were deteriorated and did not run the total length. In order to determine the shape of the stem, the lines of the side were automatically extended following the

curvature until reaching a vertical plane passing through the central axis of the hull. The lines thus generated were the most probable because they were created along a very small missing portion (1-2 m) in respect to the length of the entire plank (18-20 m), for which we know the correct curvature.

A series of transversal beams were reconstructed on rectangular notches cut at regular distances on the shelf clamp; they were slightly inclined, following the line of the rectangular cuts and the curvature as confirmed by ethnographical comparison. The beams were used as support for the deck planks and the presence of a separated deck in three parts was hypothesised, corresponding to transversal elements positioned at a distance that would permit walking on the deck planks without breaking them.

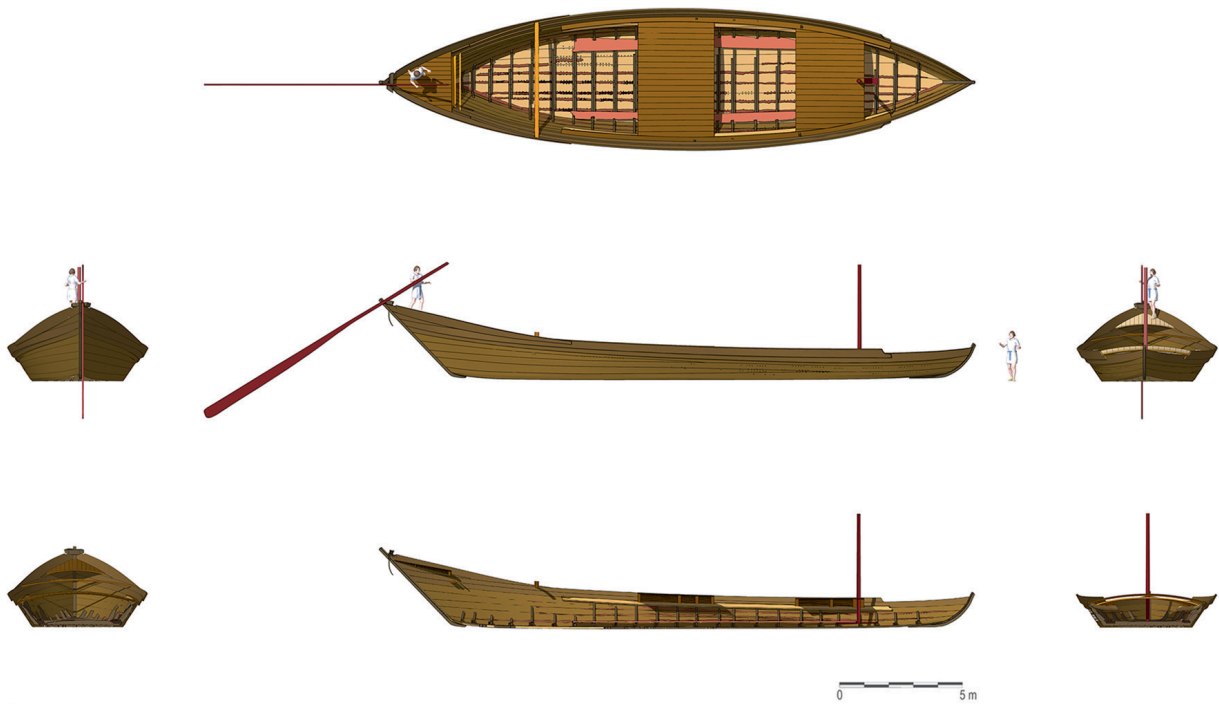
### 2.3. CONSIDERATION OF THE SHAPE AND THE PROPULSION OF THE BOAT

By redressing the deformation of the wooden structure, the reconstruction of the boat has allowed improved observations of construction aspects, and a hypothesis as to its length being around 23 m, maximum width of 5 m, and height of 1 m in the middle section and 2.20 m at the stern (fig. 3).

This is one of the few boats used only for inland navigation during the Late Roman Period in southern Europe for which the almost complete shape is known (Rieth, Guyon 2010; Marlier 2014).

Its use as a river transport boat is indicated by the flat bottom and by the absence of evidence both of a closed deck and a sail mast. We do not have any archaeological information regarding the propulsion of the boat, but we can consider the words of Latin authors who mention towing (Gaius Valgius Rufus, *fr.* 4) and oars (Martial, *Epigrammaton libri*, III, 67, 1-4) when describing

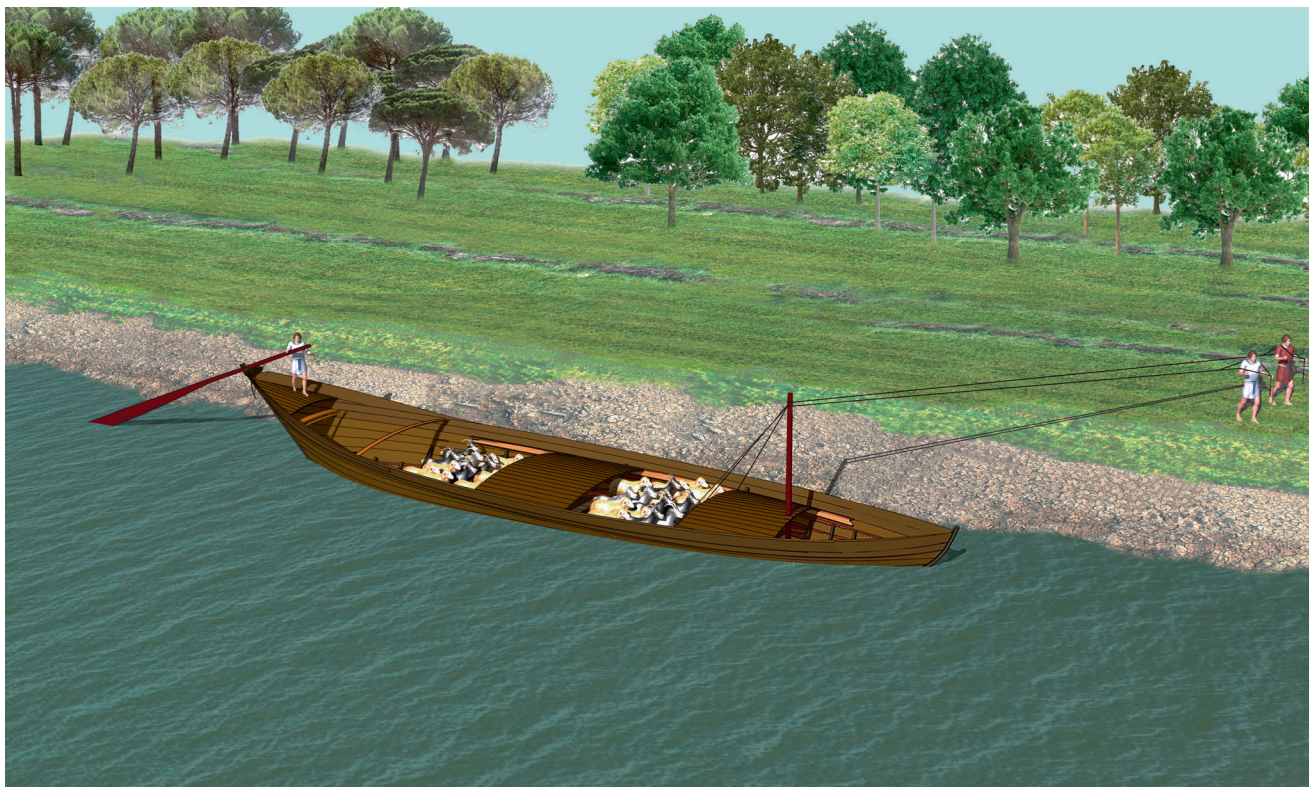




**Fig. 3:** Reconstructed plan, profiles and sections of the boat (E. Costa).

navigation along the waterways of this area. The width of the last beam toward the stem, that measures 40 cm instead 10 cm as the others beams, and some comparisons (Boetto 2008, p. 46-47; Marlier, Poveda 2014, p. 209), let us suppose the presence of a small mast to tow the boat from the riverbank.

The high sternpost invites comparisons with iconographic images from Central Europe, dated to the Roman Period (Beltrame, Costa 2016, p. 12). This end and the rise of the sides at this part, which could be suited to providing a clear view and good control of a long central steering oar, might suggest the



**Fig. 4:** Reconstruction of the boat with hypothetical cargo and of the environment (E. Costa).

presence of a helmsman in this area. The shape of the steering oar has been reconstructed from detail on a relief on the base of the statue of Tiber held in the Louvre and through comparisons with the steering oar of Arles-Rhône 3 (Casson 1995, p. 329, 336-337; Marlier, Poveda 2014, p. 214-215).

Long central single rudders were employed on different types of flat-bottomed boats along the rivers of Central Europe in the 18<sup>th</sup> century and until the beginning of the 20<sup>th</sup> century (Beaudouin, 1985, p. 73; Ossowski 2010, p. 138). Such comparisons suggest that the long pin passing through the stern and the L-shaped element on the deck might be connected to the helmsman's post, although the question of the use of the central pin is still open.

### 3. THE RECONSTRUCTION OF THE ENVIRONMENT AND THE TRANSPORTED CARGO

Matter collected in the bilge of the wreck and deposited during the use of the barge, such as pollen, plant remains and some remains of the transported cargoes, can assist in the reconstruction of the environment where the boat navigated. The landscape of the plain has been identified as a patchwork of open areas, deciduous mesophilic mixed woods (*Quercus*, *Ulmus*, *Carpinus*, *Corylus*, *Fraxinus* and *Acer*) and some stands of Mediterranean evergreen oak (*Quercus ilex*). The rare presence of pollen from *Pinus pinea* could be the first direct evidence of Roman cultivation of this species on the Adriatic coast of Emilia Romagna. The predominance of wild riparian wood pollen taxa (*Alnus*, *Populus*, *Salix* and *Sambucus nigra* type) and pollen grains of hygrophytes suggests a freshwater environment. The relatively high and unusual pollen percentage

of the dry meadow plant *Sanguisorba minor* and the co-occurrence of some other meadow species could be related to the use of the barge for the transportation of animals and their forage. The presence of spores produced by fungi that grow in dung supports the same hypothesis (Marlier 2014, p. 277; Beltrame *et al.* 2019, p. 3, 14-15) (fig. 4).

### 4. CONCLUSIONS

The anoxic conditions of the archaeological deposit have provided rare evidence of a flat-bottomed barge of the mid-5<sup>th</sup> century AD that can tell us much about ship construction and navigation along the rivers and canals of the Po Delta.

The digital survey of the hull documented *in situ* and the possibility of employing digital modelling techniques allowed us to study and analyse a particular type of boat and to reconstruct the complete shape of the hull with a high percentage of reliability, due to the fortunate conservation conditions of the shipwreck. The important contribution of geomatic techniques was crucial for the virtual modelling of the existing parts, since the excavation data was difficult to exploit due to the deformation of wooden elements, and for the reconstruction of the hypothesised elements.

Our experience serves to emphasise that the correct approach to 3D documentation of cultural heritage is to employ and integrate multiple sensors and technologies (photogrammetry, laser scanning, modelling, computer graphics, etc.), taking advantage of the intrinsic potentials of each technique. The effectiveness of these new procedures confirms digital technologies as an important and essential tool for the documentation, study and visualisation of nautical cultural heritage: this is a tool that seems to improve as research advances.

### REFERENCES

- BALISTA C., BONFATTI L., CALZOLARI M.  
2007 Il paesaggio naturale e antropico delle Valli tra Spina e Comacchio e le sue trasformazioni dall'Età etrusca all'Alto Medioevo, in F. Berti, M. Bollini, S. Gelichi, J. Ortalli (eds), *Genti del delta da Spina a Comacchio. Uomini, territorio e culto dall'antichità all'alto Medioevo*, Comacchio (Fe), Corbo editore, p. 19-32.
- BEAUDOUIN F.  
1985 *Bateaux des fleuves de France*, Douarnenez, éditions de l'estran.
- BELTRAME C.  
2002 Le *sutiles naves* romane lungo il litorale alto Adriatico. Nuove testimonianze e considerazioni tecnologiche, *Archeologia subacquea, studi, ricerche e documenti* 3, p. 353-379.
- BELTRAME C., GADDI D.  
2013 Fragments of Boats from the Canale Anfora of Aquileia, Italy, and Comparison of Sewn-Plank Ships in the Roman Era, *IJNA* 42.2, p. 296-304.
- BELTRAME C., COSTA E.  
2016 A 5<sup>th</sup>-Century-AD Sewn-Plank River Barge at St Maria in Padovetere (Comacchio, FE), Italy: an interim report, *IJNA* 45.2, p. 253-266.
- BELTRAME C., MOZZI P., FORTI A., MARITAN M., RUCCO A. A., VAVASORI A., MIOLA A.  
2019 The Fifth-Century AD Riverine Barge of Santa Maria in Padovetere (Ferrara, Italy): A Multidisciplinary Approach to its Environment and Shipbuilding Techniques, *Environmental Archaeology*, p. 1-22 (DOI: 10.1080/14614103.2019.1586084).
- BOETTO G.  
2008 L'épave de l'Antiquité tardive Fiumicino I: analyse de la structure et étude fonctionnelle, *Archaeonautica* 15, p. 29-62.
- CASSON L.  
1995 *Ships and Seamanship in the Ancient World*, Baltimore-London, Johns Hopkins University Press (2nd edition).
- COSTA E., BALLETTI C., BELTRAME C., GUERRA F., VERNIER P.  
2016 Digital Survey Techniques for the Documentation of Wooden Shipwrecks, *The International Archives of the Photogrammetry, Remote Sensing and Spatial Information Sciences* XLI-B5, p. 237-242.
- DUMAS V., GROSCAUX PH., BOETTO G.  
2015 Application de la photogrammétrie en archéologie navale, in C. Cerino, M. L'Hour, E. Rieth (eds), *Les nouveaux enjeux de*



*l'archéologie sous-marine, Revue d'Histoire Maritime* 21/2, p. 127-156.

JONES T., NAYLING N., TANNER P.

2013 Digitally reconstructing the Newport Medieval Ship: 3D designs and dynamic visualisations for recreating the original hull form, loading factors, displacement, and sailing characteristics, in C. Breen, W. Forsythe (eds), *ACUA Underwater Archaeology Proceedings*, Columbus, Ohio, Advisory Council on Underwater Archaeology, p. 123-130.

MARLIER S. (Ed)

2014 Arles-Rhône 3, *un chaland gallo-romain du I<sup>er</sup> siècle après Jésus-Christ*, Paris, CNRS Editions, *Archeonautica* 18.

MARLIER S., POVEDA P.

2014 Présentation et analyse du système mécanique, in S. Marlier (ed.), *Arles-Rhône 3, un chaland gallo-romain du I<sup>er</sup> siècle après Jésus-Christ*, Paris, CNRS Editions, *Archeonautica* 18, p. 209-216.

OSSOWSKI W.

2010 *Przemiany w szkutnictwie rzeczonym w Polsce*, Gdansk, Centralne Muzeum Morskie w Gdansku.

POMEY P., BOETTO G.

2019 Ancient Mediterranean Sewn-Boat Traditions, *IJNA* 48.1, p. 5-51.

POVEDA P.

2015 Méthode de restitution des navires antiques: nouveaux outils et nouvelles méthodes des restitutions en archéologie navale, in C. Cerino, M. L'Hour, E. Rieth (eds), *Les nouveaux enjeux de l'archéologie sous-marine, Revue d'Histoire Maritime* 21/2, p. 157-180.

2017 Les modèles tridimensionnels de l'épave *Dramont E*. Hydrostatique et réalité virtuelle au service de la restitution en archéologie navale, *Archeonautica* 19, p. 27-40.

PULAK C., INGRAM R., JONES M.

2014 Eight Byzantine Shipwrecks from the Theodosian Harbour Excavations at Yenikapı in Istanbul, Turkey: an Introduction, *IJNA* 44 .1, p. 39-73.

RAVN M.

2012 Recent Advances in Post-Excavation Documentation: Roskilde Method, in N. Günsenin (ed.), *Between Continents, Proceedings of the Twelfth International Symposium on Boat and Ship Archaeology (ISBSA 12), Istanbul 2009*, Istanbul, Yayinlari, p. 313-317.

RIETH E., GUYON M.

2010 Les épaves gallo-romaines, in E. Rieth (ed.), *Les épaves de Saint-Georges Lyon – I<sup>er</sup> – XVIII<sup>e</sup> siècles*, Paris, CNRS Editions, *Archeonautica* 16, p. 35-100.

TANNER P.

2018 The testing and analysis of hypothetical ship reconstruction, in J. Litwin (ed.), *Baltic and Beyond. Continuity and change in shipbuilding, Proceedings of the Fourteenth International Symposium on Boat and Ship Archaeology (ISBSA 14), Gdansk 2015*, Gdansk, National Maritime Museum, p. 143-150.

TANNER P., WHITEWRIGHT J., STARTIN J.

2020 The Digital Reconstruction of the Sutton Hoo ship, *IJNA* 49.1, p. 5-28.

YAMAFUNE K., TORRES R., CASTRO F.

2016 Multi-image Photogrammetry to Record and Reconstruct Underwater Shipwrecks, *Journal of Archaeological Method and Theory* 23.1 (DOI 10.1007/s10816-016-9283-1).

ZHUKOVSKY M. O., KUZNETSOV V. D., OLKHOVSKY S. V.

2013 Photogrammetric techniques for 3-d underwater record of the antique time ship from Phanagoria, *The International Archives of the Photogrammetry, Remote Sensing and Spatial Information Sciences XI-5/w2*, p. 717-721.

# AN ATTEMPT TO CREATE A DIGITAL RECONSTRUCTION OF THE PUCK 2 WRECK HULL

Paweł LITWINIENKO and Janusz RÓŻYCKI

---

## Abstract

This paper focuses on the process of documentation and digital reconstruction of the Puck 2 wreck, salvaged in 2005 from an early medieval harbour in the Puck Lagoon, northern Poland. After PEG treatment the wreck timbers were digitally documented according to the methodology developed during the Newport ship project. The individual timbers were then assembled using Rhinoceros software into a virtual model of the wreck as found, which served as a base for the attempted reconstruction of the ship's hull and its hydrostatic characteristics.

## Keywords

Digital reconstruction, early medieval era, hydrostatic analysis, 3D laser scanning

## Résumé

Cet article est centré sur le processus de documentation et de restitution numérique de l'épave Puck 2, récupérée en 2005 dans un port médiéval de la lagune de Puck, au nord de la Pologne. Après le traitement au PEG, les bois de l'épave ont été documentés numériquement selon la méthodologie développée lors de la découverte du navire de Newport. Chaque élément de la structure a ensuite été assemblé à l'aide du logiciel Rhinoceros pour créer un modèle virtuel de l'épave, qui a servi de base à la tentative de restitution de la coque du navire et à l'évaluation de ses caractéristiques hydrostatiques.

## Mots clés

Restitution numérique, Haut Moyen-Age, analyse hydrostatique, numérisation laser 3D

---

The Puck 2 wreck was discovered in 1979 during archaeological excavations conducted in the medieval harbour of Puck. The site was discovered in 1977 by a group of amateur divers. The first excavations were supervised by Wiesław Stępień from the Puck Regional Museum. The site was identified as the remains of an early medieval harbour dated from the 9<sup>th</sup>-13<sup>th</sup> century AD, extending over an area of nearly 12 ha. It contained harbour constructions, numerous artefacts and several wrecks. In 1990-2006 archaeological works were conducted by the National (then Central) Maritime Museum in Gdańsk and the University of Nicolaus Copernicus in Toruń. The archaeological teams were able to record the surface features of 6 ha, open several test trenches and excavate the discovered wrecks. Until now five wrecks (a logboat and four lapstrake vessels) have been found in Puck medieval harbour. The first wreck (P1) is lying on the eastern side of the site. It was documented in 1983 and is still *in situ*, having been secured with geotextile. The 1983 recording revealed that it is a wreck of a lapstrake vessel built in the clinker tradition, assembled with iron rivets and caulked with animal hair. According to Stępień, the aft part of the wreck has been uncovered, revealing the stem, framing system and traces of repairs caulked with textiles, which was <sup>14</sup>C dated to 1245 AD (Stępień 1998, p. 45). Dendrochronology performed in later years yielded different results: the boat was probably built after 1380 (Ważny 2013, p. 47). The next wreck (P3) lay in the western part of the documented area. It was partially uncovered and documented in 1983 (Stępień 1998, p. 47). In 1990, when the National Maritime Museum in Gdańsk resumed exploration of the site, the wreck was fully excavated, documented and salvaged (Pomian, Litwin 2009, p. 423). In 2018, after conservation it was reassembled in the museum's Shipwreck Conservation Centre in Tczew. The P3 wreck

consists of an 8.3 m-long keel, fore stem, floor timbers, a few thwart and planking assembled with wooden pegs and caulked with moss. The width of the longest beam (2.8 m) and the overall proportions of the vessel indicate that it was a small cargo carrier. The wreck has been dendrochronologically dated to after 1155 AD (Ossowski, Krąpiec 2003, p. 271-292). During the preparations for salvage of P3, another wreck (P5) was found. It was lying just 0.5 m from the bow of P3, buried deeper into the seabed. It was partially uncovered, revealing the remains of a large lapstrake vessel assembled with wooden pegs and caulked with moss. The planking was well preserved and yielded very precise dendrochronological dates, fixing the felling of the trees to 1248 AD (Litwin 1995, p. 142). It was decided to leave the wreck *in situ* and secure it by burying it under the sediment. Interestingly, the P3 and P5 wrecks were filled and surrounded by many loose wood shavings, which may suggest that they were ready for repair works (Pomian, Litwin 2009, p. 423).

## 1. THE P2 WRECK: EXPLORATION AND SALVAGE

The P2 wreck lay in the central part of the archaeological site. It was situated on what appears to be a submerged early medieval coastline reinforced with fascine (Pomian 2002, p. 131). Traces of burning on the keelson, remains of flax inside the hull and the fact that the wreck was attached to the seabed with wooden posts may indicate that the vessel had been partially submerged and used for soaking flax (Pomian, Litwin 2009, p. 423). The wreck was first found, explored and published by Wiesław Stępień, who was unable to complete his research (Stępień 1987). He managed to identify several

construction features of the vessel and to take samples for <sup>14</sup>C dating (555 AD, and later 810 AD), which turned out to be controversial (Pomian, Litwin 2009, p. 422). However, Stępień was able to provide the first reconstruction of the vessel (Stępień 1998).

Exploration of the P2 wreck was resumed in 2003 and 2005 by a National Maritime Museum team led by Iwona Pomian, head of the Underwater Archaeology Department. Prior to these latest explorations, in 1999 samples for dendrochronological analysis were taken from the planking. The results placed the vessel in the first half of the 10<sup>th</sup> century (Ważny 2001). The wreck was excavated and documented underwater in 2005 by preparing drawings as well as photo and video recording. It was decided to raise the wreck by dismantling it underwater into individual timbers, which were then transported to the conservation workshop, documented in 1:1 scale and treated with PEG (Pomian, Litwin 2009, p. 424). Several planks and structural timbers were in very bad condition and they disintegrated into small pieces, hence the total number of salvaged construction elements rose to 195.

The wreck as found can be described as the remains of the forward half of a long, narrow vessel. It consists of an almost 12 m-long keel with bow extension and a keelson with a mast step. Stems are missing, and the keel is torn off at approximately two thirds of its original length. Seven strakes of the starboard and four of portside planking are preserved, assembled with wooden pegs and caulked with animal hair. The hull has been stiffened with a framing system consisting of partially preserved floor timbers, thwarts with stanchions and knees. The hull was longitudinally strengthened by stringers preserved in six fragments.

## 2. THE POST-CONSERVATION 3D DOCUMENTATION

In 2012 the Underwater Archaeology Department of the National Maritime Museum in Gdańsk was equipped with a FARO ScanArm for the purpose of digital recording shipwreck timbers. The first documentation project carried out in the museum was the recording of timbers from the Copper Wreck in 2013 as part of an attempt to create a digital reconstruction of the hull. All 189 timbers from the Copper Wreck were documented using laser scanning producing point clouds, which were then processed into surface models. The acquired models were processed, simplified and assembled in order to recreate the shape of the hull, and then used for hydrostatic calculations performed by experts from Gdańsk University of Technology (Żrodowski 2014).

In 2016 the current authors began the documentation of timbers from the P2 wreck in hope of achieving similar results. It was decided to supplement the point cloud models achieved by laser scanning with three-dimensional wireframe drawings made in Rhinoceros 3D software, according to the methodology developed during the Hjortspring boat (Hocker 2003) and the Newport ship projects (Jones 2011). On such drawings each timber is seen as a set of faces documented one at a time, and the data on all features of the given element has to be collected manually by the documentation device operator. Both methods supplement each other: laser scanning allows the recording of every feature of the object's surface,

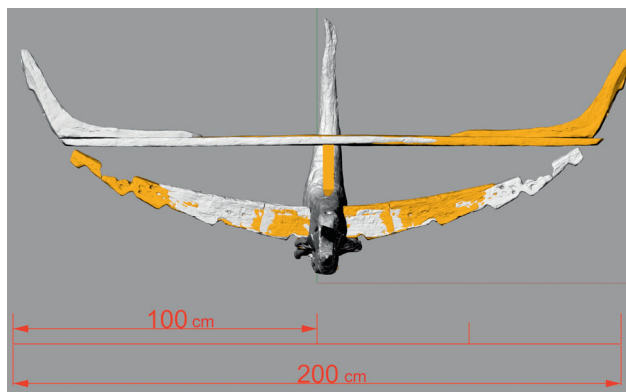


Fig. 1: Frame No. 10 of the P2 wreck with reconstructed elements in yellow (J. Różycki, P. Litwinienko).

though the post-processing stage is very time consuming; the contact method is more rapid, but also less accurate, and the outcome is more human-dependent (Jones 2011, p. 115). During recording it became clear that the documentation of long and thin planks is very troublesome with laser scanning as the object tends to bend after being turned around. Therefore laser scanning is more suitable for more robust objects like framing, whereas the contact method works well with planking. Overall, 161 construction elements of the P2 wreck were recorded: all of them with the contact method, and 102 with the optical method. Among these were the keel with bow extension and the keelson, 37 fragments of floor timbers, eight fragments of stringers, ten knees, 12 thwarts, 88 fragments of planking including over 3 m-long planks, as well as small chunks and eight other elements, such as stanchions, rowlocks and pieces of shield rack. The few dozens of smallest pieces of wood of unidentified function were excluded from digital recording and only documented photographically.

## 3. MODEL ASSEMBLY AND DESCRIPTION OF THE WRECK

After recording all structural elements, the processes of assembling the model could be started. The chosen environment was the Rhinoceros 3D 5.0 software. The software provides useful tools for importing different types of 3D objects, their post-processing, scaling, transformation, rotation, etc. The first stage was to digitise the *in situ* drawings, which served as the basis for the location of the keel assembly, keelson and frames.

The preserved keel assembly of the P2 wreck consists of an 11.87 m-long T-shaped keel and the 1.3 m-long bow keel extension. The keel has been slightly twisted and bent in its aft part during a millennium underwater and had to be digitally straightened. The framing has been assembled according to the *in situ* documentation and field inventories. There are fragments of 15 floor timbers preserved in 35 fragments. The most prominent element of the P2 wreck is undoubtedly the keelson with a mast step, located between frames Nos 9 and 12: its length is 2.79 m, and the mast step is located 8.1 m from the fore end of the bow keel extension. It was assumed that frame

No. 11, being the widest and located just behind the mast step was a central frame of the vessel and therefore a total keel length (with fore and aft extensions) was estimated at 17.8 m, which results in a total number of 23 frames. The missing elements of the framing system have been added to the model by copying and mirroring the preserved parts. Both stems of the vessel are missing and therefore their real shape remains unknown. Proposed reconstructions of stem shape have been prepared by J. Litwin and W. Stępień (Pomian, Litwin 2009) and they served as the basis for the two versions of the assembled model of the P2 wreck. The keel and the framing system components have been deformed by a millennium of resting below the seabed sediments. An attempt was made to reconstruct the original curvature of the floor timbers in order to recreate the hull as faithfully as possible. The height of three preserved thwart stanchions served as the determinant for the frame height: the length of preserved thwarts determined the width of the framing. There are 12 fragments of thwarts and ten knees preserved. With the help of the field documentation, it was possible to arrange them with the corresponding frames and to prepare the reconstructions of missing parts. Fortunately, one of few preserved knees was found still nailed to the thwart on frame No.10, closest to the mast step, which provided the cross section of the midships part of the vessel (fig. 1). The final elements of framing are represented by poorly preserved pieces of longitudinal stringer, fitted above the thwarts and on the knees.

After the placement and assembling of the framing system came the planking. All planks were made of oak. The starboard planking is in much better condition than the port, where the individual planks had to be assembled from a large number of chunks. The planks are on average 1.5 cm thick and 22-27 cm broad (while Strake 3 is narrower at only 15 cm). The only plank preserved completely (i.e. with both scarfs) is 3.26 m long, while the longest assembled strake (starboard garboard strake) is 12.81 m long and consists of four planks, joined together with simple transverse scarfs, approximately 7-8 cm long and connected with pegs and small rivets. The planking was joined with treenails approximately 1.5 cm in diameter placed every 9-10 cm, with an overlap of approximately 4 cm and caulked with animal hair. The planks are mostly oval in cross section with the exception of Strake 5, which has a deep groove through the middle part that may have indicate the waterline level. Several planks bear incisions left by frames. The third portside garboard plank bears traces of repair: a small, 43 cm-long fragment was treenailed to the plank with an additional row of treenails. Only a small piece of a sheer strake is preserved. There are no traces of the upper railing, although W. Stępień mentions such a feature as visible underwater in the 1980s (Stępień 1987, p. 152). There are two pieces of a shield rack and two rowlocks preserved, which indicate the military function of the vessel and its means of propulsion.

#### 4. HYDROSTATIC CHARACTERISTICS OF THE RECONSTRUCTED HULL

With the preserved planking assembled (fig. 2), the overall hull shape could be reconstructed and the hydrostatic characteristics of the hull assessed, according to the methodology

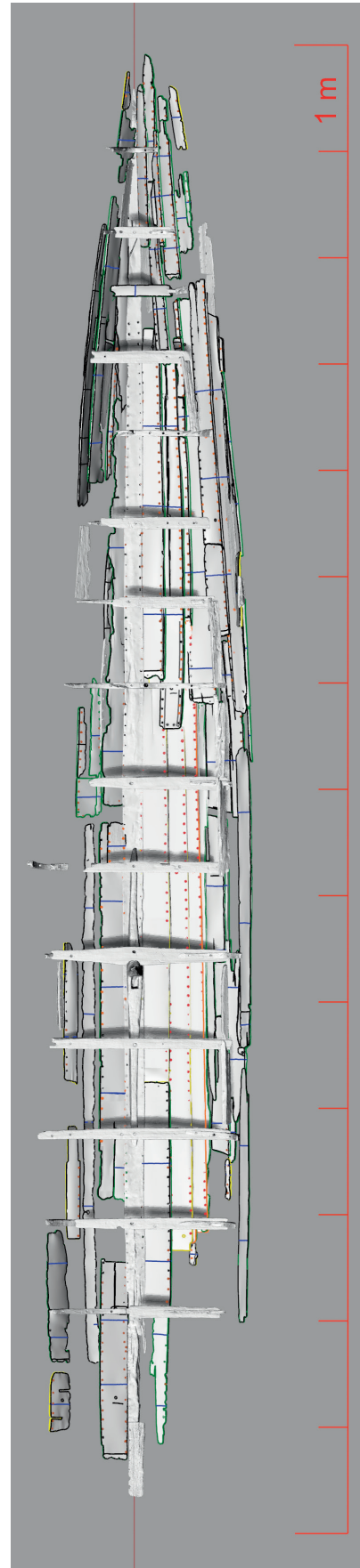


Fig. 2: Preserved elements of the P2 wreck after reassembly (J. Różycki, P. Litwinienko).



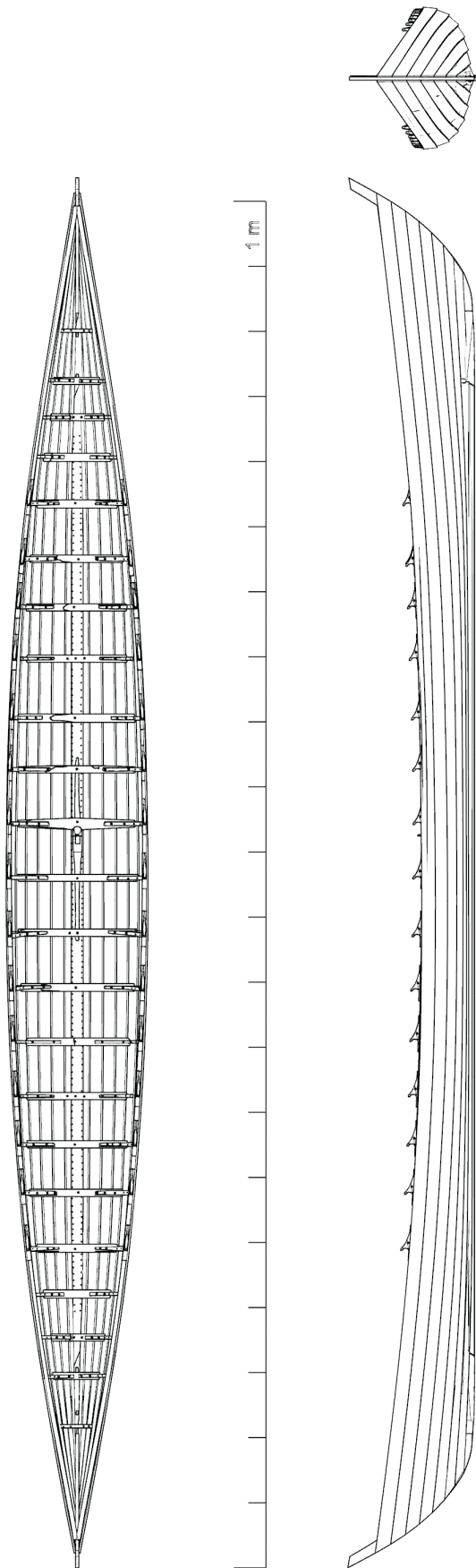


Fig. 3: Graphic reconstruction of the P2 vessel (J. Różycki, P. Litwinienko).

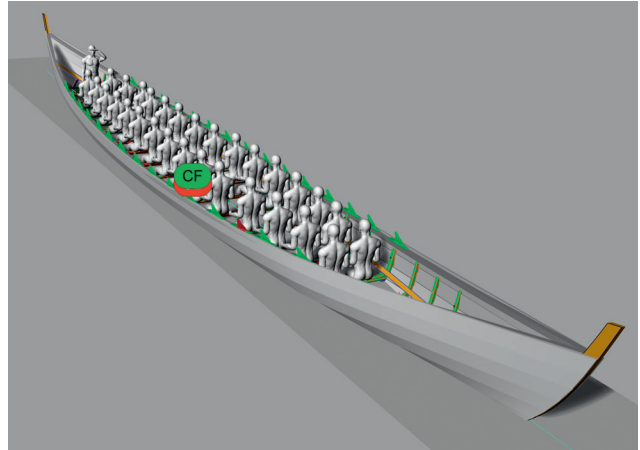


Fig. 4: Axonometric view of the P2 vessel with crewmembers and waterline (J. Różycki, P. Litwinienko).

developed for the Drogheda boat and the Newport ship, with the use of the Orca 3D plug-in (Tanner 2013a, 2013b, 2017). The edges of preserved planks were elongated alongside the frames to create the fair lines of the vessel (fig. 3). The unknown details of joining the planking with stems were not reconstructed in the model. For further simplification of this lapstrake planking, a plain hull using the Orca 3D plate tool was created. In order to estimate the weight of the vessel and therefore its light displacement, weight properties of each construction element (both preserved and reconstructed) were defined within the Orca 3D weight and cost properties tool. Most elements (keel assembly, majority of framing, planking) are of oak, while a few frames, knees and stringers are birch, alder and pine (see table 1). The wood species were analysed by Irena Jagielska from the conservation laboratory of the National Maritime Museum in Gdańsk.

Table 1: Weight properties of structural elements of the P2 wreck

| Element                                 | Material                       | Weight               |
|---|--------------------------------|----------------------|
| Keel assembly (with keelson)            | oak (690 kg/m <sup>3</sup> )   | 207 kg               |
| Floor timbers, knees, thwarts, rowlocks | oak (690 kg/m <sup>3</sup> )   | 162 kg               |
| Five floor timbers, stringers           | alder (510 kg/m <sup>3</sup> ) | 216 kg               |
| One floor timber                        | birch (610 kg/m <sup>3</sup> ) | 5 kg                 |
| Planking                                | oak (690 kg/m <sup>3</sup> )   | 897 kg               |
|   |                                | <b>1487 kg Total</b> |

The lightweight of the vessel and the overall shape of its hull allowed for calculation of its draught and loading capabilities, with the use of the minimum freeboard (F) condition after the medieval Icelandic Law (Tanner 2017, p. 173), which in case of the P2 vessel gives 32 cm ( $F=2D/5$ ). The results of hydrostatic calculations performed by the Orca 3D software are given in Table 2. Three conditions were assumed: a lightweight condition, with the vessel empty of crew and provisions; a loaded condition with 31 crewmembers (each weighing 70 kg, 30 sitting on rowing benches and one standing) and 1500 kg of ballast, provisions and equipment; and a fully loaded condition with the 32 cm freeboard (fig. 4).

**Table 2:** Hydrostatic characteristics of the P2 vessel

|                                      | Lightweight                  | Loaded  | Fully loaded                         |
|--------------------------------------|------------------------------|---|--------------------------------------|
| Length overall                       | 21.35 m                      | 21.35 m   | 21.35 m                              |
| Beam                                 | 2.16 m                       | 2.16 m  | 2.16 m                               |
| Midships depth                       | 80 cm                        | 80 cm   | 80 cm                                |
| Waterline length / wet area          | 18.6 m / 26.4 m <sup>2</sup> | 19.1 m / 38.5 m <sup>2</sup>                                  | 19.3 m / 42.3 m <sup>2</sup>         |
| Displacement                         | 14874 kg                     | 51574 kg  | 7094 kg                              |
| Draught                              | 21.5 cm                      | 40.1 cm   | 48 cm                                |
| Freeboard                            | 58.5 cm                      | 39.9 cm   | 32 cm                                |
| Crew number and weight               | 0                            | 31 men = 2170kg   | 31 men = 2 170 kg                    |
| Ballast, equipment, provisions, etc. | 0                            | 1500 kg (including 600 kg of water and provisions for 5 days) | 3437 kg (maximum loading capability) |
| Max heel angle                       | 35                           | 20  | 15                                   |
| LCB                                  | 10.6 m                       | 10.5 m  | 10.6 m                               |
| VCB                                  | 14.5 cm                      | 26.6 cm   | 31.4 cm                              |
| VCG                                  | 49 cm                        | 57.6 cm   | 51 cm                                |

## 5. CONCLUSION

As the hull reconstruction and the results show, P2 was an extremely long and light vessel, with a beam to length ratio of 1:10 and roughly 1500 kg of lightweight. Powered by a maximum crew of 30 oarsmen, the boat could also be a very fast one. It was undoubtedly used for military purposes by a local chieftain ruling over the Gulf of Gdańsk region, maybe during the struggle with the Polish Piast dynasty for control of these areas in the late 10<sup>th</sup> century (Śliwiński 2013). However, the propulsion characteristics of rowers and hull resistance still remain to be tested. Also, the presence of the keelson with a mast step raises many questions about the sail propulsion characteristics and the seaworthiness of such a slender vessel, which bears traces of both Scandinavian and southern Baltic (Slavic) shipbuilding traditions. This documentation and reconstruction programme was the first to be carried out on an early medieval wreck from the National Maritime Museum in Gdańsk collections. Recording and reconstructing other lapstrake vessels from this time period and region will provide us with the basis for comparative studies and undoubtedly enrich our knowledge about shipbuilding in the Gulf of Gdańsk area.

## REFERENCES

- HOCKER F.  
2003 *Three dimensional documentation of ship timbers using the FaroArm, Handbook v. 2.0*, Roskilde, Nationalmuseets Marinarkaeologiske Forskningscenter (unpublished document).
- JONES T.  
2011 Three Dimensional Recording and Digital Modelling of the Newport Medieval Ship, in E. Laanela, J. Moore (eds), *ACUA Underwater Archaeology Proceedings 2009*, Columbus, Ohio, Advisory Council on Underwater Archaeology Publication, p. 111-116.
- LITWIN J.  
1995 The Puck Bay wrecks – an opportunity for a “Polish Skuldelev”, in O. Olsen, J. Skamby Madsen, F. Rieck (eds), *Shipshape. Essays for Ole Crumlin-Pedersen*, Roskilde, Viking Ship Museum, p. 135-160.
- OSSOWSKI W., KRAPIEC M.  
2003 Badania dendrochronologiczne niektórych zabytków szklenictwa średniowiecznego z Pomorza Wschodniego, in H. Paner, M. Fudziński (eds), *XIII Sesja Pomorzoznawcza*, Gdańsk, Muzeum Archeologiczne, p. 271-292.
- POMIAN I.  
2002 Prace Centralnego Muzeum Morskiego w Gdańsku na stanowisku portu średniowiecznego w Pucku, *Zapiski Puckie* 1, p. 127-132.
- POMIAN I., LITWIN J.  
2009 Attempt at evaluating the scientific value of the P-2 boat originating from the Early Middle Ages, in R. Bockius (ed.), *Between the Seas. Transfer and Exchange in Nautical Technology, Proceedings of the Eleventh International Symposium on Boat and Ship Archaeology (ISBSA 11)*, Mainz 2006, Mainz, Römisch-Germanischen Zentralmuseums, p. 421-428.
- STĘPIEŃ W.  
1987 Wczesnośredniowieczny wrak łodzi klepkowej W-2 z Zatoki Puckiej, in A. Mikołajczyk (ed.), *Prace i materiały Muzeum Archeologicznego i Etnograficznego w Łodzi, seria archeologiczna*, 34, p. 139-154.
- 1998 Wczesnośredniowieczny port w Pucku, in A. Groth (ed.), *Historia Pucka*, Gdańsk, Wydawn, p. 36-54.
- ŚLIWIŃSKI B.  
2013 *Port średniowieczny w Pucku – rys historyczny*, in I. Pomian (ed.), *Raport końcowy z prac wykonanych przez Muzeum Ziemi Puckiej im. Floriany Ceynowy w Pucku, projekt “Aktualizacja Dokumentacji Archeologicznej”*, Gdańsk, National Maritime Museum, p. 31-44 (unpublished report).
- TANNER P.  
2013a 3D Laser Scanning for the Digital Reconstruction and Analysis of a 16<sup>th</sup> century Clinker Built Sailing Vessel, in C. Breen, E. Forsthe (eds), *ACUA Underwater Archaeology Proceedings 2013*, Leicester, Advisory Council on Underwater Archaeology Publication, p. 137-149.
- 2013b *Newport Ship Specialist Report: Digital Reconstruction and Analysis of the Newport Ship*, York, Archaeological Data Service.
- 2017 The testing and analysis of Hypothetical Ship Reconstructions, in J. Litwin (ed.), *Baltic and Beyond, Change and continuity in Shipbuilding, Proceedings of the Fourteenth International Symposium on Boat and Ship Archaeology (ISBSA 14)*, Gdańsk 2015, Gdańsk, National Maritime Museum, p. 171-178.
- WAŻNY T.  
2001 *Analiza dendrochronologiczna wraku łodzi P2 (Zatoka Pucka)*, Gdańsk, National Maritime Museum (unpublished report).
- 2013 *Analiza dendrochronologiczna drewna z Pucka*, in I. Pomian (ed.), *Raport końcowy z prac wykonanych przez Muzeum Ziemi Puckiej im. Floriany Ceynowy w Pucku, projekt “Aktualizacja Dokumentacji Archeologicznej”*, Gdańsk, National Maritime Museum, p. 45-48 (unpublished report).
- ŻRÓDOWSKI C.  
2014 An attempt to create a digital reconstruction of the Copper Ship, in W. Ossowski (ed.), *The Copper Ship. A Medieval Shipwreck and its Cargo*, Gdańsk, National Maritime Museum, p. 197-238.



# THE BREMEN-COG: RECONSTRUCTED ONE MORE TIME

Pat TANNER and Mike BELASUS

---

## Abstract

Within the three-year project “Between the North Sea to the Norwegian Sea: interdisciplinary research on the Hanse” (2015-2018), established by the Leibniz Association at the German Maritime Museum, questions were raised on the seaworthiness of ships of the Bremen-type<sup>1</sup>. The main object of the resulting research was the late medieval Bremen-Cog, from 1378-1379, which was found in 1962 in the River Weser close to Bremen and is today on display at the museum in Bremerhaven.

The project did not begin with the intention of reconstructing an already reconstructed ship find, but rather to examine the overall hydrodynamic and seakeeping abilities of the ship, in order to see whether ships of this building method were the oceangoing trading vessels of their era, and could sail the North Atlantic all the way to Iceland.

In order to evaluate the complex concepts of seakeeping and oceangoing, a reliable hull form as well as accurate construction details are required. Establishing the vessel’s overall hydrostatic characteristics, static and dynamic stability, and overall sailing abilities, requires detailed calculations using the centres of buoyancy, flotation and gravity.

## Keywords

Bremen, cog, late medieval, ship reconstruction

## Résumé

Dans le cadre du projet triennal « Entre la mer du Nord et la mer de Norvège : recherche interdisciplinaire sur la Hanse » (2015-2018), mis en place par l’Association Leibniz au Musée maritime allemand, des questions ont été soulevées sur la navigabilité des cogues du type de celle de Brême. Notre attention s’est donc portée sur la cogue de Brême, datée de la fin du Moyen Âge, précisément de 1378 ou 1379, et trouvée en 1962 dans la Weser près de Brême et qui est aujourd’hui exposée au musée de Bremerhaven. Le projet n’a pas commencé avec l’intention de proposer une nouvelle hypothèse de restitution d’un navire par ailleurs déjà restitué, mais plutôt d’examiner les caractéristiques hydrodynamiques et de tenue à la mer du navire. Ceci afin de voir si les navires de ce type ont pu participer à un commerce océanique en navigant sur l’Atlantique Nord jusqu’à l’Islande.

Afin d’évaluer la tenue à la mer et les capacités transocéaniques du navire, l’établissement d’une forme de coque fiable ainsi qu’un plan détaillé de la construction sont nécessaires. L’évaluation des caractéristiques hydrostatiques globales, de la stabilité statique et dynamique et des capacités générales de navigation du navire s’effectue grâce aux mesures complexes des centres de flottabilité, de flottaison et de gravité.

## Mots-clés

Brême, cogue, fin du Moyen Âge, reconstruction de navire

---

Earlier historical research determined the cog to be a predominant vessel for seaborne transport within the Hanseatic League (Heinsius 1956; Fliedner 1969; Thier 2017). The technical definition of this supposed ship type was later based on the Bremen-Cog (Crumlin-Pedersen 2000, p. 230-233; Hocker, Ward 2004, p. 75). The majority of the league’s trade ranged from Russia in the east, across the Baltic Sea, to Britain in the west, across the North Sea. Records also show trade with ‘outlying’ regions, such as Iceland in the northwest Atlantic Ocean (Wubs-Mrozewicz 2009), as well as south into the Mediterranean. The term “cog” is mentioned in connection with trade in all these regions (Gardiner 2007, p. 405).

However, is the Bremen-Cog, an example of the Bremen-type shipbuilding method, a typical example of the vessels that traded across the open oceans with Iceland as documented in historical records? Is the Bremen-type ship of the archaeological record the oceangoing cog of 80-200 tonnes in the historical documents (Gardiner 2007) of the Hanseatic League?

Ship technical calculations have in the past been employed in the analyses of the original qualities of an archaeological vessel, and hence its sphere of operation. While it is possible to determine various coefficients that can describe the form and the hydrostatic qualities for each individual vessel, only by quantifying these conditions can a basis be formed for a scientific analysis. When studying the hydrodynamic conditions, the problems are even greater. The results of these are dependent on several factors, and for new ships, a combination of experiments with scale models, tank tests and full-scale sea trials has made it possible to develop correlation factors that permit reasonably reliable predictions of performance to be made. However, such work on ancient ships has not been fully undertaken in order to corroborate the results (Crumlin-Pedersen, Trakadas 2003, p. 217-218).

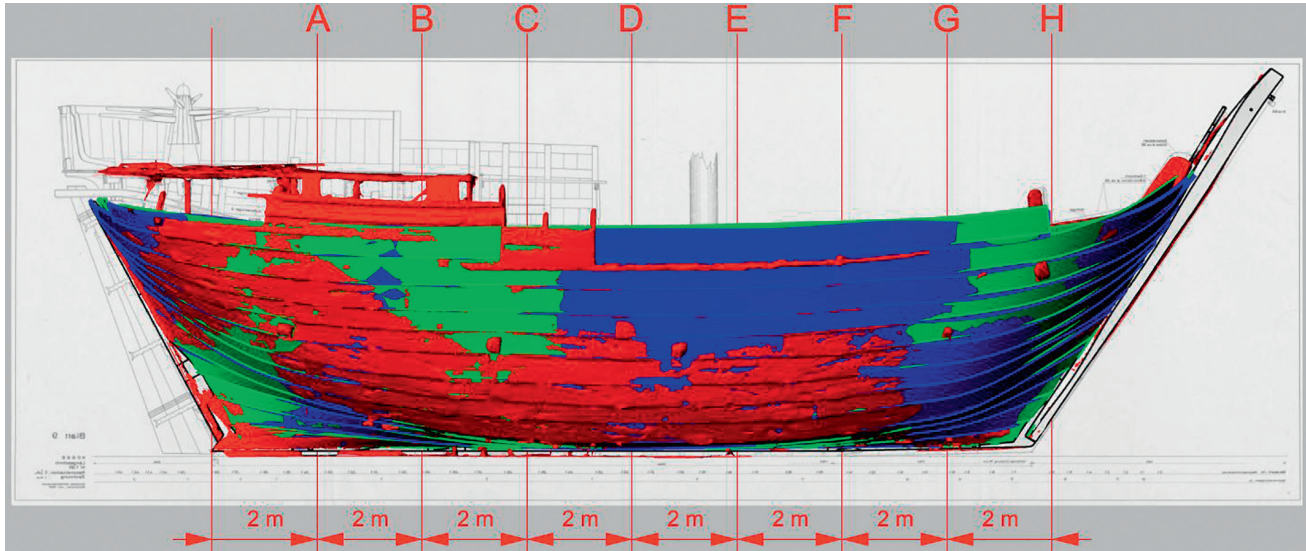
## 1. PREVIOUS ANALYSES OF THE BREMEN-COG

Previous analyses of the Bremen-Cog have included the rigging, which was designed by Hoheisel, a naval architect and technical director of the German Maritime Museum. Clausen,

---

1. “Bremen-type” refers to the shipbuilding method defined on the base of the Bremen-Cog. It is used here to avoid the term “Cog/Kogge” for the archaeological/technical definition, which causes contradictions and misunderstandings (Belasus 2017).





**Fig. 1:** Comparison of the digital data sets. The colour coding is as follows: blue is the hull shape from Lahn's section drawings; green is the hull shape from Lahn's lines plan drawings; and red is the hull shape during 3D laser scanning in 2014 (P. Tanner).

**Table 1:** Comparison of the published versions of the Bremen-Cog.

| Version                  | Empty weight | Ballast tonnes | Cargo tonnes | Displacement tonnes | Draught |
|--------------------------|--------------|----------------|--------------|---------------------|---------|
| Lahn                     | 60 tonnes    | –              | 76 - 84      | 136 – 144           | 2.25 m  |
| Hoheisel                 | 55 tonnes    | 26             | –            | 81                  | 1.53 m  |
| Hoheisel                 | 55 tonnes    | –              | 87           | 142                 | 2.25 m  |
| Jensen                   | –            | –              | –            | 139.23              | 2.25 m  |
| <i>Ubena von Bremen</i>  | 40 tonnes    | 35             | –            | 75                  | 2.25 m  |
| <i>Kieler Hansekogge</i> | 38 tonnes    | 22             | –            | 60                  | 1.6 m   |
| <i>Roland von Bremen</i> | 100 tonnes   | 20             | –            | 120                 | 2.25 m  |

a student in ship engineering at Hamburg University, tested Hoheisel's reconstructed rigging on a simplified model in a wind tunnel. Results indicated that the vessel could tack to windward, but tests were unable to include wave action or seaway. Redlin, a student at the Technical University of Berlin, tested the hull shape: he drew an idealised set of lines based on photogrammetry measurements, and calculated the stability for various cargo loads and resultant waterlines, concluding the vessel was stable while ballasted or loaded but unstable if unballasted with the rigging standing. Redlin calculated a minimum ballast of 26 tonnes, based on the Vejby cog in Denmark (Hoheisel 1994). Professor Postel at the Institute for Shipbuilding in Kiel undertook tank-towing tests, and his experiments indicated the model could not come above 90° to the true wind. Postel described the vessel as a "beam-wind sailor" provided it was ballasted and in calm waters (Hoffmann, Hoffmann 2009, p. 287-289).

Further details of the Bremen-Cog include Lahn's estimate of the ship's weight at 60 tonnes empty, giving a draught of 1.25 m and a cargo weight of 76-84 tonnes, giving a displacement of 136-144 tonnes at a draught of 2.25 m (Lahn 1992, p. 250). Hoheisel estimated the ship to weigh 55 tonnes without ballast, to have a draught of 1.53 m when ballasted, and a draught of 2.25 m with a maximum cargo of 87 tonnes. Based on Lahn's drawings, Kenn Jensen calculated the displacement to be 139.23 tonnes at 2.25 m draught (Jensen 1999, p. B-50). Of the three replicas: the *Ubena von Bremen*, built in 1991, is listed as 75 tonnes displacement, including 35 tonnes of ballast

at 2.25 m draught; the *Kieler Hansekogge*, also built in 1991, is listed as 60 tonnes displacement including 22 tonnes of ballast at 1.6 m draught; and the *Roland von Bremen*, built in 2000, is listed as 120 tonnes displacement including 20 tonnes of ballast at 2.25 m draught (Hoffmann, Hoffmann 2009, p. 291). The displacement weights for the three replicas equate to unballasted weights of 40, 38 and 100 tonnes respectively<sup>2</sup>, even though all three were built based on the same drawings, and should be the same shape, yet *Roland von Bremen* displaces 45 tonnes more than *Ubena* at the same draught. Either the quoted figures are inaccurate, or the *Roland von Bremen* has an additional 43.9 m<sup>3</sup> volume in her underwater hull form. A comparison of the various versions is set out in Table 1. As Crumlin-Pedersen stated, the relevance of these calculations is impaired by the fundamental uncertainty that is attached to the reconstruction solution (Crumlin-Pedersen, Trakadas 2003, p. 217-218).

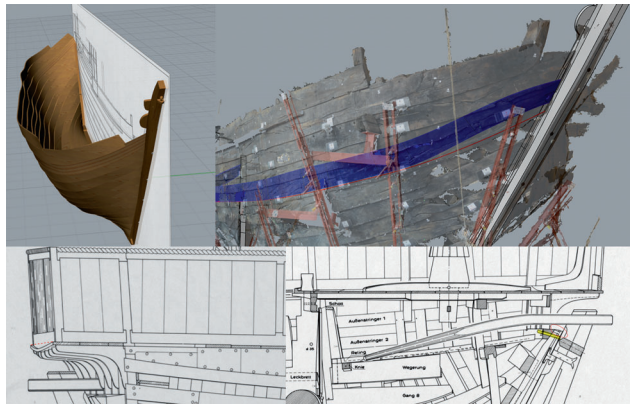
## 2. AVAILABLE DATA SETS

The shape of the Bremen-Cog, as it currently stands on display in the museum's ship hall, is not a true representation of

<sup>2</sup> The weight for *Roland von Bremen* has been attributed to the extra thick hull planking and thicker mast.

**Table 2:** Changes in sheer heights over time.

| Position            | A       | B       | C       | D       | E       | F       | G       | H      |
|---------------------|---------|---------|---------|---------|---------|---------|---------|--------|
| Photogrammetry 1980 | 0       | 0       | 0       | 0       | 0       | 0       | 0       | 0      |
| Lahn Drawing 1985   | +32 mm  | +15 mm  | +23 mm  | +86 mm  | +82 mm  | +66 mm  | +19 mm  | 0 mm   |
| 3D scan 2011        | No Data | -46 mm  | -47 mm  | -117 mm | -71 mm  | -104 mm | -113 mm | -79 mm |
| SFM Oct 2014        | -66 mm  | -58 mm  | -58 mm  | -141 mm | -118 mm | -135 mm | -143 mm | -92 mm |
| 3D scan 2014        | -105 mm | -103 mm | -102 mm | -169 mm | -138 mm | -156 mm | -185 mm | -99 mm |



**Fig. 2:** Top left, unfair strake runs; top right, strake runs not matching archaeological evidence; bottom left, reverse camber in castle deck; bottom right, transom beam bolted (yellow) 80 mm below existing hole (circled red) (P. Tanner).

the hull shape: it has suffered several periods of distortion<sup>3</sup>. Consequently, a decision was made to attempt to examine the current overall hull shape and compare that to the available data sets. The available data sets included two-dimensional paper drawings by Lahn in 1981-90, which also included a photogrammetry survey of the reconstructed vessel carried out by the University of Hanover in 1980, as well as published material on the vessel (Kiedel, Schnall 1989; Lahn, 1992). In addition, the data from three separate occasions of three-dimensional digital documentation<sup>4</sup> carried out by the museum in 2011 and 2014 was included.

The goal of the project changed from simply analysing the seafaring capabilities of the vessel to also examining the current form of the vessel on display, as well as attempting to distil several conflicting data sets into a valid hypothetical reconstruction to be used as the basis for detailed hydrodynamic and seakeeping analysis.

### 3. METHODOLOGY

All of the available data sets were imported into Rhinoceros, a 3D CAD modelling software, and the original published Lahn drawings were converted into three-dimensional CAD models in order to compare with the various three-dimensional

3. The still ongoing deformation processes are a subject of current research on monitoring of large-scale museum objects within preventive conservation by Amandine Colson, University of Bamberg, Germany.

4. The vessel remains were 3D-laser scanned in 2011 and 2014, and recorded using photogrammetry in 2014 by the German Maritime Museum.

digital documentation sets (fig. 1). This clearly illustrated the changing form of the hull shape over the 30 year period from the initial reconstruction to its shape when documented in 2014 (Tanner 2017a, p. 5-24). A series of cross sections (A-H) were taken at 2 m intervals along the keel, and the changing height of the sheer at each point is documented in Table 2. This deformation and change in hull shape could possibly be explained by the steel structure, which is currently supporting the vessel in the museum, or by shrinkage of the exhibited timbers

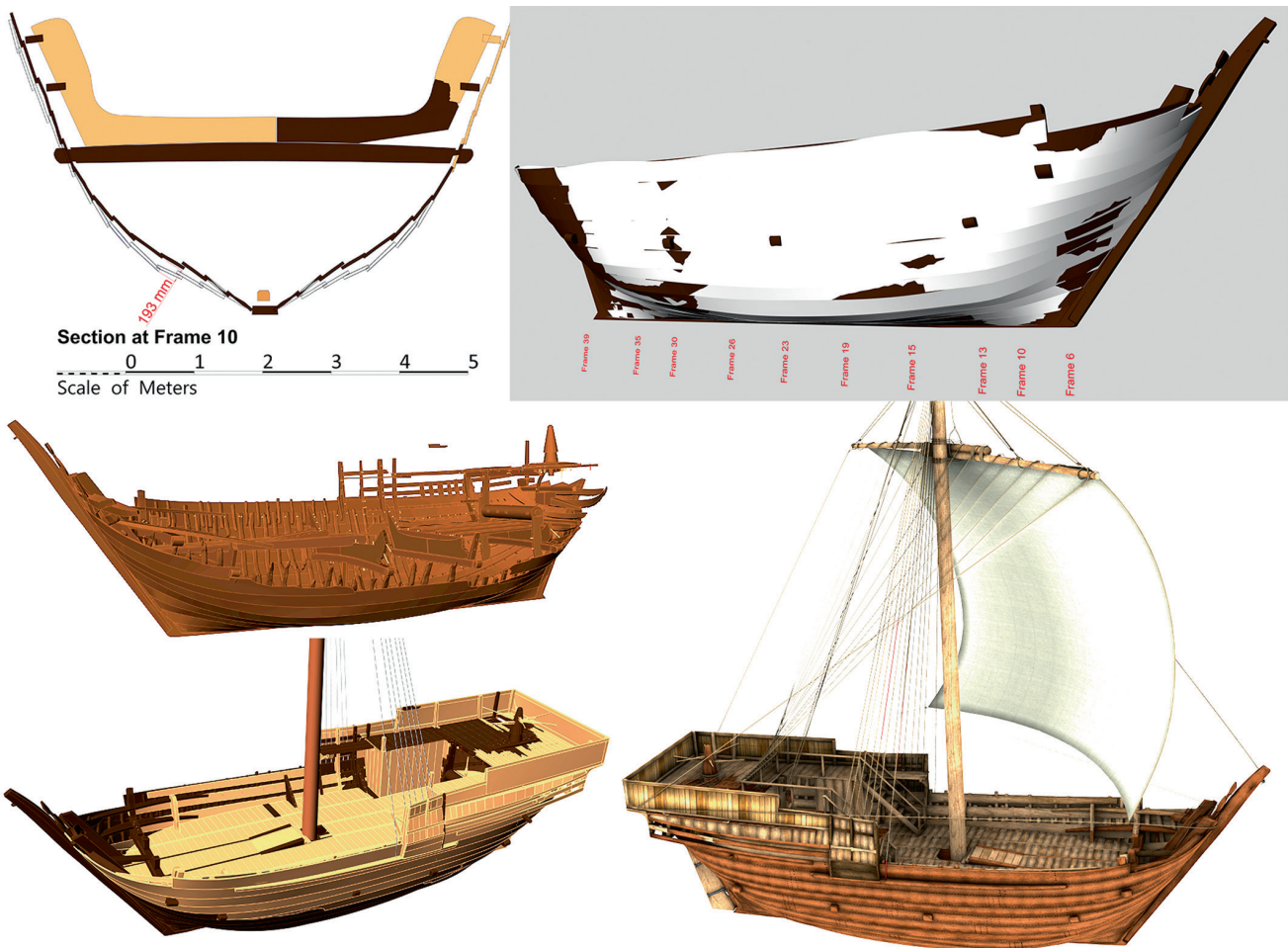
While generating 3D models from Lahn's drawings, it was realised that all of these drawings could not be reconciled into a single coherent three-dimensional model, as can be seen from the blue and green surfaces in Figure 1. Additional discrepancies noted (fig. 2) include strake runs which appear very distorted when modelled three-dimensionally, the transverse beam bolted 80 mm lower than the archaeological evidence suggests, the reverse camber to the castle deck, as well as the angled stern castle deck.

It was therefore decided to undertake a completely revised digital reconstruction of the vessel<sup>5</sup> in order to reconcile the various Lahn drawings, not only with each other, but also with the archaeological evidence. The methodology used in this approach has been demonstrated using a known test subject, and the results have been shown to be better than 99% accurate for dimensional variations in the 3D modelling process, and better than 98% accurate when calculating displacement values using average wood densities (Tanner 2017b).

### 4. A NEW HYPOTHETICAL RECONSTRUCTION

In a process similar to that used on the Drogheda boat, the Newport ship and the Poole Iron Age logboat (Berry *et al.* 2019; Tanner 2013a, 2013b), a digital model of every constituent part of the vessel was created using Rhinoceros 3D, with Lahn's drawings and the archaeological data as reference. A series of fair curves were created to represent each strake. The length of each curve was fixed to match the archaeological evidence taken from the 3D scan data, and the curvature adjusted until fair, using Lahn's drawings and the 3D scan data as a reference (fig. 3, top). Then, digital 3D models of the surviving hull elements were created and fitted to the evolving hull form (fig. 3, middle left). Next, the missing elements were extrapolated and modelled (fig. 3, bottom left) to create a more definitive hypothetical reconstruction combining all of the available data sets (fig. 3, bottom right). The revised hypothetical reconstruction based on the evidence resulted in a less full-bodied hull form, compared to Lahn's reconstruction, particularly in the lower

5. This process is explained in detail in the reconstruction report on file at the German Maritime Museum, Bremerhaven, Germany (Tanner 2017a, p. 47-63).



**Fig. 3:** Top left, difference between Lahn and reconstructed hull at Frame 10; top right, difference between two hull forms; middle left, archaeological remains 3D modelled; bottom left, missing elements extrapolated; bottom right, fully reconstructed hypothetical reconstruction of the Bremen cog. (P. Tanner).

extremities, such as at Frame 10 (fig. 3, top left) where the revised shape was up to 20 cm narrower at the height of the fourth strake.

With the entire vessel modelled using Rhinoceros 3D, it was then possible to analyse the vessel in greater detail. One of the added benefits of the project was that 3D modelling the surviving archaeological elements allowed for a better understanding of the material remains. The surviving elements of the Bremen-Cog weigh a total of 25.02 tonnes<sup>6</sup>. In addition, during the recording and digital reconstruction phase of this project, it was possible to accurately measure the timbers, allowing the shrinkage of the conserved timbers to be analysed. A sample of the results is set out in Table 3. The amount of shrinkage proved comparable with that documented in the Newport medieval ship where tangential shrinkage (width in the case of radially split planks) ranged between 4.4 and as much as 15.1% with an 8% average (Jones, Panter 2016).

6. This weight is based on using an average density for the oak, in this case 800 kg per m<sup>3</sup> being typical for oak at 27% moisture content. This figure can be revised if the exact density of the PEG-treated oak is known.

## 5. ANALYSIS OF THE HYPOTHETICAL RECONSTRUCTION

The determination of a vessel's capabilities is a complicated interaction between hydrodynamic and aerodynamic forces, dependant on many factors including flotation characteristics, static stability, dynamic stability, performance, environmental conditions, and seamanship. Past approaches to examining the Bremen-Cog's seafaring or hydrodynamic capabilities have included tank and wind tunnel testing, which are limited (Crumlin-Pedersen, Trakadas 2003, p. 217-218), as well as full-scale replicas used for sea trials. However, the tests have produced conflicting results such as wind tunnel results indicating the vessel could tack to windward, while tank-towing tests indicated the model could not come above 90° to the true wind. The replicas all include modern additions, such as mechanical propulsion systems, watertight decks and other safety requirements. Hoheisel states the replica *Kieler Hansekogge* could sail at about 70° to the wind but would drift about 15 to 20° (Hoheisel 1994, p. 259), this would result in the vessel making little or no progress to weather as the resultant course to windward would be 90° or more.



**Table 3:** Shrinkage measured between 1980 and 2014 scan dimensions

| Location             | Lahn measurement 1980 | 2014 laser scan dims. | Difference |        |
|----------------------|-----------------------|-----------------------|------------|--------|
| Weather board @ F19  | 580 mm                | 527 mm                | 53 mm      | 9.1 %  |
| Strake 12 @ Frame 19 | 642 mm                | 604 mm                | 38 mm      | 5.9 %  |
| Strake 11 @ Frame 19 | 648 mm                | 609 mm                | 39 mm      | 6.0 %  |
| Strake 10 @ Frame 19 | 494 mm                | 457 mm                | 37 mm      | 7.5 %  |
| Strake 9 @ Frame 19  | 509 mm                | 465 mm                | 44 mm      | 8.6 %  |
| Weather board @ F23  | 574 mm                | 537 mm                | 37 mm      | 6.4 %  |
| Strake 12 @ Frame 23 | 635 mm                | 577 mm                | 58 mm      | 9.1 %  |
| Strake 11 @ Frame 23 | 649 mm                | 581 mm                | 68 mm      | 10.5 % |
| Strake 10 @ Frame 23 | 505 mm                | 457 mm                | 48 mm      | 9.5 %  |
| Strake 9 @ Frame 23  | 515 mm                | 474 mm                | 41 mm      | 8.0 %  |

A more traditional approach has typically been to use various coefficients that can describe the form and the hydrostatic qualities. McGrail (1987) gives a brief introduction to using weight calculations and hydrostatic curves to determine the stability, displacement and draught calculations on ancient boats in Chapter 3 of *Ancient Boats in North-West Europe* (McGrail 1987, p. 12–22), and discusses methods of assessing the performance of a vessel in Chapter 11 (McGrail 1987, p. 192–203). The use of simple form coefficients is suggested by McGrail as a method of determining relative assessments of a boat’s capabilities, such as length to beam ratio or beam to depth ratio. Hydrostatic curves defining the underwater form of a vessel are used to generate coefficients of form which give forecasts of performance. However, coefficients<sup>7</sup> are a multiplier or factor that measures a particular property and are based on the underwater form of the vessel. Standard naval architectural convention divides the underwater volume into ten equal stations and using Simpson’s Rule an approximation of the underwater volume is calculated. This generates a snapshot of the underwater form of a vessel in a given flotation condition, which needs to be recalculated whenever external factors, such as additional cargo, or a change in heel angle due to wind load causes a change in the equilibrium condition, resulting in a changed underwater profile or volume.

Using Orca3D, a naval architecture plugin for Rhinoceros 3D allows for the rapid and real-time calculations of the hydrostatic forces in effect on a ship’s hull. By calculating the exact geometric form of the selected elements, and if material densities are applied to each element, the computer calculates the exact shape, weight and centre of gravity of the combined elements. Orca3D will then transform the model (ship) to its correct resultant equilibrium flotation condition. Once a static equilibrium condition has been achieved, the software also allows for external loadings such as wind loading, wind with icing, heavy lifting, towing, deck crowding and high speed turning to be applied to the model, and the relevant hydrostatic and stability criteria to be tested based on the updated flotation condition. In the case of the Bremen-Cog, all the constituent components of the vessel were solid modelled, and a material density applied to each<sup>8</sup>. The Orca3D software calculates the exact weight and centre

of gravity for the entire ship and, based on the geometric shape of the hull form, alters the angles of heel, trim and displacement depth in order to establish the exact equilibrium flotation plane. This is done in real-time and the resulting flotation condition is the only possible solution for a vessel of that specific form and weight.

## 6. STATIC STABILITY

A digital analysis of the vessel was carried out using Orca3D to determine its resultant equilibrium flotation condition in various weight and draught configurations. As the original flotation configuration for the original vessel is not known, the vessel was first tested in both a bare hull and fully rigged configuration to establish a baseline. Results showed that the bare vessel, without mast or rigging, floats in a stable condition. However, once the mast and rigging are added, the vessel becomes unstable and would require the addition of internal ballast. The quantity of internal ballast needs to be enough to counteract the overturning tendencies of the vessel itself as well as counteracting additional heeling moments caused by wind loading or wave roll. Modern rules for the stability of ships are formulated by the International Maritime Organisation (IMO): Bureau Veritas (BV) is one such classification organisation founded in Antwerp in 1828; it was originally Belgian but is now a French company (Bureau Veritas 2012, p. 81–97). The stability testing carried out by Orca3D used the Bureau Veritas criteria and the resulting static stability flotation conditions are shown in Table 4.

## 7. DYNAMIC STABILITY

For lateral wind loading, the yard and sail were rotated as far as possible (36.3° in this case) in order to project the maximum possible surface area to a ‘beam-on’ wind, representing a worst-case scenario wherein the sail was not released despite adverse winds. Orca3D uses this information to calculate a heeling moment, which is then applied to the vessel, in combination with wave roll action to determine the vessels resultant angle of heel and dynamic stability performance. Results from these tests indicated that 15 tonnes of internal ballast would be sufficient to satisfy the Marine Insurance Act (1906) and Bureau Veritas stability criteria. The term seaworthiness is a very broad one, as it not only includes the

7. The use of coefficients such as block, prismatic, midship, volumetric and slenderness coefficient are all values on a scale from 0 to 1. The values give no numerical values for what is good or below average.

8. For the timber elements, a density of 800 kg per m<sup>3</sup> being typical for oak at 27% moisture content



**Table 4:** Various draught and displacement results.

| Condition                         | Weight tonnes | Cargo tonnes  | Displacement | Draught aft | Draught forward | Freeboard | Downflooding angle | GMt                       |
|-----------------------------------|---------------|---|--------------|-------------|-----------------|-----------|--------------------|---------------------------|
| Bare hull and superstructure      | 43.25         | 0   | 43.25        | 1.25 m      | 0.64 m          | 3.26 m    | 49.5°              | 0.39 m                    |
| Fully rigged – unballasted        | 47.29         | The vessel with a negative metacentric height is unstable, resulting in an angle of loll <sup>9</sup> of 4.9°. Any slight heeling moment will capsize the ship. |              |             |                 |           |                    | – 0.29 m                  |
| Ballasted with 15 tonnes          | 62.29         | 0   | 62.29        | 1.49 m      | 0.95 m          | 2.97 m    | 44.7°              | 0.37 m                    |
| Draught set to 1.6 m (Hansekogge) | 62.29         | 7.33  | 69.62        | 1.60 m      | 1.05 m          | 2.72 m    | 42.9°              | 0.34 m depending on cargo |
| Beams not submerged               | 62.29         | 45.01   | 107.30       | 2.06 m      | 1.54 m          | 2.72 m    | 35.32°             | 0.82 m depending on cargo |
| Draught set to 2.25 m             | 62.29         | 61.25   | 123.54       | 2.25 m      | 1.72 m          | 2.15 m    | 32.36°             | 0.86 m depending on cargo |
| Grågås Codex loading              | 62.29         | 108.01  | 170.30       | 2.77 m      | 2.17 m          | 1.74 m    | 24.21°             | 1.10 m depending on cargo |

physical state of the vessel but also extends to other aspects and factors. Consequently, it is not easy to define seaworthiness in rigorous terms. A 13<sup>th</sup>-century law defined a ship as seaworthy if it did not need to be bailed more than three times in 24 hours (Christensen 1968, p. 138-139). A medieval Icelandic law in the Grågås Codex states the minimum freeboard (F) of a cargo ship should be  $F=2D/5$  where D = depth of hull amidships (Morken 1980, p. 178). In the case of the Bremen-Cog, this minimum freeboard would be  $F = 2 \times 4.35 / 5 = 1.74$  m.

The vessel was subsequently analysed in three flotation conditions: Condition A – fully rigged and ballasted with 15 tonnes; Condition B – with the protruding beam-ends not submerged, equating to a fully rigged ship, 15 tonnes of ballast and 45 tonnes of additional cargo; and Condition C – the Grågås Codex minimum freeboard condition, equating to a fully rigged ship, 15 tonnes of ballast and an additional 108 tonnes of cargo. For each flotation condition the vessel was then tested for various wind load and wave roll conditions using the Bureau Veritas criteria: the results are shown in Table 5.

**Table 5:** Resulting wind heel angle<sup>10</sup>

|             | Wind strength | Power generated from sail area | Speed @ 70% efficient Sail | Speed @ 40% efficient Sail | Wind heel angle | Freeboard remaining | Gust heel angle 150% wind | Freeboard remaining |
|-------------|---------------|--------------------------------|----------------------------|----------------------------|-----------------|---------------------|---------------------------|---------------------|
| Condition A | Force 3       | 23.48 kW                       | 7.45                       | 6.75                       | 7.98°           | 2.42 m              | 15.71°                    | 1.92 m              |
|             | Force 4       | 32.04 kW                       | 7.85                       | 7.15                       | 15.71°          | 1.92 m              | 26.01°                    | 1.21 m              |
|             | Force 5       | 31.2 kW                        | 7.80                       | 7.1                        | 15.80°          | 1.91 m              | 16.11°                    | 1.20 m              |
|             | Force 6       | 55.9 kW                        | 8.85                       | 7.82                       | 21.3°           | 1.53 m              | 32.4°                     | 0.79m               |
| Condition B | Force 3       | 23.48 kW                       | 5.9                        | 4.9                        | 0.8°            | 1.54 m              | 4.47°                     | 2.05 m              |
|             | Force 4       | 32.04 kW                       | 6.5                        | 5.5                        | 4.47°           | 2.05 m              | 9.67°                     | 1.76 m              |
|             | Force 5       | 31.2 kW                        | 6.4                        | 5.4                        | 4.42°           | 2.05 m              | 9.60°                     | 1.76 m              |
|             | Force 6       | 55.9 kW                        | 7.4                        | 6.4                        | 6.84°           | 1.92 m              | 14.17°                    | 1.49m               |
| Condition C | Force 3       | 23.48 kW                       | 4.85                       | 4.00                       | 0.76°           | 1.70 m              | 1.70°                     | 1.63 m              |
|             | Force 4       | 32.04 kW                       | 5.40                       | 4.45                       | 1.70°           | 1.63 m              | 3.89°                     | 1.49 m              |
|             | Force 5       | 31.2 kW                        | 5.35                       | 4.40                       | 1.65°           | 1.64 m              | 3.68°                     | 1.50 m              |
|             | Force 6       | 55.9 kW                        | 6.37                       | 5.35                       | 2.57°           | 1.57 m              | 5.71°                     | 1.37 m              |

9. Angle of loll is the state of a ship that is unstable when upright (i.e. has a negative metacentric height) and therefore takes on an angle of heel to either port or starboard. When this occurs, the vessel goes to neutral equilibrium, and the angle of heel at which it happens is called angle of loll.

10. For all conditions, a sail area of 100 m<sup>2</sup> plus three additional ‘bonnets’ of 33 m<sup>2</sup> each giving a total of 199 m<sup>2</sup> is used in Force 3 and 4 winds, and a mainsail alone of 100 m<sup>2</sup> for winds of Force 5 and above.

So far, the vessel has been tested to assess how it would float in various loading conditions as well as examining the heeling moments generated with various wind and wave roll loadings. These results give an indication of the vessel's initial static stability and demonstrate how the vessel will float at given cargo loads and various flotation depths and with various wind conditions. However, each test is a static snapshot and does not consider the dynamic and changing conditions of a body floating in water. Other than the vessel itself, the other major influencing factor on any sea voyage is the sea state, which is primarily influenced by waves. The three main factors which make up waves are wind speed, wind duration, and fetch<sup>11</sup>. These factors work together to create waves, and the greater each of the variables in the equation, the greater the size of the wave. The most significant variable of the three is fetch. Within the Baltic and North Seas, the fetch is limited to less than 300 nautical miles, thereby limiting the significant wave heights. Storm waves in the Baltic seldom exceed 2.4 m in height and 30 m in length, while those in the North Atlantic can reach heights of 10.6 m with a length of 304 m (Marchaj 1964, p. 400-401).

Computational fluid dynamics is a potential approach to analyse both aero- and hydrodynamic interactions with a vessel, however, the calculation process is a static one and the vessel will require to be re-orientated for each changing environmental factor, and the computing requirements are large. An alternative approach was to use Unity3D, a real-time development platform that includes a built-in physics engine to handle calculations based on real world physics. Blocks of appropriate size were created to represent the wave height and length for both the Baltic Sea and Atlantic Ocean and the computer-generated wind adjusted in order to create realistic sea conditions for both areas (fig. 4, top right). The digital model of the Bremen-Cog was then imported from Rhinoceros 3D to Unity, and with its characteristics set for Condition B (with the protruding beam ends not submerged, equating to a fully rigged ship, 15 tonnes of ballast and 45 tonnes of additional cargo), the physics engine applied a gravitational force on the vessel.

Voxels<sup>12</sup> were used to check whether each grid point on the hull was submerged (fig. 4, top left), and if so, to exert the appropriate upward (flotation) pressure to counteract the gravitational weight thereby causing the vessel to 'float' in a realistic manner. The speed of the vessel was adjusted to suit each of the relevant wind strengths, and with the simulation running, the vessel was observed to see if the simulated ship remained afloat or if any seawater was taken onboard. Results indicated the ship remained afloat in the Baltic Sea-type sea conditions in any weather condition, but struggled to remain afloat in anything over 20 knots of wind in the Atlantic, when waves of 5 m led to large volumes of water breaking over the sides. If, as suggested by Ellmers (1994, p. 41), the deck of the cog did not form a watertight connection with the hull, but rather allowed water to flow directly into the bilges, such quantities of water breaking onto the deck as seen in the 5 m waves of the Atlantic during 20

knot winds would quickly overwhelm any attempts at bailing out with a bilge pump (fig. 4, bottom right).

## 8. CONCLUSION

The Bremen-Cog, based on its hull shape, if restricted to not having the through-hull beams submerged, can carry a cargo of 45 tonnes, potentially increased to 60 tonnes if the ballast were replaced with cargo. At 2.25 m draught, each of the replica ships sail with beams wholly or partially submerged and the rebates for hull planking on the beam ends would suggest they were constructed in such a manner as to prevent water ingress. Archaeological evidence such as Doel 1 (Vermeersch, Haneca 2015) or Aber Wrac'h (L'Hour, Veyrat 1989), and iconographic representations depicting cogs, clearly show triangular or wedge-shaped blocks of timber attached to the exterior of the hull, adjacent to the through-hull beam ends. As discussed by Vermeersch and Haneca (2015, p. 123), these hemi-conical elements should be referred to as fairing blocks rather than fenders, as their design appears more to guide objects past the exposed square beam-ends than to protect against side impact. Perhaps the fairing blocks and rebated treatment of the through-hull beams indicates that having the beam ends submerged was not considered an issue (Waldus *et al.* 2019, p. 477). If this were the case the vessel could be loaded much deeper, to the Grågås Codex laws, allowing a cargo capacity of over 100 tonnes while maintaining a freeboard of 1.74 m.

The archaeological evidence for vessels of the Bremen-type shipbuilding method confirm the presence of such vessels all over the Baltic Sea and the southern North Sea (Abel *et al.* 1969; Crumlin-Pedersen 1979; Adams 1990; Ellmers 1994; Hoheisel 1994; Weski 1999; Adams, Rönby 2002; von Arbin, Daly 2012; Hocker, Daly 2016; Waldus *et al.* 2019). It is obviously a vessel well suited to this activity, for if it were not, it simply would not have flourished to such an extent (Ellmers 1994). Ellmers also noted the need for increased cargo capacity due to expanding trade and cites a cog mentioned in AD 1241 with a cargo capacity of about 240 tonnes (Ellmers 1994, p. 38). Hocker (Hocker, Ward 2004, p. 75) says of the Bremen cog, "As deep-water cogs go, it is of medium size, at 24 m long, with a capacity of 40 lasts (about 120 m<sup>3</sup>, which is about 80 metric tons of rye). In fact, it is smaller than nearly all contemporary accounts would suggest was typical. Medieval documents show that some Hanseatic cogs exceeded 100 lasts by the 1240s and cogs of 150 lasts were known in the fifteenth century."

It is not possible to state whether a vessel of the Bremen-type ever successfully completed a voyage to Iceland, or crossed the exposed Bay of Biscay, en route to the Mediterranean. Certainly, the historical record suggests that ships termed "cogs" were known at least in the Mediterranean (Springmann, Schreier 2008), but this use of the term might not always correspond to the same archaeological definition. Perhaps the larger cogs suggested by Ellmers and Hocker might be better suited to voyages such as crossing the Atlantic to Iceland. One possibility could be the Ijsselcog (Waldus *et al.* 2019): with a midship height of 5.8 m it is over 1.5 m higher than the Bremen-Cog, and almost 3 m longer. The Bremen-Cog as tested had a cargo of 61.25 tonnes and ballast of 15 tonnes leaving a static freeboard of 2.15 m. A similar quantity of cargo on the Ijsselcog would leave a static freeboard of 3.95 m.

11. Fetch is the distance of open water that the wind blows over.

12. A voxels represents a single sample, or data point, on a regularly spaced, three-dimensional grid. This data point can consist of a single piece of data, such as an opacity, or multiple pieces of data, in this case each voxel would continually check if it were submerged or no, and if submerged apply the relevant buoyant force to the vessel.



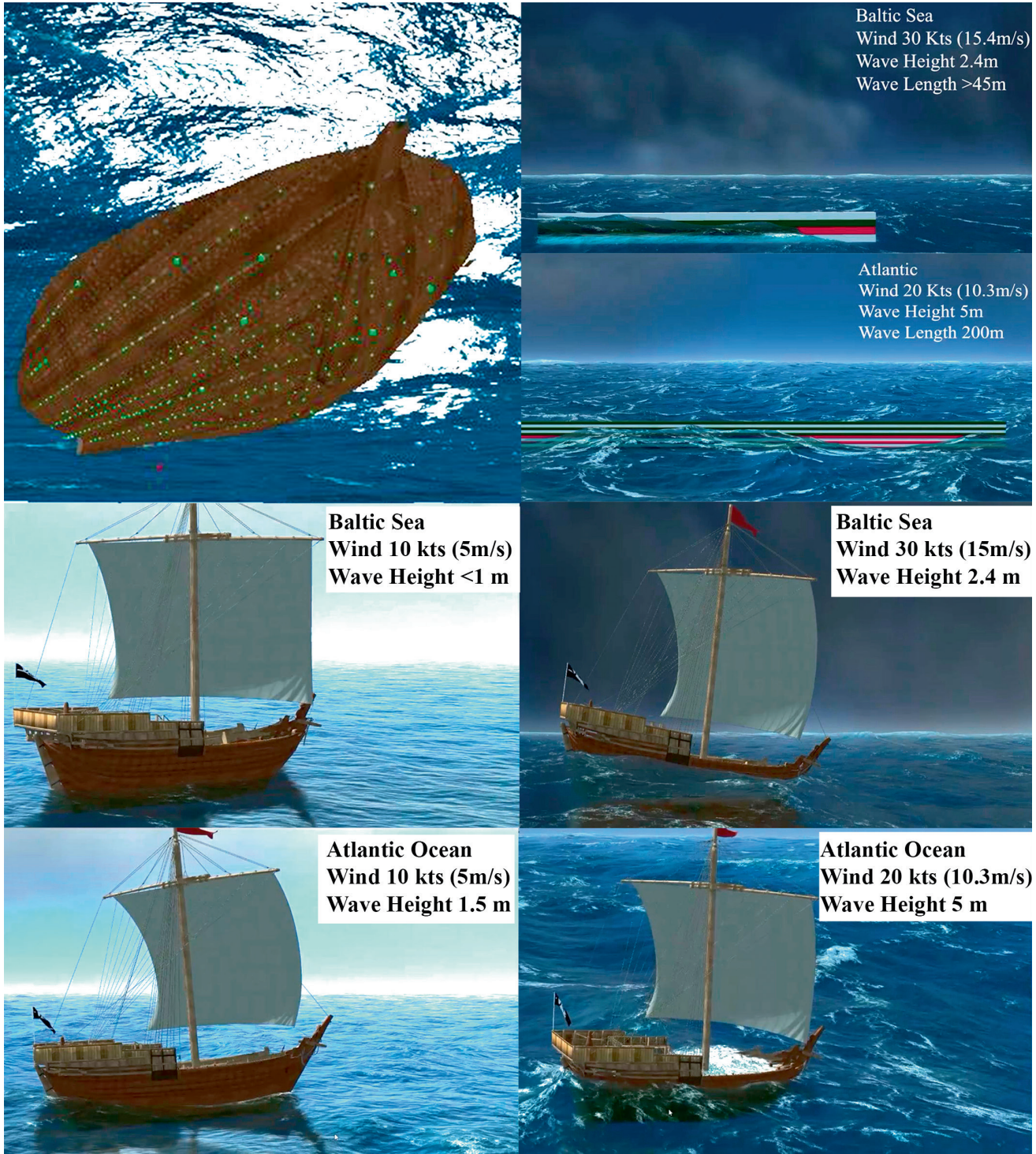


Fig. 4: Various sea states in the Baltic Sea and Atlantic Ocean. (P. Tanner).

The Bremen-Cog would, as a cargo vessel, appear to be well suited to transporting cargo along coastal routes and relatively short sea crossings, taking *circa* two to three days on the sheltered waters of northern Europe. However, its flat bottom, which would be prone to slamming in a high sea, combined with the

overall hull shape and performance characteristics would not indicate a vessel ideally suited to operations on the high seas of the exposed North Atlantic. It is the opinion of the authors that ships with the characteristics and dimensions of the Bremen-Cog would not be the primary choice for such an adventure.

## REFERENCES

- ABEL H., BAUCH J., FLIEDNER H., HOHEISEL W. D.  
1969 *Die Bremer Hanse-Kogge. Fund – Konservierung – Forschung*, Bremen, Monografien der Wittheit zu Bremen 8.
- ADAMS J.  
1990 The Oskarshamn cog. Part II: excavation, underwater recording and salvage, *IJNA* 19, p. 207-219.
- ADAMS J., RÖNNBY J.  
2002 Kuggmaren 1: the first cog find in the Stockholm archipelago, Sweden, *IJNA* 31, p. 172-181.
- BELASUS M.  
2017 Historical Ship Archaeology in the Shadow of Historism and Nationalism. A German Perspective, in A. Brooks, N. Mehler (eds), *The Country Where my Heart is: Historical Archaeologies of Nationalism and National Identity*, Gainesville, University Press of Florida, p. 222-241.
- BERRY J., PARHAM D., APPLEBY C. (EDS)  
2019 *The Poole Iron Age Logboat*, Oxford, Archaeopress.
- BUREAU VERITAS  
2012 *Rules for the Classification and the Certification of Yachts*, NR 500 DT R01 E, Neuilly-sur-Seine, Bureau Veritas, Marine Division.
- CHRISTENSEN A.E.  
1968 Sjøvollen Ship, *Viking* 32, p. 131-153.
- CRUMLIN-PEDERSEN O.  
2000 To be or not to be a cog: the Bremen Cog in perspective, *IJNA* 29, 2, p. 230-246.  
1979 Danish cog-finds, in S. McGrail (ed.), *The Archaeology of Medieval Ships and Harbours in Northern Europe*, Oxford, BAR International Series 66, p. 17-34.
- CRUMLIN-PEDERSEN O., TRAKADAS A. (EDS)  
2003 *Hjortspring: A Pre-Roman Iron-Age Warship in Context*, Roskilde, Viking Ship Museum, Ships and Boats of the North 5.
- ELLMERS D.  
1994 The cog as cargo carrier, in R. Gardiner (ed.), *Cogs, Caravels and Galleons: The Sailing Ship 1000-1650*, London, Conway Maritime Press, p. 29-46.
- FLIEDNER S.  
1969 «Kogge» und «Hulk». Ein Beitrag zur Schiffstypengeschichte, in H. Abel, J. Bauch, S. Fliedner, W.D. Hoheisel (eds), *Die Bremer Hanse-Kogge. Fund – Konservierung – Forschung*, Bremen, Monografien der Wittheit zu Bremen 8, p. 39-122.
- GARDINER M.  
2007 English and Hanseatic trading and fishing sites in medieval Iceland: report on initial fieldwork, *Germania* 85, 2, p. 385-427.
- HEINSIUS P.  
1956 *Das Schiff der hansischen Frühzeit*, Weimar, Quellen und Darstellungen zur Hansischen Geschichte, Neue Folge, XII.
- HOCKER F., DALY A.  
2016 Early cogs, Jutland boatbuilders, and the connection between East and West before AD 1250, in L. Blue, F. Hocker, A. Englert (eds), *Connected by the Sea, Proceedings of the Tenth International Symposium on Boat and Ship Archaeology (ISBSA 10), Roskilde 2003*, Oxford, Oxbow Books, p. 187-194.
- HOCKER F., WARD C. (EDS)  
2004 *The Philosophy of Shipbuilding. Conceptual Approaches to the Study of Wooden Ships*, College Station, Texas A&M University Press.
- HOFFMANN G., HOFFMANN P.  
2009 Sailing the Bremen Cog, *IJNA* 38, p. 281-296.
- HOHEISEL W.-D.  
1994 A full-scale replica of the Hanse cog of 1380, in C. Westerdahl (ed.), *Crossroads in Ancient Shipbuilding, Proceedings of the Sixth International Symposium on Boat and Ship Archaeology (ISBSA 6), Roskilde 1991*, Oxford, Oxbow Books, Oxbow Monograph 40, p. 257-260.
- JENSEN K.  
1999 *Documentation and Analysis of Ancient Ships*, PhD thesis, Centre for Maritime Archaeology and Department of Naval Architecture and Offshore Engineering, Technical University of Denmark.
- JONES T., PANTER I.  
2016 The conservation of the Newport Medieval Ship. Quantifying post-conservation shrinkage and distortion of PEG pre-treated and freeze-dried hull timbers using contact digitisers, in *13<sup>th</sup> ICOM-CC Wet Organic Archaeological Materials (WOAM) Working Conference, Florence 2016*, Preprints, p. 11.
- KIEDEL K.-P., SCHNALL U. (EDS),  
1989 *Die Hanse-Kogge von 1380*, Bremerhaven, Deutsches Schiffahrtsmuseum.
- LAHN W.  
1992 *Die Kogge von Bremen. Band 1, Bauteile und Bauablauf*, Hambourg, Schriften des Deutschen Schiffahrtsmuseums 30.
- L'HOUE M., VEYRAT E.  
1989 A mid-15<sup>th</sup> century clinker boat off the north coast of France, the Aber Wrac'h I wreck: A preliminary report, *IJNA* 18, p. 285-298.
- MARCHAJ C. A.  
1964 *Sailing Theory and Practice*, London, Adlard Coles.
- MCGRAIL S.  
1987 *Ancient Boats in North-West Europe: the Archaeology of Water Transport to AD 1500*, London, Longman Archaeology Series.
- MORCKEN R.  
1980 *Langskip, Knarr og Kogge*, Bergen, Eget forlag.
- SPRINGMANN M.-J., SCHREIER S.  
2008 The Ebersdorfer Cog Model as a basis for a reconstruction of a late medieval sailing vessel, in M.-J. Springmann, H. Wernicke (eds), *Historical Boat and Ship Replicas: Conference Proceedings on the Scientific Perspectives and the Limits of Boat and Ship Replicas, Torgelow 2007*, Friedland, Steffen Verlag, p. 105-116.
- TANNER P.  
2013a 3D Laser Scanning for the Digital Reconstruction and Analysis of a 16<sup>th</sup> century Clinker Built Sailing Vessel, in C. Breen, W. Forsythe (eds), *ACUA Underwater Archaeology Proceedings 2013, SHA Conference Leicester*, Advisory Council for Underwater Archaeology, p. 137-149.  
2013b *Newport Ship Specialist Report: Digital Reconstruction and Analysis of the Newport Ship, Newport Medieval Ship Archive*, York, Archaeological Data Service.  
2017a *The Bremen Cog Reconstructed*, Bremerhaven, German Maritime Museum (Internal Museum Report).  
2017b The Testing and Analysis of Hypothetical Ship Reconstructions, in J. Litwin (ed.), *Baltic and Beyond, Change and Continuity in Shipbuilding, Proceedings of the Fourteenth International Symposium on Boat and Ship Archaeology (ISBSA 14), Gdansk 2015*, Gdansk, National Maritime Museum, p. 171-178.



THIER K.

- 2017 Early Cogs, at Home and Abroad, in J. Litwin (ed.), *Baltic and Beyond, Change and Continuity in Shipbuilding, Proceedings of the Fourteenth International Symposium on Boat and Ship Archaeology (ISBSA 14), Gdansk 2015*, Gdansk, National Maritime Museum, p. 179-185.

VERMEERSCH J., HANECA K.

- 2015 Construction Features of Doel 1, a 14<sup>th</sup>-Century Cog found in Flanders, *IJNA* 44.1, p. 111-131.

VON ARBIN S., DALY A.

- 2012 The Mollö Cog Re-Examined and Re-Evaluated, *IJNA* 41.2, p. 372-389.

WALDUS W., VERWEIJ J., VAN DER VELDE H., VAN HOLK A., VOS S.

- 2019 The IJsselcog project: from excavation to 3D reconstruction, *IJNA* 48.2, p. 466-494.

WESKI T.

- 1999 The IJsselmeer type: some thoughts on Hanseatic cogs, *IJNA* 28, p. 360-379.

WUBS-MROZEWICZ J.

- 2009 Fish, Stock and Barrel. Changes in the Stockfish Trade in Northern Europe, C. 1360-1560, in L. Sicking, D. Abreu-Ferreira (eds), *Beyond the Catch. Fisheries of the North Atlantic, the North Sea and the Baltic, 900-1850*, Leiden, Brill, p. 187-208.

# COMPUTATIONAL FLUID DYNAMICS: FLOATING A DIGITAL BARCODE 02

Sarah FAWSITT and Lin Cecilie HOBBERSTAD

---

## Abstract

Computational fluid dynamics (CFD) is a mathematically based method of simulating fluid. Tank testing and full-scale reconstructions of archaeological boat finds are generally prohibitively expensive for archaeological projects. The aim of this study is to run a hypothetical model of Barcode 02 through a CFD simulation and to find out how useful and usable it could be for maritime archaeologists. CFD is time consuming and requires many iterations to draw concrete conclusions on the sailing ability of a boat model. Experience with nautical engineering, applied mathematics or physics would be an advantage in interpreting the results.

## Keywords

Computational fluid dynamics, digital documentation, maritime archaeology

## Résumé

L'étude de la dynamique des fluides par simulation numérique (CFD) est une méthode mathématique de simulation de fluide. Les tests en bassin de carène et la construction de répliques navigantes sont souvent d'un coût prohibitif pour les projets archéologiques. Le but du projet est d'étudier une hypothèse de restitution de l'épave Barcode 02 à travers une simulation CFD et de découvrir dans quelle mesure cet outil pourrait être utile et accessible pour les archéologues maritimes. Le CFD prend du temps et nécessite de nombreuses itérations pour tirer des conclusions concrètes sur la capacité de navigation d'un modèle de bateau. Posséder une expérience en ingénierie navale, une connaissance des mathématiques appliquées ou de la physique semble un avantage pour interpréter les résultats.

## Mots clés

Dynamique des fluides par simulation numérique, documentation numérique, archéologie maritime

---

The aim of this study was to evaluate the usefulness of computational fluid dynamics (CFD) in analysing archaeological digital boat models. Tangentially it was also a study of the ability of a maritime archaeologist, without a background in advanced mathematics, nautical engineering or physics, to utilise CFD. CFD is a mathematically based method of simulating fluid using a computer. It is utilised in a variety of industries to analyse the movement of fluid. One application for CFD is boat design. Several companies offer the possibility to study the flow of water around a hull and the flow of air around a sail to test the capabilities of said objects. This has obvious advantages for the study of archaeological boat remains, by allowing us to examine a digital model in a computational simulation. As our archaeological boat finds have hull shapes that would not be built, and so never analysed, today we need to carry out testing to understand their abilities, and their loading capacities.

As archaeologists record and digitally preserve more and more boats (Ravn *et al.* 2011, p. 236), the possibility of taking our understanding of ancient boats further without the costs associated with a full-scale reconstruction is tantalising. Physical scale-model testing in tow tanks has been a possibility but such testing is quite expensive, time consuming, and the problems of scale for a small boat model add an extra element of imprecision (Milgram 1997, p. 640; Fassardi 2002). In the event that a full-scale reconstruction is planned and there is some doubt as to the shape of the hull, CFD could be used to analyse differing hypotheses before the building began. However, there is no guarantee that the optimal shape was necessarily the original shape. For seemingly non-optimal

hulls, experiments with loading might show how the ship functioned.

At the Norwegian Maritime Museum we have been digitally documenting boat finds for over a decade. Inspired by Roskilde (Bischoff 2016, p. 21), the Drogheda boat project (Schweitzer 2013, p. 30) and the Newport ship project (Jones 2007, 2008), we have been using FARO arms to digitally draw our boat parts, Rhino 3D to process our drawings, and Orca3D to analyse our hull forms (Bischoff 2016, p. 31; Tully, Tanner 2012). When we learned that Orca3D were teaming up with a CFD provider, Simerics, to analyse boat models, we approached them immediately. Simerics and Orca 3D kindly allowed us to use their simulation for free to analyse our Barcode 02 models.

## 1. BARCODE 02

Between 2008 and 2009, an excavation, necessitated by the construction of a new high-rise development in the area, uncovered 13 shipwrecks in the old harbour of Oslo city (Gundersen 2012, p. 75-80). The largest and most complex of those ships was Barcode 02 (BC02). A model of the ship was constructed in 1:10 scale with 2D and 3D printed pieces made from digitally recorded 1:1 drawings of the boat parts. These drawings were made using FARO documentation in combination with the computer-aided design application software Rhinoceros 5.0 (Rhino 3D). The reconstructed ship contains 21 strakes, 32 rows of frames and is 14.5 m long, 6 m wide and 5.4 m high.



Fig. 1: Reconstruction of Barcode 02: bottom part of the hull in pine, upper part in oak. The ship is 14.5 m long.

The digital model of the boat is based on this physical scale model (fig. 1).

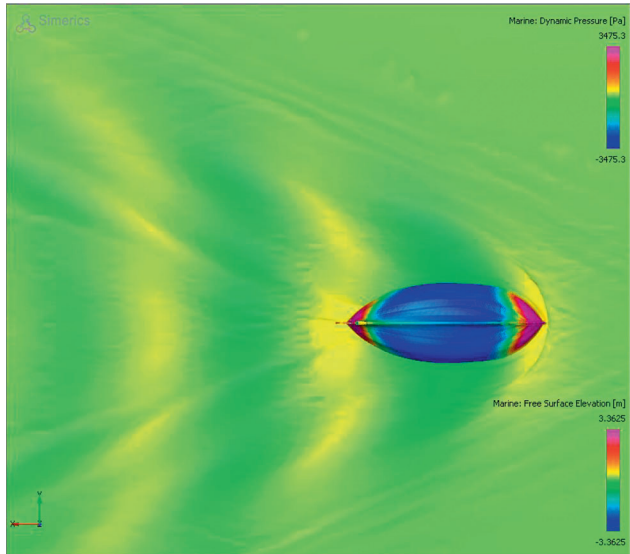
The reason we choose Barcode 02 as a test for CFD is that it existed as two ships. The lower hull including the first 12 strakes and every second frame is made of pine taken from the northern part of the west coast of Norway and was felled in winter 1589/1590 (Kirchhefer 2015). This ship probably worked as a *jekt* carrying dry fish and grain along the west coast of Norway (Christensen 1989, p. 110-122). The rest of the ship is made of oak that was felled somewhere in the southern part of Norway or west coast of Sweden roughly between 1595 and 1602 (Daly 2014). The upper part has a ballast port on the portside and because of this our interpretation is that the ship was rebuilt for shipping timber from the east and south of Norway (Nymoen 2009, p. 105-106). We thought it would be interesting to try to reconstruct both of the ships and see how they act in water by using the CFD.

Unfortunately, we did not have the resources to make a full 1:10 reconstruction of the lower hull. Instead, we adjusted the digital model. Some of the strakes were removed, while others were assigned the density of pine. We removed the foremast, and tipped the mainmast to stand straight. The shape of this

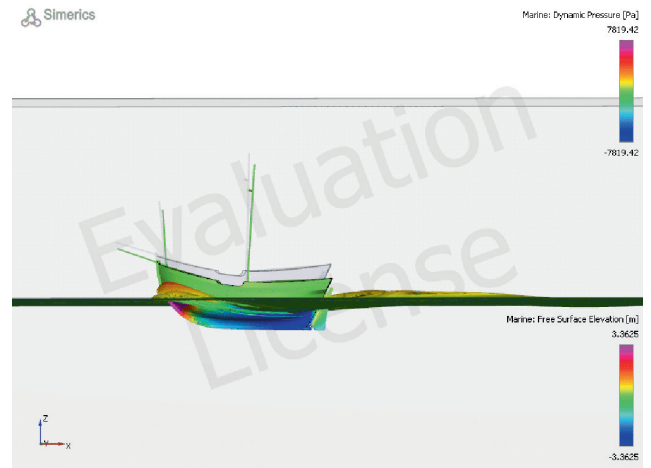
hull will almost certainly not correspond perfectly with the shape of the original *jekt*. Nevertheless, for our purpose as a test for CFD, the digital model in pine will give us a lighter version of the reconstructed rebuilt boat with oak parts, and should act somewhat differently in the water.

## 2. COMPUTATIONAL FLUID DYNAMICS

While CFD itself is complex, the Orca 3D/Simerics simulation is straightforward to use. Each simulation takes about 48 hours to reach completion. Once a model has had a successful hydrostatic analysis in Orca 3D it can be uploaded to the Simerics simulation. This upload function is built into the Orca 3D tabs in Rhino. When uploading the model you can specify which speeds you wish your model to run at. You can also specify whether you would like to run a 'resistance' (drag) test or a 'propulsion' test. The propulsion test was designed primarily with propellers in mind so all of the completed test runs in this paper are the results of resistance tests. You can choose between salt or fresh water. There is also an option to indicate



**Fig. 2:** Plan view of Barcode 02 being dragged through the water in the Simerics CFD simulation: the free surface elevation or wake is visible.



**Fig. 3:** Side view of Barcode 02 being dragged through the water at 12 knots in the Simerics CFD simulation.

that you are analysing a displacement hull. The fluid modelled in the simulation is still water, moved only by the boat being dragged through it.

There are two forms of output from the simulations: animations and graphs. The animations show the dynamic pressure on the hull, the free surface elevation (wake) (fig. 2), the streamlines around the part of the hull that is out of the water, and the flow of water around the hull. Colour gradations display the changes in pressure on the hull and to the height of the waves. The ranges for the output are automatically set but are also adjustable, so if you want to show comparative simulations you can ensure that the ranges match. The graphs (fig. 3) numerically display the heave and pitch of the boat, the effective power, the resistance, and the forward velocity. It is also possible to export the graph data to an Excel file for further comparison. As with the animations, the ranges for the graphs are automatically set, so if you want to show comparative data you must adjust the ranges to ensure they are the same.

The animations provided the most compelling results (fig. 4). It was possible to see the hull in action, cutting through the water. The simulation allows for moving the viewpoint in all directions. With a side view, you can see the waves displaced by the bow of the boat curling along the side of the hull and expelled at the aft end. To evaluate the animation function, we ran simulations at speeds from 3 to 12 knots. There is a method to estimate the top speed of a hull, using the Froude number or speed-length ratio to estimate the number of waves along the length of a hull (Marchaj 1964, p. 250-251) (table 1). For this model, the Froude number of 0.4 and the speed-length ratio of 1.34 are reached at 8.46 knots. In the simulations run

up to 7 knots the waves were mere ripples, but from 8 knots and up the water displaced became more dramatic. At 12 knots, the freeboard was cut in half by the waves formed at the bow of the boat. A side view also shows the boat heaving and pitching and the resultant changes in sinkage and trim that occur at speed. A pale silhouette of the boat shows the model's position before the drag test began. With a view from above or below the boat, it is possible to see the wake that forms as the boat is dragged through the water. It is also possible to zoom in to any area of the hull to see how the dynamic pressure is distributed.

The simulations showed that Barcode 02 moved through the water without creating excessive bow waves up to 7 knots: less waves mean less resistance moving through the water (Manen, Oossanen 1988, p. 15). With 7 knots being the highest speed without this obvious sign of wave-making resistance, we decided to use 7 knots to evaluate the graph output from the simulation. Four models were run through the simulation to provide a basis of comparison. Two of the models were based on what we theorised the original version of Barcode 02 was like. It had a displacement of 4,216 kg: to that a cargo of timber, crew and provisions (25,847 kg) was added, which gave it a displacement of 30,063 kg. Another version of this model was run with an extra 8,000 kg of ballast, giving it an overall displacement of 38,063 kg. The second pair of models was based on Barcode 02 as it had been found, with additional strakes and a deck. It had a displacement of 10,305 kg: to that a cargo of timber, crew and provisions was added (26,167 kg), which gave it a displacement of 36,472 kg. A second version of this model was also run with an extra 8,000 kg of ballast,

**Table 1:** Froude numbers and speed-length ratio for the oak and pine model, with a displacement of 36,472 kgf, run through the Simerics CFD simulation between 3 knts and 12 knts.

| Velocity  | 3knts | 4knts | 5knts | 6knts | 7knts | 8knts | 9knts | 10knts | 11knts | 12knts |
|-----------|-------|-------|-------|-------|-------|-------|-------|--------|--------|--------|
| Fr        | 0.142 | 0.189 | 0.237 | 0.284 | 0.331 | 0.378 | 0.426 | 0.473  | 0.520  | 0.568  |
| SLR ratio | 0.47  | 0.63  | 0.79  | 0.95  | 1.11  | 1.27  | 1.42  | 1.58   | 1.74   | 1.90   |



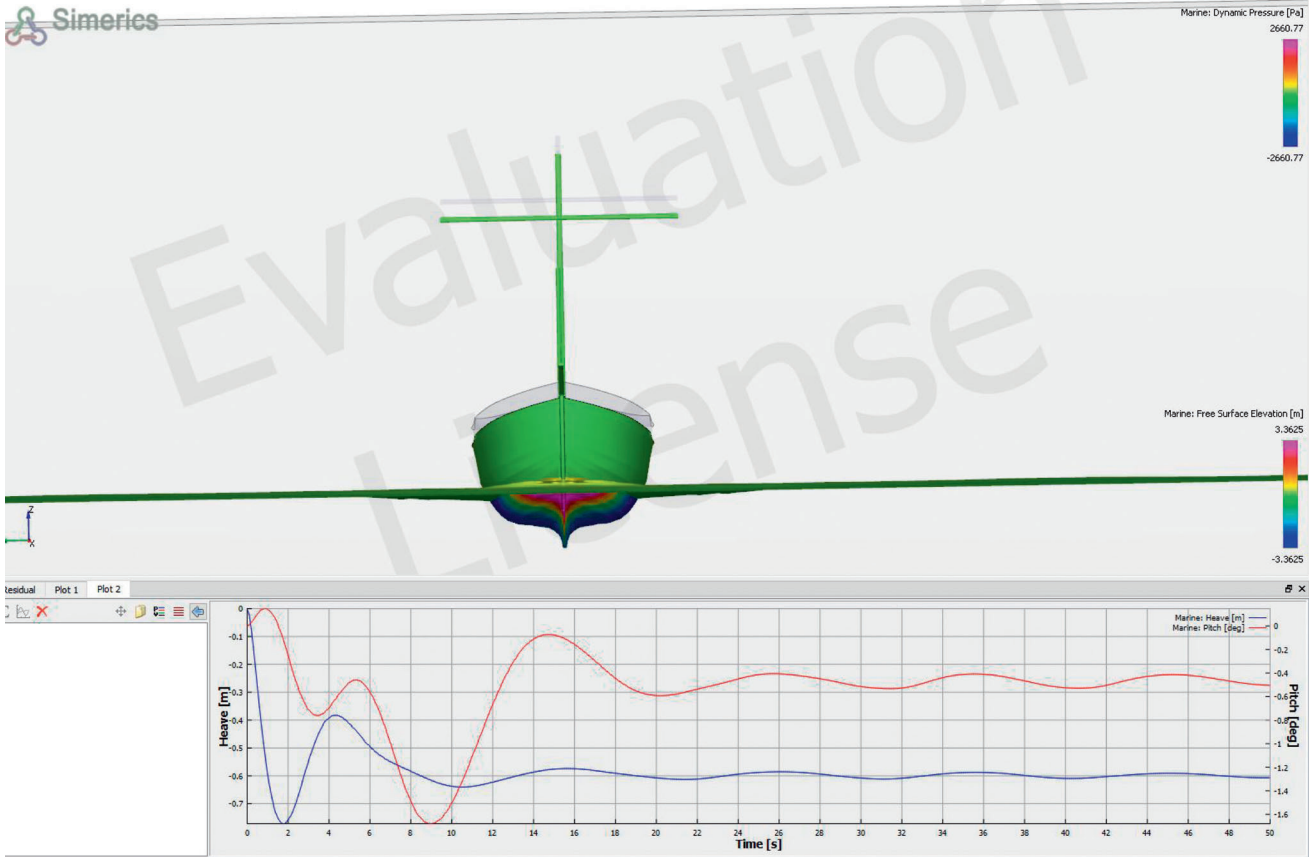


Fig. 4: Example of the Simerics graph output showing heave and pitch.

giving that an overall displacement of 44,472 kg. The mass and geometry of each Barcode 02 model that was run through the simulation can be seen in table 2, here changes to the mass and geometry can be seen with each model. It should be noted that the CFD simulation could only run if the transverse

(T) centre of gravity was manually changed to 0 m. For more thorough analyses of the model, a range of speeds and loadings would have been analysed, but time constraints dictated that only one speed and four loadings could be analysed for this study.

**Table 2:** Mass and geometry of each Barcode 02 model before the CFD simulations were run. The values were calculated using Orca3D.

| Pine model, full loading              |                        |                                  |                        | Displacement                |                        | 30,063.586 kgf         |                       |
|---------------------------------------|------------------------|----------------------------------|------------------------|-----------------------------|------------------------|------------------------|-----------------------|
| Waterplane values                     | Vol. [m <sup>3</sup> ] | Wetted surface [m <sup>2</sup> ] | Overall dimensions [m] | Waterline dimensions [m]    | Hull form coefficients | Centre of buoyancy [m] | Centre of gravity [m] |
| LCF:5.968m                            | 29.305                 | 60.665                           | Loa:13.919             | Lwl:11.946                  | Cb:0.281               | L: 6.037               | L:6.048               |
| TCF:0.012m                            |                        |                                  | Boa: 5.962             | Bwl: 5.1                    | Cp: 0.580              | T: 0.019               | T:0.015               |
| Awp:41.844m <sup>2</sup>              |                        |                                  | D: 4.417               | T: 1.71                     | Cx: 0.485              | V: -0.761              | V:-0.311              |
|                                       |                        |                                  |                        |                             | Cvp:0.410              |                        |                       |
|                                       |                        |                                  |                        |                             | Cwp:0.687              |                        |                       |
| Pine model, full loading, and ballast |                        |                                  |                        | Displacement 38,063.586 kgf |                        |                        |                       |
| Waterplane values                     | Vol. [m <sup>3</sup> ] | Wetted surface [m <sup>2</sup> ] | Overall dimensions [m] | Waterline dimensions [m]    | Hull form coefficients | Centre of buoyancy [m] | Centre of gravity [m] |
| LCF:5.99m                             | 37.103                 | 66.431                           | Loa:13.919             | Lwl:12.154                  | Cb: 0.308              | L:6.142                | L:6.144               |
| TCF:0.011m                            |                        |                                  | Boa: 5.962             | Bwl:5.301                   | Cp: 0.594              | T:0.018                | T:0.017               |
| Awp:44.642m <sup>2</sup>              |                        |                                  | D: 4.417               | T: 1.868                    | Cx: 0.519              | V:-0.653               | V:-0.508              |
|                                       |                        |                                  |                        |                             | Cvp:0.445              |                        |                       |
|                                       |                        |                                  |                        |                             | Cwp:0.693              |                        |                       |

| Oak and pine model, full loading              |                        |                                  |                        | Displacement 36,472.033 kgf<br>36,472.033 kgf |                        |                        |                       |
|---|------------------------|----------------------------------|------------------------|---|------------------------|------------------------|-----------------------|
| Waterplane values                             | Vol. [m <sup>3</sup> ] | Wetted surface [m <sup>2</sup> ] | Overall dimensions [m] | Waterline dimensions [m]                      | Hull form coefficients | Centre of buoyancy [m] | Centre of gravity [m] |
| LCF:6.176m                                    | 35.551                 | 65.414                           | Loa:14.328             | Lwl:12.158                                    | Cb: 0.291              | L:6.236                | L:6.253               |
| TCF:0.018m                                    |                        |                                  | Boa:6.205              | Bwl:5.275                                     | Cp: 0.565              | T:0.023                | T:0.019               |
| Awp:44.355m <sup>2</sup>                      |                        |                                  | D:5.389                | T: 1.865                                      | Cx: 0.505              | V:-1.078               | V:-0.466              |
|   |                        |                                  |                        |   | Cvp:0.430              |                        |                       |
|   |                        |                                  |                        |   | Cwp:0.692              |                        |                       |
| Oak and pine model, full loading, and ballast |                        |                                  |                        | Displacement 44,472.033 kgf<br>44,472.033 kgf |                        |                        |                       |
| Waterplane values                             | Vol. [m <sup>3</sup> ] | Wetted surface [m <sup>2</sup> ] | Overall dimensions [m] | Waterline dimensions [m]                      | Hull form coefficients | Centre of buoyancy [m] | Centre of gravity [m] |
| LCF:5.945m                                    | 43.349                 | 70.843                           | Loa:14.328             | Lwl:12.327                                    | Cb: 0.322              | L:6.101                | L:6.104               |
| TCF:0.013m                                    |                        |                                  | Boa:6.205              | Bwl:5.439                                     | Cp: 0.602              | T:0.021                | T:0.018               |
| Awp:46.729m <sup>2</sup>                      |                        |                                  | D:5.389                | T: 2.007                                      | Cx: 0.535              | V:-0.569               | V:-0.299              |
|   |                        |                                  |                        |   | Cvp:0.462              |                        |                       |
|   |                        |                                  |                        |   | Cwp:0.697              |                        |                       |

The results from these runs are visible in table 3. The results were at times counterintuitive. It was the lighter boat that seemed to struggle the most with higher resistance and more energy required to move the boat. The sinkage was also greatest for the boat with only the second highest displacement. It is at this stage of the process that having a background in naval architecture or physics might provide a clearer understanding of the contributing factors and implications of these results. The graphs show the dynamic sinkage and trim of the models: that

is the sinkage and trim that occurred as the boat was dragged through the water. The results for the sinkage are found in the heave graph and the results for trim are found in the pitch graph. The four models had a sinkage of between 38.42 cm and 60.01 cm. The trim varied between 0.19 degrees with the bow lower in the water to 0.45 degrees with the stern lower in the water. It is probably these variations in the centre of gravity, sinkage and trim that have resulted in the oak and pine boats dealing with less resistance and needing less effective power to move.

**Table 3:** Data output from computational fluid dynamics analysis of four versions of the Barcode 02 digital model.

| Pine model, full loading                      |                      |               |                 | Displacement 30,063.586 kgf  |                      |                    |                               |                      |
|---|----------------------|---------------|-----------------|------------------------------|----------------------|--------------------|-------------------------------|----------------------|
| Forward velocity [knot]                       | Dynamic sinkage [cm] | Heave up [cm] | Heave down [cm] | Dynamic trim by bow [deg]    | Pitch by stern [deg] | Pitch by bow [deg] | Effective power (EHP) [N-m/s] | Total resistance [N] |
| 7.00  | - 38.42              | 0.06          | - 0.11          | 0.19                         | - 0.01               | 0.01               | 12366.40                      | 3434.05              |
| Pine model, full loading, and ballast         |                      |               |                 | Displacement 38,063.586 kgf  |                      |                    |                               |                      |
| Forward velocity [knot]                       | Dynamic sinkage [cm] | Heave up [cm] | Heave down [cm] | Dynamic trim unchanged [deg] | Pitch by stern [deg] | Pitch by bow [deg] | Effective power (EHP) [N-m/s] | Total resistance [N] |
| 7.00  | - 59.03              | 0.19          | - 0.26          | 0                            | - 0.01               | 0.02               | 13796.90                      | 3831.30              |
| Oak and pine model, full loading              |                      |               |                 | Displacement 36,472.033 kgf  |                      |                    |                               |                      |
| Forward velocity [knot]                       | Dynamic sinkage [cm] | Heave up [cm] | Heave down [cm] | Dynamic trim by stern [deg]  | Pitch by stern [deg] | Pitch by bow [deg] | Effective power (EHP) [N-m/s] | Total resistance [N] |
| 7.00  | - 60.01              | 0.26          | - 0.26          | - 0.45                       | - 0.03               | 0.02               | 9963.45                       | 2766.77              |
| Oak and pine model, full loading, and ballast |                      |               |                 |                              |                      |                    |                               |                      |
| Forward velocity [knot]                       | Dynamic sinkage [cm] | Heave up [cm] | Heave down [cm] | Dynamic trim by stern [deg]  | Pitch by stern [deg] | Pitch by bow [deg] | Effective power (EHP) [N-m/s] | Total resistance [N] |
| 7.00  | - 44.41              | 0.42          | - 0.56          | - 0.21                       | - 0.04               | 0.03               | 10827.30                      | 3006.66              |

### 3. REFLECTIONS ON USING CFD

Using CFD is a time consuming endeavour. Not only because each run takes 48 hours but also due to the amount of runs that must occur to get a full picture of the capabilities of any one boat. It is essential to make a detailed plan in advance. Plan what speeds you intend to run. Make a plan to incrementally change the trim of the boat. Establishing what range of trim you will test is probably faster to start in Orca 3D. There you can

experiment to establish a range that Orca 3D calculates as stable. Record the initial trim of the boat and the resultant dynamic trim of the boat. Record the initial freeboard of the boat and the resultant freeboard due to the dynamic sinkage of the boat. Keep all related data together, weight cost reports and stability reports from Orca 3D, videos and graphs from Simerics. Decide on a range for your videos and graphs in advance so that everything is easily comparable. Make a video of at least a side view and a plan view for each run. All of this

information should be combined to give a full and rounded report on the testing of a boat.

The CFD study has shown the resistance and dynamic pressure exerted on the hull at 7 knots, which raises the possibility that the rebuild added to the sailing capabilities of Barcode 02. These changes in resistance are probably a result of the change in sinkage, trim and waterline length. The sinkage also shows the depth limitations the sailors of Barcode 02 would have to take into account, as well as the freeboard should it be carrying a heavy load.

There is other information we could find out about Barcode 02. Computational fluid dynamics offers an array of possibilities for the study of boats. Even within the Simerics simulation, there were aspects of analysis not included in this study. There is a possibility of studying yaw angles. There is also, theoretically, a way to move the force of propulsion into the sails. Other CFD simulations analyse the capabilities of sails and the ability of boats to move through and with waves. The use of CFD to study any archaeological boat would be interesting but a library of results from all of the digitally recorded boats would yield a

wealth of information. It would give us a more in-depth understanding of the capabilities of ships from different eras. In so doing, we would have one more, small, piece of the puzzle that is trying understanding the past through material objects.

## 4. CONCLUSION

Due to time constraints, this is a rough study of the use of CFD to analyse digitally recorded archaeological ship finds. More simulations are needed with different loadings and speeds to attain a clearer picture of the Barcode 02 models. While the results here pertaining to Barcode 02 are not conclusive, CFD shows one way forward in how we can interpret our ship finds. Computational fluid dynamics is complex in and of itself, but CFD is an accessible tool. While a background in engineering or physics would be helpful, results are attainable for anyone. Interpreting the results and extrapolating meaning from them is a subject that requires more examination.

## REFERENCES

- BISCHOFF V.  
2016 Application of 3D digital methods in the documentation, reconstruction and dissemination of archaeological ship finds, in *Why 3D? Challenges and Solutions with the use of 3D Visualisations in Cultural History Disciplines, Proceedings of the seminar, Department of Archaeology, Aarhus University, Moesgård 2014*, Faaborgs, Øhavsmuseet Faaborgs Forlag, p. 21-36.
- CHRISTENSEN A. E.  
1989 Jekta som fartøystype. Opprinnelse og eldste utvikling, in O. L'Orange (ed.), *Kulturminner i Nord-Trøndelag III. Jekter og jektefart fra innherred*, Nord-Trøndelag historielag, Steinkjer Bokhandel A/S, p. 110-122.
- DALY A.  
2014 Dendrocronological analysis of timber from Barcode ship 2, *Barcode, Oslo, Dendro.dk Report 32*; Copenhagen.
- FASSARDI C.  
2002 Tank Testing and Data Analysis Techniques for the Assessment of Sailboat Hydrodynamic Characteristics, in *High Performance Yacht Design Conference, Auckland 2002* (<http://vm2330.sgyps.net/~syrfest/images/library/20150702141832.pdf>).
- GUNDERSEN J.  
2012 Barcode Project: Fifteen Nordic Clinker-Built Boats from the 16<sup>th</sup> and 17<sup>th</sup> Centuries in the City Centre of Oslo Norway, in N. Günsenin (ed.), *Between Continents, Proceedings of the Twelfth Symposium on Boat and Ship Archaeology (ISBSA 12), Istanbul 2009*, Istanbul, Ege Yayinlari, p. 75-80.
- JONES T.  
2007 *The Newport Medieval Ship: Timber Recording Manual: Digital Recording of Ship Timbers, Using a FaroArm 3D Digitiser and Rhinoceros 3D software*, Newport, Newport Medieval Ship Project, p. 1-33.  
2008 *The Newport Medieval Ship: Timber Recording Manual: Digital Recording of Ship Timbers, Using a FaroArm 3D Digitiser and Rhinoceros 3D software*, Newport, Newport Medieval Ship Project, Supplement 21, p. 34-49.
- KIRCHHEFER A.J.  
2015 Dendrokronologisk datering av deler av et skipsvrak fra Bjørnvika i Oslo, *Barcode 11-12. Rapport 16/2015*, Tromsø, p. 1-11 (unpublished report).
- MANEN VAN J. D., OOSSANEN VAN P.  
1988 Resistance, propulsion and vibration, in E. V. Lewis (ed.), *Principles of Naval Architecture*, vol. II, 2<sup>nd</sup> revision, 3<sup>rd</sup> edition, Jersey City, NJ, The Society of Naval Architects and Marine Engineers, p. 11-135.
- MARCHAJ C. A.  
1964 *Sailing theory and practice*, New York, Dodd, Mead & Company.
- MILGRAM J.  
1997 Hydrodynamics in Advanced Sailing Design, in *Twenty-First Symposium on Naval Hydrodynamics 1997*, Washington DC, The National Academic Press, p. 635-660 (<https://www.nap.edu/read/5870/chapter/1#iii>)
- NYMOEN P.  
2009 Marginale steder eller marginale kilder? Undervannsarkeologisk blikk på små landshavner, in Brendalsmo J., Eliassen F.-E., Gansum T. (eds), *Den urbane underskog. Strandsteder, utvekslingssteder og småbyer i vikingtid, middelalder og tidlig nytid*, Oslo, Novus, p. 94-131.
- RAVN M., BISCHOFF V., ENGLERT A., NIELSEN S.  
2011 Recent Advances in Post-excavation Documentation, Reconstruction, and Experimental Maritime Archaeology, in A. Catsambis, B. Ford, D. L. Hamilton (eds), *The Oxford Handbook of Maritime Archaeology*, Oxford, Oxford University Press, p. 232-249.
- SCHWEITZER H.  
2013 *The Drogheda Boat and Clinker boats of the Renaissance on Europe's western seaboard*, PhD thesis, University of Southern Denmark (<https://avxhm.se/ebooks/DroghedaBoat.html>).
- TULLY D., TANNER P.  
2012 3D Laser Scanning in Boat Recording, *Nautical Archaeological Society Newsletter*, p. 3.

# MASS DOCUMENTATION OF ARCHAEOLOGICAL SHIP TIMBERS: INTRODUCING A NOVEL, TIME-EFFICIENT APPROACH

Thomas VAN DAMME, Massimiliano DITTA and Jens AUER

---

## Abstract

This article introduces the annotated scans method as a new approach to ship timber recording. The proposed method consists of several phases: timbers are first scanned in 3D, these scans are then annotated in Rhino, and finally the timber catalogue is generated using a semi-automated workflow. We compare this approach to the current best practice method for timber recording, namely contact digitising. Based on our experience recording the timbers of the Wismar 'Big Ship', we conclude that the proposed method matches, and in some regards surpasses the current best practice method, most notably in terms of cost and time efficiency.

## Keywords

Annotated scans, Artec, timber recording

## Résumé

Cet article présente la méthode de numérisations annotées comme nouvelle approche de l'enregistrement des pièces de bois de navires. La méthode proposée comprend plusieurs phases: les bois sont d'abord scannés en 3D; ces numérisations sont ensuite annotées dans le logiciel Rhino; enfin, le catalogue de bois est généré à l'aide d'un processus semi-automatisé. Nous souhaitons comparer cette approche à la méthode privilégiée actuellement pour l'enregistrement des bois, à savoir la numérisation par palpement. Sur la base de notre expérience d'enregistrement des bois du « Big Ship » de Wismar, nous concluons que la méthode proposée égale, et à certains égards surpasse la méthode par palpement, notamment en termes de coût et de temps.

## Mots-clés

Numérisations annotées, Artec, enregistrement de bois

---

Every year maritime archaeologists around the globe are faced with the daunting task of having to record, interpret and publish hundreds if not thousands of individual ship timbers. After *in situ* documentation entire wooden wrecks are frequently disassembled, recovered and subsequently recorded frame by frame, plank by plank, before either being conserved, stored or discarded. This in-depth study of individual timbers is often crucial to understanding a ship's construction, and the resulting timber catalogue serves as a final, detailed visual record of the vessel's numerous individual elements.

Current methods for timber recording, be they digital or analogue, 3D or 2D, are generally quite accurate and detailed, but unfortunately also very time consuming. In practice the recording of a single wreck may take many months and in some cases years to complete. On time-critical projects with large quantities of timbers, such as many development-led excavations, these methods are therefore often simply untenable.

In this paper we present a novel approach to timber recording which addresses this issue. We begin by briefly outlining our use case and recording objectives. Next, we evaluate whether the current best practice method for timber recording, namely contact digitising, fulfils these objectives. We then present our proposed methodology and conclude by comparing the outcomes of both methods.

## 1. BACKGROUND AND RECORDING OBJECTIVES

Different facets of our proposed methodology were gradually refined between 2015 and 2018 over the course of seven development-led shipwreck documentation projects. The studied shipwrecks include the 15<sup>th</sup>-century IJssel cog, punt and barge wrecks excavated by archaeology company ADC ArcheoProjecten in the River IJssel in the Netherlands (Van Damme 2018) and two 18<sup>th</sup>-century shipwrecks excavated by the Landesamt für Kultur-und Denkmalpflege (LAKD) Mecklenburg-Vorpommern in the Bay of Greifswald in northern Germany (Auer *et al.* 2018 and Auer in this volume).

In this paper, we will focus on the most recent implementation of the methodology, as used on the Wismar Big Ship project (Ditta, Auer in this volume). The 12<sup>th</sup>-century Wismar Big Ship measures 19.8 by 5.3 m and was excavated by the LAKD in the harbour of Wismar in the winter of 2017. After excavation, a total of 240 diagnostic timber elements were selected to be recorded using our methodology: 106 two-sided timbers (or parts thereof) and 134 four-sided elements.

Despite the development-led nature of these projects, the intention was to adhere to quite demanding standards in terms of timber recording. Specifically, the recording objectives were: a) to be accurate, detailed and three-dimensional; b) to allow for 3D printing of the ship timbers and 3D modelling of the wreck; c) to allow for the creation of a 2D timber catalogue for final publication; and d) to be time- and cost-efficient.



## 2. CURRENT BEST PRACTICE: CONTACT DIGITISING

### 2.1. METHOD OVERVIEW

Whereas traditionally ship timbers have been recorded in 2D using scaled drawings or full-sized tracings, over the past 15 years 3D contact digitising has gradually emerged as the best practice method for ship timber recording. Contact digitising involves tracing all significant features and outlines of a timber using the pen of a coordinate measuring device, which tracks and records the precise 3D location of the penpoint, generally to sub-millimetre accuracy. Typically the traced 3D coordinates are recorded in real time as 3D polyline wireframes in the 3D CAD software Rhino, with different layers in Rhino representing different feature types. The best-known and most widely used tool for this approach is the FaroArm, though other coordinate measuring devices such as the wireless Creaform HandyPROBE have also been used (Jones 2015).

Within the field of maritime archaeology the FaroArm was first used at Mystic Seaport in the US in the mid-1990s to record ship's models (Starr 1996). For timber recording, use of the FaroArm and Rhino 3D was pioneered by the National Museum of Denmark in 2001 to record 56 timbers of the Kolding cog (Hocker 2003; Jones 2015, p. 143-147). Since then the approach has seen widespread adoption on numerous shipwreck projects, mainly in Europe and Turkey, including the Roskilde wrecks, the Newport ship, the Drogheda boat, the Doel cog project, several of the Yenikapı shipwrecks and Arles-Rhône 3 (Jones 2015, p. 264-282; Kocabas 2015; Lenaerts *et al.* 2011; Marlier *et al.* 2017; Schweitzer 2012).

### 2.2. ASSESSMENT

Compared to traditional 2D recording methods, contact digitising presents a clear step forwards in terms of accuracy, while simultaneously producing a full three-dimensional record of each timber. By using similar layering conventions in Rhino, the digital 3D timber files can easily be understood at a glance by researchers on different projects. Three-dimensional layers can be switched on or off to create 2D views of each face of a timber for publication, and more importantly, the 3D polyline wireframes can be modelled into 3D solids. This allows researchers to reassemble the wrecks digitally in CAD software, or to 3D print the timbers and reassemble them physically. As such, contact digitising meets our three first recording objectives: a) it is accurate, detailed and three-dimensional; b) it allows for 3D printing and 3D modelling; and c) it allows for the creation of a 2D timber catalogue.

The final question then is: d) is contact digitising also time- and cost-efficient? A first factor impacting cost-efficiency is the cost of the recording hardware. While prices vary depending on the model chosen, on average a new FaroArm retails at around €30,000 (Toby Jones, personal communication). The second and most significant factor influencing cost-efficiency is time-expenditure: the more time is needed to record the timbers, the more money will be spent on staff wages and other project operating costs, such as location rental and staff accommodation. In order to get an estimate for time-expenditure, we base ourselves on figures reported by Toby Jones for contact

digitising on the Newport ship project, which is considered to be one of the most efficient implementations of this methodology. Jones has estimated that, on average, a FaroArm user with at least one month of experience would need about four hours to record a plank and six hours to record a frame. In addition, once the timbers had been recorded, converting the 3D polyline wireframes into 3D solids for CAD modelling or 3D printing required, on average, a further two hours per timber (Toby Jones, personal communication).

Based on these estimates, assuming we were able to hire an experienced FaroArm user (and supporting staff to clean, photograph and make written descriptions of the timbers) working ten hours per day, contact digitising of 106 two-sided timbers and 134 four-sided timbers on the Wismar Big Ship project would have taken roughly 123 days to complete, or an average of about two timbers recorded per day. Since in this approach the main bottleneck is the hardware itself, the only way to speed up recording would be to purchase additional FaroArms, which, as we have seen above, are rather costly. Finally, after recording, an additional 480 labour hours would be needed to convert the 3D polylines into digital solids for 3D printing and modelling.

Now consider the following: on the Wismar Big Ship project, the actual underwater excavation and underwater recording of the wreck, as well as mobilisation, demobilisation and timber transport, took a team of six archaeologists working eight hours per day a mere 32 days to complete. As such, it seems that for most development-led projects the added scientific value of recording all timbers using contact digitising is simply not proportional to the added time-expenditure and project costs associated with this method. This likely explains why in maritime archaeology contact digitising, despite being considered the best practice method for timber recording, has so far remained inaccessible to all but the best-funded research projects, or projects relying on free volunteer or intern labour, with access to free or low-cost lent-out contact digitisers. Unfortunately, the method is simply too slow and therefore too costly for most short-term development-led projects.

## 3. PROPOSED METHOD: ANNOTATED SCANS

### 3.1. METHOD OVERVIEW

The timber recording methodology we propose consists of several phases. After cleaning, timbers are first scanned in 3D. In practice, a wide range of 3D scanning methods can be used to make the timber scans: in the case of the Wismar Big Ship project, we opted to use an Artec Eva 3D scanner. After processing, the resulting scans are then imported into the CAD software Rhino 3D, where the timbers' various important features are annotated directly onto the timber's digital copy. Finally, scaled 2D technical line drawings and textured renders of all faces of each timber are then exported from Rhino using an automated workflow, in order to produce the wreck's timber catalogue.

#### 3.1.1. Timber scanning and processing

The Artec Eva is a handheld structured-light 3D scanner which records both object geometry and texture (colour). Prior to scanning, several factors must be taken into consideration.

In order to avoid interference with the structured-light system, scanning should be carried out indoors, out of direct sunlight. Reflections can likewise lead to errors, so after cleaning, timber surfaces should be blotted dry with a towel. Finally, the scanner tracks its location using both geometry and texture information, so it is advised to place the timbers on a surface that contains both distinctive geometry and texture features: in our case, simple wooden pallets proved to be an ideal background for scanning.

In general, the workflow then consists of making several overlapping scans of each timber, and subsequently combining these scans into a single model using the Artec Studio software. During recording, the Eva was connected to a laptop, thereby allowing the researchers to move freely around the timber, and to see the 3D model being captured in real time on the computer screen (fig. 1). Sturdy four-sided timbers are the easiest to record: they can be placed directly on the pallets and recorded in two scans, one per side. Flexible planks with thin edges are more problematic: they may change shape when turned over, and their edges provide little overlap between the inboard and outboard scans. In order to overcome this, pins can be inserted along the edges of the plank to provide stable reference points between two scans, or the planks can be suspended above the recording surface (through staves inserted in treenail holes), allowing the plank to be recorded in a single scan (fig. 2).

While one person was scanning, another person was responsible for timber processing on a custom-built PC: this parallel workflow allowed us to avoid waiting times between tasks. In terms of processing, in Artec Studio the background of each scan is first removed. The individual scans are then aligned, either automatically or manually using reference points. Following successful alignment, the 'Global Registration' command is used to optimize the alignment of the individual scans and to combine them into a single model of the timber. After removing noise and unwanted objects from the scan, the 'Sharp Fusion' command is used to create a watertight mesh, which is then simplified and textured.

### 3.1.2. Timber annotation

The resulting textured mesh is an objective digital 3D *reproduction* of the physical timber, but as archaeologists we need to go one step further and actually *interpret* the timber. To do this,



**Fig. 1:** Timber scanning setup using the Artec Eva structured-light 3D scanner (photograph T. Van Damme).



**Fig. 2:** Generally, planks will bend slightly when turned over, meaning that the 3D geometry of the plank changes in between two scans. This may lead to reconstruction errors when merging the outboard and inboard scans of a plank. In order to avoid this issue, planks can be suspended above the recording surface, thereby allowing the user to record the entire plank in a single scan (photograph J. Auer).

we first save the textured mesh in OBJ format and import it into Rhino 3D. In Rhino, we use a layering convention similar to that used for contact digitising, with different layers representing different feature types such as wood grain, treenails, nails, repairs, tool marks and intentional markings. Whereas with contact digitising these features are physically traced using the pen of a coordinate measuring device, in our approach the features are traced digitally using Rhino's 'PolylineOnMesh' command, which allows users to draw 3D polylines directly onto the textured mesh (fig. 3). During this annotation process we keep the physical timber next to us, and researchers go back and forth between examining the physical timber and then tracing all significant features onto the timber's digital copy. A notable difference with contact digitising is that we do not need to trace all the timber's edges, since these are already stored in the mesh geometry. In addition to tracing all significant features, we also produce cross sections of the timbers at intervals using the 'Section' command, and we draw polylines connecting treenail ends in order to show the direction in which treenails are inserted. Finally, during this annotation phase researchers also make a written description of the timber and take detail pictures of important features.

### 3.1.3. Producing the timber catalogue

In order to produce a 2D timber catalogue entry for each timber, we take advantage of Rhino's various 'Drafting/Layout' and 'Rendering' tools. Using the 'Drafting/Layout' tool we create standard templates for the timber catalogue, in which each face of the timber (two faces for planks, four faces for frames) is automatically shown at scale 1:10 on a (digital) sheet of paper ranging in size from A4 to A0 (depending on the size of the timber). After creating several standard layout templates, the user simply has to place the timber in the right position in 3D space in Rhino and choose the most appropriate template for any given timber. The scaled timber drawings are then exported in PDF format both as 'Technical' and 'Rendered' views. The 'Technical' render automatically converts the mesh into a line drawing in which timber outlines and geometric edges are shown in black, and the traced features are shown in

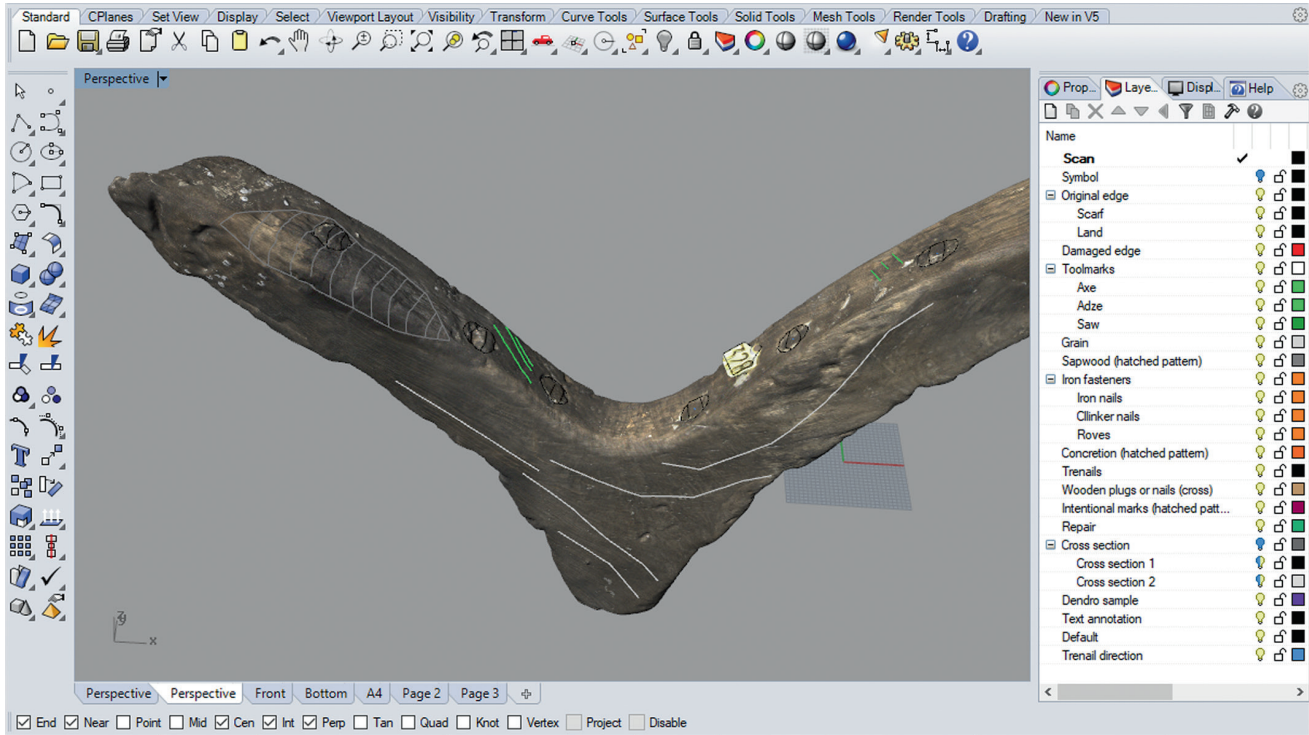


Fig. 3: Rhino 3D screenshot, showing timber features traced on the textured mesh as 3D polylines (left) and Rhino layers representing different feature types (right).

different colours corresponding to the layers on which the features were traced. The 'Rendered' view shows a full colour render of the textured mesh (fig. 4).

### 3.2. ASSESSMENT

The level of accuracy and detail of the Annotated Scans Method will depend largely on the 3D scanning method used to produce the original timber scans. The Artec Eva used in our case study has a stated accuracy of up to 0.1 mm, and a resolution of up to 0.5 mm (Artec 2019). Given that traditional ship-builders likely were not working at sub-millimetre levels of precision, this should be more than enough for most maritime archaeological applications. Since the result of the initial scanning phase is a textured mesh of each timber, these 3D solids could immediately be used for 3D modelling and printing. On the Wismar Big Ship project, a preliminary CAD model assembly of the wreck's framing timbers was produced on the fly as new scans were processed, and after scanning was completed, all timbers were 3D printed at scale 1:20 and reassembled using metal wire. The resulting model was again scanned in 3D and a tentative CAD reconstruction of the original vessel was made (Ditta, Auer in this volume). By annotating the meshes in 3D in Rhino we were able not only to record but also interpret the ship timbers, and Rhino's 'Drafting/Layout' tools proved invaluable in order to automatically produce 2D timber catalogue entries of all faces of each timber. As such, the annotated scans method meets our three first recording objectives: a) it is accurate, detailed and three-dimensional; b) it allows for 3D printing and 3D modelling; and c) it allows for the creation of a 2D timber catalogue.

Once again, the final question then is: d) is the method also time- and cost-efficient? In terms of hardware, the most significant cost is the 3D scanner. At the time of writing, a new Artec Eva costs either € 12,330 or € 13,700, depending on whether the user qualifies for an educational discount (Artec 2019). However, as discussed above, by far the most important factor determining the cost of a project is time-expenditure. Using the annotated scans method, on the Wismar Big Ship project a team of four people equipped with a single Artec Eva scanner, working ten hours a day, were able to clean, scan, annotate, photograph and describe 240 timber elements in a mere 37 days. This adds up to an average of 6.5 timbers per day. Interestingly, one or two people scanning and processing timber scans were able to complete eight to ten timber scans a day, meaning that in our approach the main bottleneck was not the scanning hardware itself, but rather the speed at which the other researchers could subsequently annotate and describe the timbers. Since the final output of the scanning phase is a textured mesh, no additional manual work was required to convert our scans into digital solids for 3D modelling and printing. Finally, after recording was completed, it took a single person ten days to produce a detailed timber catalogue of all 240 timber elements.

It should be noted that the Wismar Big Ship project had several advantages. Firstly, three out of four team members had prior experience with the Artec Eva scanner and the annotated scans method while working on the shipwrecks excavated in the Bay of Greifswald the year before. Secondly, the team was highly qualified in terms of general 3D scanning experience and know-how, meaning that workflows could quickly be adapted to overcome the challenges that inevitably come up while scanning timbers. A less experienced team



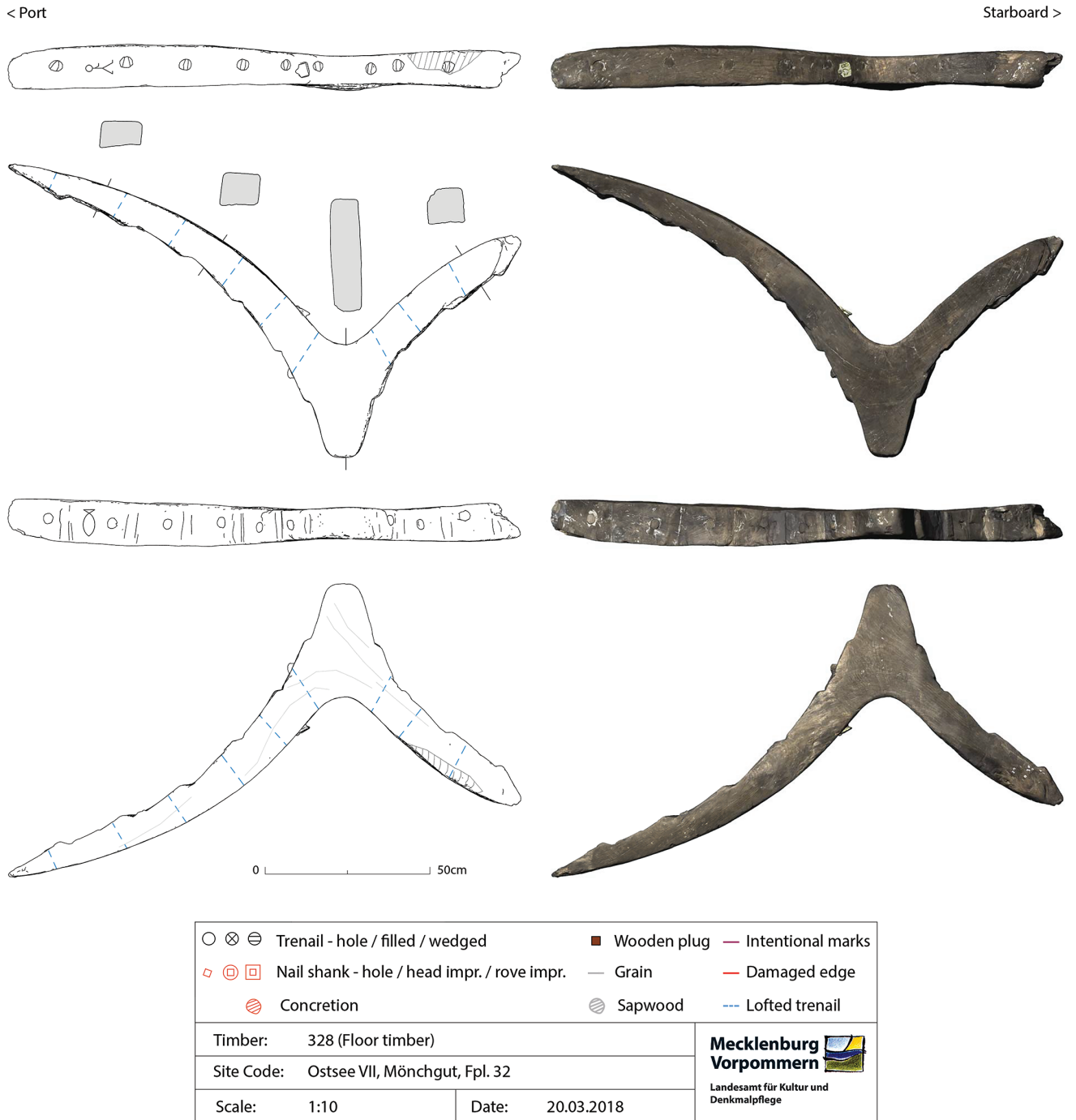


Fig. 4: Example of a four-sided timber catalogue entry, showing both the 'Technical' view (left) and 'Rendered' view (right).

would likely have hit more obstacles over the course of the project, resulting in significantly longer scanning times. Nevertheless, the project also suffered several setbacks: our Artec Eva scanner was faulty for two weeks, resulting in significantly longer processing times; two team members were sick for a week; and at one point the workplace flooded, which resulted in a day lost to cleaning. As such our case study does not represent the “best case scenario”, and we are confident that we can further improve on time-efficiency in future projects.

#### 4. CONCLUSION

The annotated scans method matches, and in several regards surpasses, the current best practice method for timber recording. Firstly, whereas contact digitising only stores the information considered important by the researcher at the time of recording, our method results in an objective digital copy of every geometric and colour detail visible on the original timber (the textured mesh), which is then



supplemented by the archaeologists' interpretation of the timber during the annotation phase. Secondly, in contrast to the simplified 3D solids produced with contact digitising, the 3D scans made using our method contain significantly more geometric detail, resulting in more accurate models for 3D

printing or CAD modelling. Most importantly, however, the annotated scans method is considerably more cost-efficient than contact digitising, thanks in part to reliance on cheaper hardware, but mostly due to substantial reductions in time-expenditure.

## REFERENCES

- ARTEC  
2019 *Artec Eva*, <https://www.artec3d.com/portable-3d-scanners/artec-eva>, accessed 31/05/2019.
- AUER J., GRABOWSKI M., VAN DAMME T.  
2018 *Excavation and recovery of wrecks Ostsee Bereich VII, Mönchgut Fpl. 63 (7070) and Fpl. 64 (7071) and in situ protection of wreck Fpl. 65 (7072)*, *Archaeological Diving Operation*, Schwerin, Landesamt für Kultur und Denkmalpflege Mecklenburg-Vorpommern.
- HOCKER F.  
2003 *Faro Manual V.2*, Copenhagen, National Museum of Denmark.
- JONES T.  
2015 *Three-Dimensional Digital Recording and Modelling Methodologies for Documentation and Reconstruction of the Newport Medieval Ship*, Newport, University of Wales Trinity Saint David.
- KOCABAŞ U.  
2015 The Yenikapı Byzantine-Era Shipwrecks, Istanbul, Turkey: a preliminary report and inventory of the 27 wrecks studied by Istanbul University, *IJNA* 44.1, p. 5-38.
- LENAERTS T., VERMEERSCH J., HANECA K., DEFORCE K., VAN CAMP L., SEURINICK J., RIJMENANTS S., DE BIE M.  
2011 *Kogge Rapportage 1: Internal Report on the Doel Kogge*, Antwerp, Flemish Heritage Institute and Archeologische Dienst Waasland.
- MARLIER S., POVEDA P., RANCHIN N.  
2017 The Arles-Rhône 3 project: From the excavation and raising of a Gallo-Roman barge, in the southern coastal French city of Arles, to its documentation and modelling in 3D (2011-2012), in J. Gawronski, A. van Holk, J. Schokkenbroek (eds), *Ships and Maritime Landscapes. Proceedings of the Thirteenth International Symposium on Boat and Ship Archaeology, ISBSA 13, Amsterdam 2012*, Amsterdam, Barkhuis Publishing, p. 383-389.
- SCHWEITZER H.  
2012 Drogheda Boat: A Story to Tell, in N. Günsenin (ed.), *Between Continents. Proceedings of the Twelfth International Symposium on Boat and Ship Archaeology (ISBSA 12), Istanbul 2009*, Istanbul, Ege Yayınları, p. 225-231.
- STARR M.  
1996 Measuring Mystic Seaport's Half-Model Collection the Electronic Way, *The Log of Mystic Seaport* 48, p. 69-72.
- VAN DAMME T.  
2018 3D-fotogrammetrie, in W.B. Waldus (ed.), *De opgraving en lichting van de 15<sup>e</sup>-eeuwse IJsselkogge*, Amersfoort, ADC ArchoProjecten, p. 87-93.

# ARTISTIC AND SYMBOLIC ELEMENTS OF THE MALTESE *LUZZU*

Efthymia AKRIVOPOULOU and Irene MUÑOZ

## Abstract

Almost in the centre of the Mediterranean Sea, the Maltese islands provide harbours for various types of traditional fishing boat. One of these types, and the focus of this research, is the *luzzu*. Decorated with different colours and symbols, the once prominent *luzzu* is today found in only a few harbours. Using *in situ* research, these boats were studied to understand how the symbolism of their decorations might have changed throughout the years.

## Keywords

Colour symbolism, *luzzu*, Malta, nautical ethnography, *oculi*

## Résumé

Situé au centre de la mer Méditerranée, l'archipel maltais offre une multitude de ports pour divers types de bateaux de pêche traditionnels. L'une de ces embarcations, objet de cette recherche, est le *luzzu*. Décoré de nombreuses couleurs et de symboles variés, le *luzzu* autrefois très courant ne se trouve plus aujourd'hui que dans quelques ports. Par le biais de recherches effectuées sur le terrain, ces bateaux ont été étudiés pour percevoir comment le symbolisme de leurs décorations a pu évoluer au fil des ans.

## Mots-clés

Symbolisme des couleurs, *luzzu*, Malte, ethnographie navale, *oculi*

This short contribution aims to present and understand the meaning of colours and symbols of the *luzzijet* (singular *luzzu*), a type of traditional fishing boat found in the archipelago of Malta (fig. 1). It probably evolved from the *gozzo*, an Italian boat that was regularly seen off the Maltese coast around the 19<sup>th</sup> century. The *luzzu*, usually between 9 ft and 25 ft (2.7 m and 7.6 m) in length, superseded other traditional Maltese boats due to its strong construction. It is a double-ended, carvel-built open boat with a stern rudder, a false keel and extra planking at the bilge for extra framework support and protection while beaching. Originally, it was propelled by oars, later developments added sails (spritsail and jib) and nowadays engines power the boats (Muscat 1999, p. 94-98).

Our initial approach was to use first-hand knowledge derived from personal communication with Maltese fishermen, owners and shipwrights, but that proved impossible since few were willing to talk to us. Therefore, our approach changed, this time focusing more on personal observations and the available bibliography.

A total of 62 *luzzijet* were observed. Sometimes their identification was quite problematic since they were anchored far from shore or covered with cloth, so they were not easily distinguishable from other similar boats. They were not distributed evenly around the islands: of the recorded boats, 14 of them were in Mgarr, Gozo's main port, five in the area of Msida and St Julian's, seven in St Paul's Bay and Qawra, and more than

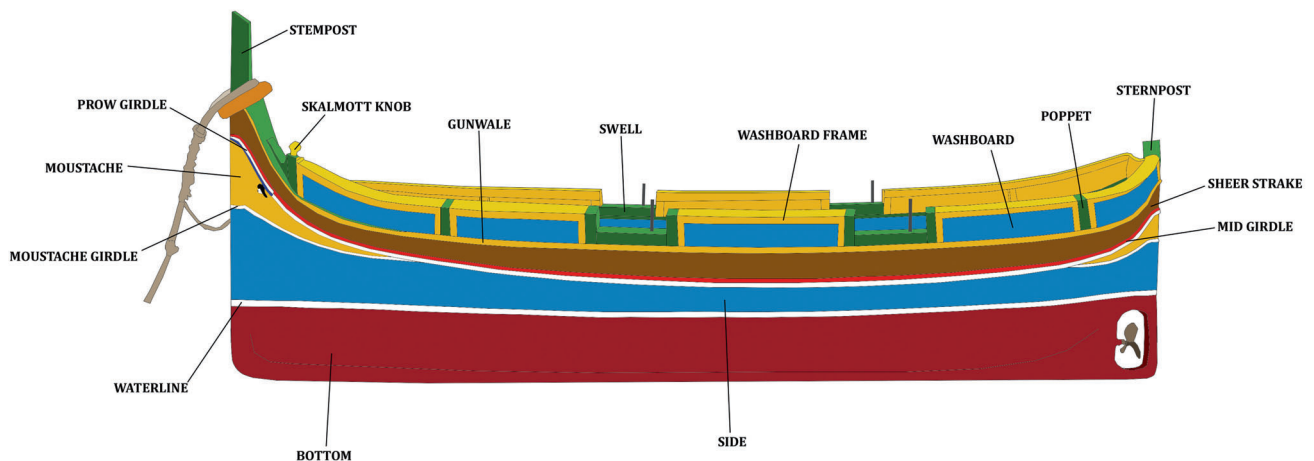


Fig. 1: Drawing showing the shape of a *luzzu* along with the terminology for each part (drawing Irene Muñoz).

half of them, 36, were anchored in Marsaskala and Marsaxlokk, especially Marsaxlokk (30 of the 36).

## 1. INTERPRETATION OF COLOURS

When choosing a colour, many factors come into play, including the practical, aesthetic, symbolic and cultural. Earlier authors emphasised the importance of the moustache (*mustaċċ*) to distinguish the location of origin of a *luzzu*. S. Said (2014, p. 36) notes, “a red *mustaċċ* would mean that the boat came from St Paul’s Bay. A lemon yellow *mustaċċ* indicates it came from Msida or St Julian’s, whilst an ochre yellow would identify the boat as pertaining to the south (Marsaxlokk and Marsascala area)”. A fisherman interviewed by J. Hornell (1923, p. 314) mentioned the change to a black or dark blue moustache as a sign of grief when a relative dies.

However, unlike previous research, no local differentiation regarding the colour of the moustache was observed today. In Valletta and St Julian’s, we interviewed two fishermen, asking why they used specific colours for their boats. They gave vague answers, such as “because these colours are used here” or “there is no particular reason, just because I like it”. Even if today the traditional selection of colours is mostly respected, the meaning behind those colours seems to have been lost. In table 1 we have gathered past and present possible meanings of the dominant colours of each part of a *luzzu*.

## 2. INTERPRETATION OF SYMBOLS

### 2.1 BIRD WITH SCROLL

The bird, represented on the sides of the boat flying under the *oculi* usually carrying a scroll in its beak, can be identified as a debased form of the Christian dove carrying an olive branch. In Christianity, the dove symbolises the soul and is the image of the Holy Spirit. It can also be understood as a symbol of hope, since it helped Noah find land after the flood. Thus, it could act as a protective image, helping boats return home safely. In addition, D. Morris (2016, p. 71) recorded an interesting tradition: during the launch and baptism of a *luzzu*, references to Noah’s

tale can be found in the priest’s sermon, and also in the olive branch and cross that are attached to the stempost.

### 2.2 OCULI

*Oculi* are depicted on the moustache. This symbol is present on many boats around the world, possibly indicating several inception points. It is not until the Egyptian civilization that this symbol becomes common. The eye appears as an independent entity or associated with a deity such as Ra, Atum or Horus. The eye of Horus was a popular amulet in ancient Egypt for protection against disease and the ‘evil eye’ (Castañeda Navarro 2014, p. 9). It can be seen on Ra’s sacred barque, on the bow of funerary ships and other objects ensuring a safe trip to the ‘other shore’ (Hornell 1923, p. 300). It is likely that the Phoenicians helped spread this symbol across the Mediterranean, with the Greeks and later the Romans continuing the tradition. Painted eyes also appear on pre-Islamic Arabic ships as protection against the ‘evil eye’ and the temptations of demons, a custom that probably spread to the East through trading routes (Castañeda Navarro 2014, p. 14-15).

When Hornell visited Malta and Gozo in the early 1920s, he found that locals thought the eye of Horus acted as a protection against the ‘evil eye’, while Gozo residents believed that the symbol gave a spiritual identity to the boats, as if they were ‘animated’. They were also associated with the success of the *luzzu*. Hornell also noticed that most *oculi* had a yellow eyebrow (Hornell 1923, p. 314). Similar symbolism is common today, but most eyebrows are painted black, or yellow as the second most common colour. Red and blue are rarer, while there was also one example of an orange eyebrow. All these variations seem to be associated with personal preferences.

### 2.3 BIRD/DRAGON

When the sheer strake of the *luzzu* is decorated, the motif has been observed to be a garland of plants and flowers. In some *luzzijet*, this decoration is carved and painted yellow or white, although this only occurs on those boats where the sheer strake is varnished wood. Sometimes a dragon appears on the bow, or else a bird or a creature that is a mix of both. The bird, like the one on the side of the boat, can be interpreted as a dove holding

**Table 1:** The table shows the dominant colour for each part of a *luzzu*.

| Colour       | Meaning / Functionality  | Location                                     |
|--------------|--|--|
| Brownish-red | Copper-based paint as an antifouling aid   | Bottom                                       |
| Blue         | Related to water and the spiritual world in many cultures  | Side<br>Washboards                           |
| White        | Aesthetics and tradition: visually separates different sections of the boat  | Waterline<br>Moustache girdle                |
| Yellow       | Colour of the Vatican flag and the Archbishop of Malta. Almost universally, yellow symbolises the sun, eternity and the divine       | Moustache<br>Sheerstrake<br>Washboard frames |
| Red / white  | Maltese flag. A variation of this, red/white/blue, represents the colours of the Maltese flag under British rule                     | Prow girdle<br>Mid girdle                    |
| Brown        | Imitates wood, since varnished wood needs more maintenance   | Sheerstrake                                  |
| Green        | In ancient Egypt symbolised goodness, life and resurrection, while in ancient Rome green was identified with growth, health and life | Poppets<br>Swells                            |

a floral garland instead of the usual olive branch (Morris 2016, p. 77). When the bow figure has a more dragon-like shape, the rest of the pattern on the sheer strake can be interpreted as fire coming out of its mouth. In many Western societies, the dragon has a negative connotation related to evil (Carmona Muela 2008, p. 227). Thus, this symbol can be considered a memory of an older religion or culture.

### 3. CONCLUSION

Compared to previous studies, such as those carried out by Hornell in 1923 and Morris in the 1970s, the number of *luzzijiet*

has decreased significantly and any local differentiation regarding the colour of the moustache that was recorded previously is absent today. Although each *luzzu* is different depending on the owner's colour preference, the final choice is still subject to local cultural pressure. Symbols once prominent, but now stripped of their original meaning, still survive in art and cultural traditions despite contradicting modern beliefs. The chromatic homogeneity seen today may also be related to the numerous photographs of romanticised fishing villages and colourful boats that are used to promote Malta as a tourist destination.

### REFERENCES

- CARMONA MUELA J.  
2008 *Iconografía de los santos*, Madrid, Ediciones Akal S.A.
- CASTAÑEDA NAVARRO P. A.  
2014 *El origen mitológico del ojo de las barcas de jábega malagueñas*, Málaga, Amigos de la Barca de Jábega, Cuadernos del Rebalaje 25.
- HORNELL J.  
1923 Survivals of the Use of Oculi in Modern Boats, *The Journal of the Royal Anthropological Institute of Great Britain and Ireland* 53, p. 289-321.
- MORRIS D.  
2016 *The boats of Malta: The Art of the Fishermen*, Malta, Anthony Aquilina.
- MUSCAT J.  
1999 *The Dghajsa and other Traditional Maltese Boats*, Malta, Fondazzjoni Patrimonju Malti.
- SAID S.  
2014 *The Firilla: A case study of a Maltese traditional boat*, Master's thesis, Denmark, Syddansk Universitet.





# THE 16<sup>TH</sup>-CENTURY PUMP FROM GAGLIANA GROSSA: PRELIMINARY RESULTS OF RECORDING AND ANALYSIS

Katarina BATUR and Irena RADIĆ ROSSI

---

## Abstract

During excavations on the 16<sup>th</sup>-century Gnalić shipwreck, elements of the ship's pump were located. Surviving artefacts associated with the pump consist of the pump well and lower pump tube. This paper discusses the pump assemblage and findings noted during fieldwork. These discoveries are particularly valuable as it is the only example providing construction characteristics of a ship's pump from a late 16<sup>th</sup>-century Venetian round ship.

## Keywords

Gagliana Grossa, Gnalić shipwreck, ship's pump

## Résumé

Lors des fouilles de l'épave de Gnalić, datée du XVI<sup>e</sup> siècle, des éléments de la pompe de cale ont été localisés. Les vestiges se composent du puits et de la partie inférieure du tuyau. L'article traite de l'assemblage de la pompe et des résultats issus du travail de terrain. Ces découvertes sont particulièrement précieuses, car il s'agit du seul exemple donnant les caractéristiques de construction de la pompe d'un navire rond vénitien de la fin du XVI<sup>e</sup> siècle.

## Mots-clés

Gagliana Grossa, épave de Gnalić, pompe de cale

---

The lowly ship's pump can play a significant role in saving a vessel during calamities. When parts of the ship crucial for propulsion and manoeuvring do not work and water is leaking through the seams filling the hold, it is still possible to save everyone onboard by pumping the water out. Except for Thomas Oertling's publication, *Ships' Bilge Pumps* (1996), which discusses this crucial ship component from the 16<sup>th</sup> to 19<sup>th</sup> centuries, there is a lack of additional archaeological evidence for ships' pumps on other 16<sup>th</sup>-century vessels (Waddell 1985; Loewen 2007; McElvogue 2007; Guérout 2017). In a recently published article, Charles Bendig (2020) discusses pump technological developments based on archaeological evidence from 300 BC to 1600 AD, considering the position of the ship's pump within the hull.

Although a fair number of chain and force pumps were attested on ships from antiquity (Stein 2007; Carre 2007), it is unknown exactly when common and burr pumps were first invented. Drawings from historical sources suggest they came into use by the middle of the 15<sup>th</sup> century. Subsequent drawings of similar pumps used for mining in Germany are described by Gregorius Agricola in his treatise *De Re Metallica* (1556). Pumps of similar designs were also used on ships from the same period. In fact, circular lead discs recovered from the 16<sup>th</sup>-century Molasses Reef shipwreck were identified as the valves of a common pump based on Agricola's drawings (Oertling 1989, p. 586 and 587, 1996, p. 22-23 and 34-35).

Contrary to the force pump's reliance on two solid pistons working in tandem, burr and common pumps utilise two permeable valves to lift water through a single tube. Ancient chain pumps are predominantly mechanical and lift water using a series of discs strung on a rope (Stein 2007; Carre 2007).

Burr and common pumps co-existed in the 16<sup>th</sup> century, while in the 17<sup>th</sup> century the burr pump fell out of use. Both types of pump had a stationary lower valve, installed either just below the pump tube as part of a separate wooden foot or inside the tube itself (Waddell 1985; Loewen 2007). The only definitive way to distinguish between these two pump types is based on the type of upper valve used (Oertling 1996, p. 21 and 24).

Excavations of the *Gagliana Grossa*, which sank in 1583 near the Gnalić islet off the coast of Croatia, yielded an interesting find in 2016. After removing a layer of ballast stones, archaeologists discovered a vertical rectangular timber with smooth sides. Upon further examination, the timber had a central vertically drilled hole, and the lower end was stepped to fit between floor timbers. Based on its position in the middle of the ship and analogies with published archaeological data, the object was identified as the lower part of the pump tube for a ship's pump. It was surrounded by upright positioned planks forming a structure interpreted as the pump well.

During the 2017 and 2018 field seasons, it was decided to remove parts of the structure to conduct recording in the laboratory. Observations, sketches, and photos were made, as well as a photogrammetry model. After recording, the removed components were wrapped in geotextile and stored safely back on the site.

## 1. THE SHIP'S PUMP ELEMENTS

Although the lower tube and the pump well assembly were well preserved, the remainder of the pump equipment, such as the valves, rod, breaks, or an associated dale, did not survive.

The pump complex was composed of two elements.

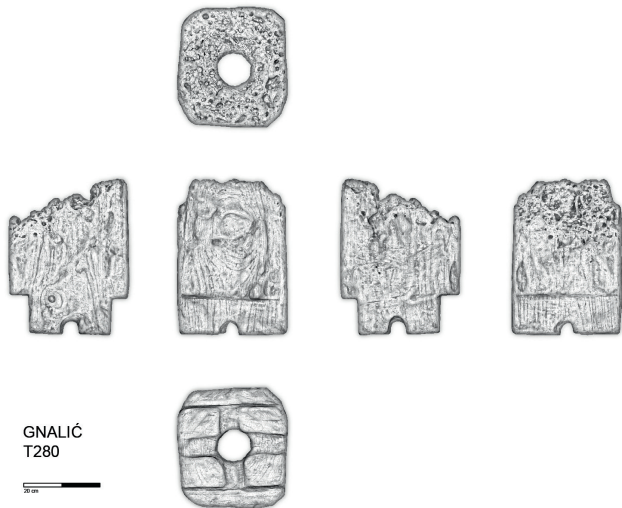


Fig. 1: Lower part of the pump tube (drawing: K. Yamafune, K. Batur).

### 1.1. THE PUMP TUBE

Measurements: bottom, 23 × 28 cm; middle, 30 × 28 cm; diameter of the hole, 11 cm (upper), 9 cm (lower); preserved height, 30 cm (fig. 1).

The surviving element of the pump tube is made from a single timber originally found standing in an upright position amidships. Each vertical edge of the tube is chamfered, with a circular hole drilled vertically through the centre. Two sides of the rectangular base are rebated to allow the tube to fit between adjacent floor timbers. The tube was installed between the fourth and fifth aft floor timbers to reach as deeply as possible into the central bilge.

Water that accumulated in the lowest part of the ship was pumped out through the central bore. No material evidence was found on site for the lower and upper valves. As there was no foot below the pump tube, the lower valve was probably made of leather and/or metal installed in the missing part of the pump tube. Survival of the upper valve attached to the movable rod would allow us to distinguish whether this pump was a burr or common type.

### 1.2. THE PUMP WELL

Measurements: overall dimensions, 163 × 97 cm; height, 87 cm (fig. 2).

The pump well is an enclosed structure formed to protect the pump components from ballast stones, other cargo, or debris present in the hold of the ship (Waddell 1985, p. 251). In the



Fig. 2: View of the middle ship area, focusing on the ship's pump and mast step (orthophoto: K. Yamafune).

Gnalić shipwreck, the pump well was built on the starboard side, formed by walls made of upright positioned planking, stanchions, and a buttress. On the southern side, the structure was defined by two internal stanchions, which were fixed in place between two stringers. The western wall has a foundation on the first, western buttress. Pump well height was achieved by installing the pump well planks vertically.

## 2. DISCUSSION

Similar systems of drainage have been found on other 16<sup>th</sup>-century ship excavations, including the Basque whaler *San Juan*, lost in 1565 in Red Bay, Canada, and the *Lomellina*, lost in 1516 at Villefranche-sur-Mer, France. *San Juan* carried a burr pump, based on the upper valve formed as a leather cone attached to the end of the rod (Loewen 2007, p. 164-167). Conversely, it is not possible to define the type of pump on *Lomellina*, as only the lower foot valves were preserved (Guérout 2017, p. 5-8). In contrast, the ship's pump excavated on the *Gagliana Grossa* appears to have just one long tube without a lower foot valve to act as a base. The find from *Gagliana Grossa* is especially important, as it is possibly the earliest archaeological evidence of a pump tube without the use of a foot on a ship intended for Mediterranean sailing (table 1).

Table 1: 16<sup>th</sup>-century archaeological evidence of ships' pumps.

| Site  | Date        | Pump position and type | Tube parts                 | Operational location | Reference                              |
|---|-------------|------------------------|----------------------------|----------------------|--|
| <i>Lomellina</i> (Villefranche-sur-Mer, France) | 1516        | Main pump; unknown     | Lower foot, tube           | Mediterranean        | Guérout 2014, p. 4-7.                  |
| Molasses Reef (Turks and Caicos Islands, UK)    | 1520s-1530s | Unknown; common        | none                       | Transatlantic        | Oertling 1989.                         |
| <i>Mary Rose</i> (Solent, UK)                   | 1545        | Spare pump; unknown    | tube, internal lower valve | Northwestern Europe  | McElvogue 2007, p. 289-292.            |
| <i>San Juan</i> (Red Bay, Canada)               | 1565        | Main pump; burr        | Lower foot, tube           | Transatlantic        | Waddell 1985; Loewen 2007, p. 164-167. |
| <i>Gagliana grossa</i> (Gnalić islet, Croatia)  | 1583        | Main pump; unknown     | Tube                       | Mediterranean        | Radić Rossi, Nicolardi 2019, p. 75.    |

### 3. CONCLUSION

The Gnalić shipwreck contains a ship's pump structure preserved at midship on the starboard side. Construction of the pump well is closely related to the mast step assembly. In this case, the western wall of the pump well was installed over the mast step's first buttress. The overall area surrounded by the other three preserved walls of the pump well encompasses one third of the mast step area.

The only part of the ship's pump recovered was the tube. The original height of the tube is unknown, as the surviving upper portion is quite damaged by shipworms and there is still not enough data to assume the overall height of the hold. Absence of any evidence for the lower valve possibly demonstrates that *Gagliana Grossa* went through another phase of ship pump development. The foot base probably disappeared from use because it made the pump tube difficult to clean and maintain during a voyage (Oertling 1996, p. 21). A future site discovery

of the pump rod would permit full analysis of the type of ship pump installed on *Gagliana Grossa* based on the appearance of upper valve attached to the rod.

Although studies of the ship pump from the Gnalić shipwreck are still in progress, the current results have significantly contributed to understanding the overall evolution of the ship pump.

### ACKNOWLEDGEMENTS

We would like to express our gratitude to the Croatian Ministry of Culture, Municipality of Pašman, and the Association for the Promotion of Underwater Archaeology (FUWA, Koblenz, Germany) for supporting the underwater excavations; Charles Bendig, David Ruff and Christopher Dostal for English editing and providing valuable suggestions and corrections.

### REFERENCES

- BENDIG C. D.  
2020 Ships' Pumps: From Antiquity to the Early Modern Era, *Journal of Maritime Archaeology*, p. 1-23.
- CARRE M.-B.  
2007 Les pompes de cale et l'évacuation de l'eau de sentine sur les navires antiques, in J.-P. Brun, J.-L. Fiches (eds), *Énergie hydraulique et machines élévatrices d'eau dans l'Antiquité, Actes du colloque international, Vers-Pont-du-Gard 2006*, Naples, Centre Jean Bérard, Collections du CJB 27, p. 51-66.
- GUÉROUT M.  
2014 Epave de la Lomellina (1516). Système d'épuisement des eaux de cale, in C. Beltrame (ed.), *Archeologia dei relitti postmedievali / Archaeology of Post-Medieval Shipwrecks*, Firenze, All'Insegna del Giglio, APM-Archeologia Postmedievale 18, p. 49-61.
- LOEWEN B.  
2007 The ceiling, decks, and castles: adaptations of shipyard carpentry for whaling, in R. Grenier, M.A. Bernier, W. Stevens (eds), *The underwater archaeology of Red Bay – Basque Shipbuilding and Whaling in the 16<sup>th</sup> century*, vol. 3, Ottawa, Parks Canada, p. 149-251.
- McELVOGUE D.  
2009 Removing water, in P. Marsden (ed.), *Mary Rose: Your Noblest Shippe: Anatomy of a Tudor Warship*, vol. 2, Portsmouth, Mary Rose Trust, p. 288-413.
- OERTLING T. J.  
1989 A Suction Pump from an Early-16<sup>th</sup>-Century Shipwreck, *Technology and Culture* 30.3, p. 584-595.  
1996 *Ships' Bilge Pumps: A History of Their Development, 1500-1900*, College Station, Texas A&M University Press.
- RADIĆ ROSSI I., NICOLARDI M.  
2019 *Brodolom kod Gnalića – Ogdaleno renesansnog svijeta*, Zagreb, AGM.
- STEIN J. B.  
2007 Roman wooden force pumps, use and performance, in J.-P. Brun, J.-L. Fiches (eds), *Énergie hydraulique et machines élévatrices d'eau dans l'Antiquité, Actes du colloque international, Vers-Pont-du-Gard 2006*, Naples, Centre Jean Bérard, Collections du CJB 27, p. 7-17.
- WADDELL P. J. A.  
1985 The pump and pump well of a 16<sup>th</sup> century galleon, *IJNA* 14.3, p. 243-259.





# WHAT INFLUENCED BRITISH EAST INDIAMEN SHIP DESIGN?

Kurt BENNETT

---

## Abstract

This paper presents the author's PhD research and explores the archaeological case study, *Edwin Fox*, to demonstrate changes in British East Indiaman ship design and construction during the mid-19<sup>th</sup> century. A range of methods have been employed during this investigation, including: 3D laser scanning, dendrochronology, fibre analysis and archival research to understand what influenced design and construction technologies over time. This paper contributes to our understanding of British colonial merchant ship design and building practices.

## Keywords

Colonial shipbuilding, *Edwin Fox*, British East Indiaman, ship construction

## Résumé

Cet article présente les recherches effectuées par l'auteur pour sa thèse de doctorat et aborde une étude de cas particulière, celle de l'*Edwin Fox*, pour démontrer les changements dans la conception et la construction des navires des Indes orientales britanniques au milieu du XIX<sup>e</sup> siècle. Un ensemble de méthodes a été utilisé au cours de cette étude: balayage laser 3D, dendrochronologie, analyse des fibres et recherche d'archives afin de comprendre ce qui a influencé la conception et les techniques de construction au fil du temps. Cet article contribue à notre compréhension de la conception et des pratiques de construction des navires marchands coloniaux britanniques.

## Mots-clés

La construction navale coloniale, *Edwin Fox*, British East Indiaman, construction navale

---

*Edwin Fox* is a mid-19<sup>th</sup> century merchant ship located in Picton, New Zealand and offers an opportunity to record and study major ship components in context (fig. 1). The vessel, constructed in Calcutta, India, in 1853 measures 48 m in length by 9.3 m breadth. *Edwin Fox* is used as a case study for the author's PhD research investigating design and construction technologies employed in building British East Indiamen. This study contributes to our understanding of British merchant ship construction in the 19<sup>th</sup> century while complementing traditional nautical archaeological approaches.

## 1. SIGNIFICANCE

The vessel has historical connections with India, England, Crimea, Australia and New Zealand. In 1999, Heritage New Zealand Pouhere Taonga registered *Edwin Fox* as Category 1, registration number 7450. Category 1 status is awarded to places or objects with special or outstanding historical or cultural significance or value. In 2013, the Edwin Fox Maritime Museum was awarded the World Ships Trust award for preservation. The award was presented because this surviving historic ship represents a type of vessel that had a significant role in the history of humanity and due to the fact that its presentation and display advances the education of the public. Currently, *Edwin Fox* is the only surviving historic vessel located in New Zealand to be assigned Category 1 status, which further reflects its current historical significance.

## 2. METHODOLOGY

In December 2016, a New Zealand based company, 3DScans, used a FARO Focus 130 laser scanner to scan the external and internal hull structure. The scanning took two days to complete and produced 370 million polygons with  $\pm 2$  mm accuracy. The exterior and interior raw data represented 77.2 GB in file size and provided accurate information for producing ships lines and a hull construction drawing. The scanned information was post-processed using different computer software. CloudCompare was used to consolidate all the data points collected from the scan. The entire digital model was then uploaded into MeshLab. Specifically, this software was used to reduce the overall file size and scale of the 3D digital model. The model was scaled using the Quadric Edge Collapse Decimation function to 10% of the original size while retaining the texture quality. This reduced the total file size to 1.17 GB. The reduction in size allowed for the 3D model to become more user-friendly across different platforms and computer programs. The ships lines drawing and construction drawing were then produced through the combination of Rhino 4.0, DELFTship and Illustrator CS6. The computer used for this processing was supplied by the Digital Archaeology Lab, Flinders University. This computer ran two Intel® Xeon® CPU E5-2680 v3 2.5GHz processors, 256GB RAM and operated on a 64-bit system.

More detailed recording of the hull included taking baseline offset measurements of features and of the midship section. Timber samples were collected for species identification, as well as core samples for dendrochronological analysis. Fibre samples from the caulking and the fibrous membrane behind



**Fig 1:** Edwin Fox on display at the Edwin Fox Maritime Museum, Picton, New Zealand. The ship measures 48 m in length by 9.3 m breadth (Photography K. Bennett).

the copper sheathing were collected and sent to BIAX Consultants for analysis. Historical research has also been undertaken at the British Library, London. Metal sheathing samples were collected and will be analysed for metal composition using XRF.

### 3. CONCLUSION

*Edwin Fox* is the last surviving extant hull of a mid-19<sup>th</sup> century British East Indiaman. Archaeological recording shows the ship is double planked with the outside layer fixed diagonally onto the inner longitudinal planking running bow to stern. These inner planks are caulked with hemp cordage. A layer of Muntz<sup>1</sup> metal covers the exterior planks below the waterline with an extra layer of goat hair matting between the sheathing and the diagonal hull planking. The outer planking is fixed to the ships frames with treenails. The frames are constructed using up to four futtocks and join floor timbers separating the keel and keelson. The ceiling planking is fixed using a mixture of iron fasteners and treenails. Iron bracing is installed on top of the ceiling planking to act as additional bracing and subsequently led to Lloyds originally surveying the ship as A1 (the top rating for a vessel). The ship is three masted, however, they have been reduced in length over time. The ship is mostly constructed of teak (*Tectona grandis*), with some structural timbers, i.e. floor timbers, being sal (*Shorea robusta*), and the masts, Himalayan cedar (*Cedrus deodara*). This is ongoing research and final results are expected in early 2020.

### ACKNOWLEDGEMENTS

Australian Government RTP stipend, Faculty of Education, Humanities and Law Top-up scholarship, Flinders University, School of Environment, University of Auckland, School of Science and Engineering, Flinders University, Australasian Institute for Maritime Archaeology Scholarship, Flinders University Student Association Development Grant, BIAX Consultants, 3DScans New Zealand, Marlborough Heritage Trust, Edwin Fox Maritime Museum.

1. Muntz metal, also known as yellow-metal sheathing, is a 60:40% copper-zinc mix patented by George Frederick Muntz in 1832 (O'Guinness Carlson *et al.* 2011, p. 108).

### REFERENCES

- O'GUINNESS CARLSON M., LIPPERT N.R., RONNBERG E.A.R., SCOTT D.A.  
 2011 Technical analysis of Muntz metal sheathing from the American clipper ship *Snow Squall* (1851-1864), in P. Mardikian, C. Chemello, C. Watters and P. Hull (eds), *Metal 2010, Proceedings of the Interim Meeting of the ICOM-CC Metal Working Group*, South Carolina, Clemson University, p. 107-115.

# TRADITIONAL SHIP CONSTRUCTION IN THE GULF OF LION AND THE LIGURIAN SEA: THE *TARTANE* CASE STUDY

Hélène BOTCAZOU

## Abstract

This article deals with a type of coaster from the northwest Mediterranean called *tartane*. This emblematic coaster is generally presented as the most commonly utilised boat for cargo transport from the 16<sup>th</sup> century until the end of sailing ship coastal trade in this area at the very beginning of the 20<sup>th</sup> century. Although it is often described as a wide-bottom one-masted lateen ship, we can count at least four different rigging systems in various iconographic resources portraying *tartanes*, dating from 1679 to the very first decades of the 20<sup>th</sup> century. These diverse rigging systems reveal some developments to and influences on the *tartane*-type vessel, and they add complexity to our vision of a maritime cultural landscape in a coherent sailing space that includes the Gulf of Lion and Liguria.

## Keywords

Corsica, lateen rigging, naval architecture, 17<sup>th</sup>-20<sup>th</sup> century, *tartane*, western Mediterranean,

## Résumé

Cet article traite d'un type de caboteur à voile de la Méditerranée nord-occidentale appelé *tartane*. Ce caboteur emblématique est généralement présenté comme le bateau le plus utilisé pour le transport de marchandises du xvi<sup>e</sup> siècle jusqu'à la fin du commerce côtier par voiliers dans cette zone, au tout début du xx<sup>e</sup> siècle. Bien qu'il soit souvent décrit comme un navire à voile latine à large fond, on peut compter au moins quatre systèmes de gréement différents dans diverses sources iconographiques représentant des *tartanes*, de 1679 aux toutes premières décennies du xx<sup>e</sup> siècle. Ces divers systèmes de gréement mettent en évidence un certain nombre de développements et d'influences sur le navire de type *tartane* et ils ajoutent de la complexité à notre vision d'un paysage culturel maritime inscrit dans un espace de navigation cohérent qui comprend le golfe du Lion et la Ligurie.

## Mots-clés

Corse, gréement latin, architecture navale, xvii<sup>e</sup> - xx<sup>e</sup> siècle, *tartane*, Méditerranée nord-occidentale

This paper presents an overview of the evolution of the *tartane*-type vessel, which was the most emblematic and widespread coaster along the southern coasts of France, from Provence to Languedoc. This case study is part of the author's PhD research focused on the architectural and functional systems of coasters sailing along Corsica's coast between the 16<sup>th</sup> and the 20<sup>th</sup> century<sup>1</sup>. Indeed, this island is strategically situated within a specific maritime transport zone sailed by a large number of coasters coming from different regions of the northwest Mediterranean basin. Thus, alongside the coasters of Corsican origin, this research also takes into consideration the coasters of Catalonia, the south coast of France, Liguria and Sardinia.

At the core of our research is the collection of a complete 'catalogue' composed of ship representations in paintings, stamps, photographs, and archival and bibliographical descriptions, along with other information from current underwater archaeological excavations conducted on the coast of Corsica. The aim is to describe the characteristics of the different coasters and identify adaptations to their environment and to the local societies that built them. We also try to present the differences and similarities in the coasters' building traditions in the different regions covered by our research.

1. This research was supervised by Nicolas Faucherre (LA3M, AMU, CNRS, Aix-en-Provence) and Eric Rieth (LAMOP, CNRS, Paris).

## 1. THE *TARTANE*-TYPE VESSEL

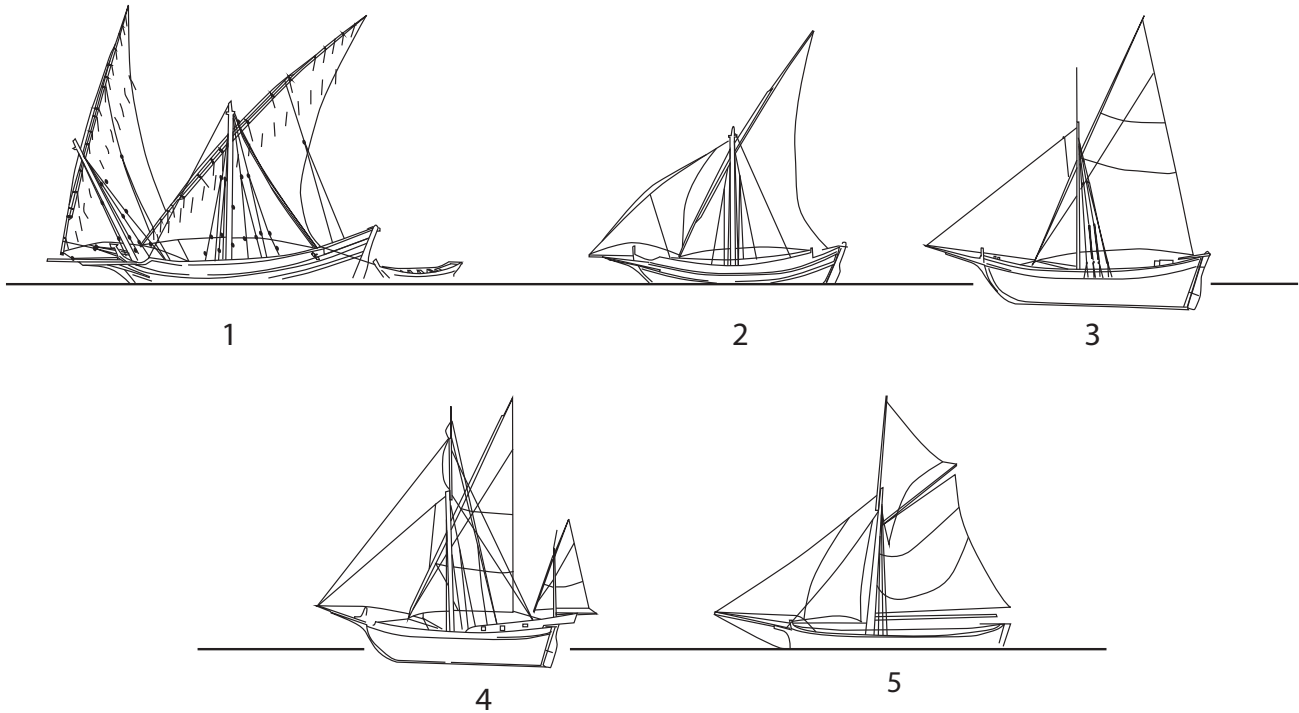
A comparison of the various drawings of *tartane*-type vessels allows us to follow the evolution of this type of ship and possibly the diversity of its regional adaptations (fig. 1).

The *tartane* generally corresponds to a one or two mast ship that has an average tonnage around 70 tonnes, though it can displace from 25 to 100 tonnes for the largest. Its wide bottom is easily recognisable, as well as its lateen rigging. As an example, the *Tartane Provençale from 1789*, drawn by Admiral Pâris (Pâris 1882), the first French maritime ethnographer and curator of the National Maritime Museum between 1871 and 1893, measured 12.90 m long, 3.20 m wide, with a draught of 2.30 m (fig. 1.3).

It seems that the first *tartanes* appeared in the 16<sup>th</sup> century (De Nicolò 2012) in Provence, southern France. The last of them was used in L'Estaque, Marseille, to transport tiles (Damonte 1990).

During the 17<sup>th</sup> and 18<sup>th</sup> century, *tartanes* for hauling cargo had a greater rigging, composed of a main mast (*mestre*), which was a lateen mast situated a little beyond the master frame, and a fore mast (*trinquet*) with a 25° inclination (fig. 1.1). This fore mast gradually disappeared during the 18<sup>th</sup> century. Ships like the *Tartane Provençale* of 1789 drawn by Admiral Pâris tend to adopt some of the features of the one-masted *tartane* used for fishing or transporting ballast as drawn by Jouve in 1679





**Fig. 1:** Evolution of the tartane-type of vessel (drawing H. Botcazou, AMU-LA3M, *Ipsa Facto*): 1. Tartane de négoce under sail (from Jouve 1679a, pl. 19-20); 2. Tartane de pêche under sail (from Jouve 1679b, pl. 16); 3. Tartane provençale, 1789 (from Pâris 1882, pl. 4); 4. Tartane "L'Albanaise" of the 18<sup>th</sup> century (French National Maritime Museum, Paris, model inv. 5.CP.9. – PH. 32579); 5. Tartane marseillaise, beginning of the 20<sup>th</sup> century (based on a photograph by Hubert Poilroux)

(Jouve 1679). Here, a large jib called *polacre* replaces the fore mast (fig. 1.2).

Another type of *tartane* is represented by the *Albanaise*, a model from the 18<sup>th</sup> century held in the French National Maritime Museum in Paris (fig. 1.4). It is a lateen-rigged boat with a main mast and a mizzen (*méjane*) situated at the stern of the boat. The mizzen is balanced at the bow by a *polacre* (Pâris 1882). This type of rig can be related to both the Italian *bovo* and *pareggia* vessels that were in use in the 19<sup>th</sup> century, especially between Corsica and Liguria, and to the Spanish *balancelles* from Catalonia.

During the transition from the 19<sup>th</sup> to 20<sup>th</sup> century, the surviving *tartanes* are of the one-masted type. The yard of the lateen sail (*antenne*) becomes more rigid and is topped up so that the triangle of sail situated in front of the mast is reduced. We often see a triangular topsail rigged to a topmast attached above the lateen one. The front part of the yard will slowly disappear to look like a fore and aft rig, and a large jib is used beyond the main mast (fig. 1.5). This system demands less effort and people for handling. It allows the division of the sails, which are as a result lighter to use. This organisation is cleverly complemented by a curtain sail (*voile à rideau*), which allows easy furling of the main sail without lowering the gaff (Burlet 1988).

The one-masted *tartane* with a lateen rig was related to fishing activities from at least the 17<sup>th</sup> century (fig. 1.2). The term *tartane* is also the name of a specific net. These boats were involved in pair-trawling (*pêche aux boeufs*). The last versions of these vessels were still in use in the first half of the 20<sup>th</sup> century in the harbour of Sète in Languedoc. André Aversa, a local

traditional boat builder, witnessed the changes in technology during his life, and testified that he adapted the original shape of the *bateaux boeufs*, a *tartane*-like fishing boat, to the engine and to the new nets that are now hauled in from the rear of the boat. Little by little the sail disappeared and, with the engine, a transom appeared (Vigne 2003).

## 2. CONCLUSION

This ongoing research has led us to understand that the *tartane*-type vessel, which seemed at first sight to correspond to a very distinctive type of coaster, effectively reflects a varied range of successive adaptations over time. The rigging of the *tartane* has been successively modified to answer the needs of the local populations: it has influenced other types of coasters (e.g. the *bateaux boeufs* of Sète); and it has itself been influenced by external practices. The fore-and-aft coaster from the first decades of the 20<sup>th</sup> century, for example, sheds light on this last case. The successive adaptation of the rigging of the *tartane* corresponds to the global evolution of the lateen rig. The big two-masted *tartane* from the 17<sup>th</sup> century abandons the fore mast in the subsequent century, and then follows two different paths. The first is inherited from the one-masted fishing or ballast ship, and will later be influenced by the Atlantic fore-and-aft rigging. The second corresponds to a widespread rigging from Catalonia to Liguria, composed of two masts (a main and a mizzen) and a jib. This efficient balanced rigging was also used to fit the *bovi* and *paregge*,

both types abandoned at the end of the 19<sup>th</sup> century in Liguria, Corsica and Provence.

Although iconographic and archival research provides information on the rigs and superstructures of ships that have now disappeared, it does not offer much data on architectural building details. However, this research opens new perspectives for the study of the structural and technical systems of the often forgotten small to medium size Mediterranean merchant

vessels, and brings fresh insight to the archaeological data gathered from past and ongoing archaeological research<sup>2</sup>.

---

2. In particular to the current project led by Franca Cibecchini (Drassm) at Paragan (southern Corsica) where a coaster has been under excavation since 2016 (see Rieth, Cibecchini in this volume). This fieldwork is part of a larger research programme led by Eric Rieth (CNRS) on the architectural signatures of traditional Mediterranean shipbuilding.

## REFERENCES

- BURLET R.  
1988 La voile latine, *Neptunia* 171, p. 11-21.
- DAMONTE L.  
1990 Les derniers voiliers ayant fréquenté la rade de Marseille, *Neptunia* 179, p. 25-31.
- DE NICOLÒ M. L.  
2012 Recherches sur l'histoire de la pêche en Méditerranée: Tartanes de Provence, tartanes de Vénétie, trabacs, modèles adriatiques pour la pêche à la traîne et le petit cabotage (XVII<sup>e</sup> au XVIII<sup>e</sup> siècles), *Cahiers de la Méditerranée* 84, p. 309-323.
- JOUBE J.  
1679 *Desseins de tous les bastiments qui naviguent sur la Méditerranée*, Marseille.
- PÂRIS F.-E.  
1882 *Souvenirs de marine conservés ou Collection de plans ou dessins de navires et de bateaux anciens et modernes, existants ou disparus: avec les éléments numériques nécessaires à leur construction*, Paris, Gauthier-Villars.
- VIGNE B.  
2003 Un siècle de construction navale à Sète; les mémoires d'André Aversa, charpentier de marine, *Le Chasse-Marée* 162, p. 46-54.



# SHIPS OF THE WESTERN INDIAN OCEAN IN PERSIAN MANUSCRIPT PAINTINGS

Michael J. DE RUYTER

---

## Abstract

The preliminary review of 150 images of watercraft in Persian manuscript paintings from the 14<sup>th</sup> to the 19<sup>th</sup> centuries reveals the contextual environment of these much-maligned images of seafaring. Nautical researchers rarely cite Persian paintings, but availability of digital facsimiles of Persian manuscripts online has improved access to a large corpus of images allowing close examination and comparisons. This study demonstrates the potential of the corpus of watercraft images in Persian manuscripts and shows how these paintings may be interpreted more as illustrations of seafaring culture rather than detailed depictions of nautical technology.

## Keywords

Islamic art, Islamic seafaring, Persian ships, dhows

## Résumé

La relecture de 150 images d'embarcations apparaissant dans des peintures des manuscrits persans du XIV<sup>e</sup> au XIX<sup>e</sup> siècle révèle l'environnement contextuel de ces images tant décriées de la navigation. Les chercheurs en histoire maritime citent rarement les peintures persanes, mais la disponibilité en ligne de fac-similés numériques de manuscrits persans a amélioré l'accès à un vaste corpus d'images permettant réexamens et comparaisons approfondies. Cette étude met en évidence le potentiel du corpus d'images d'embarcations dans les manuscrits persans et montre comment ces peintures peuvent être interprétées davantage comme des illustrations de la culture maritime que comme des représentations détaillées de la technologie nautique.

## Mots-clés

Art islamique, navigation islamique, navires persans, boutres

---

This paper describes the preliminary review of a corpus of 150 images of watercraft in Persian manuscript paintings from the 14<sup>th</sup> to the 19<sup>th</sup> centuries. The iconic 13<sup>th</sup>-century paintings of ships and boats in several illustrated versions of al-Hariri's *Maqamat* are widely used by nautical researchers as pictorial evidence of seafaring in the Indian Ocean, and are highly valued due to the relative paucity of other iconographic and archaeological evidence (Agius 2008, p. 31 and 382). The more plentiful Persian images produced over the next six centuries are much less frequently cited and have been considered "remarkably unrealistic" (Nicolle 1989, p. 187). Persian paintings are rarely cited by nautical researchers due to their highly stylised nature, the apparent absence of evidentiary value and difficulty of access compared to other sources (Nicolle 1989, p. 183). The availability of digital facsimiles of Persian manuscripts online is rapidly rendering the last of these impediments obsolete, prompting a reappraisal of the others. The images in this corpus of Persian paintings might lack technical merit as strictly nautical studies, but they have clear potential to illustrate the nuances of Islamic seafaring culture in the western Indian Ocean.

## 1. THE CORPUS OF IMAGES

This study seeks to examine the social contexts of western Indian Ocean seafaring by exploring rarely used iconographic sources that can supplement archaeological evidence. The growing corpus of Persian paintings of watercraft currently includes 150 images dating from 1314 to 1870 identified in digital collections online and in manuscript catalogues. The images

have been coded by temporal, spatial and figural elements, as well as by the shapes, features and activities of the watercraft represented. The original paintings were executed in court workshops in inland cities of the 'Persianate' world – Shiraz, Tabriz, Herat, Bukhara, Isfahan, Qazwin, Khurasan, Yazd – and are stylistically distinct from contemporary Arab, Ottoman and Indian manuscript paintings. Watercraft are depicted in a range of lacustrine, riverine and marine environments. This paper reports some results from an initial analysis of the coded images and the full results will be published on completion of the PhD project.

## 2. SOURCES AND SCENES

The majority of these images come from copies of the *Shahnama* (Book of Kings), an epic Persian poem written in the 11<sup>th</sup> century. The illustrators were not therefore witness to the events shown. They appear to have used a mix of inspirations to supplement their clearly limited real life experience, including older Persian manuscripts (Eastman 1950, p. 162-163), Arab and European art, rock reliefs and shadow puppets.

A range of activities is depicted throughout the corpus. Fully 73% of images show vessels on passage or crossing rivers or lakes, 10% show fighting or violence such as in figure 1, 7% depict the Prophet Nuh and the Ark, 7% represent vessels in crisis or people overboard, three images show hunting or fishing, and only one image depicts boatbuilding activity, suggesting a lack of concern with seafaring trades among court audiences.





**Fig. 1:** A 1533 painting from the *Zafarnamah*, a biography of Timur, showing structural features of watercraft and the sail, and clear differentiation between courtiers and passengers, soldiers and crew (BL IO Islamic 137, f. 50r, courtesy of the British Library).

### 3. PEOPLE ONBOARD

Figure 1 shows a common distribution of figures in Persian paintings of watercraft. Crew members are commonly differentiated by simpler clothing, often shirtless and by darker skin. A *nakhoda* or sailing master is frequently shown towards the stern in larger vessels, usually distinguished by better clothing and headwear, although people of high social rank are also shown in this position, as is the case in figure 1.

Prophets, kings, women, soldiers, merchants and slaves are all variously shown as passengers in ships. Some 10% of images show women embarked, always as passengers and often in Nuh's Ark, and 7% depict the transport of horses, like in figure 1, which in this case includes an elephant. Sea monsters like those on the left of figure 1 are included in a fifth of all scenes and often portend grief or evil (Simpson 1997, p. 56-57).

### 4. SHIPS AND TECHNOLOGY

There are several standard boat or ship types that appear throughout the corpus, usually shown in profile. The majority of vessels depicted are small craft resembling the lower two in fig. 1 and 39% are seagoing vessels with mast and superstructure similar to the main vessel in the image, while 6% are identifiably European-type vessels, like carracks or galleons.

Indigenous Persian, Indian and European watercraft are depicted in the corpus. Square sails are prevalent throughout the corpus and triangular or trapezoidal sails first appear in the early 16<sup>th</sup> century, as shown in fig. 1. Stylistic 'banner' sails similar to those in the ship from the Schefer *Maqamat* manuscript (Bibliothèque nationale de France MS Arabe.5847, f.119v), possibly depicting a Quranic simile (Beeston 1973, p. 94), appear into the 15<sup>th</sup> century. Only in later European-style vessels is it possible to conclusively determine the method of fastening where nails or bolts appear.

### 5. CONCLUSIONS

This study confirms that seafaring for the Persian elite was an exceptional experience, much more so than fighting, hunting or feasting if the frequency of representation in manuscript painting in general is a guide. This is demonstrated by the appearance of watercraft in only 1% of the manuscript illustrations reviewed, and the majority of these watercraft conform to one of several visual tropes repeated throughout. These images for the most part display the nautical technical naivety of the terrestrially bound court artists, yet show the potential to provide rich insight into the social contexts of Persian seafaring. Further study of this growing corpus will include analysis of contextual information associated with the images and of the models or prototypes used by the artists. As well as identifying general technical trends, it may then be possible to distinguish which artists or images are more reliable for nautical research and which are more likely to be based on first-hand experience. This corpus already represents a significant collection of indigenous maritime art of the western Indian Ocean that can supplement documentary and archaeological sources.

### ACKNOWLEDGEMENTS

Thanks to Flinders University, the British Foundation for the Study of Arabia, the Iran Heritage Foundation and the Royal Historical Society for financial support, and to Associate Professor Wendy van Duivenvoorde for supervision. Thanks to the anonymous reviewer and Dr Giulia Boetto for helpful comments.

## REFERENCES

- AGIUS D. A.  
2008 *Classic Ships of Islam: from Mesopotamia to the Indian Ocean*, Leiden, Brill.
- BEESTON A. F. L.  
1973 Ships in a Quranic simile, *Journal of Arabian Literature* IV, p. 94-96.
- EASTMAN A. C.  
1950 On Three Persian "Marine" Paintings, *Journal of Near Eastern Studies* 9.3, p. 153-163.
- NICOLLE D.  
1989 Shipping in Islamic art: seventh through sixteenth century AD, *The American Neptune* XLIX.3, p. 168-197.
- SIMPSON M. S.  
1997 *Persian Poetry, Painting and Patronage: Illustrations in a Sixteenth-Century Masterpiece*, New Haven, Yale University Press.



# THE TALLINN COG: SMART CONSERVATION

Eero EHANTI, Heikki HÄYHÄ and Priit LÄTTI

---

## Abstract

This article presents the conservation project of a medieval shipwreck find in Tallinn, Estonia. The object, the well-preserved wreck of a Hanseatic cog, is briefly introduced, but the main focus is on conservation measures. The decision-making process is discussed, and the conservation plan summarised. At this late stage of the project, it can be concluded that the choices made and conservation actions carried out have proven to be successful.

## Keywords

Cog, conservation, maritime archaeology, shipwreck, wood

## Résumé

Cet article présente le projet de conservation d'une épave médiévale découverte à Tallinn, en Estonie. L'objet, l'épave bien conservée d'une cogue hanséatique, est brièvement présenté, mais l'accent est mis principalement sur les mesures de conservation. Le processus décisionnel est discuté et le plan de conservation résumé. À l'issue de ce projet, on peut conclure que les choix opérés et les actions de conservation menées se sont avérés fructueux.

## Mots-clés

Cogue, conservation, archéologie maritime, épave, bois

---

A very well preserved, early 14<sup>th</sup> century wreck of a cog, the ship type used by the Hanseatic League, is undergoing conservation in Tallinn in order to be exhibited inside the old town city walls. The 18m-long wreck with a beam of 6 m was found in 2015 during construction works in a park area near Tallinn shoreline. The ship is made of oak, which dates after 1296 (*terminus post quem*) according to dendrochronology. The bottom of the hull is carvel-built while the strakes are clinker-built. The planking is fastened to frames with wooden pegs, and strakes are connected to each other with iron nails. Sintels are used to hold the wooden laths in place on the plank seams. Moss is used for caulking.

The ship and numerous artefacts found on board were carefully excavated and brought to the Estonian Maritime Museum for conservation. The cog was placed inside a spacious and sturdy tent on gravel. Air circulation was improved by an industrial fan. It became evident that the ship is the best-preserved medieval vessel found in Estonia and will thus become the star exhibit in the new permanent exhibition in the Estonian Maritime Museum's renovated Fat Margaret premises.

Before any kind of display, the complex wet object had to be conserved in order to stabilise it and enhance its exhibition value. Plenty of cleaning was required, and reinforcements were needed to keep the pieces together. The major question was whether to PEG treat or not, whether to use polyethylene glycol, the trustworthy polymer utilised successfully in such shipwreck finds elsewhere. This led to a subsidiary question: should we first dismantle the entire wreck for proper impregnation, or keep the wreck together and spray-treat, as has been done with *Vasa* for instance? There was also the consideration as to whether the oak was in good enough condition to withstand controlled drying without the introduction of stabilisation agents inside the wood matrix. Some cracking and damage caused by too fast drying upon excavation were obvious on the upper part of the hull. The fear was that this might continue without PEG treatment.

Eventually, we took the somewhat bold decision to air-dry without any stabilising agent. A very relevant fact affecting our decision-making was that the wreck had already dried considerably when the conservation process was initiated: it was no longer waterlogged, merely wet. We believed that it was too late for PEG treatment unless the entire wreck was returned to a waterlogged state, which would have caused unnecessary stress to the wood. Another cornerstone of our evaluation was the observed and researched fact that the oak wood is for the most part quite sound, although the upper part of the ship has been damaged by direct sunlight. Wooden pegs attaching the hull planking to the frames were still holding the structure together. Hence, we estimated that the wood would withstand controlled drying and the structure would remain together given that sufficient support was added by replacing corroded iron nails and missing treenails as needed. External and internal supporting structures following the ship's form were also needed for safe transportation and meaningful exhibition.

Needless to say, a very laborious cleaning process had to be completed in order to make the whole presentable and minimise the possibility of biological growths. Cleaning was mostly done mechanically, using brushes, scalpels, vacuum cleaners and so on, but we are also very proud to report that dry ice blasting was used on outer surfaces of the hull as well as parts of the inside, with great results. This method might sound a bit harsh for shipwreck wood, but after thorough testing on loose pieces we learned that when gentle enough parameters have been defined, the results are very good in terms of sensitivity, efficiency and aesthetics.

Everything was minutely documented by traditional measuring and photography methods, but also by laser scanning. The latter was carried out twice during the conservation project. A local coordinate system was established, and the measured point clouds were compared together. We were able to see that the changes in the hull were minimal. Deformation monitoring of the hull in the final exhibition will be based on the same technique. The exhibition hall will, of course, be climate controlled.





Fig. 1: Priit Läti and Heikki Häyhä cleaning the hull in December 2018 (photography Eero Ehanti)

The cog is far from complete. A lot of the structure is missing, but the shape of the hull and the information as to how it was built has been beautifully preserved. The keelson is complete and the mast step made out of a single tree trunk is still there. Moss caulking between the hull planking has been preserved in many places. Even some sintels holding the caulking together were preserved. With internal steel structures, new wooden pegs and acid-proof bolts, the cog will hold together and will represent a cognitive anchor to medieval Tallinn.

The cog will be ready for display within the previously established schedule, which was indeed quite tight for the large-scale conservation of such a precious item. The schedule affected our decision-making. Insisting on a PEG treatment process of, for example, ten years' duration, would have had significant repercussions on the entire project, including finance. As it is, the cog exhibition will be opened in November 2019. At the time of writing, late May 2019, everything appears fine. The wood has dried nicely without dramatic reactions.

This brings us to the notion of 'smart conservation' as mentioned in the title of our article. We think that conservation is not always about elaborate treatments involving special chemicals after very scientific analyses. It is rather about understanding the object at hand and doing only what is needed to preserve the tangible object while enhancing the intangible. By the latter, we refer to the wealth of significance that historical objects possess. Why are we preserving this and how are we telling its stories?

Sometimes very drastic, slow and costly conservation processes are needed, but they should not be resorted to when not necessary. Here we have a fine example of one of the ideals of conservation: minimum intervention. Or smart conservation, as we like to call it<sup>1</sup>.

1. For more information about the cog and a blog about its conservation: [www.fogheritage.com](http://www.fogheritage.com); <http://meremuseum.ee/en/>; <https://www.muinsuskaitseamet.ee>

# EARLY MODERN REUSED SHIP TIMBERS FROM BOQUEIRÃO DO DURO, LISBON, PORTUGAL

Gonçalo C. LOPES, José BETTENCOURT, Cristóvão FONSECA,  
Tiago SILVA, Patrícia CARVALHO and Inês Pinto COELHO

## Abstract

Archaeological excavations conducted at the riverside area of Lisbon (Boqueirão do Duro, Santos) in 2016 revealed archaeological remains from the 18<sup>th</sup> to the 19<sup>th</sup> centuries, including the remains of a late 19<sup>th</sup>-century factory named *Vulcano e Colares* built on top of an ancient beach and later port.

The waterfront archaeological contexts were wide-ranging. There were several timbers from a large ship dismantled on the beach, port structures that reused ship elements, and an assemblage of pre-shaped timbers. Among the dismantled elements were keels, keelsons, stems, floor timbers, futtocks, hull planks, wooden sheathing, and an uncommon find, three complete bilge pumps.

## Keywords

Early modern archaeology, maritime archaeology, reuse of ship timbers, urban archaeology

## Résumé

Des fouilles archéologiques menées sur les rives du Tage à Lisbonne (Boqueirão do Duro, Santos) en 2016 ont révélé des vestiges archéologiques du XVIII<sup>e</sup> au XIX<sup>e</sup> siècles, y compris les vestiges d'une usine de la fin du XIX<sup>e</sup> siècle nommée *Vulcano e Colares*, construite au sommet d'une ancienne plage qui deviendra plus tard un port.

Les contextes archéologiques de la rive se révèlent très variés : plusieurs fragments de bois d'un grand navire démantelé sur la plage, des structures portuaires qui réutilisaient des éléments de navire et un assemblage de bois de charpente pré-équarri. Parmi les éléments démontés, on trouve des quilles, des carlingues, des étraves, des vaigres, des allonges, des fragments de bordé, des revêtements en bois et une découverte rare : trois pompes de cale complètes.

## Mots-clés

Epoque moderne, archéologie maritime, réutilisation du bois des navires, archéologie urbaine

Several riverside contexts were identified during archaeological monitoring of the redevelopment of a building located between Largo Conde Barão and Boqueirão do Duro Street. The archaeological remains were discovered under a 19<sup>th</sup>-century factory, in an area on the right bank of the Tagus River. This area appears in the city's early iconography as a beach. By the end of the 14<sup>th</sup> century it was occupied by maritime activities, which intensified over the 15<sup>th</sup> and 16<sup>th</sup> centuries. In the 17<sup>th</sup> century the area was known as *Ribeira da Junta do Comércio*, a place for shipbuilding and ship repair activities controlled by companies trading with Brazil. In the mid-19<sup>th</sup> century, it was occupied by the Boa Vista landfill, a huge operation that aimed to reclaim land from the river and where numerous factories were set up (Sarrazola *et al.* 2014, p. 111-116).

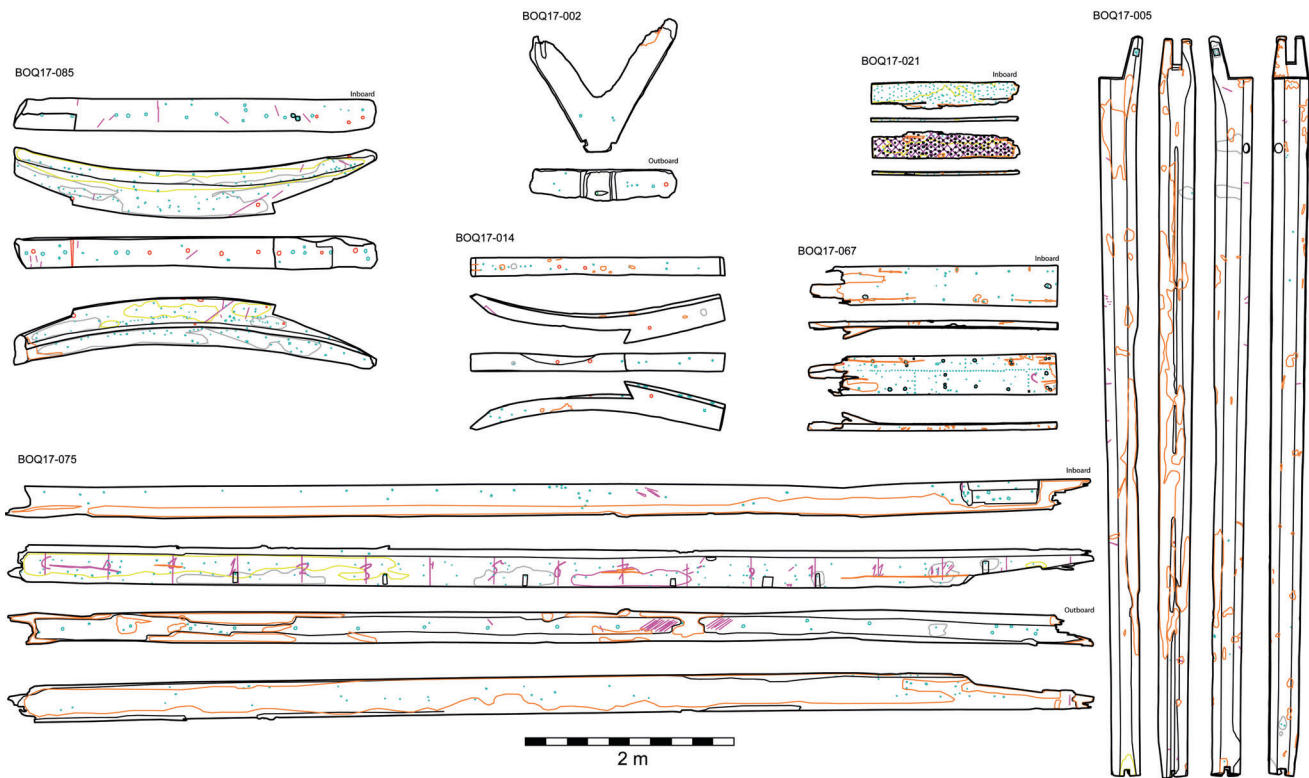
The stratigraphic sequence observed during the archaeological intervention attests to the use of this space for maritime activities between the 18<sup>th</sup> and the beginning of the 19<sup>th</sup> centuries. The older contexts correspond to the occupation of an intertidal zone with raw material storage and a wharf built from reused ship timbers. The remains of a small abandoned boat and an assemblage of dismantled timbers placed on the beach also belong to this phase (Macedo *et al.* 2017, p. 1916).

## 1. THE SHIP'S ELEMENTS

Up to 108 ship elements were recovered from these contexts: four keels, three keelsons, three stems, a rudder, 13 floor timbers, nine futtocks, 13 hanging knees, a carling, four bilge pump pipes, a complete anchor stock and 24 hull planks (fig. 1).

Some of these finds reveal interesting aspects about ship equipment that are unusual in the archaeological record. This is the case of a bilge pump pipe (BOQ17-005), consisting of a 7.08 m-long and 26-36 cm-wide piece with an octagonal section. The lower end has four channels, 4.5 to 5 cm wide and thick, through which the water was sucked in. Each channel had a square iron nail, measuring 1 cm that secured assembly, probably to the keelson.

The cheeks are 42 cm long and 9.2 cm wide, the height varying between 10.5 and 14 cm. They are carved in the pump extension and the edges are rounded. The pump had a tube across its total length, 9.5 to 10.5 cm in diameter where the valves worked. On one side there is a round hole, 9 cm in diameter and filled with cork, for water drainage. On the other side there is a small groove, 6 m long, 3.5 cm wide and 1.5 cm deep, of unknown function. Similar pumps have been found on the 18<sup>th</sup>-century vessels *San José* and *Las Animas* (1733), *Machault*



**Fig. 1:** Boqueirão do Duro ship timbers: BOQ17-085 – stem; BOQ17-002 – floor timber; BOQ17-021 – sheathing plank; BOQ17-014 – frame; BOQ17-067 – hull plank; BOQ17-075 – keel; BOQ17-005 – pipe of a bilge pump (drawing G. Lopes and J. Bettencourt).

(1760) and *Defense* (1779) (Oertling 1996, p. 24-29), for example.

Other pieces show different construction typologies and details. A keel component (BOQ17-075) is 10.45 m long, and presents sided dimensions between 28.2 and 29.4 cm, and moulded dimensions between 22.4 and 36.6 cm; one of the sides features a sequence of numbers from 1 to 11 and also some symbols, such as a half moon and a droplet. They are arranged at regular intervals of 60 cm and may correspond to marks for the sequential setting of the floor timbers, in a frame-first conception, as recorded, for example, on the keel of *La Belle* (Bruseth *et al.* 2017, p. 99-100 and p. 129-130).

A sheathing plank (BOQ17-021) measuring 1.41 m in length, 25.8 cm wide and 3.4 to 3.6 cm thick, features more than 100 square iron nails. The nails have a shank dimension ranging from 0.5 to 1 cm square, and heads embedded in round countersinks. On the outer face there are numerous carpenter's marks corresponding to punctures that form a quincunx pattern where the nails were supposed to be placed at intervals of about 5 cm. This large number of nails was intended to create a concretion layer, caused by the oxidation of the iron, which increased the watertightness of the ships. Parallels for this type of sheathing plank can be found in Dutch ships from the 17<sup>th</sup> and 18<sup>th</sup> centuries, such as *Batavia* (1629), *Vergulde Draak* (1656), *Zuiddorp* (1712) and *Zeewijk* (1727) (Duivenvoorde 2012, p. 242-246).

A hull plank (BOQ17-067), 2.38 m long, 37 to 39.2 cm wide and 6.5 to 6.7 thick, holds approximately 65 square copper alloy nails, with a shank dimension of 0.5 cm, creating a pattern that corresponds to the setting of copper alloy sheets: the plank is fastened to the frames by three or four iron nails in each

connection. These were square nails, measuring 1.5 to 2 cm, with round countersinks, suggesting a late 18<sup>th</sup> century chronology. In fact, between 1780 and 1830, the iron nails used in the assembly of hull planks to frames were replaced by copper nails, since contact between the iron and copper provoked iron corrosion and weakened the structure (Staniforth 1985, p. 22-23).

## 2. SOME REMARKS

The Boqueirão do Duro area was a maritime space from at least the 18<sup>th</sup> century onwards. At an early stage, the river beach was a port area without relevant structures, and might also have been used as a shipyard for ship dismantling activities. In a second phase, probably in the second half of the 18<sup>th</sup> century, the area was profoundly transformed, receiving a large wooden structure perpendicular to the river, probably a wharf.

Ship timbers were reused in the construction of this structure, including pieces of different elements with diverse construction features. The different typologies hinder their analysis as part of a ship structure, but it is possible to recognise a number of elements that are unusual in Atlantic shipwreck contexts, such as bilge pumps, some from large ships. Other elements seem to document external shipbuilding traditions, namely English or Dutch. Therefore, besides shipbuilding studies, these remains have considerable potential as a source for the analysis of the Lisbon riverfront, the archaeological site formation processes, and the management of end-of-life ships.



## REFERENCES

- BRUETH J. E., BORGES A., JONES B. M., RAY E. D. (EDS)  
2017 *La Belle, the Archaeology of a Seventeenth-Century Ship of New World Colonization*, College Station, Texas A&M University Press.
- MACEDO M. L., SILVA I. M., BETTENCOURT J., LOPES G. C., FREITAS T., NASCIMENTO R., PONCE M.  
2017 *Relatório Final de Trabalhos Arqueológicos Rua Boqueirão do Duro nº 38-42/Rua D. Luís I nº 28-28B, Lisboa. Escavação Arqueológica de Contextos Portuários*, Lisboa, ERA-Arqueologia S.A., Relatório Preliminar 5.
- OERTLING T.  
1996 *Ships' Bilge Pumps. A History of Their Development, 1500-1900*, College Station, Texas A&M University Press.
- SARRAZOLA A., BETTENCOURT J., TEIXEIRA A.  
2014 Lisboa, o Tejo e a Expansão Portuguesa: os mais recentes achados arqueológicos da Lisboa Ribeirinha, in A. Silveira (ed.), *O Tempo Resgatado ao Mar. Catálogo da Exposição*, Lisboa, Imprensa Nacional Casa da Moeda e Museu Nacional de Arqueologia, p. 111-116.
- STANIFORTH M.  
1985 The Introduction and Use of Copper Sheathing: A History, *The Bulletin of the Australian Institute for Maritime Archaeology* 9, p. 21-48.
- VAN DUIVENVOORDE W.  
2012 Use of Pine Sheathing on Dutch East India Company Ships, in N. Günsenin, (ed.), *Between Continents, Proceeding of the Twelfth Symposium on Boat and Ship Archaeology, ISBSA 12, Istanbul 2009*, Istanbul, Ege Yayinlari, p. 241-251.





# SHIP SHAPES: DIGITISING HISTORIC SHIP MODELS

John K. McCARTHY and Wendy VAN DUIVENVOORDE

---

## Abstract

This ongoing PhD project involves the gathering of data on large Dutch merchant ships of the 17<sup>th</sup> and 18<sup>th</sup> centuries and the conversion of that data into a common spatial format. It is hoped that this will give new insights into shipbuilding during this period. As part of this project a large proportion of the known models of this type and period have been digitised in partnership with museums across Europe. Using this data the project also looks at how 3D data of this type can facilitate the dissemination of accurate maritime archaeological data and museum collections to the public.

## Keywords

Netherlands, photogrammetry, 3D reconstruction, ship model, virtual reality

## Résumé

Ce doctorat en cours concerne la collecte d'informations sur les grands navires marchands néerlandais des xvii<sup>e</sup> et xviii<sup>e</sup> siècles et la conversion de ces données dans un format spatial commun. L'objectif est d'obtenir de nouvelles perspectives sur la construction navale de cette période. Une grande partie des modèles de ce type de navires connus pour cette période ont ainsi été numérisés en partenariat avec des musées de toute l'Europe. Le projet examine également comment l'usage de la 3D peut faciliter la diffusion auprès du public de connaissances précises sur l'archéologie maritime et les collections de musées.

## Mots-clés

Pays-Bas, photogrammétrie, reconstruction 3D, maquette de navire, réalité virtuelle

---

## 1. SURVEY

*The families of ships are often very interbred* (Witsen 1671).

*In the course of 100 years it has not been possible to arrive at the proper understanding of any one rate* (Pieter Van Dam, in Stapel 1927).

*It is difficult to judge what the real dimensions of these ships were* (Parthesius 2010, p. 68).

*It is almost impossible to make any hard and fast statements about seventeenth-century ship types* (Hoving 2012, p. 12).

*It is not specifically known what made these fully rigged ships so different from other mercantile ships... and what specific customized features were considered important for their long voyage to Asia* (van Duivenvoorde 2015, p. 39).

The quotations all discuss Dutch merchant ships of the 17<sup>th</sup> and 18<sup>th</sup> centuries and underline the difficulty in obtaining a clear view of the evolving physical qualities of these vessels from both contemporaries and modern researchers. The design of these ships is thought to have played a major role in the rise and fall of Dutch global power in this period, but for many historic vessel types, archaeological evidence remains very limited, due to the small number of located wrecks, the destructive power of the marine environment and the loss of material to treasure hunters and salvors. This is particularly true of large Dutch ocean-going merchant ships of this period, despite their large scale of production over 200 years.

Primary written sources show that there were major changes in design and shipbuilding philosophy occurring across this period in the Netherlands, such as a divergence between warships

and merchant ships, as well as a shift away from bottom-built approaches to sporadic use of the English style of frame-first shipbuilding. Archaeologically surveyed ship hulls have not resolved these issues due to their scarcity, and discoveries have been difficult to place in their proper context.

This PhD project applies a 3D spatial approach to draw evidence from contemporary ship models, iconographic, historical and archaeological sources into a common spatial format. This will provide the most comprehensive possible tracking of trends in Dutch ship design over this period. Contemporary scale models are particularly useful but are scattered in museums across Europe. Researchers have usually relied on a handful of photographs, but scanning allows a much more complete and useful record, and new modes of analysis and dissemination for the benefit of curators, academics and the wider public. Not all the models are likely to represent accurately ships as built, but this spatial approach will allow quantification of that divergence as well as recording historical objects of great interest in their own right.

Around 25 contemporary scale models of these ships survive in museums, mainly in the Netherlands but also in Norway, Belgium and the UK. Although a few models are inaccessible due to staff availability or storage conditions, scanning of most of these contemporary models in Europe was conducted in 2018. Due to their complexity, rigged ship models are one of the most difficult subjects to scan, and a programme of testing and refinement of scanning methods was undertaken throughout 2017 in Australia.

## 2. ANALYSIS

This project aims to create a comprehensive library of scanned ship models of a particular type and will define more precisely what an Indiaman looked like in the 17<sup>th</sup>-18<sup>th</sup> centuries.

Variation will be captured in a way that moves beyond the descriptive into the quantitative. This methodology will be of wider relevance to other classifications of ship types and will demonstrate meaningful ways to combine the 3D underwater survey that has become so widespread in recent years with a wide variety of other data sources to develop typological datasets.

Extensive effort has been put into capturing and gathering 3D data for the fragmentary and widely scattered archaeological remains of VOC ships. Three-dimensional workflows also mean that iconographic evidence can also be exploited more fully through morphometric analysis. For those hull configurations believed to be accurate reflections of built ships, hydrostatic analysis will be carried out using Orca 3D. Ultimately it is hoped that analysis of design trends over a long period can illustrate changing priorities for defence, capacity and seaworthiness through the 17<sup>th</sup> and 18<sup>th</sup> centuries.

### 3. DISSEMINATION

Effective use of 3D technology can powerfully facilitate both archaeological analysis and dissemination to a wider audience. This project explores a wide variety of 3D dissemination methods

aimed both at researchers and the public. One of the most useful is a virtual museum where the scans of the scale models have been brought together for the first time. As the models are held in museums across Europe and are regularly used in exhibitions, it would be impossible to gather them together in this way. The virtual museum also allows the models to be appreciated both in their original size, or at full-size ship scale. The scans of models can also be used in animations, virtual reality wreck-diving experiences, 3D printing and even holographic displays – all of these formats are being created as part of this project. The focus in all cases has been on quantifiable impact, and outputs will be assessed through formal public feedback.

### ACKNOWLEDGEMENTS

This project is funded by the Embassy of the Kingdom of the Netherlands in Canberra and Flinders University. Scanning is carried out in partnership with museums including the Rijksmuseum, the Scheepvaartmuseum, the Amsterdam History Museum, Maritiem Museum Rotterdam, Huis van Gijn in Dordrecht, Zeeuws Maritiem muZEEum, Stadhuismuseum Zierikzee, Aust-Agder Museum in Norway, Museum Aan de Stroom in Antwerp and Greenwich Maritime Museum.



**Fig. 1:** Scans of VOC scale models from several different museums, approximately half of the projected total. These date from the mid-17<sup>th</sup> century to the end of the 18<sup>th</sup> century. In this illustration, all rigging and masts have been removed and models have been scaled to the same size to allow for visual comparison. Models are arranged in rough chronological order, with the oldest at the bottom.

## REFERENCES

- HOVING A. J.  
2012 *Nicolaes Witsen and Shipbuilding in the Dutch Golden Age*. College Station, College Station, Texas A&M University Press.
- PARTHESIUS R.  
2010 *Dutch Ships in Tropical Waters: The Development of the Dutch East India Company (VOC) Shipping Network in Asia, 1595-1660*, Amsterdam, Amsterdam University Press.
- STAPEL F. W. (ED.)  
1927 *Pieter van Dam's Beschryvinge van de Oostindische Compagnie 1693-1701, Eerste Boek, Deel 1*, The Hague, Martinus Nijhoff.
- VAN DUIVENVOORDE W.  
2015 *Dutch East India Company Shipbuilding: The Archaeological study of Batavia and other Seventeenth-Century VOC Ships*, College Station, Texas A&M University Press.
- WITSEN N.  
1671 *Architectura navalis et regimen nauticum. Ofte Aaloude en hedendaagsche scheeps-bouw en bestier*, Amsterdam, Pieter en Joan Blaeu.





# THE SIZE OF WOODEN COMPONENTS IN RELATION TO THE TONNAGE OF GREEK AND ROMAN SHIPS

Emmanuel NANTET

---

## Abstract

This article focuses on the size of tonnage as an impact on the size of wooden components in a ship. It is based on a list of 66 tonnages, elaborated via a methodology employing three methods to determine tonnage (reconstruction of the hull lines, the tonnage formula, and the weight of the cargo). This list notes the thickness of the planking and of the moulded side of the frames. However, the article also explores further factors that are involved, particularly the evolution of the architectural type.

## Keywords

Frame, hull line reconstruction, planking, tonnage

## Résumé

Cet article traite de l'influence du tonnage sur la taille des éléments architecturaux en bois d'un navire. Il repose sur une liste de 66 tonnages, élaborée au moyen d'une méthode employant trois procédés pour déterminer le tonnage (restitution graphique des lignes de coque, formule de jauge et poids de la cargaison). Cette liste note l'épaisseur du bordé et la hauteur des membrures. Cependant, l'article évoque également d'autres facteurs tels que l'évolution des types architecturaux.

## Mots-clés

Membrane, restitution graphique de la ligne de coque, bordé, tonnage

---

## 1. WHAT IS TONNAGE?

Tonnage is the load capacity of a ship – the space that can be used in a boat for merchandise (Nantet 2016). It should not be confused with displacement, which is the overall amount of water moved by the ship while she is sailing. Tonnage gives a valuable clue to estimate the volume of trade. It helps us to understand the scale of trade in which the ship was involved. While ancient mariners used volume units of measurement, historians prefer to provide tonnages with weight units of measurement in order to allow a more relevant comparison to the size of the ships.

## 2. HOW TO ESTIMATE TONNAGE?

The tonnage of a ship can be estimated via three methods (Pomey, Rieth 2005, p. 41-45). The first provides the most accurate results and relies on a close study of the hull remains. Indeed, if a significant part of the hull is preserved, it is possible to reconstruct the original hull lines of the ship and thus the loaded displacement and the deadweight tonnage.

However, this method cannot be carried out in many situations, since the hull remains are not always sufficiently well preserved to allow a reliable reconstruction of the hull lines. In this case, only the overall dimensions of the ship can be estimated. It is possible then to use a formula, similar to those formulas used in the early modern period, to provide a quick estimate of the tonnage of a ship. When used by archaeologists, the 'tonnage formula' provides a result that must be considered as more approximate than the result obtained through the first of our three methods.

Nevertheless, it may be that the hull is not well preserved, which means that the overall dimensions cannot be estimated. It is still possible to add the weight of each item of merchandise found in the shipwreck in order to estimate the weight of the cargo when the ship sunk. Of course, the relevance of this estimate relies heavily on the accuracy of the available data recorded in the field, which can be impacted by many factors, such as looting by unscrupulous divers. In other words, the weight of the cargo, as estimated by archaeologists, can sometimes be very different from the tonnage, if, for example, the ship was loaded with a cargo of organic material, such as grain or fabric, which has not been preserved after 2000 years in the sea.

Therefore, a comparison between the results generated by these several methods is possible. However, it must be carried out with great caution. With caution in mind, this methodology has been applied to 102 shipwrecks (Nantet 2016), and two further, recently published examples, i.e. 104 Mediterranean shipwrecks, dated from the Archaic period to the Muslim conquests in the Mediterranean in the 7<sup>th</sup> century. For this study, only sea-going ships have been considered, while riverboats have been excluded.

## 3. THE TONNAGE, A MAJOR IMPACT ON THE SIZE OF WOODEN ELEMENTS

The database also allowed comparisons to be made between the tonnage of the ships and the size of their wooden elements, such as the thickness of the planking and the moulded side of the frames. Of course, such details about the components

of the hull are not always available, since hull remains might not have been preserved or publications do not include details about the specific locations where measurements were taken.

Thus, only 66 hull remains out of the 104 shipwrecks were sufficiently well documented, although very briefly in most cases (table 1).

**Table 1.** Estimates of the tonnage of ships from their remains and comparison with their wooden components (from Nantet 2016, updated with Poveda *et al.* 2016 and Boetto, Poveda 2018). Measurements show the average size of the component, as far as publications provide such details. Where a double layer exists, the measurement includes the overall thickness of the planking.

| Name                       | Date        | Deadweight tonnage (tonnes) | Methodology                      | Average planking thickness (mm) | Average moulded frame (mm) | References                |
|----------------------------|-------------|-----------------------------|----------------------------------|---------------------------------|----------------------------|---------------------------|
| Mazarrón 1                 | – 650/– 600 | 4                           | Tonnage formula                  | 36                              | 70-80                      | Nantet 2016: no 3         |
| Mazarrón 2                 | – 650/– 600 | 2-2.8                       | Weight of the cargo              | unknown                         | 40                         | Nantet 2016: no 4         |
| Pabuç Burnu                | – 600/– 550 | 16                          | Tonnage formula                  | 32-45                           | unknown                    | Nantet 2016: no 6         |
| Bon-Porté 1                | – 540/– 510 | 2                           | Tonnage formula                  | unknown                         | 110-140                    | Nantet 2016: no 7         |
| Cala Sant Vicenç           | – 530/– 500 | 30                          | Tonnage formula                  | 45-50                           | 310                        | Nantet 2016: no 9         |
| Jules-Verne 9              | – 510/– 500 | 2                           | Reconstruction of the hull lines | 29                              | 100                        | Nantet 2016: no 10        |
| Jules-Verne 7              | – 525/– 500 | 12.2                        | Reconstruction of the hull lines | 25-30                           | –                          | Nantet 2016: no 11        |
| Golo                       | – 510/– 490 | 4.5                         | Tonnage formula                  | 33                              | unknown                    | Nantet 2016: no 12        |
| Grand Ribaud F             | – 510/– 490 | 40                          | Weight of the cargo              | unknown                         | 260                        | Nantet 2016: no 13        |
| Gela 1                     | – 500/– 480 | 40                          | Tonnage formula                  | 50                              | 140                        | Nantet 2016: no 14        |
| Ma'agan Mikhael            | ca. – 400   | 15.9                        | Reconstruction of the hull lines | 25                              | 110                        | Nantet 2016: no 17        |
| El Sec                     | – 375/– 350 | 20                          | Weight of the cargo              | unknown                         | 250-280                    | Nantet 2016: no 18        |
| Kyrenia                    | – 295/– 285 | 23.3                        | Reconstruction of the hull lines | 30-40                           | 80-100                     | Nantet 2016: no 20        |
| Chrétienne C               | – 175/– 150 | 40                          | Tonnage formula                  | 29-36                           | 80                         | Nantet 2016: no 21        |
| Apollonia 1                | – 150/– 80  | 24                          | Tonnage formula                  | 30                              | unknown                    | Nantet 2016: no 22        |
| Carry-le-Rouet             | – 125/– 75  | 25                          | Weight of the cargo              | 60                              | unknown                    | Nantet 2016: no 23        |
| Dramont C                  | – 125/– 75  | 14                          | Tonnage formula                  | 24                              | 58-90                      | Nantet 2016: no 24        |
| Cavalière                  | ca. – 100   | 22.17                       | Reconstruction of the hull lines | 30                              | 90                         | Nantet 2016: no 26        |
| Bénat 2                    | – 125/– 50  | 3.3                         | Weight of the cargo              | 22                              | 55-65                      | Nantet 2016: no 29        |
| Le Miladou                 | – 125/– 50  | 11.25                       | Weight of the cargo              | 25                              | –                          | Nantet 2016: no 30        |
| La Madrague de Giens       | – 75/– 60   | 402.5                       | Reconstruction of the hull lines | 60-100                          | 120-150                    | Nantet 2016: no 31        |
| Kizilburun                 | – 100/– 25  | 54-61                       | Weight of the cargo              | 40-45                           | 140                        | Nantet 2016: no 32        |
| Dramont A                  | ca. – 50    | 111                         | Tonnage formula                  | 55-70                           | unknown                    | Nantet 2016: no 33        |
| Planier 3                  | – 50/– 47   | 32-46                       | Tonnage formula                  | unknown                         | 120                        | Nantet 2016: no 34        |
| Cap Béar 3                 | – 40/– 30   | 9.15                        | Weight of the cargo              | 40                              | 75-95                      | Nantet 2016: no 36        |
| Tre Senghe A               | – 30/– 20   | 58.2                        | Weight of the cargo              | 40                              | 100                        | Nantet 2016: no 37        |
| Comacchio                  | – 25/– 12   | 59                          | Tonnage formula                  | –                               | 160                        | Nantet 2016: no 38        |
| Ladispoli                  | ca. 1       | 20.5-33.7                   | Weight of the cargo              | 40-45                           | 180-200                    | Nantet 2016: no 40        |
| Barthélemy B               | 1/15        | 2.1                         | Weight of the cargo              | 20-25                           | 60-100                     | Nantet 2016: no 41        |
| Saintes-Maries-de-la-Mer 2 | 1/25        | 21                          | Weight of the cargo              | 60                              | 210-230                    | Nantet 2016: no 43        |
| Chrétienne H               | 15/25       | 27                          | Weight of the cargo              | unknown                         | 120                        | Nantet 2016: no 44        |
| La Giraglia                | 15/25       | 33.6-38.6                   | Weight of the cargo              | 29-38                           | 100-155                    | Nantet 2016: no 45        |
| Diano Marina               | 40/60       | 50                          | Weight of the cargo              | 60                              | unknown                    | Nantet 2016: no 49        |
| Antirrhodos Island         | 1/100       | 341                         | Tonnage formula                  | 108                             | 280                        | Nantet 2016: no 50        |
| Dramont I                  | 1/100       | 24                          | Weight of the cargo              | 50                              | –                          | Nantet 2016: no 51        |
| Lardier 4                  | 50/75       | 6.5                         | Weight of the cargo              | 21                              | 55-64                      | Nantet 2016: no 53        |
| Herculanum                 | 79          | 4                           | Tonnage formula                  | 17-20                           | 50                         | Nantet 2016: no 58        |
| Napoli A                   | 75/100      | 16                          | Reconstruction of the hull lines | 32                              | 86.3                       | Boetto & Poveda 2018      |
| Calanque de l'Îne          | 75/110      | 50-80                       | Tonnage formula                  | unknown                         | 140-160                    | Nantet 2016: no 59        |
| Tiboulou de Maître         | ca. 116     | 270                         | Tonnage formula                  | 55                              | 204                        | Poveda <i>et al.</i> 2016 |
| Saint-Gervais 3            | 100/150     | 81.133                      | Reconstruction of the hull lines | 35                              | 130                        | Nantet 2016: no 61        |
| Grado                      | 100/160     | 23-25                       | Weight of the cargo              | 25-45                           | unknown                    | Nantet 2016: no 62        |
| Monfalcone                 | 1/300       | 140-200                     | Tonnage formula                  | 45-55                           | 90                         | Nantet 2016: no 65        |
| La Bourse                  | 160/220     | 142                         | Reconstruction of the hull lines | 60                              | 150                        | Nantet 2016: no 69        |
| Ouest-Embiez 1             | 180/220     | 20                          | Weight of the cargo              | unknown                         | 85-90                      | Nantet 2016: no 71        |
| Torre Sgarata              | 180/220     | 160                         | Weight of the cargo              | 72                              | 80                         | Nantet 2016: no 72        |

| Name                 | Date    | Deadweight tonnage (tonnes) | Methodology                      | Average planking thickness (mm) | Average moulded frame (mm) | References          |
|----------------------|---------|-----------------------------|----------------------------------|---------------------------------|----------------------------|---------------------|
| Giglio Porto         | 200/225 | 30                          | Tonnage formula                  | 35                              | 100-130                    | Nantet 2016: no 74  |
| Punta Scifo A        | 200/225 | 200                         | Weight of the cargo              | 80                              | unknown                    | Nantet 2016: no 75  |
| Punta Scifo B        | 200/300 | 347                         | Weight of the cargo              | 80                              | unknown                    | Nantet 2016: no 79  |
| Laurons 2            | 280/300 | 28.354                      | Restitution graphique            | 25                              | 90                         | Nantet 2016: no 80  |
| Chrétienne D         | 300/320 | 19.7                        | Weight of the cargo              | 25-28                           | –                          | Nantet 2016: no 83  |
| Pointe de la Luque B | 300/325 | 50-65                       | Tonnage formula                  | 30                              | 130                        | Nantet 2016: no 84  |
| Yassı Ada 2          | 350/400 | 100-115                     | Tonnage formula                  | 42                              | 125                        | Nantet 2016: no 85  |
| Dramont F            | 380/400 | 9-11                        | Tonnage formula                  | 30                              | 85-100                     | Nantet 2016: no 87  |
| Fiumicino 1          | 300/500 | 50                          | Reconstruction of the hull lines | 30-54                           | 60-120                     | Nantet 2016: no 89  |
| Fiumicino 2          | 300/500 | 70                          | Tonnage formula                  | 77-90                           | 100-170                    | Nantet 2016: no 90  |
| Fiumicino 3          | 300/500 | 27                          | Tonnage formula                  | 23                              | 55-67                      | Nantet 2016: no 91  |
| Port-Vendres 1       | ca. 400 | 78.740                      | Reconstruction of the hull lines | 40                              | 230                        | Nantet 2016: no 92  |
| Dramont E            | 425/455 | 32.4                        | Reconstruction of the hull lines | 30-40                           | 100-180                    | Nantet 2016: no 93  |
| Parco di Teodorico   | 450/500 | 4-8                         | Tonnage formula                  | 25-30                           | 80-90                      | Nantet 2016: no 95  |
| Tantura A            | 480/600 | 17-22                       | Tonnage formula                  | 25                              | 95                         | Nantet 2016: no 96  |
| Dor 2001/1           | 500/530 | 35                          | Reconstruction of the hull lines | 35                              | 104                        | Nantet 2016: no 97  |
| Dor 2006             | 550/625 | 128-171                     | Tonnage formula                  | 32                              | 85-185                     | Nantet 2016: no 99  |
| Saint-Gervais 2      | 600/625 | 40                          | Tonnage formula                  | 25-30                           | 220                        | Nantet 2016: no 100 |
| Yassı Ada 1          | ca. 625 | 55.765                      | Reconstruction of the hull lines | 35                              | 140                        | Nantet 2016: no 101 |
| Pantano Longarini    | 600/650 | 200                         | Tonnage formula                  | 50                              | unknown                    | Nantet 2016: no 102 |

While the data is neither uniform nor complete, it is possible to propose a comparison and make some comments. Unsurprisingly, the size of the wooden components of the hull is closely related to the tonnage: the bigger the ship, the bigger the frames and the planks. It is no surprise that the thinnest planks – between 17 and 20 mm thick – and the smallest frames – 50 mm moulded – were found on the Herculanium shipwreck (2 tonnes). On the contrary, the Madrague de Giens shipwreck had 120 to 150 mm moulded frames. The planking of her hull was 60 mm thick, even double-layered in the bottom, reaching an overall thickness of 100 mm.

Indeed, the decision to build a small or a large boat relies primarily on three main factors:

- the traffic setting (scale of trade, direct route or redistribution);
- the merchandise, according to the available resources and the needs;
- the sailing conditions (winds and currents, depth of harbours, open or closed sea, nature of the coasts, etc.).

#### 4. CHANGES IN TONNAGE

During the Archaic Period, tonnage does not exceed approximately 30 tonnes, as evidenced by the Cala Sant Vincenç shipwreck. From the end of the 6<sup>th</sup> century AD, tonnage increased slowly but considerably during the two next centuries. In the Hellenistic and Late Republican Periods, the largest ships could load cargoes up to several hundred tonnes, such as the Madrague de Giens shipwreck (402.5 tonnes). Then, in the early Roman Period, the tonnage is still very high for ships carrying stone or wheat as part of state-sponsored traffic. But the tonnage of ships carrying wine, salted fish and olive oil seems to decrease. However, because of the scarcity of data, it is hard to determine precisely the changes in tonnage in the Byzantine Period and

early Middle Ages. In any case, the idea that it would have dropped dramatically must be rejected.

#### 5. FURTHER FACTORS IMPACTING THE SIZE OF WOODEN COMPONENTS

The increase in the size of wooden components is not exactly proportionate to the tonnage. Further factors also impact the size of the frames and the planking, such as (fig. 1):

- the function of the ship;
- the tree species and the tools;
- the navigation area;
- the architectural features of the shipyard;
- the architectural type and the construction system.

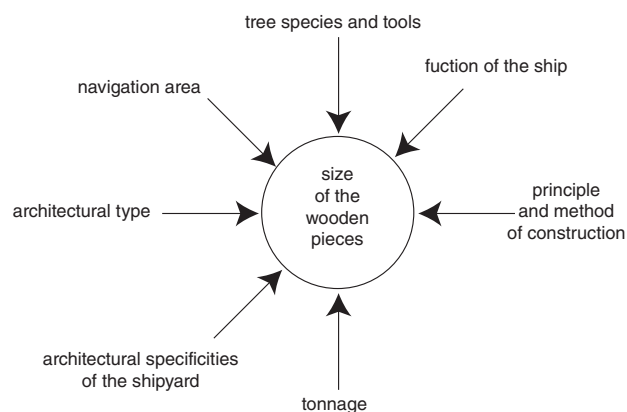


Fig. 1: The various factors that impact the size of wooden components



Indeed, this last factor appears quite important, since Greek Archaic boats, fastened with ligatures, were built with thick planks, usually between 30 and 50 mm. As for the frames, widely spaced, they are very high moulded in comparison with their tiny tonnage: for example, 100 mm for the Jules-Verne 9 shipwreck, although she could carry only 2 tonnes. A few centuries later, the Benat 2 shipwreck, which was found with a cargo weighing 3.3 tonnes, was fitted with a 22 mm-thick planking and *circa* 60 mm moulded frames. Even a large ship like the Madrague de

Giens shipwreck was constructed with 120 to 150 mm moulded frames. After the adoption of mortise-and-tenon joints, it seems that the evolution of construction techniques did not impact the size of wooden components in the next centuries. For example, the transition from shell-first construction to frame-first construction, which changed the concept of the structure of the ship completely (Pomey *et al.* 2012), does not seem to have produced a significant decrease or increase in the dimensions.

## REFERENCES

- BOETTO G., POVEDA P.  
 2018 Napoli A, un voilier abandonné dans le port de *Neapolis* à la fin du 1<sup>er</sup> siècle : architecture, fonction, restitution et espace de navigation, in G. Boetto, E. Rieth, (eds), *De re navali. Pérégrinations nautiques entre Méditerranée et océan Indien. Mélanges en l'honneur de Patrice Pomey*, Paris, CNRS éditions, *Archaeonautica* 20, p. 19-56.
- NANTET E.  
 2016 *Phortia. Le Tonnage des navires de commerce en Méditerranée du VIII<sup>e</sup> siècle av. l'è. chr. au VI<sup>e</sup> siècle de l'è. chr.*, Rennes, Presses Universitaires.
- POMEY P., KAHANOV Y., RIETH É.  
 2012 Transition from Shell to Skeleton in Ancient Mediterranean Ship-Construction: Analysis, Problems, and Future Research, *IJNA* 41.2, p. 235-314.
- POMEY P., RIETH É.  
 2005 *L'Archéologie navale*, Paris, Errance.
- POVEDA P., SABASTIA A., XIMÉNÈS S.  
 2016 Étude architecturale de l'épave Tiboulen de Maire, *Cahiers d'Archéologie Subaquatique* 23, p. 13-33.

# THE *FOUGUEUX* (1785-1805): PROTOTYPE OF AN 18<sup>TH</sup>–19<sup>TH</sup> CENTURY FRENCH CONSTRUCTION METHOD

*In memory of our friend Manuel Izaguirre Lacoste*

Nuria E. RODRÍGUEZ MARISCAL, Nicolás C. CIARLO, Milagros ALZAGA GARCÍA, Éric RIETH  
and Manuel IZAGUIRRE LACOSTE

## Abstract

The 74-gun French ship *Fougueux* (1785-1805) belonged to the Spanish-French fleet that faced the British in the Battle of Trafalgar on 21 October 1805. This warship was lost off the coast of Sancti Petri after the battle. About two centuries later, an array of iron cannons and wooden remains were studied at this site by the Underwater Archaeology Centre of Andalusia. This paper presents the results of the analysis of the ship's construction method, whose particularities place it within the tradition of French naval construction between the late 18<sup>th</sup> century and early 19<sup>th</sup> century.

## Keywords

Battle of Trafalgar, fastenings, *Fougueux*, naval construction, sheathing

## Résumé

Le navire français de 74 canons *Le Fougueux* (1785-1805) appartenait à la flotte franco-espagnole qui affronta les Britanniques lors de la bataille de Trafalgar le 21 octobre 1805. Ce navire de guerre fut perdu au large de Sancti Petri après la bataille. Environ deux siècles plus tard, un ensemble de canons de fer et de vestiges en bois ont été étudiés sur ce site par le Centre d'archéologie sous-marine d'Andalousie. Cet article présente les résultats de l'analyse des méthodes de construction du navire, que ses particularités placent dans la tradition de la construction navale française entre la fin du XVIII<sup>e</sup> et le début du XIX<sup>e</sup> siècle.

## Mots clés

Bataille de Trafalgar, assemblages, *Le Fougueux*, construction navale, doublage

## 1. HISTORICAL BACKGROUND

The *Fougueux* was a third class French ship, according to regulations of ships of the line, and was armed with 74 guns. It was built in L'Orient (now Lorient) in Brittany in 1784, supervised by chief engineer Charles-Jean François Segondant and following the guidelines set out in the *plan-type* Sané-Borda of 74 guns, approved in 1782 (SHM 2G<sup>1</sup> 11; Boudriot, Berti 1995, p. 90-102).

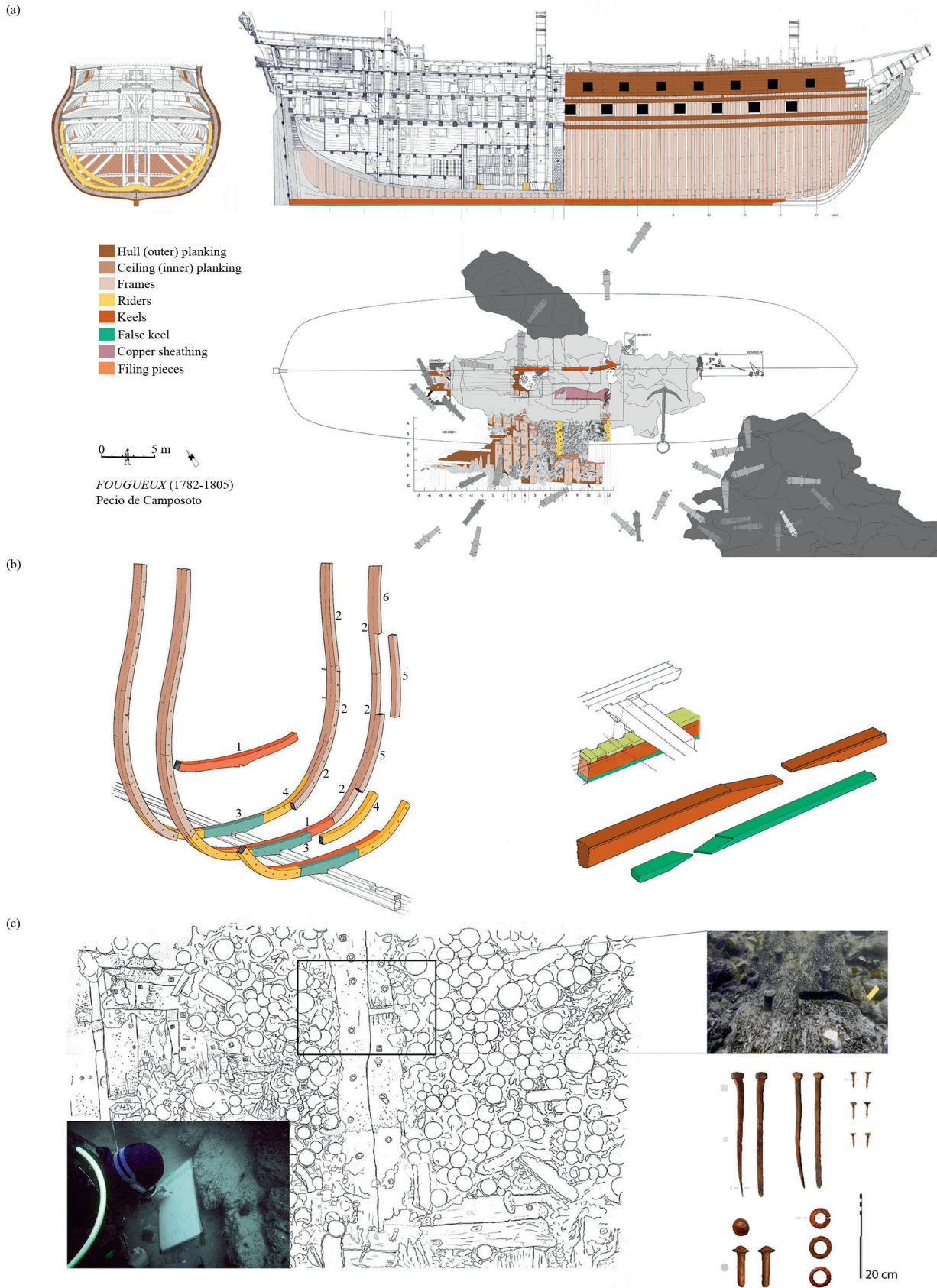
In fulfilment of its mission to defend the Atlantic and Mediterranean French coasts, in 1805 the *Fougueux* joined the combined Spanish-French squadron under the command of Vice-Admiral Pierre-Charles Villeneuve. On 21 October of the same year, Villeneuve was to face the British fleet commanded by Admiral Horatio Nelson off the coast of Barbate in the well-known Battle of Trafalgar. After undergoing a hard confrontation, the *Fougueux*, unmasted and ungoverned, was taken and towed as a prize of war by the British ship *Temeraire*. Finally, the *Fougueux* was abandoned to her fate in the middle of a strong storm that broke after the battle. The last news of the French ship indicated that it was lost, breaking on the rocky slopes of Sancti Petri in the early hours of 22 October (Lon Romeo 2005, p. 341).

About two centuries later, a set of iron cannons, an anchor of large dimensions, and wooden remains of what appeared to be a gunship were discovered in an area near to where documentary sources situated the shipwreck of the *Fougueux*.

## 2. ARCHAEOLOGICAL RESEARCH

The site, located at Sancti Petri, Cadiz, Spain, sits between two rocky formations and is partially buried in sand at an average depth of 8 m. The Underwater Archaeology Centre of Andalusia conducted three excavation seasons between 2006 and 2008. Archaeological research at this site enabled the identification of the shipwreck as the remains of the *Fougueux*. The studies focused on the hull remains, armaments, nautical equipment, personal possessions and other objects carried onboard (Rodríguez *et al.* 2010). The archaeological data related to shipbuilding indicated that the technical characteristics of the structural remains have a close correspondence to the French construction method of the late 18<sup>th</sup> to early 19<sup>th</sup> century, which is defined by the adoption of the Sané-Borda (1782) type plans (fig. 1-a) (Rodríguez *et al.* 2013, 2014, for a detailed account of the analyses).

The main architectural evidence identified at the site is notably related to the design and morphological characteristics of the ship's structural elements defined in this construction system. The surviving keel has a length of about 18 m, a width of 40 cm – *circa* 15 inches, being the dimension proposed by Sané (Boudriot 1977, p. 157) – and a minimum thickness of 42 cm, given that its upper side is slightly deteriorated. Additionally, it has a false keel of similar width and a thickness



**Fig. 1:** (a) A comparison between the Sané-Borda (1782) type plan of a French ship-of-the-line and the hull remains of the Fougueux (1785-1805) (drawings after Boudriot 1977, pl. 11, 12 and 15); site plan and photographs IAPH-CAS Graphic Background 2006-2007, Spain). (b) The framing pattern (left): 1, floor timber (varangue); 2 and 5, second, third, etc. futtocks (allonges); 3, half-floor timber (demi-varangue); 4, first futtock (genou); 6, half futtock (demi-allonge). The keel assembly (right): rising wood (contre-quille) along all the keel's length, keel (quille) and false keel (fausse-quille) (drawings after Boudriot 1977, p. 81). (c) Hull copper fastenings: a rider and its clench ring bolts are shown in detail (site plan and photographs IAPH-CAS Graphic Background 2006-2007, Spain).

of 15 cm. Each double frame has a floor timber of *circa* 34-39 cm and a first futtock of *circa* 32-35 cm sided, transversally joined with iron bolts. This feature indicated that the double frames correspond to pre-designed frames (the French *couples de levée*), which were assembled prior to mounting, as is shown in the models designed by Sané (Boudriot 1977, p. 66-67). Each double frame is composed of a full floor timber (*varangue*), which is joined to the keel, and followed by the second, third, etc. futtocks (*allonges*): and of a half-floor timber (*demi-varangue*), with first futtock (*genou*), second, third, etc. futtocks (*allonges*) (fig. 1-b).

Half-floor timbers, which were recorded in the northwest area of the site, were incorporated into French ship construction from the late 18<sup>th</sup> to early 19<sup>th</sup> centuries to improve the transversal strength of the hull structure. The space between frames near the midship section is 10-12 cm on average. On the other hand, the poor state of preservation of the wooden remains, which exhibited massive concretions, made it impossible to clearly identify the midship frames and pre-designed frames installed subsequently. Additionally, filling pieces (*clés*) inserted between the frames were recorded longitudinally at three levels (along the frames' length). These elements were used to reinforce the transversal structure of the hull (see Rodríguez Mariscal *et al.* 2013, for additional data on the construction features recorded).

Apart from the indicative structural features mentioned above, other hull elements were recorded. Inner planking was distinguished in some areas, but it remains in a very poor condition. Regarding outer planking, it is arranged in pairs of similar width, showing a range from about 18 | 18 cm to 35 | 35 cm, while the thickness varies between 9 and 11 cm (measured near the keel) and 20 cm (between the lower and orlop decks). Wood anatomy analyses determined that the keel, false keel, frames and planking were made of oak (*Quercus robur*).

Several fastenings belonging to the lower part of the hull were located at the site (fig. 1-c). Some were still associated with the timbers, while others were scattered. The hull was copper-sheathed, while lead sheets were used on the false

keel for additional mechanical protection, and both were fastened with copper-base sheathing tacks. The latter feature is consistent with historical data for French ships (Boudriot 1975, p. 242). The main dimensions recorded for recovered fastenings (dispersed pieces) are the following: bolts (up to 900 mm length and 25-30 mm diameter); spikes (about 275 to 300 mm length); and sheathing tacks (37 mm length on average) (see Ciarlo 2016, for more details on formal features).

Metallurgical examination was conducted by light microscopy, scanning electron microscopy, X-ray energy dispersive spectroscopy, optical emission spectrometry, and atomic absorption spectrometry. The analytical data indicated that the raw material used for the sheets was 99.8% copper (Bethencourt 2010). Bolts and spikes were handmade and primarily by a hot forging process with unalloyed copper. As far as the bolts are concerned, this evidence further suggested that traditional copper fastening production techniques continued long after the improvements made in Britain by William Forbes (1783) and other patents of grooved rollers (Ciarlo 2016). Metallurgical characteristics of *Fougueux*'s samples showed a high degree of similarity to remains recovered from another contemporary site, helping to associate them with the remains of the *Bucentaure* (1805), flagship of the combined Franco-Spanish fleet (Bethencourt 2008-2009; Ciarlo *et al.* 2014).

### 3. CONCLUSIONS

We have presented a brief examination of the structural remains of the *Fougueux* (1785-1805) in this paper. Archaeological research conducted at this site allowed the identification of a series of technical features of the construction method proposed by Sané-Borda in 1782. Given that the *Fougueux* was one of the first warships of this kind, her remains shed new light on how this French system was put into practice in its early years.

## ARCHIVES

SHM 2G<sup>1</sup> 11 Service Historique de la Marine, Rochefort, *Marine 1784, Port de L'Orient, Construction à l'Entreprise, pour la main-d'oeuvre de charpente du vaisseau du Roi le Fougueux de 74 Canons*

## REFERENCES

BETHENCOURT M.

2008-2009 Adaptation of Archaeometry Techniques to the Study of 18th- to 20th-century Copper Sheathing in Ships, *Historical Metallurgy Society (HMS) News* 70, p. 3-4.

2010 *Caracterización de forro, pecio de Camposoto*, Corrosion and Protection Laboratory, Department of Material Science and Metallurgy Engineering and Inorganic Chemistry, School of Marine and Environmental Sciences, University of Cadiz, Puerto Real, Andalusia, Spain.

BOUDRIOT J.

1975 *Le Vaisseau de 74 Canons – Traité Pratique d'Art Naval*, vol. 3, Paris, éditions des Quatre Seigneurs, Collection Archéologie Navale Française.

1977 *Le Vaisseau de 74 Canons – Traité Pratique d'Art Naval*, vol. 1, Paris, éditions Jean Boudriot, Collection Archéologie Navale Française.

BOUDRIOT J., BERTI H.

1995 *Les Vaisseaux de 74 à 120 Canons. Étude historique, 1650-1850*, Paris, A.N.C.R.E., Collection Archéologie Navale Française.



CIARLO N. C.

- 2016 *Innovación tecnológica y conflicto naval en Europa Occidental, 1751-1815: aportes arqueológicos e históricos al conocimiento de la metalurgia y sus aplicaciones en los barcos de guerra*, PhD thesis (Archaeology), School of Philosophy & Letters, University of Buenos Aires, Argentina.

CIARLO N. C., DE ROSA H., LUCCHETTA M. C., MARINO P., RODRÍGUEZ N., MARTÍ J., MAXIA G.

- 2014 Estudio comparado de dos navíos franceses de la Batalla de Trafalgar: los elementos de fijación estructurales del *Fougueux* (1785-1805) y *Bucentaure* (1804-1805), in D. Juanes, C. Roldán (eds), *Actas del X Congreso Ibérico de Arqueometría*, Castellón, Subdirección de Conservación, Restauración e Investigación IVC+R de CulturArts Generalitat, p. 217-229.

LON ROMEO E.

- 2005 *Trafalgar. Papeles de la Campaña de 1805*, Excma / Zaragoza, Institución Fernando el Católico / Diputación de Zaragoza.

RODRÍGUEZ N. E., RIETH É., IZAGUIRRE M.

- 2010 Investigaciones en el pecio de Camposoto: hacia la identificación del navío francés *Fougueux*, *Boletín Instituto Andaluz del Patrimonio Histórico* 75, p. 94-107.

RODRÍGUEZ N. E., ALZAGA M., IZAGUIRRE M., RIETH É., MÁRQUEZ L., ACERRA M.

- 2013 El *Fougueux*, análisis del sistema constructivo de un navío de línea de la armada imperial de Napoleón Bonaparte, in X. Nieto, A. Ramírez, P. Recio (eds), *I Congreso de Arqueología Náutica y Subacuática Española*, Cartagena, Ministerio de Educación, Cultura y Deporte, p. 575-592.

RODRÍGUEZ N. E., ALZAGA M., MARTÍ J., RIETH É., IZAGUIRRE M.

- 2014 El *Fougueux*, Trafalgar (1805). Un navío construido y artillado para la batalla, in R. Castillo, A. Ramírez, L.A. Torres (eds), *IKUWA V, Proceedings of the 5th International Congress on Underwater Archaeology*, Cartagena, Ministerio de Educación, Cultura y Deporte, p. 1036-1038.

# VIKING BOATS IN MEDIEVAL RUSSIA FROM WRITTEN AND ARCHAEOLOGICAL EVIDENCE

Petr SOROKIN

---

## Abstract

Mention of Viking vessels in Russia is rare and brief both in Russian *letopis* (chronicles) and in ancient Nordic literature. Foreign-language boat names were usually used in medieval Russian documents to designate foreign vessels, while local vessels, as well as their parts and rigging, practically always had local names. Archaeological data of boat finds from the territory of early medieval Russia includes elements of Scandinavian vessels and representations of Viking boats. They have been discovered in medieval layers of Russian towns along the main inland water routes connected with the Baltic from the mid-8<sup>th</sup> to early 11<sup>th</sup> centuries, and in boat graves. The Scandinavian boatbuilding tradition existed here in the period of intensive Russian-Scandinavian contacts during the Viking Age.

## Keywords

Boatbuilding, medieval Russia, rivets, ship, vessel, Viking

## Résumé

Les mentions des navires vikings en Russie sont rares et brèves tant dans les *letopis* (chroniques) russes que dans la littérature nordique ancienne. Les noms de bateaux en langue étrangère étaient généralement utilisés dans les documents russes médiévaux pour désigner les navires étrangers, tandis que les navires locaux, ainsi que leurs pièces et gréements, portaient pratiquement toujours des noms locaux. Les témoignages archéologiques de bateaux du début du Moyen Âge sur le territoire de la Russie comprennent des éléments de navires scandinaves et des représentations de bateaux vikings. Ils ont été découverts dans les niveaux médiévaux de villes russes situées le long des principales voies navigables intérieures reliées à la Baltique du milieu du VIII<sup>e</sup> au début du XI<sup>e</sup> siècle, ainsi que dans des bateaux-tombes. La tradition de la construction navale scandinave a existé en Russie au moment des contacts intensifs russo-scandinaves de l'époque viking.

## Mots-clés

Construction navale, Russie médiévale, rivets, bateau, navire, Viking

---

The development and spread of early medieval boatbuilding traditions in the Baltic region is an important topic related to the history and contacts of its peoples. The study of it is especially advanced with an accumulation of archaeological data since the mid-20<sup>th</sup> century.

One of the main criteria for differences in the boatbuilding traditions is the method of plank connection and caulking. The joining of overlapping wooden planks (clinker-built) with iron rivets and wool caulking was used by Scandinavians, whereas wooden nails with moss caulking were used by western Slavs (Crumlin-Pedersen 1991, p. 72). The sewing technique with various vegetal fibres and roots, and moss caulking is associated with Sami, Finnish and Russian boatbuilding (Westerdahl 1985, p. 52-55, 1995, p. 233-260; Forssell 1995, p. 201). The Vikings visited and settled some Russian areas in early medieval times. The extent of the use of Scandinavian vessels or boatbuilding tradition in Russia, the distribution, type and size of vessels, as well as the period of this use are the subject of this study.

## 1. ARCHAEOLOGICAL DATA OF VIKING SHIP ELEMENTS

Parts of medieval vessels and elements of their gear have been excavated in medieval layers of Russian towns and in boat burials. Boats with clinker planking have been identified among

several construction technique types of archaeological vessels, but they are not the most common. The natural conditions of Rus' – low-lying areas with fast-flowing rivers linking towns with the sea, as well as rich forests – meant the predominance in this region of flat-bottomed vessels and plank boats with a dugout base. Such boats were suited for the transportation of people and cargo over long distances and could successfully overcome obstacles on rivers and lakes. The clinker-built boats, according to archaeological finds, had two types of plank connection. The first, using iron rivets, is confirmed by finds from Staraya Ladoga dating back to the mid-8<sup>th</sup> century, and belongs to the Scandinavian boatbuilding tradition (Rjabinin, Sorokin 1998). The second, sewing with bast ropes or pine tree roots is of local origin and is confirmed by Novgorod finds dating to the 10<sup>th</sup> century (Dubrovin *et al.* 2001).

Boat rivets, sometimes with fragments of wooden planks adjoined, have been found primarily in the towns of northern Russia connected by river systems to the Baltic Sea (fig.1.1, 9-12, fig. 2.1). They date from the mid-8<sup>th</sup> to the early 11<sup>th</sup> century, although some finds have turned up in archaeological layers of the 12<sup>th</sup> to 17<sup>th</sup> centuries. Boat rivets dating to the 10<sup>th</sup> to early 11<sup>th</sup> century have been found in the settlements of the Dnieper basin, Gnezdovo and Shestovitsy, and in the Upper Volga at Timerevo and Sarskoye Gorodische, separated from the Baltic by portages (fig. 1.5-8).

Boat graves and graves with boat parts in cremation burial mounds of the mid 9<sup>th</sup> to early 11<sup>th</sup> centuries have been



**Fig. 1:** The main settlements and boat graves with finds of boat rivets in the territory of ancient Russia: 1. Staraya Ladoga; 2. Ust'-Rybezna; 3. Kalmaniemi; 4. Zalahtovie; 5. Gnezdovo; 6. Shestovitsy; 7. Timerevo; 8. Sarskoe Gorodische; 9. Beloozero; 10. Novgorod; 11. Pskov; 12. Polock.

discovered in the Ladoga Lake area (Staraya Ladoga, Ust'-Rybezna and Kalmaniemi) (fig. 1.1-3), in the Upper and Middle Dnieper (Gnezdovo, Shestovitsy), and in the Upper Volga (Timerevo) (fig. 1.5-7). Mounds with such burials have different shapes and sizes, reaching 11-38 m in diameter and 0.5-8 m in height: the cremation sites inside mounds vary in size from 6 × 3 m to 23.5 × 12.8 m. They have been recognised by the concentrations of iron rivets that connected boat parts. From about 100 burials with rivets, only 11 included 50 to 276 examples, most of them have only one to three. A few of them can be used to determine the approximate dimensions of the vessel. The reconstructed length of the burned boats is about 6 to 10 m, which corresponds to the average size of vessels in Viking-age burial mounds of central Sweden (Sorokin 2018).

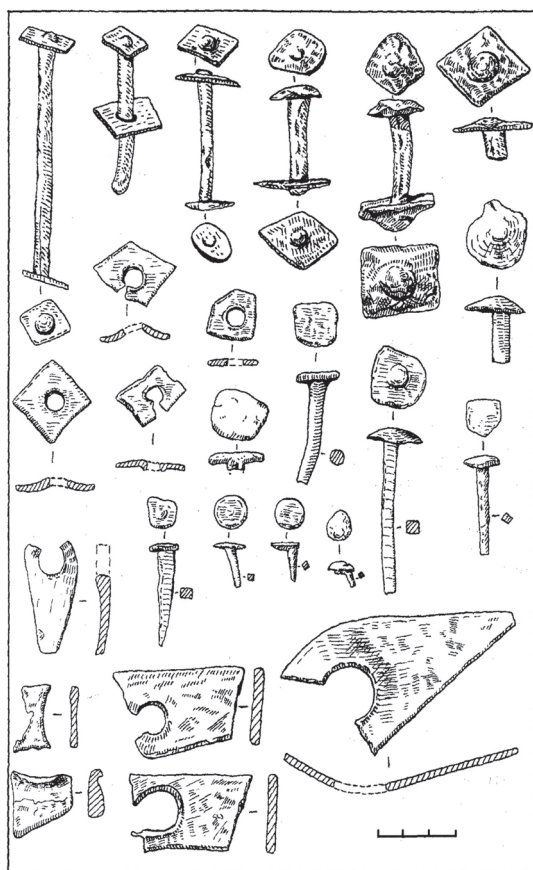
The length of the iron rivets varies from 2.1 to 8.7 cm, with shaft diameter of 0.4 to 1 cm. The shafts are mostly of irregular shape, rounded in section, and tend to become thicker from the middle to the edges, although there are also some rivets rectangular and round in section. Based on size, shape and general context of the finds, most of the rivets are interpreted as elements from vessels. J. Bill, who has studied ship rivets in different parts of northern Europe, concluded that there are local variations that can be distinguished by the shape of the shaft: a rounded section in Scandinavia and square in Slavic and Finnish zones (Bill 1994). The study of boat rivets in the

territory of Russia shows that the first version prevails, but the second is also present. This may indicate that the majority of boat rivets found in Russia are of Scandinavian origin.

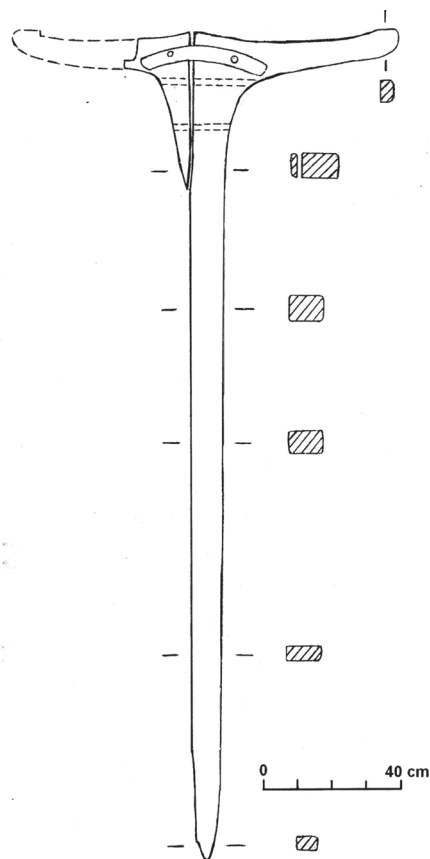
The joining technique using iron rivets was not at all typical of medieval Russian craft production and such evidence is seldom found in urban layers, except in towns located along the main water routes in areas with Scandinavian populations. The technique was brought to northwest Russia by Scandinavians as early as the 8<sup>th</sup>-9<sup>th</sup> centuries.

Apart from rivets and fragments of wooden planks, some other elements of rigging and equipment found in Staraya Ladoga also originate from clinker-built boats, probably ore ships (Sorokin 2006, p. 157-162). These include several variants of rowlocks fastened to a vessel's plank through holes in their base with the help of wooden treenails or binders. A T-shaped post for a ship's tent (2.4 m tall and about 1.2 m wide) with an extension of the upper part for laying yards was excavated by the wooden causeway, dated to 865-920, near a large Viking house (fig. 2.2). Its structure and size are similar to a post from the Gokstad ship. Such an element could only be used on large ships. Its upper part has a carved graffito of a Scandinavian deity with a pointed beard and long moustache that resembles Thor in appearance. A similar graffito was on a tent post from the Oseberg ship. Images of deities on ships' tents served as amulets reflecting some religious tradition connected with navigation.





1



2

Fig. 2: Finds from Staraya Ladoga of elements from vessels: 1. Boat rivets, mid-8<sup>th</sup> century (after Rjabinin, Sorokin 1998); 2. T-shaped post for a ship's tent (drawing P. Sorokin).

A graffito on a bone comb and on a piece of birch bark, both depicting a large ship with high arched stem and stern, common for Scandinavian vessels, with a mast in one case, and with a square sail in the other, with rigging and flag, were found in archaeological layers of the 9<sup>th</sup>-11<sup>th</sup> centuries in Pskov and Staraya Ladoga.

Some of the boat finds could belong to different types of vessel, but most likely to clinker-built boats. These include elements of a vessel's equipment: rudders and rowing oars, rowlocks, frames, and elements of rigging.

## 2. WRITTEN SOURCES CONCERNING VIKING BOATS

Mention of Scandinavian vessels in northwest Rus' dating back to the Viking Age are rare and brief both in Russian *letopis* (chronicles) and Nordic literature of the 12<sup>th</sup>-13<sup>th</sup> centuries. Scandinavian vessels that sailed into Ladoga Lake at the end of the 10<sup>th</sup> to mid-11<sup>th</sup> century are mentioned in sagas as *skip* (ship). Runic stones of central Sweden bear mentions of ships that used to sail along the *austerweg* (the eastern way): *knorr*, *knar* – a large ore cargo and military ship; and *skeid* – a large military ship. One inscription of the 11<sup>th</sup> century contains information about Sigvid who “fell in Holmgard”

(Novgorod) (Mel'nikova 1977, p. 34, 77-93, 111, 191; Sorokin 2017, p. 50).

Documents describing Russian medieval life mention about 20 variants of vessel names. They include generic and proper, Russian and foreign names. The *Russkaya Pravda* legal code of the mid-11<sup>th</sup> century mentions among certain types of vessels a *sea lodia* or *overseas lodia*, which could also be used for Scandinavian ships. Russian documents describing events since the 12<sup>th</sup> century name some types of Scandinavian vessels that came to the Russia from the Baltic Sea, predominantly during military campaigns: *korabl* and *sneka*. The *sneka* was a large sailing and rowing boat that is frequently mentioned in the Scandinavian literature. *Korabl* was a Russian generic name for large seagoing vessels (Sorokin 2017, p. 50). Normally the *sneka* had about 20 pairs of oars (Jesch 2001, p. 126), but larger versions could hold 30 rowing benches (Struluson 1980, p. 142).

Visits to Ladoga by Scandinavian nobles, including representatives of royalty, during the reign of Prince Vladimir and Prince Yaroslav (970-1054) were also likely to have been made on large Viking ships, which corresponded to their status and provided security. The Orkneying Saga tells us of an embassy that arrived from Norway to Aldeigjuborg (Staraya Ladoga) to take Magnus, Saint Olaf's son, from Prince Yaroslav, continuing on from there to Holmgard (Novgorod) by horse. When their mission was complete, “...down to Aldeigjuborg



they sailed, and brought ships there; they set forth from the East as soon as ice disappeared". The Saga of Harald Hardrada has a similar trip description, "... He got ready and sailed from Holmgard, and travelled to Aldeigjuborg in spring, took a ship there, and sailed from the East in summer" (Glazyrina, Dzhakson 1987, p. 87 and p. 81). According to "The History of Norway", Olav Tryggvasson, another would-be king of Norway, while serving Prince Vladimir, undertook sea raids to Baltic shores, supposedly from Ladoga: "After he had conquered many lands and cities for King Valdemar, ... he set forth for home to Gardy" (Dzhakson 2000, p. 38 and p. 40). Written records contain only general information about the Scandinavian vessels that visited Russia, but they were all sea-going and in most cases could not navigate inland waterways.

### 3. CONCLUSION

Russia was included in Baltic connections from early medieval times and had economic, political and military relations with Scandinavian peoples. The spread of Scandinavian boatbuilding traditions in Russia according to archaeological and written data coincides mainly with the areas of Viking presence in Russia. Iron rivets and wooden elements belonging to the vessels, and graffiti of ships are found primarily in towns of northwest Russia: Staraya Ladoga, Novgorod and Pskov. The signs of this tradition are fixed along the main waterways of Eastern Europe during the Viking Age (mid 8<sup>th</sup>-early 11<sup>th</sup> centuries), a period of intensive contacts between Russia and Scandinavia. Evidence of the use of clinker-built boats has been discovered in the Dnieper basin and in the Upper Volga region. In addition to iron rivets and fragments of wooden planks, some other parts of rigging probably also originate from Scandinavian boats and ships (fig. 2.2).

A comparative analysis of written and archaeological sources shows that large Scandinavian ships stopped at Staraya Ladoga,

the closest town to the Baltic Sea. Smaller plank boats (6-9 m long), similar to the Gokstad ships 1-3, were used for communications up the inland water systems of Eastern Europe because they could easily sail in shallow waters and could be portaged over rapids both by water and by land. From the 9-10<sup>th</sup> century, clinker-built boats assembled with iron rivets were visiting the basins of both the Dnieper and Volga Rivers, from where they could pass through to the Black and Caspian Seas. We cannot, however, rule out the possibility that some parts of the clinker planking may have belonged to boats with a dugout base. Russian and Byzantine chronicles mention two types of vessels used in the Black Sea during Russian expeditions to Byzantium in the 9<sup>th</sup> to early 11<sup>th</sup> century. The Arab traveller, Ibn Fadlan, gives a detailed description of a Russian nobleman's boat burial in the Upper Volga in 921. In both cases, the vessels described appear to be large. The types and sizes of vessels used for sailing along the inland waterways of Eastern Europe "from the Varangians to the Greeks" and "to Arabian East" (Likhachev 2007, p. 8-9) were chosen in accordance to the purpose and the natural and political possibilities of travelling.

No reliable evidence of building clinker vessels with iron rivets in Russian towns has been found so far, although there are potential signs of this on the sites: iron and woodworking industries with all the necessary tools and resources. It is unknown whether all vessels of this type came from Scandinavia or some of them were built in Russia. In early medieval Russia, where inland waterways prevailed, local types of vessels were mainly used for such voyages. The method of joining planks with iron rivets, common in Scandinavian places of residence in Russia, did not spread into local boatbuilding. Traditional shipbuilding on the White and Barents Seas in the 19<sup>th</sup> century produced a type of ship known as *schnjaka*, close to the Scandinavian *sneka*, however, the connection of the planks followed a local technique of sewing. Thus, the Scandinavian shipbuilding tradition in Russia was mainly typical of people from Scandinavia during the Viking Age.

### REFERENCES

- BILL J.  
1994 Iron nails in Iron Age and Medieval Shipbuilding, in C. Westerdahl (ed.), *Crossroads in Ancient Shipbuilding, Proceedings of the Sixth International Symposium on Boat and Ship Archaeology (ISBSA 6)*, Roskilde 1991, Oxford, Oxbow Books, p. 54-63.
- CRUMLIN-PEDERSEN O.  
1991. Ship Types and Sizes AD 800-1400, in O. Crumlin-Pedersen (ed.), *Aspects of Maritime Scandinavia AD 200-1200, Proceedings of the Nordic Seminar on Maritime Aspects of Archaeology, Roskilde 1989*, Roskilde, Viking Ship Museum, p. 69-82.
- DUBROVIN G. E., OKOROKOV A.V., STARKOV V.F., CHERNOSVITOV P. JU.  
2001 *Istorija severorusskogo sudostroenija*, Sankt-Petersburg, Aleteja.
- FORSSELL H.  
1995 *Mekrijarvibaten. Batar 2*, Lovisa, Skrifter utgivna av Skargardsmuseet.
- GLAZYRINA G.V., DZHAKSON T.N.  
1987 *Drevnerusskie goroda v drevneskandinavskoj pis'mennosti*, Moskva, Nauka.
- DZHAKSON T. N.  
2000 *Chetyre norvezhskih konunga na Rusi*, Moskva, Jaziki Russkoy Kulturi.
- JESCH J.  
2001 *Ships and Men in the Late Viking Age. The vocabulary of Runic Inscriptions and Skaldic Verse*, Woodbridge, Boydell & Brewer.
- MEL'NIKOVA E. A.  
1977 *Skandinavskie runicheskie nadpisi*, Moskva, Vostochnaja literatura.
- LIKHACHEV D. S. (ED.)  
2007 *Povest' vremennih let*, Sankt-Petersburg, Nauka.

- RJABININ E. A., SOROKIN P. E.
- 1998 Nekotorye sudovye nahodki iz raskopok v Staroy Ladoge, in *Izuchenie pamjatnikov morskoy arheologii* 3, St Petersburg, The Institute of the History of Material Culture, Russian Academy of Science, p. 187-194.
- SOROKIN P. E.
- 2006 Staraya Ladoga: a Seaport in Medieval Russia, in L. Blue, A. Englert, F. Hocker (eds), *Connected by the Sea. Proceedings of the Tenth International Symposium on Boat and Ship Archaeology (ISBSA 10)*, Roskilde 2003, Oxford, Oxbow Books, p. 157-162.
- 2017 The medieval vessels in northwestern Russia in written and archaeological sources, in J. Litwin (ed.), *Baltic and Beyond, Change and Continuity in Shipbuilding, Proceedings of the Fourteenth International Symposium on Boat and Ship Archaeology (ISBSA 14)*, Gdańsk 2015, Gdańsk, National Maritime Museum, p. 49-52.
- 2018 The boats from graves on the territory of Old Russia, *Stratum plus* 5, p. 235-250.
- STRULUSON S.
- 1980 *Krug zemnoi*, Moskva, Nauka.
- WESTERDAHL C.
- 1985 Sewn boats of the North: A preliminary catalogue with introductory comments. Part 1, *IJNA* 14.1, p. 33-62.
- 1995 Samischer bootsbau, teil 1, *Deutsches Schifffahrtarchiv* 18, p. 233-260.



# SOUTH AND NORTH: THE LINGUISTIC MYSTERIES OF THE *BUSS*

Katrin THIER

## Abstract

As the variety of names for ship types in the 12<sup>th</sup> and 13<sup>th</sup> century is greater than that of the archaeological evidence from the period, this is an attempt to contribute to the wider study of ship types by tracing the evidence provided by one particular word, which was in use both in northern and southern Europe at the time.

## Keywords

Language, Middle Age, Mediterranean, North Sea, ship types

## Abstract

Compte tenu de la grande variété des noms des types de navires aux XII<sup>e</sup> et XIII<sup>e</sup> siècles, qui sont bien plus nombreux que les attestations archéologiques contemporaines, il s'agit ici d'une tentative de contribuer à une étude plus large des types de navires en repérant les témoignages fournis par un mot particulier, *buss*, qui était utilisé aussi bien dans le nord que dans le sud de l'Europe à cette époque.

## Mots-clés

Langue, Moyen Age, Méditerranée, mer du Nord, type de navire

*Buss* is one of a number of new words that appear in the 12<sup>th</sup> and 13<sup>th</sup> centuries against a background of increased sea traffic between southern and northern Europe, which led to innovation and technological exchange. However, while it is now well documented as a type of North Sea fishing boat, its geographical origin and early history are far from clear.

The following is an attempt to approach this problem by treating the word as a type of artefact with particular features, which can be dated and mapped in the absence of physical evidence<sup>1</sup>. One such feature is pronunciation: many spellings suggest that the word for *buss* in a particular language<sup>2</sup> was pronounced with /ts/ in the middle, others suggest /s/. We know that /ts/ developed into /s/ in some languages, but the reverse does not usually happen, so /ts/ was probably original. However, it is sometimes difficult to tell the difference, as not all letters (like *c* and *z*) were used consistently<sup>3</sup>. Grammatical gender is also of interest: while the word is usually feminine, some languages also have unexpected masculine forms.

## 1. EVIDENCE

The very earliest evidence appears to be the short-lived compound *butse-carl* (*buss*-man), which is unique to England and was either formed in English or locally in a Scandinavian language. The compound first appears in a manuscript of the

late 11<sup>th</sup> century<sup>4</sup>, so the simple word must already have existed in one of these languages.

There are also very early examples in German (SuH 216.63, 11<sup>th</sup>/12<sup>th</sup> century)<sup>5</sup>, and Judaeo-French (Rashbam<sup>6</sup>, 12<sup>th</sup> century); both in academic contexts and from inland areas, suggesting that the word was already known beyond seafaring circles. It also appears in some 12<sup>th</sup>-century German and French romances, mostly in encounters with the 'Saracens'<sup>7</sup> of Spain in a fictionalised past<sup>8</sup>.

On the continental North Sea coast the word is often associated with fishing from an early date, and now survives denoting a fishing boat in Dutch and Low German<sup>9</sup>. The earliest evidence from this region is in an 1163 Latin document from Flanders<sup>10</sup>; Low German forms appear in the 14<sup>th</sup> century and have a variety of distinctive forms, reflecting both types of pronunciation, and some odd masculine-looking forms (with *-en*; e.g. *butzen*: Paulsen 2016, p. 841 and p. 889). Such variation may have various reasons, both external and internal and may (but need not!) go back to a time when the word was forming.

4. Earliest in the *Anglo-Saxon Chronicle* for 1052 (ASC MS C); the compound also appears in Latin and Anglo-Norman French in the early 12<sup>th</sup> cent (later instances quote or copy earlier sources). Compare the discussion of these in OED3 at BUSCARL n.

5. As *buzo*, translating Latin *paro* 'ship suitable for pirates', in a passage based on Isidore of Seville's major 7<sup>th</sup> century reference work.

6. In Hebrew letters as *bwš* /*bwšš*, translating Hebrew *bišit* 'kind of ship' in a commentary on the Talmud. Attributed to Rashbam's grandfather Rashi (11<sup>th</sup> century) in FEW at BŪZA; I am grateful to Mark Kiwitt, then of the *Dictionnaire Étymologique de l'Ancien Français* for the correction (personal communication 2011).

7. I use 'Saracens' to refer to the fictional enemy of medieval romances, to distinguish them from historical Muslim peoples.

8. Especially stories set in the period of Charlemagne (e.g. *Rolandslied* cited in MWB).

9. Hence later English *buss* for a fishing boat (1471; OED3 at BUSS n./1 sense 2).

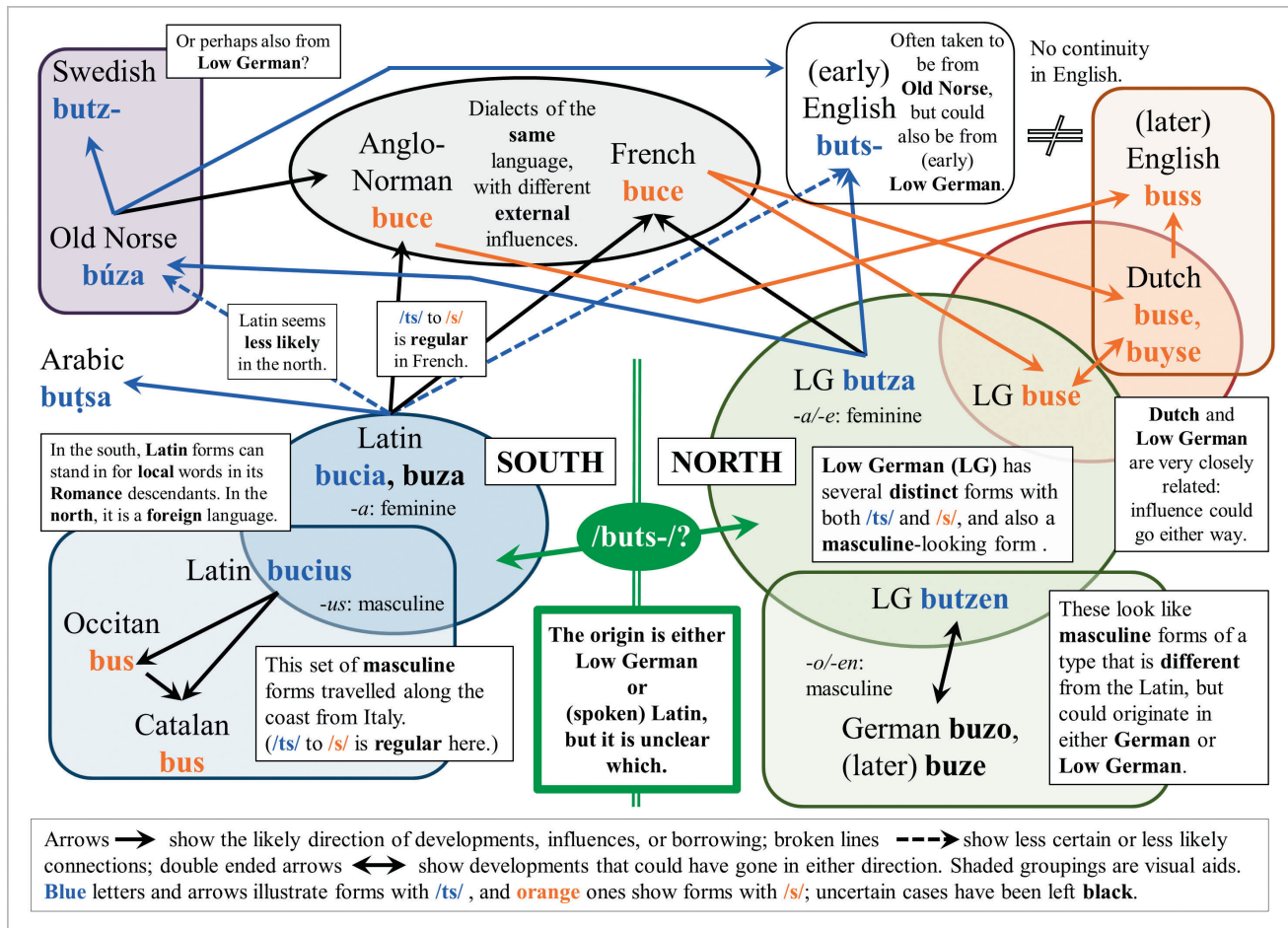
10. (toll due for a) *buzā adducens recens allec* "buzā bringing fresh herring", cited in ONW at BŪSA.

1. For a more detailed discussion of my methodology, compare Thier 2006.

2. For the purposes of this paper, I will use *buss* or "this word" to refer to attested word forms in any language, regarding the differences between languages as individual typological realisations of the general concept.

3. On the overview graphic, these changes are marked up in blue and orange, respectively; according to linguistic convention, letters surrounded by slashes show pronunciations (IPA 1999, p. 27).





Old Norse *búza* first appears in the 12<sup>th</sup> century, which is early for that language<sup>11</sup>.

Some of the earliest Mediterranean evidence comes from a Latin book on the First Crusade (1095-9), compiled soon afterwards in northern Europe and apparently based on eyewitness accounts. This mentions English ships “which they call *buzā*”, 60 *buzae* of the Norwegian king, and also (once) *buzae* in the Muslim fleet (AA X.i.718, XI.xxvi.798, XI.xxvii.800)<sup>12</sup>. In 1190, Richard I (Lionheart) hired a Mediterranean fleet in Marseilles, which included “ten large *busses*” (RoH 114)<sup>13</sup>. By the early 13<sup>th</sup> century the word had been borrowed into Arabic as *buṭṣa* (e.g. BaD 123-6; cf. Kindermann 1934, p. 7-9).

In Italy and the western Mediterranean the word appears in local texts as early as the mid-12<sup>th</sup> century. Here the spoken languages were still similar to Latin, which was used in writing, adapting new words to look Latin. Unusually, in this group the word is often (but not always) masculine<sup>14</sup>. This variation may imply that the word was still quite new to the local speakers.

The accompanying graphic lays out likely interrelations between these words, based on the evidence of attested forms, which point towards spoken Latin and Low German as possible points of origin.

## 2. HISTORICAL POINTS

The word is first attested in 11<sup>th</sup> century England, and is used explicitly for English and Norwegian ships in a 12<sup>th</sup>-century Crusade account. In Old Norse, the word seems well established by the 13<sup>th</sup> century, and is found in sagas about people with no Mediterranean connections<sup>15</sup>. These points may suggest a north European origin.

However, in the western Mediterranean the word is already used in local sources and for local ships by the mid-12<sup>th</sup> century, and in later Crusade accounts of the same time it often refers to Mediterranean ships; in romances it is associated with ‘Saracens’. The earliest Scandinavian evidence is in a 12<sup>th</sup>-century poem listing types of native and foreign, including Mediterranean, ships (SkH 863).

Major political contact between northern and southern Europe began in the 11<sup>th</sup> century, when speakers of Norman

11. The bulk of surviving Old Norse (Icelandic and Norwegian) evidence dates from the 13<sup>th</sup> century and later.

12. The same Norwegian vessels are just called “ships” in the Old Norse saga recounting the same event (SJ 157).

13. *Decem buccias magnas*: these ships made rendezvous with Richard’s north European fleet in Messina, but up to that point, descriptions of the hired fleet refer to Mediterranean ships only; the author was present.

14. Compare examples for both in NJal at \*BUCTUS.

15. For a summary of the saga evidence, see ONP at *BÚZA*.

French (with its Scandinavian elements) held power in parts of southern Italy, even before the Crusades brought large numbers of northern ships into the Mediterranean.

### 3. THE SHIPS

As archaeological evidence from this period is very limited<sup>16</sup>, images are also rare, and neither refers to named ship types, the written accounts from both regions may provide further evidence on the kinds of ships called *buss*.

A 13<sup>th</sup>-century Old Norse saga equates a *búza* with a *langskip* (with 80 crew; OH 122.347) and another reports a 35-bench *búzuskip* ‘buss-ship’ (HH 59.155). Similarly, some western Mediterranean sources describe *bucii* with up to 80 oars (AnnGen1204), and an 1190 contract from Liguria provides the dimensions of a large, but narrow merchant ship (Ciciliot 2012, p. 263)<sup>17</sup>. In Western and Arabic crusade sources, *busses* typically carry cargo or large numbers of men. Some very early sources refer to smaller craft (AA IX.ix.648), but by *circa* 1200 *busses* are most commonly described as ‘(very) large’, etc<sup>18</sup>.

There is little information on sails. A 12<sup>th</sup>-century passage mentions tall masts on a ship in the Mediterranean, which

might indicate a northern square sail (AA X.vii.724)<sup>19</sup>, while the “triple spread of sail” mentioned in the 13<sup>th</sup> century recalls multi-masted Mediterranean vessels (RoD 93). However, neither (north European) author was there.

### 4. INCONCLUSIVE CONCLUSIONS

The word belongs to an age of innovation, and may refer to either the form or function of a kind of ship, or both. It is likely to originate either in Low German (if from the north) or in spoken Latin (if from the south). It seems to have spread fast, which would happen more easily if it referred primarily to function, as physical features typically vary locally. An emphasis on function may also be confirmed by the contradictions in the few physical descriptions. As innovation settles and form types crystallise, some innovative terms can become redundant; a function-based word may be more vulnerable to this process. This could explain both the term’s widespread loss, and its localised survival in one particular context.

### ACKNOWLEDGEMENTS

I am grateful to my colleagues at the OED, especially Ruth Arstall, Inge Milfull, Sam Schad, and Nicolay Yakovlev, and also to Tressy Arts and Simon Hopkins for their help with Arabic.

19. It is unclear if this is a description based on the informant’s report, or the north European author’s own figure of speech.

16. The main Mediterranean finds are earlier and from the east.  
17. The dimensions are: *circa* 30 m by *circa* 4.25 m: L/B ratio *circa* 7; the courier is from Nice.  
18. E.g. Latin *permaxima* (IP ii.28.181), Old Norse *mikill* (OH 122.347).

### PRIMARY SOURCES

- AA:** Edgington S. B. (ed.) 2007 *Albert of Aachen Historia Ierosolimitana*, Oxford, Clarendon Press [cited by chapter, section, and page].
- AnnGen1204:** *Annals of Genoa* anno 1204, in Pertz G. H. (ed.) 1863 *Ogerius Panis, Annales Ianuenses (1197-1219)*, Hannover, Hahn, Monumenta Germaniae Historica SS 18, p. 121-122.
- ASC MS C:** O’Brien O’Keefe, K. 2001 (ed.) *The Anglo-Saxon Chronicle: A Collaborative Edition, vol. 5: MS C*, Cambridge, D. S. Brewer [cited by year].
- BaD** (Bahā’ al-Dīn ibn Shaddād): Richards D. S. 2001 (ed.) *The rare and excellent history of Saladin, or, al-Nawādir al-Sulṭāniyya wa’l-Maḥāsīn al-Yūsufiyya*, Aldershot, Ashgate [cited by page in translation].
- HH:** *Haralds saga Harðráða*, in Jónsson F. 1901 (ed.) *Heimskringla: Nóregs konunga sögur af Snorri Sturluson*, Vol 3, København [cited by chapter and page]; for a translation cf. A. Finlay, A. Faulkner 2015 (eds) *Snorri Sturluson, Heimskringla*, vol. 3, London, Viking Society for Northern Research (as *Haralds saga Sigurðarsonar*).
- IP:** Stubbs W. 1864 (ed.) *Itinerarium Peregrinorum et Gesta Regis Ricardi*, Rerum Britannicarum London, Longman, Medii Aevi Scriptores (Rolls Series) 38, vol. 1 [cited by book, chapter, and page]; for a translation cf. Nicholson H. J. 1997 (ed.) *The Chronicle of the Third Crusade, a translation of the Itinerarium Peregrinorum et Gesta Regis Ricardi*, Aldershot, Ashgate.
- OH:** Johnsen O. A., Helgason J. 1941 (eds) *Saga Óláfs konungs hins helga*, 2 vols, Oslo, Brøgger. [cited by chapter and page]; a slightly later version is translated in A. Finlay, A. Faulkner 2014 (eds) *Snorri Sturluson, Heimskringla*, vol. 2, London, Viking Society for Northern Research.
- RoD:** Ralph of Diceto, *Ymagine Historiarum*, in Stubbs W. 1876 (ed.) *Radulfi de Diceto Decani Lundoniensis Opera Historica*, London, Longman, Rerum Britannicarum Medii Aevi Scriptores (Rolls Series) 68, vol. 2, p. 3-176 [cited by page].
- RoH:** [Roger of Howden] *E Gestis Henrici II et Ricardi I Regum Angliae*, in Liebermann F., Pauli R. 1885 (eds) *Ex rerum Anglicarum Scriptoribus Saeculi XII et XIII*, Hannover, Hahn, Monumenta Germaniae Historica SS 27, p. 81-132 [cited by page].
- SkH:** Gurevich E. 2017 *Skipa heiti*, in Gade K. E., Marold E. (eds) *Poetry from Treatises on Poetics, Part 2: Anonymous Pulur*. Turnhout, Brepols, Skaldic Poetry of the Scandinavian Middle Ages 3, p. 861-876. [cited by page].
- SJ:** *Saga Sigurðar Jórslafara*, in Unger C. R. 1867 (ed.) *Morkinskinna*, Christiania (Oslo), Bentzen, p. 156-198 [cited by page]; a slightly later version is translated in Finlay A., Faulkner A. 2015 (eds) *Snorri Sturluson, Heimskringla*, vol. 3, London, Viking Society for Northern Research (as *Magnússonar saga*).
- SuH:** Hildebrandt R. 1974-1995 (ed.), *Summarium Heinrici*, 2 vols, Berlin, De Gruyter.

## DICTIONARY ENTRIES

- FEW:** бѠЗА, in von Wartburg W. 1968 *Französisches Etymologisches Wörterbuch*, Band XV/2 ([Germanismen] \*bu-\*faihiða), Basel, Zbinden, p. 47. (<https://apps.atilf.fr/lecteurFEW/lire/152/47>)
- MWB:** бѠZE swM, in Gärtner K. *et al.* 2006 (eds) *Mittelhochdeutsches Wörterbuch*, Trier, Universität Trier (Online only, <http://www.mhdwb-online.de/wb.php?buchstabe=B&portion=4360>)
- NJal:** \*BUCIUS, in Mollat M. 1972 (ed.) *Nouveau glossaire nautique d'Augustin Jal* (B), Paris, Mouton, p. 164.
- OED3:** BUSS n./1 and BUSCARL n. (both 2012), in Simpson J. *et al.* 2000, *Oxford English Dictionary Online*, Oxford, Oxford University Press (Online only, <https://www.oed.com/view/Entry/25256> and <https://www.oed.com/view/Entry/25173>)
- ONP:** бѠЗА, in Knirk J. E. *et al.* 2000, *Ordbog over det norrøne prosasprog*, vol. 2 (ban-da) København, Den arnamagnæanske commission, co. 1006-1007 (<https://onp.ku.dk/onp/#o12510>)
- ONW:** bŪSA, in Schoonheim T. H. 2009 (ed.) *Oudnederlands Woordenboek*, Leiden, Instituut voor Nederlandse Lexicologie. (Online only, <http://gtb.inl.nl/iWDB/search?actie=article&wdb=ONW&id=ID2219>)

## REFERENCES

- CICILLOT F.  
2012 Les chantiers navals en Ligurie du Moyen Âge à l'époque moderne (XII<sup>e</sup>-XIV<sup>e</sup> siècles), *Cahiers de la Méditerranée* 84, p. 259-271.
- IPA  
1999 *Handbook of the International Phonetic Association*, Cambridge, Cambridge University Press.
- KINDERMANN H.  
1934 «Schiff» im Arabischen, Zwickau.
- PAULSEN R.  
2016 *Schiffahrt, Hanse und Europa im Mittelalter*, Köln, Böhlau.
- THIER K.  
2006 Sea-lanes of communication: Language as a tool for nautical archaeology, in L. Blue, F. Hocker, A. Englert (eds), *Connected by the Sea, Proceeding of the Tenth Symposium on Boat and Ship Archaeology, Roskilde 2003*, Oxford, Oxbow Books, p. 210-216.

# BUILDING CHEAPLY AND SIMPLY: FLAT-BOTTOMED BOATS WITH CROSS-PLANKED BOTTOMS AROUND THE WORLD

Krzysztof ZAMOŚCIŃSKI

---

## Abstract

In Poland and in some other countries of the world different kinds of cross-planked bottom boats have been and still are built. The author has undertaken to establish the places where they are built, their chronology and building techniques, and, on the basis of this information, to investigate the question of potential connections between individual examples. From this research emerges the ongoing process of diffusion of the cross-planked bottom boat idea. Everything indicates that it started in the second half of the 18<sup>th</sup> century in North America. It was adopted in different types of crafts – previously existing or new – and activities. The advantages are cheapness and ease of construction.

## Keywords

Cross-planked bottom boats, nautical ethnology

## Résumé

En Pologne et dans quelques autres pays du monde, différents types de bateaux à bordés transversaux ont été et sont encore construits. L'auteur s'est employé à établir leur chronologie, leurs lieux et leurs techniques de construction et, sur la base de ces informations, à enquêter sur la question des liens potentiels entre des exemples individuels. De cette recherche émerge le processus continu de diffusion de l'idée de bateaux à bordés transversaux. Tout indique qu'elle a commencé dans la seconde moitié du XVIII<sup>e</sup> siècle en Amérique du Nord et a été adoptée dans différents types d'embarcations – nouvelles ou préexistantes – et d'activités. Les avantages en sont son faible coût et sa facilité de construction.

## Mots-clés

Bateau à bordés transversaux, ethnologie nautique

---

Lake fishermen in the vicinity of Gdańsk, Poland, have long used boats with cross-planked bottoms, built upside-down. In this method, transverse bottom planks were nailed after the first side strakes, held apart by a midship transom, were secured to stem and stern elements: then the whole frame was inverted and the second strakes added. These boats were believed to be an independent invention, but how do we account for boats with a similar construction that are known from other countries? Is there any connection between them, and could this explain the distribution of this construction method in many places?

## 1. MATERIALS AND METHODS

The author conducted ethnographical investigations in Poland, as well as in published works (Chapelle 1951; Rudolph 1966), articles (Parry, McGrail 1989; Rodgers, Corbin 2003), boatbuilding manuals (Paddlefast 1876), FAO reports, and the Australian register of historic vessels. Archival and contemporary photographs of boats, magazine illustrations and paintings found on the internet were also used.

Ethnogeographic (Pokropek 1981) and historical (Topolski 1984) methods were applied. The former was used to fix ranges of boat occurrences, the latter to determining chronology.

## 2. RESULTS

The first cross-planked bottom boats (a punt type with L-shaped chine girders) were discovered in South Carolina, United States, in the 1980s and were dated to the second half of the 18<sup>th</sup> century (Newell 1996). The wreck of a cross-planked flatboat with straight chine girders from the beginning of the 19<sup>th</sup> century was found near the Ohio River in 2000 (Wagner 2015). The first scow schooner was recorded in 1825 on Lake Erie. Its hull construction attests that the flatboat was the inspiration for this type of vessels. The next step was the adoption of this construction in some classes of small boats in northeast USA. From the 1870s numerous publications for amateur boat-builders started to disseminate the idea in the USA and abroad.

In Canada, this construction type appeared from the second half of the 19<sup>th</sup> century in some types of boats: *bateau* and double-ended skiff (St Lawrence River), skiff (Prince Edward Island), scow (British Columbia), punt (Nova Scotia) and also in the dory. In Cuba, skiff type *canoas* from the Rio Guarabo (DWW 2000, p. 111) and boats at Tunas de Zaza indicate American roots. The design of the cross-planked fishing *zapato chalanas* from the Peruvian Pacific coast was presumably introduced by foreigners, or else they were constructed according to plans published between the 1920s and 1940s (Edwards 1967, p. 369).

Designs of skiff, scow (known as punt) and *garvey* are found on the east coast of Australia. Scow design is connected



with the development of the Australian oyster industry in the second half of the 19<sup>th</sup> century. The idea of the scow schooner was introduced to New Zealand directly from North America in 1873 (Hawkins 1965).

The cross-planked bottom was introduced to Great Britain before the 1850s in narrow boats and Worsley *starvationers*. The Tredunnoch boat belongs to this group and is dated to the middle of the 19<sup>th</sup> century. In the 1870s and 1880s cross-planked punts on the Thames are shown in pictures, illustrations in magazines and books.

The technique appears in France on the north coast of Brittany and in the Morbihan on its southern coast, as well as on the French west coast (Vendée, Charente-Maritime, Gironde estuary) (Beaudouin 1975, p. 85, 356). The introduction appears to be connected to the transplantation of American oyster industry experiences to the French seacoast in the 1860s and the sharpie design in yachting. In the Gorges du Tarn (southern France) the reason was the development of tourism in the 1870s: in Haute-Vienne it was sand dredging. These boats presented scow or punt designs. In the Netherlands, a cross-planked type of *schouw* was used (DWW 2000, p. 516).

In Spain, on the west coast of Galicia, one can find *gamelas* with a cross-planked bottom and skiff type *chalanas*. The Sil River also has a skiff type. Simple *scow* designs appeared on the Minho River probably in the second half of the 19<sup>th</sup> century. One can also find the *batuxo* type on the Portuguese length of this river.

In the middle of southern Norway, punt and scow designs (*pram*) were introduced at the beginning of the 20<sup>th</sup> century (Gjestland 1983). In southeast Norway (Oslo Fiord) one could find a design called *doris*. The punt forms (*flataka*, *pram*) (Skanske *et al.* 1983, p. 122, 128) were introduced to southern Sweden at the beginning of the 20<sup>th</sup> century, and the *doris* from Newfoundland at the end of 19<sup>th</sup> century along the coasts of Bohuslän and Halland. Cross-planked *proomu* were used in southwest Finland in the 1940s.

The cross-planked bottom was introduced to punt design in Spreewald around the 1860s and at Mecklenburg-Vorpommern in the 1910s, as well as to Western Pomerania (Dievenow) and Eastern Pomerania (Hammerstein, Radaune River), and the inland lakes of Brandenburg (Rudolph 1966, p. 111, 114).



**Fig. 1:** Cross-planked bottom boat from Black Lake, Kartuzy District, Poland, 2014 (photograph K. Zamościński).

Knowledge of sharpie yacht design is attested in Germany in the 1880s.

In Poland in the 1930s, cross-planked boats were introduced to the Kashubian Lake District in Eastern Pomerania (Litwin 1995, p. 244), and as sand dredging boats on the Wisłoka River in the southeast of the country. The punt design was introduced after 1945 into some ponds of collective fish farms.

Cross-planked skiffs are sometimes built in Russia, Ukraine and Belarus following plans based on an American design published there for the first time in 1973 (Антонов 1973).

Cross-planked boats of the Adriatic region usually have the form of the American skiff: *batana* in Senigallia near Ancona, Italy (Bonino 1981, p. 135, fig. 4C), *batana salvorina* in Istria, *batello* on Rab and *sandula* on the Vis Islands, Croatia. Descriptions of Croatian boats from 1903 do not mention this design (Lorini 1903, p. 53-64), but the punt form has been used at least from the 1930s on the Kupa and Korana Rivers<sup>1</sup> (Karlovac 2020). In Albania, there are skiff type boats on Lake Ohrid and on the Tirana Artificial Lake.

Programmes of the Food and Agricultural Organisation (FAO) caused the introduction of this construction type to the following countries in Asia and Africa after 1973: Nepal, Indonesia, Ivory Coast, and Malawi. In the Dhaka region of Bangladesh, the cross-planked bottom was introduced recently to the *kosha* boat type.

Besides the technique described above, a chronologically earlier technique has been identified of building flat-bottomed boats right-side up at first, and then upside-down only for the cross-planked bottom ends. It was known in Europe before the 19<sup>th</sup> century. In some central Italian lakes this technique can be traced back to medieval times (Gambini 2015). In southwest France it was known (together with L-shaped chine girders) on the Adour River in the 18<sup>th</sup> century (Beaudouin 1970, p. 43-53).

### 3. CONCLUSIONS

All the evidence indicates that the whole cross-planked bottom technique was invented on the southeast coast of North America in the second half of the 18<sup>th</sup> century and this invention was inspired by the partly cross-planked bottom introduced there by French Huguenots (Harris 2014) from the Adour River.

Constructional traits, chronology and direct testimonies prove that the technique was applied in transport, work, canal, sport, and recreational types of boats or barges and it spread throughout the United States where it underwent its most comprehensive development. It was then disseminated in different forms to Europe, Canada, New Zealand, Australia, Central and South America, and finally to Asia and Africa. This process of diffusion still continues. It is directly confirmed in some places, in others it remains the most probable hypothesis (in those cases convergent evolutions should also be considered). The simplicity and cheapness of the technique have supported it. It was often introduced into already existing boat types with longitudinally planked bottoms.

1. See photographs at <http://www.kafotka.net/galerije/karlovac-1900-1940> (consulted 06/04/2020).

## REFERENCES

- DWW  
2000 *A Dictionary of the World's Watercraft: From Aak to Zumbra*, London, Chatham Publishing.
- АНТОНОВ Д.  
1973 Гребная лодка-скиф, Катера и Яхты, № 42.
- CHAPELLE H. I.  
1951 *American Small Sailing Craft*, New York-London, W.W. Norton and Company.
- BEAUDOUIN F.  
1970 *Les bateaux de l'Adour*, Bayonne, Musée Basque.  
1975 *Bateaux des côtes de France*, Grenoble, Éditions des 4 Seigneurs.
- BONINO M.  
1981 Rafts and dugouts in central Italy. The primitive phase of local inland boatbuilding, *The Mariner's Mirror* 67.2, p. 125-148.
- EDWARDS C. R.  
1967 Commercial Sail and Small Fishing Craft of Western South America, *The Mariner's Mirror* 53.4, p. 357-370.
- GAMBINI E.  
2015 Le grandi imbarcazioni tradizionali in uso al Lago di Perugia nella pesca dei 'tori' tra Quattro e Cinquecento, *Gentes. Rivista di Scienze Umane e Sociali*, II, 2, p. 18-24.
- GJESTLAND G.  
1983 *Innlandsbåter i Vest-Agder*, Rapport fra Registering av innlandsbåter i Lyngdal kommune, Fylkeskonservatoren i Vest-Agder ([https://www.vaf.no/dm\\_documents/innlandsb%C3%A5ter\\_i\\_vest-agder\\_iyhst.pdf](https://www.vaf.no/dm_documents/innlandsb%C3%A5ter_i_vest-agder_iyhst.pdf) consulted 31/05/2019)
- HARRIS L. B.  
2014 *Patroons and Periaguas: Enslaved Watermen an Watercraft of the Lowcountry*, Columbia, South Carolina, University of South Carolina Press.
- HAWKINS C. W.  
1965 The New Zealand Scow, *The Mariner's Mirror*, 51.3, p. 221-231.
- LITWIN J.  
1995 *Polskie szkutnictwo ludowe*, Gdańsk, Marpress.
- LORINI P.  
1903 *Ribanje i ribarske sprave pri istočnim obalama Jadranskog mora*, Beč, C.k. Naklada školskih knjiga (<https://digitalna.nsk.hr/pb/?object=info&id=11419> consulted 13/03/2020)
- NEWELL M. M.  
1996 *The Historic Working Small Craft of South Carolina. A General Typology with a Study of Adaptations of Flatboat Design*, PhD Thesis, University of St. Andrews (<https://research-repository.st-andrews.ac.uk/handle/10023/11135> consulted 13/03/2020)
- PADDLEFAST  
1876 How to Build Cheap Boats, *Scientific American Supplement*, Vol. I, No. 25, June 17, p. 397; Vol. I, No. 26, June 24, p. 410; Vol. II, No. 29, July 15, p. 359-460.
- PARRY S., MCGRAIL S.  
1989 The Tredunnoch boat, *IJNA* 18.1, p. 43-49.
- POKROPEK M.  
1981 Metoda etnogeograficzna, in E.Z. Szulc (ed.), *Metody etnologii*, p. I, Warszawa, Wydawnictwa Uniwersytetu Warszawskiego, p. 61-85.
- RODGERS B. A., CORBIN A.  
2003 Mud box – filled with stone: the wreck of the scow schooner Dan Hayes, *IJNA* 32.2, p. 210-224.
- RUDOLPH W.  
1966 *Handbuch der volkstümlichen Boote im östlichen Niederdeutschland*, Berlin, Akademie-Verlag.
- SKANSE P., ANDERSSON B., CLAEISSON S.  
1983 *Båtar i Blekinge*, Skärhamn, Batdokumentationsgruppen.
- TOPOLSKI J.  
1984 *Metodologia historii*, Warszawa, Państwowe Wydawnictwo Naukowe.
- WAGNER M. J.  
2015 *The Wreck of the "America" in Southern Illinois: A Flatboat on the Ohio River*, Carbondale, Southern Illinois University Press.

pcd  
cmb  
édition pré-press  
livres numériques  
44400 Rezé

# Archaeonautica

## Open Sea | Closed Sea. Local and Inter-Regional Traditions in Shipbuilding Proceedings of the Fifteenth International Symposium on Boat and Ship Archaeology Marseille 2018

Twenty-four years after the seventh ISBSA was held on the island of Tatiou, it became the turn of Marseille on the Mediterranean coast of France to have the honour of hosting the fifteenth *International Symposium on Boat and Ship Archaeology* (ISBSA 15), which brought together, from 22 to 27 October 2018, some 300 scholars, PhD and post-doctoral researchers, and students from 36 countries belonging to almost 130 research bodies. The conference was organised by the Centre Camille Jullian - UMR 7299, which, on the occasion of ISBSA 15, celebrated 50 years of activity in the field of nautical archaeology. This volume includes 60 contributions from 93 authors covering different nautical areas (the Mediterranean, North Sea, Baltic, Atlantic, Pacific and South China Sea) from prehistory to the modern era. The papers are organised around a number of different themes, the principal being “Open Sea, Closed Sea: Local and Inter-Regional Traditions in Shipbuilding”. The intention is to reveal interactions between local and inter-regional traditions of open and enclosed waters through examples taken from nautical areas as varied and representative as possible.

## Mer Fermée | Mer Ouverte. Traditions locales et interrégionales dans la construction navale Actes du Quinzième Colloque international d'archéologie navale Marseille 2018

*Vingt-quatre ans après le septième ISBSA, tenu en 1994 à l'île Tatiou, la façade méditerranéenne de la France a été mise à l'honneur en recevant à Marseille la quinzième édition de l'International Symposium on Boat and Ship Archaeology (ISBSA 15), qui a réuni du 22 au 27 octobre 2018 près de trois cents chercheurs, jeunes chercheurs (post-doctorants et doctorants) et étudiants, provenant de 36 pays et appartenant à près de 130 organismes de recherche. Le colloque a été organisé par le Centre Camille Jullian qui, à cette occasion, a fêté ses 50 ans de recherche dans le domaine de l'archéologie navale. Le volume regroupe soixante contributions de quatre-vingt-treize auteurs portant sur différents espaces nautiques (Méditerranée, mer du Nord, Baltique, Atlantique, Pacifique, mer de Chine), de la Préhistoire à l'époque moderne. Ces actes sont organisés autour de différents thèmes : le principal d'entre eux s'intéresse aux interactions entre traditions locales et traditions interrégionales, mers ouvertes et mers fermées, mises en évidence à travers des exemples pris dans des régions aussi variées et représentatives que possible.*

60 € prix valable en France  
ISSN : 0154-1854  
ISBN : 978-2-271-12972-7



[www.cnrseditions.fr](http://www.cnrseditions.fr)

Le Gyptis  
dans la calanque d'En Vau, 2013  
Cliché L. Damelet (CNRS/AMU/CCJ)