

F1072 US10084 INV1085 Peinte Ill. 14

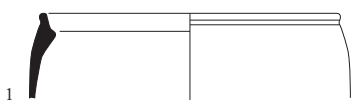

F1072 US10084 INV1085 Peinte Ill. 13

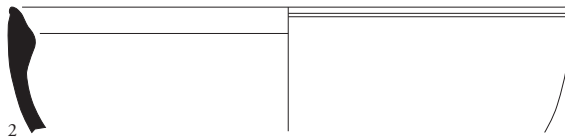

F1072 US10084 INV1085 Cl. calc. Ill. 11

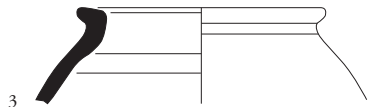

F1072 US10084 INV1085 Cl. calc. Ill. 11



F1072 US10084 INV1085 Cl. calc. Ill. 12

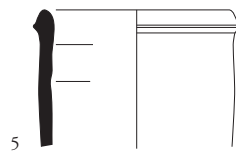

F1072 US10084 INV1085 Cl. calc. Ill. 10



Ech 1:3

0 15 cm

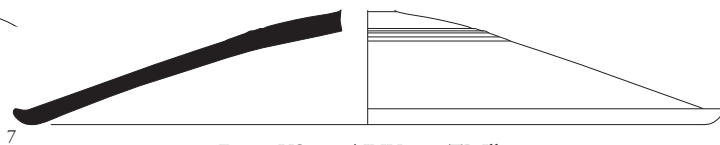

F1072 US10084 INV1085 TR Ill. 15

F1072 US10084 INV1085 TG Ill. 16

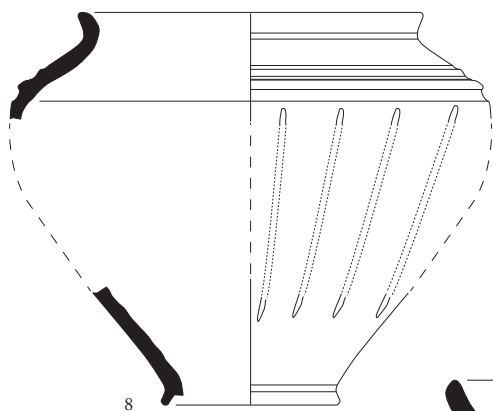

F1072 US10084 INV1085 TG Ill. 9

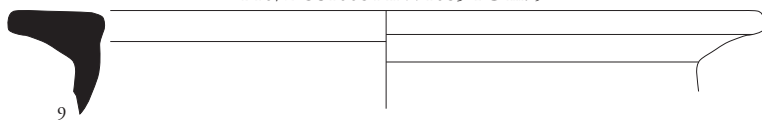

F1072 US10084 INV1085 TG Ill. 8

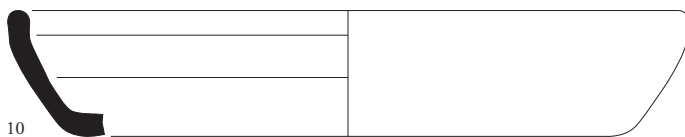

F1072 US10084 INV1085 TG Ill. 7

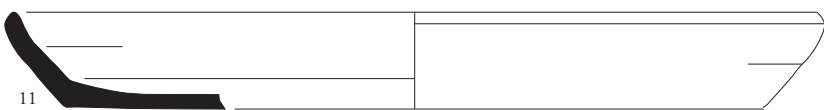

F1072 US10084 INV1085 TG Ill. 19



F1072 US10084 INV1085 TG Ill. 18

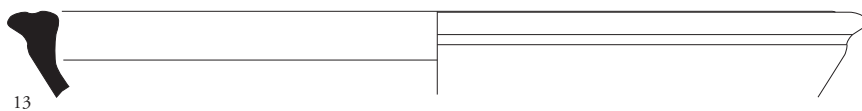

F1072 US10084 INV1085 TG Ill. 21

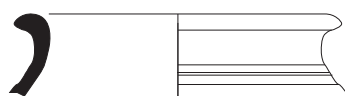

F1072 US10084 INV1085 TG Ill. 20

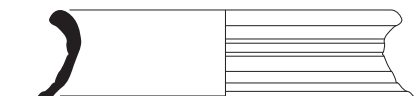

F1072 US10084 INV1085 TG Ill. 17

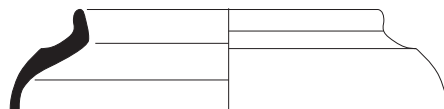

14

15

16