



**HAL**  
open science

## L'épave de Phanagoria, mer Noire (Russie) : un navire de guerre d'époque hellénistique

Pierre Poveda, Giulia Boetto, Sergey Olkhovskiy

### ► To cite this version:

Pierre Poveda, Giulia Boetto, Sergey Olkhovskiy. L'épave de Phanagoria, mer Noire (Russie) : un navire de guerre d'époque hellénistique. Séminaire "Archéologie nautique. Moyens de transport par eau, aménagements de l'espace littoral et du milieu fluvial", Université Paris 1- Panthéon Sorbonne, Feb 2022, Paris, France. halshs-03586170

**HAL Id: halshs-03586170**

**<https://shs.hal.science/halshs-03586170v1>**

Submitted on 6 Mar 2023

**HAL** is a multi-disciplinary open access archive for the deposit and dissemination of scientific research documents, whether they are published or not. The documents may come from teaching and research institutions in France or abroad, or from public or private research centers.

L'archive ouverte pluridisciplinaire **HAL**, est destinée au dépôt et à la diffusion de documents scientifiques de niveau recherche, publiés ou non, émanant des établissements d'enseignement et de recherche français ou étrangers, des laboratoires publics ou privés.



UNIVERSITÉ PARIS 1  
**PANTHÉON SORBONNE**  
UFR HISTOIRE DE L'ART  
ET ARCHÉOLOGIE

# L'épave de **Phanagoria** (Mer Noire, Russie)

## Un navire de guerre d'époque hellénistique

**Sergey Olkhovskiy**  
Institute of Archaeology  
Russian Academy of Science

**Pierre Poveda**  
**Giulia Boetto**  
AMU - CNRS  
Centre Camille Jullian



ИНСТИТУТ АРХЕОЛОГИИ  
РОССИЙСКОЙ АКАДЕМИИ НАУК



Aix\*Marseille  
université  
*Socialement engagée*



# L'épave de **Phanagoria** : un navire de guerre d'époque hellénistique

Sergey Olkhovskiy  
Pierre Poveda  
Giulia Boetto

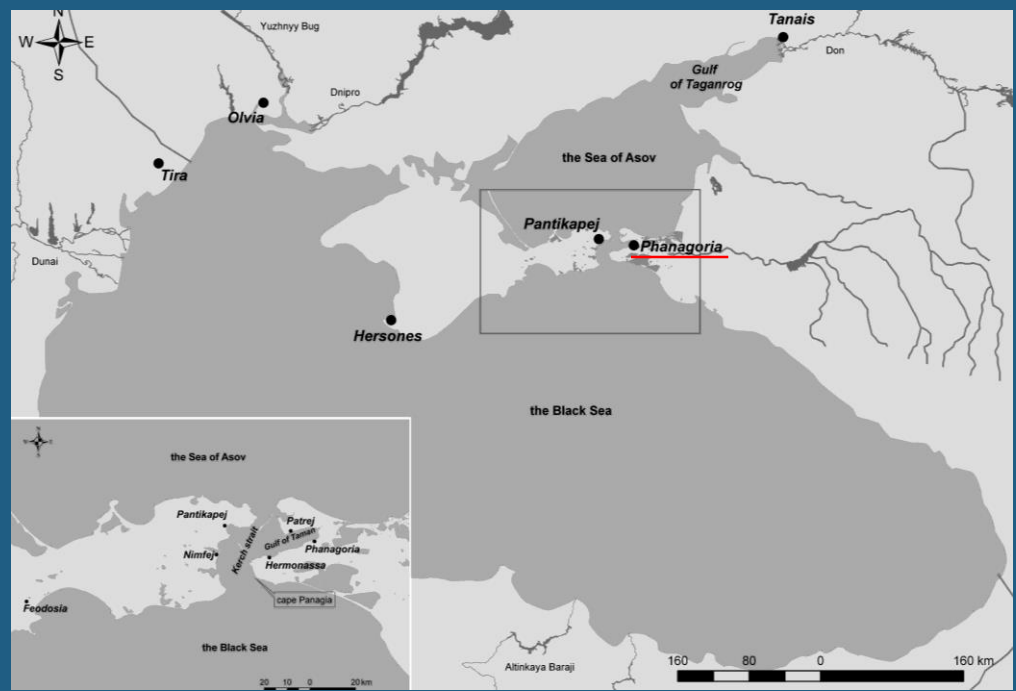
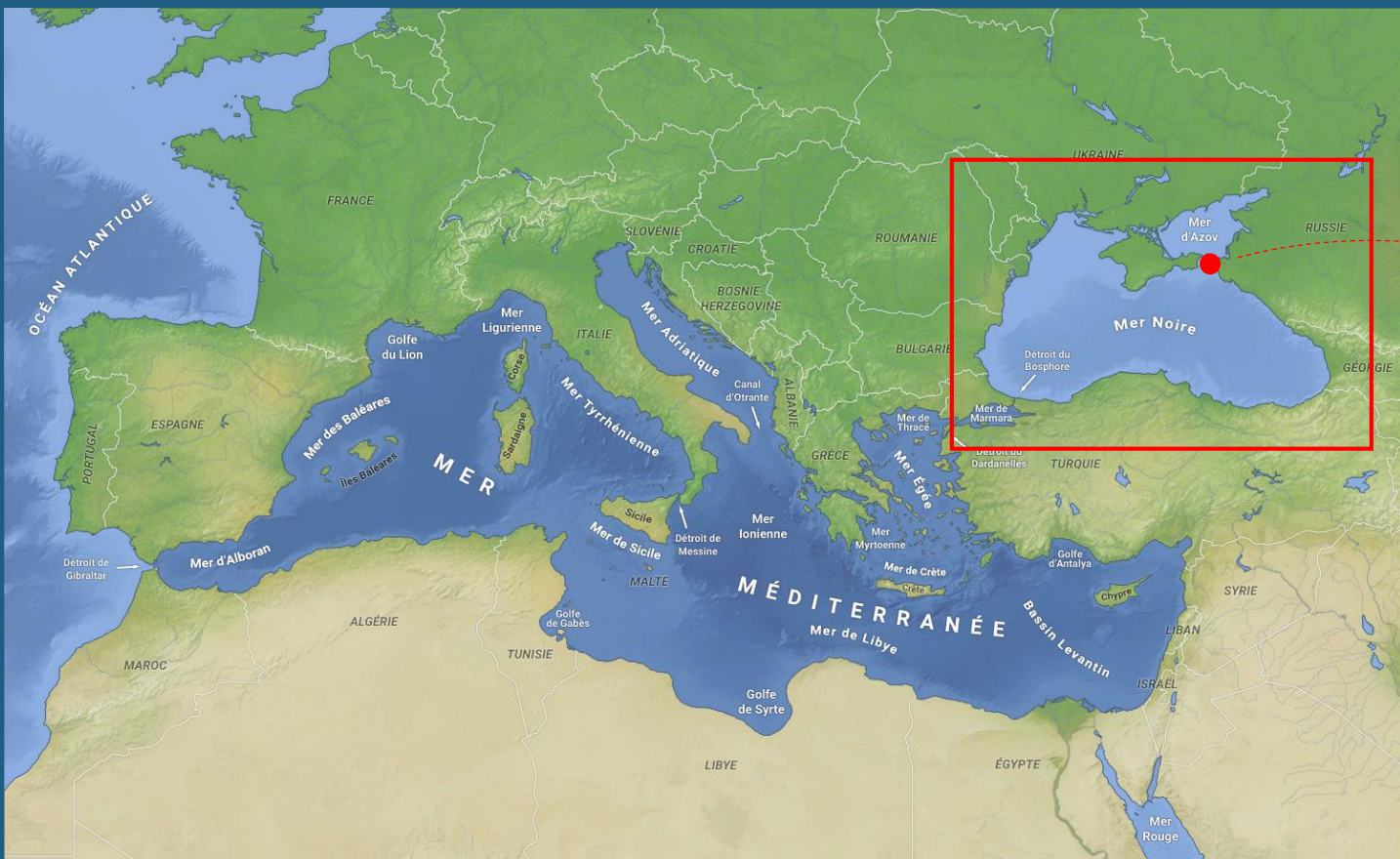



- 545 av. J.-C
- Colons grecs en provenance de Teos

## Φαναγορ(ε)ία - Phanagoria



- **Royaume du Bosphore**  
 d'environ 480 à 107 av. n.e



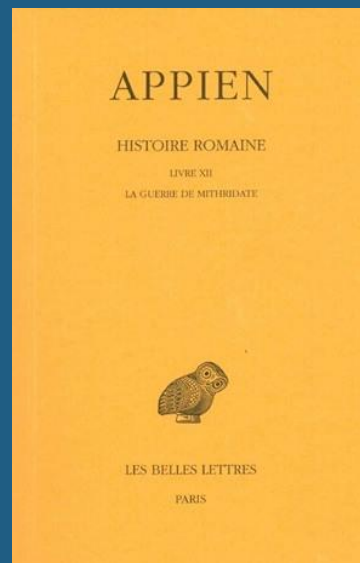

- Guerres Mithridatiques contre Rome entre 88 et 63 av. n.e
- Soulèvement de Phanagoria en 63 av. n.e



**Mithridate VI Eupator**

- **Royaume du Pont**  
d'environ 280 à 63 av. n.e





# L'épave de Phanagoria : un navire de guerre d'époque hellénistique

Sergey Olkhovskiy  
Pierre Poveda  
Giulia Boetto

• 1859

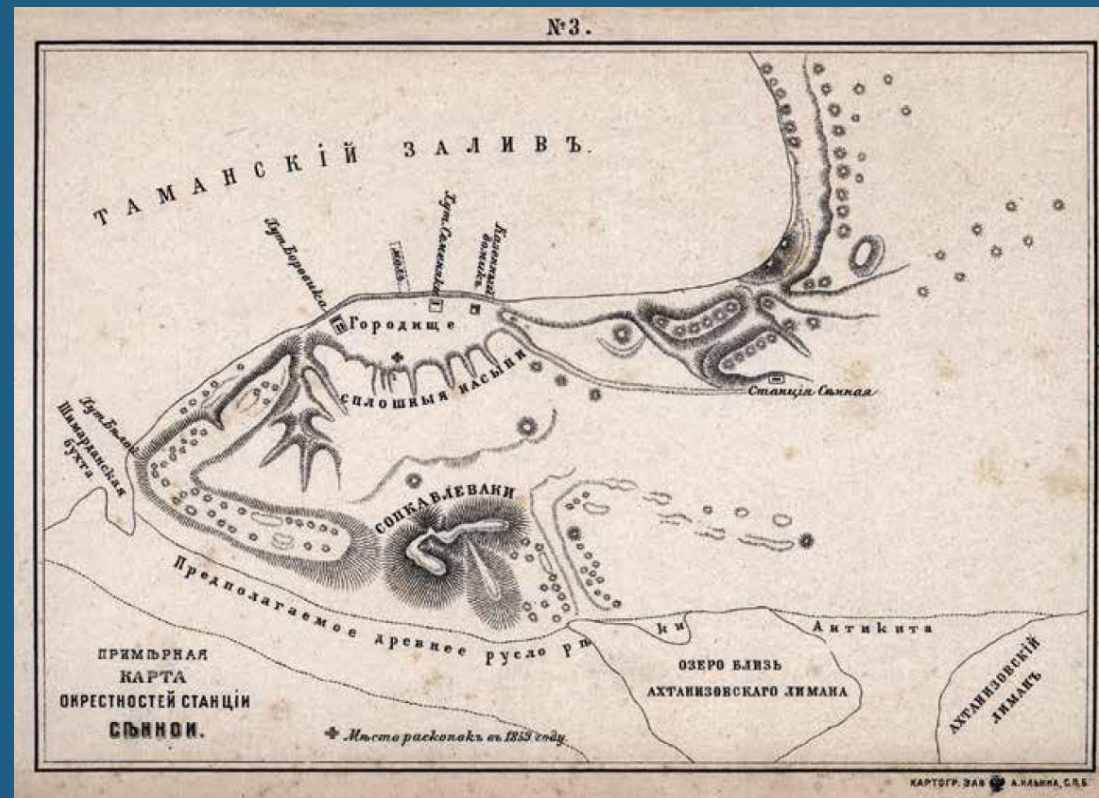

- XIX ème s.
- 1836 - Premières fouilles: Musée des antiquités de Kerch



# L'épave de Phanagoria : un navire de guerre d'époque hellénistique

Sergey Olkhovskiy  
Pierre Poveda  
Giulia Boetto





- 1947 fouilles sous la supervision de V.D. Blavatsky puis de Mme. Kobylina



# L'épave de **Phanagoria** : un navire de guerre d'époque hellénistique



# L'épave de **Phanagoria** : un navire de guerre d'époque hellénistique

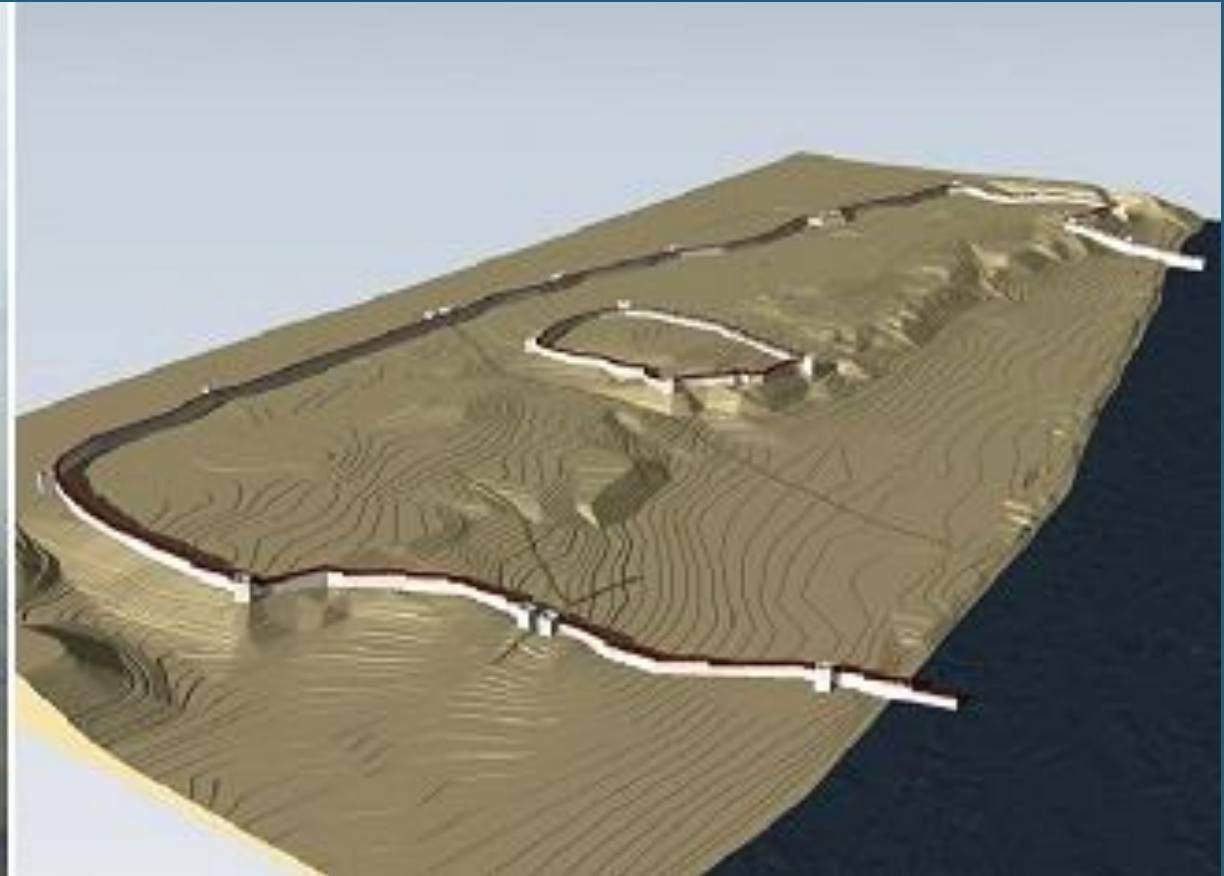





**Oleg Deripaska** remettant la clé du nouveau centre de recherche de Phanagoria à **V. D. Kuztnesov**, directeur de l'expédition archéologique de Phanagoria



# L'épave de **Phanagoria** : un navire de guerre d'époque hellénistique

Sergey Olkhovskiy  
Pierre Poveda  
Giulia Boetto





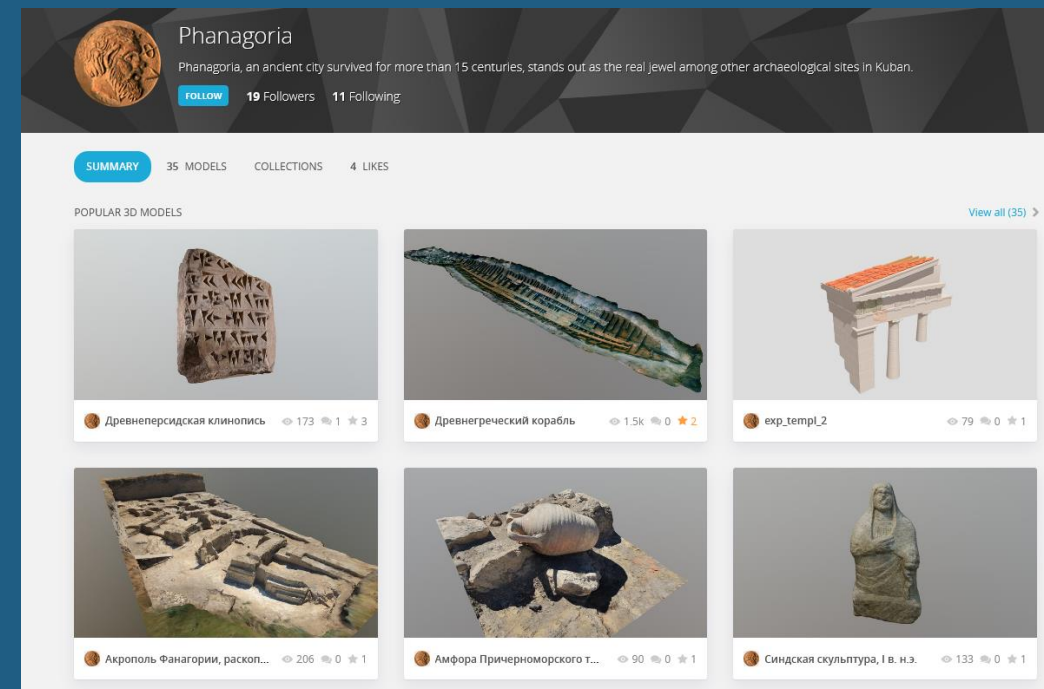

Monographies disponibles en ligne : <http://phanagoria.info/publishing/>

Modèles 3D consultable  
sur la plateforme Sketchfab :

<https://sketchfab.com/phanagoria>



## L'épave de **Phanagoria** : un navire de guerre d'époque hellénistique





# L'épave de **Phanagoria** : un navire de guerre d'époque hellénistique





# L'épave de Phanagoria : un navire de guerre d'époque hellénistique



- 1950...

- ...2019...





# L'épave de **Phanagoria** : un navire de guerre d'époque hellénistique

Sergey Olkhovskiy  
Pierre Poveda  
Giulia Boetto

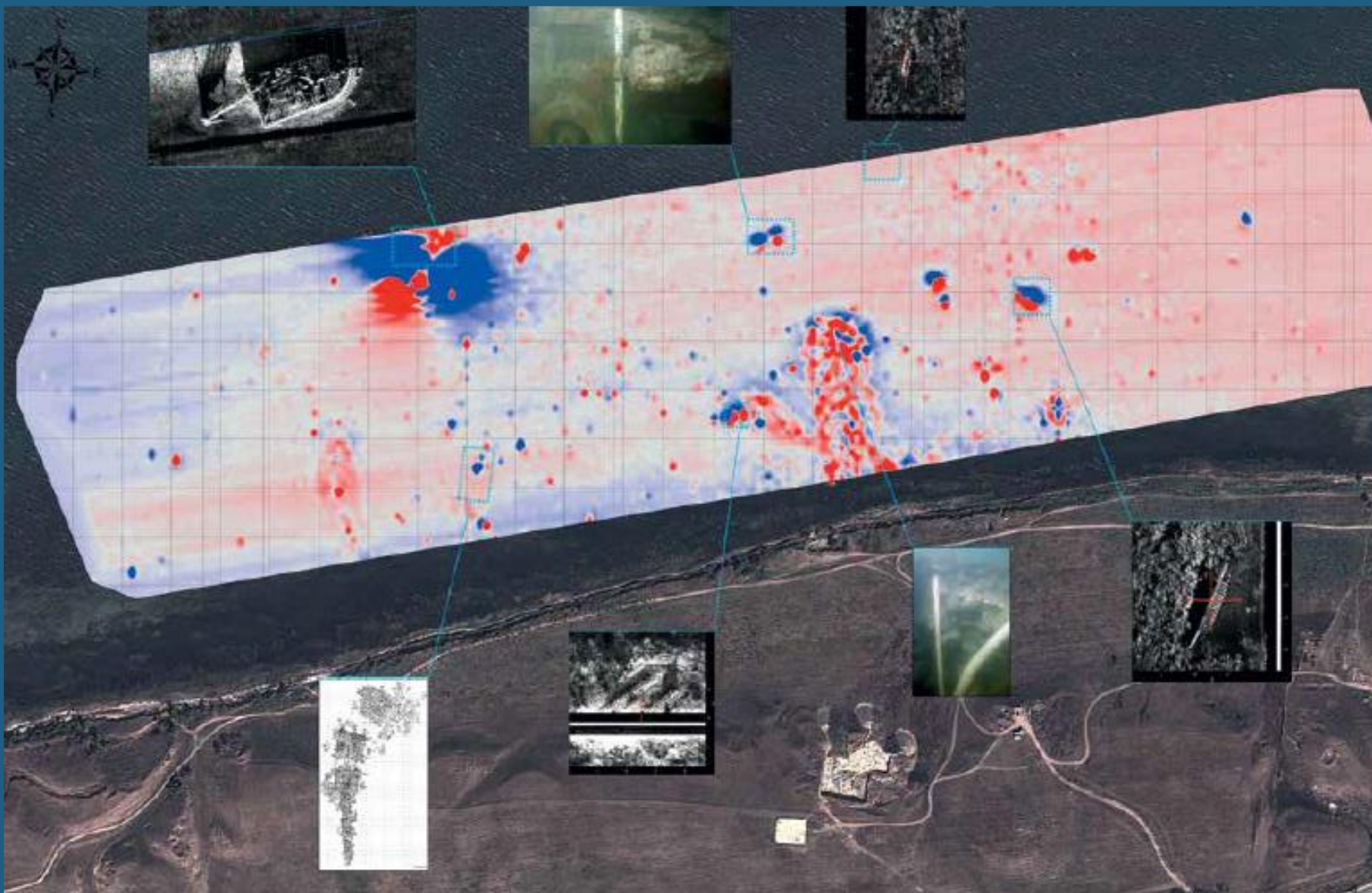



# L'épave de Phanagoria : un navire de guerre d'époque hellénistique

Sergey Olkhovskiy  
Pierre Poveda  
Giulia Boetto

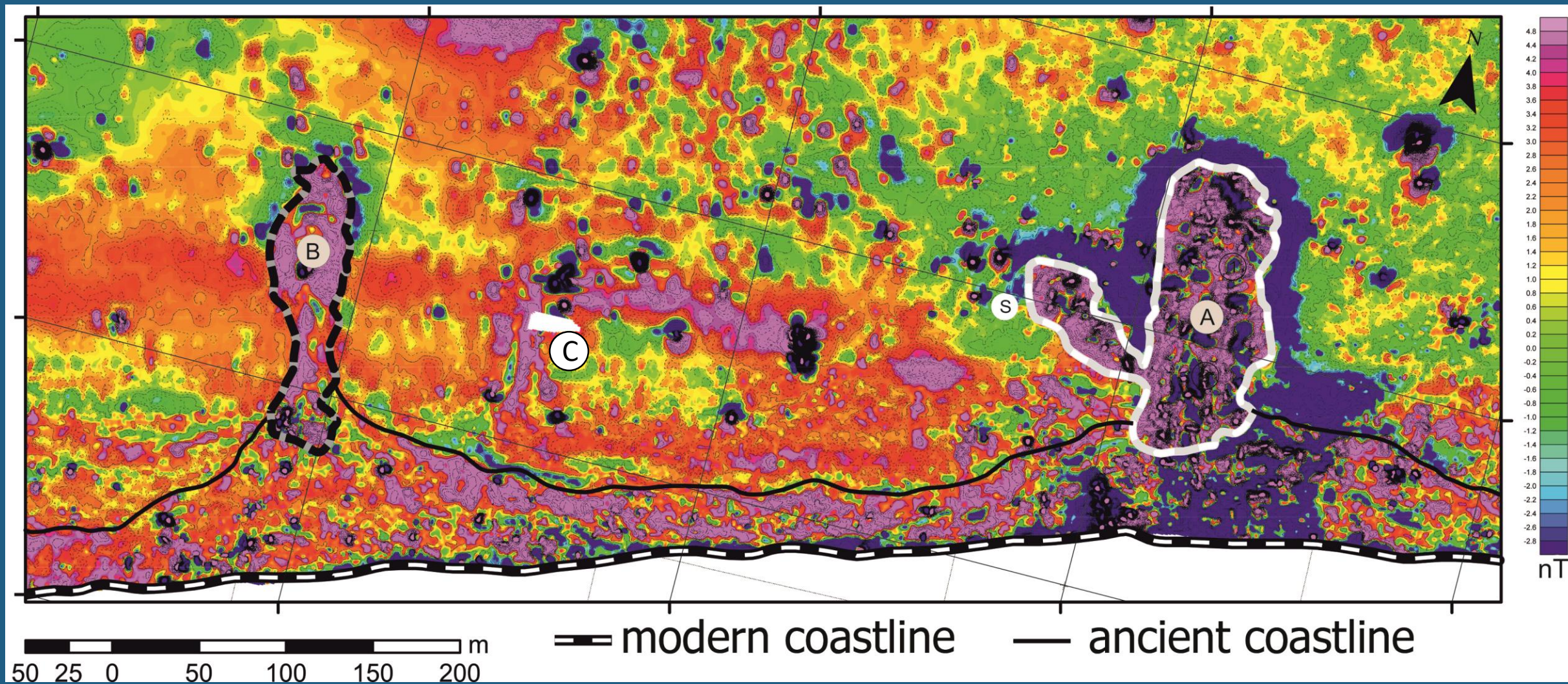



# L'épave de Phanagoria : un navire de guerre d'époque hellénistique

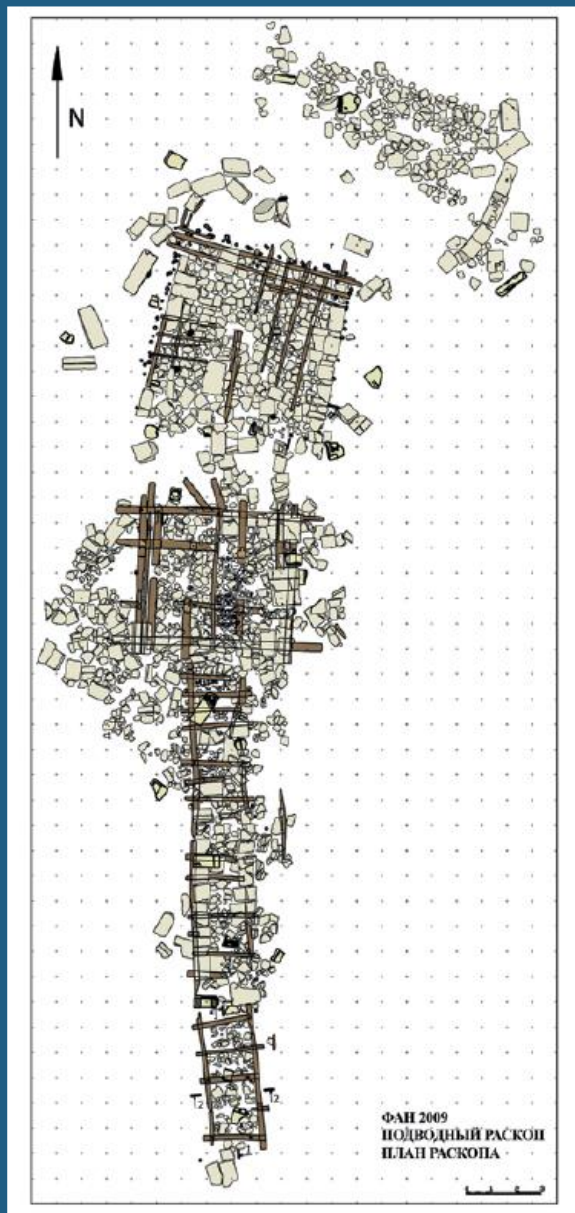



# L'épave de Phanagoria : un navire de guerre d'époque hellénistique

Sergey Olkhovskiy  
Pierre Poveda  
Giulia Boetto





# L'épave de Phanagoria : un navire de guerre d'époque hellénistique

Sergey Olkhovskiy  
Pierre Poveda  
Giulia Boetto

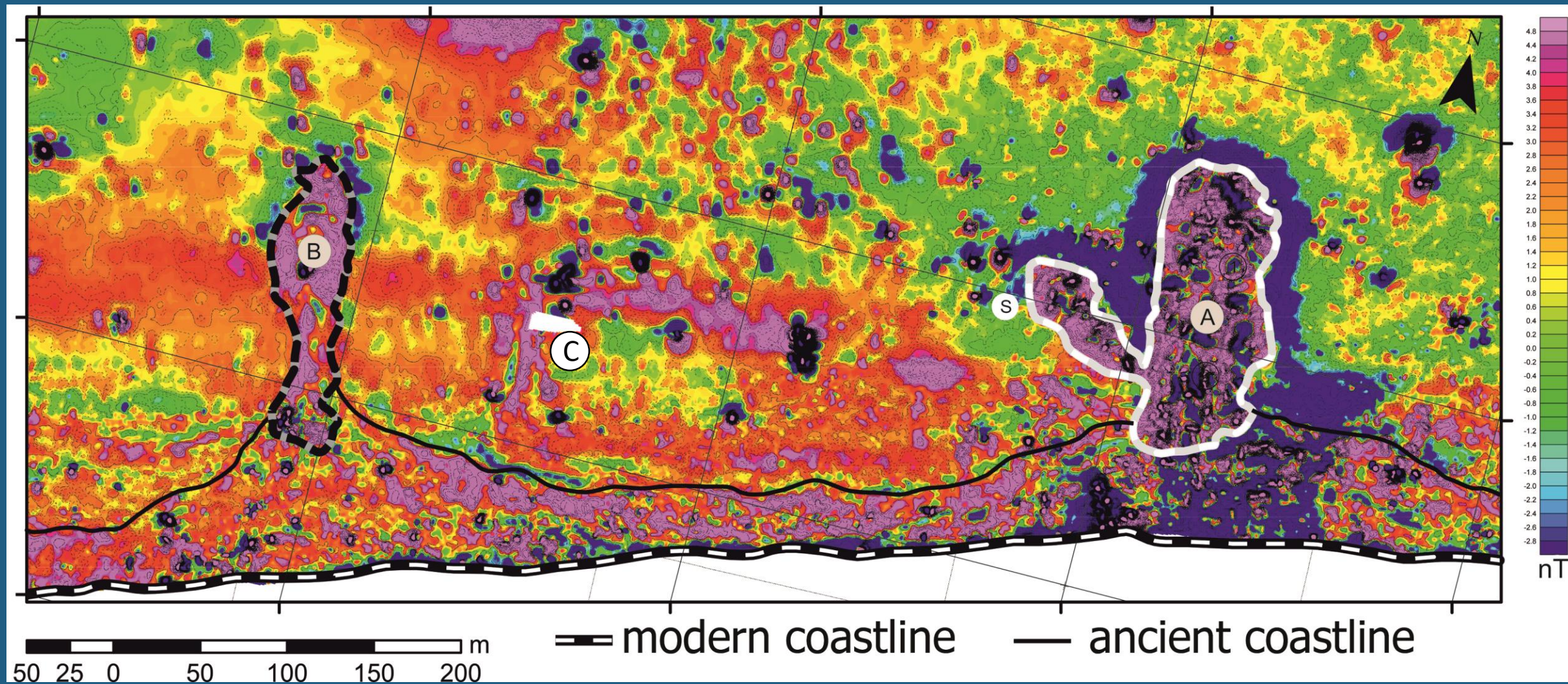



# L'épave de **Phanagoria** : un navire de guerre d'époque hellénistique





# L'épave de **Phanagoria** : un navire de guerre d'époque hellénistique

Sergey Olkhovskiy  
Pierre Poveda  
Giulia Boetto

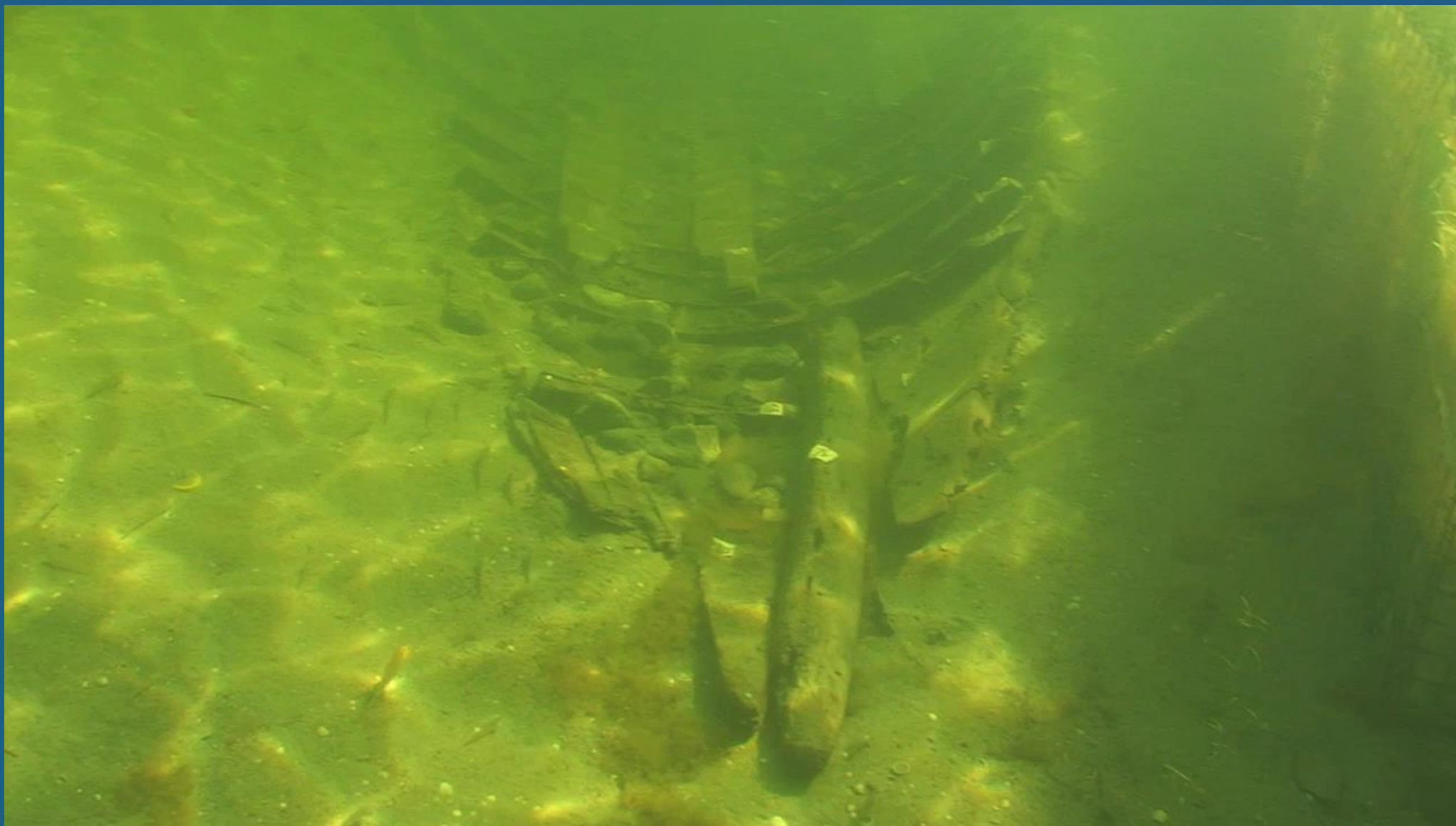



2012

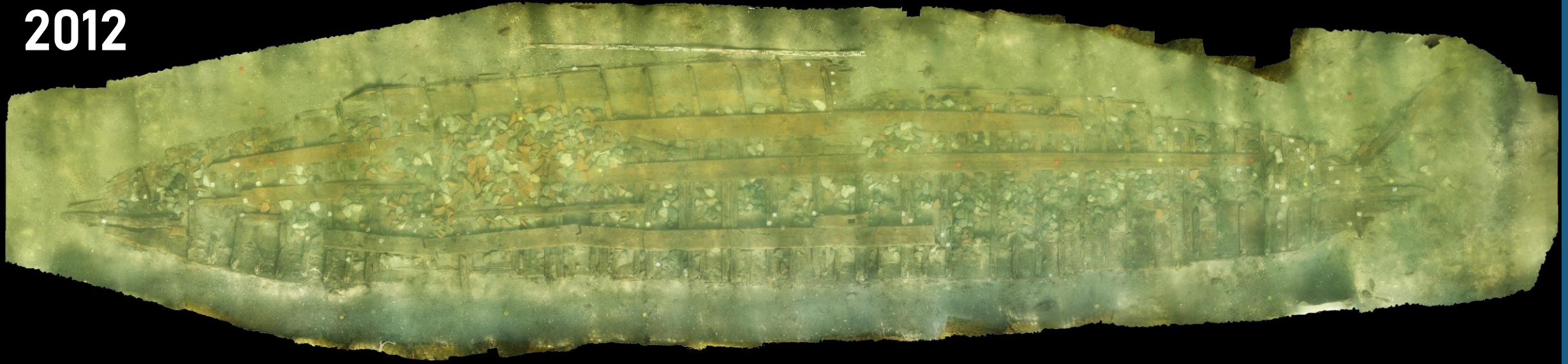



# L'épave de Phanagoria : un navire de guerre d'époque hellénistique

Sergey Olkhovskiy  
 Pierre Poveda  
 Giulia Boetto

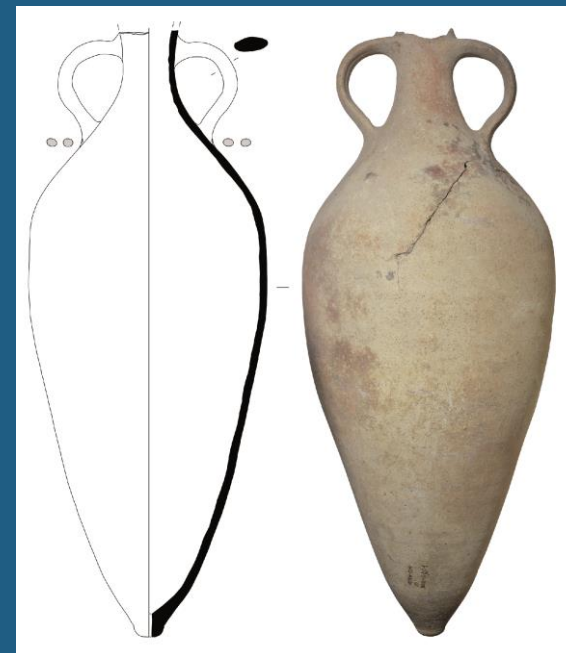
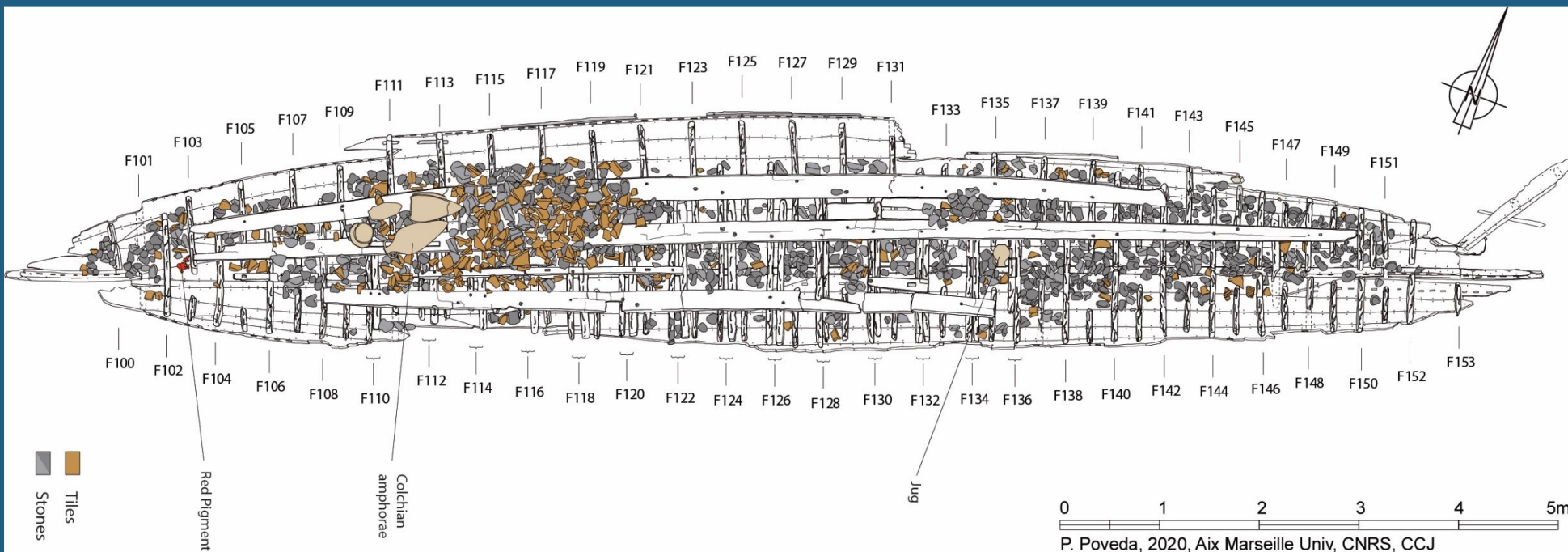

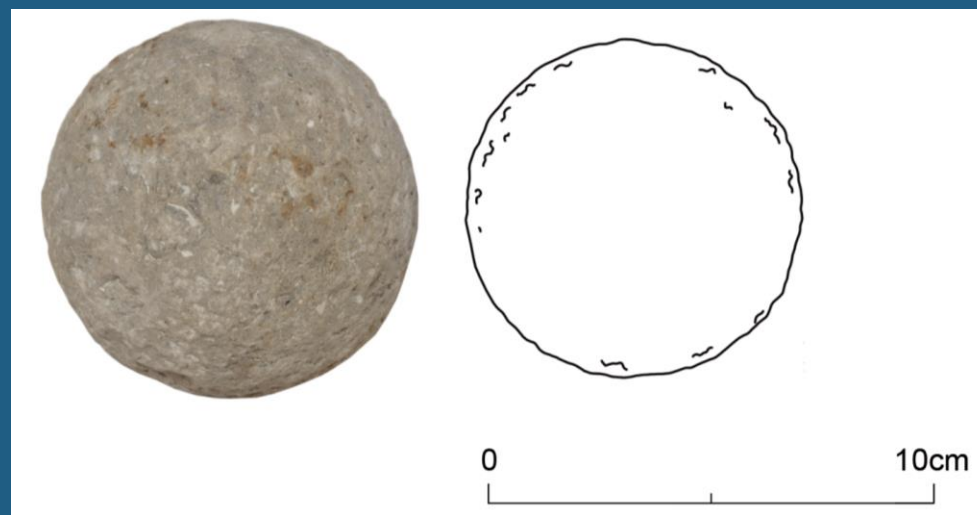

## Geological Studies as a Source of Data on the Maritime Trade between the Cimmerian Bosphorus and the Mediterranean in the 1<sup>st</sup> Millennium BCE

Alexey Khotylev – Sergey Olkhovskiy

**Abstract** – This article contains the results of an analysis of the stone material found during the geological research of one of the hydrotechnical structures in the Phanagoria harbor (Taman peninsula, Black Sea). Because of the lack of building stone deposits on the peninsula, large amounts of stone had to be imported. The goals of our research were: 1) to determine the volume of stone used during the construction of the 'Eastern Pier'; 2) to identify the type of rock and its provenance; 3) to estimate the scale of stone import to Phanagoria. It has been established that about 50 % of stone material came from the Crimean-Caucasian region, while the rest of it originated in other regions, including the Southern coast of the Black Sea and the Aegean islands.

**Inhalt** – Dieser Beitrag stellt die Ergebnisse einer Analyse des Steinmaterials vor, das während des geologischen Surveys archäologischer Befunde im Hafen von Phanagoria (Taman-Halbinsel, Schwarzes Meer) gefunden wurde. Da auf der Halbinsel kein zum Bauen geeigneter Stein ansteht, mussten große Mengen von Steinen importiert werden. Die Ziele unserer Forschung waren: 1) das Volumen des für den Bau der 'Östlichen Mole' genutzten Steinmaterials zu bestimmen; 2) die Gesteine und ihre Herkunft zu bestimmen; 3) den Umfang des Steinimports nach Phanagoria zu schätzen. Es wurde festgestellt, dass etwa 50 % des Steinmaterials aus der Region Krim/Kaukasus kommt, während der Rest aus anderen Regionen stammt, darunter der Südküste des Schwarzen Meers und der ägäischen Inseln.

For many centuries Phanagoria, a city founded by Greeks in the 6<sup>th</sup> century BCE on the South coast of the Taman Bay (Black Sea), was an important transit center on the trade route from the Mediterranean to Azov Sea (fig. 1). The city did not possess a comfortable natural harbor, but, undoubtedly, had a developed port structure. Because of the Black Sea level's transgression, the coastal part of the city and its port were submerged and covered by marine sediments. A magnetic marine map of the water area opposing the central part of the city shows a linear anomaly created by a large rock congestion. The following research is dedicated to the study of the composition of stone that creates this congestion.

### Research methods

The open stone settings in Phanagoria's water area are only visible near the coast, up to 20 cm depths. Outside of the wave-breaking area all objects are hidden under loose sand, clay and silt deposits as well as perennial seaweed blanket, making any visual survey of the seabed uninformative. Since the area of the submerged part of the city and the port's water area is at least 0,15 km<sup>2</sup>, the chance of successfully studying the city and the port by laying survey pits randomly is too low. Because of that, the main focus of underwater research in Phanagoria is on remote sensing methods – hydromagnetic survey<sup>1</sup> and acoustic profiling<sup>2</sup>.

Hydromagnetic survey is the most efficient method of the Phanagorian water area research. Its efficiency is conditioned by the fact that the Taman Peninsula consists mostly of clay and has a very low natural magnetic background. On this background, the objects with stronger magnetic characteristics (volcanic, plutonic or metamorphic rocks) as well as ceramics produce significant anomalies<sup>3</sup>. A camera analysis of magnetic data allows the researchers to find

<sup>1</sup> Кузнецов – Ольховский 2016.

<sup>2</sup> Olkhovskiy et al. 2017.

<sup>3</sup> Lanza – Meloni 2006; Смирнова и др. 2007.



# L'épave de **Phanagoria** : un navire de guerre d'époque hellénistique

Sergey Olkhovskiy  
Pierre Poveda  
Giulia Boetto

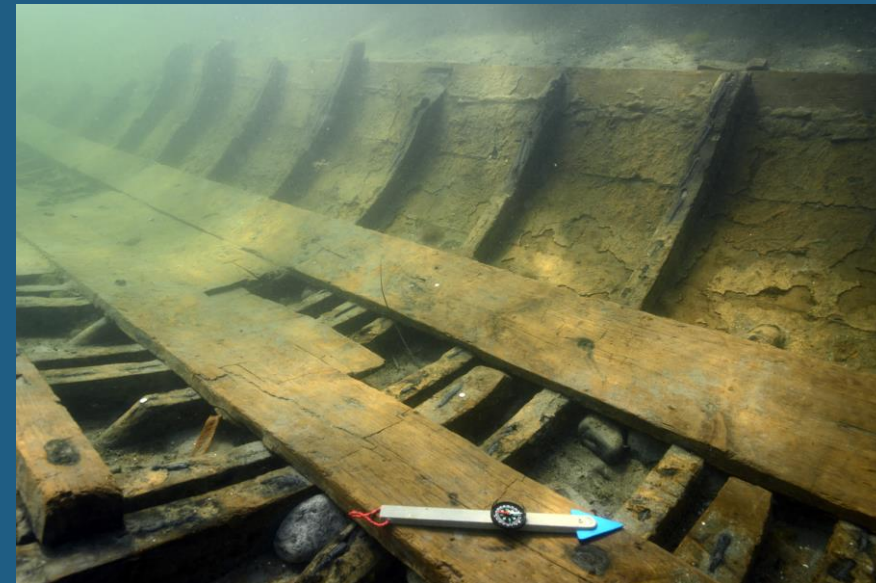

2014



2014

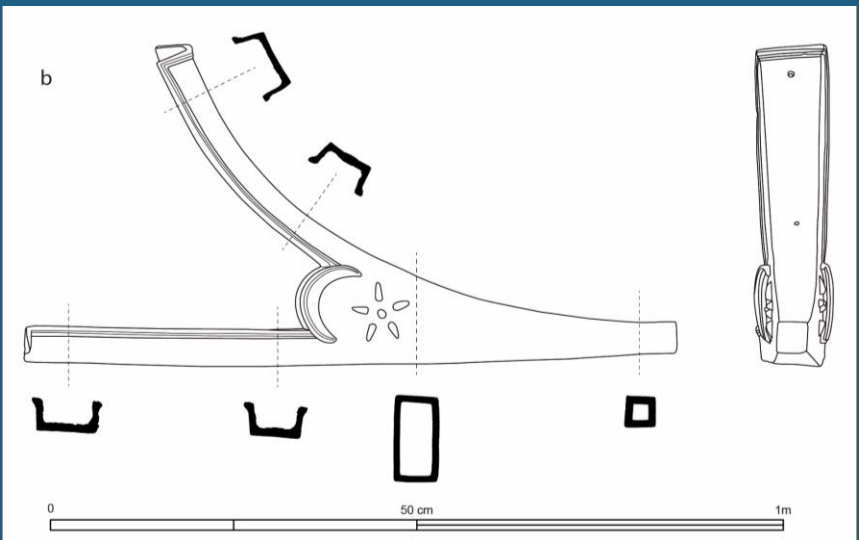



# L'épave de Phanagoria : un navire de guerre d'époque hellénistique

Sergey Olkhovskiy  
Pierre Poveda  
Giulia Boetto

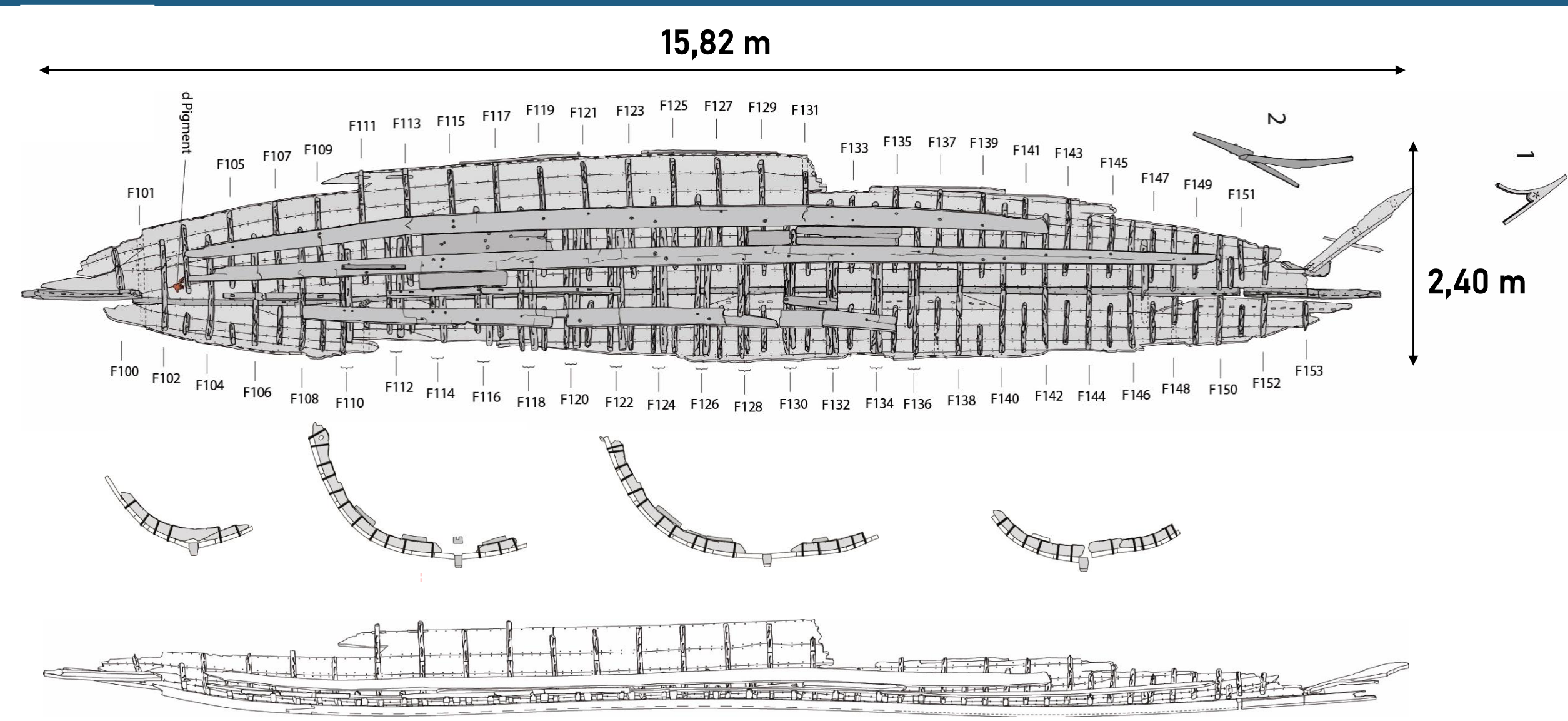



- Charpente Axiale

- Quille:
  - 13 m de longueur
  - 10 cm x 6 cm en section



- Datation

N <sup>o</sup>	IGAN <sub>A</sub> MS	<sup>14</sup> C, BP (1σ)	cal BP, BC
1	6995	2172±20 -150	95.4 (2 sigma) cal BC <b>356</b> - 284 0.593 256- 249 0.008 234- 169 0.399 Median Probability: -304
2	6994	2138±20 - 119	95.4 (2 sigma) cal BC 348- 317 0.108 207- <b>95</b> 0.892 Median Probability: -178

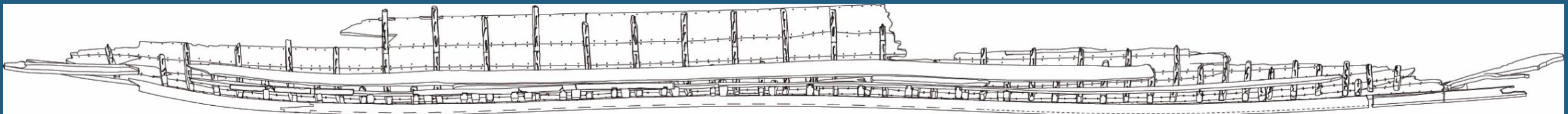



## • Bordé

13 virures (8 bâbord et 5 tribord)

4,2 cm : épaisseur moyenne des galbords

3,2 cm : épaisseur moyenne du reste du bordé

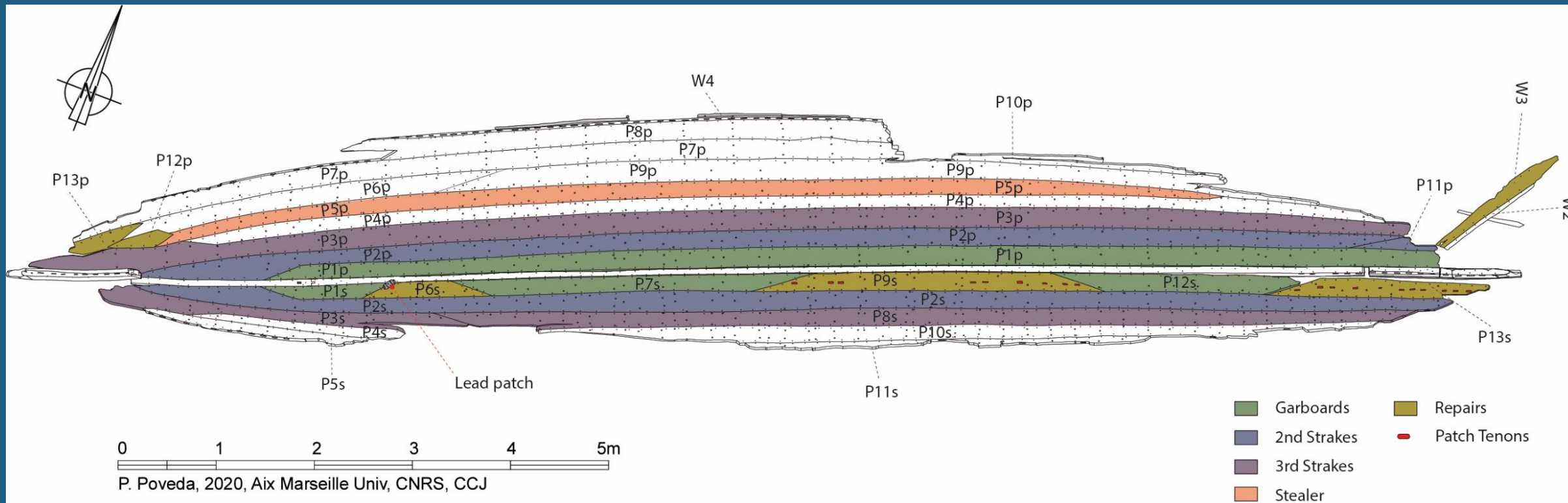



# L'épave de Phanagoria : un navire de guerre d'époque hellénistique

Sergey Olkhovskiy  
Pierre Poveda  
Giulia Boetto

- Bordé

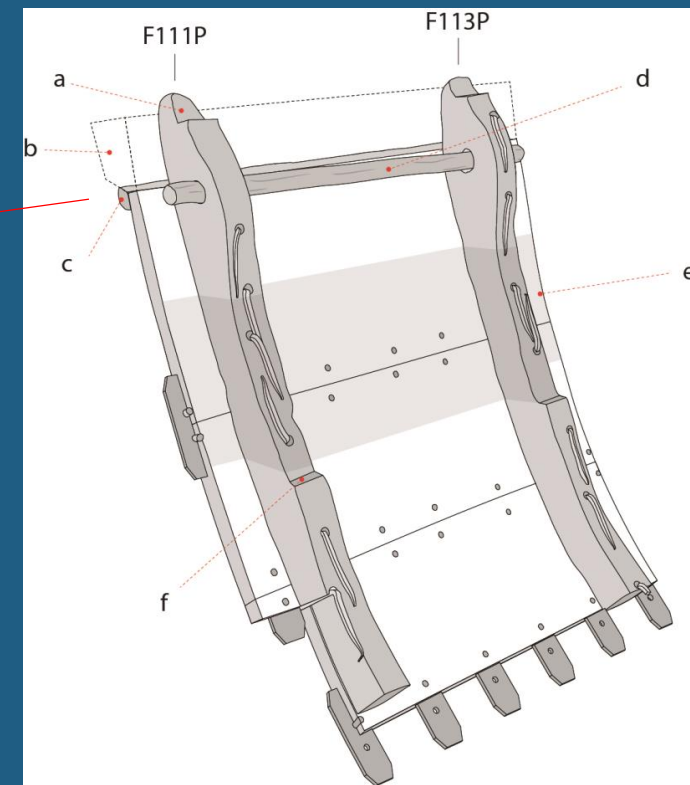
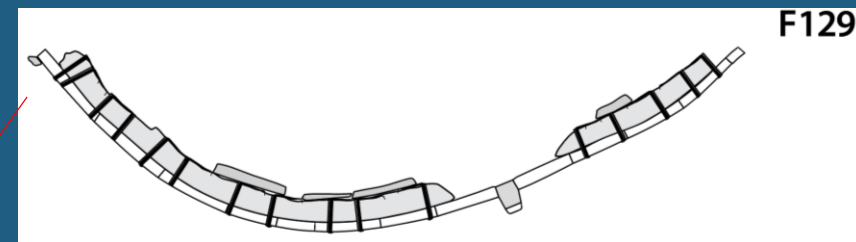
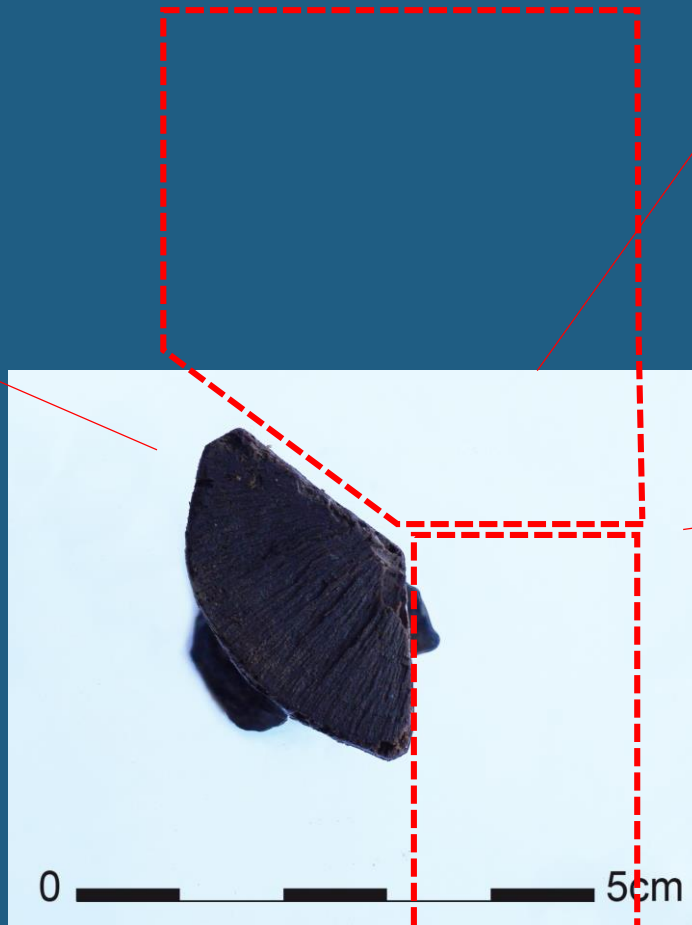



## • Charpente transversale

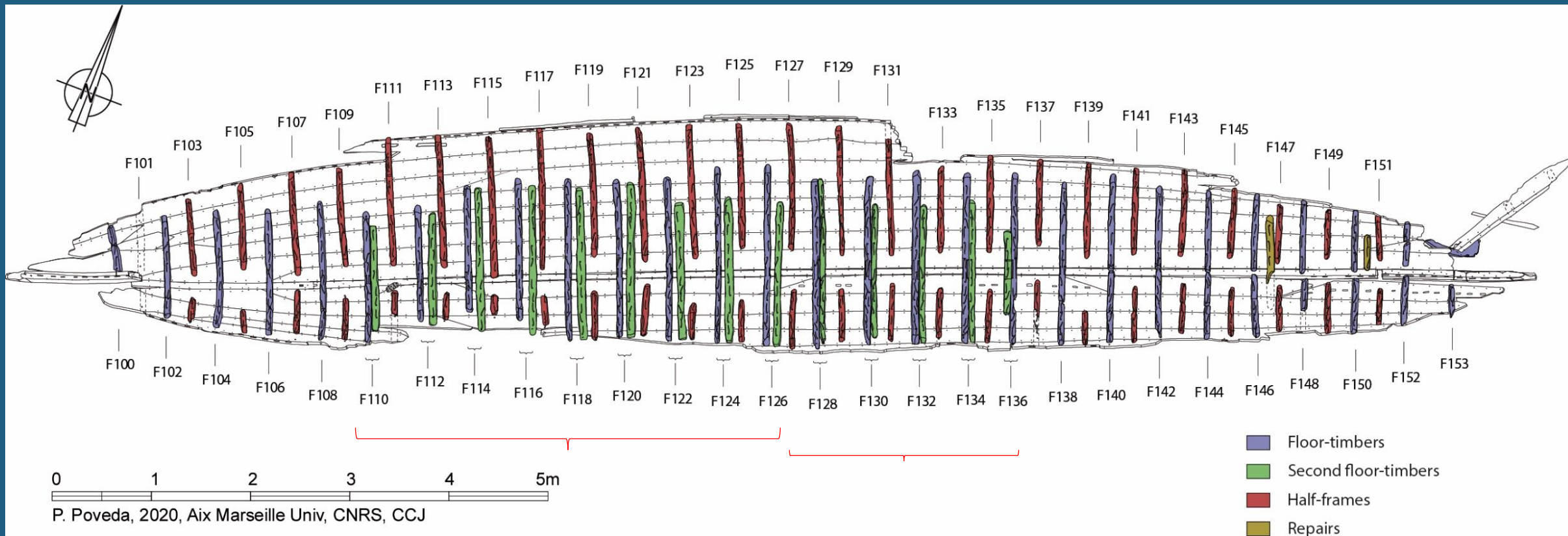

- Charpente transversale

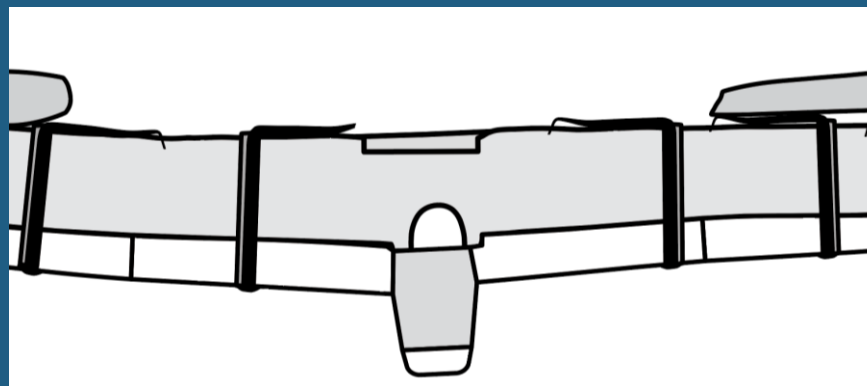
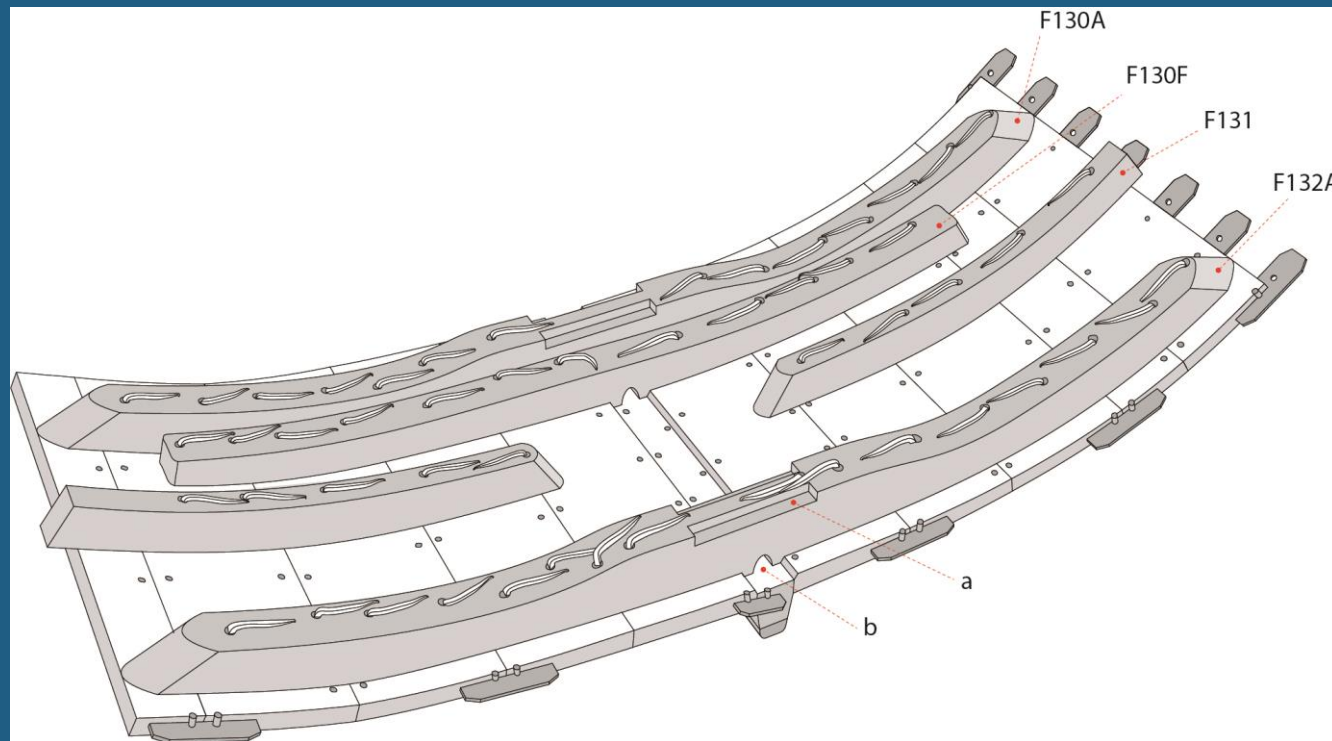



- Charpente transversale

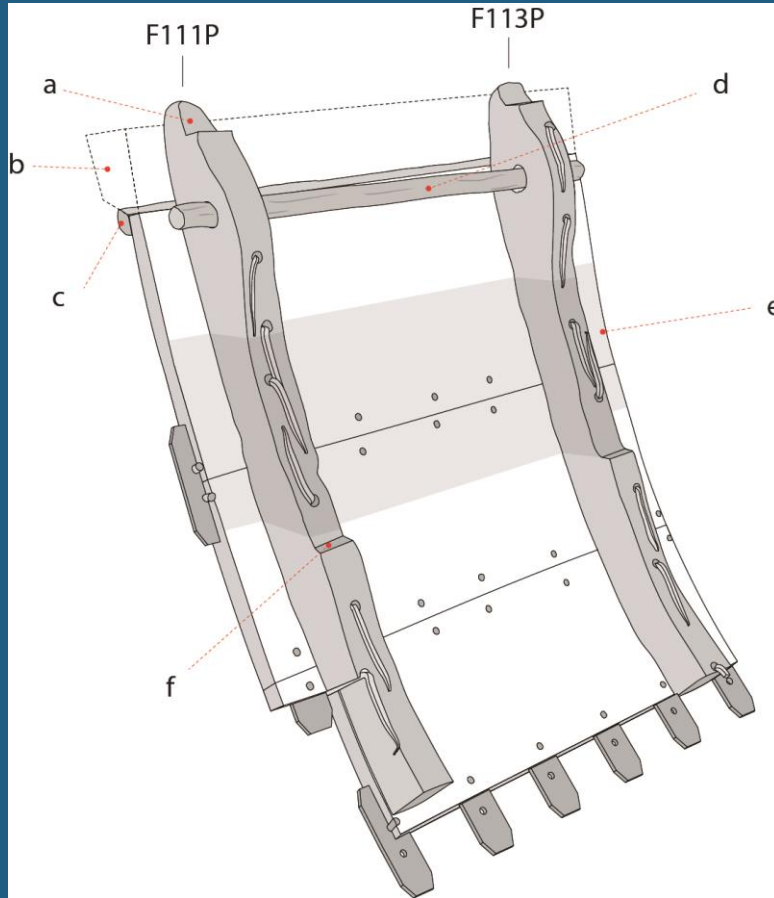

- Charpente transversale





- Vaigrage et charpente longitudinale interne

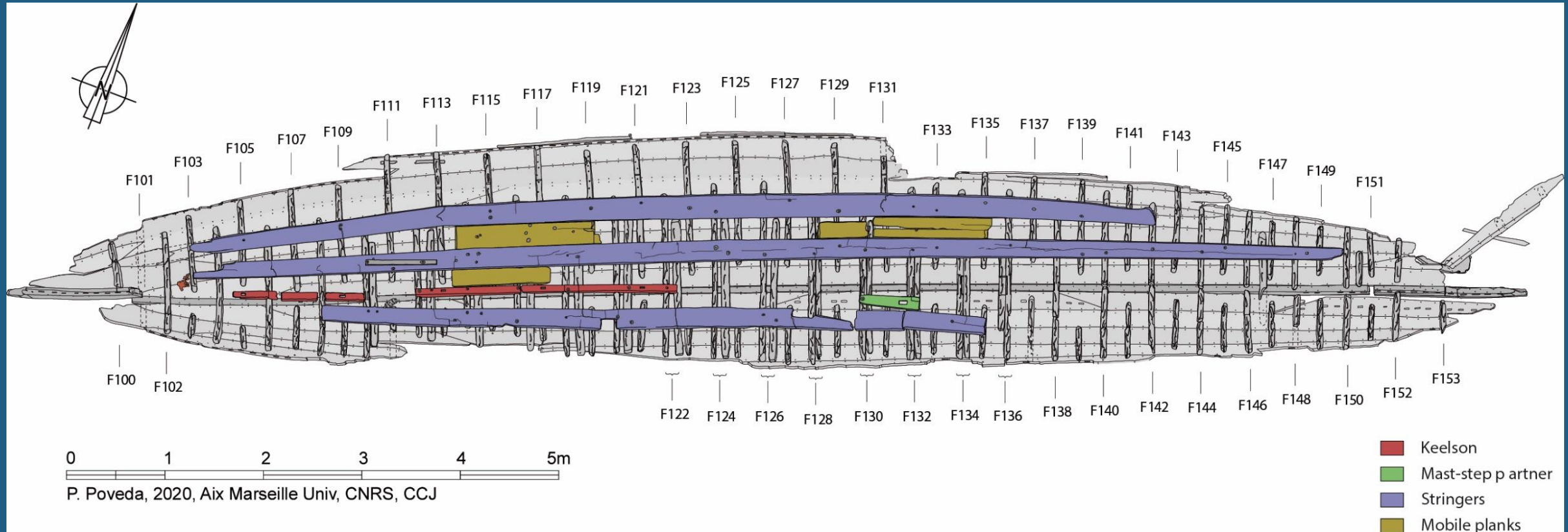

# L'épave de Phanagoria : un navire de guerre d'époque hellénistique

Sergey Olkhovskiy  
Pierre Poveda  
Giulia Boetto

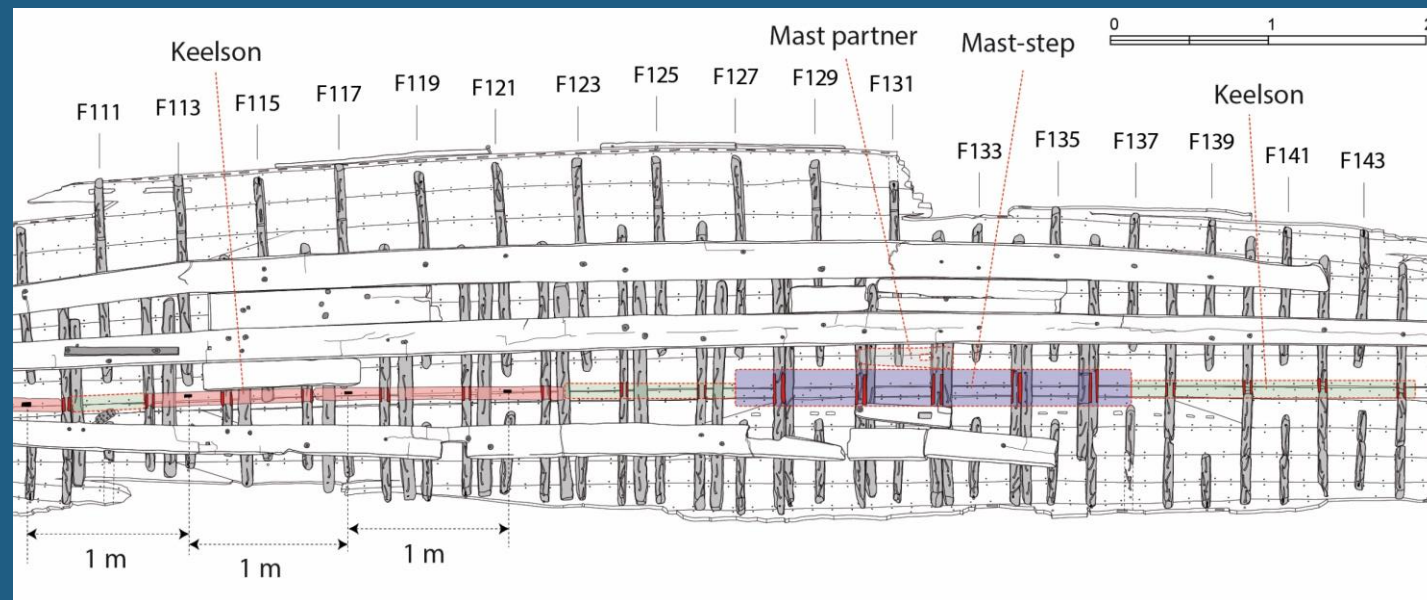
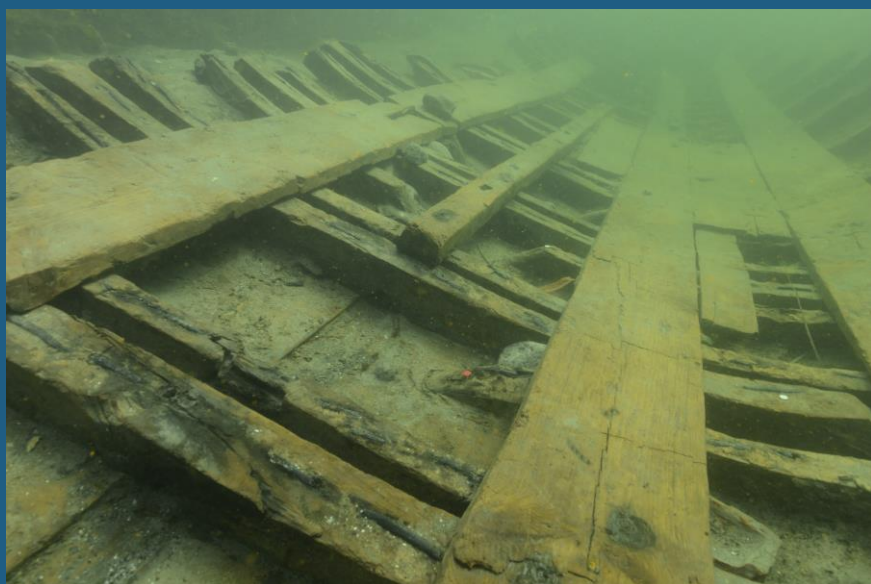



# L'épave de Phanagoria : un navire de guerre d'époque hellénistique

Sergey Olkhovskiy  
Pierre Poveda  
Giulia Boetto

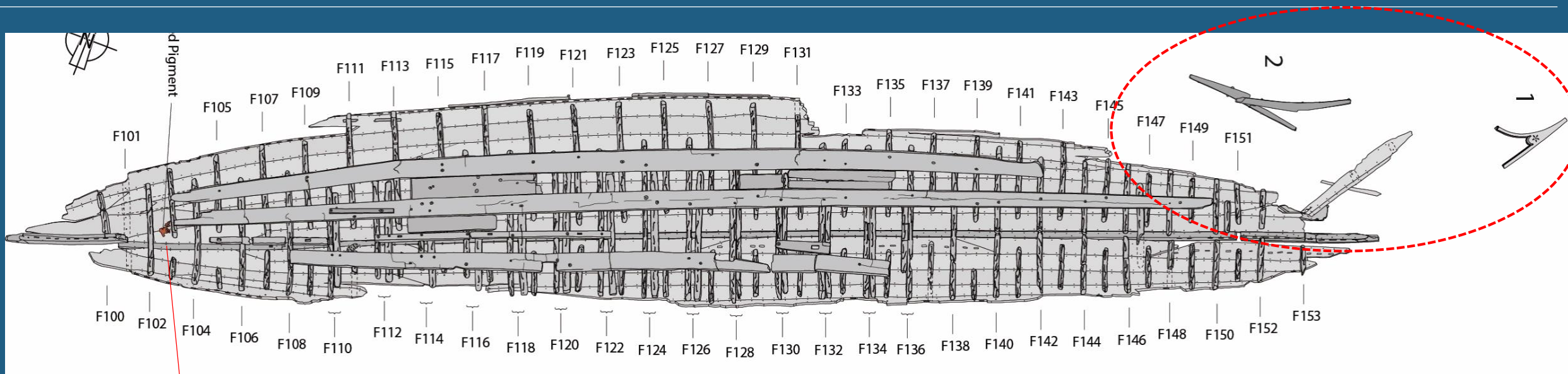



# L'épave de **Phanagoria** : un navire de guerre d'époque hellénistique

Sergey Olkhovskiy  
Pierre Poveda  
Giulia Boetto





# L'épave de Phanagoria : un navire de guerre d'époque hellénistique

Sergey Olkhovskiy  
Pierre Poveda  
Giulia Boetto

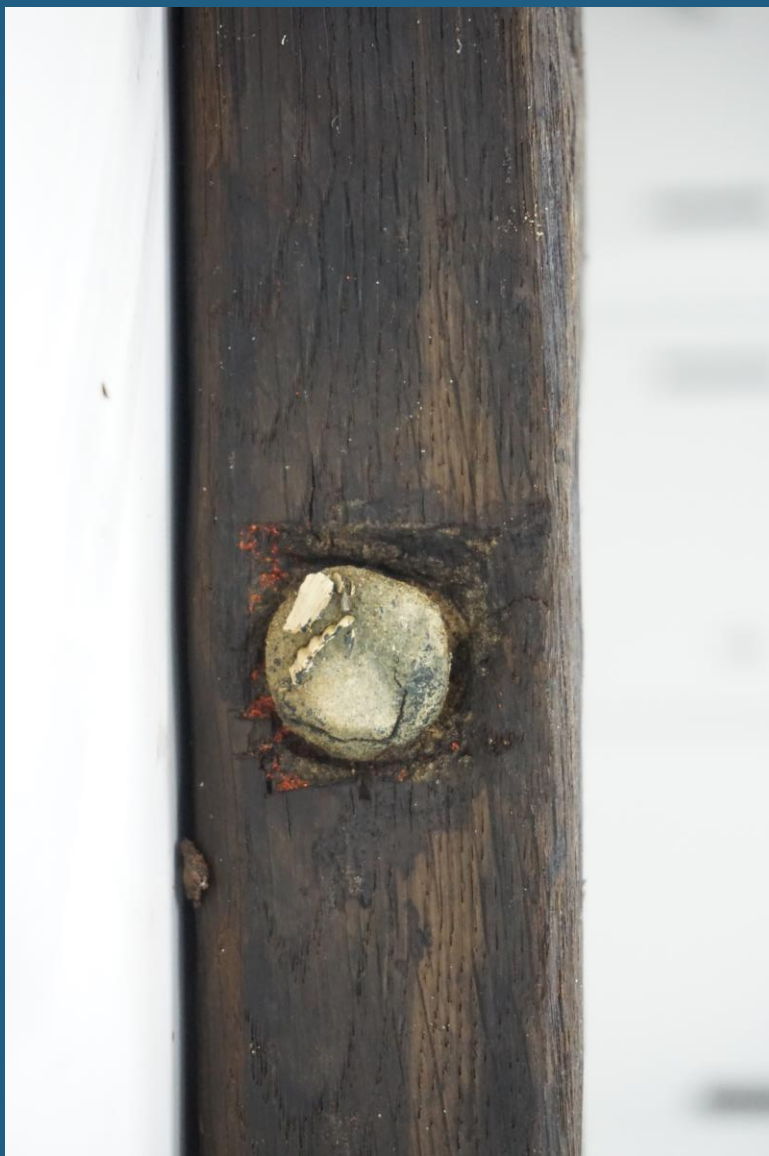

# L'épave de Phanagoria : un navire de guerre d'époque hellénistique

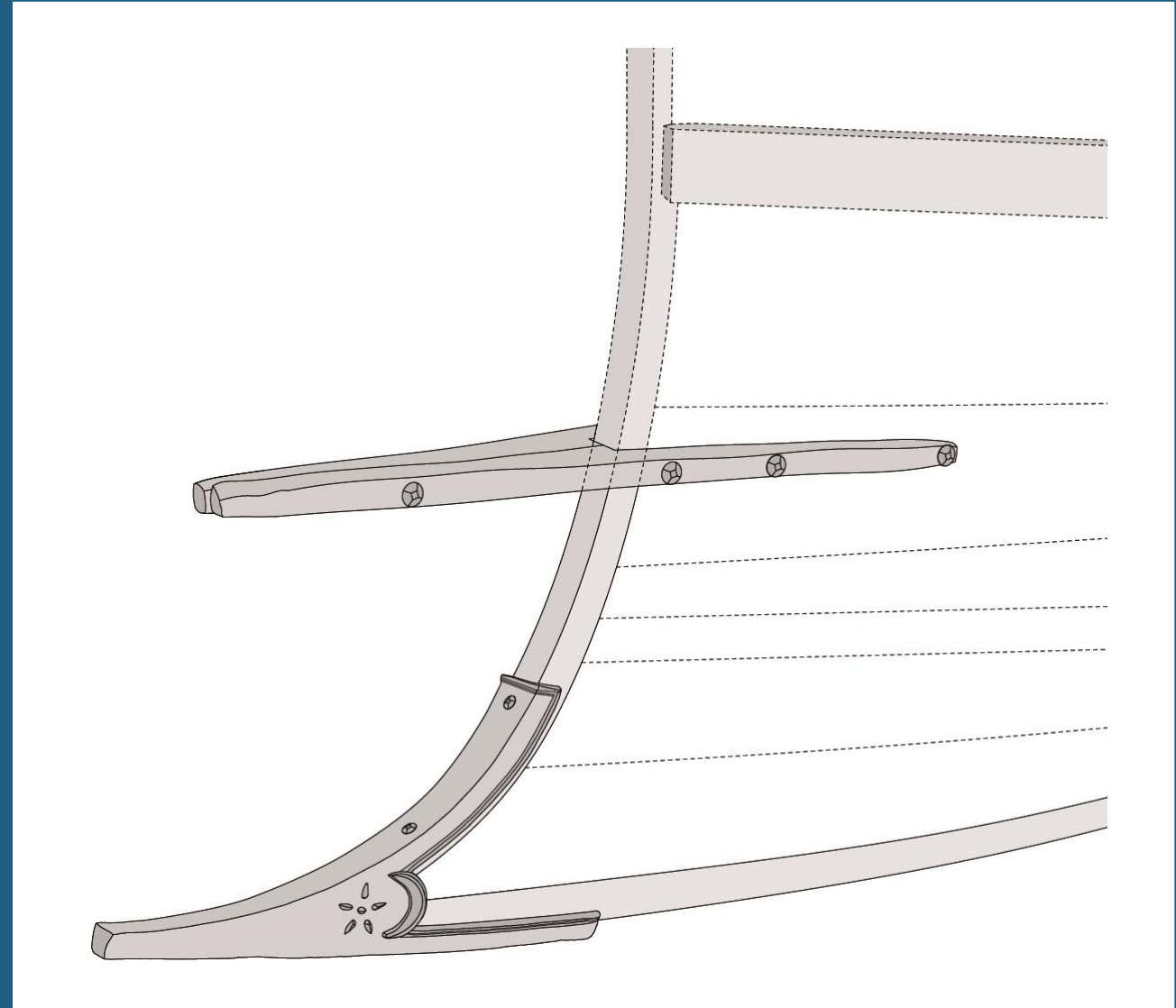
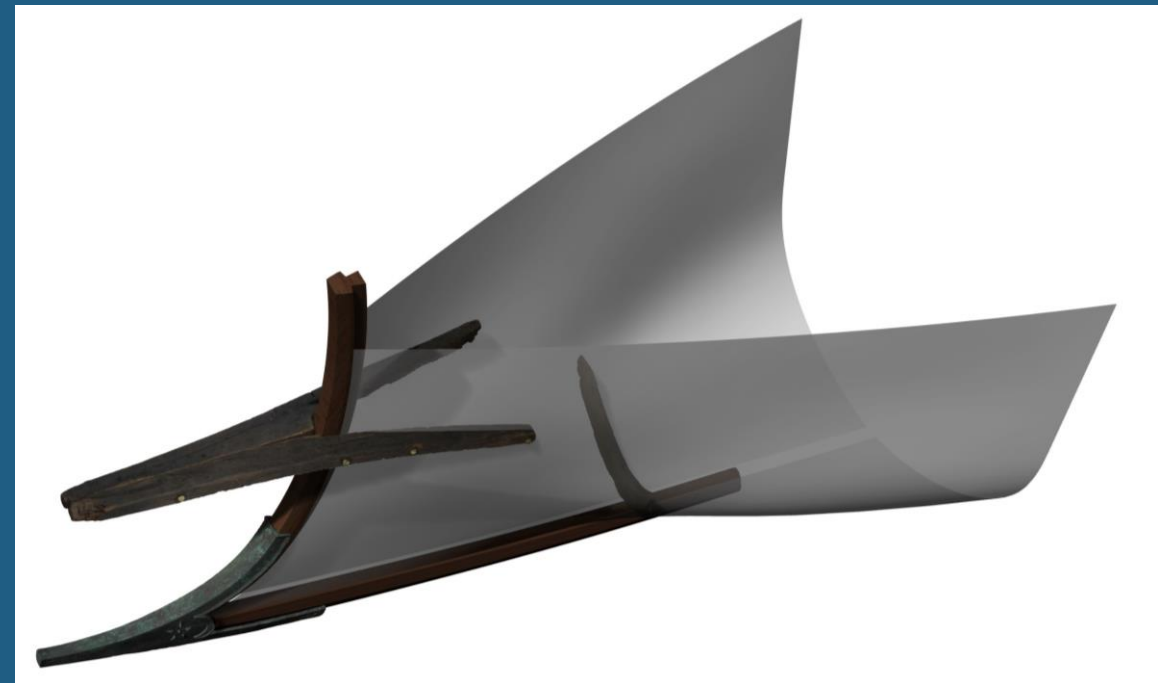
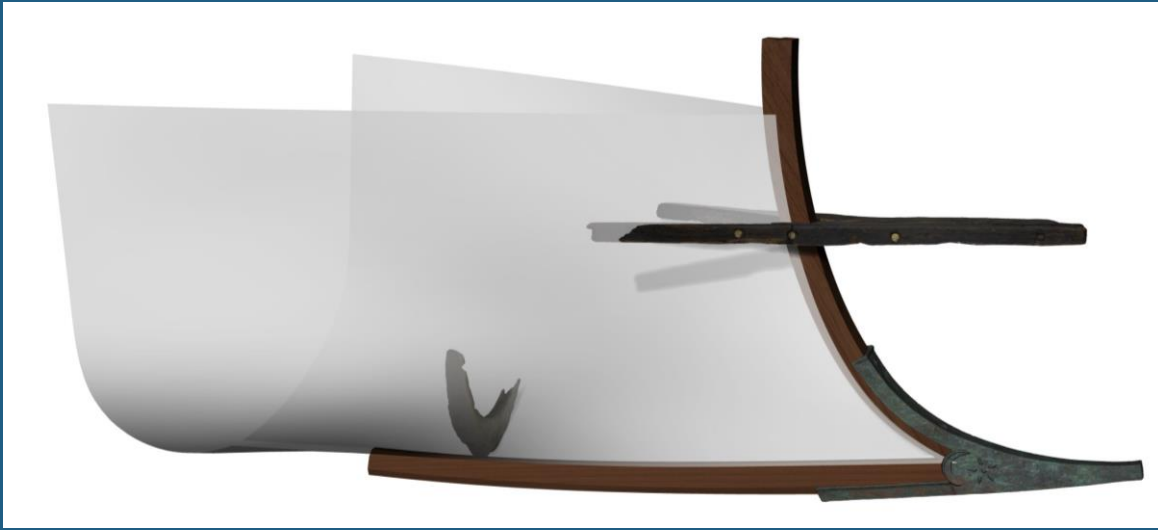



# L'épave de Phanagoria : un navire de guerre d'époque hellénistique

Sergey Olkhovskiy  
Pierre Poveda  
Giulia Boetto

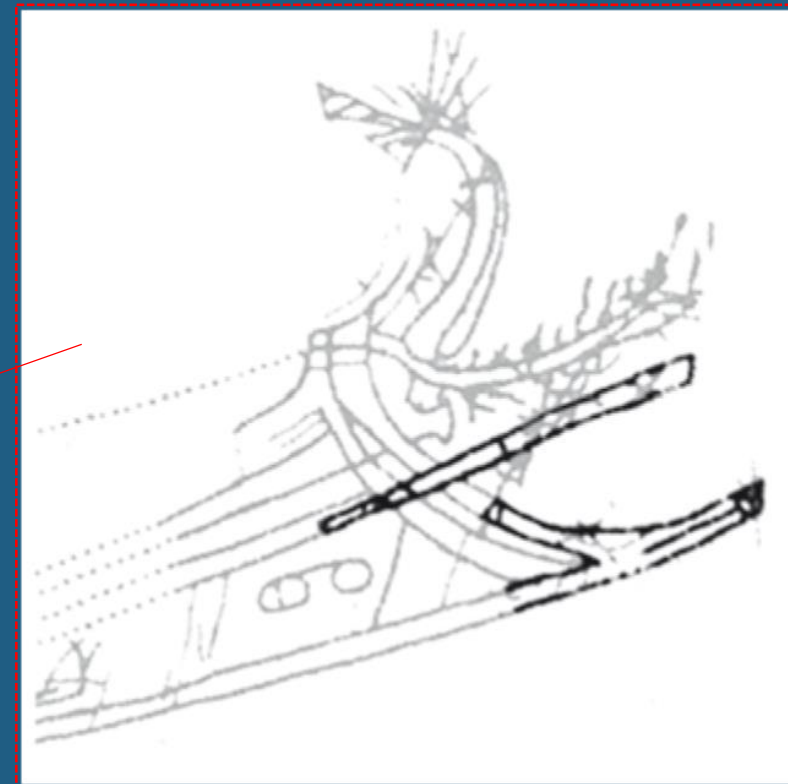
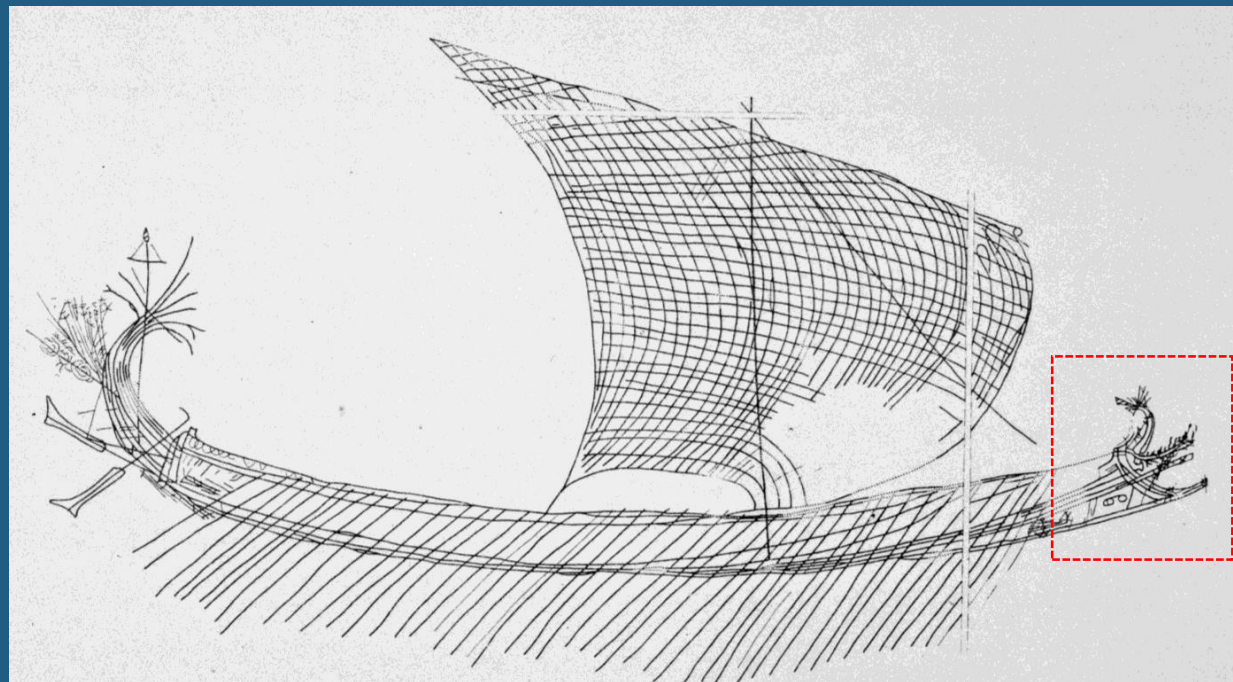

• Identification Xylologique  
 (C. Cenzon-Salvayre)

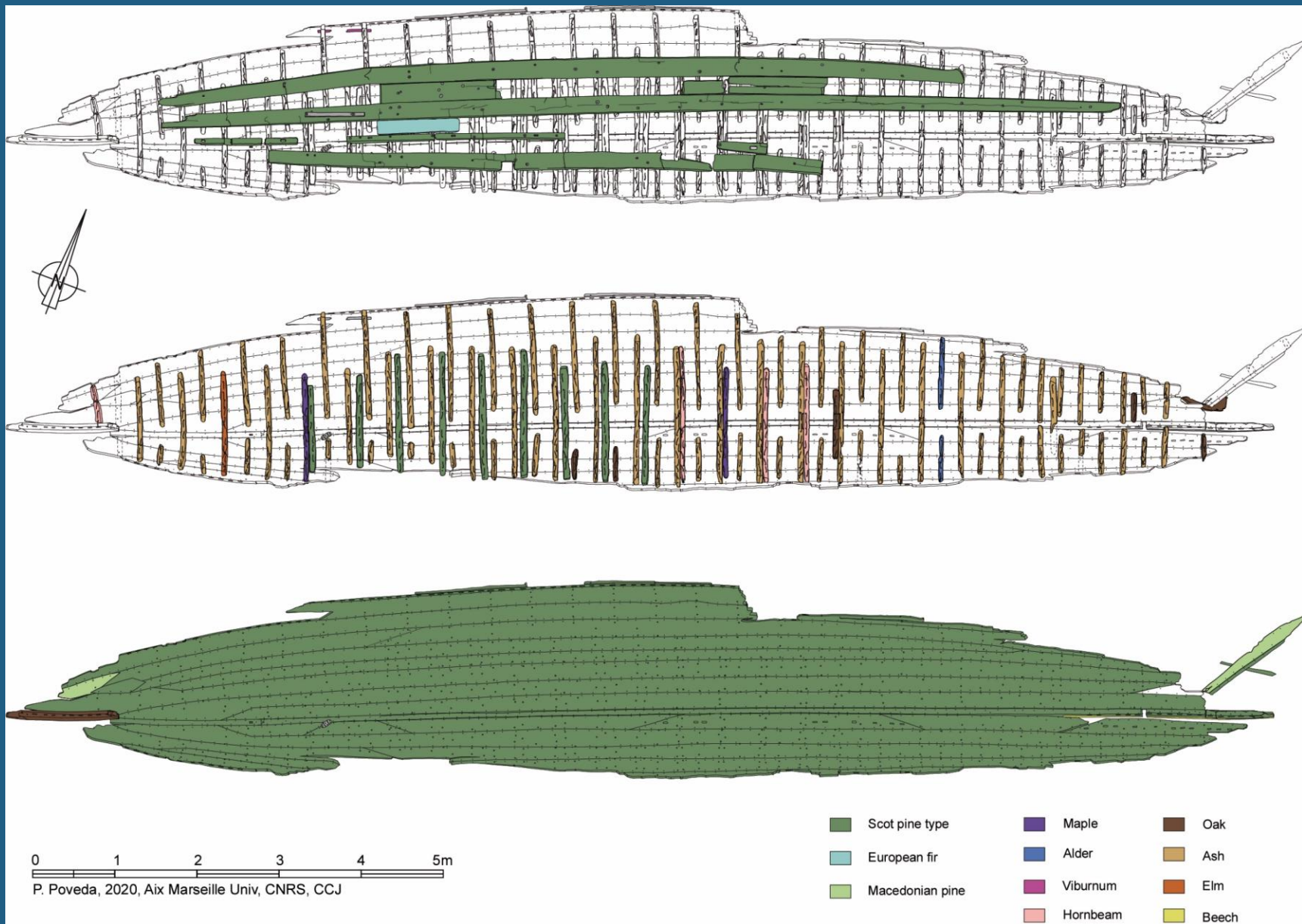
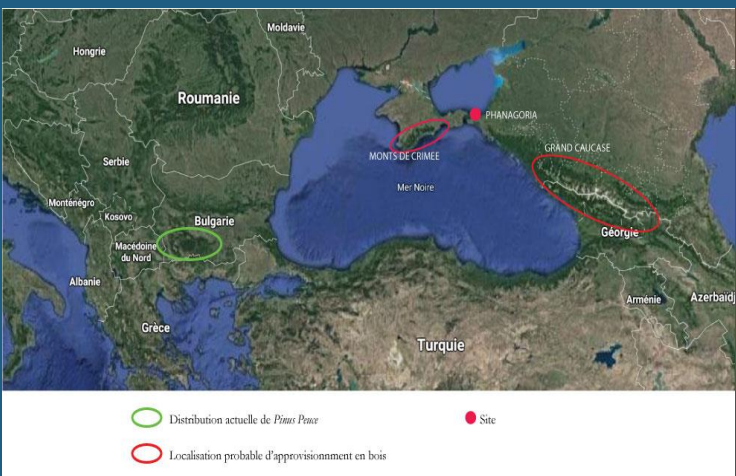



# L'épave de **Phanagoria** : un navire de guerre d'époque hellénistique

Sergey Olkhovskiy  
Pierre Poveda  
Giulia Boetto

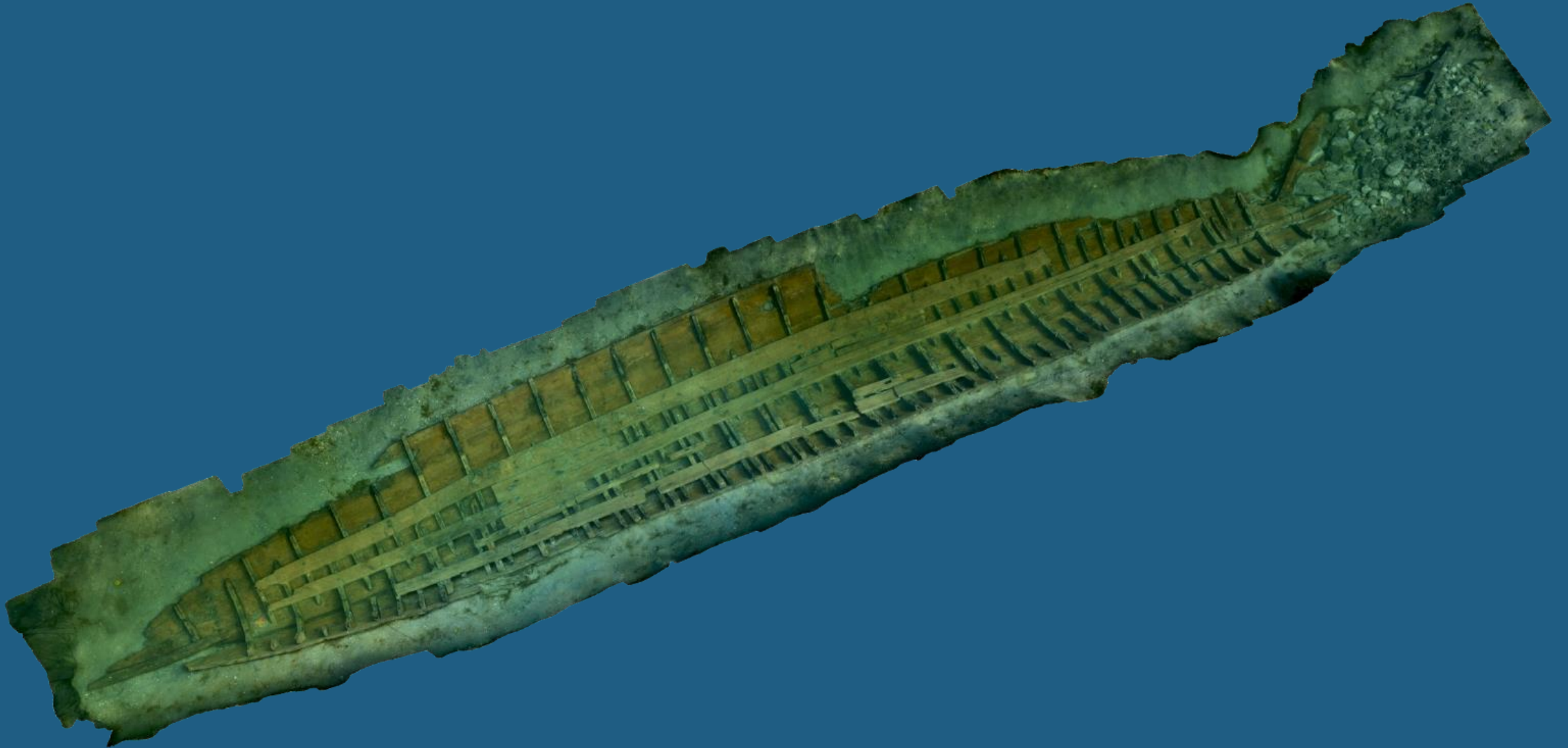

Possibilité d'une reconstruction?

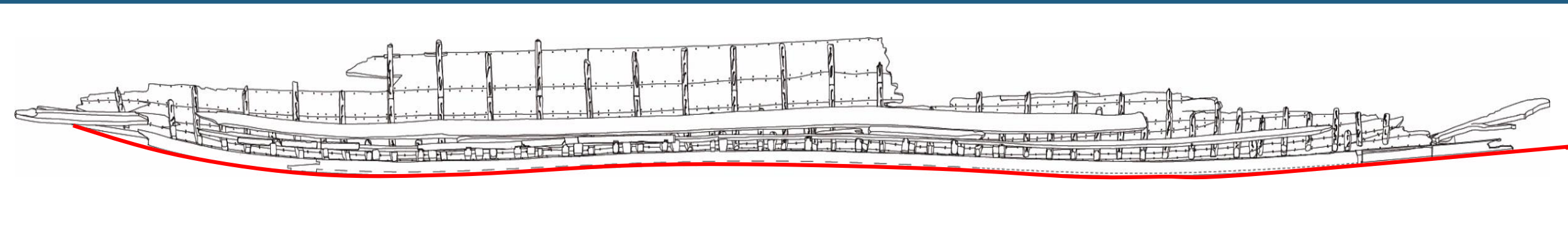
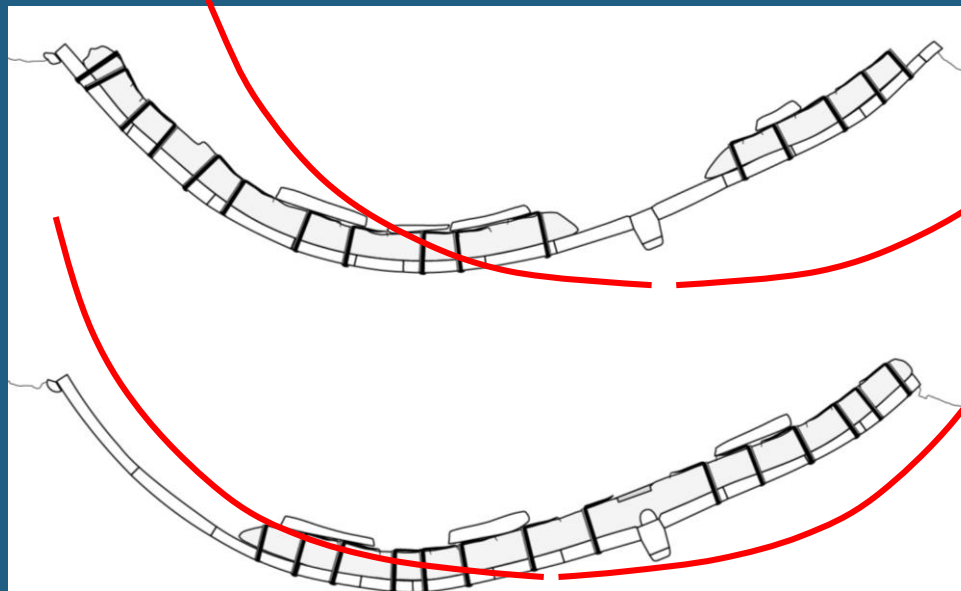



# L'épave de Phanagoria : un navire de guerre d'époque hellénistique

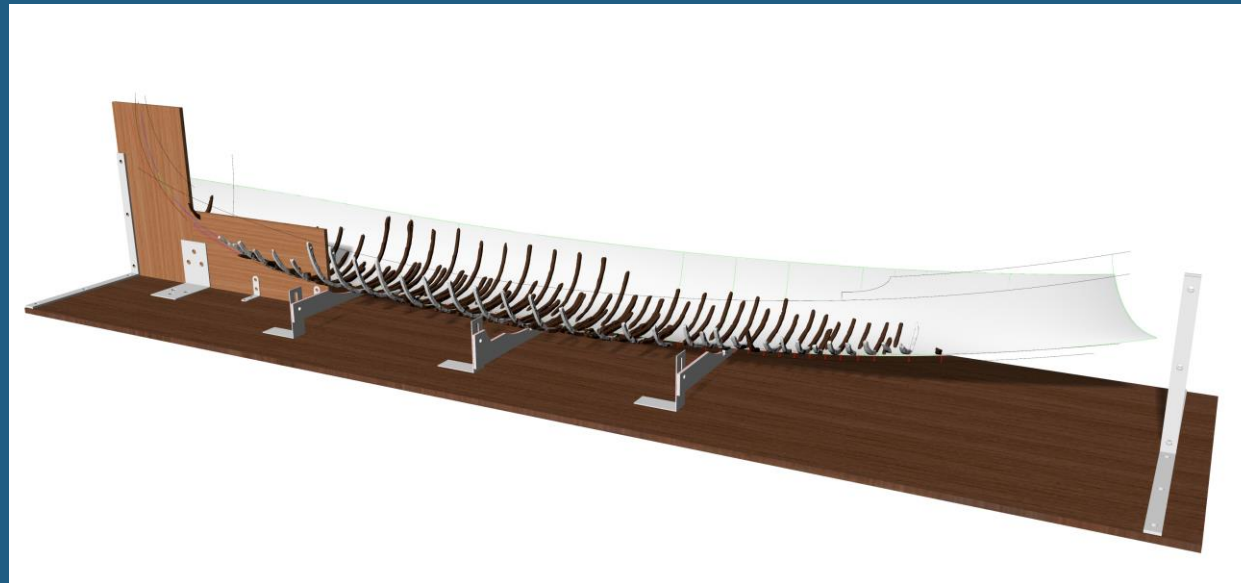
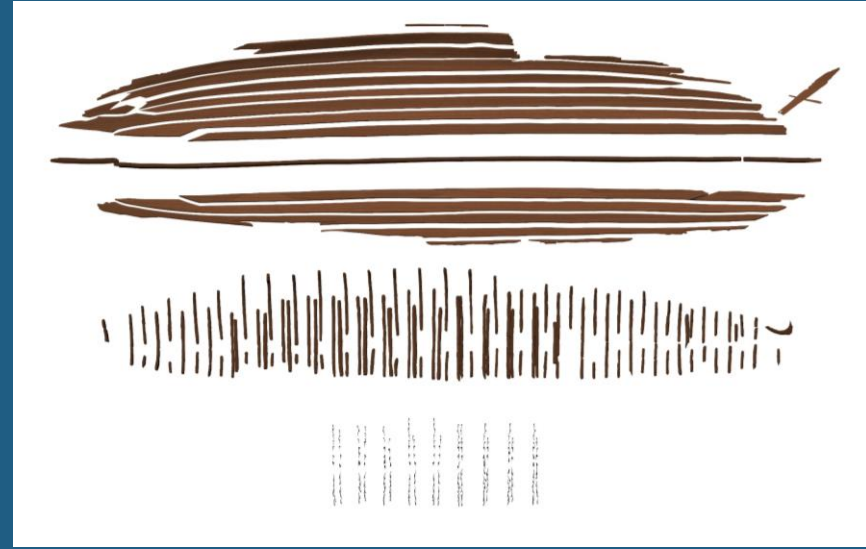

## L'épave de **Phanagoria** : un navire de guerre d'époque hellénistique





# L'épave de **Phanagoria** : un navire de guerre d'époque hellénistique

Sergey Olkhovskiy  
Pierre Poveda  
Giulia Boetto

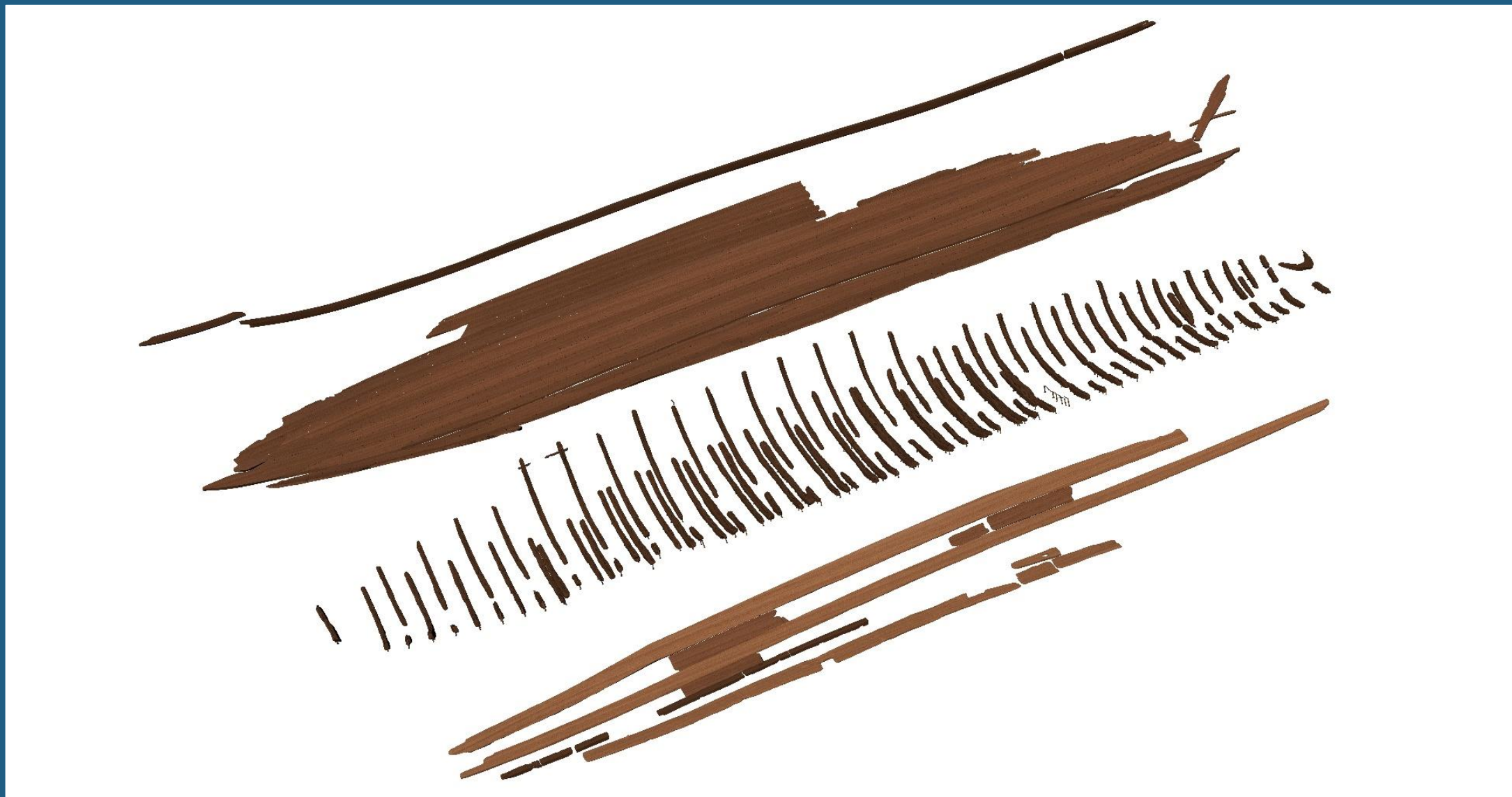

## L'épave de **Phanagoria** : un navire de guerre d'époque hellénistique

Sergey Olkhovskiy  
Pierre Poveda  
Giulia Boetto

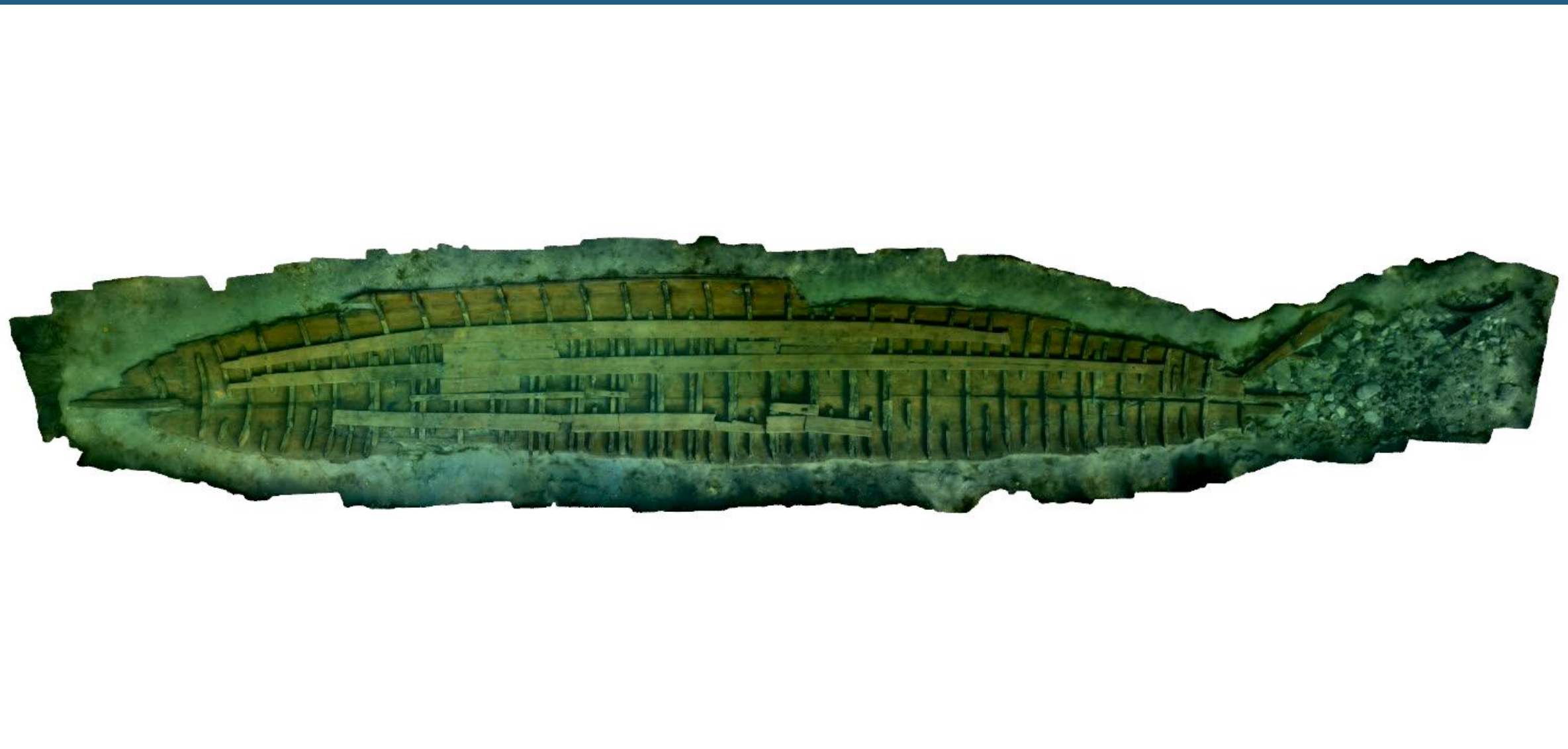



# L'épave de Phanagoria : un navire de guerre d'époque hellénistique

Sergey Olkhovskiy  
Pierre Poveda  
Giulia Boetto

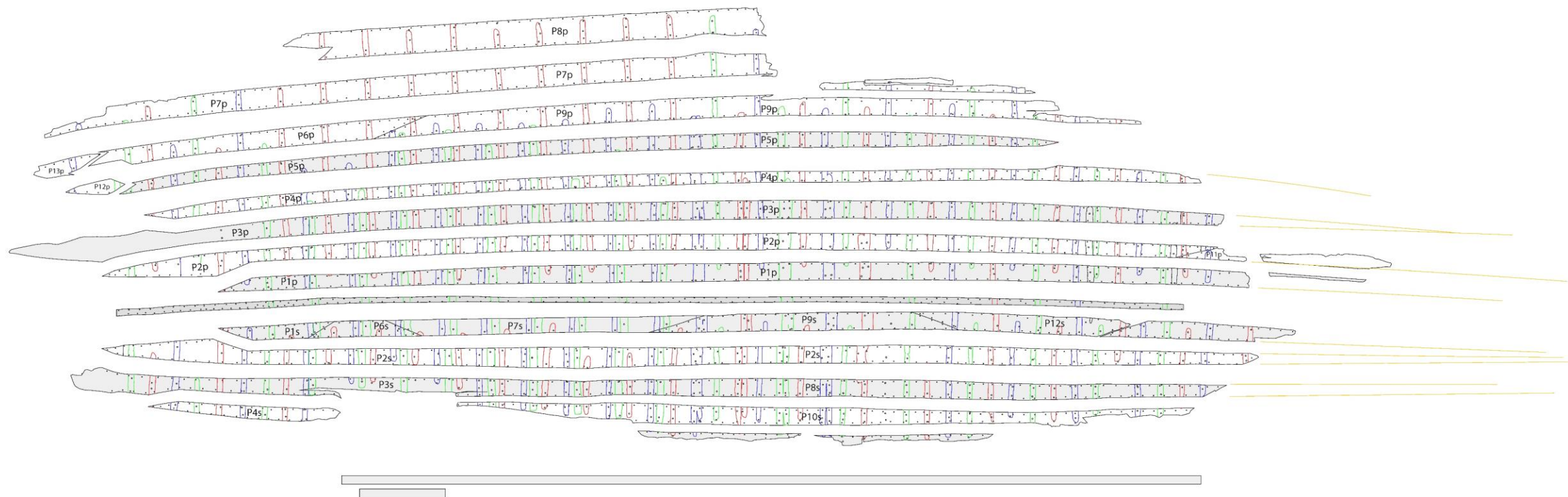

# L'épave de Phanagoria : un navire de guerre d'époque hellénistique

Sergey Olkhovskiy  
Pierre Poveda  
Giulia Boetto

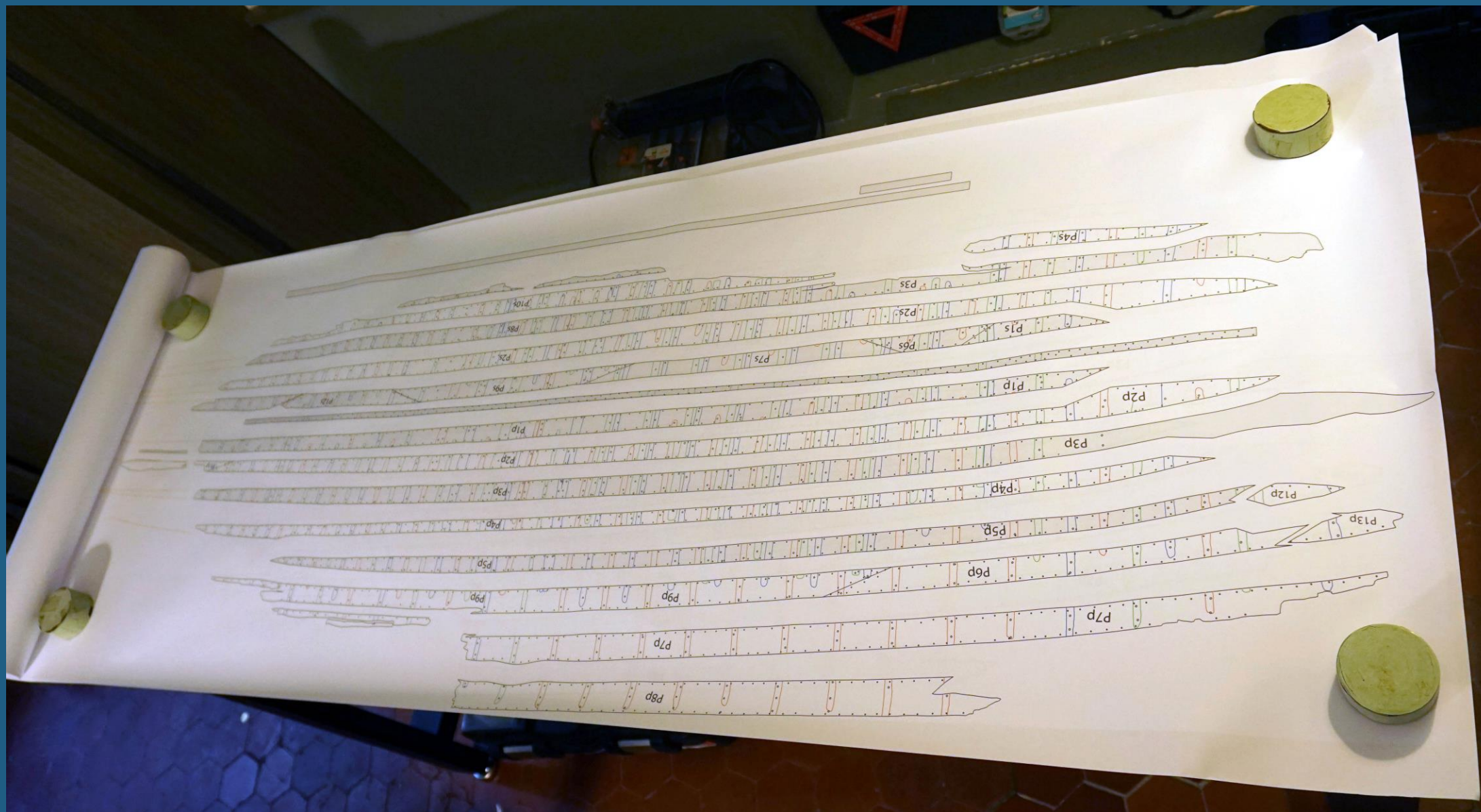



## L'épave de **Phanagoria** : un navire de guerre d'époque hellénistique

Sergey Olkhovskiy  
Pierre Poveda  
Giulia Boetto

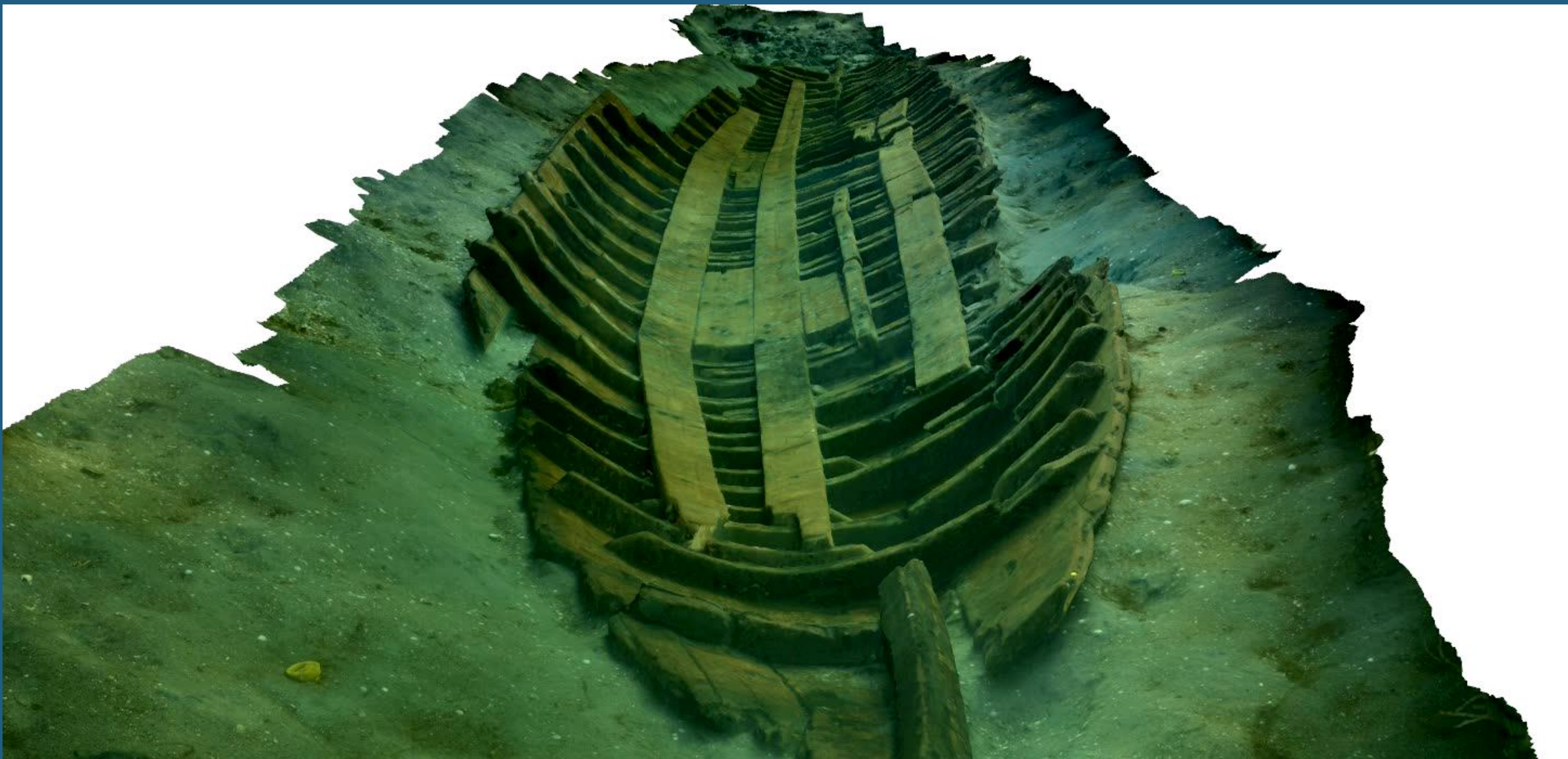



# L'épave de Phanagoria : un navire de guerre d'époque hellénistique

Sergey Olkhovskiy  
Pierre Poveda  
Giulia Boetto





# L'épave de **Phanagoria** : un navire de guerre d'époque hellénistique

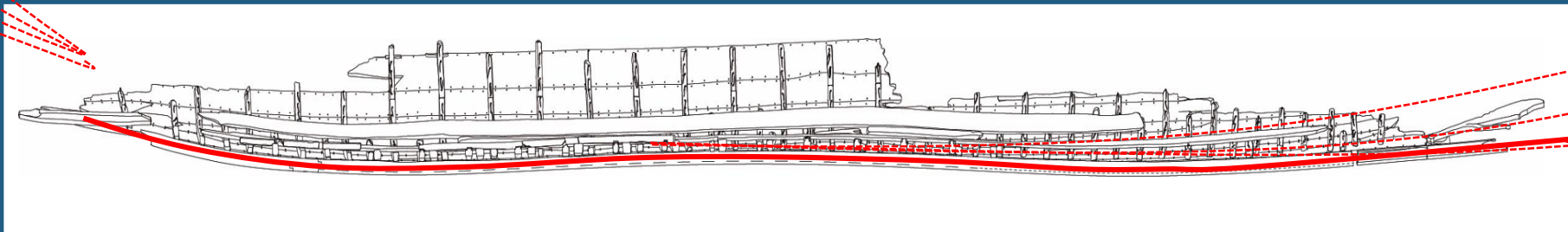





# L'épave de **Phanagoria** : un navire de guerre d'époque hellénistique

Sergey Olkhovskiy  
Pierre Poveda  
Giulia Boetto

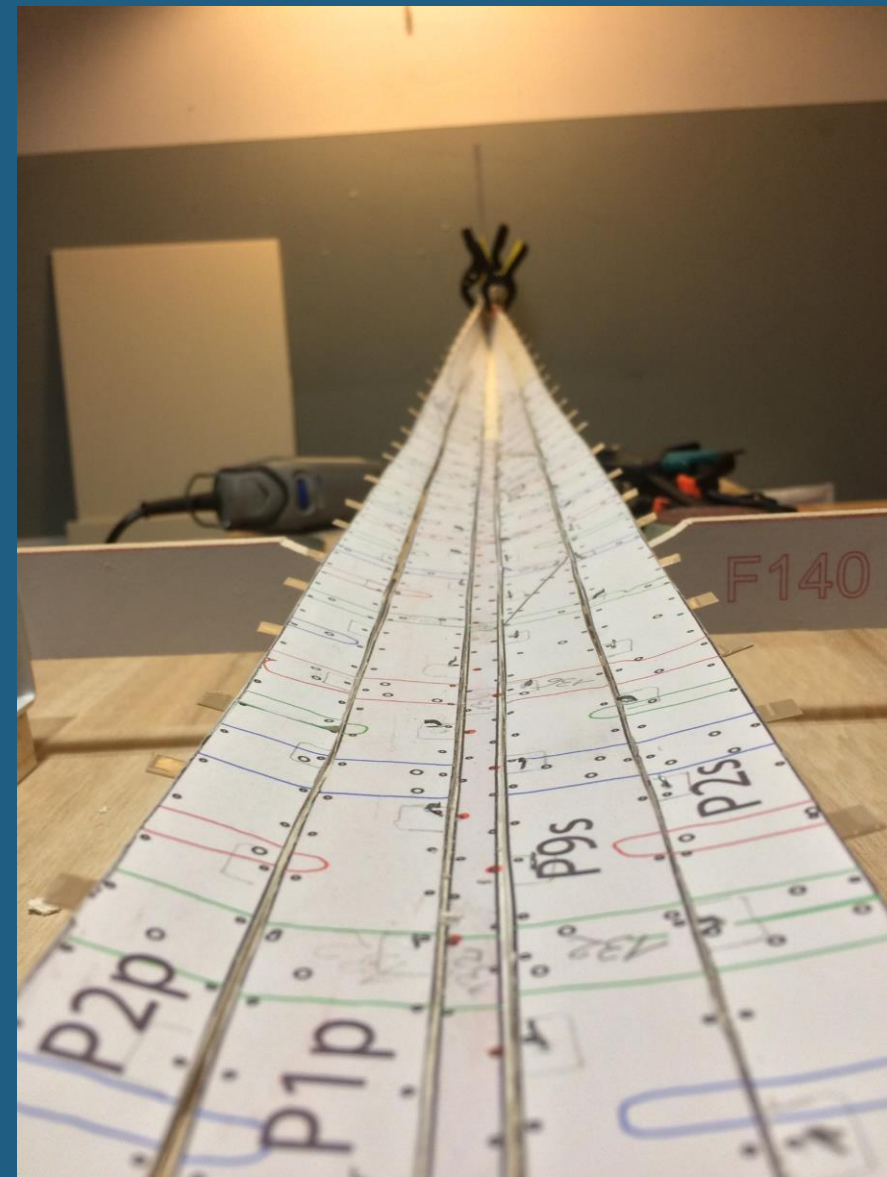
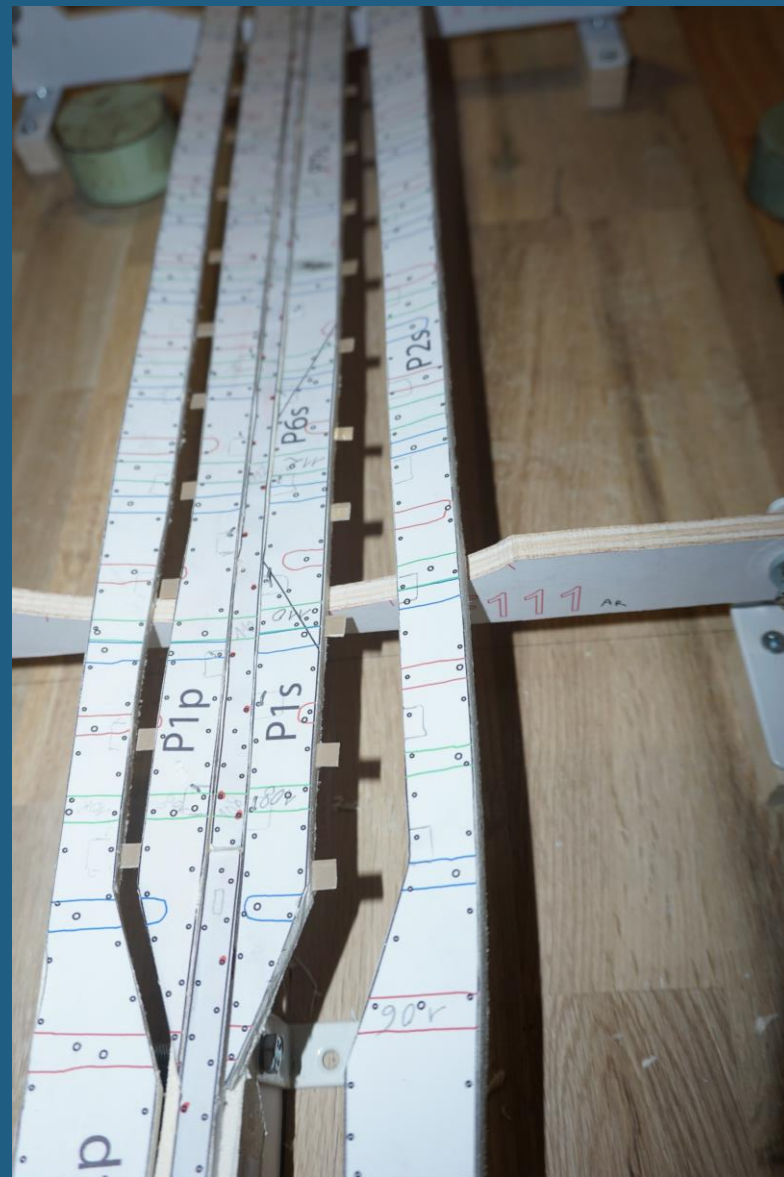



# The Late Hellenistic military ship of Phanagoria

Sergey Olkhovskiy  
Pierre Poveda  
Giulia Boetto

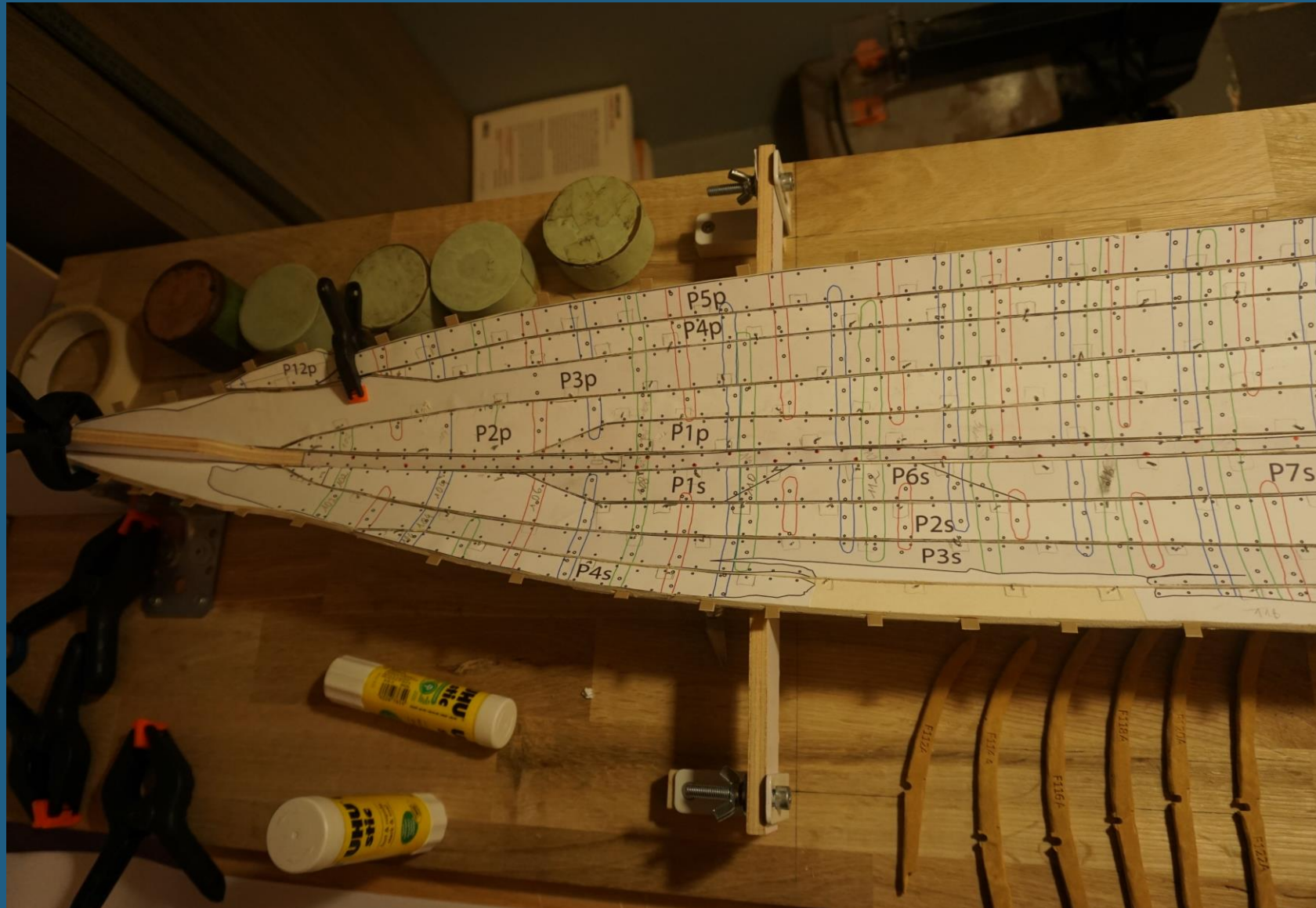



# L'épave de **Phanagoria** : un navire de guerre d'époque hellénistique

Sergey Olkhovskiy  
Pierre Poveda  
Giulia Boetto



# L'épave de **Phanagoria** : un navire de guerre d'époque hellénistique

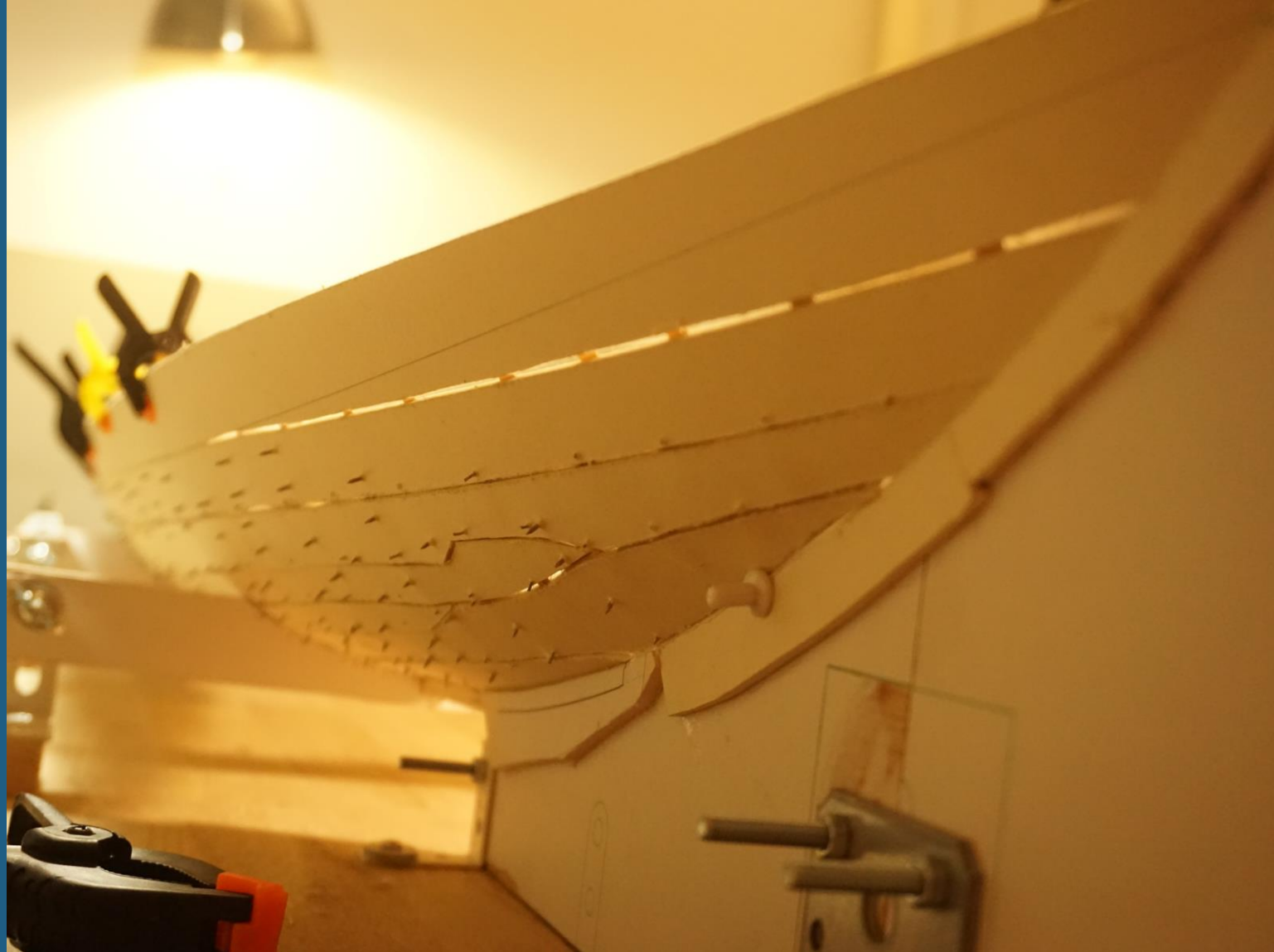



## L'épave de Phanagoria : un navire de guerre d'époque hellénistique

Sergey Olkhovskiy  
Pierre Poveda  
Giulia Boetto





# L'épave de **Phanagoria** : un navire de guerre d'époque hellénistique

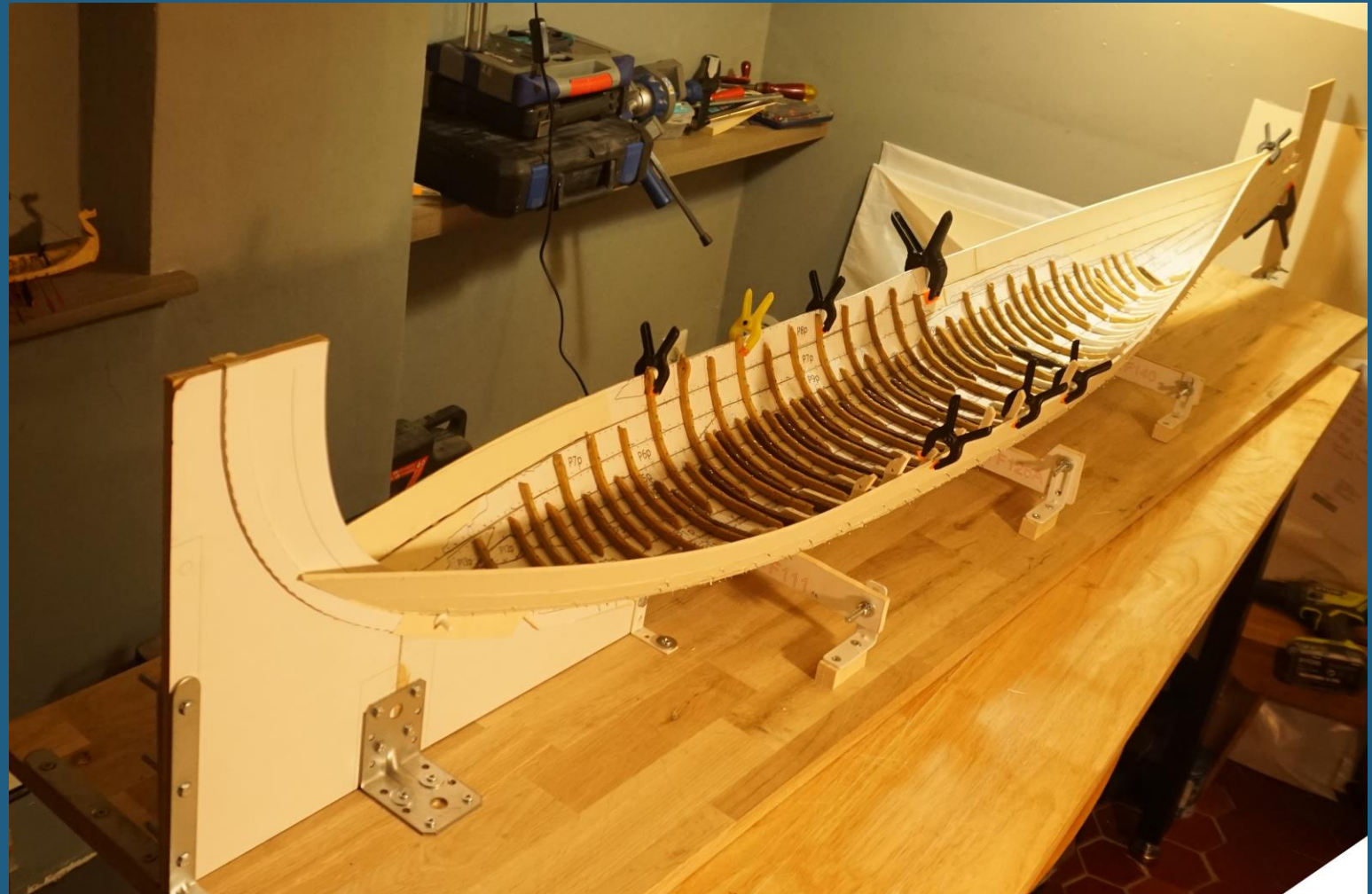



# L'épave de **Phanagoria** : un navire de guerre d'époque hellénistique

Sergey Olkhovskiy  
Pierre Poveda  
Giulia Boetto





# L'épave de **Phanagoria** : un navire de guerre d'époque hellénistique





# L'épave de **Phanagoria** : un navire de guerre d'époque hellénistique

Sergey Olkhovskiy  
Pierre Poveda  
Giulia Boetto



# L'épave de **Phanagoria** : un navire de guerre d'époque hellénistique





# L'épave de **Phanagoria** : un navire de guerre d'époque hellénistique

Sergey Olkhovskiy  
Pierre Poveda  
Giulia Boetto



# L'épave de Phanagoria : un navire de guerre d'époque hellénistique

Sergey Olkhovskiy  
Pierre Poveda  
Giulia Boetto

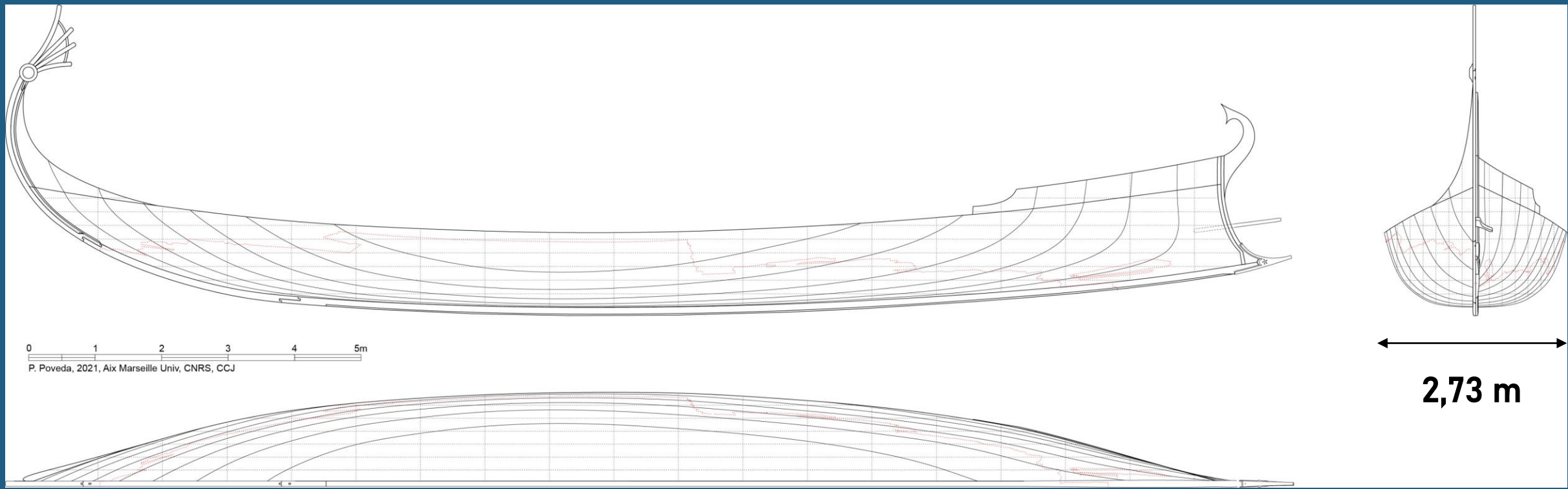

0 1 2 3 4 5m  
P. Poveda, 2021, Aix Marseille Univ, CNRS, CCJ

← →

**2,73 m**

← →

**19,35 m**



# L'épave de **Phanagoria** : un navire de guerre d'époque hellénistique



# L'épave de **Phanagoria** : un navire de guerre d'époque hellénistique

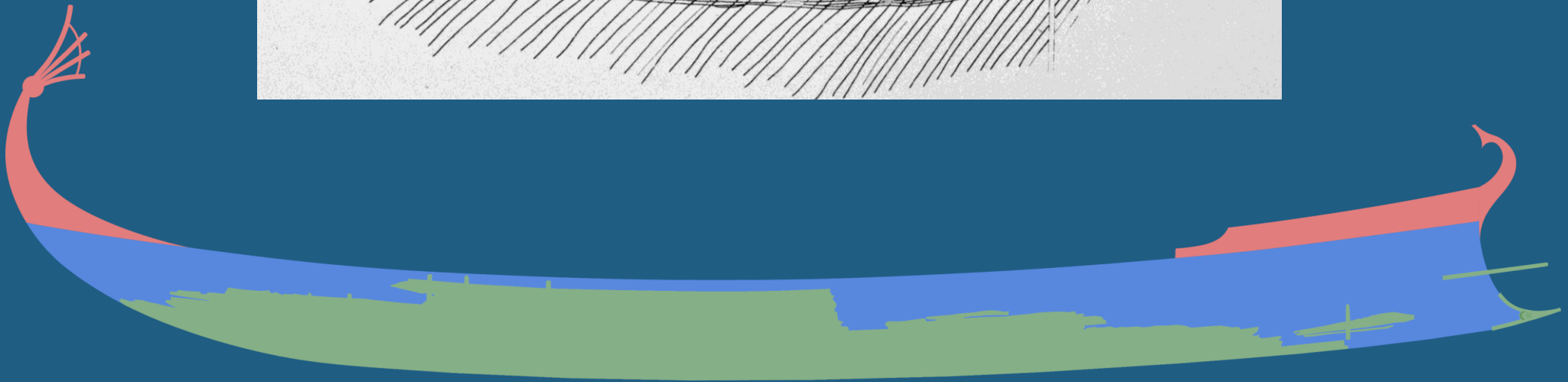
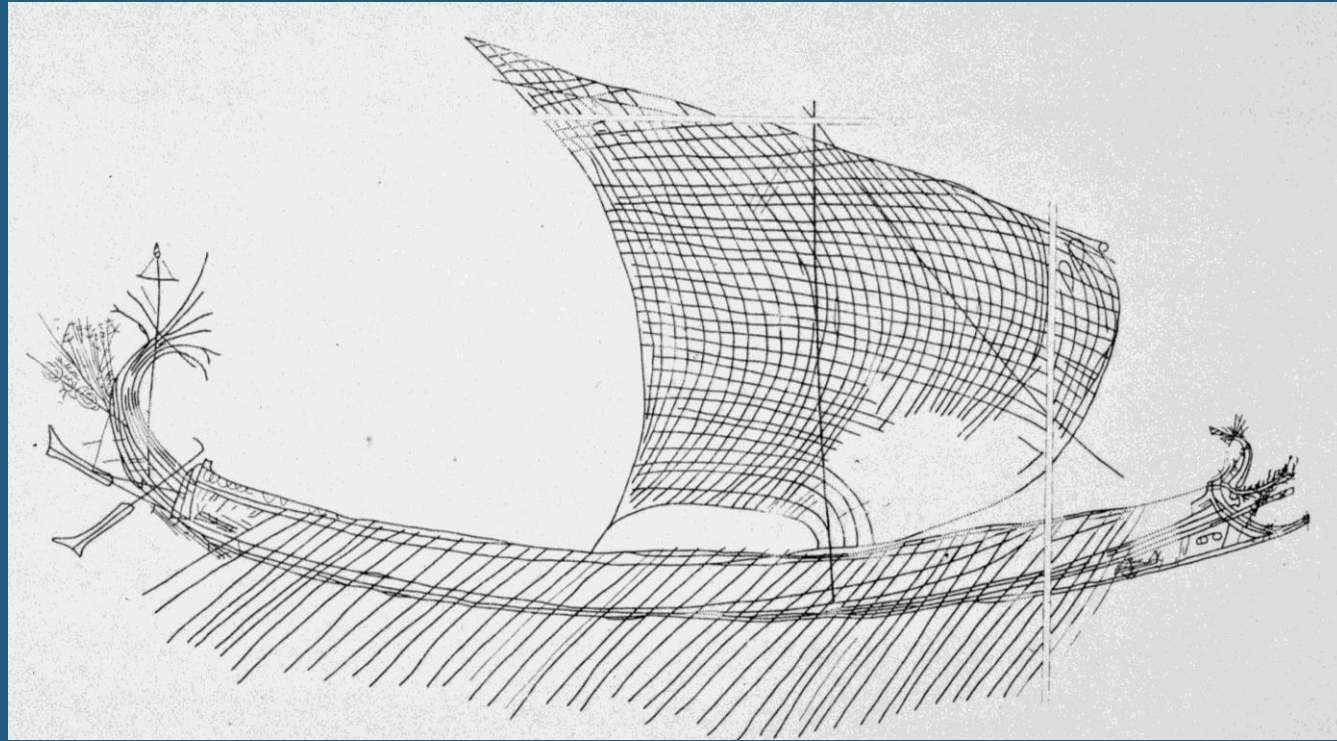



# L'épave de **Phanagoria** : un navire de guerre d'époque hellénistique

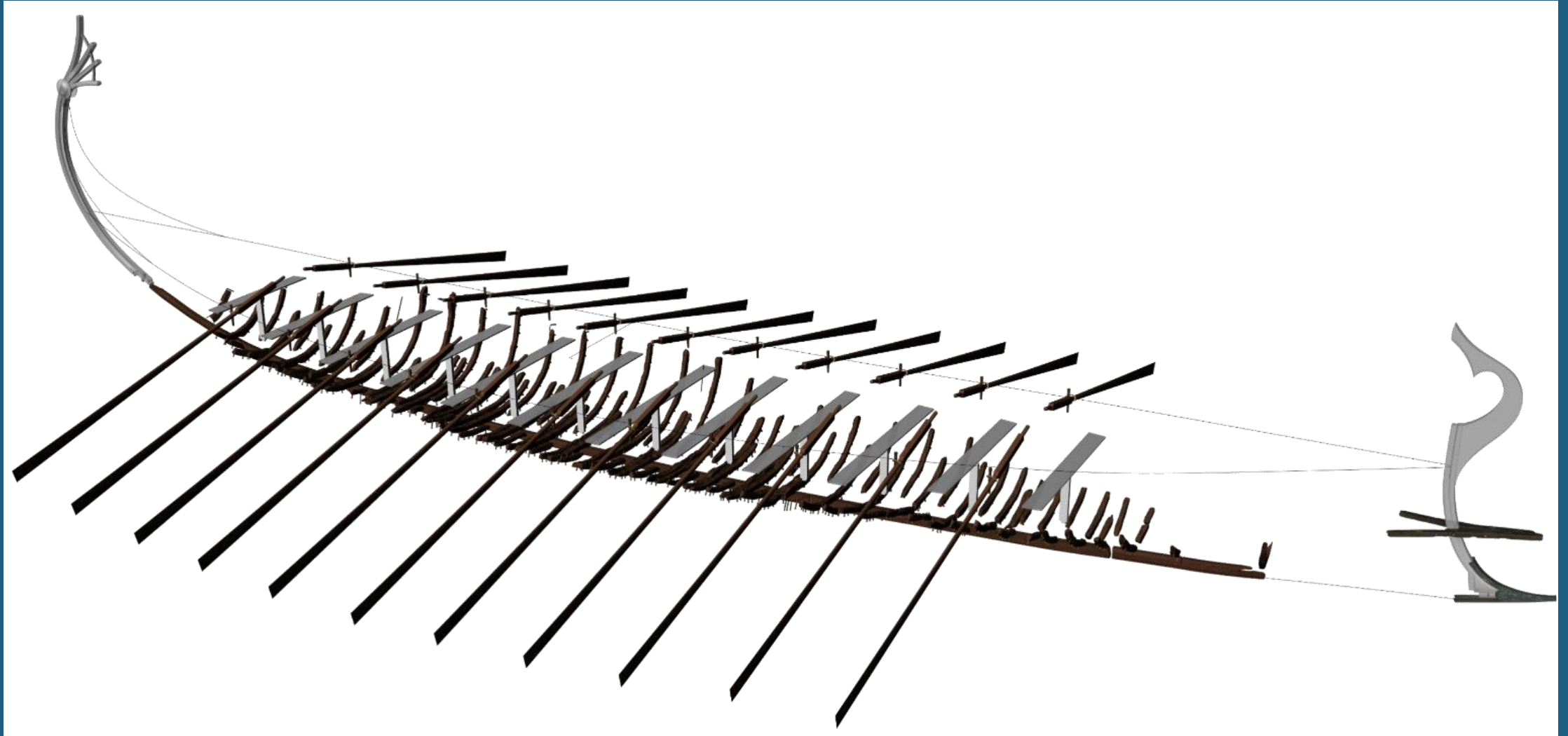

# L'épave de **Phanagoria** : un navire de guerre d'époque hellénistique

Sergey Olkhovskiy  
Pierre Poveda  
Giulia Boetto

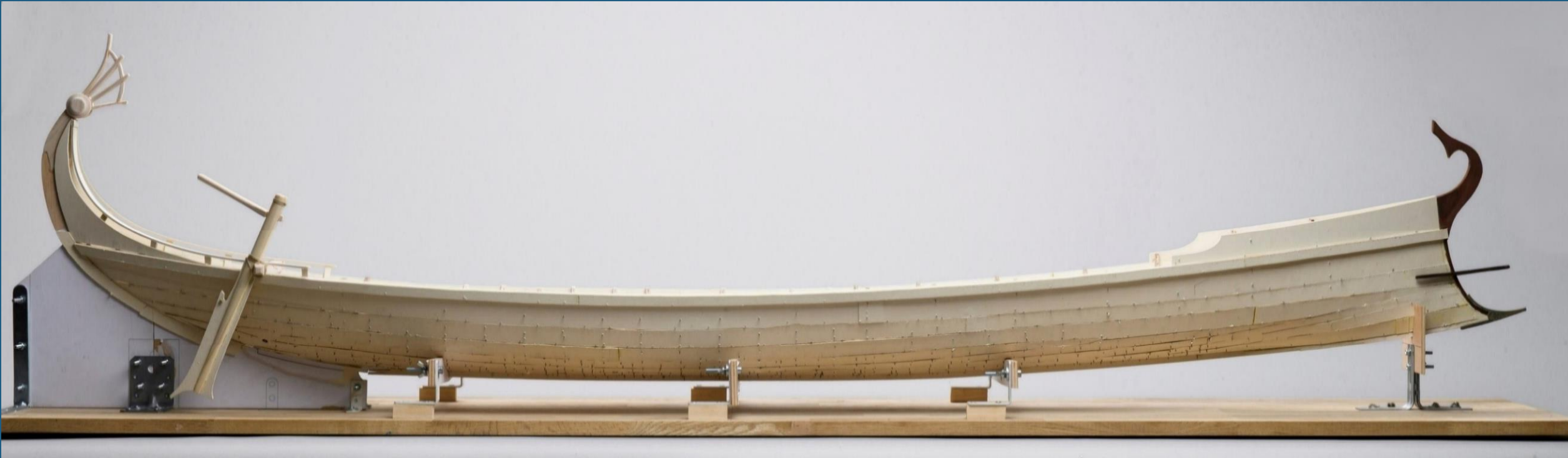





Merci pour votre attention!

A suivre...

