



**HAL**  
open science

## Recent discoveries on the Hellenistic and Parthian occupation of Ulug-depe

Johanna Lhuillier, Julio Bendezu-Sarmiento

► **To cite this version:**

Johanna Lhuillier, Julio Bendezu-Sarmiento. Recent discoveries on the Hellenistic and Parthian occupation of Ulug-depe. *Antiquity of Turkmenistan, Scientific Research and Restauration of Monuments*, pp.198-213, 2022. halshs-03900539

**HAL Id: halshs-03900539**

**<https://shs.hal.science/halshs-03900539>**

Submitted on 15 Dec 2022

**HAL** is a multi-disciplinary open access archive for the deposit and dissemination of scientific research documents, whether they are published or not. The documents may come from teaching and research institutions in France or abroad, or from public or private research centers.

L'archive ouverte pluridisciplinaire **HAL**, est destinée au dépôt et à la diffusion de documents scientifiques de niveau recherche, publiés ou non, émanant des établissements d'enseignement et de recherche français ou étrangers, des laboratoires publics ou privés.



J. Lhuillier, J. Bendezu-Sarmiento

## RECENT DISCOVERIES ON THE HELLENISTIC AND PARTHIAN OCCUPATION OF ULUG-DEPE

### Abstract

This paper seeks to shed new light on the latest discovered occupation period at Ulug-depe: the Hellenistic and Parthian occupation. Ulug-depe displays the longest continuous stratigraphic sequence of southern Central Asia, from the Late Neolithic to the Middle Iron Age. After its abandonment at the end of the Middle Iron Age period, the site was reoccupied during the late 1st millennium BC. Although the archaeological levels relating to this period are badly preserved, extended research led by the joint Turkmen-French Archaeological Expedition (MAFTur) has succeeded in unearthing this occupation in many places of the site and has studied a varied pottery assemblage. Its study suggests Ulug-depe was located strategically in the central part of the Kopetdag during the last centuries of the 1st millennium BCE.

### Introduction

Large-scale excavations were carried out at Ulug-depe since its discovery: first by V.I. Sarianidi between 1967 and 1970 (Sarianidi 1969; 1971; 1972), and since 2001 by the joint French-Turkmen archaeological mission (MAFTur) placed under the direction of M. Mamedov<sup>1</sup> and the late O. Lecomte (CNRS, 2001-2013), and then supervised by J. Bendezu-Sarmiento (CNRS, 2014–). The site occupies a special place in the Proto-history and the History of Central Asia, and in particular of Turkmenistan, since it displays the longest continuous occupation sequence in Central Asia, from the Late Neolithic to the end of the Middle Iron Age (ca. 5000 – 600 BCE)<sup>2</sup>.

Located 175km east of Ashgabat in Turkmenistan, close to the village of Dushak, in an alluvial plain of the eastern foothills of the Kopetdag, Ulug-depe is a site equidistant from the well-known sites of Namazga-depe and Altyn-depe. It yielded impressive results on the Bronze Age, and fieldwork has also exposed the only known proto-urban city of the

<sup>1</sup> National Department for the Protection, Research and Restoration of Historical and Cultural Sites of the Ministry of Culture of Turkmenistan.

<sup>2</sup> For a detailed presentation of the occupation sequence of Ulug-depe, see Lecomte 2007; 2011; 2013; Bendezu-Sarmiento, Mamedov et al. in this volume (see also the location map of Ulug-depe).

pre-Achaemenid Iron Age period (Lecomte 2013; Lhuillier et al. 2015). For several years, the team of the MAFTur thought that the site had been abandoned after the Middle Iron Age and not reoccupied, except for a small occupation at the top of the depe during the Islamic period. But as we became more familiar with the site, we discovered some anomalies: evidence of secondary occupation in the pre-Achaemenid city, a different type of housing, and unusual pottery. A first study of these data led us to conclude that this occupation was quite significant and could be dated to the end of the 1st millennium BCE, and attributed to the Hellenistic period in a broad sense, to both the Hellenistic period proper and that which followed, which saw the development of the Greco-Bactrian and Parthian cultures (Lhuillier & Bendezu-Sarmiento 2018)<sup>3</sup>.

### The Hellenistic settlement

The Hellenistic remains of Ulug-depe are mainly found within the areas of the Middle Iron Age (pre-Achaemenid) settlement, when a city occupied most of the top of the site. The Middle Iron Age city was abandoned around the 7th century BC; the “citadel” and other buildings were emptied, and in some cases closing rituals were performed (Lecomte et al. 2002; Lecomte & Mashkour 2013). After a few centuries, large parts of these buildings were reoccupied<sup>4</sup>. For this reason, the remains of Hellenistic occupation are found in the uppermost, and thus partly eroded, layers of the site, almost at surface level.

The Middle Iron Age “citadel” and the “warehouse” – both displaying thick, lasting walls – were partly reoccupied: in some areas of the two buildings, new mud-brick walls and new stone structures were built during the late 1st millennium BC. This is particularly

<sup>3</sup> The present paper integrates and expands the data published in this previous publication.

<sup>4</sup> As for now, no evidence of an Achaemenid occupation can be identified with certainty, and, we cannot rely on the stratigraphy or the evolution of pottery types to date the late 1st millennium BC remains. Similarly, in the central part of the Kopetdag piedmont, J. Bruno noticed that the identification of the period is made difficult by the lack of multilevel sites (2019a, p. 420). This stands in contrast to Merv and other sites in Bactria, where a thorough examination of the pottery assemblages related to the stratigraphy has shown the persistence of Yaz III types well into the Hellenistic period (see Puschnigg 2008; Callieri 2014).

*«Garwa» keramikasynyň  
görnüşleri: iki sany kiçijik  
jürdek we kiçijik tabak.  
(S. Pýera).*

*“Nomadic” pottery types,  
two small jars and a small  
bowl  
(MAFTur/ S. Piera).*

*Типы «кочевой»  
керамики: два  
кувшинчика и  
маленькая чаша  
(С. Пьера).*

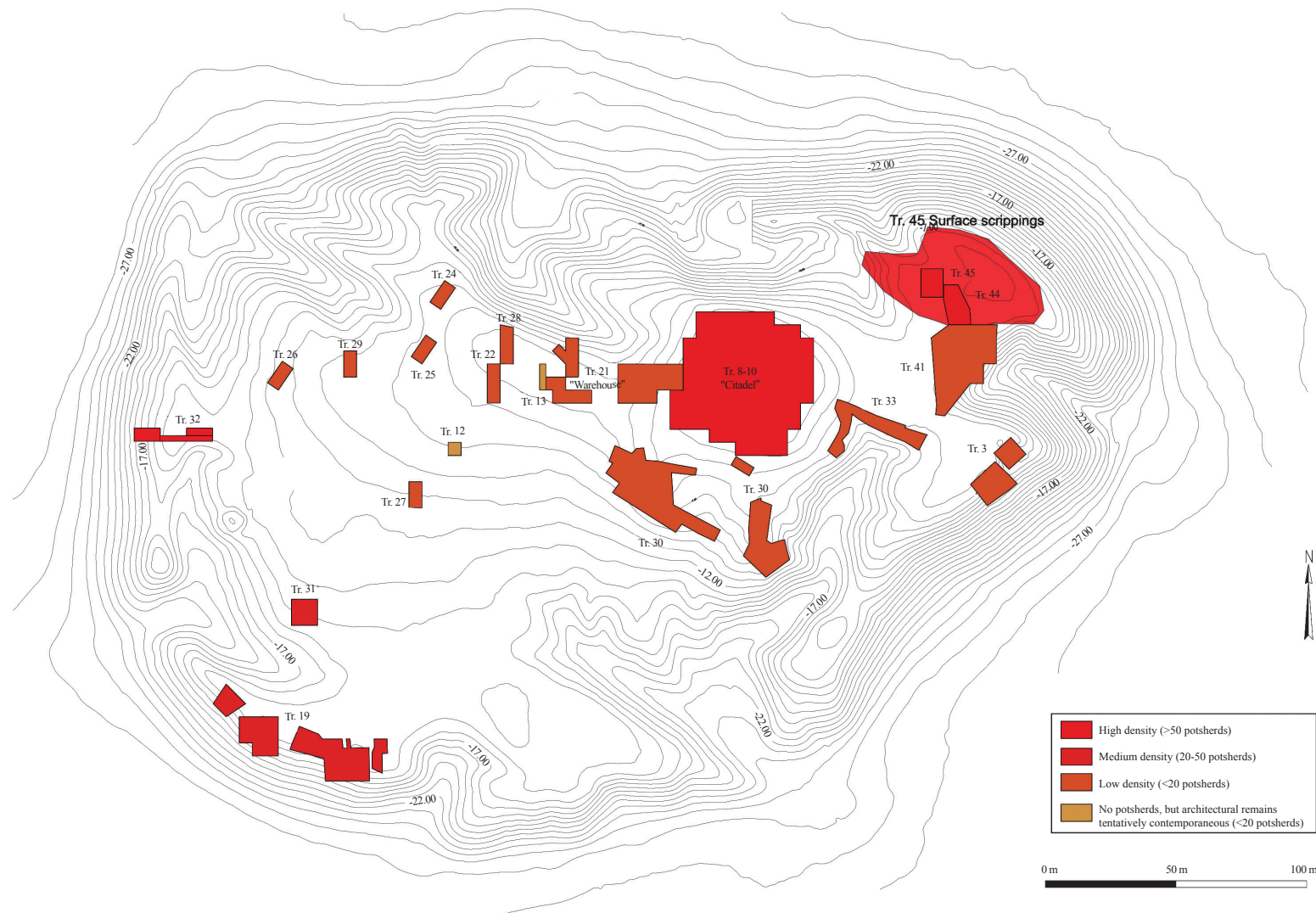

*Ýadygürligiň ellinizm we parfiýa döwürleriniň keramikalarynyň ýaýran çäkleri bellenen topografiýa kartasy (Ž. B. Kawern, J. Lýuilyeniň girizen özgertmeleri bilen).*

*Topographical map of the site with the distribution of Hellenistic-Parthian pottery (MAFTur/J.-B. Caverne, modified by J. Lhuillier).*

*Топографическая карта городища с локализацией эллинистической и парфянской керамики (Ж. Б. Каверн, с изменениями Дж. Люлье)*

noticeable in the south-eastern corner of the external, peripheral corridor of the “citadel”, where large boulders were used, together with fragments of mud bricks, to build small walls to divide the corridor into small rooms.

In the area south of the citadel, some walls were built with mud bricks of a size similar to that used in the citadel (60 x 30 x 10 cm). This fact may indicate that they were reemployed. However, other walls in the same area were built with square mud bricks (32 x 32 x 10 cm), usually taken as a chronological indicator for the Hellenistic period<sup>5</sup>. Some post-holes and large fireplaces built with boulders were discovered between the partially destroyed walls of the earlier warehouse and are related to several short-time, squatter occupations.

The more densely occupied area is located in the north-eastern part of the depe, on a flattened area overlooking the plain. During our last fieldwork season (2019), extensive surface stripping has enabled us to identify important remains associated with the pre-Achaemenid city: the area was apparently occupied by the north-eastern part of the fortification, thus surrounding the entire site with a massive enclosure. In contrast to other structures

of this period, it was heavily affected by erosion, as early as the end of the 1st mill. BCE. The whole area was then reoccupied by semi-subterranean structures, perhaps a few dwellings. Usually dug in the vicinity of the Iron Age walls, they are only a few metres apart one from each other. They are oval with an average size of 4-5 x 5-6m, and some mudbricks of different sizes (rectangular and square shapes) were obviously reemployed in the internal arrangements. Some fireplaces were identified in some instances, within or sometimes outside the semi-subterranean structures, while postholes are at times found on the perimeter.

In the western and south-western parts of the site and below the tepe, the structures did not follow the orientation of the most ancient architectural remains. There, small domestic rooms with fireplaces and storage pits have walls built with rectangular mud bricks<sup>6</sup> and stones preserved only two or three courses high. Sometimes no architectural structures were preserved, and only floors with some grinding tools testify to ancient occupation.

The study of the distribution of the ceramic assemblage can provide additional information on the extension of this Hellenistic settlement. It is striking to observe that ceramic appears everywhere at the site, except for the north slope where the main

<sup>5</sup> For a recent synthesis on the topic, see Mokroborodov 2013. Similar mudbricks are found in the Parthian settlements of the Kaahka region, according to Pilipko (2015, 74).

<sup>6</sup> These bricks have a standard size of 60x30x10cm.

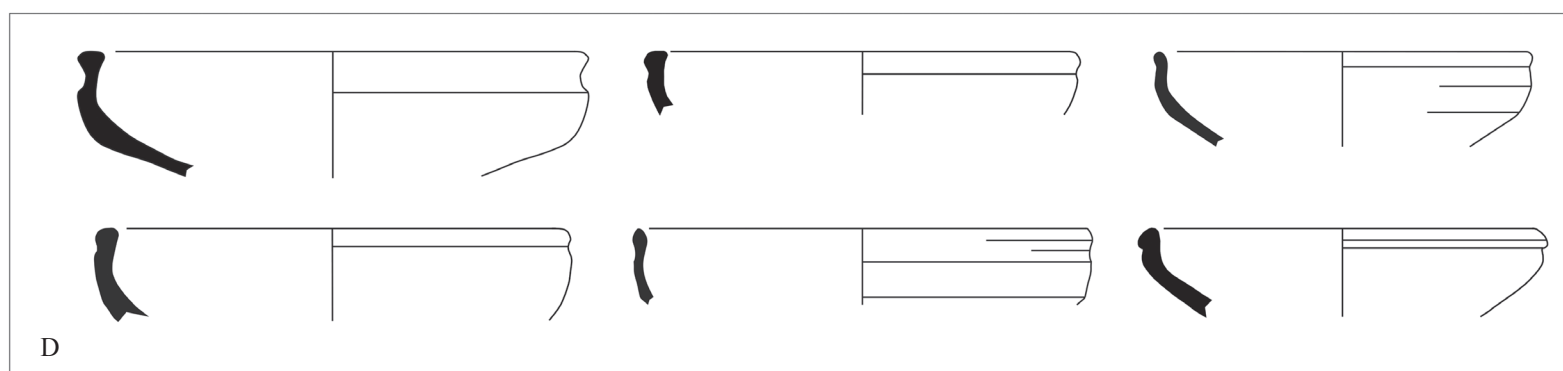
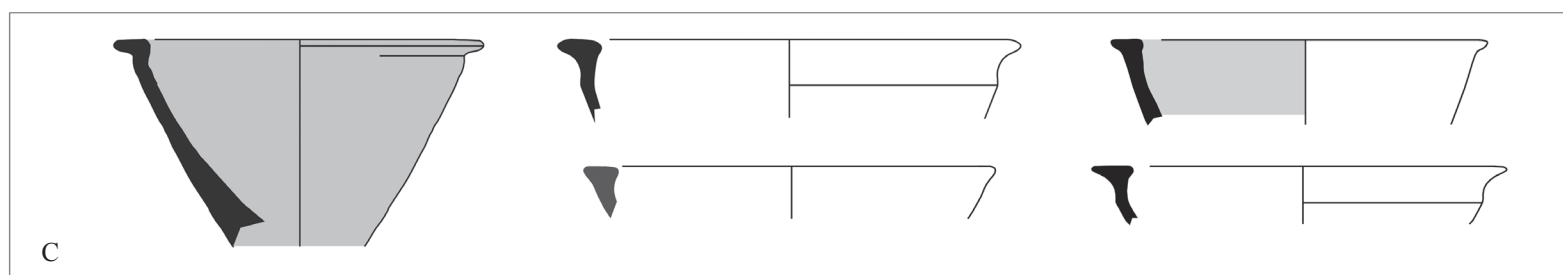
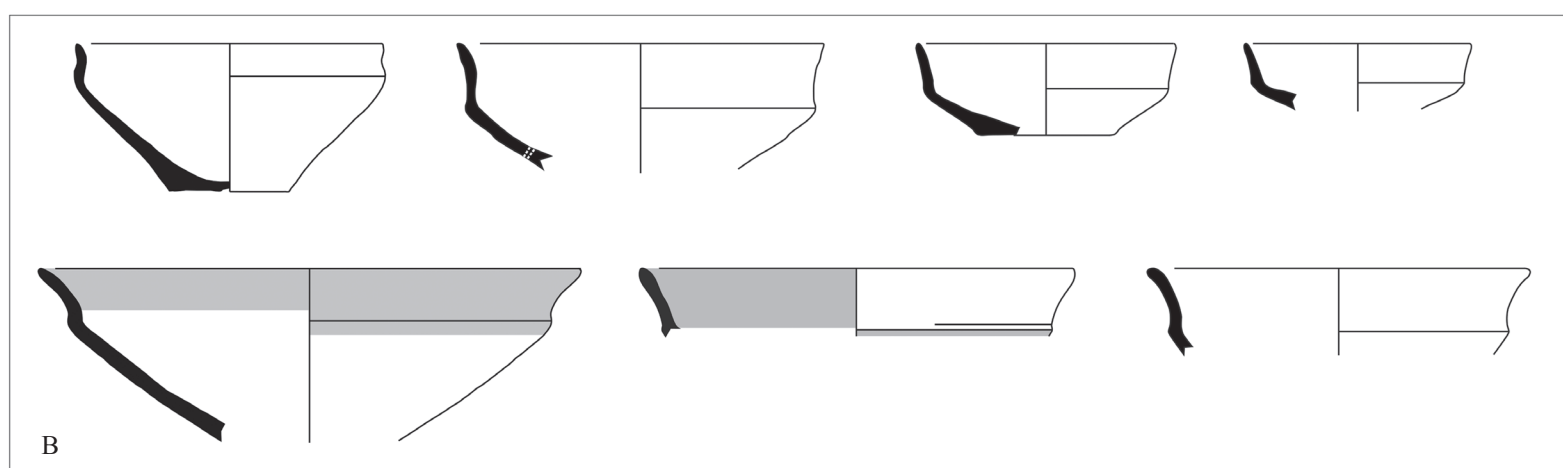
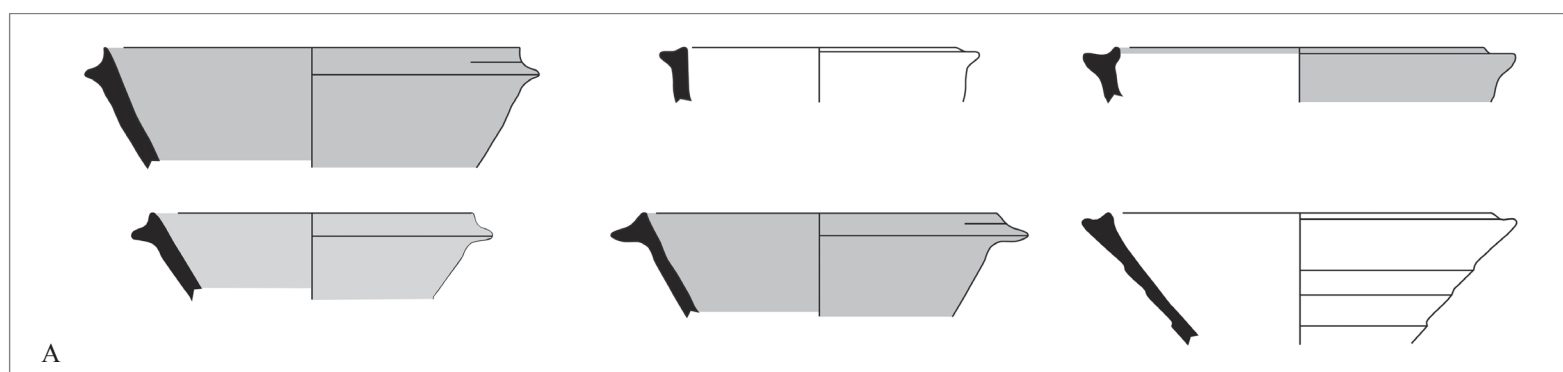

occupation relates to the Bronze Age, suggesting fairly significant occupation of the site. The distribution map of this pottery shows its particular abundance in the “citadel” area, with a low but continuous concentration all around it in the upper town, and in the site’s north-eastern part. Another important concentration is found on the tepe’s western slope, and to a lesser extent, in its southern part. This distribution

fits well with that of the architectural remains, and suggests that the occupation was denser in the central, highest part, and in the areas previously occupied by the Iron Age fortification wall, where its partial preservation favoured opportunistic occupation. The high concentration of late potsherds on the western edge may be explained by the erosion of the top of the site combined with topography, the slope of the tepe favouring the spread potsherds in that area.

*Ahemenilerden  
soňky döwrüň  
«ahemenileşdirilen»  
keramikasynyň görnüşleri.*

*Achaemenized pottery  
types from the post-  
Achaemenid period.*

*Типы  
«ахеменизированной»  
керамики  
постахеменидского  
периода.*

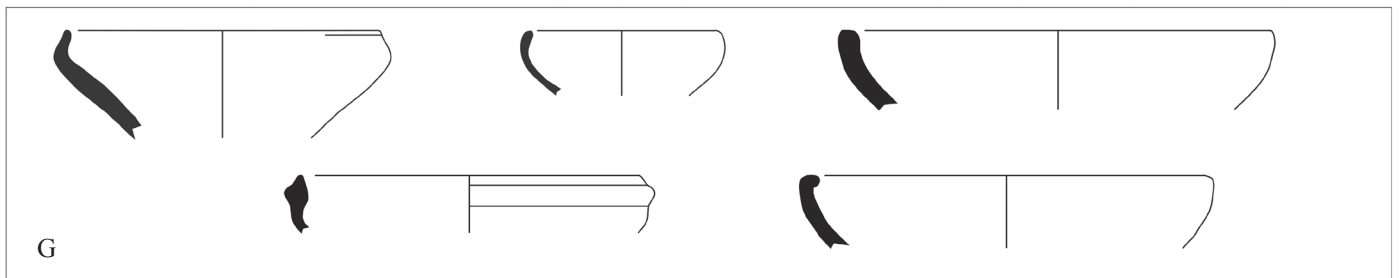
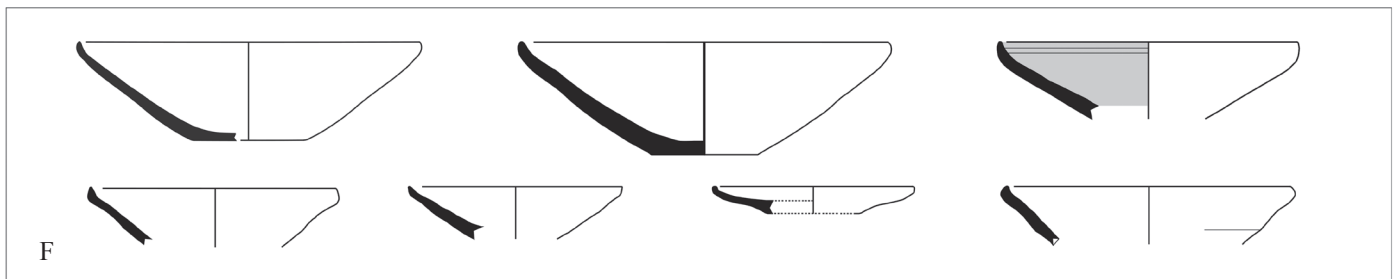
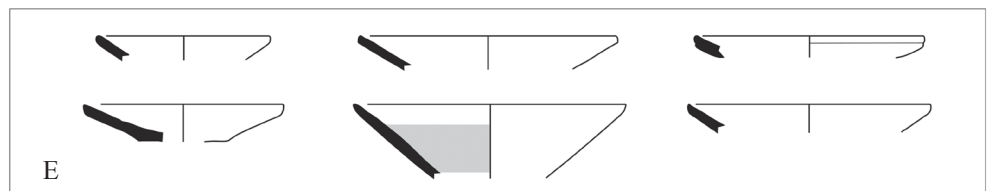
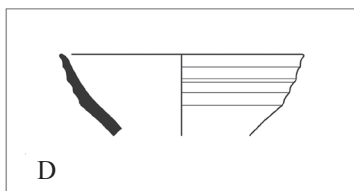
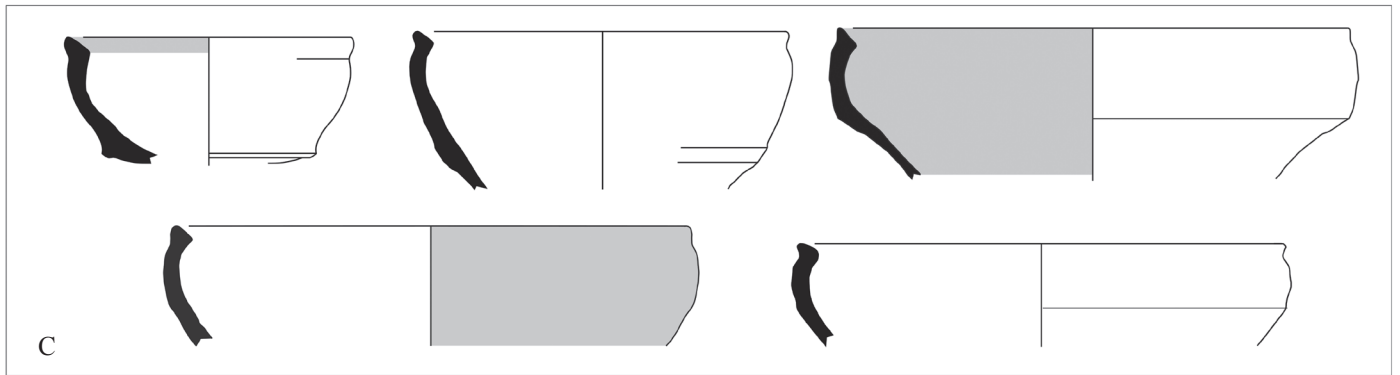
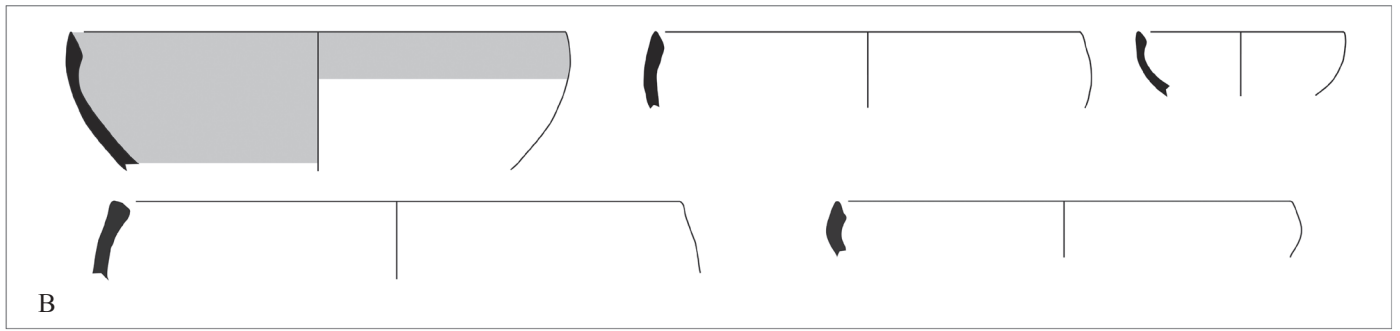
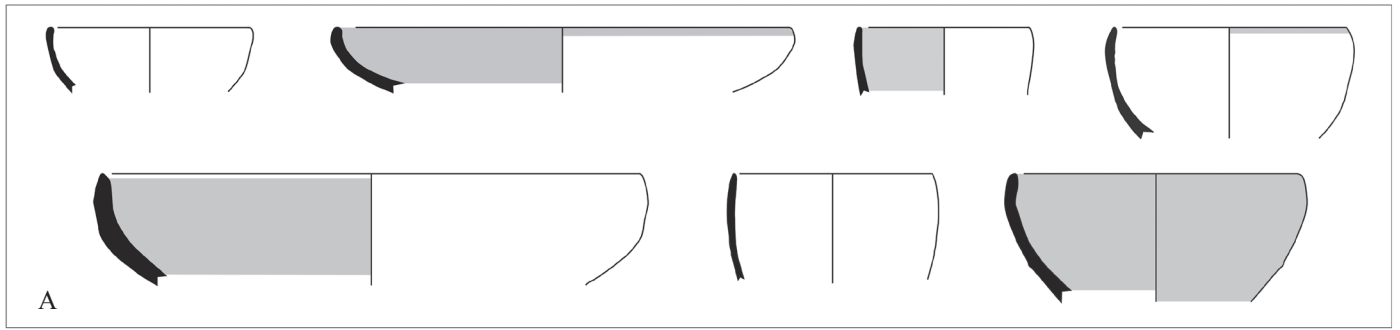

## The pottery

A group of about 400 diagnostic potsherds was selected for the study of the pottery assemblage attributed to the late 1st millennium BC. The assemblage from Ulug-depe includes several groups, including Achaemenized, Hellenistic and Parthian types, and types that might be attributed to mobile tribes.

### Achaemenized types from the post-Achaemenid period

Several forms are reminiscent of Achaemenid types or forms that appeared during the 5th-4th century BCE, but can be attributed to a post-Achaemenid occupation of the 4th-3rd century BCE or later.

Some conical bowls with a concave rim, most of them with a red slip and burnished surface, are among the most striking forms encountered at Ulug-depe. Although this form does not seem to be very widespread in the Kopetdag piedmont, parallels exist in the Etek area of the Dashly Oasis, at Dashly 3. It is also found already during the "Achaemenid" period, among Yaz II-III pottery, at Garry-Kjariz (Pilipko 2015, Fig. 148, 1-2; pl. IV, 1) and at Khyrly-depe in the Akhal region near Geok-Tepe, during the Khyrly II and III periods (Pilipko 2005, Figs. 6.20, 12.11, 12.33, 13.32, 13.35; 2015, Figs. 132.16, 140.11, 140.33, 151.2, 151.5), where it was still used during the Hellenistic period in Khyrly IV levels (Pilipko 2005, Figs. 14.10-11; 2015, Figs. 151.2, 151.5). V.N. Pilipko suggests dating the levels where this form is found between the 5th century BCE and the first half of the 3rd (Pilipko 2005, 78; 2012, 110-111). A comparable form is attested at Old Nisa (sector M), but in a different, grey-black ware (Lippolis et al. 2019, Fig. 7.1). Similar cups with concave rims were identified in the upper Etek Valley and south of the Aladagh mountains, where they are much more widespread and appear as a characteristic type (Pilipko 2005, Fig. 4). Ulug-depe thus displays the easternmost evidence of this form.

Some rare occurrences of carinated bowls with a flaring wall and a concave, S-shaped rim are comparable to the Iranian "tulip bowls", which are considered a typical shape for the Achaemenid period, in ceramics as well as in metal ware. However, in Iran and in Central Asia, they are still attested in post-Achaemenid levels, and some potsherds of this group may also be compared with Hellenistic carinated bowls (for example at Aï Khanoum (Lyonnet 2013, fig. 110) and other sites in Bactria and Margiana). Similar bowls are attested from the 4th-3rd centuries BCE around Kaakhka (for example at Dashly 45:

Pilipko 2014, Fig. 6.17-18), and, according to J. Bruno, during the Parthian period, in the Atrak Valley (Bruno 2019a, p. 426, Figs 2-3).

Bowls or plates with a long, out-turned horizontal rim were considered by A. Cattenat and J.-C. Gardin (Cattenat & Gardin 1977) as a shape widespread in the Iranian plateau that appeared during Achaemenid times and lasted into the Hellenistic period. Both types that they identified - with a hemispherical or a carinated wall - are present at Ulug-depe. More common than the previous one, this type was in use throughout the Hellenistic and Parthian period in the upper Etek Valley and in the Turkmen foothills of the Kopetdag (Pilipko 1980, fig. 3.14; Bruno 2019b, p. 117, fig. 8), and further in Bactria, at Kampyr-tepa, Termez, Kurganzol (Sverchkov 2006; 2008), and Aï Khanoum (Lyonnet 2012).

Large bowls or basins with convex walls and rolled or thickened rim, of which only few potsherds have been found at Ulug-depe, should also be considered among the forms influenced by the types produced in the Iranian Plateau during the Achaemenid and post-Achaemenid periods. Cattenat and Gardin already noticed the diffusion in Central Asia of this type (Cattenat & Gardin 1977, p. 236 type H, fig. 6.g.i.), and Bruno listed further analogies on the Plateau and recognised this form in the upper Atrak Valley (Bruno 2019b, p. 116-117, fig. 7). The form is attested until the 2nd-1st centuries BC in the Turkmen foothills of Kopetdag, for example at Janyk-depe or Kosha-depe (Pilipko 1980, fig. 3.27; 2015, fig. 153.25).

### Hellenistic pottery types

The bulk of the pottery is wheel-made, with a fine, well-levigated clay. The surface can have a homogeneous brownish-beige colour; it can also be greenish beige, with pink spots due to firing, this last group of potsherds being very close to the Middle Iron Age Yaz II pottery. The assemblage includes mostly tableware and storage vessels, which suggests domestic occupation. The original assemblage probably included handmade cooking pots, but the stability of their shapes throughout the 1st millennium BC makes it very difficult to date precisely the potsherds of this ware we collected. It is not relevant to discuss here the period when the Hellenistic types identified at Ulug-depe were introduced from the Mediterranean world, but rather to rely on well-dated neighbouring Turkmen and Central Asian sites to suggest a chronological span for the Hellenistic/Parthian occupation at Ulug-depe.

### Open forms

Open forms are prevalent among the Hellenistic/Parthian types. Slipped sherds are found among all the open types, more rarely on the closed ones: the slip is usually red, sometimes with a vertical burnishing,

*Ahemenilerden soňky döwrüň «ahemenileşdirilen» keramikasynyň görnüşleri. A. Erňegi içine aýlaw epilen tabaklar; B. Göwresiniň diwary epilen çigildem görnüşli tabaklar; C. Erňeginiň üsti tekiz tabaklar; D. Erňeginiň gyrasy gerişjagaz görnüşli ýa-da E, G. galňadylan tabaklar (J. Lüuilýe, S. Moura de Brolyá).*

*Hellenistic pottery types, open forms. A. Hemispherical bowls with simple rim; B. Hemispherical bowls with bevelled rim; C. Hemispherical bowls with outstanding bevelled rims; D. Bowl with a ribbed wall; E. Small plates with straight wall; F. Small plates with a raised rim; G. Small plates with in-turned rim (MAFTur/ J. Lhuillier, S. Moura de Broglia).*

*Типы эллинистической керамики, открытые формы. A. Полусферические чаши с простым венчиком; B. Полусферические чаши со скошенным венчиком; C. Полусферические чаши со скошенным наружу венчиком; D. Чаша с перегибом в профиле стенки; E. Маленькие тарелки с прямой стенкой; F. Маленькие тарелки с приподнятым краем; G. Маленькие тарелки с загнутой краиной (Дж. Люлье, С. Моура де Бралья).*

<sup>7</sup> In a first, preliminary study of this form at Ulug-depe, we erroneously proposed including it among the Hellenistic pottery types (Lhuillier & Bendezu-Sarmiento 2018, 340).

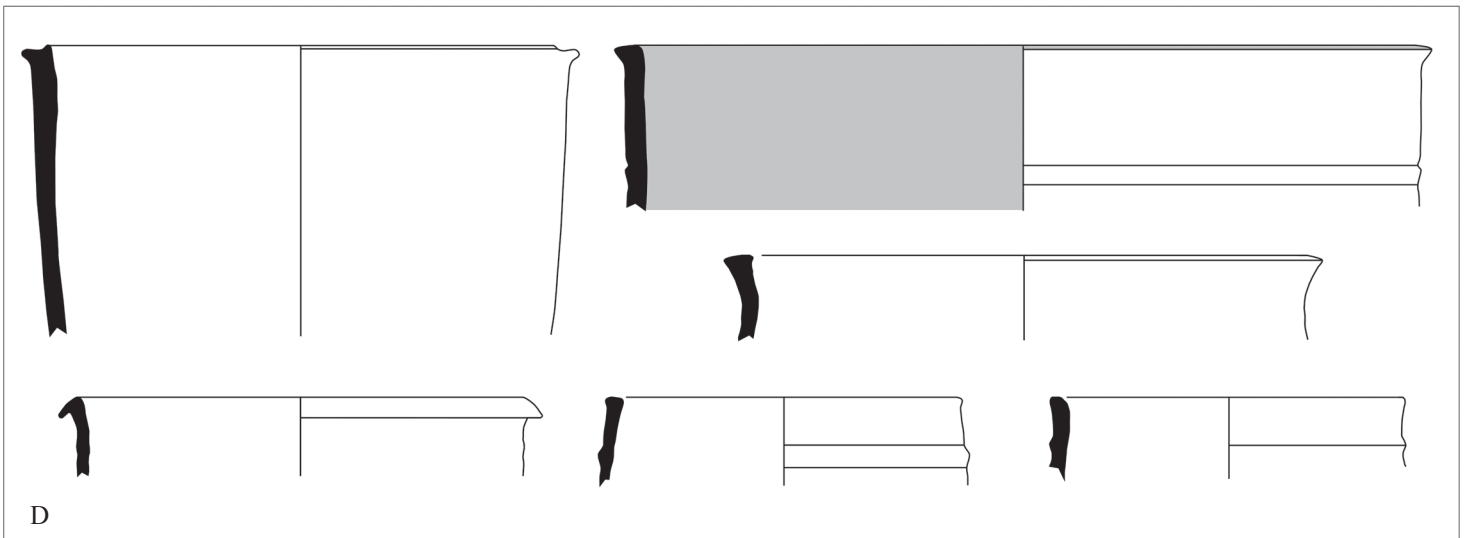
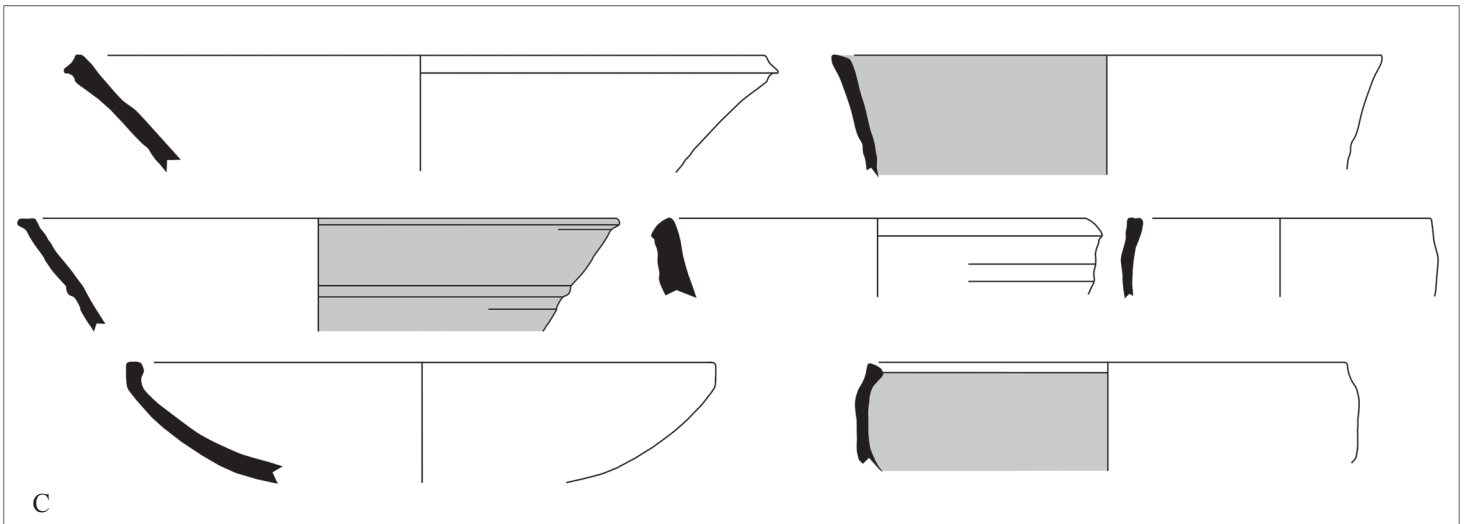
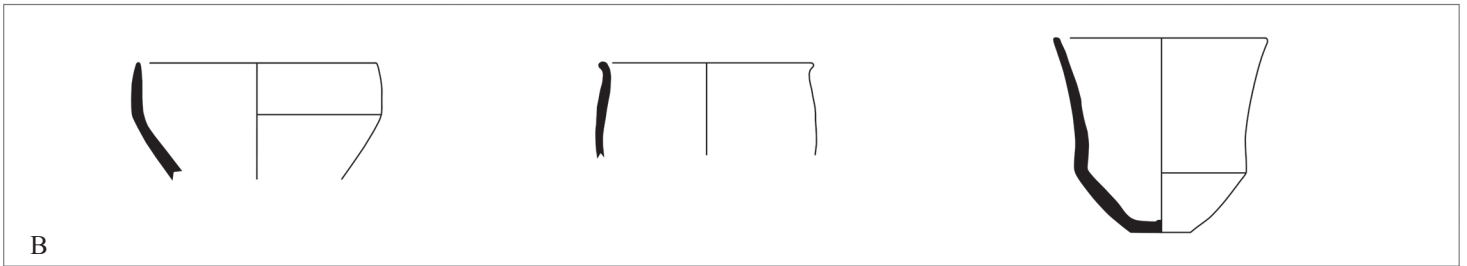
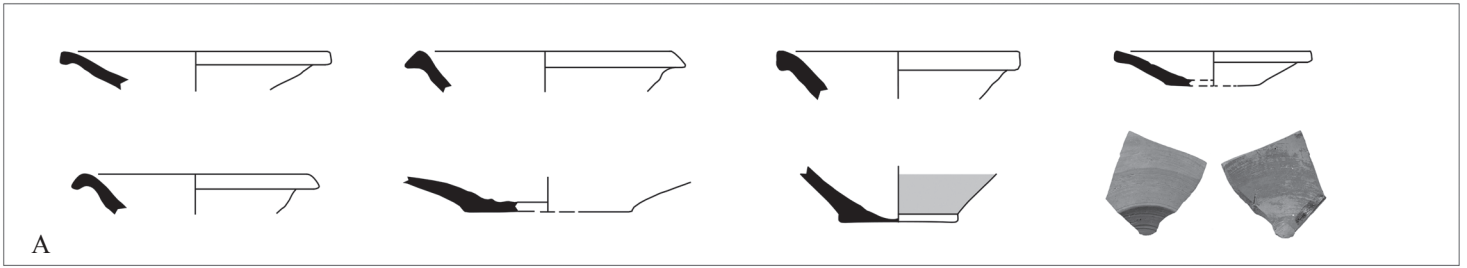



and, occurrence of black slip is extremely scant; but there is no specific type produced with red slip.

The most common shapes are hemispherical bowls displaying several variants, with simple, thinned, thickened, or inturned rim, or more rarely bevelled rim; these bowls are small- to medium-sized. This shape is widespread at Nisa, Merv and other contemporaneous sites of Central Asia during both the Hellenistic and the Parthian periods.

Bowls with convex walls and outstanding or thickened bevelled rims are also frequent. Similar bowls are attested at Nisa during the 3rd-2nd centuries BCE (Pilipko 2001, Fig. 220.4,15,40) and during the 2nd-1st centuries BCE in Dashly-45 (Pilipko 2014, Figs. 2.11, 6.4; Pilipko 2015, Fig. 69.14).

One single bowl with a ribbed wall is similar to an example of Anauskoe poselenije, found in levels dating to the 3rd c. BCE (Pilipko 2015, fig. 152.12).

Small plates with a flat base and straight wall, or with a raised r in-turned rim are known thanks to the find of several complete vessels. Similar plates are found at Dashly-45 dating to the 3rd c. BCE (Pilipko 2014, fig. 2.7), and at Kosha-depe (Pilipko 2015, fig. 85.9).

Fish plates are scarce at Ulug-depe, where they are represented by few triangular or drooping rims, and by two ring bases with a central depression, including one in grey ware. This common Hellenistic type is known at Merv from the end of the 3<sup>rd</sup> c. to the late 2<sup>nd</sup> or early 1<sup>st</sup> c. BCE (Puschnigg 2008, p. 113).

Single occurrences of goblets with deep, slightly convex wall and a flat base relate to a common Hellenistic type (for ex. Aï Khanoum: Lyonnet 2012, fig. 8.12) with analogies at Kosha-depe in the 2nd-1st cc. BCE levels (Pilipko 1980, fig.4.2), Kapyrkala (Pilipko 1980, figs. 5.5, 6.51), and Dashly-45 (Pilipko 2014, fig. 2.22). A variant with a carinated wall, concave at the upper third, is similar to a vase from Kosha-depe (Pilipko 1980, fig.4.3). Scarce evidence of ring bases can be associated with the afore-mentioned types of goblet, plates or bowls.<sup>8</sup>

Large, deep basins show flared walls and flattened rims and have parallels at Kapyrkala during the 4<sup>th</sup>-3<sup>rd</sup> cc. BCE (Pilipko 1990, fig. 2.8; Pilipko & Koshelenko 1985, pl. LXXIX) and Kosha-depe in the 2nd-1st cc. BCE levels (Pilipko 1980, fig. 3.17, fig. 4.1-2, 4-5).

Fragments of other large opens bowls might be related to kraterae, with vertical or slightly convex walls with a long horizontal rim; one single sinuous body sherd (as well as possibly a single foot) could belong to the same type, but the lack of profiles does not allow one to be more precise. As opposed to Nisa, where this shape is found in greyblack ware, fragments from Ulug-depe were produced in common beige ware.

### Closed forms

Closed forms include middle and large size jars with either a banded or thickened rim, or a slightly concave interior rim, or even a beaked rim, and a thick, flat base. Small jars and necked jugs are much less frequent, with or without a handle, and have a thickened or beaked rim. Small jugs sometimes have a handle, and are slipped with a vertical burnishing. The only complete jug shows an ovoid body, a vertical neck with a triangular banded-rim, and an enlarged flat base; the handle has a round section.

Among the jars and jugs, a group of very few potsherds stands out from a technological point of view: the ware has a red colour and is carefully polished. Diagnostic sherds include only one ring base, and a single body sherd of a necked jug or small jar has an applied horizontal band with vertically pendant endings.

Small pots are attested by single complete vessels. A small pot with a flat base, a carinated, almost vertical wall, and an everted rim is similar to pots from Kapyrkala in the 4th-3rd centuries BCE (Pilipko 1990, Figs 2.36, 6.22) and Koshadepe in the 2nd-1st centuries BCE levels (Pilipko 1980, Fig. 3.10). Another pot has a globular profile with a flattened base, an everted rim, and traces of a round-section handle. The shape strongly recalls globular pots of the Early Iron Age Yaz I period, which are widespread at Ulug-depe, but the ware and the manufacturing technique used differ, and the pot is similar to a finding from the Akhal region dated to the 2nd-1st century BCE (Pilipko 2015, Fig. 178.4).

### “Nomadic” pottery types

The last group of ceramics that we include in this assemblage groups some more unusual pottery types, including mainly potsherds with splashes of slip. Considered in a broad geographical frame, the analogies observed for these potsherds point to a potential link with the northern, steppe world (in a broad sense), but also possibly with the Iranian-Afghan territory of Sistan.

Belonging to this group, a homogeneous complex assemblage was discovered in the warehouse's uppermost, reoccupied layers, in an area reorganised with large boulders and post-holes. It includes four complete wheel-made vessels, in a beige-coloured ware: three almost identical small jars with a flat base, an ovoid ribbed body, a short neck, and an everted, thinned rim; and a small bowl with a flat base and a raised thick rim. Two potsherds with splashes of slip have been discovered in the same level. The shape of the small jars is not common and has no

*Açık kysymly ellinistik keramikanyň görnüşleri. A. «Balyk okarasy»; B. Kuboklar; C. Uly tabaklar; D. Krater kysymly uly gaplar; E. Krater kysymly gabyň bölekleri bolmagy mümkin (J. Lýuilýe, S. Moura de Brolyá).*

*Hellenistic pottery types, open forms. A. «Fish plates»; B. Goblets; C. Basins; D. Large vessels of the kraterae type; E. Possible fragments of kraterae (MAFTur/J. Lhuillier, S. Moura de Broglia).*

*Типы эллинистической керамики, открытые формы. А. «Рыбные блюда»; В. Кубки; С. Крупные миски; D. Крупные сосуды типа кратера; E. Возможно, фрагменты сосудов-кратеров (Дж. Люлье, С. Моура де Бролья).*

<sup>8</sup> For a picture, see for example Boucharlat et al. 2005, bottom of fig. 18.

*Çuň tabak ýa-da kubok  
(A. Pelle).*

*A deep bowl or goblet  
(MAFTur/ A. Pelle).*

*Глубокая чаша или  
кубок  
(А. Пелле).*



*Ýapyk kysymly ellinistik  
keramikanyň görnüşleri.  
A. Orta ýa-da uly ölçegli  
banka şekilli gaplar;  
B. Kiçijik jürdekler we  
boýunly jürdek;  
C. Kiçijik golçalar we  
gyzyl toýundan ýasalan  
gap; D. Boýunly jürdek;  
E. Kiçijik golçalar  
(J. Lhuillier, S. Moura de  
Broglia).*

*Hellenistic pottery types,  
closed forms. A. Medium  
or large-sized jars; B.  
Small jars and necked  
jugs; C. Small jugs with a  
red ware; D. Necked jug;  
E. Small pots (MAFTur/  
J. Lhuillier, S. Moura de  
Broglia).*

*Типы эллинистической  
керамики, закрытые  
формы. А. Банки  
среднего или большого  
размера; В. Маленькие  
кувшины и кувшин с  
шейкой;  
С. Маленькие горшки и  
красноглиняная посуда;  
D. Кувшин с горлышком;  
E. Маленькие горшки  
(Дж. Люлье, С. Моура де  
Бролья).*

direct analogies, but may be compared to pottery from Chorasmia as well as from Sistan. Vessels comparable both in shape and technological patterns are found in Chorasmia (Vorob'eva 1973, fig. 4; Tolstov & Vajnberg 1967, fig. 45a), and in burials of the nomadic populations of the Aral Sea dated to the last quarter of the 1st millennium BC (Yagodin 1990, figs. 6 and 11). R. Ghirshman and G. Dales found similar small jars in Nad-i Ali in Afghanistan (Ghirshman 1942, NA 70, pl. IV; Dales 1977, pl. 15.7, 8, pls. 32-37). Dales has compared this shape to pottery from Dahan-i Ghulaman in Iran (see Scerrato 1966, figs. 56-57, left of fig. 59), and established a parallel in the incised sign found on some of these vessels with examples from Nad-i Ali and Dahan-i Gulaman.<sup>9</sup>

In other areas of the site of Ulug-depe, wheel-made potsherds with splashes of slip or paint were

found in the same archaeological contexts, together with the aforementioned Hellenistic ceramics. These potsherds are exclusively body sherds, and their cultural and chronological attribution is hence extremely difficult. As a working hypothesis, we relate them to the ceramic production attributed to the “Kangju” cultural area – understood as the area of the Syr-Darya delta – mainly the Jety Asar culture (Levina 1996), and to the Kaunchi culture in Chach (Tashkent area), both dating in their initial stage to the late 1st millennium BC, when splashes of slip are widespread (Burjakov & Koshelenko 1985).

However, one of those potsherds displays, in its fabric and its painted motif, some analogies with Sistani post-Achaemenid pottery from Nad-i Ali (Dales 1977, pl. 24) and Qal'a-ye Sam (Maresca 2016). This type of pottery, which is called “Dipinta Storica Sistana”<sup>10</sup> by G. Maresca (2016, 203-204), is

<sup>9</sup> U. Scerrato (1966, fig. 58, p.27) dated the site to the Achaemenid period, and said that this incised motif is “infrequent and consists in a few straight, or wavy lines; a recurrent motif, however, is a particular sign formed of a sort of trident, down-turned and surmounted by a circlet.”

<sup>10</sup> “This ceramic class is characterised by a peculiar painted decoration in red, wine-red, ochre, brown and dark brown, sometimes limited to the rim but more often covering also the shoulder or the upper portion of the vessel. Almost always monochromatic, the decoration consists mostly of geometric patterns

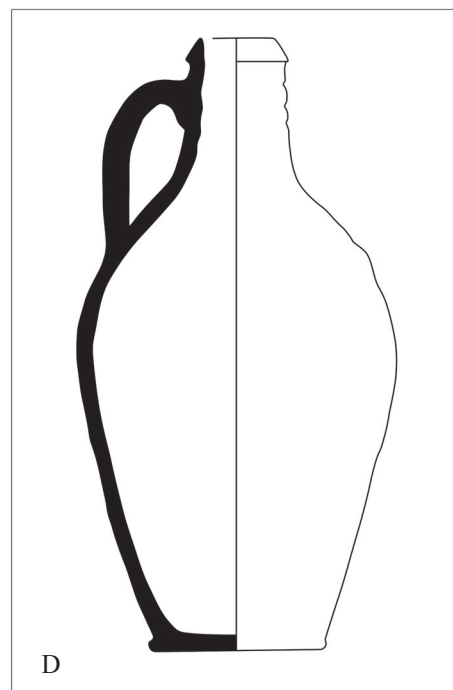
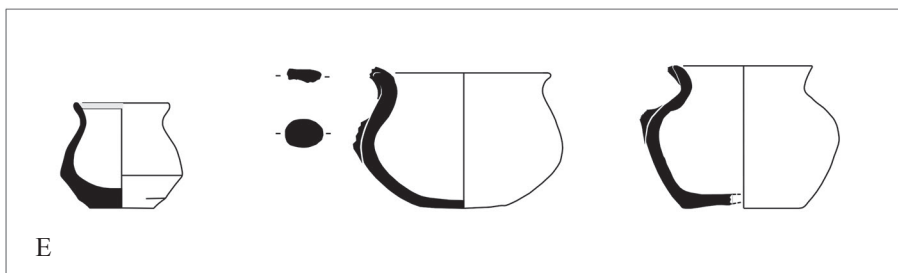
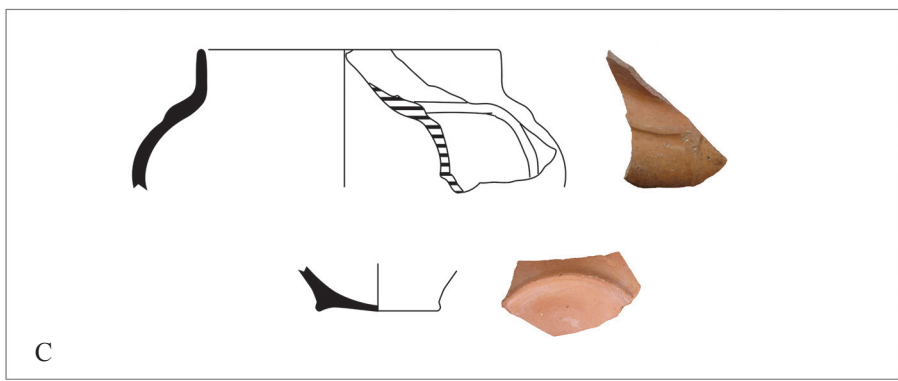
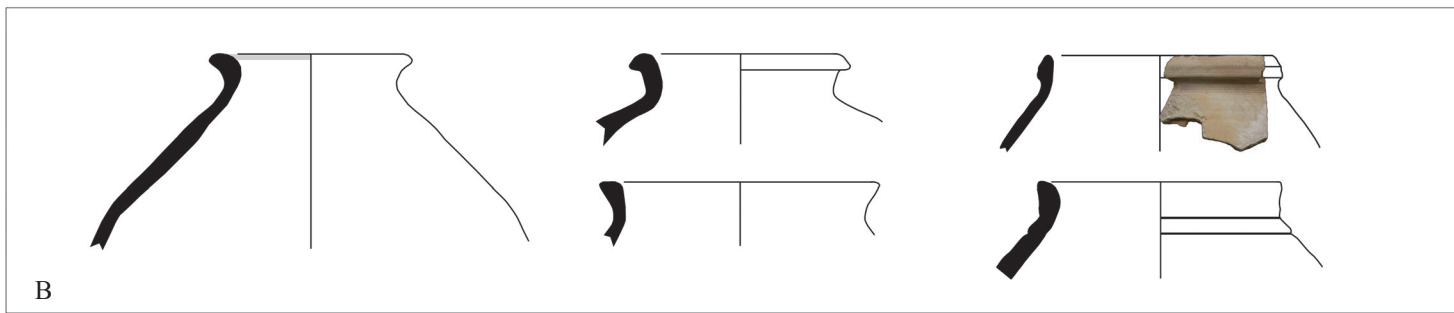
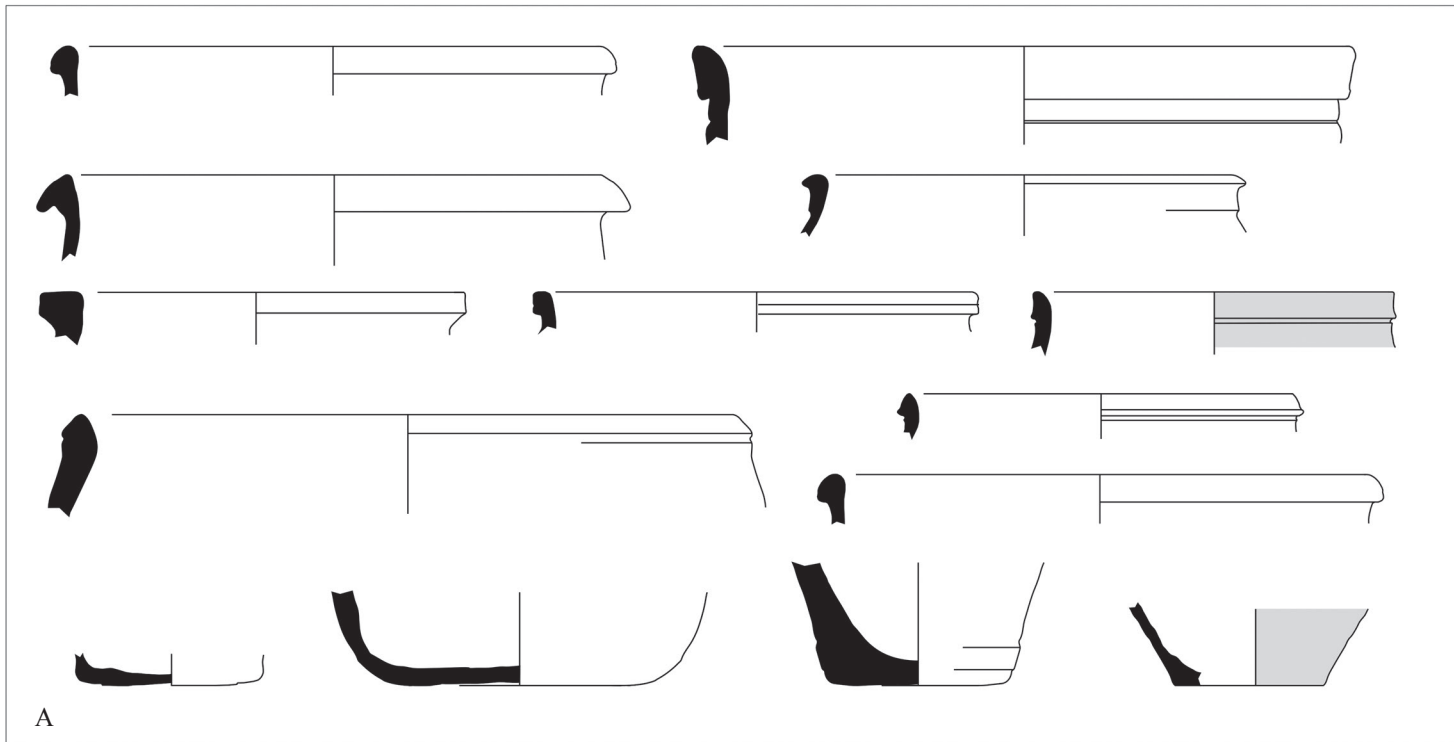

*Daşy angoblanan we dikligine ýylmanan kiçijik goňçalar (P. Hamuda).*

*Small jugs with a red slip and vertical burnishing (MAFTur/ P. Hamouda).*

*Маленькие горшки с ангобом и вертикальным лощением (П. Хамуда).*



associated with some types also found at Ulug-depe, including types inherited from the Achaemenid period (tulip bowls, carinated bowls with horizontal rim) and types introduced during the Hellenistic period (fish plates, bowls with incurved rims, burnished pottery).

### Discussion

It is still difficult to date the assemblage of Ulug-depe precisely, since we have no possibility to link it to the stratigraphy of previous occupations, and we lack chronological elements like coins or inscriptions. However, the pottery evidence suggests a long occupation at the site (continuous or not) throughout the Hellenistic and Parthian periods.

The existence of Achaemenized shapes might at first glance suggest an occupation of the uppermost levels of Ulug-depe around the period of the Greek conquest. But most of these types spread into Central Asia during the 4th-3rd centuries BCE only, and should better be considered as indicative of interactions with the area of the Iranian Plateau and the upper Etek valley during the post-Achaemenid period. Some forms appear as a cultural trait shared with the piedmont of the Kopetdag (the best example being the conical bowls with concave rim attested in the upper Etek Valley), in the Akhal and the Etek regions, and widespread at Ulug-depe. It allows one to elaborate on the observation made by Bruno (2019b p. 116-117) as regards the “upper Atrek valley,

(multiple superimposed upside-down 'V', rectangles divided in four portions by diagonal lines, cross-shaped motifs, single or multiple rows of traits or dots, sometimes set within metope frames) but also, quite rarely, of stylized phytomorphic motifs (sheaves of wheat or hydrophytes)”.

as well as the inner valleys of the central part of the Kopetdag, [that] was inside the zone of co-occurrence of influences between Iran and Central Asia”, by extending this zone of co-occurrence eastward to Ulug-depe.

Most of the ceramics found in the uppermost levels of Ulug-depe can be clearly related to the Hellenistic types widespread in Central Asia, although some of the shapes commonly found in most of Central Asian Hellenistic sites are not featured: for example, flasks are lacking, while grey-black ware remains extremely scarce. This is most likely due to the relatively moderate Hellenistic influence compared to that in the Merv region. Similarly, Hellenistic Central Asian settlements are usually built with square mudbricks, thus contrasting with the architecture of the previous periods (Mokroborodov 2013), and also with that of the Parthian period (Pilipko 2015). At Ulug-depe, some walls indeed display square mudbricks, but most of the architectural remains related to this last occupation stage are made of rectangular mudbricks (60 x 30 x 10 cm) due to the reoccupation of earlier, Yaz II structures, and probably to the secondary use of these bricks. Coexistence of mudbricks of different sizes, both rectangular and square, is known at Hellenistic sites, such as Kapyr-kala (Pilipko 2015, 74), and Parthian ones, for example at Garry-Kjariz (Pilipko 1975, 47-48).

Analogies of pottery forms with those from sites of the Akhal and Etek regions of Turkmenistan, and especially with those excavated by Pilipko in Kaahka area – Koshadepe, Dashly-45 and Kapyr-kala –, suggest that occupation of Ulug-depe lasted well into the Parthian period. As at Old Nisa, at Ulug-depe the Hellenistic influence on pottery types seems to have increased during the 2nd and 1st centuries

BCE, and testifies to a widespread use of red slip and burnishing, and small or medium-sized open shapes for individual use (Bruno forthc. 2020).

During the same period at the very end of the 1st millennium BCE, evidence from Ulug-depe testifies to the presence of another cultural group, probably nomadic, noticed in the findings of ceramics with splashes of slip. The opportunistic occupation of Ulug-depe may be related to the movements of nomadic peoples, either linked to the Dahae who occupied territories on the western part of the Kopetdag, or to other groups linked to the Yuezhi coming from northern territories toward Bactria and neighbouring regions (including Parthia and Sistan), at the end of the 1st millennium BC.<sup>11</sup> Some of these groups occupied the piedmont of the Kopet Dagh, apparent in the dozens of kurgans recorded<sup>12</sup> and as described in textual sources (Strabo XI.8.2; Justin, Prologus, XLI). We also identified a few nomadic necropolises during our surveys south of Ulug-depe in the Kopetdag foothills, the chronology of which cannot be precisely determined without excavation.

<sup>11</sup> For a synthesis on the subject, see for instance Zadneprovskij 1994.

<sup>12</sup> Mandel'shtam 1971; Marushchenko 1959; Olbrycht 2015.

In conclusion, we may infer that Ulug-depe saw sporadic occupation by some populations who settled into the then partially preserved areas of the abandoned site. The heterogeneous aspect of the pottery assemblage described in this article may also reflect occupation during a prolonged period of time covering the Hellenistic and Parthian periods, between the late 4th century BC and the turn of the 1st millennium AD, when different populations mingled in this area of the Kopet Dagh foothills.

### Acknowledgments

We want to take this opportunity to express our deepest gratitude to Mokhamed Mamedow for long years of fruitful collaboration. We express our warmest thanks to the late Olivier Lecomte, Rémy Bouchardat, and Akhmed Khalmyradov, who made the work at Ulug-depe possible. We are grateful to all the members of the team who contributed to the excavation of the Hellenistic and Parthian levels or to the spotting of unusual pottery. We are extremely grateful to Bertille Lyonnet for the comments she made on our first study of this pottery, and to Jacopo Bruno for his useful and relevant bibliographic advice. Funding for the excavation was provided by the French *Ministère de l'Europe et des Affaires Etrangères*, and Bouygues Turkmén.

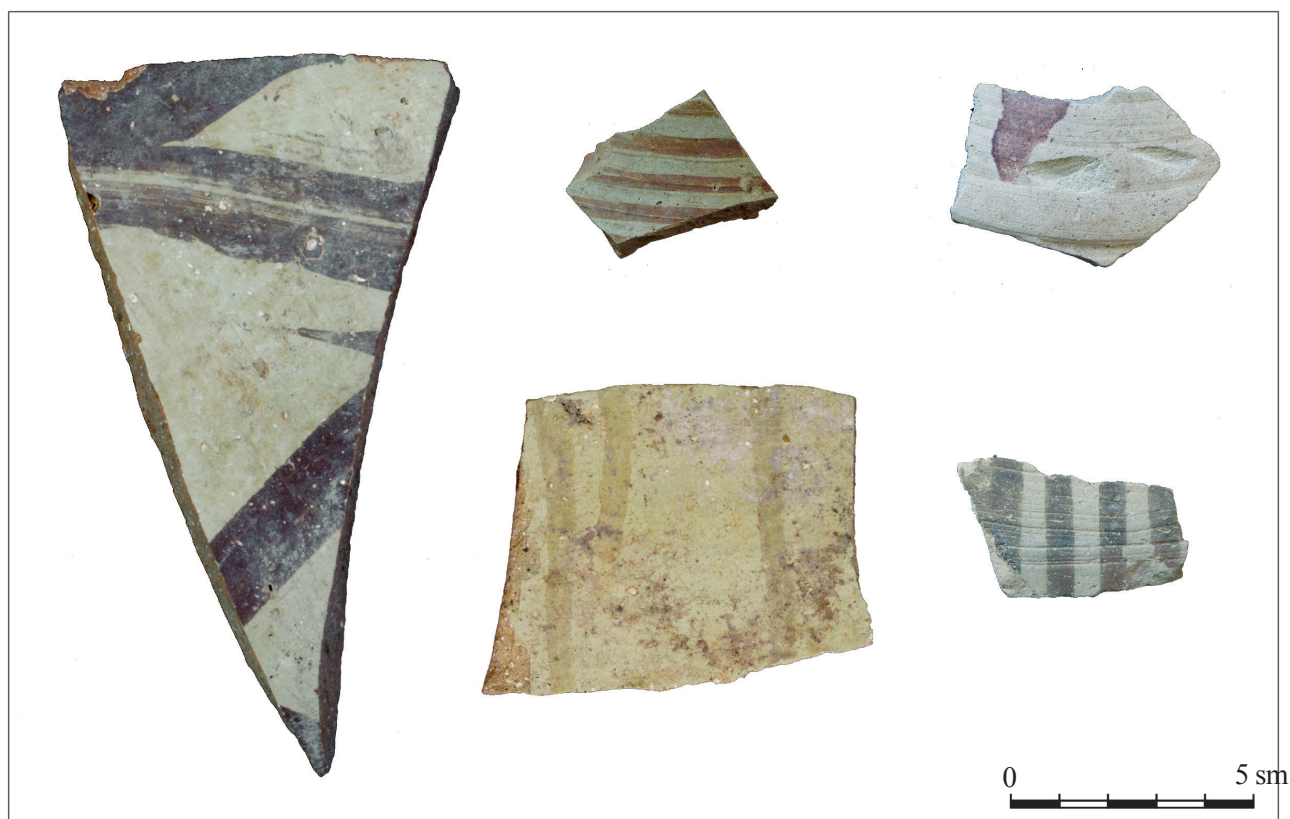

«Garwa» keramikasynyň görnüşleri: ýüzünde reňkiň yzlary galan küýze döwürleri (J. Ljuiilye, A. Didiye).

“Nomadic” pottery types, potsherds with splashes of slip or paint (MAFTur/J. Lhuillier, A. Didier).

Типы «кочевой» керамики: глиняные черепки со следами краски (Дж. Люлье, А. Дидье).

EDEBIÝAT  
BIBLIOGRAPHY  
ЛИТЕРАТУРА

- Boucharlat, R., Francfort, H.-P., and Lecomte, O. 2005. The Citadel of Ulug-Depe and the Iron Age Archaeological Sequence in Southern Central Asia. *Iranica Antiqua* 40, 479–514.
- Bruno, J. 2019a. Ceramics of the Parthian Homeland: new and old data on the ceramic production of the early Arsacid period in Turkmenistan and north-eastern Iran. In: A. Peignard-Giros (ed.) *Daily Life in a Cosmopolitan World, Pottery and Culture during the Hellenistic Period*, Proceedings of the 2nd Conference of IARPotHP, Lyon, November 2015, 5th – 8th, Vienna, Phoibos Verlag, 419–430.
- Bruno, J. 2019b. Between the Iranian Plateau and Central Asia: The Ceramic Complex of the Upper Atrek Valley during the Achaemenid Period. In: B. Genito, G. Maresca (eds.) *Ceramics and the Archaeological Achaemenid Horizon. Near East, Iran and Central Asia*, Napoli, 109–122.
- Bruno, J. forthcoming 2020. Parthia. In R. Mairs (ed.) *The Graeco-Bactrian and Indo-Greek Worlds*, Routledge Worlds, 56–77.
- Burjakov, Ju. F., and Koshelenko, G. A. 1985. Tashkenskij oasis (Chach). In: G.A. Koshelenko (ed.) *Drevnejshie gosudarstva Kavkaza i Srednej Azii*, Moscow, Nauka, 297–303.
- Callieri, P. 2014. Margiana in the Hellenistic Period: Again on Problems of Archaeological Interpretation. In: C.C. Lamberg-Karlovsky, B. Genito, and B. Cerasetti (eds.), *My Life is like the Summer Rose. Maurizio Tosi e l'Archeologia come modo di vivere. Papers in Honour of Maurizio Tosi for his 70th Birthday*, BAR International Series 2690, Oxford: Archaeopress, 59–62.
- Cattenat, A., Gardin, J.-Cl. 1977. Diffusion comparée de quelques genres de poterie caractéristiques de l'époque achéménide sur le plateau iranien et en Asie centrale. In: J. Deshayes (ed.), *Le plateau iranien et l'Asie centrale des origines à la conquête islamique. Leurs relations à la lumière des documents archéologiques (Colloques Internationaux du CNRS n° 567)*, Paris, Editions du CNRS, 225–248.
- Dales, G.F. 1977. *New Excavations at Nad-i Ali (Sorkh Dagh), Afghanistan*, Research Monograph n° 16 Series. Berkeley, Center for South and Southeast Asia Studies.
- Ghirshman, R. 1942. Fouilles de Nad-i Ali dans le Séistan Afghan. *Revue des Arts Asiatiques* 13 (1), 10–22.
- Lecomte O. 2007. Entre Iran et Touran, recherches archéologiques au Turkménistan méridional (2001–2006). *Comptes Rendus de l'Académie des Inscriptions et Belles-Lettres* 151 (1), 195–226.
- Lecomte O. 2011. Ulug depe, 4000 years of evolution between plain and desert. In: M. A. Mamedov (ed.), *Historical and Cultural sites of Turkmenistan. Discoveries, Researches and restoration for 20 years of independence*, Ashgabat, Türkmen döwlet nesiriyat gullugy, 221–237.
- Lecomte O. 2013. Activités archéologiques françaises au Turkménistan. In: J. Benezu-Sarmiento (ed.), *L'archéologie Française en Asie centrale. Nouvelles recherches et enjeux socioculturels*, (Cahiers d'Asie centrale, 21–22), Paris, De Boccard, 165–190.
- Lecomte, O., Francfort, H.-P., Boucharlat, R., Mamedov, M. 2002. Recherches archéologiques récentes à Ulug Dépe (Turkménistan). *Paléorient* 28 (2), 123–132.
- Lecomte, O., Mashkour, M. 2013. La cigogne la chèvre et les renards. In: A. Peruzzetto, F.D. Metzger, L. Driven (eds.), *Animals, Gods and Men from East to West. Papers in Honour of Roberta Venco Ricciardi*, (BAR International Series 2516), Oxford: Archaeopress, 27–32.
- Levina, L.M. 1996. *Étnokul'turnaya istoriya vostochnogo priaral'ya, I tys. do n.e. – I tys. n.e.* Moscow, Vostochnaya Literatura.
- Lhuillier, J., Benezu-Sarmiento, J., and Lecomte, O. (2015). Ulug-depe and an Overview of the Iron Age in Turkmenistan. *Journal of Iranian Archaeology* 4, pp. 78–89.
- Lhuillier, J., Benezu-Sarmiento, J. 2018. Central Asia and the interaction between the Iranian Plateau and the Steppes in Late First Millennium BC: case study from Ulug-depe in Turkmenistan, in Minardi, M., A. Ivanchik (eds.), *Ancient Chorasmia, Central Asia and the Steppes. Cultural relations and exchanges from the Achaemenids to the Arabs. Proceedings of the International Conference Held in Bordeaux, France, 17-18 October 2016, Ancient Civilizations from Scythia to Siberia 24/1-2, Special Volume*, 331–353.
- Lippolis, C., Mamedov, M., Bruno, J., Patrucco, G. 2019. Preliminary note on the 2019 archaeological campaign of the Italian-Turkmen archaeological expedition to old Nisa (Turkmenistan). *Parthica* 21, 115–126, 192.
- Lyonnet, B. 2012. Questions on the Date of the Hellenistic Pottery from Central Asia (Ai Khanoum, Marakanda and Koktepe), *Ancient Civilizations from Scythia to Siberia* 18, 143–173.

- Lyonnet, B. 2013. La céramique de la maison du quartier sud-ouest d'Aï Khanoum. In: G. Lecuyot (ed.), Fouilles d'Aï Khanoum IX, L'habitat (Mémoire de la Délégation archéologique française en Afghanistan XXXIV), Paris, De Boccard, 179–234.
- Maresca, G. 2016. Echoes of Regional Traditions plus Western Typological Influences: Some Notes about the Post-Achaemenid Pottery Assemblage from the Italian Excavations at Qal'a-ye Sam (Iran, Sistan), in R. A. Stucky, O. Kaelin, and H.-P. Mathys (eds.), Proceedings of the 9th International Congress on the Archaeology of the Ancient Near East, 9–13 June 2014, Basel, Volume 2, Wiesbaden, Harrassowitz Verlag, 195–207.
- Mandel'shtam, A.M. 1971. Meshrepitekhtinskiĭ Mogilnik. *Kratkie Soobshchenija* 128, 66–72.
- Marushchenko, A.A. 1959. Kurgannie pogrebeniya sarmatskogo vremeni v podgornoĭ polose Yuzhnogo Turkmenistana. *Tr.IIEAAN TurkmSSR* 5, 110–122.
- Mokrobodov, V.V. 2013. Format syrtsovogo kirpicha kak dopolnitel'nyĭ istochnik po khronologii pamyatnikov rannezheznovo veka. *O'zbekiston Arxeologiyasi* 1 (6), 12–20.
- Olbrycht, M. J. 2015. Arsacid Iran and the Nomads of Central Asia – Ways of Cultural Transfer, in J. Bemman, M. Schmauder (eds.), Complexity of Interaction along the Eurasian Steppe Zone in the First Millennium CE, *Bonn Contributions to Asian Archaeology* 7, Rheinische Friedrich-Wilhelms-Universität Bonn, 333–390.
- Pilipko, V. N. 1975. Parfianskoe sel'skoe pocelenie Garry-Kjariz, Ashgabat, Ylym.
- Pilipko, V. N. 1990. Ranneantichnoe poselenie Kapyr-kala u Kaushuta. In: *Drevnjaja i srednevekovaja arheologija Srednej Azii* (K probleme istorii kul'tury). Tashkent.
- Pilipko, V. N. 2001. Staraya Nisa. Osnovnye itogi arheologicheskovo izucheniya v sovetskij period, Moskva.
- Pilipko, V. N. 2005. Raskopky Khyrly-depe, *Problemy Istorii, Filologii, Kul'tury* 15, 57–80.
- Pilipko, V. N. 2012. Remarks on the material culture of the Akhal area in the Hellenistic period, *Anabasis* 3, 109–125.
- Pilipko, V. N. 2014. Materialy iz raskopok poselenija ellinisticheskogo vremeni Dashly 45 (Kaahkinskij rajon, Turkmenistan). *Rossijskaja Arkheologija* 2014/1, 123.
- Pilipko, V. N. 2015. Stanovlenie i razvitie parfyanskoj kul'tury na territorii yuzhnogo Turkmenistana, Sankt-Peterburg, AIK.
- Pilipko, V. N., Koshelenko, G. A. 1985. Srednjaja Azija v antichnuyu epokhu. Severnaja Parfija. In G. A. Koshelenko (ed.), *Drevnejšie gosudarstva Kavkaza i Srednej Azii*, Moskva, 209–225.
- Puschnigg, G. 2008. Hellenistic Echoes in Parthian Merv: Transformation and Adaptation in the Ceramic Repertoire. *Parthica* 10, 109–127.
- Sarianidi V. I. 1969. Prodlzhenie rabot na Ulug-Depe. *AO* 1968, 434–445.
- Sarianidi V. I. 1971. Issledovanie sloev rannezheznogo veka na Ulug-Depe. *AO* 1970, 433–444.
- Sarianidi V. I. 1972. Raskopki 1970 g. na Ulug-Depe. *Uspekhi sredneaziatskoĭ arkheologii*, 53–55.
- Scerrato, U. 1966. Excavations at Dahan-i Ghulaman (Seistan-Iran). First Preliminary Report (1962-1963). *East and West* 16 (1-2), 9–30.
- Sverchkov, L. M. 2006. Opyt sinkhronizatsii keramicheskikh kompleksov epokhi ellinizma (Kampyrtepa, Termez, Dzhigatepa, Kurganzol), *Materialy Tokharistanskoi ekspeditsii* 5, 105–124.
- Sverchkov, L. M. 2008. The Kurganzol Fortress (on the History of Central Asia in the Hellenistic Era). *Ancient Civilizations from Scythia to Siberia* 14, 123–191.
- Tolstov, S. P., Vajnberg, B.I. 1967. Koj-Krylgan-kala – pamjatnik kul'tury drevnego Khorezma IV v. do n.è. – IV v. n.è. (Tr. KhAèè V). Moskva, Nauka.
- Vorob'eva, M. G. 1973. Dingil'dzhe v drevnem Khorezm. *Usad'ba I tysjacheletnija do n.è. (MKhè 9)*. Moskva: Nauka.
- Yagodin, V. N. 1990. Kurgannyj Mogil'nik Devkesken-4. *Arkheologija Priaral'ja* 4, 28–81.
- Zadneprovskij, Y. A. 1994. The Nomads of the Northern Central Asia after the Invasion of Alexander, in J. Harmatta (ed.), *History of Civilisations of Central Asia. Vol. II, The Development of Sedentary and Nomadic Civilisation 700 B.C. to A.D. 250*, Paris, UNESCO Publishing, 448–463.

*Boşunly, abat jürdek  
(A. Pelle).*

*A complete necked jug  
(MAFTur/ A. Pelle).*

*Целый кувшин с  
горлышком (А. Пелле).*





J. Lúuilýe, H. Bendezu-Sarmiento

### ULUGDEPEDE SOŇRAKY BARLAGLARYŇ DOWAMYNDA ÜSTI AÇYLAN ELLINIZM WE PARFIÝA DÖWÜRLERINDÄKI ÝAŞAÝSYŇ YZLARY

Bu makalada täze barlaglaryň netijesinde ýüze çykarylan maglumatlaryň esasynda ellinizm we parfiýa döwürlerinde Ulugdepäniň täzedan ilatlaşandygyny esaslandyrmaga synanyşyk edilýär. Bu ýadygärlik Merkezi Aziýanyň günortasynyň giçki neolitden başlap irki demir asyrynyň ortaky döwrüne çenli, juda uzak wagtlap üznüksiz dowam eden uzygiderli stratigrafiýasyny ýüze çykarýar. Demir asyrynyň ortaky döwrüniň ahyrynda boşap galanyndan soň, b.e.ö. I müňýyllygyň ahyrynda ol ýene-de ilatlaşypdyr.

Bu döwre degişli arheologik gatklaryň ýaramaz saklanandygyna garamazdan, Türkmen-fransuz bilelikdäki ekspedisiýasy tarapyndan amala aşyrylan giňişleýin barlaglar ol döwürdäki ýaşaýsyň yzlaryny ýadygärligiň ençeme ýerinde ýüze çykarmaga we dürli keramika toplumlaryny öwrenmäge mümkinçilik berdi. Bu barlaglar Ulugdepäniň b.e.ö. I müňýyllygyň soňky ýüzýyllyklarynda hem Günorta Türkmenistanyň Köpetdagyň etegi zolagynda möhüm strategik ýagdaýa eýe bolandygy baradaky çaklama esas döredýär.

Дж. Люлье, Х. Бендезу-Сармьенто

### ЭЛЛИНИСТИЧЕСКИЙ И ПАРФЯНСКИЙ ПЕРИОДЫ ОБЖИВАНИЯ ГОРОДИЩА УЛУГ-ДЕПЕ В СВЕТЕ ПОСЛЕДНИХ ОТКРЫТИЙ

В данной статье предпринята попытка представить в свете новых открытий данные о выявленных за последнее время периодах заселения Улуг-депе: эллинистическом и парфянском. Этот памятник демонстрирует самую длинную непрерывную стратиграфическую последовательность юга Центральной Азии, от позднего неолита до среднего железного века. После периода запустения, наступившего в конце среднего железного века, эта территория вновь была освоена в конце I тысячелетия до н.э. Несмотря на то, что археологические напластования, от-

носящиеся к данному времени, плохо сохранились, комплексные исследования, осуществлённые Совместной туркмено-французской археологической экспедицией, позволили обнаружить следы обживания этого периода на многих участках городища и изучить разнообразные керамические комплексы. Эти исследования дают основание предполагать, что Улуг-депе занимал стратегическое положение в центре прикопетдагской равнины Южного Туркменистана на протяжении последних веков I тысячелетия до нашей эры.



*«Garwa» keramikasynyň görnüşleri: ýüzünde reňkiň yzlary galan küýze döwürleri (J. Lúuilýe, A. Didiýe).*

*“Nomadic” pottery types, potsherds with splashes of slip or paint (MAFTur/ J. Lhuillier, A. Didier).*

*Типы «кочевой» керамики: глиняные черепки со следами краски (Дж. Люлье, А. Дидье).*

**TÜRKMENISTANYŇ GADYMYÝETI**  
**Ylmy-barlaglar we ýadygärlikleriň rejelenilişi**

Çapa taýýarlanlar: Taryhy-medeni ýadygärlikleri goramak,  
öwrenmek hem-de rejelemek baradaky milli müdirligiň hünärmenleri

Ylmy redaktor	<i>M. Mamedow</i>
Redaktorlar	<i>B. Hojagulyýew, M. Kerimowa, A. Popow</i>
Surat redaktory	<i>O. Çerkezowa</i>
Teh. redaktor	<i>O. Nurýagdyýewa</i>
Kompýuter işleri	<i>A. Korotkowa, M. Geldiyew, B. Mämmetgurbanow</i>
Iňlis diline terjime	<i>R. Denega</i>
Dizaýn-maket	<i>A. Şaýymowa</i>

A – 107691.

Çap etmäge rugsat edildi 18.02.2022. Ölçeği 66 x 100<sup>1/8</sup>. Çap listi 39.0.  
Şertli reňkli ottiski 193,98. Şertli çap listi 47.58. Hasap-neşir listi 46,05. Sargyt № 1227. Sany 2000.

Türkmen döwlet neşirýat gullugy.  
744000. Aşgabat, Garaşsyzlyk şaýoly, 100.

Türkmen döwlet neşirýat gullugynyň Metbugat merkezi.  
744015. Aşgabat, 2127-nji (G.Gulyýew) köçe, 51/1.