



HAL
open science

The Roman port of Parentium (Poreč/Parenzo, Croatia)

Klaudia Bartolić Sirotić, Gaetano Benčić, Marie-Brigitte Carre, Giulia Boetto,
Ida Koncani Uhač

► **To cite this version:**

Klaudia Bartolić Sirotić, Gaetano Benčić, Marie-Brigitte Carre, Giulia Boetto, Ida Koncani Uhač. The Roman port of Parentium (Poreč/Parenzo, Croatia). 1st International Conference of Mediterranean Harbour & Coastal Archaeology Harbour Cities 2022, Aix Marseille Université, Sep 2022, Aix-en-Provence, France. halshs-03909376

HAL Id: halshs-03909376

<https://shs.hal.science/halshs-03909376>

Submitted on 19 Jan 2023

HAL is a multi-disciplinary open access archive for the deposit and dissemination of scientific research documents, whether they are published or not. The documents may come from teaching and research institutions in France or abroad, or from public or private research centers.

L'archive ouverte pluridisciplinaire **HAL**, est destinée au dépôt et à la diffusion de documents scientifiques de niveau recherche, publiés ou non, émanant des établissements d'enseignement et de recherche français ou étrangers, des laboratoires publics ou privés.



Klaudia Bartolić Sirotić

Gaetano Benčić

Zavičajni muzej Poreštine/
Museo del territorio parentino

Giulia Boetto

Marie-Brigitte Carre

Centre Camille Jullian, CNRS
Aix Marseille Université

Ida Koncani Uhač

Arheološki muzej Istre /
Museo archeologico dell'Istria

The Roman port of *Parentium* (Poreč/Parenzo, Croatia)

1st Mediterranean Harbour Cities Conference, Aix-en-Provence, 27 septembre 2022



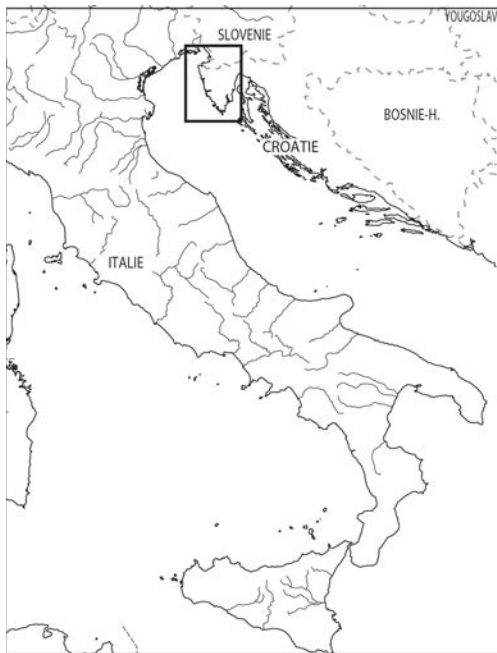

Istria (Xth regio)



R. Kosinožić

Poreč Peninsula and its waterfront



- *caput civitatis*, colonial sea ports
- Secondary ports
- Ports of *villa* or related to economic activity

Hierarchy of the Istrian ports

(in : *L'Istrie et la mer*, 2011, p. 58)



**The northern shore of the
Peninsula :
La Porporella**

L. Damelet, CNRS/CCJ



L. Damelet, CNRS/CCJ

Excavations 2019, 2021

Arheološki muzej Istre, Pula/Pola

Centre Camille Jullian, Aix-en-Provence

271500.000

271600.000

271700.000

271800.000

271900.000

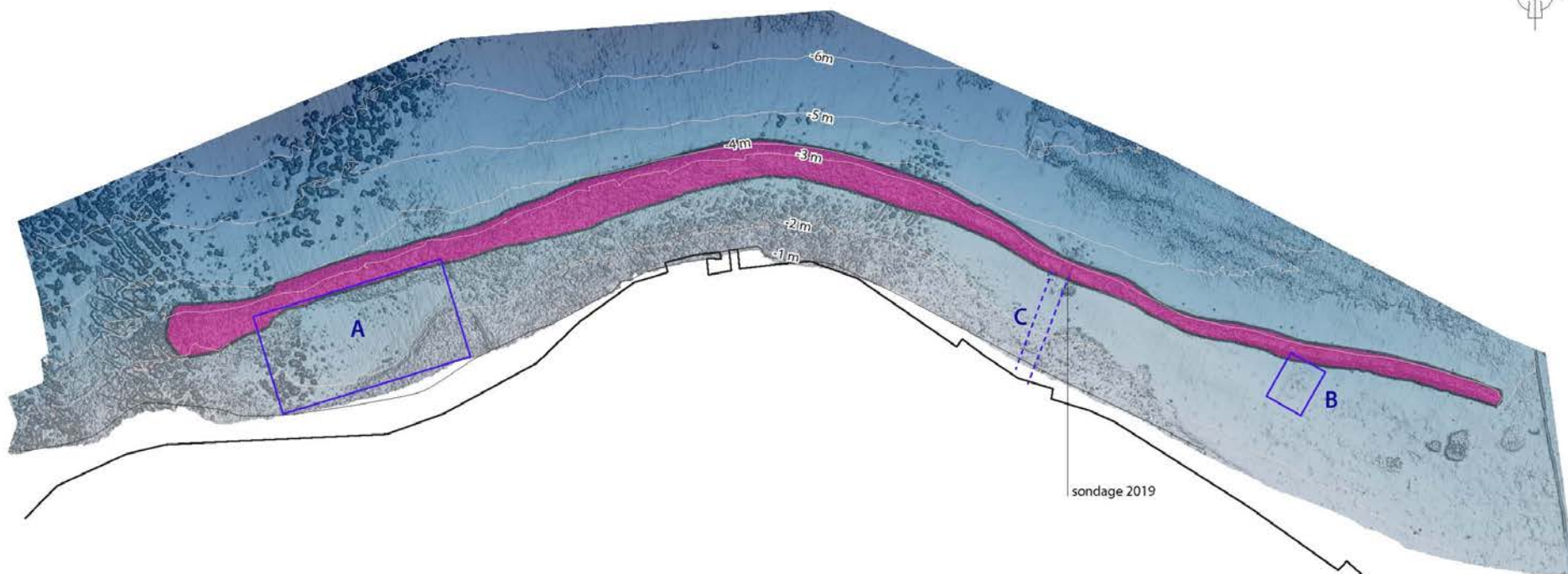

50 100 150 200 m

emprise porporela
solution bathymetric : SIRIO d.o.o. Koper, 2019
projection cartographique : HTRS96

AMU, CNRS, CCJ/JMR/2019/ V.Dumas/2020

longueur porporela : 418 m
largeur min : 4,4 m
largeur max : 12,5 m
superficie porporela : 3652 m²
volume porporela : 1614 m³

Sidescan sonar (Sirio, Koper, SLO)

+



Sonda A



Sonda B

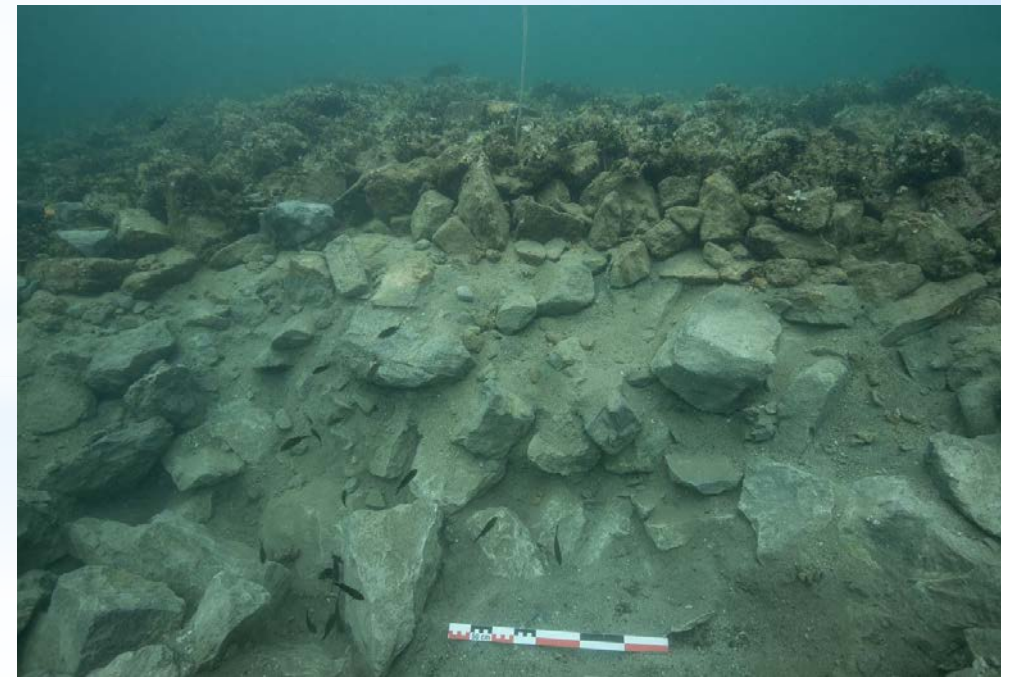

Coupes transversales sur la Porporella

(V. Dumas, CCI/CNRS)

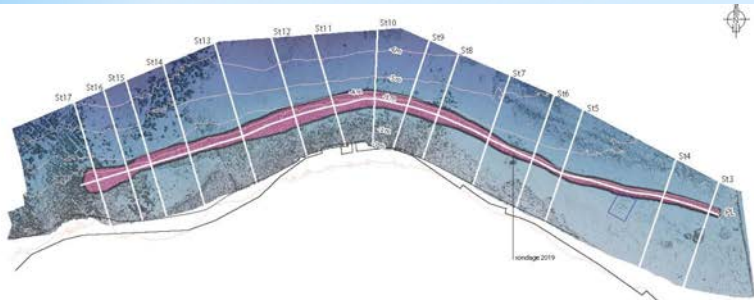

Transversale 1

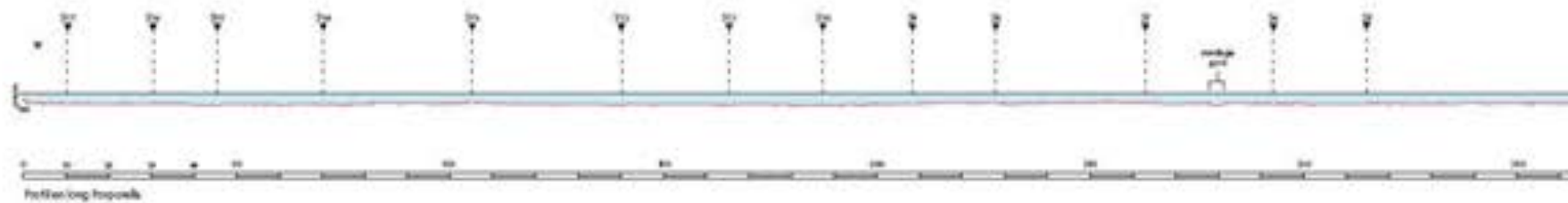
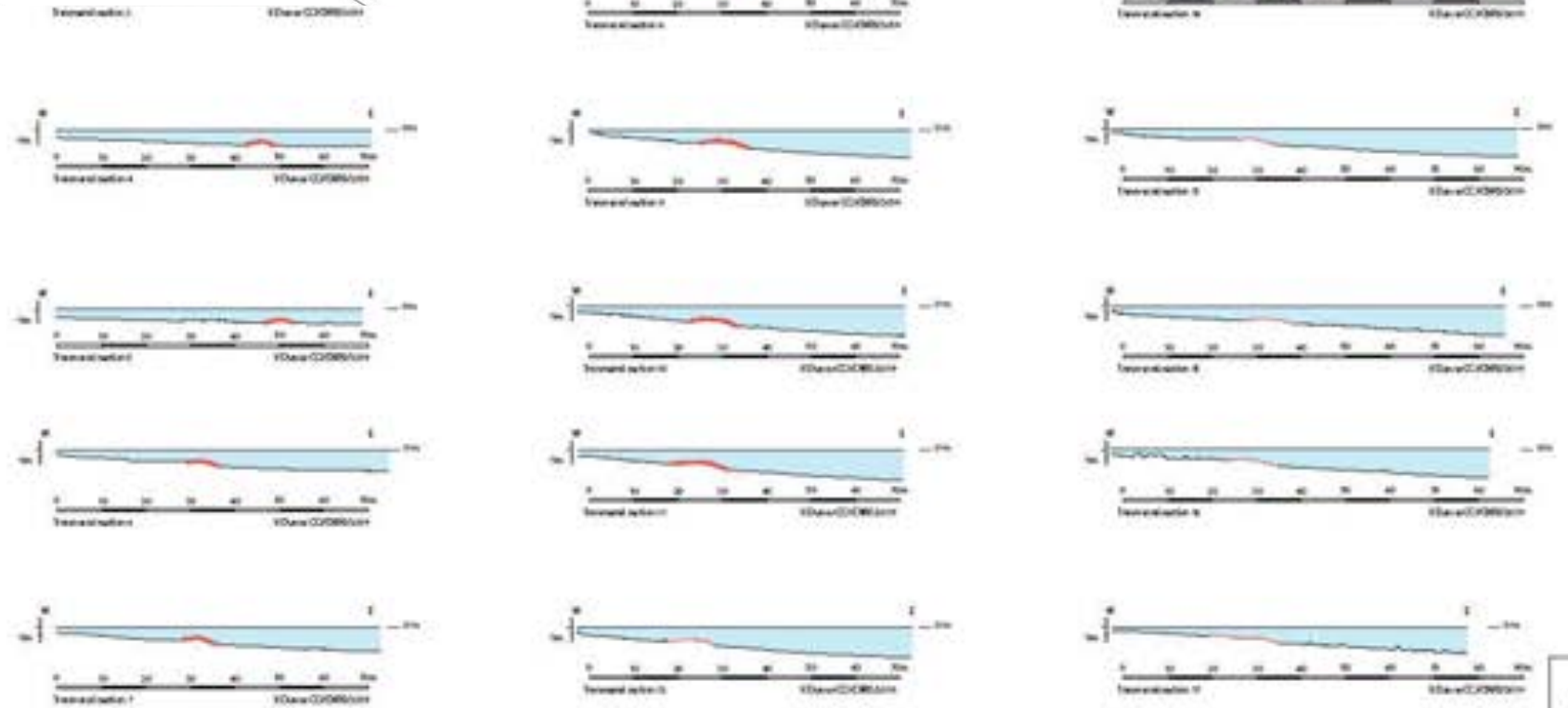

Map of the harbour of Parenzo/Poreč

(Carta di Cabotaggio, 1845, folio 3, State Archives in Zadar).

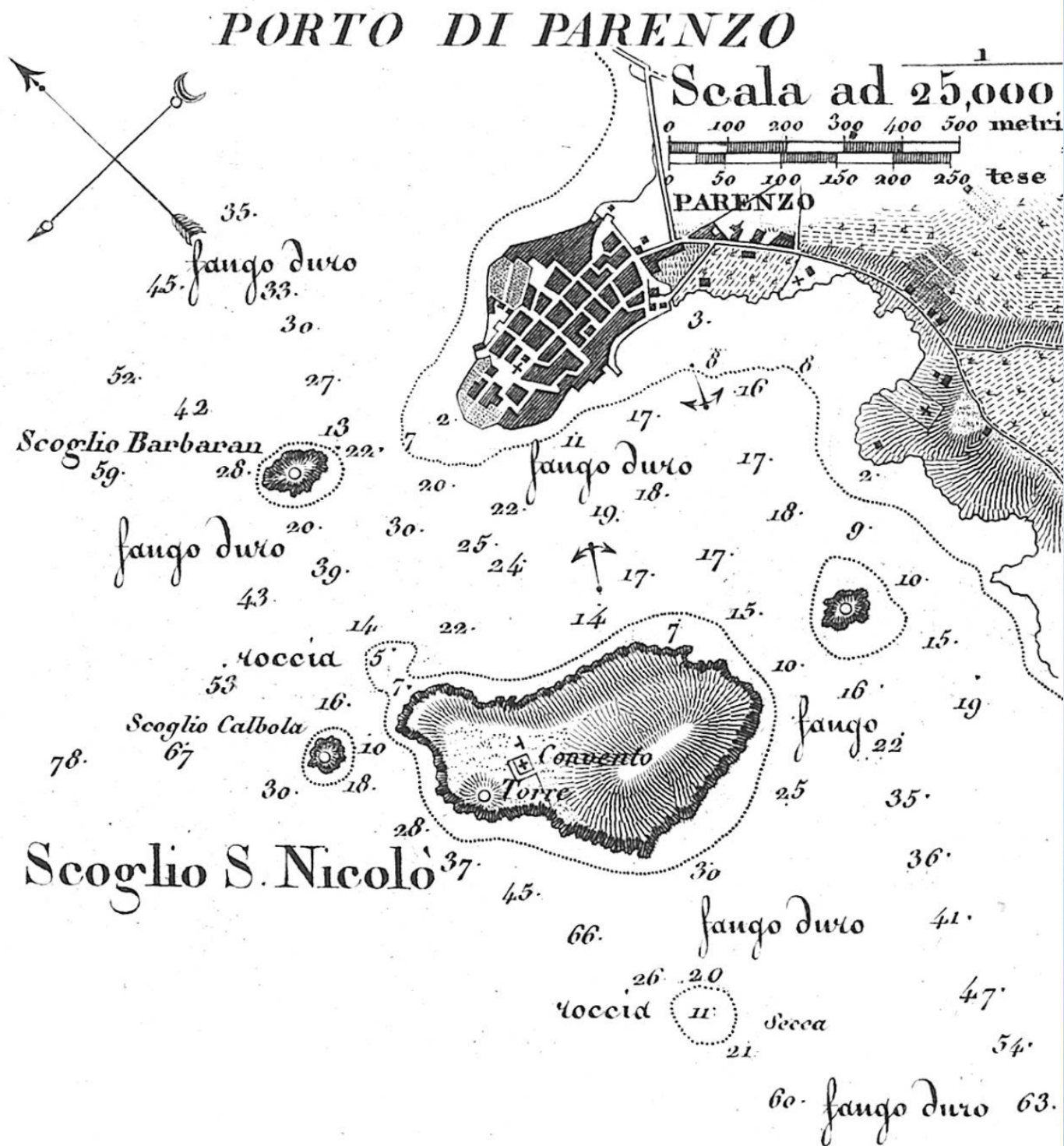

Southern shore of Parenzo



Location of Riva 1994
excavation



Location of Porta de Mar
2020 excavation

Excavation 1994

(M. Novak, Zavičajni muzej Poreštine/ Museo del territorio parentino)

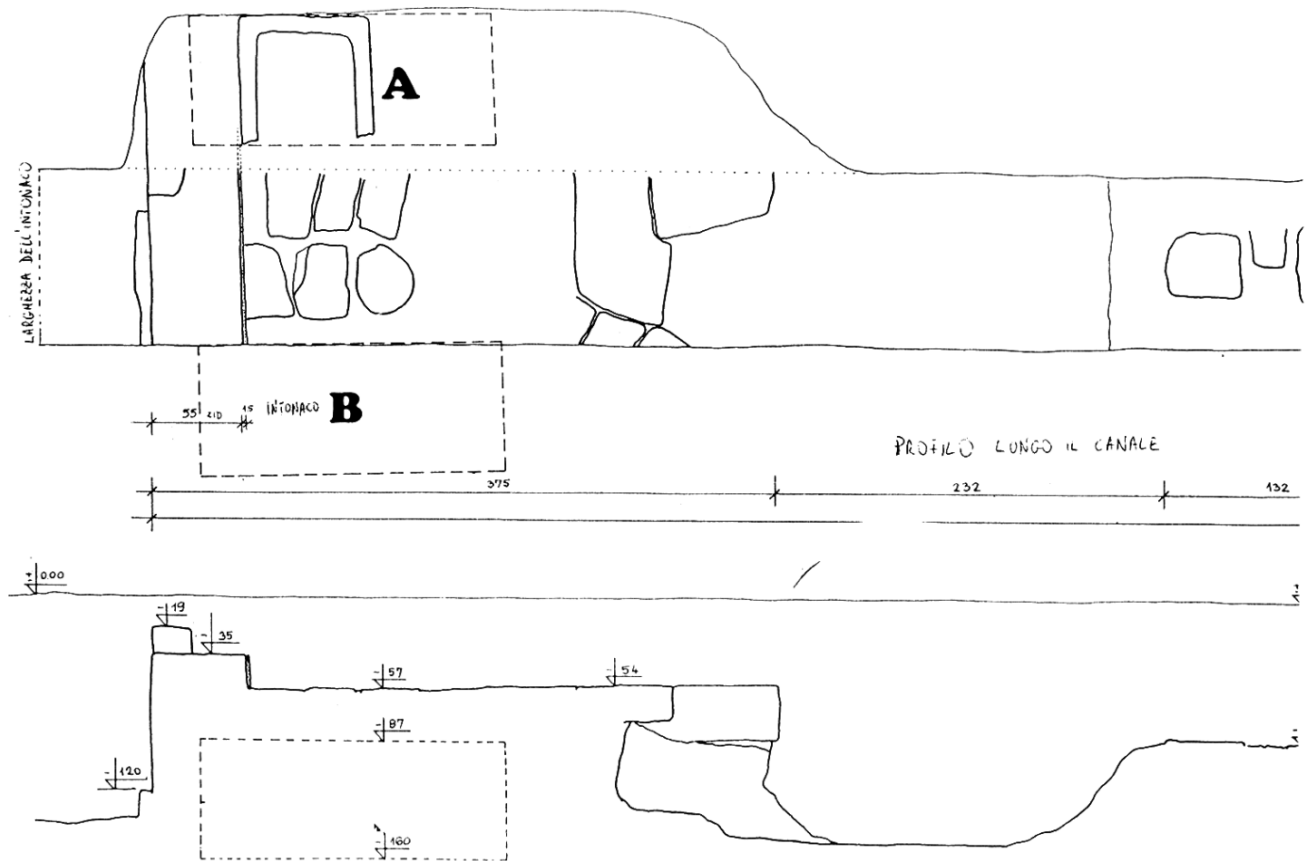

Southern shore of Parenzo

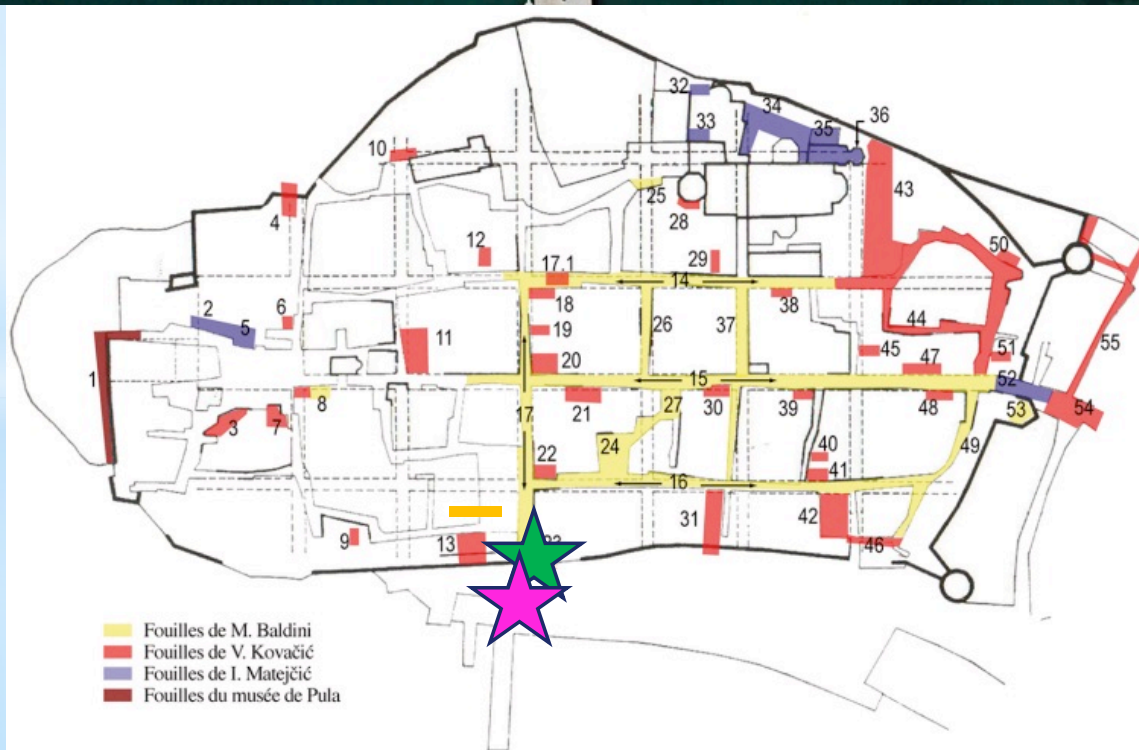

Location of Riva 1994
excavation



Location of Porta de Mar
2020 excavation



Porta de Mar Excavation 2020

(photos Zavičajni muzej Poreštine/ Museo del territorio parentino)





(ortho-photos Zavičajni muzej Poreštine/ Museo del territorio parentino)





The wreck



(ortho-photos Zavičajni muzej
Poreštine/ Museo del territorio
parentino)

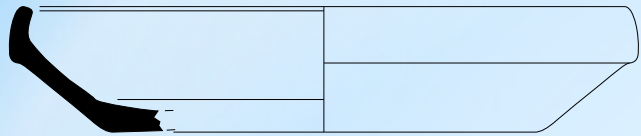

Poreč- Porta de Mar 2020
sj 79-09



Poreč- Porta de Mar 2020
sj 109-01

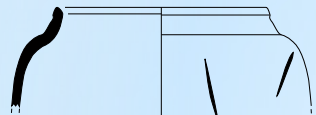
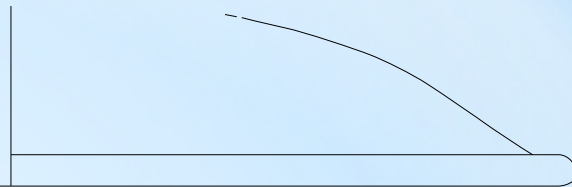

Poreč- Porta de Mar 2020
sj 109-03



Poreč- Porta de Mar 2020
sj 109-14

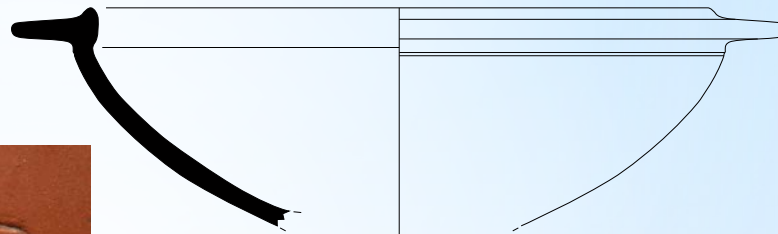

Poreč- Porta de Mar 2020
sj 104-01

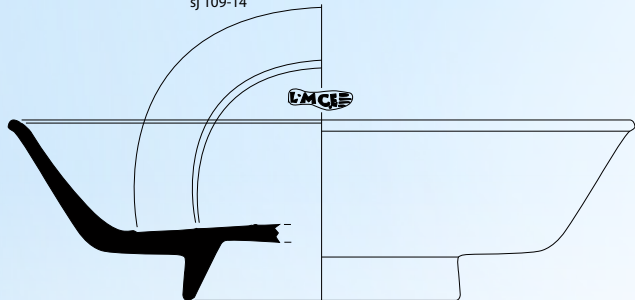

Poreč- Porta de Mar 2020
sj 109-15



End 1st c. AD



Poreč- Porta de Mar 2020
sj 82/83-07

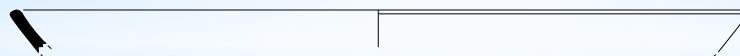

Poreč- Porta de Mar 2020
sj 82/83-02

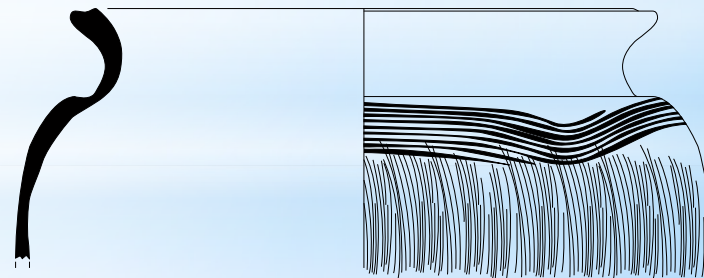

Poreč- Porta de Mar 2020
sj 108-09

III-V th c. AD

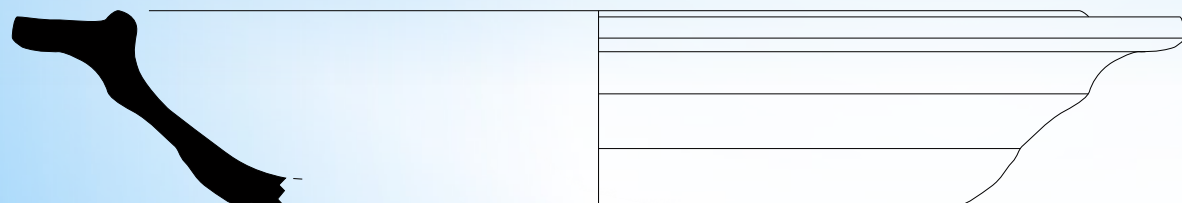

Poreč- Porta de Mar 2020
sj 79-04

(L. Cavassa, CNRS/CCJ)

Statigraphy (K. Bartolić Sirotić ZPM, K. Nees AMU/CCJ)

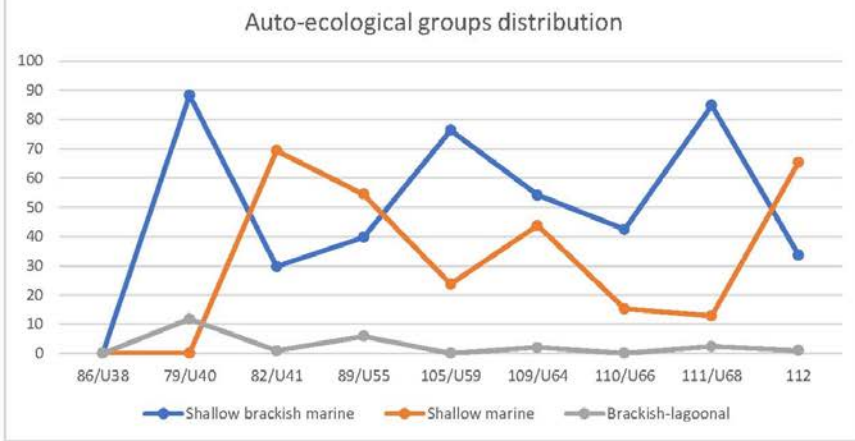
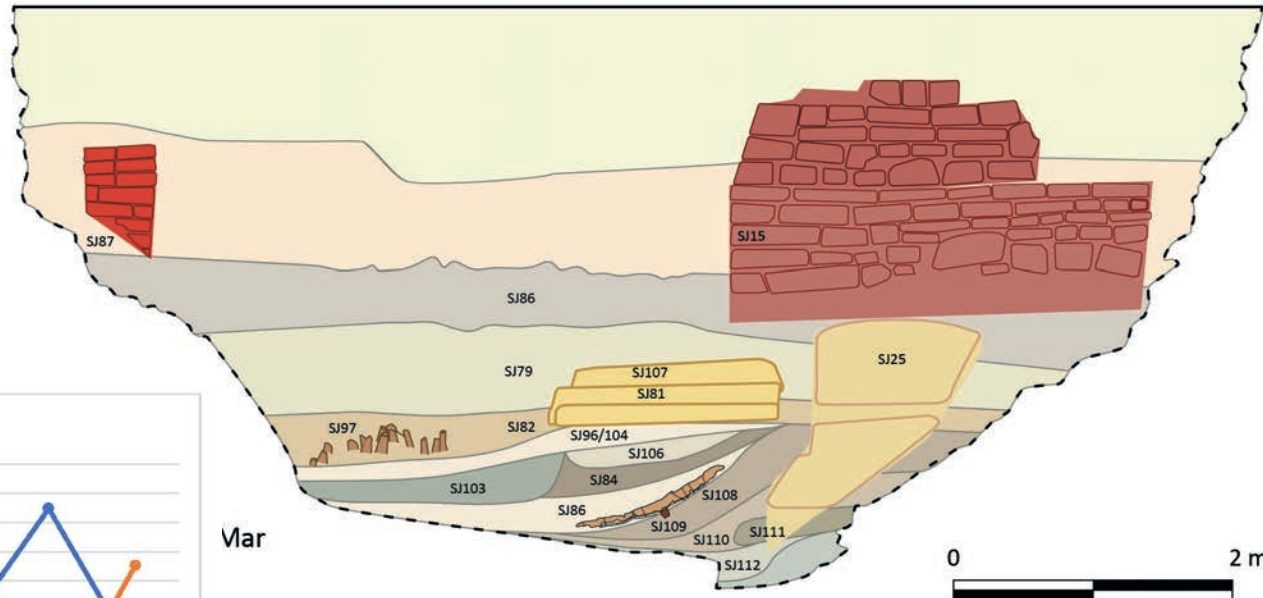

Figure 3 : La distribution des principaux groupes autoécologiques.

Bio-sedimental analysis

(A. Bivolaru, AMU/CEREGE)

Fixed fauna analysis

(H. Zibrowius (CNRS, Station Marine d'Endoume) & Chr. Morhange (AMU/EPHE))

The stairs against the quay
(photo ZPM)





The shipwreck

(photos Zavičajni muzej Poreštine/ Museo del territorio parentino)

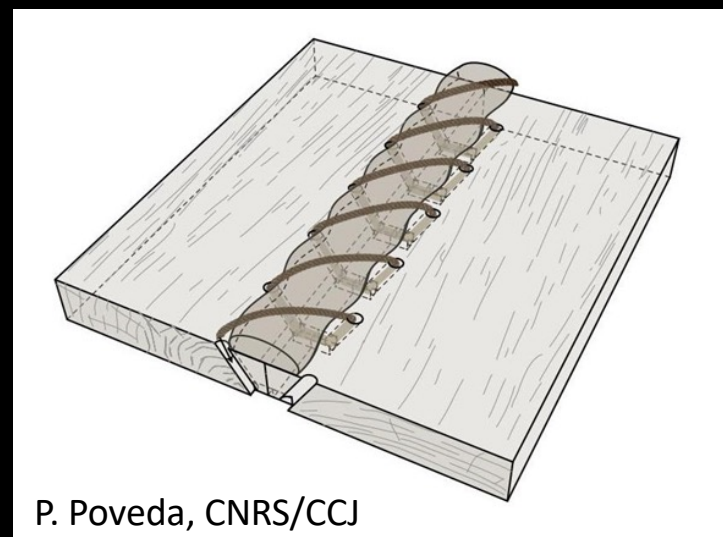

P. Poveda, CNRS/CCJ

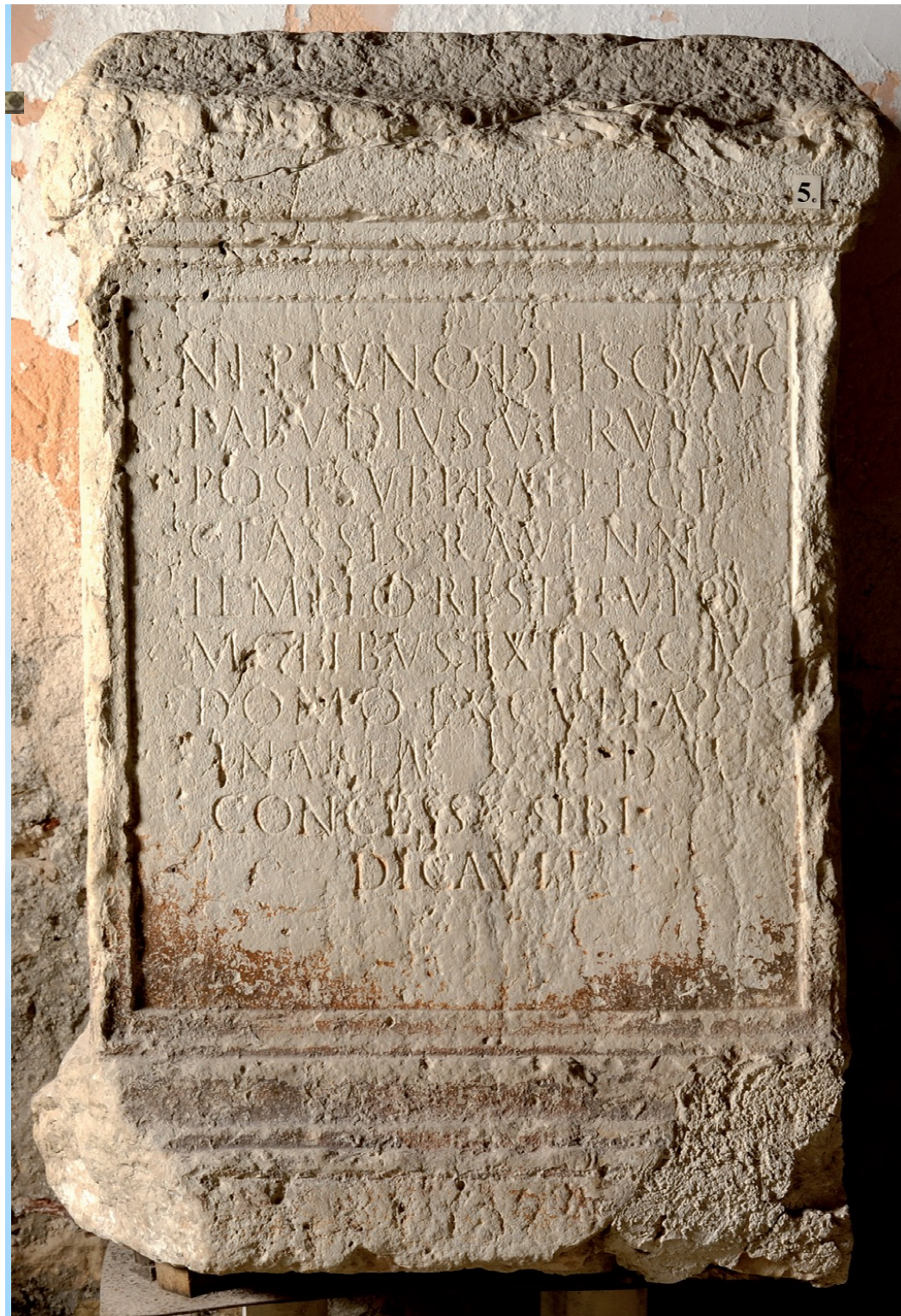

T. Abudius Verus altar

CIL V, 328 = InscrIt X,2, 3

Neptuno deisq(ue) Aug(ustis)

T(itus) Abudius Verus

post subpraefect(uram)

classis Ravenn(atis)

templo restituto

molibus extract(is)

domo exculta

in area d(ecreto) d(ecurionum)

concessa sibi

dicavit