



HAL
open science

Traditions de construction navale dans le nord de l'Adriatique dans l'Antiquité tardive : état des connaissances

Giulia Boetto

► **To cite this version:**

Giulia Boetto. Traditions de construction navale dans le nord de l'Adriatique dans l'Antiquité tardive : état des connaissances. Doctoral Workshop, L'Adriatique entre Antiquité tardive et haut Moyen Âge : espace d'échange d'idées et de formes = The Adriatic between Late Antiquity and Early Middle Ages: Space of Transfer of Ideas and Forms, Université de Franche-Comté; University of Zagreb, Oct 2022, Besançon, France. halshs-03909391

HAL Id: halshs-03909391

<https://shs.hal.science/halshs-03909391>

Submitted on 19 Jan 2023

HAL is a multi-disciplinary open access archive for the deposit and dissemination of scientific research documents, whether they are published or not. The documents may come from teaching and research institutions in France or abroad, or from public or private research centers.

L'archive ouverte pluridisciplinaire **HAL**, est destinée au dépôt et à la diffusion de documents scientifiques de niveau recherche, publiés ou non, émanant des établissements d'enseignement et de recherche français ou étrangers, des laboratoires publics ou privés.

Institut des Sciences et Techniques de l'Antiquité

Postgraduate Doctoral Programme in Pre-Modern History, University of Zagreb

Doctoral Workshop

The Adriatic between Late Antiquity and Early Middle Ages

Space of Transfer of Ideas and Forms

7th and 8th october 2022

UFR SLHS
30 rue Mégevand
Grand Salon

UNIVERSITÉ DE
FRANCHE-COMTÉ



ista
univ-franche.com
UR 4011

Society for the
Medieval Mediterranean

Traditions de construction navale dans le Nord de l'Adriatique dans l'Antiquité tardive : état des connaissances

Giulia Boetto

Centre Camille Jullian UMR 7299

Qu'est-ce que l'archéologie navale ?

Un domaine de recherche

Objet d'étude

- bateaux et navires
- construction
- fonction
- mise en œuvre
- navigation



Historiographie

1536, Lazare de Baïf, *Annotationes... de re navali...*

XVIIe-XVIIIe, ouvrages d'érudits (Witsen 1671, Le Roy 1777...)

1840, Augustin Jal, *Archéologie navale*

Fin XIXe, études philologiques (Graser, Breusing, Vars, Cartault, Torr...)

Apport de l'ethnographie: Amiral Pâris

Début XXe, développement iconographie et ethnographie (Carlini, Poujade...)

Milieu XXe, archéologie (archéologie sous-marine...)

Avant milieu XXe

Sources écrites dominantes, iconographie faible, séparation des sources

- pas de différence de construction
- similarité des navires dans l'espace et permanence des types dans le temps
- diffusionnisme

Après milieu Xxe

Complémentarité des sources : textes, iconographie, ethnographie, archéologie

- différence construction (« sur bordé » ≠ « sur squelette »)
- diversité des navires dans l'espace et dans le temps
- évolutionnisme

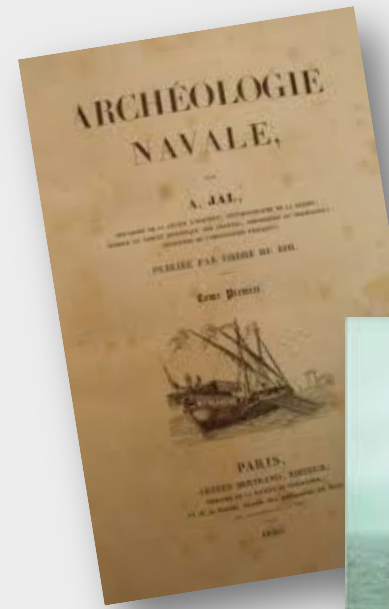

Définition du navire (Muckleroy 1978)

1) MACHINE

- Structure flottante : architecture et hydrostatique (flottabilité et stabilité) -> système architectural
- Structure mobile : propulsion, direction, performances (hydrodynamique) -> système technique

2) INSTRUMENT ADAPTÉ À UNE FONCTION

Adaptation particulière du système architectural et du système technique à une fonction par des aménagements particuliers (navire de guerre ou de commerce, bateau de pêche ou de servitude ...)

3) SOCIÉTÉ FERMÉE

Lieu de vie et de travail d'une micro-société...

Une communauté particulière avec ses traditions, ses modes de vie, sa religiosité

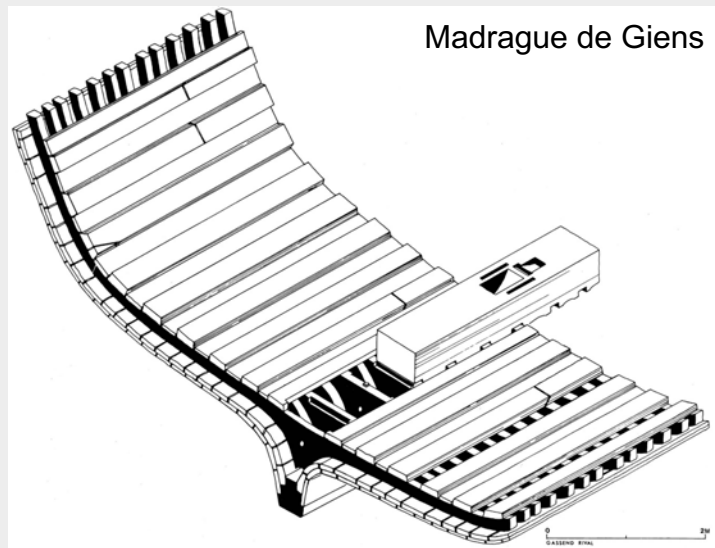

Dessin M. Rival

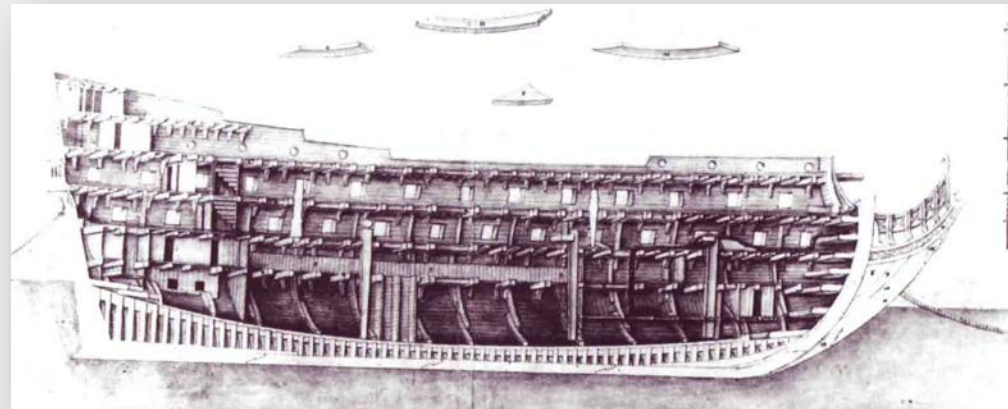

Vaisseau 80 canons (1670), d'après Pomey, Rieth 2005

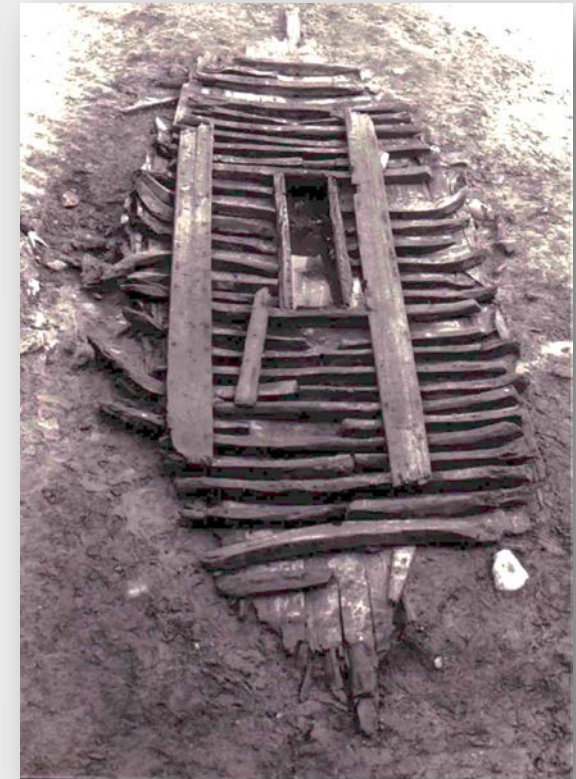

Jules-Verne 3, cliché CNRS/CCJ

Objectifs des études d'archéologie navale

RESTITUTION

- *Systeme architectural*
- *Principe et méthodes de construction : de la conception à la réalisation*
- *Systeme technique*
- *Systeme fonctionnel*
- *Systeme social*

RESTITUTION FINALE D'ENSEMBLE

UTILISATION ET NAVIGATION

Réplique navigante



Shipwrecks found in the North-western Adriatic area (Italy), from Ravenna (Po delta) to Aquileia and in the Eastern Adriatic area (Slovenia and Croatia)

- more or less well preserved (hull bottoms, separate pieces of ship's structures)
- different levels of knowledge (fully published, on-going researches, not yet or enough studied ...)

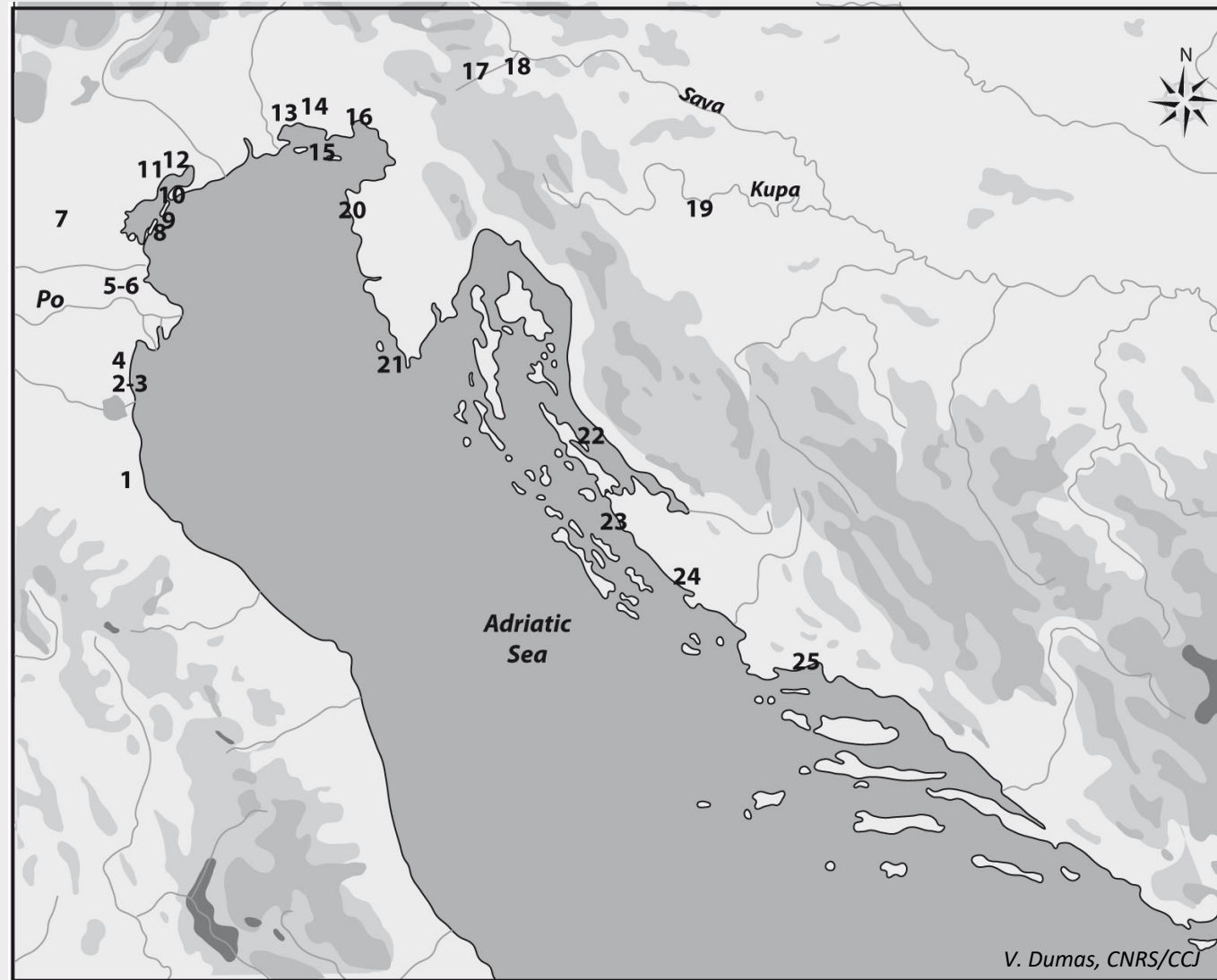

1. Cervia
2. Comacchio
3. S. Maria Padovetere
4. Pomposa
5. Motta di Cavanella d'Adige
6. Corte di Cavanella d'Adige
7. Padova
8. Alberoni, Lido di Venezia
9. S. Nicoletto, Lido di Venezia
10. S. Francesco del Deserto
11. Marcon
12. Meolo
13. Stella
14. Aquileia
15. Grado
16. Monfalcone
17. Lipe
18. Sinjia Gorica
19. Kamensko
20. Zambratija
21. Pula
22. Caska
23. Zaton/Nin
24. Pakostane
25. Trstenik, Split

Chronology: from the Bronze Age to the Late Roman-Early Medieval time

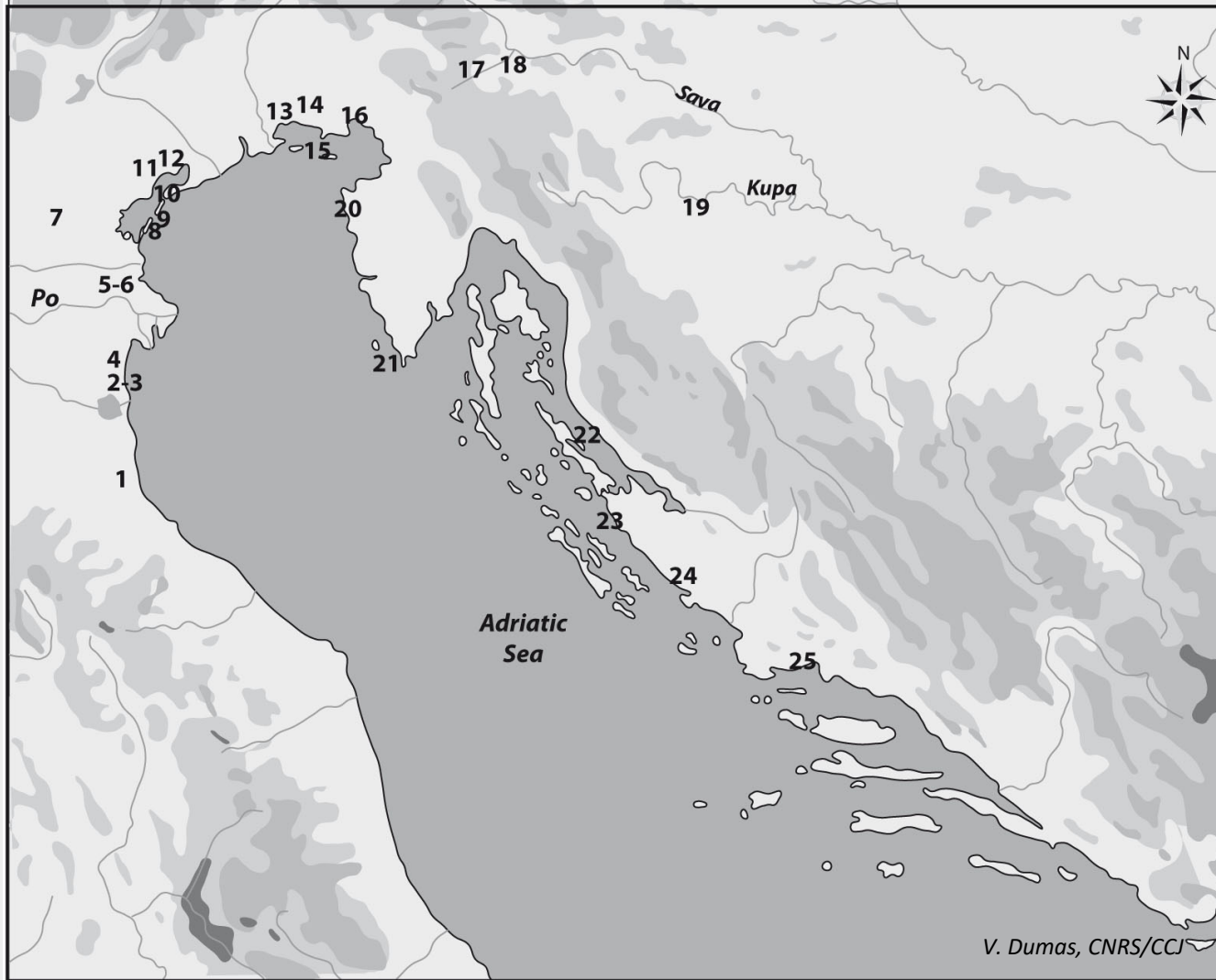

1. Cervia (7th c. AD)
2. Comacchio (end 1st c. BC)
3. S. Maria Padovetere (5th c. AD)
4. Pomposa (possibly 7th c. AD)
5. Motta di Cavanella d'Adige (end 1st-beg. 2nd c. AD)
6. Corte di Cavanella d'Adige 1-2 (end 1st-beg. 2nd c. AD)
7. Padova (before 2nd c. AD)
8. Alberoni, Lido di Venezia (1st-beg. 2nd c. AD; 1-144 AD)
9. S. Nicoletto, Lido di Venezia (Roman, prec. date unknown)
10. S. Francesco del Deserto (Roman, prec. date unknown)
11. Marcon (Roman, prec. date unknown)
12. Meolo (Roman, prec. date unknown)
13. Stella (beg. 1st c. AD)
14. Aquileia (1st c. AD & end 2nd-beg. 3rd c. AD)
15. Grado (2nd c. AD)
16. Monfalcone
17. Lipe (beg. 1st c. AD)
18. Sinjia Gorica (beg. 1st c. AD)
19. Kamensko (1st-2nd c. AD)
20. Zambratija (12th -10th c. BC; 1120-930 BC)
21. Pula 1-2 (1st-end 2nd c. AD)
22. Caska 1-4 (1st - 2nd c. AD)
23. Zaton 1-3 (1st - 2nd c. AD)
24. Pakostane (end 4th -beg. 5th c. AD)
25. Trstenik (1st - 2nd c. AD)

- Keel-based => characterized by a morphological and structural continuity between the bottom and the sides
- Zambratija, Comacchio, Grado, Monfalcone, Caska 1-2, Pula 1 & 2, Zaton 1-3 Pakostane, Trstenik

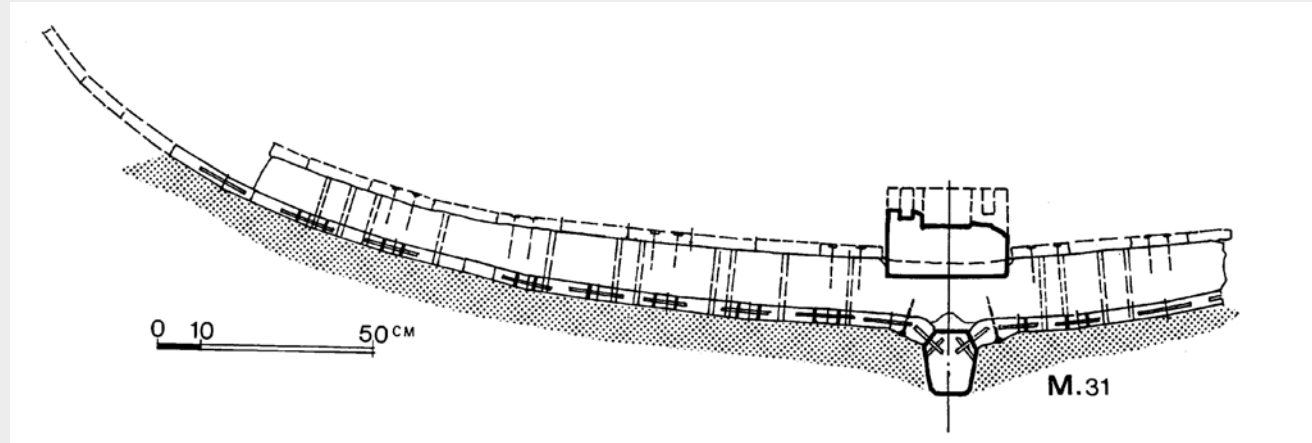

- Bottom-based => characterized by a morphological and structural discontinuity between the bottom and the sides
- Corte di Cavanella d'Adige 1-2, S. Maria Padovetere, Stella, Lipe, Sinjia Gorica, Kamensko

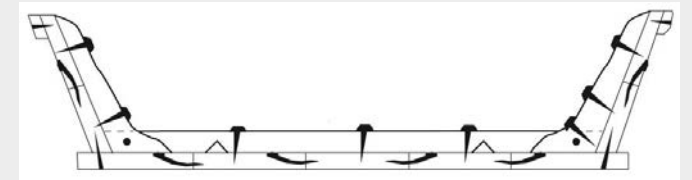
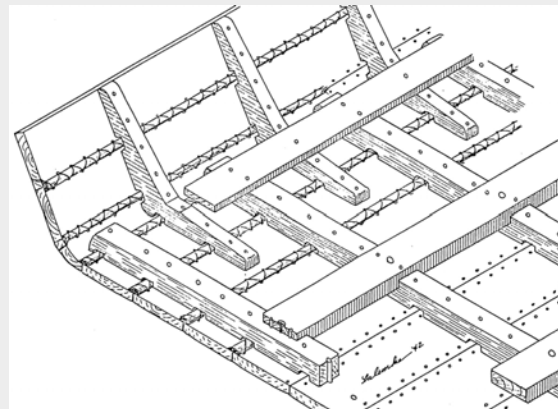
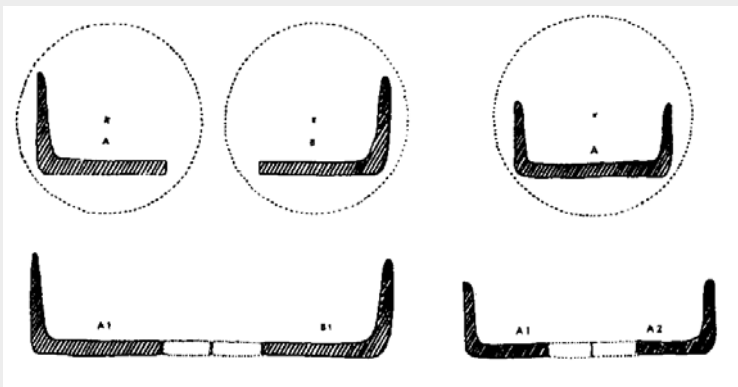

Strakes joined together by mean of different fastening techniques

- Tenons-and-Mortise => strakes fastened using tongues (tenons) of hard wood inserted in cavities (mortises) carved at regular intervals along the edges of the planks then blocked by pegs:
- Grado, Monfalcone, Caska 2, Pakostane, Trstenik

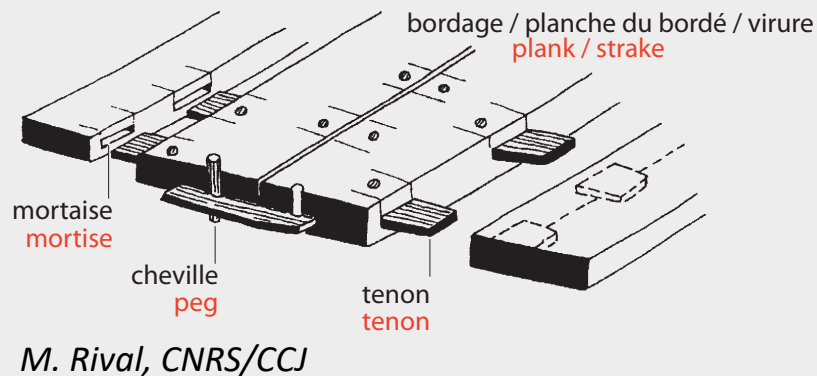

- Sewing => strakes fastened using stiches made of a continuous length of interlocked fibers:
- Corte di Cavanella d'Adige 1-2, Stella, Zambratija, Lipe, Caska 1, 3-4, Pula 1-2, Zaton 1-3

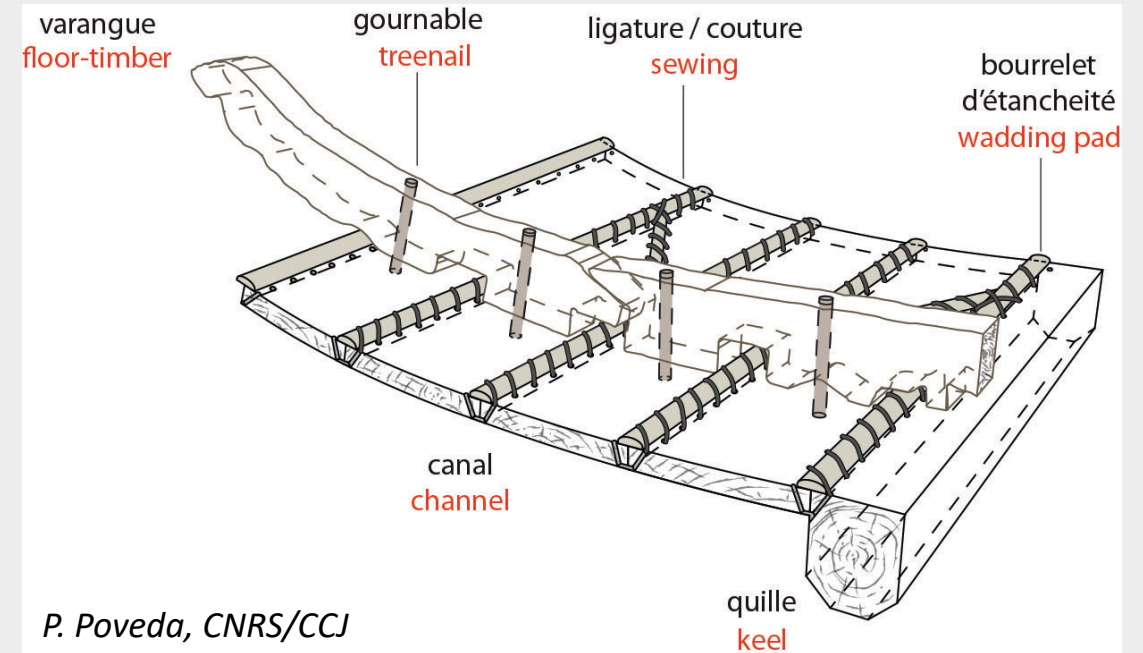

- Mixed techniques (sewings, tenons-and-mortaises)
- Comacchio, S. Maria Padovetere

Strakes joined together by mean of different fastening techniques

- Clamps => strakes fastened using small metallic fastenings:
- Kamensko, Sinja Gorica, Sisak ...



**Different architectural types of ships ...
... and different functional types of ships
adapted to different geographical transport zones (maritime, fluvio-maritime, inland ...)**

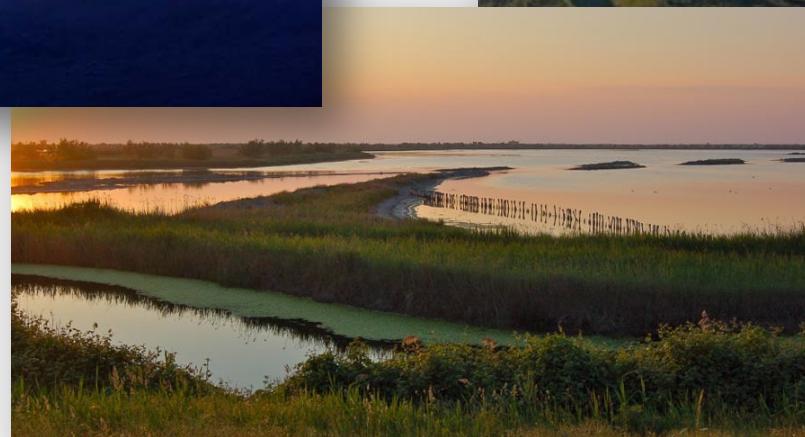

Sewn boats in Adriatic

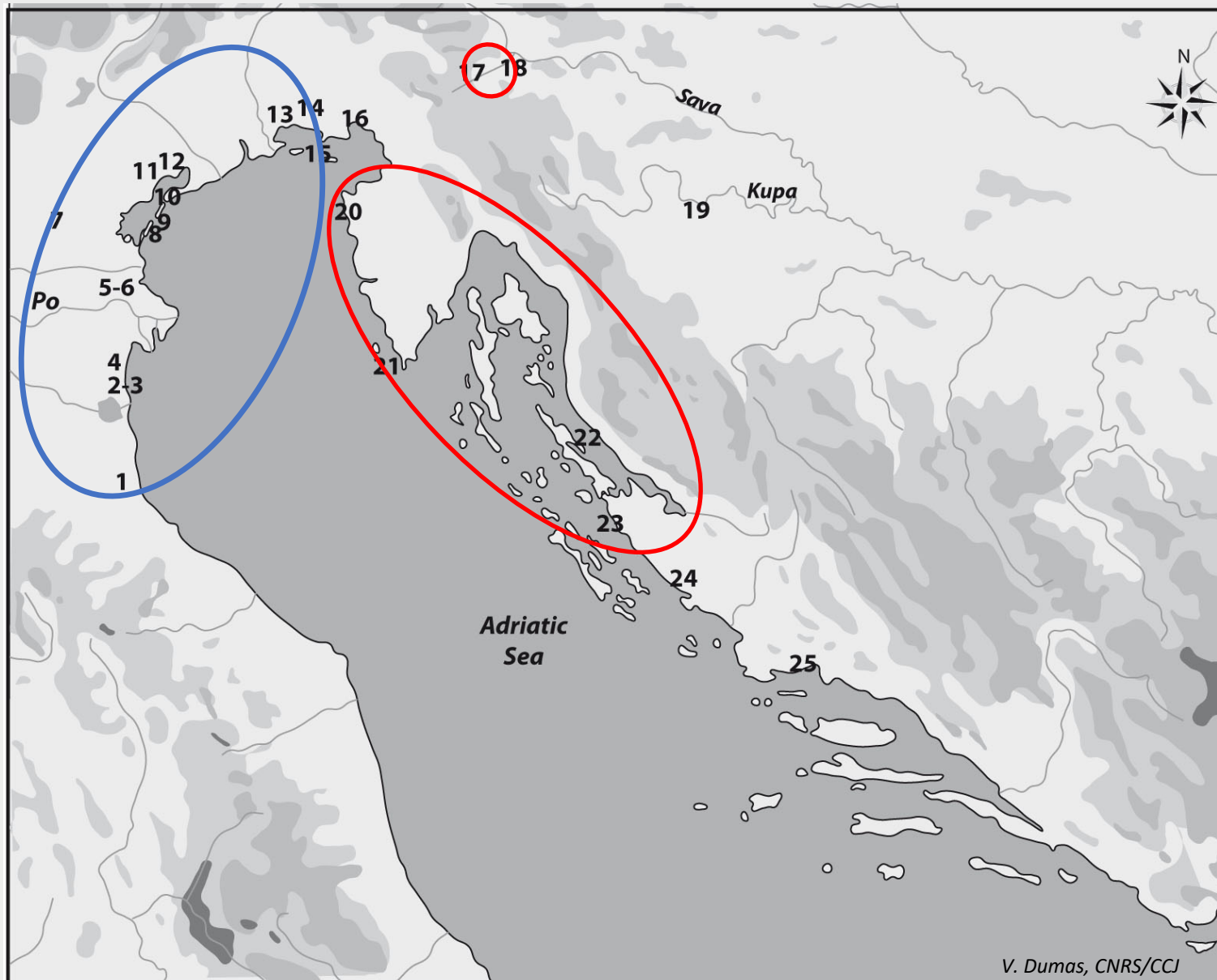

**The North-
Western Adriatic
tradition**

**The Eastern
Adriatic tradition**



point de surjet



point croisé



G. Boetto, CNRS/CCJ

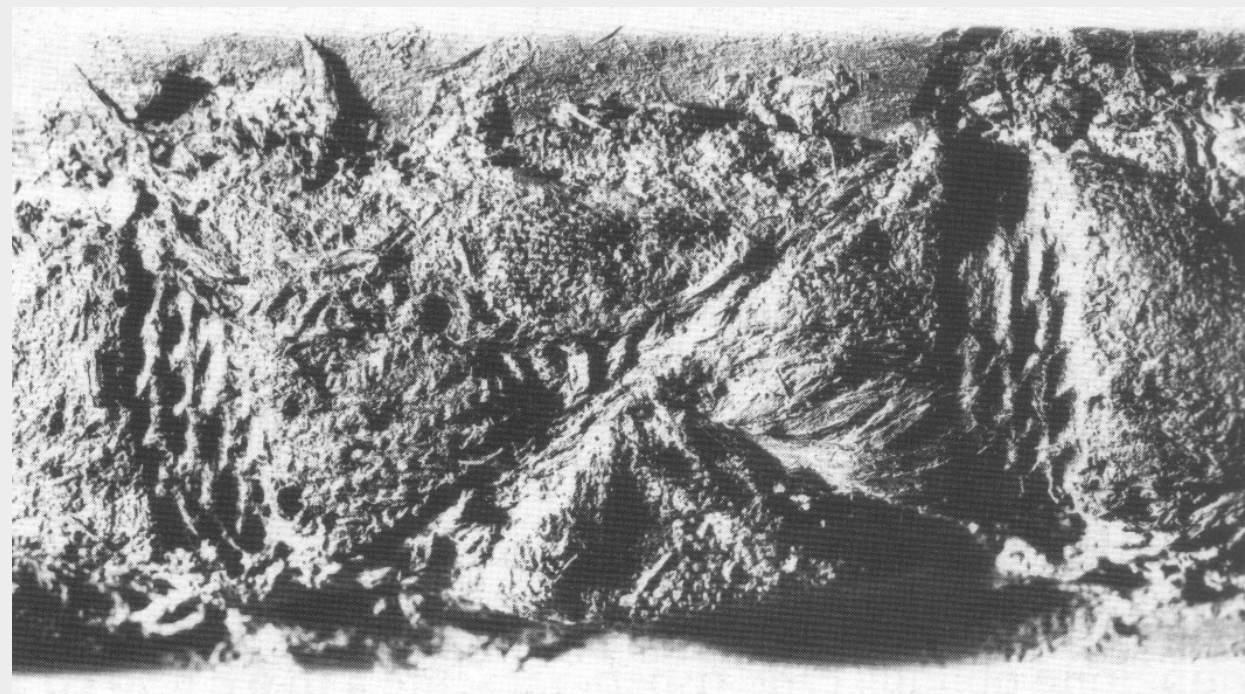

d'après Berti 1990

Caska1, end of the 1st c. AD

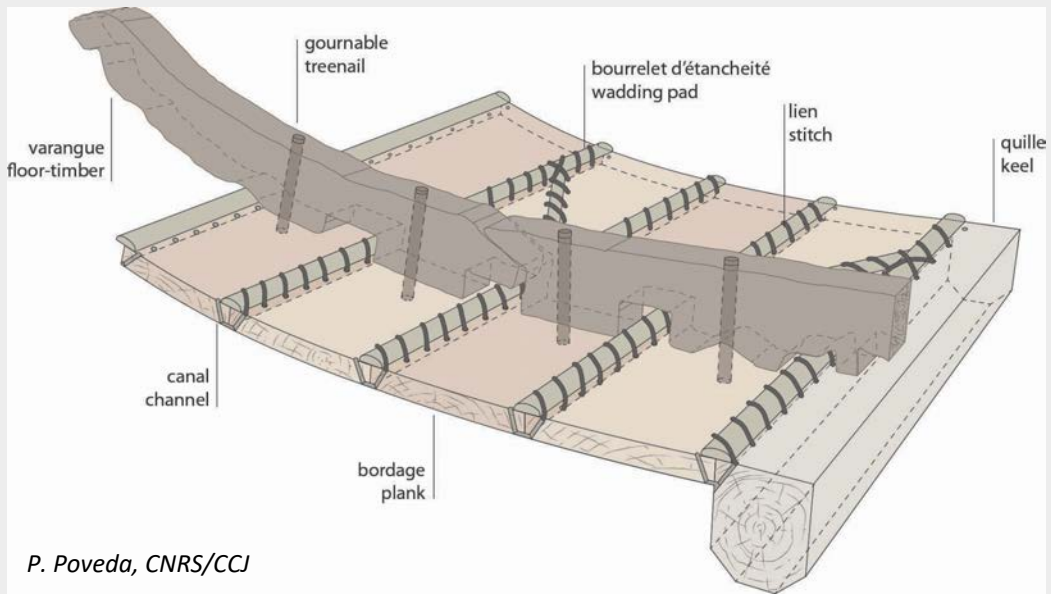

Comacchio, end of the 1st c. BC

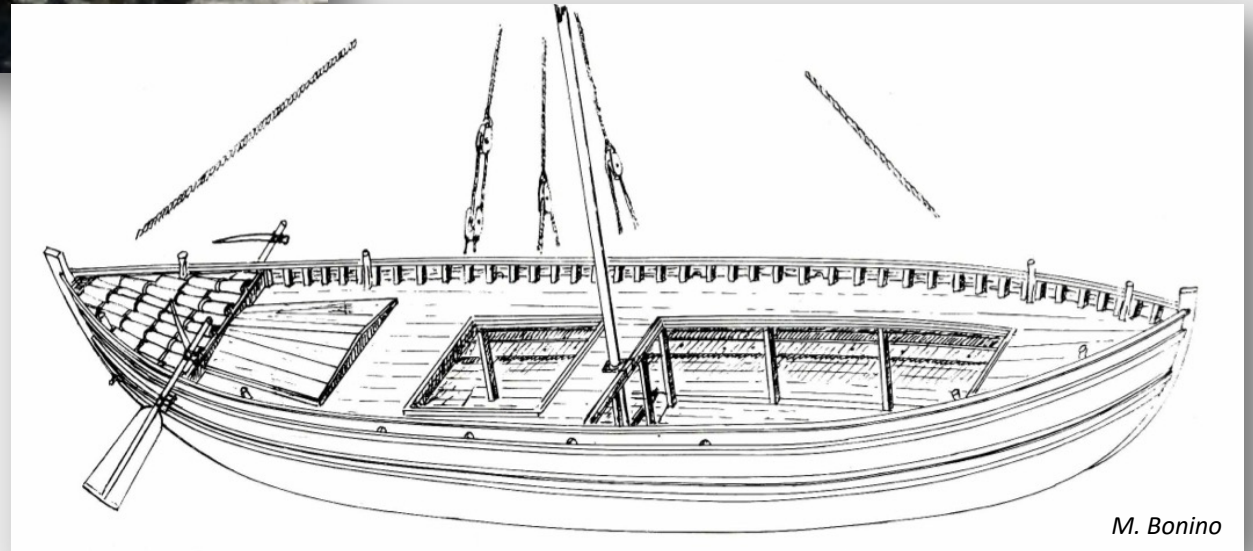
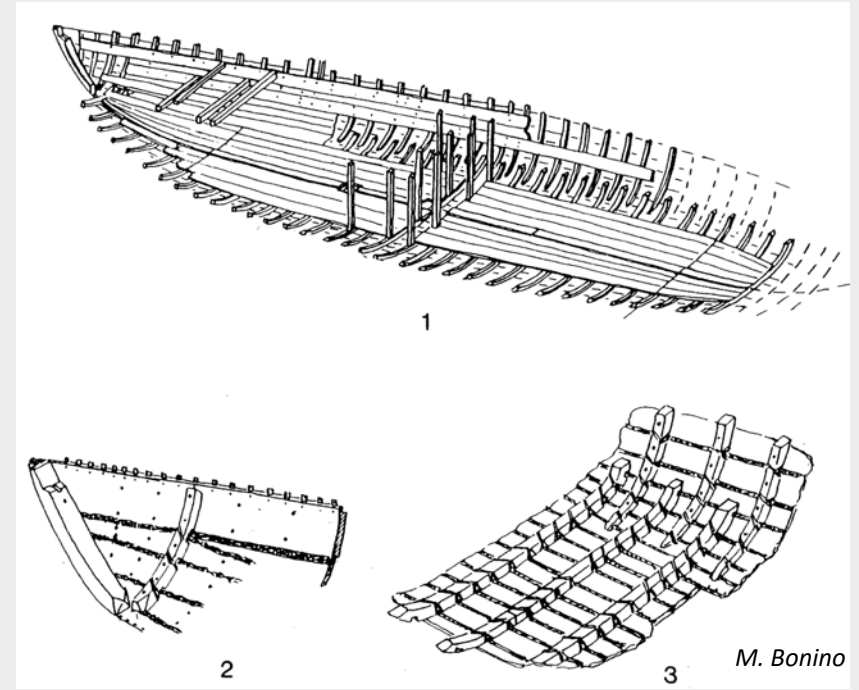
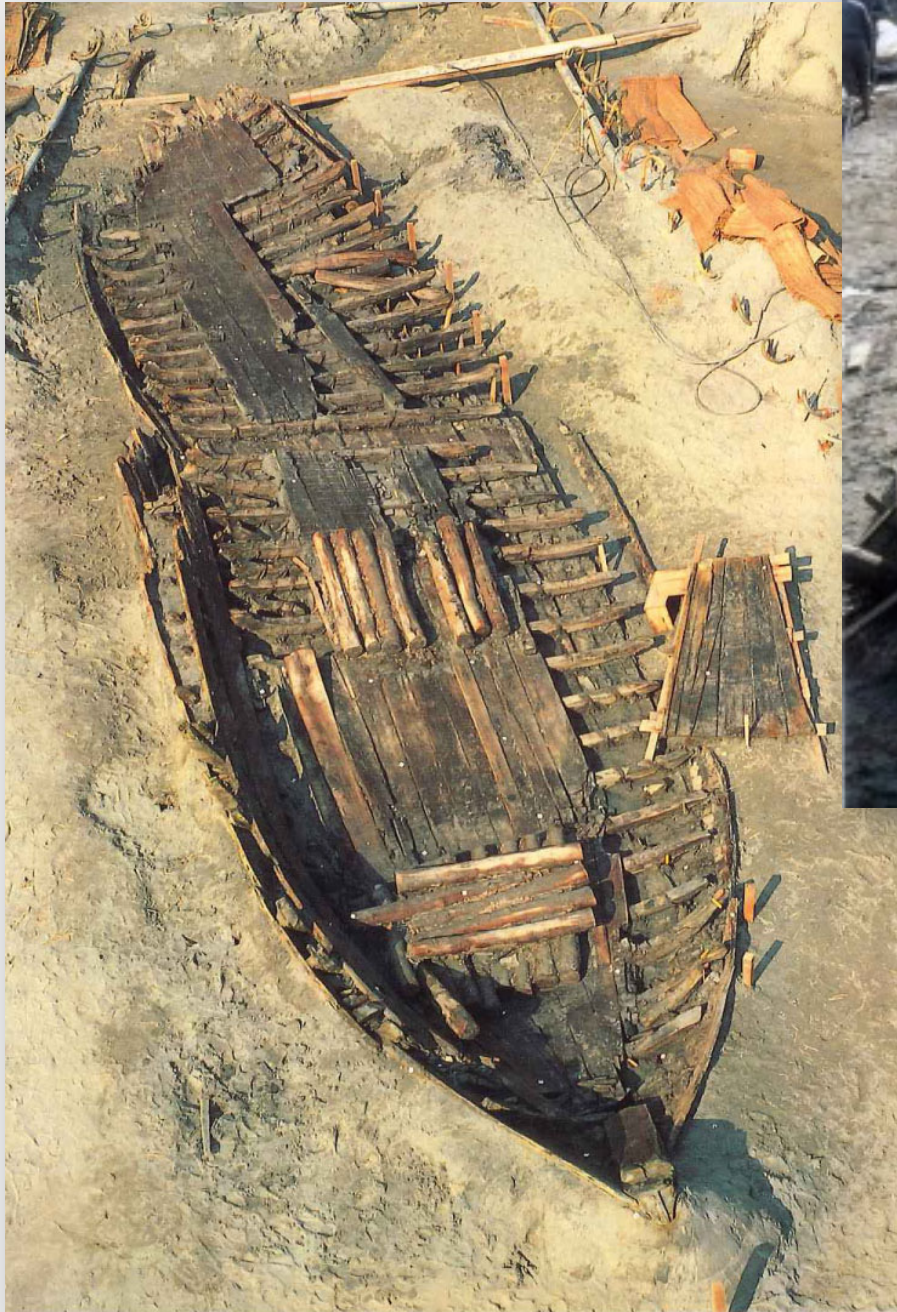

d'après Berti 1990

M. Bonino

Santa Maria in Padovetere, 5th c. AD



Cervia & Pomposa
7th c. AD?

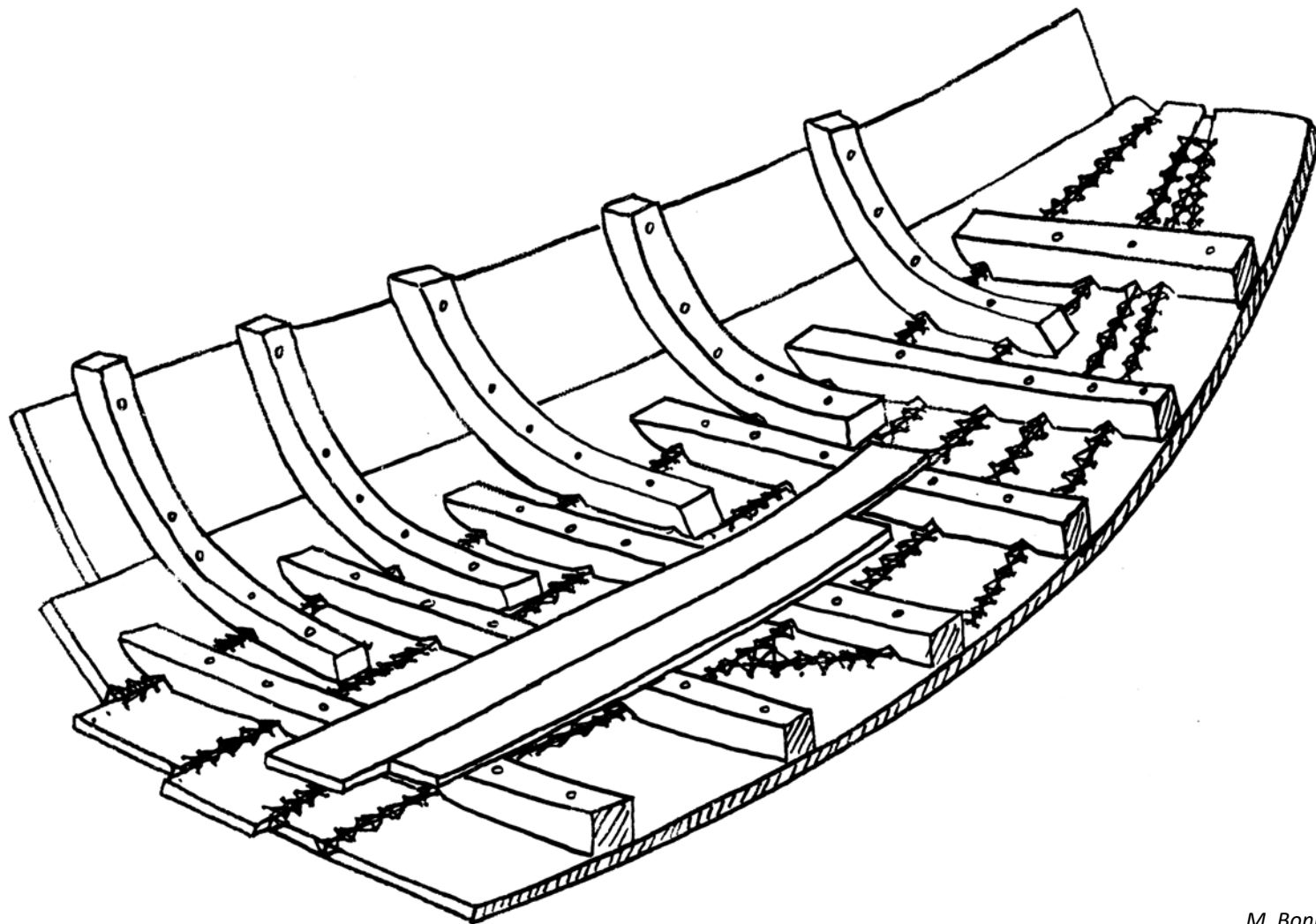

M. Bonino

Il Ponte di Borgo

Parco Teodorico, Ravenna
5th c. AD

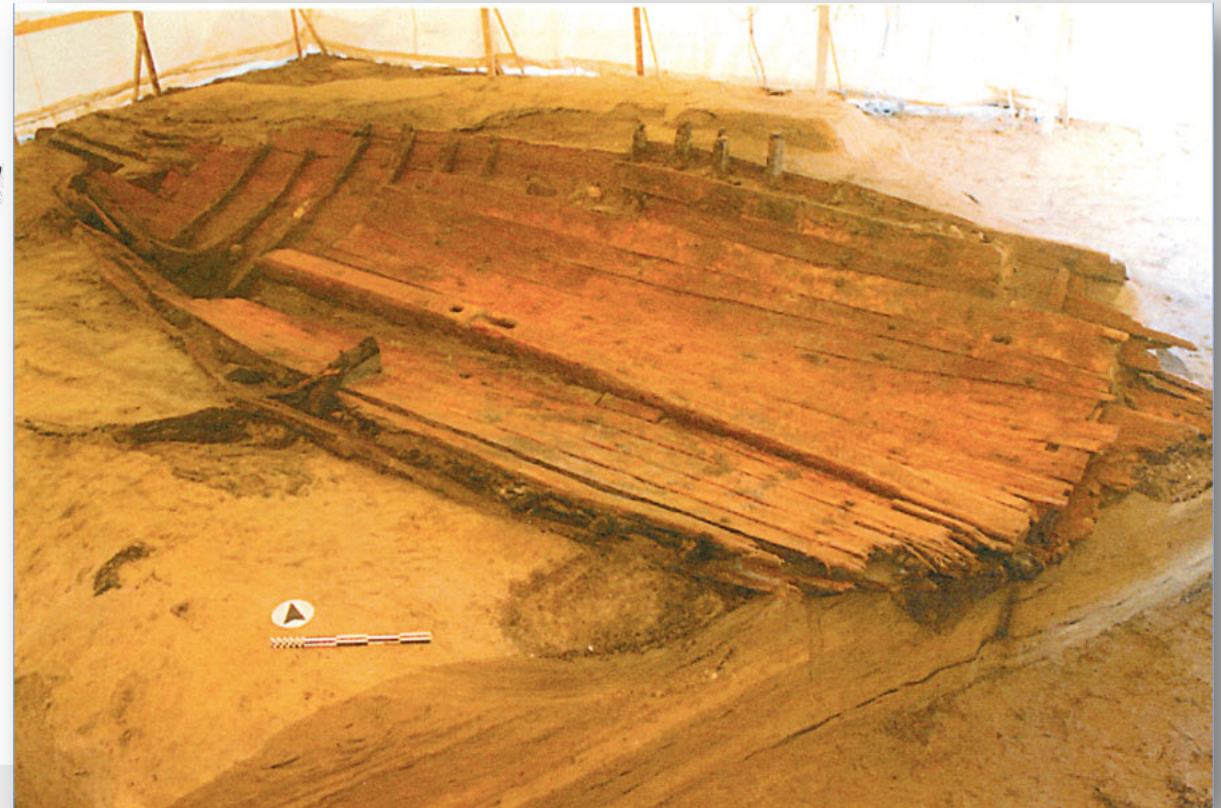
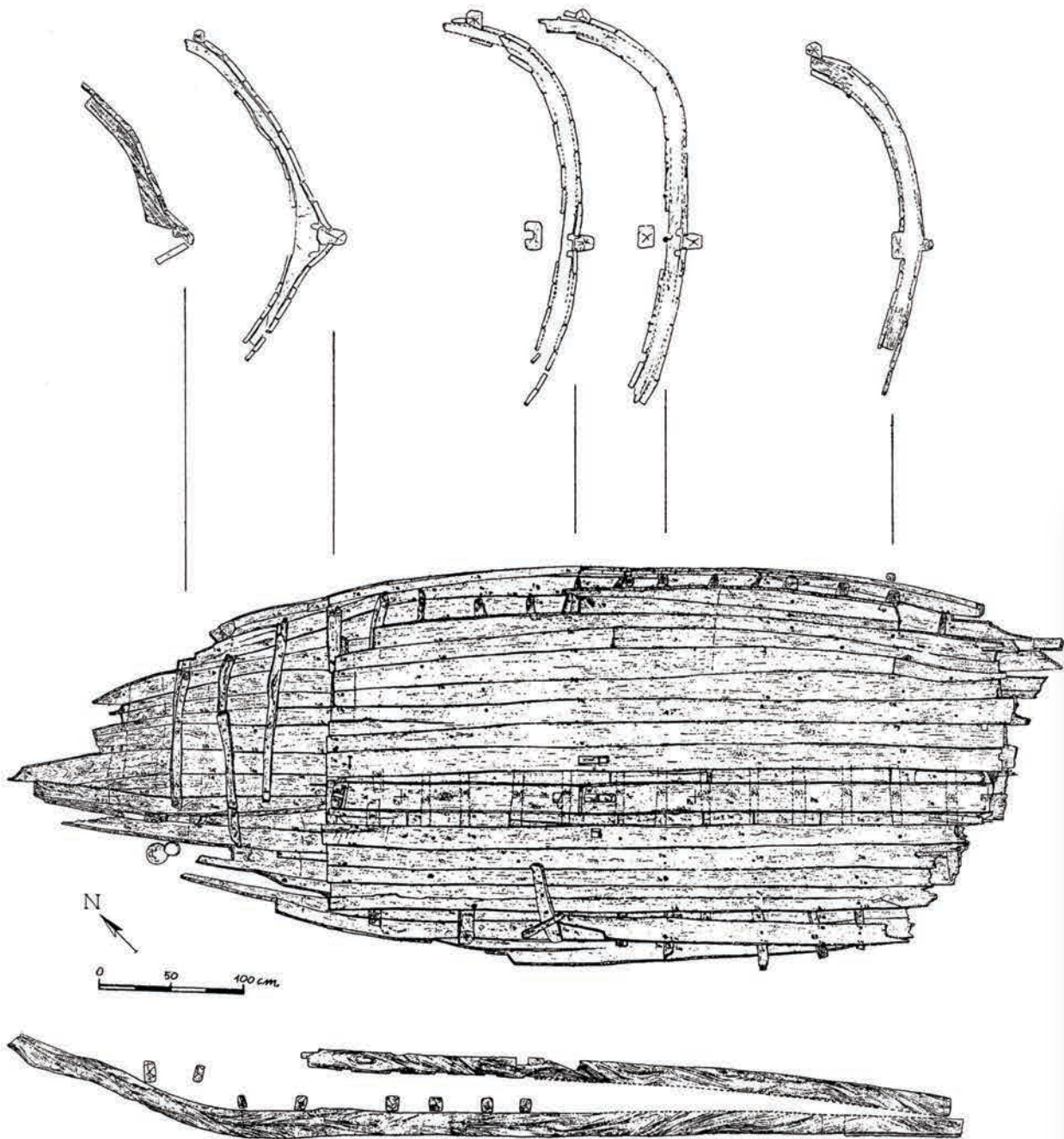



V. Dumās CNRS/CCJ



L. Damelet CNRS/CCJ



Ville de Pakostane

Pakostane (end 4th –beg. 5th c. AD)

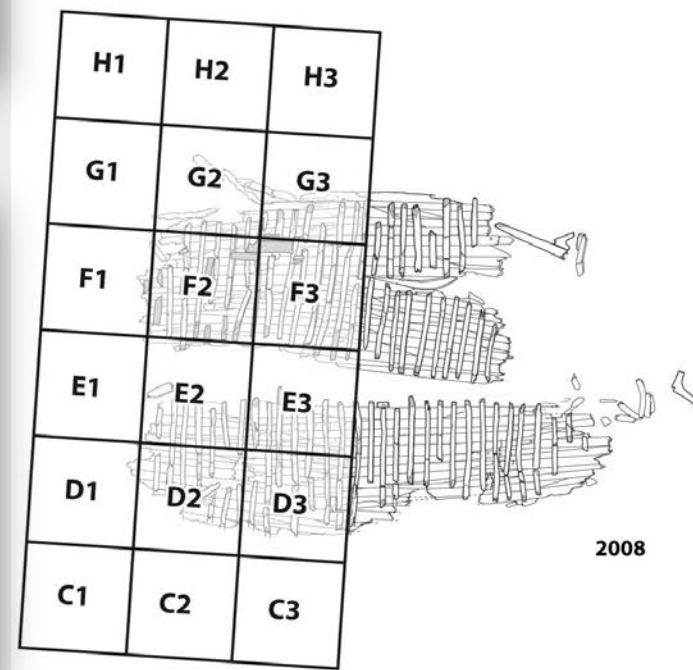
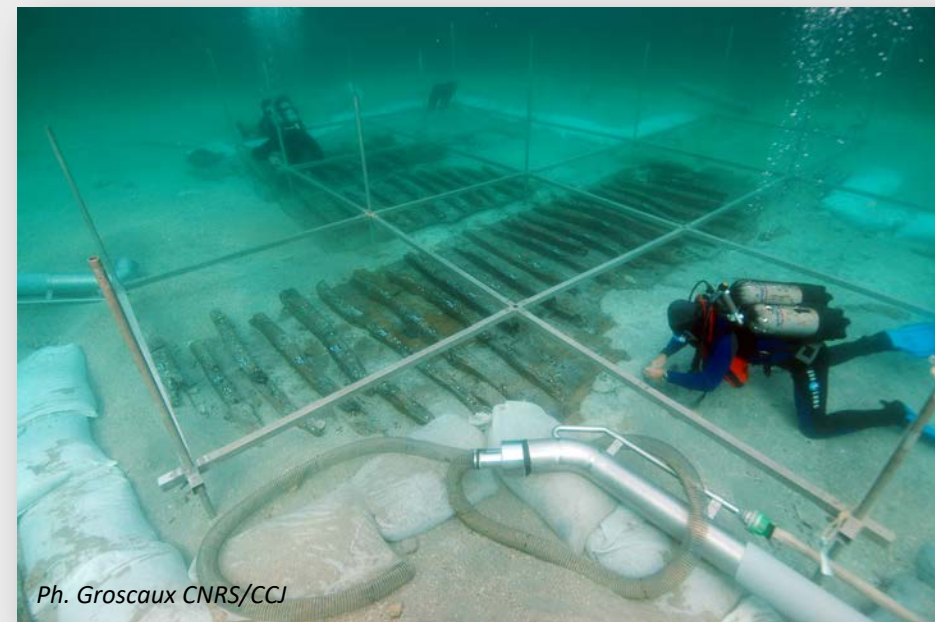
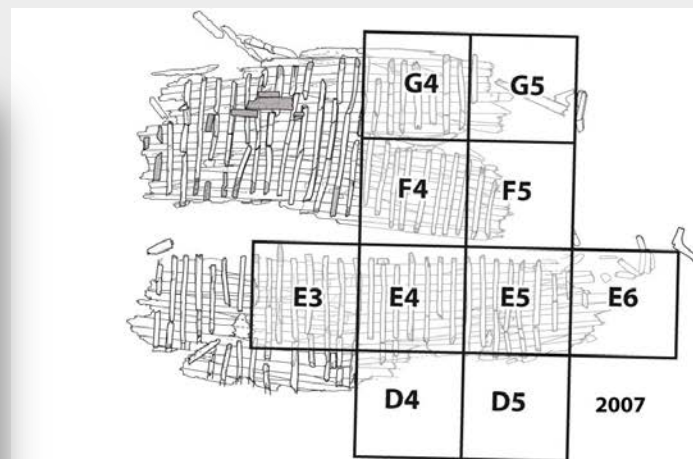

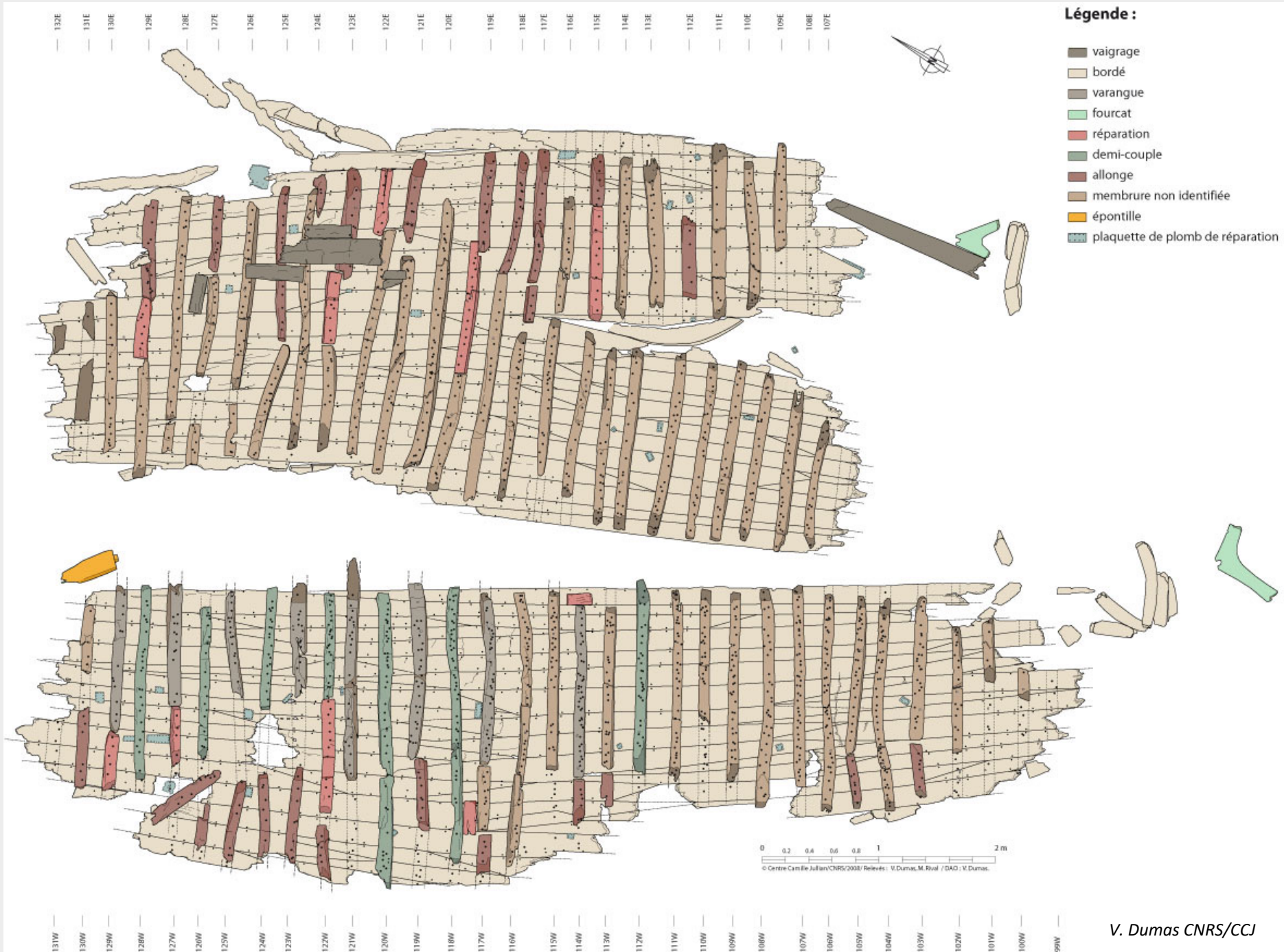



Ph. Groscaux CNRS/CCJ



Ph. Groscaux CNRS/CCJ

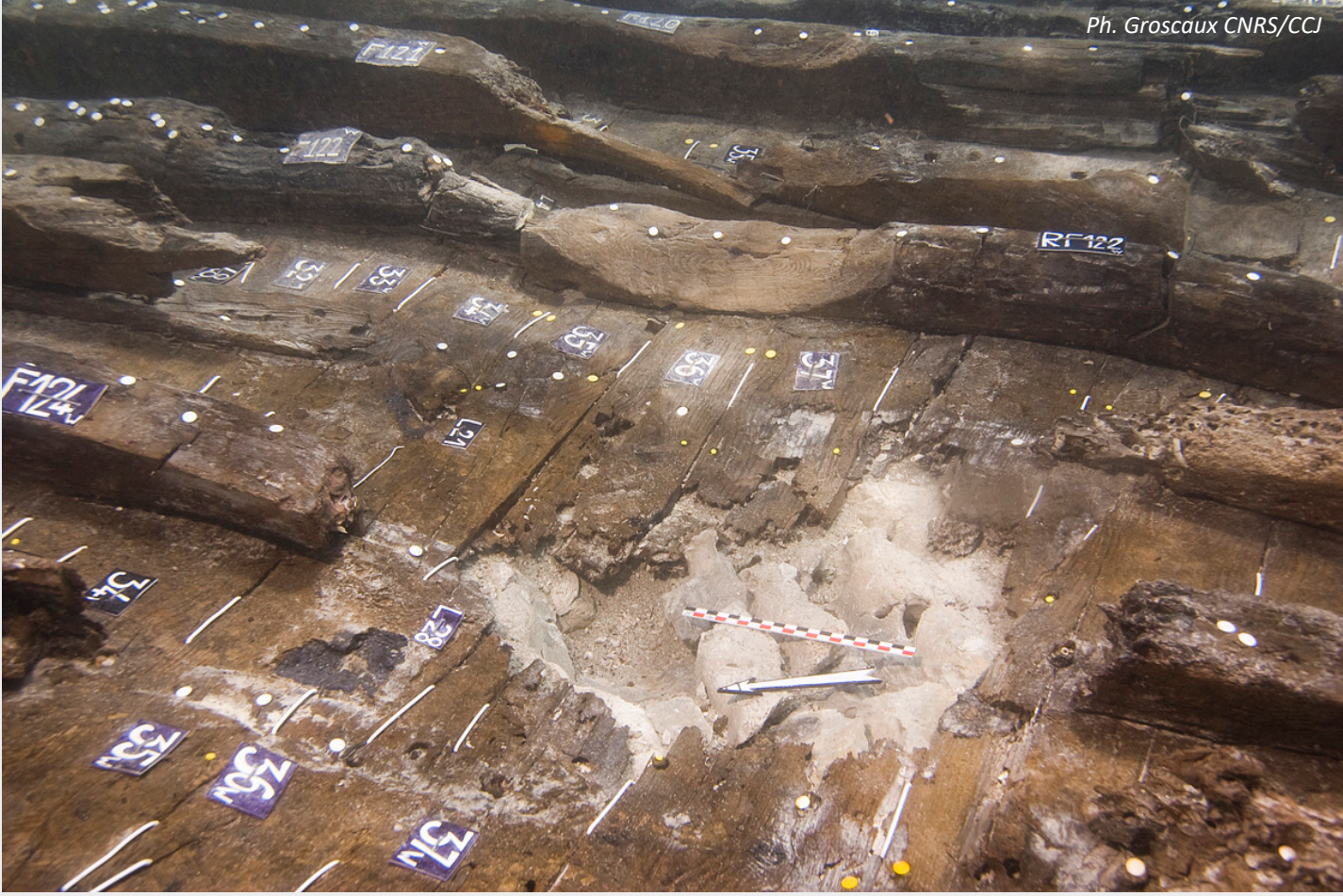

Ph. Groscaux CNRS/CCJ

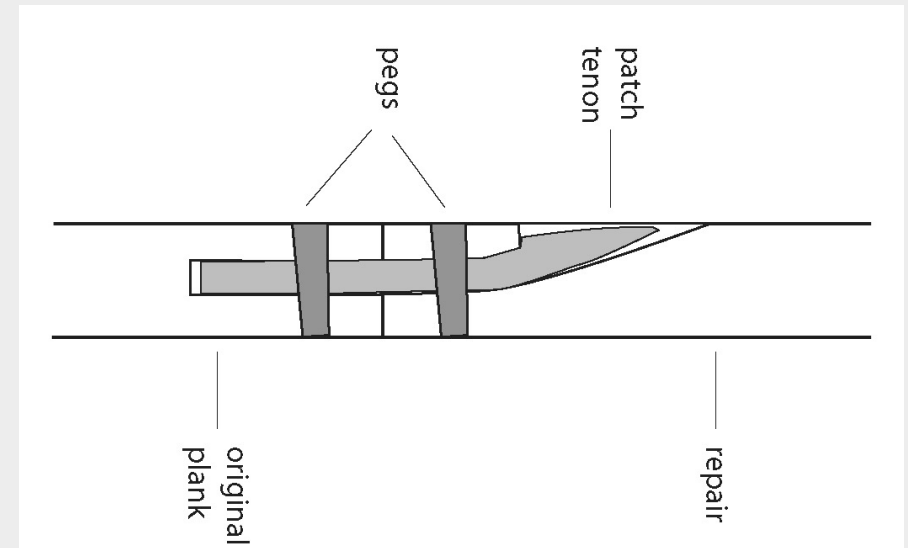
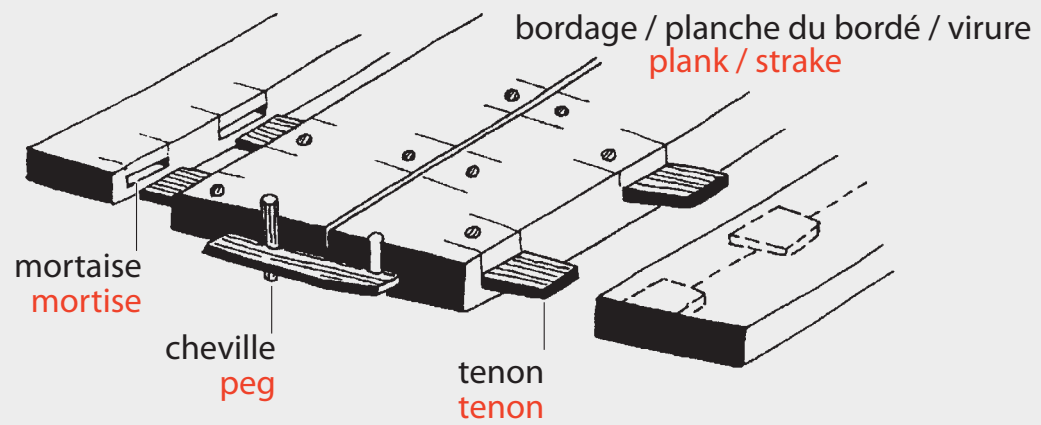



Ph. Groscaux CNRS/CCJ



Ph. Groscaux CNRS/CCJ



PK 08/108

Ph. Groscaux CNRS/CCJ



L. Damelet CNRS/CCJ



L. Damelet CNRS/CCJ



L. Damelet CNRS/CCJ

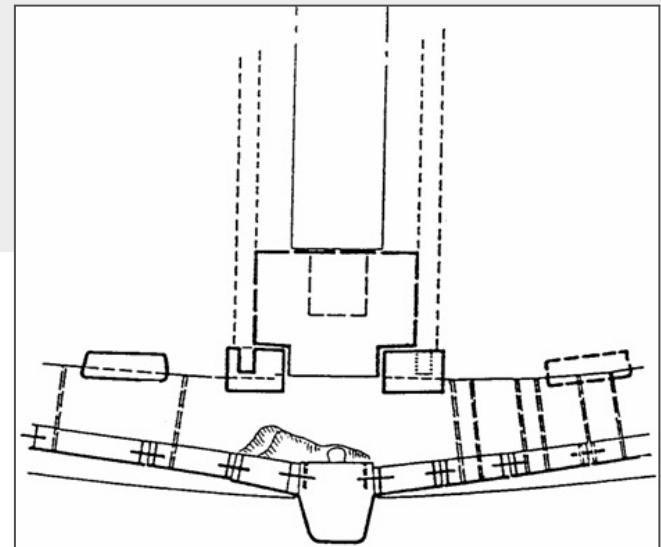
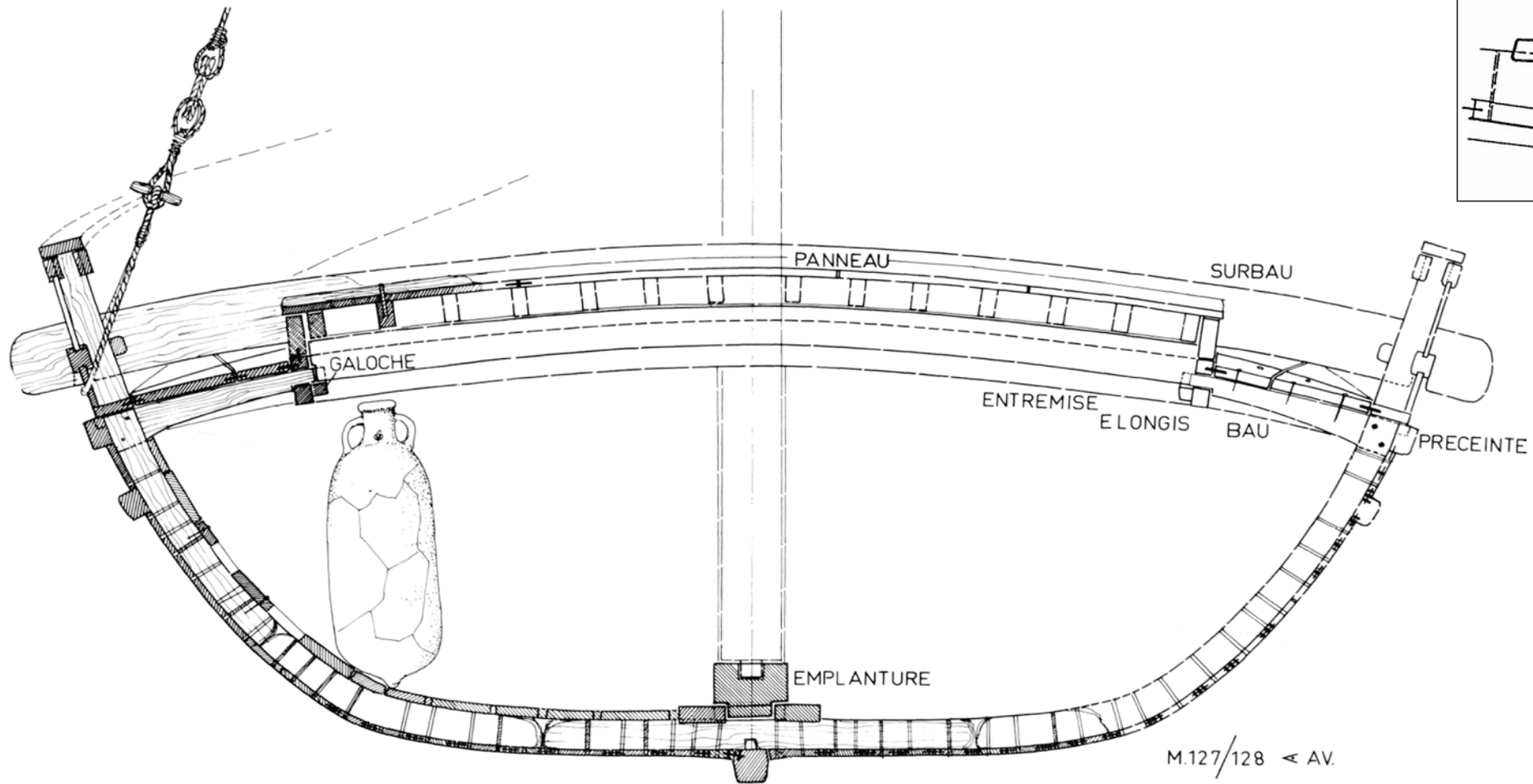

M.127/128 ← AV.

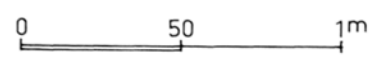

J.-M. Gassend CNRS/IRAA

Debeljak (end 4th –beg. 5th c. AD)



L. Damelet CNRS/CCJ



L. Damelet CNRS/CCJ



L. Damelet CNRS/CCJ



L. Damelet CNRS/CCJ



L. Damelet CNRS/CCJ

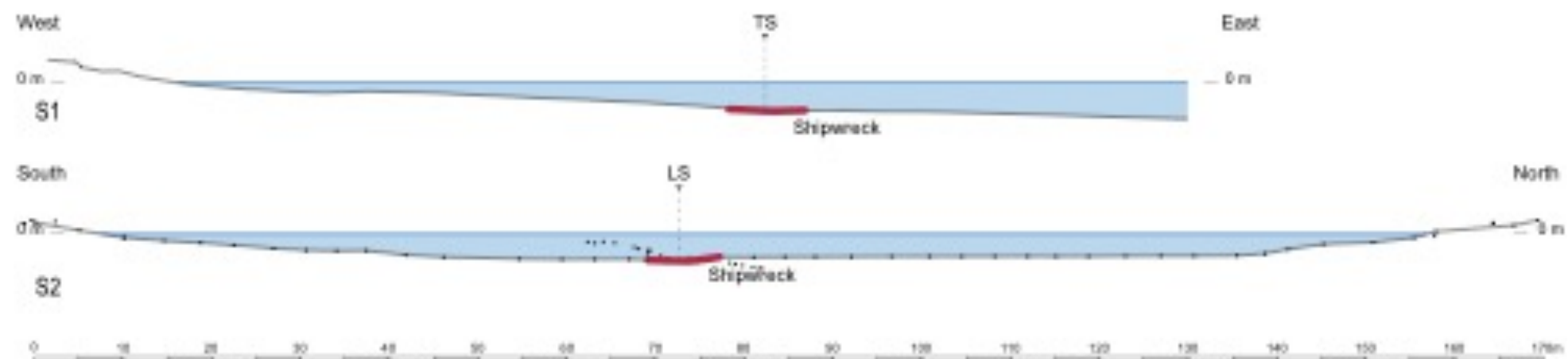
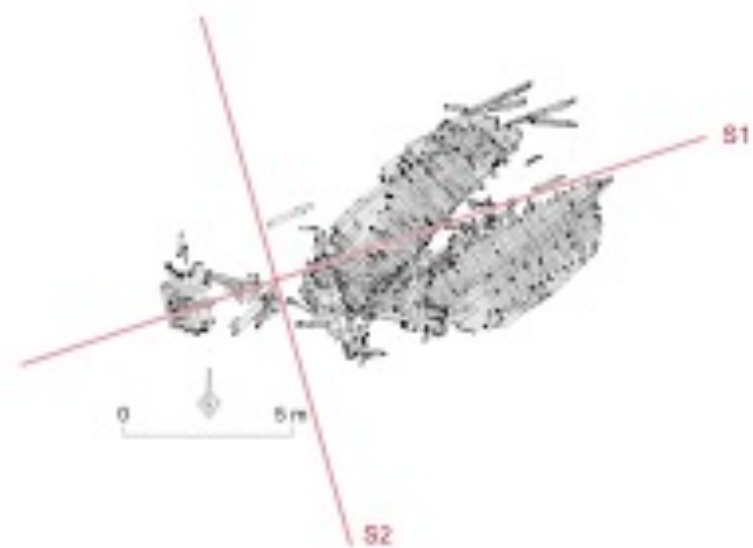

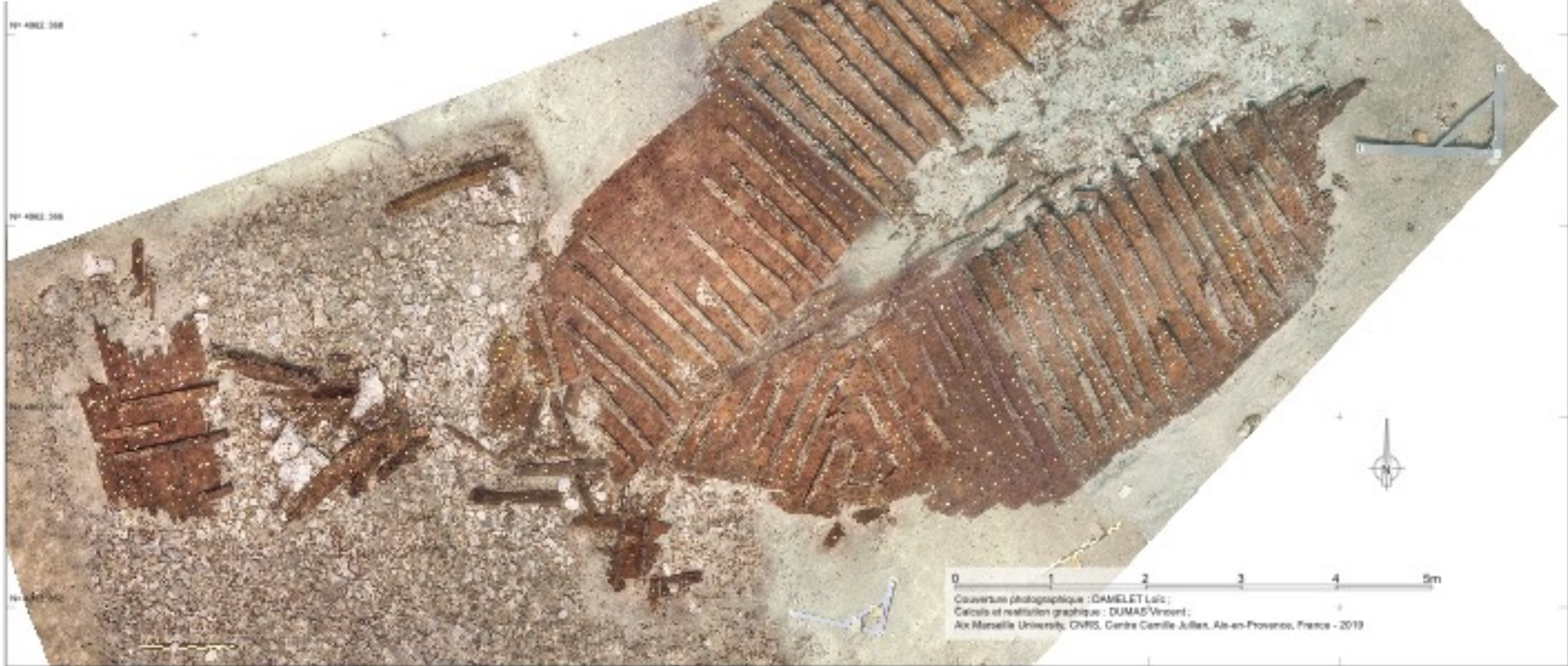
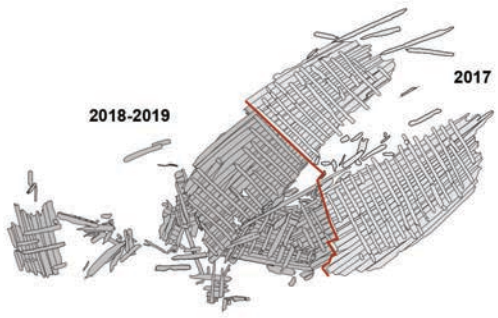

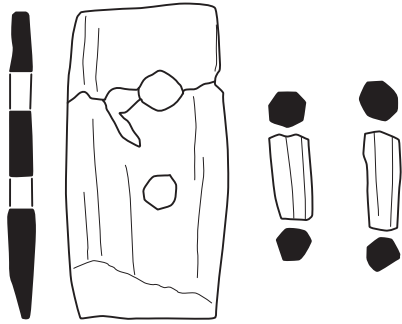

DE17 / W39a

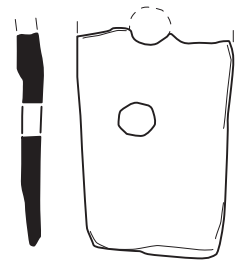

DE17 / W39b

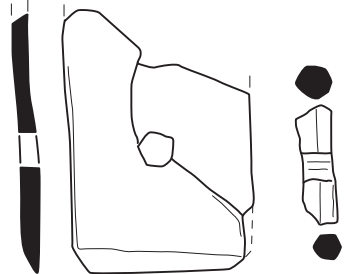

DE17 / W31



DE18 / N10

0 5cm
G. Boetto, CNRS, CCJ



DE18 / N9

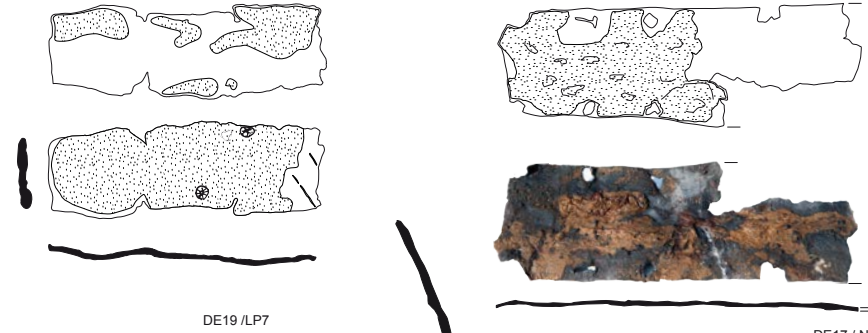

DE19 / LP7



DE19 / LP3

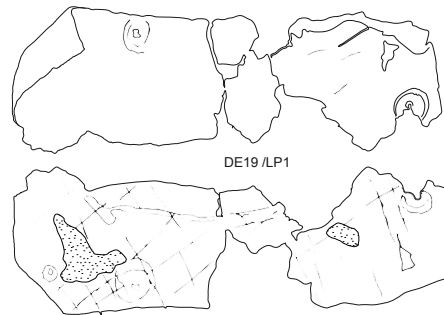

DE19 / LP1

pitch
0 5cm
G. Boetto, P. Poveda, CNRS, CCJ

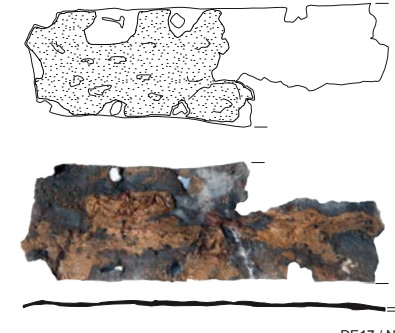

DE17 / N36

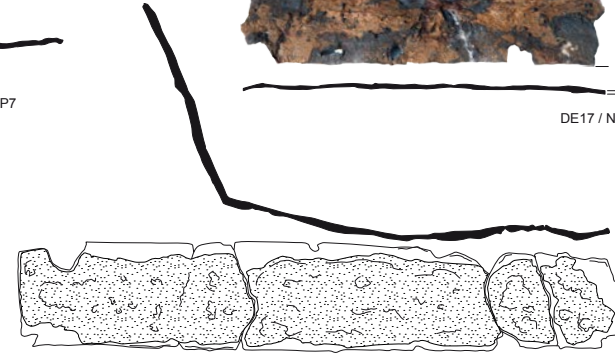

DE17 / N28



DE17 / N32

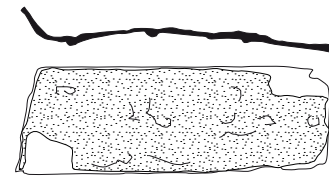

DE17 / I. N.

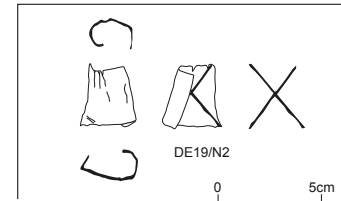

0 5cm

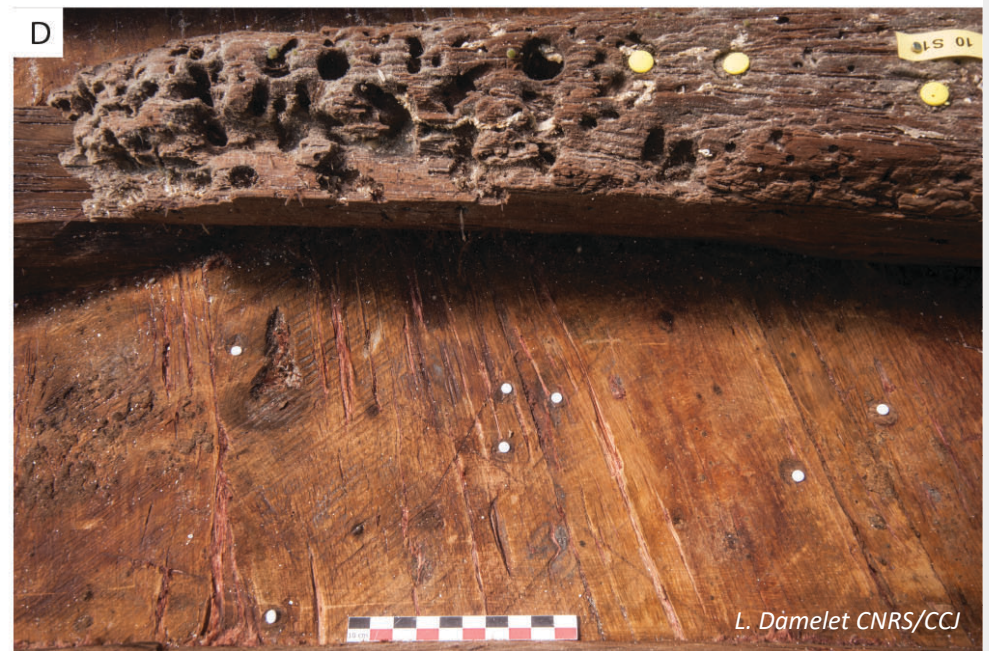

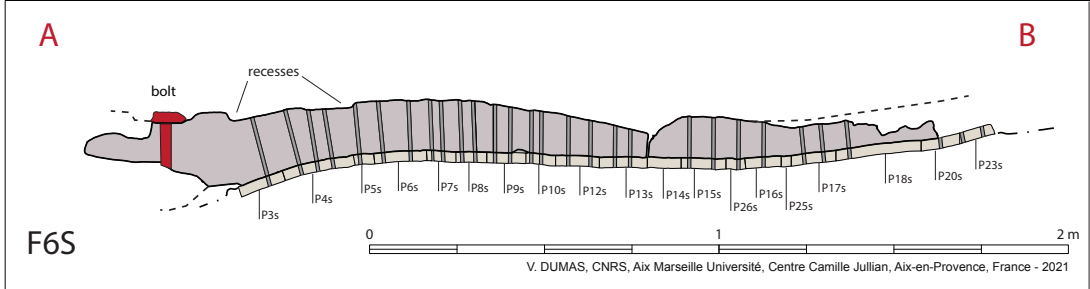

F6S

B

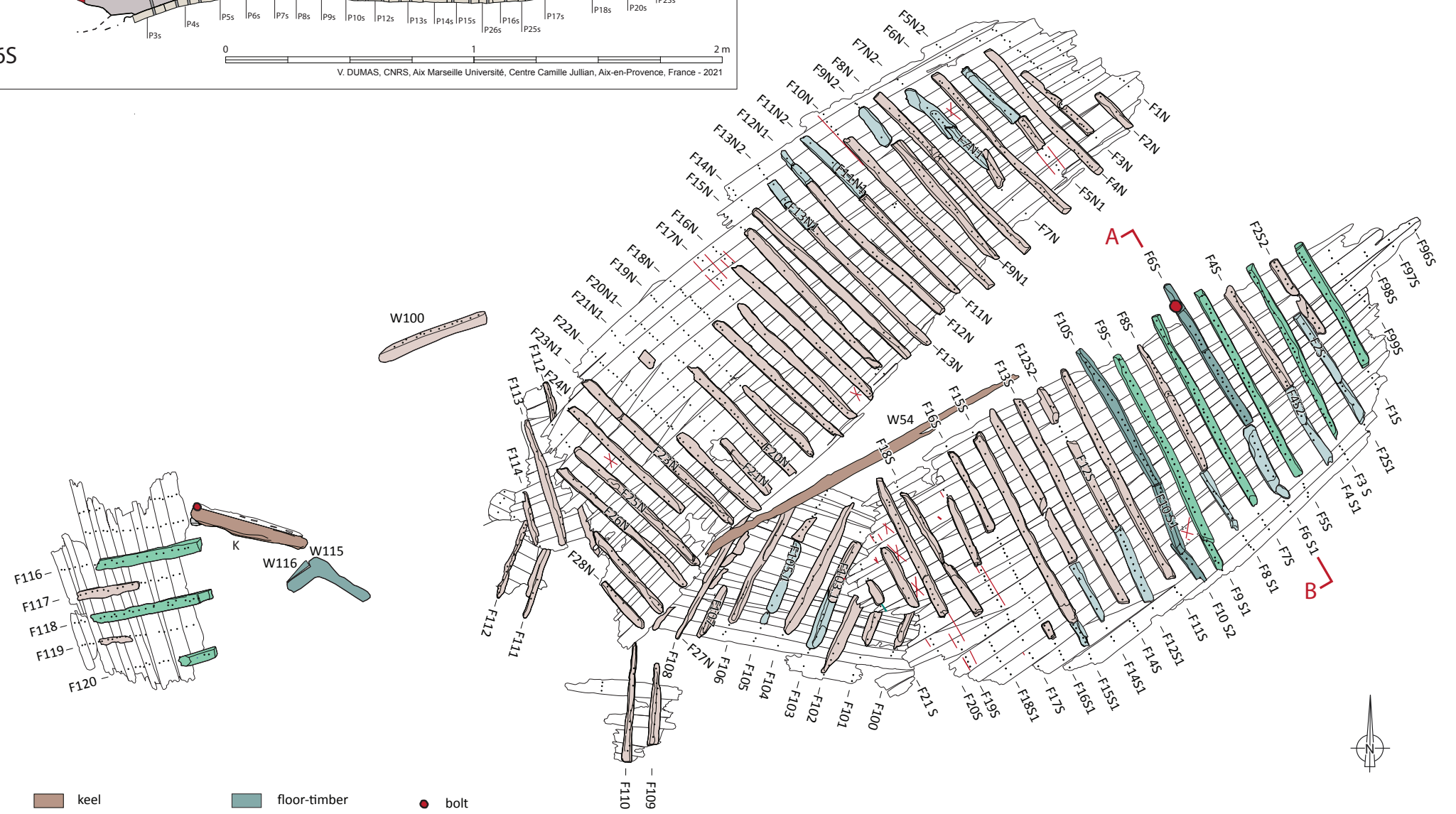

- keel
- floor-timber
- bolt
- planking
- half-frame
- treenail
- frame not id.
- futtock
- carpenter mark



Couverture photographique : L. DAMELET ; calculs et restitution graphique : V. DUMAS
CNRS, Aix Marseille Université, Centre Camille Jullian, Aix-en-Provence, France - 2019





0 5 cm

L. Damelet CNRS/CCJ



L. Damelet CNRS/CCJ



L. Damelet CNRS/CCJ

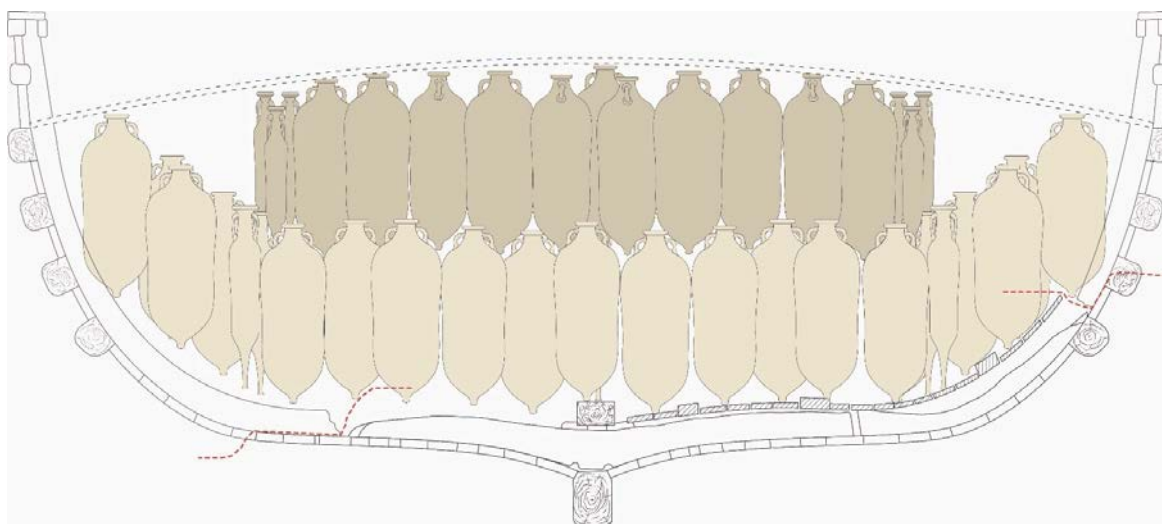
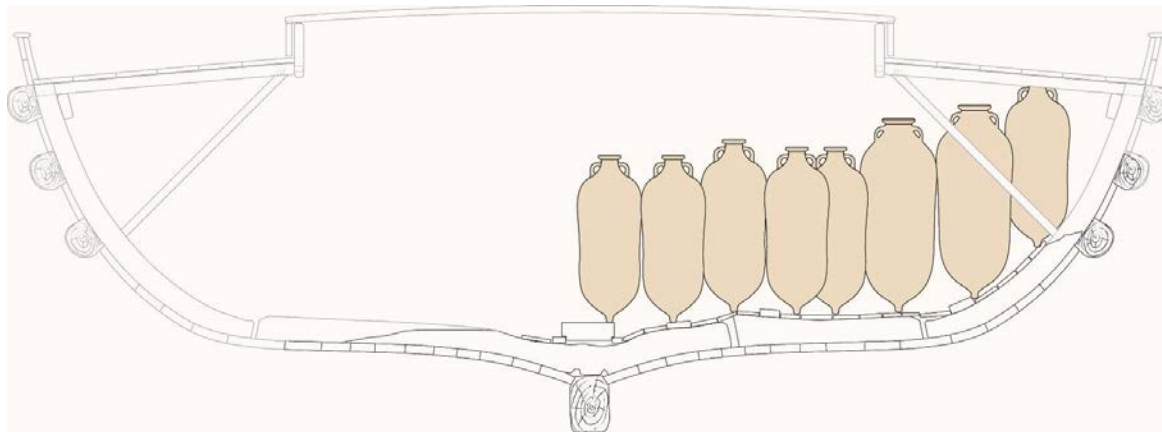

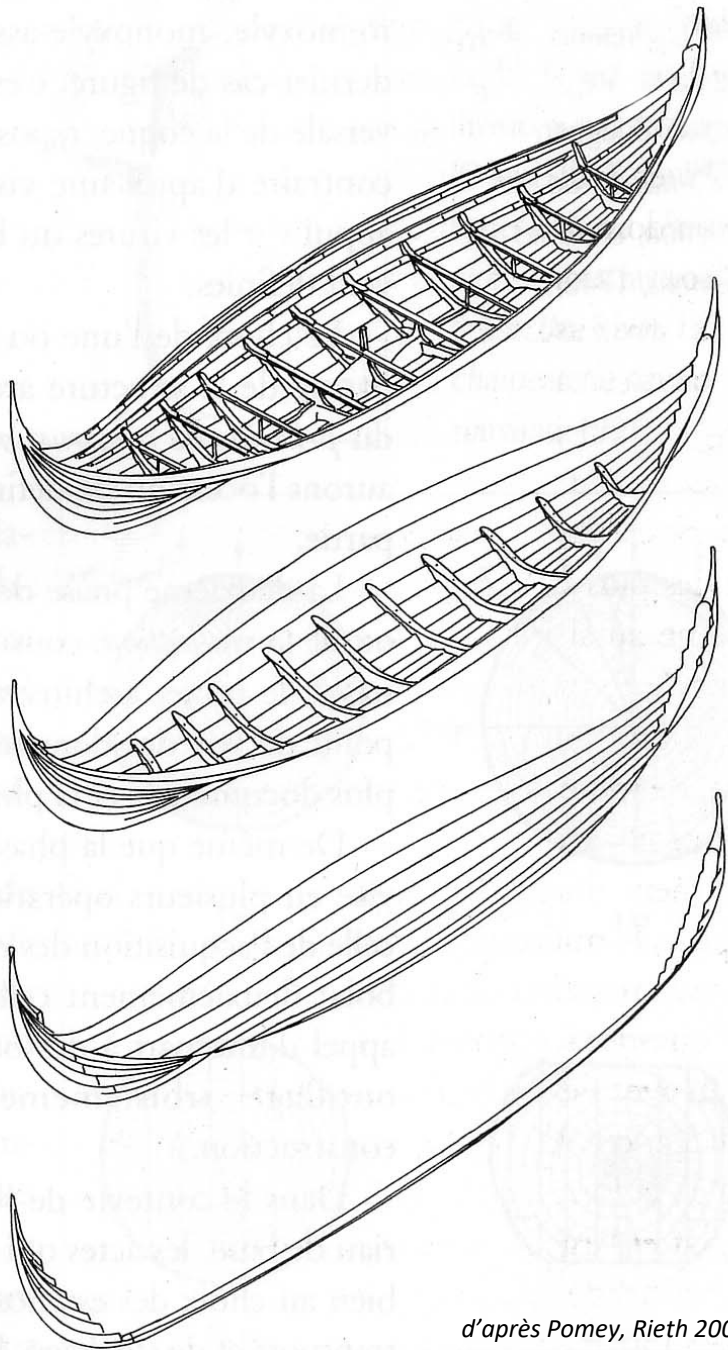

d'après Pomey, Rieth 2005





**Merci de votre
attention !**