



**HAL**  
open science

## Céramique et terres cuites de Soknopaiou Nesos : croisement des données

Delphine Dixneuf

► **To cite this version:**

Delphine Dixneuf. Céramique et terres cuites de Soknopaiou Nesos : croisement des données. Master. Université de Toulouse, France. 2022. halshs-04064301

**HAL Id: halshs-04064301**

**<https://shs.hal.science/halshs-04064301>**

Submitted on 11 Apr 2023

**HAL** is a multi-disciplinary open access archive for the deposit and dissemination of scientific research documents, whether they are published or not. The documents may come from teaching and research institutions in France or abroad, or from public or private research centers.

L'archive ouverte pluridisciplinaire **HAL**, est destinée au dépôt et à la diffusion de documents scientifiques de niveau recherche, publiés ou non, émanant des établissements d'enseignement et de recherche français ou étrangers, des laboratoires publics ou privés.

Copyright

# Céramique et terres cuites de Soknopaiou Nesos : croisement des données

Delphine Dixneuf

Aix Marseille Univ, CNRS, LA3M, Aix-en-Provence, France



- **Delphine Dixneuf**, « Introduction à la céramique de Soknopaiou Nesos », dans M. Capasso et P. Davoli (dir.), Soknopaiou Nesos Project I (2003-2009), Biblioteca degli « Studi di Egittologia e di Papirologia 9, Pise-Rome, 2012, p. 315-361.

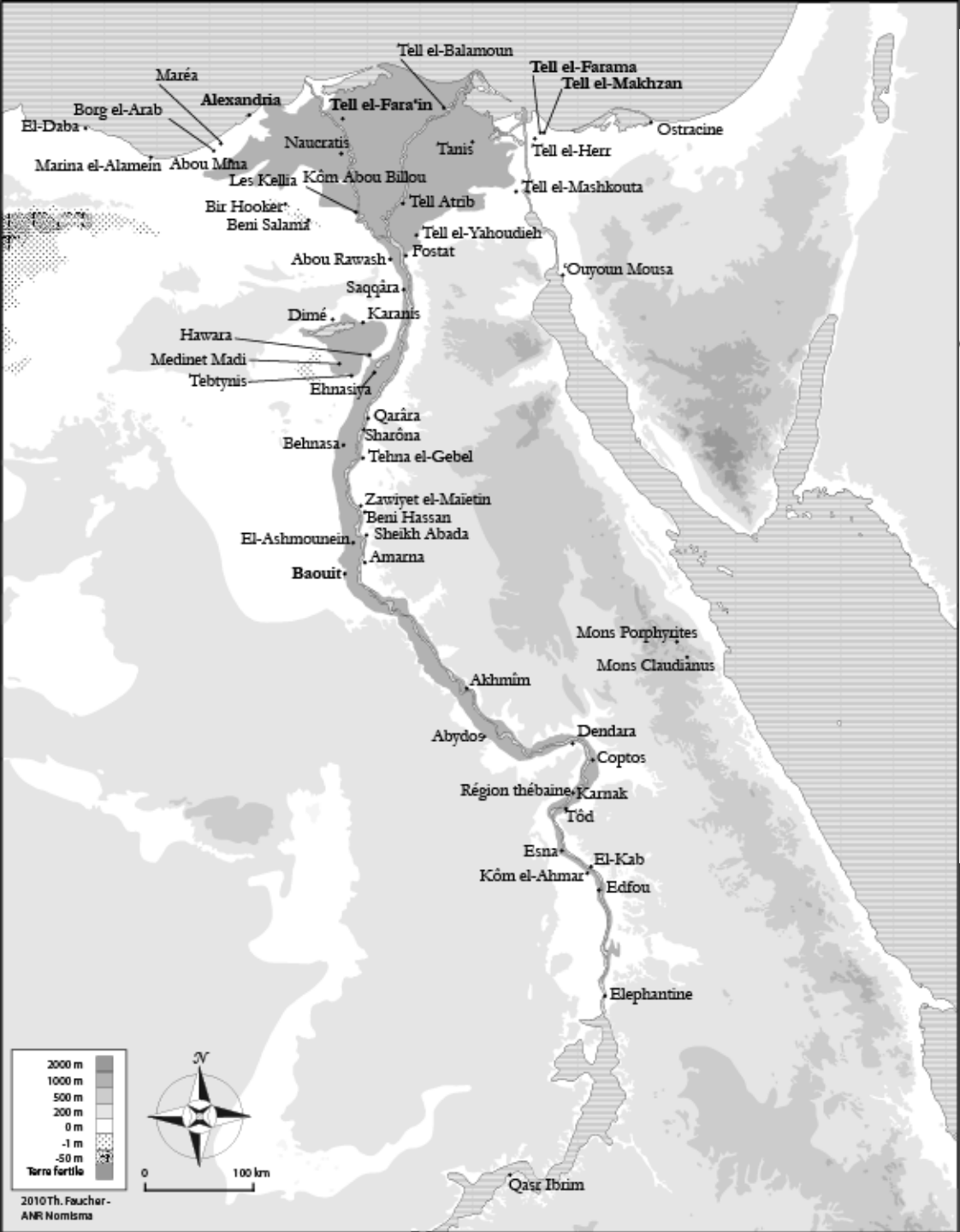

Carte du Fayoum à l'époque gréco-romaine  
(d'après Davoli 1998, p. 33, fig. 1)

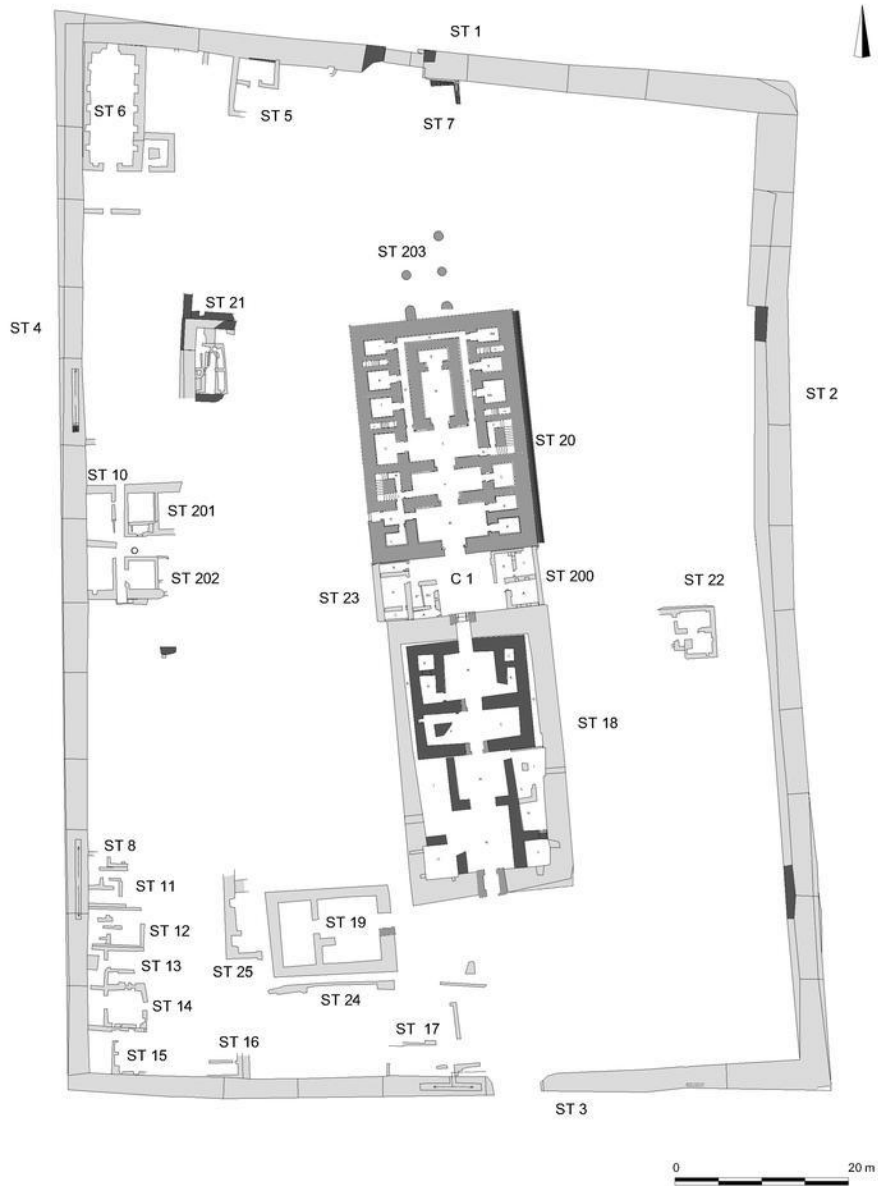

Site of Soknopaïou Nesos from the SE (dominated by the temple of Soknopaïos) © The Soknopaïou Nesos Project, University of Salento  
<https://www.universiteitleiden.nl/en/research/research-projects/humanities/text-in-context#tab-1>

Plan du temple (Davoli, Miks 2015)

# Céramiques et amphores importées

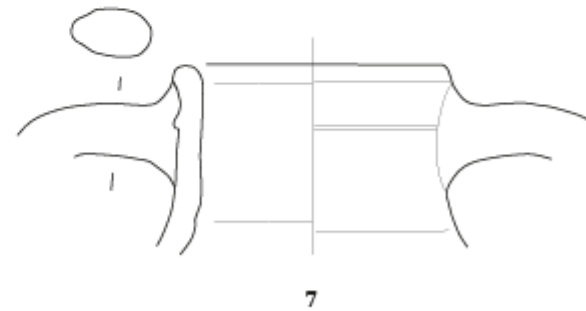
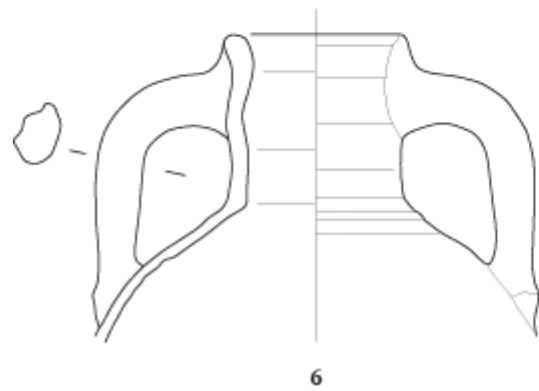
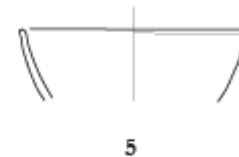
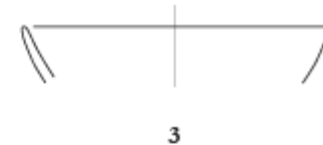
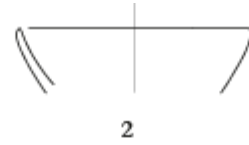
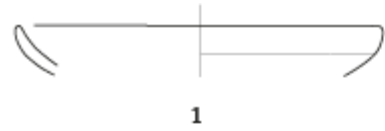

0 8 cm

# Céramiques et barillets d'Assouan et/ou des Oasis

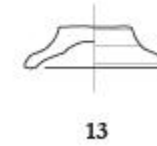
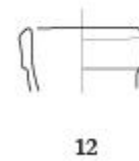
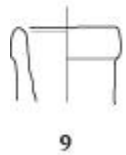
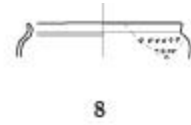

0 8 cm

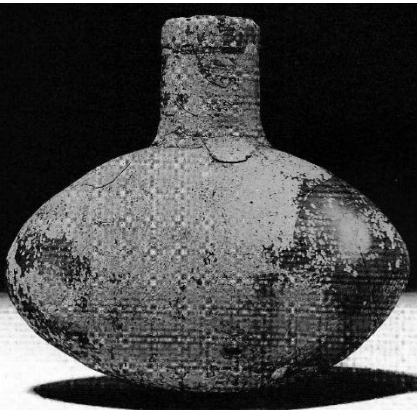

Barillet découvert à Hawara et conservé au British Museum (Bailey 1998, pl. 135)

# Amphores AE 1 et AE 2

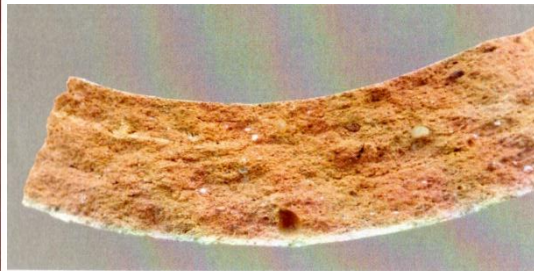
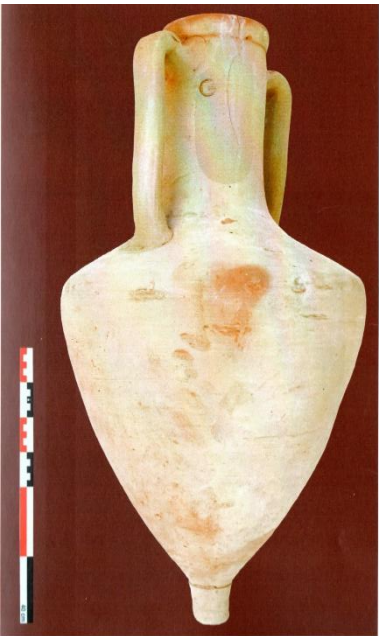
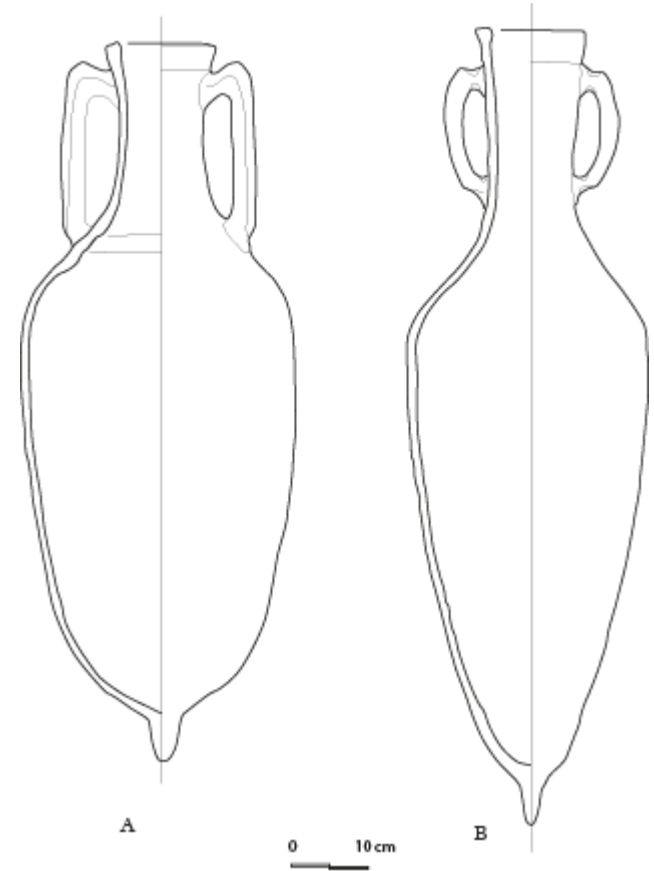
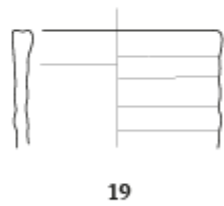
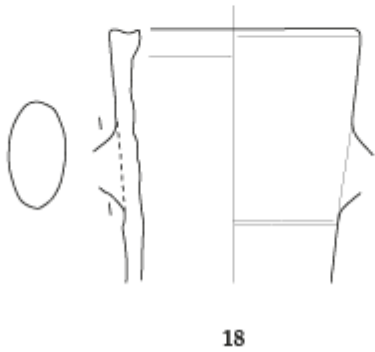
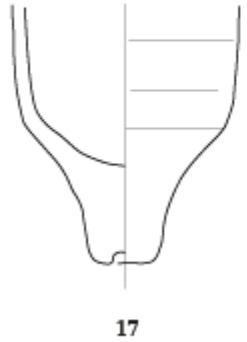
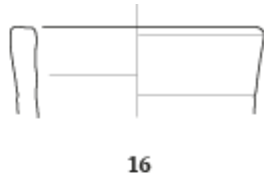
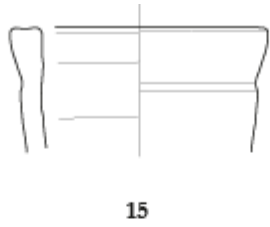
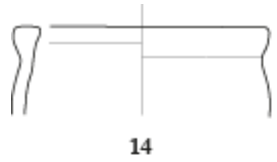

Amphore AE 1 produite à Philadelphie  
(Marchand, Chang, Nannucci 2018)

Amphores AE 2 produites à Tell el-Haraby  
(Majcherek, Shennawi 1991)



# Amphores AE 4 et AE 3

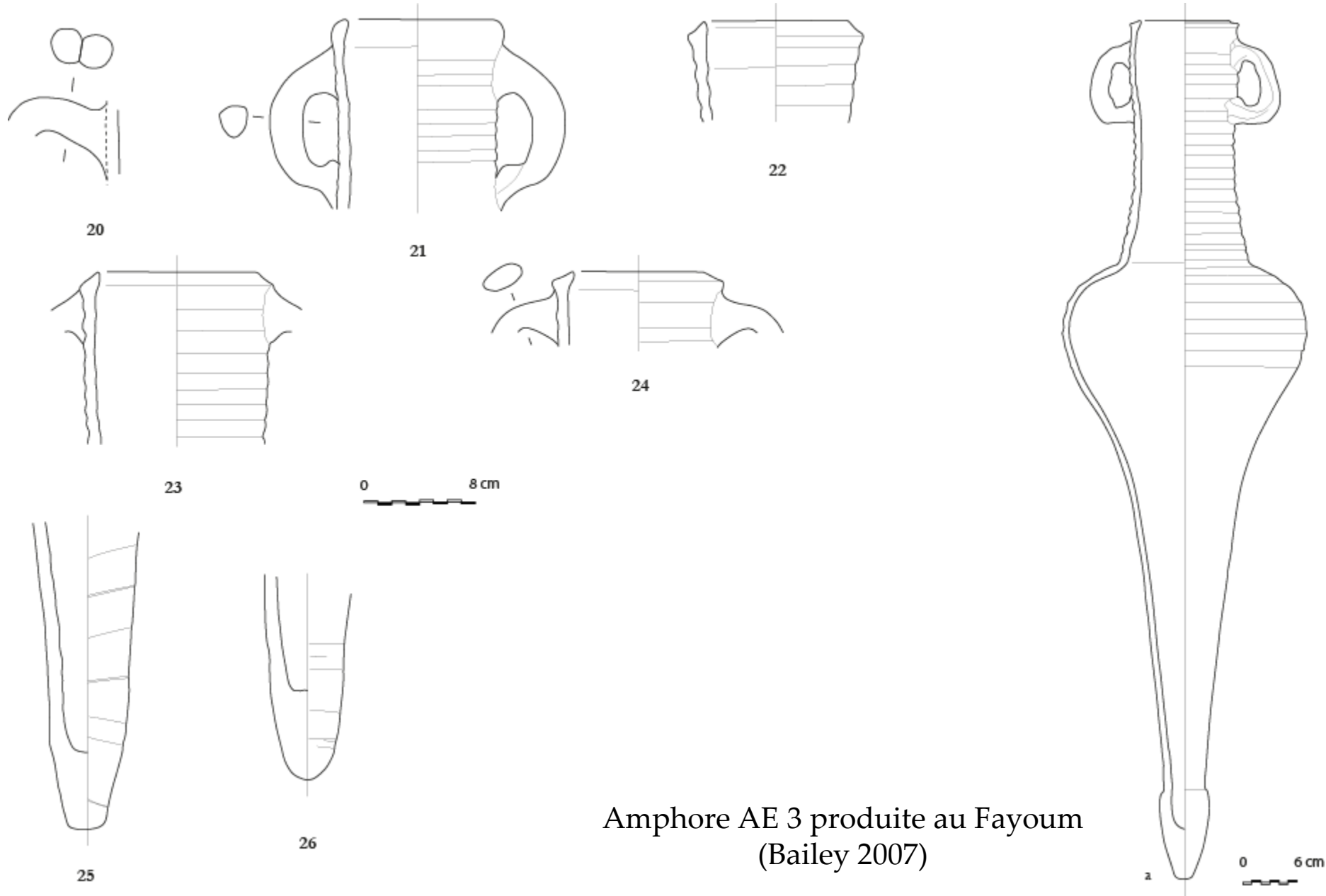

Amphore AE 3 produite au Fayoum  
(Bailey 2007)

# Amphores LRA 7/AE 7

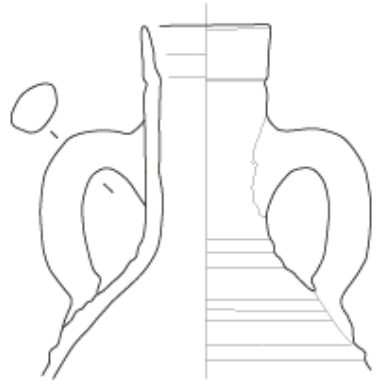

27



28

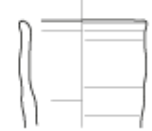

29

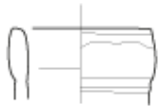

30



31



32

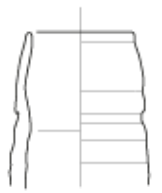

33



34

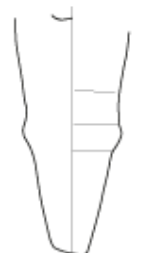

35

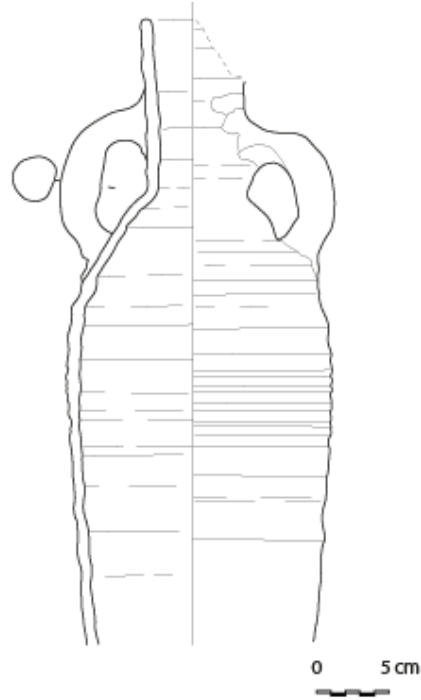

Amphore découverte  
à Alexandrie



Amphores découvertes à Baouît

# Jarres de stockage et vases à liquide

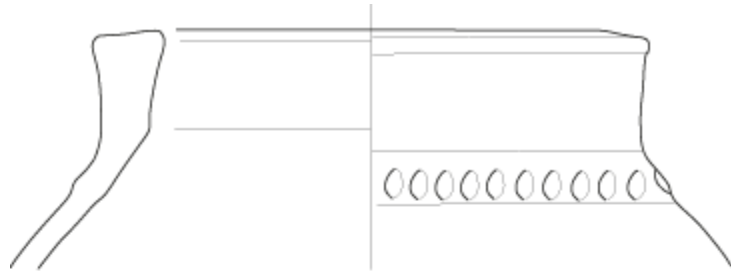

36

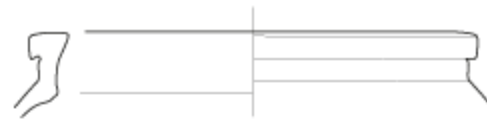

37



38



39



40



41

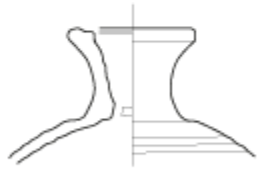

42



43



44



45



46



47



48



49



50



51



# Dokka, larges coupes, cratères et bols

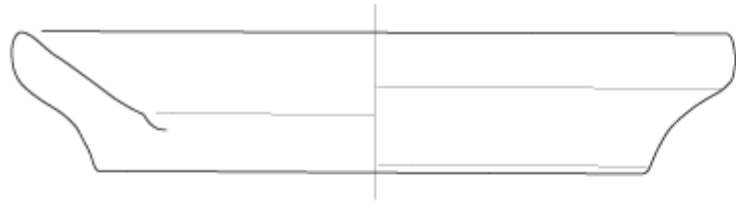

52



53

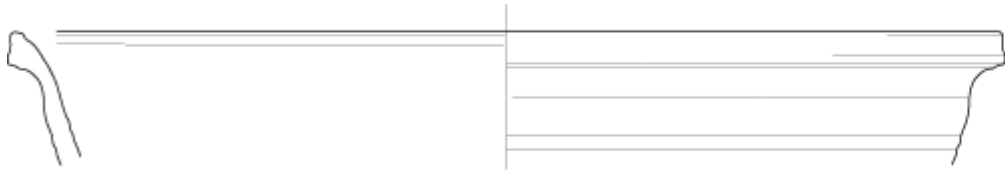

54

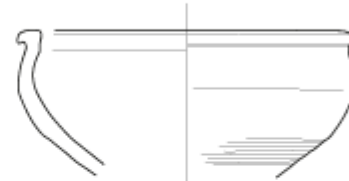

55



56

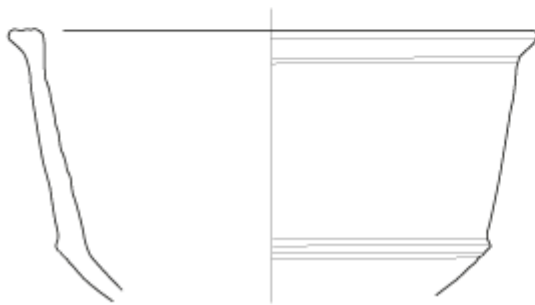

57

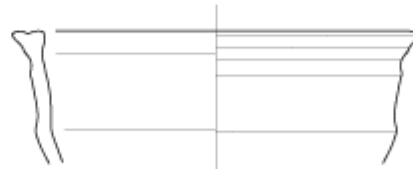

58



Coupe carénée à décor peint  
découverte à Baouît

# Bols convexes

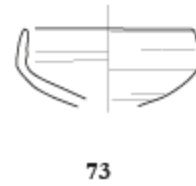
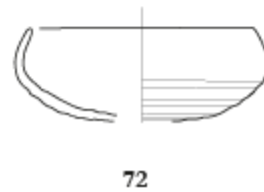
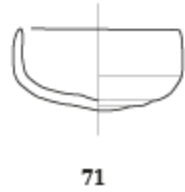
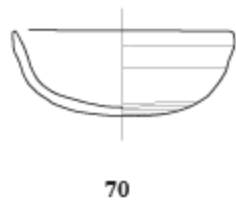
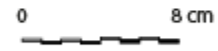
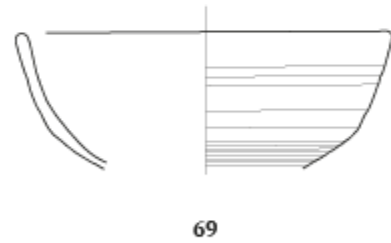
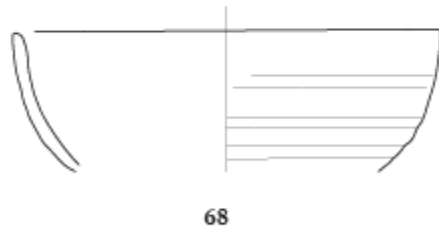
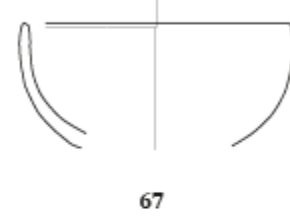
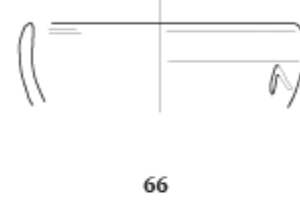
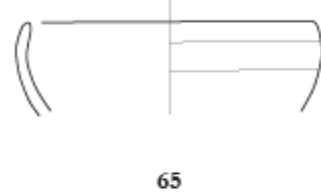
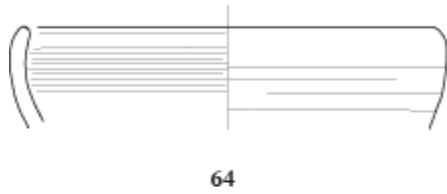
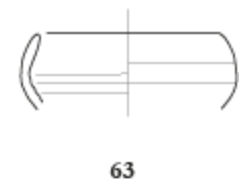
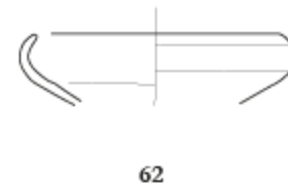
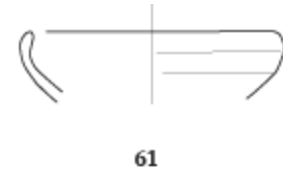
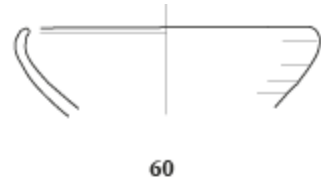
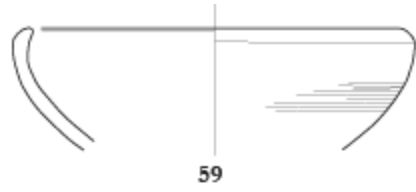

# Coupelles et assiettes

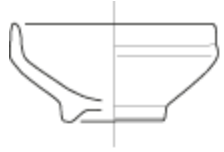

74

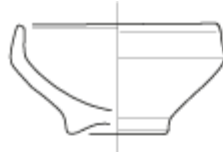

75

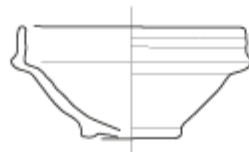

76



77

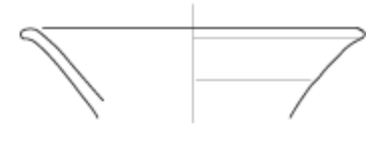

78



79



80



81

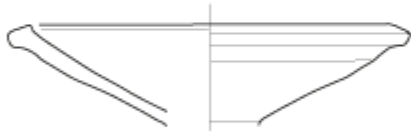

82



83



84



85



86



87

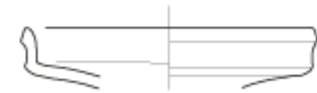

88



# Céramiques de forme ouverte du groupe K/K'

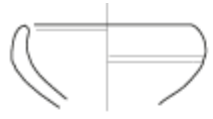

89



90



91

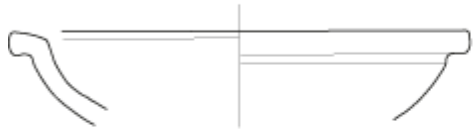

92



93

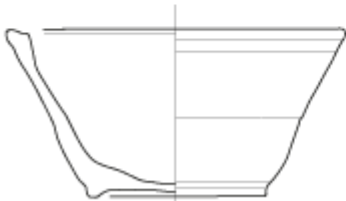

94



95



Coupes du groupe K/K'  
découvertes à Baouît

# Plats de cuisson, caquelons et marmites



96

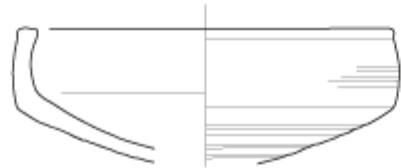

97



98



99



100



101



102

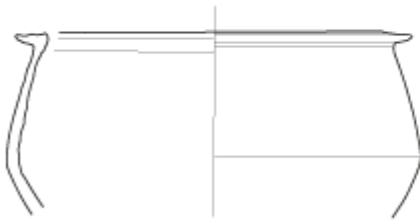

103

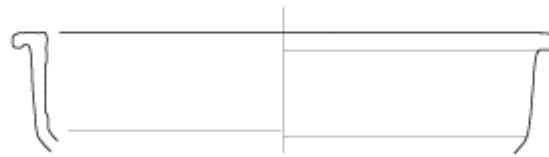

104

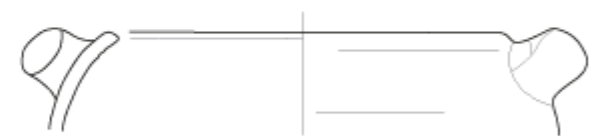

105



106



107





# Marmites



108

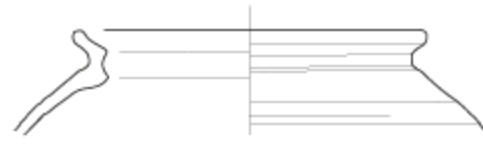

109



110



111

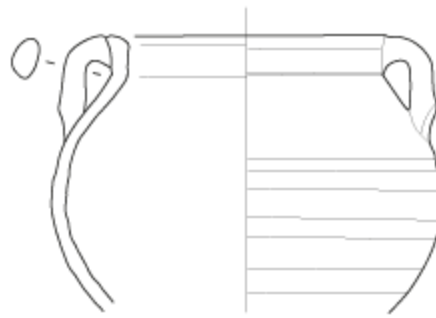

112

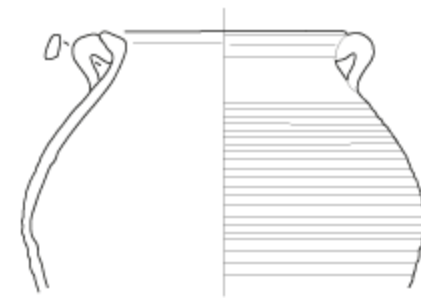

113

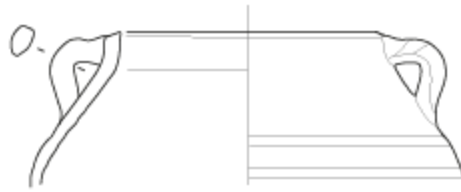

114

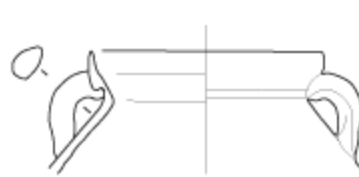

115

0 8 cm

# Lampe-coupelles



116



117



118



119



120



121



122

0 8 cm

# Lampes moulées hellénistiques et romaines

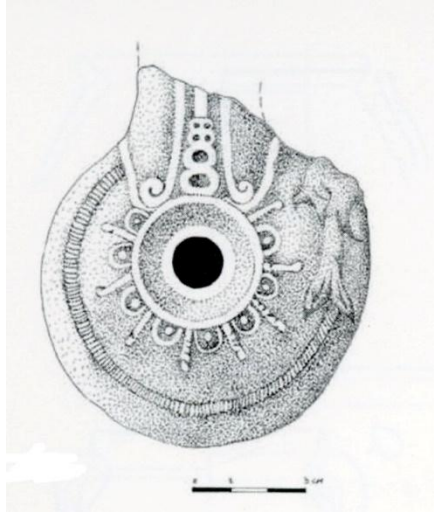

123

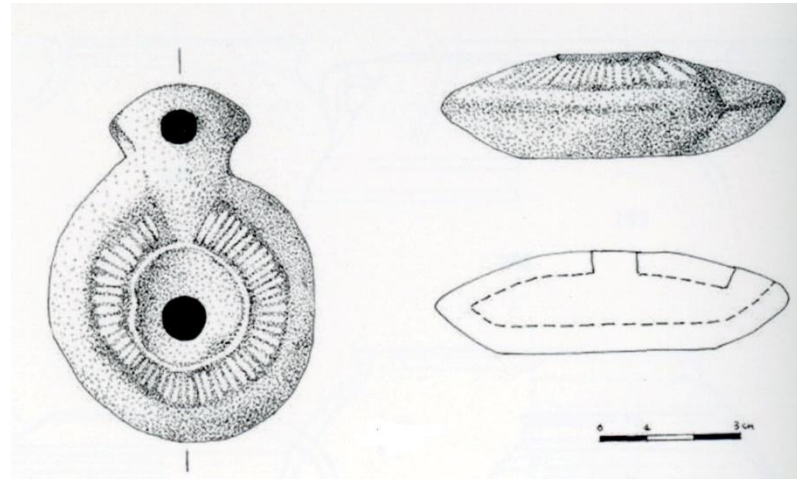

124

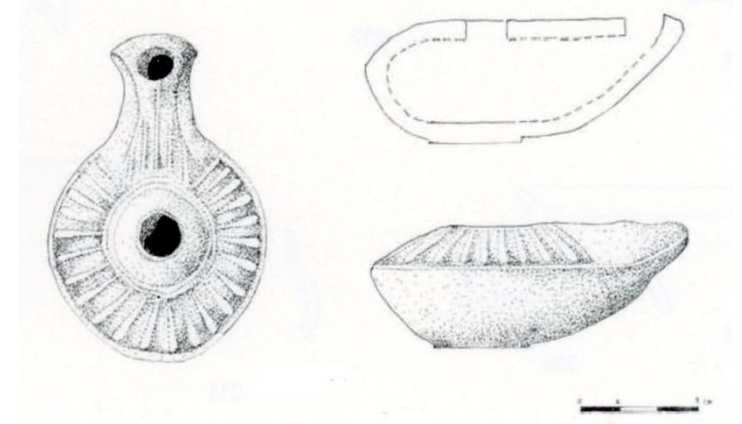

125



126

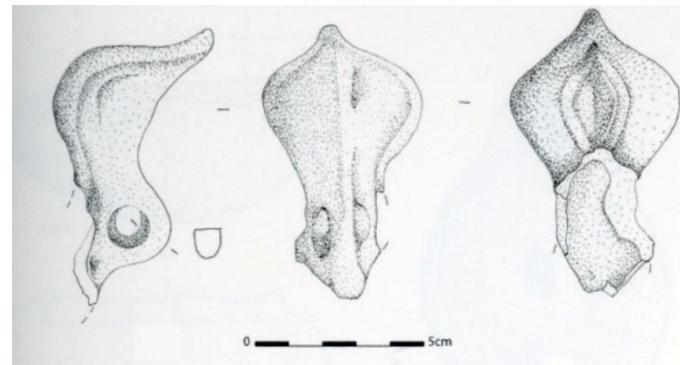

127

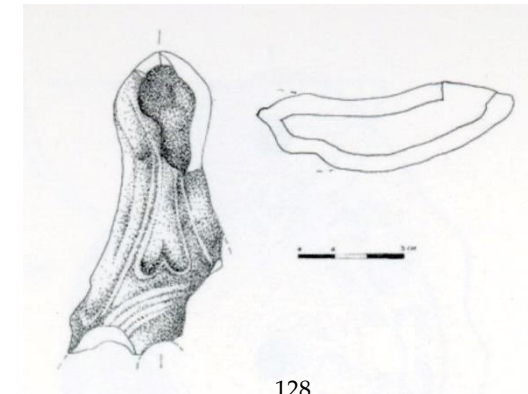

128

# Lampes moulées romaines et de l'Antiquité tardive



129

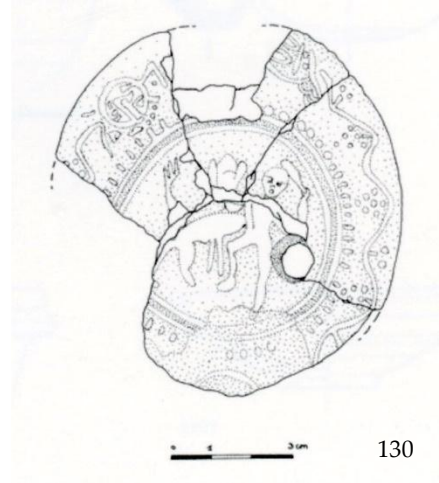

130

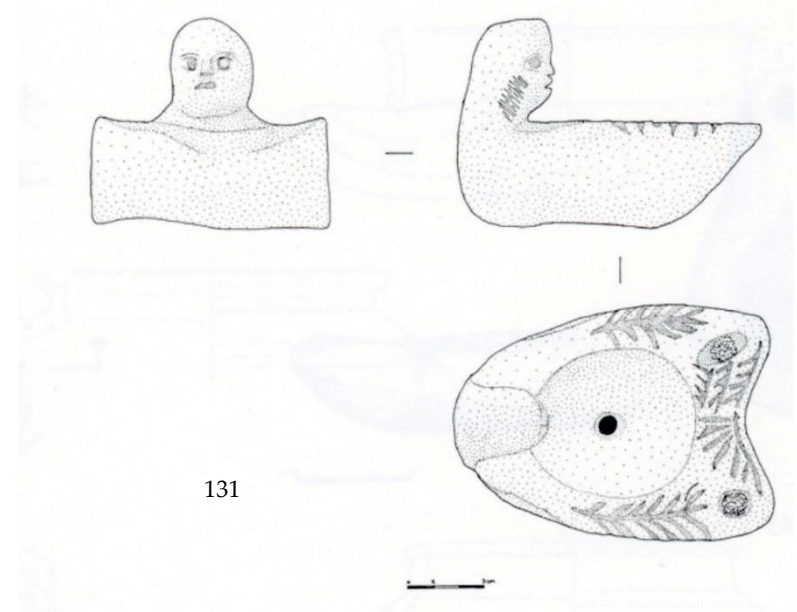

131

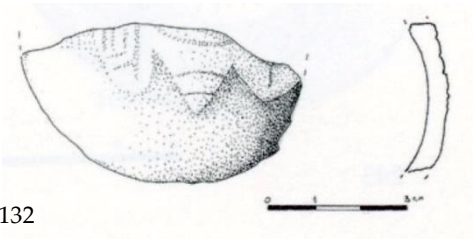

132

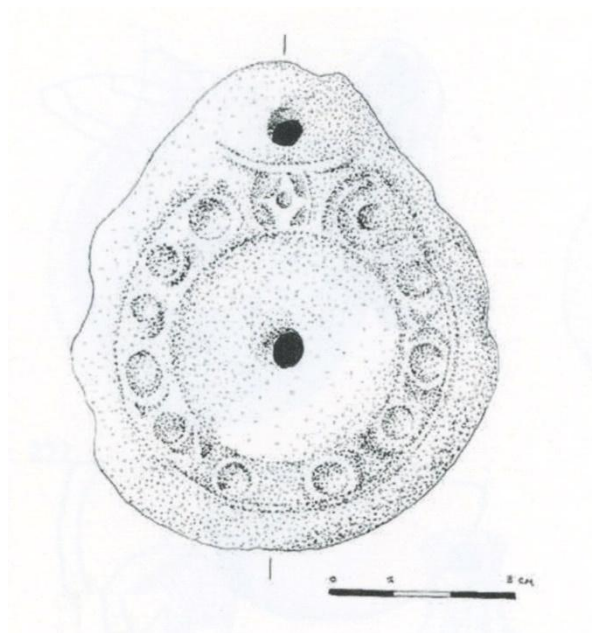

134

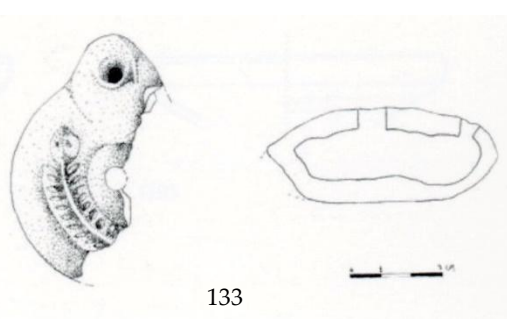

133

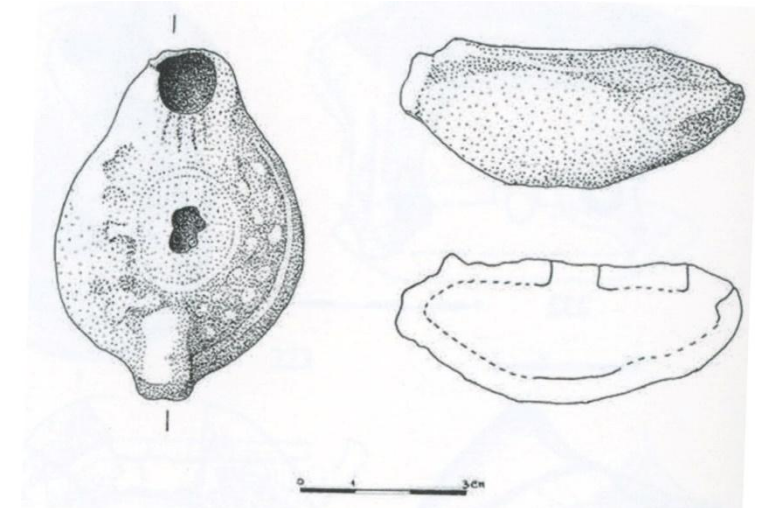

135

# Bibliographie

- D.M. Bailey, *Excavations at El-Ashmunein: V. Pottery, Lamps and Glass of the Late Roman and Early Arab Periods*, British Museum Expedition to Middle Egypt 5, Londres, 1998.
- D.M. Bailey, *A Catalogue of the Lamps in the British Museum. 1. Greek, Hellenistic and Early Roman Pottery Lamps*, British Museum Publications, Londres, 1975.
- D. Dixneuf, *Amphores égyptiennes. Production, typologie, contenu et diffusion (IIIe siècle avant J.-C. – IXe siècle après J.-C.)*, *Etudes alexandrines* 22, Alexandrie, 2011.
- C. Harlaut, J.W. Hayes, *Pottery in Hellenistic Alexandria. Aux origines d'Alexandrie et de sa production céramique. Hellenistic pottery deposits from Alexandria*, *Etudes alexandrines* 45, Alexandrie, 2018.
- M. Rodziewicz, *Hellenistic painted goblets in Alexandria*, *Etudes alexandrines* 49, Alexandrie, 2020.
- S. Martin-Kilcher, J. Wininger, *Syene III. Untersuchungen zur römischen Keramik und weiteren Funden aus Syene - Assuan (1.-7. Jahrhundert AD), Grabungen 2001 – 2004, Beiträge zur ägyptischen Bauforschung und Altertumskunde* 20, Gladbeck, 2017.
- P. Ballet, A. Poludnikiewicz, *Tebtynis V. La céramique des époques hellénistique et impériale, Fouilles franco-italiennes, campagnes 1988-1993. Production, consommation et réception dans le Fayoum méridional*, FIFAO 68, Le Caire, 2012.

# Remerciements

- **Estelle Galbois** (Maître de conférences en Histoire de l'art et Archéologie de l'Antiquité, Directrice-adjointe du laboratoire PLH (EA 4601), "Patrimoine, Littérature, Histoire" Université de Toulouse - Jean Jaurès) ;
- **Cecile Daguillanes** (Assistante de direction, Maison des Sciences de l'Homme et de la Société de Toulouse) ;
- **Clementina Caputo** (PhD in Philology and Archaeology, Research Fellow at the Politecnico di Milano - Department ABC, Building 15 - Campus Bonardi, Milan) ;
- **Mario Capasso et Paola Davoli** (Directeurs de la mission archéologique de Soknopaiou Nessos) ;
- **Ashraf Senussi** (Céramologue et dessinateur des céramiques de la mission archéologique de Soknopaiou Nessos) ;
- **Ihab Mohamed Ibrahim** (photographe à l'Institut français d'archéologie orientale au Caire) ;
- **Philippe Soubias** (alors photographe au Centre d'études alexandrines à Alexandrie puis au Centre Camille Jullian à Aix-en-Provence).