



**HAL**  
open science

## Numérique et lecture de textes épigraphiques altérés

Florent Comte, Hernan Gonzalez Bordas

► **To cite this version:**

Florent Comte, Hernan Gonzalez Bordas (Dir.). Numérique et lecture de textes épigraphiques altérés. Ausonius éditions, 107 p., 2023, Prima Luna, 27, 978-2-35613-548-3. 10.46608/primaluna27.9782356135469 . halshs-04372712

**HAL Id: halshs-04372712**

**<https://shs.hal.science/halshs-04372712v1>**

Submitted on 4 Jan 2024

**HAL** is a multi-disciplinary open access archive for the deposit and dissemination of scientific research documents, whether they are published or not. The documents may come from teaching and research institutions in France or abroad, or from public or private research centers.

L'archive ouverte pluridisciplinaire **HAL**, est destinée au dépôt et à la diffusion de documents scientifiques de niveau recherche, publiés ou non, émanant des établissements d'enseignement et de recherche français ou étrangers, des laboratoires publics ou privés.



Distributed under a Creative Commons Attribution - ShareAlike 4.0 International License

# Numérique et lecture de textes épigraphiques altérés

sous la direction de

Florent Comte et Hernán González Bordas

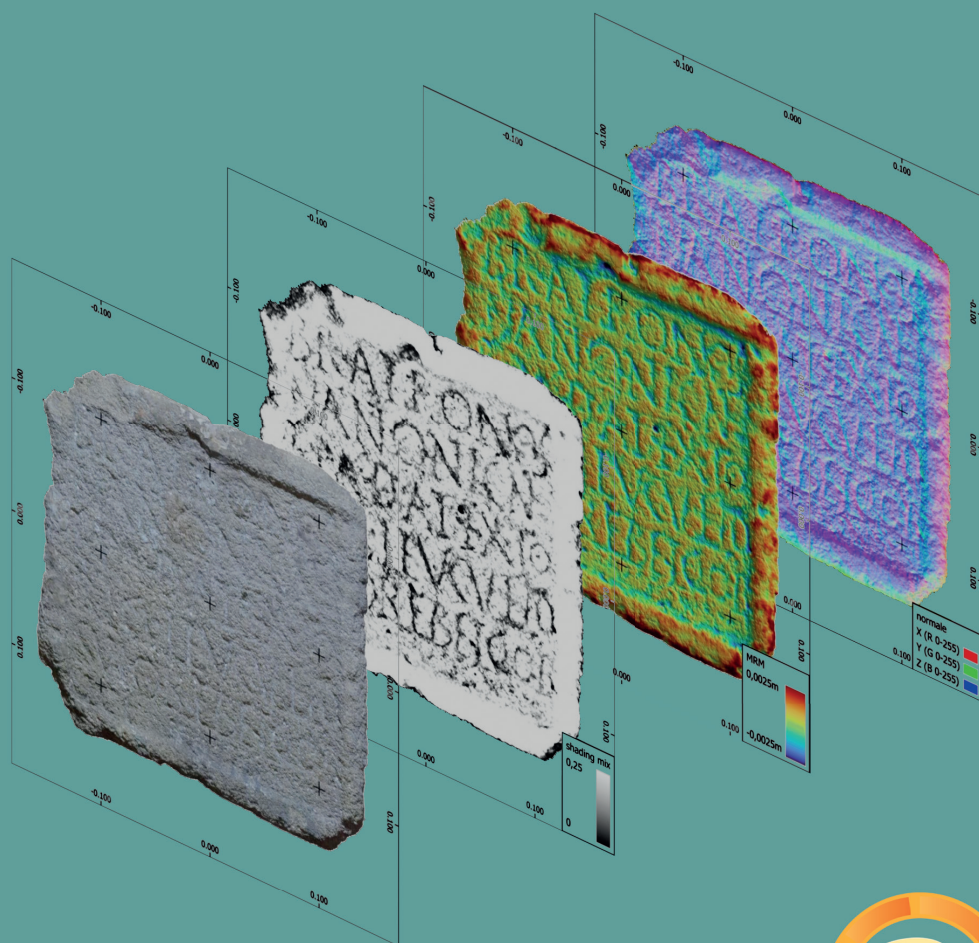

Numérique et lecture de textes  
épigraphiques altérés

Cet ouvrage a été réalisé pour  
Ausonius éditions  
par la plateforme UN@  
site d'édition universitaire numérique en libre accès.

Retrouvez les articles en version html, pdf téléchargeable  
et leurs contenus additionnels  
sur <https://una-editions.fr>



---

Numérique et lecture de textes épigraphiques altérés  
sous la direction de Florent Comte et Hernán González Bordas

Ausonius éditions, collection PrimaLun@ 27, Pessac, 2023

<https://una-editions.fr/numerique-et-lecture-de-textes-epigraphiques-alteres/>

DOI : 10.46608/primaluna27.9782356135469

Dépôt légal : décembre 2023

ISSN de la collection multipresses PrimaLun@ : 2741-1818

ISBN (HTML) : 978-2-35613-546-9

ISBN (PDF) : 978-2-35613-551-3

Mises en page papier et numérique :  
Alice Tanneur

Ce livre a été imprimé en 50 exemplaires sur les presses du  
Pôle Impression de l'Université de Bordeaux Montaigne, France,  
sous le label de référence Imprim'Vert®.



Il ne peut être vendu. Disponible gratuitement sur <https://una-editions.fr>

---

# Numérique et lecture de textes épigraphiques altérés

sous la direction de

Florent Comte  
et  
Hernán González Bordas

Cet ouvrage a obtenu le soutien financier de l'Institut Ausonius, UMR 5607-CNRS  
ainsi que de l'Université Bordeaux Montaigne dans le cadre de la PSE3-2023.





En couverture :  
*Superposition de différentes améliorations numériques pour l'étude d'une inscription latine.*

## AUTEURS

---

Angelos Barmpoutis	University of Florida
Eleni Bozia	University of Florida
Florent Comte	UMR 3495 MAP – MAP-Gamsau
Salvatore Ganga	Università di Sassari
Hernán González Bordas	Université Bordeaux Montaigne, UMR 5607 Ausonius, CNRS
Giovanna Rocca	IULM University
Coline Ruiz Darasse	Université Bordeaux Montaigne, CNRS, UMR 5607 Ausonius
Giulia Sarullo	eCampus University
Ignacio Triguero	Universidad de Alcalá





## SOMMAIRE

---

Déchiffrement de textes épigraphiques et 3D : état de l'art .....	9
<i>Florent Comte, Hernán González Bordas</i>	
The Forum Cippus. New elements from the laser scanning.....	25
<i>Giovanna Rocca, Giulia Sarullo</i>	
L'impiego di nuove tecniche digitali per la lettura delle iscrizioni: un esempio di disegno automatico dal modello 3D e un'applicazione virtuale della RTI.....	47
<i>Salvatore Ganga</i>	
Sinergías digitales para la lectura de epígrafes: casuística y metodología.....	65
<i>Ignacio Triguero</i>	
Reinscribing the 3rd dimension in epigraphic studies and transcending disciplinary boundaries .....	79
<i>Angelos Barmoutis, Eleni Bozia</i>	
QGIS, une solution alternative pour la lecture des inscriptions .....	95
<i>Florent Comte, Coline Ruiz Darasse</i>	



# DÉCHIFFREMENT DE TEXTES ÉPIGRAPHIQUES ET 3D : ÉTAT DE L'ART

*Florent Comte, Hernán González Bordas*

---

## PRÉSENTATION ET OBJECTIFS DU VOLUME

Le présent volume porte un intérêt particulier au caractère innovant des techniques mises en œuvre et à la variété de méthodes déployées lors de la résolution des problèmes retrouvés dans la lecture des textes sur différents supports épigraphiques. Il s'agira d'observer, pour chaque cas, les critères appliqués ainsi que les solutions choisies pour répondre aux différents problèmes issus de la diversité d'inscriptions. En effet, la pertinence des outils de modélisation n'est plus à démontrer, mais le nombre d'outils et d'analyses ayant pour objectif de livrer la moindre information conservée à la surface de l'inscription est devenu extrêmement conséquent. Il devient alors important, d'une part, d'aborder leur pertinence comparée, et, d'autre part, de comparer cette pertinence aux analyses traditionnelles de l'épigraphie. Cet ouvrage constitue ainsi une première étape indispensable pour atteindre un deuxième but, celui du consensus entre les épigraphistes et modélisateurs sur les protocoles de création de modèles 3D adaptés aux caractéristiques et aux problèmes présentés par chaque inscription.

## L'APPLICATION DE LA MODÉLISATION 3D À L'ÉPIGRAPHIE

Avant de passer au bilan de ce qui a été réalisé en matière d'application de la modélisation 3D pour l'épigraphie, il convient de revenir rapidement sur le stade immédiatement antérieur, notamment sur la numérisation des éléments réels dans d'autres disciplines historiques. C'est par l'intermédiaire de l'archéologie, soucieuse de la virtualisation de ses corpus à des fins d'études et de conservation, que l'épigraphie a bénéficié de la méthode numérique. En effet, cette dernière s'est ouverte aux sciences archéologiques relativement tôt et elle a été considérée comme une thématique à part entière dès la fin du XX<sup>e</sup> siècle et le début du XXI<sup>e</sup>. Localement, les colloques *Virtual Retrospect*, organisés depuis 2003 par l'Unité Archéovision<sup>1</sup>, implantée sur le campus de Bordeaux, en sont la meilleure preuve.

Plus largement, l'intégration systématique des outils liés aux humanités numériques dans la réflexion et l'heuristique des sciences archéologiques a permis de redéfinir depuis de nombreuses années leur paysage méthodologique. L'impact profond des nouvelles technologies dans cet espace disciplinaire s'enracine dans la mise en place de méthodes et d'outils offrant une meilleure interaction entre acteurs et données. Son ancrage résulte également de la concordance entre les Sciences Humaines et notre société assujettie aux technologies

1 L'ancienne UMS Archéovision est aujourd'hui intégrée à l'UMR ArchéoSciences.

numériques, concordance que les humanités numériques ne cessent d'ailleurs d'interroger sous des angles inédits, en construisant, notamment, les outils permettant à la société de s'emparer des résultats de recherche de manière toujours plus efficace.

Au même titre que de nombreux autres outils informatiques, la numérisation 3D fait incontestablement partie des humanités numériques. Son but consiste à construire, à analyser et à visualiser des résultats de corpus numériques. Elle constitue, comme chaque spécialité, un système de techniques tout à fait autonome demandant des connaissances spécifiques pour relever les défis auxquels elle fait face. La modélisation 3D s'est développée au sein des laboratoires de recherche d'archéologie des périodes préhistoriques et historiques par nécessité d'enregistrer le plus finement possible des données qui ne prennent sens que dans des relations spatialisées, qu'elles soient extrinsèques (les faits liés aux structures d'un site archéologique) ou intrinsèques (les faits présents sur un artefact ou un écofact, par exemple).

C'est par ce dernier usage que la modélisation 3D – et surtout l'analyse des modèles virtuels qui en découlent – a été introduite dans le domaine de l'épigraphie. Ainsi, si ces méthodes existent depuis plus d'une vingtaine d'années pour l'archéologie, elles ne remontent pas avant les années 2010 pour notre discipline. Et encore, si nous entendons un usage spécifique des modèles virtuels, dont l'analyse permet de quantifier des phénomènes (temporels, morphologiques, etc.) et non pas seulement une application de "vitrine" visuelle et technologique, les expériences fondatrices ont été longtemps marginales, et l'applicabilité réelle n'a cristallisé dans notre communauté qu'il y a quelques années.

Au début des années 2010, les universités et centres de recherche qui développaient ces techniques étaient encore rares et se remettaient aux compétences détenues par quelques spécialistes<sup>2</sup>. En revanche, de nos jours, les programmes de recherche centrés sur l'épigraphie, dans, par exemple, un centre comme l'institut Ausonius, proposent systématiquement un volet modélisation 3D<sup>3</sup>. Si ce phénomène est évidemment lié à l'attrait développé assez tôt par le laboratoire mentionné pour la *digital epigraphy* (notamment grâce à la plateforme *PETRAE*<sup>4</sup>) et à des pionniers dans l'usage de la 3D comme J.-P. Bost<sup>5</sup>, le même constat s'applique à de nombreux laboratoires autant en France qu'à l'étranger.

Aujourd'hui, ces méthodes ont été pleinement adoptées par la communauté, mais il faut se demander pour quels motifs cette application, bien implantée dans l'archéologie, a pris plus d'une dizaine d'années à devenir une réalité pour l'épigraphie. Nous identifions principalement trois raisons. En premier lieu, tout simplement, l'intérêt de la modélisation 3D n'a pas été compris de façon immédiate par les spécialistes de la discipline. En deuxième lieu, et probablement en lien avec la première raison, on peut évoquer un certain conservatisme dans les méthodes de lecture de la part des épigraphistes et même une méfiance. En guise d'exemple, avant la 3D, la retouche de photos d'inscriptions sur Photoshop n'était pas vue d'un bon œil, même si l'objectif était de faire mieux ressortir les lettres. Cela réveillait chez l'épigraphiste une peur atavique, qui datait des époques des humanistes et antiquaires, et qui

2 Voir dans ce volume Bozia & Barmpoutis, 82-83.

3 UMR 5607.

4 Programme d'Enregistrement, Traitement et Reconnaissance Automatique en Épigraphie. Voir sur ce point : Comte *et al.* 2021.

5 Voir le corpus à paraître, *ILA Lemovices*, fiche 94 (inscription de Saint-Avit-de-Tardes AE, 2018, 1141).

concernait notamment les falsifications d'inscriptions<sup>6</sup>. En troisième lieu, des raisons d'ordre technique expliquent ce retard. En effet, si la généralisation des outils 3D s'est accentuée dans notre domaine au cours de la dernière décennie, c'est notamment grâce à l'essor de la puissance de calcul des ordinateurs, la miniaturisation des outils, la robustesse des solutions logicielles et l'accès à diverses solutions matérielles et logicielles pour des budgets bien inférieurs à ceux proposés auparavant.

Pour terminer ce premier et rapide tour d'horizon, il convient de nuancer nos propos par le fait que si la tendance générale montre un décalage entre disciplines, certaines équipes ont été pionnières dans la création de solutions technologiques utiles aux études épigraphiques et à celles du mobilier. On pense ici évidemment au *Reflectance Transformation Imaging* (RTI), dont l'invention remonte au tout début des années 2000, et qui, dès le départ, s'est concentré sur l'apport à la lecture d'artefacts anciens<sup>7</sup>. L'essor fulgurant de ce système (lié au *shape-from-shading* et permettant d'enregistrer en 2D les informations de réflectance à la surface des matériaux numérisés) s'explique par sa capacité à travailler extrêmement finement sur les détails discrets, grâce à diverses améliorations visuelles mettant en valeur ces détails<sup>8</sup>.

### MODÉLISATION 3D ET ÉPIGRAPHIE : DES INTERACTIONS NÉCESSAIRES

À ce jour, deux grands volets complémentaires se développent, distincts autant par les fonctions qu'ils remplissent que par les outils et les procédés qu'ils mettent en œuvre. Il s'agit, d'un côté, de la modélisation pour la vulgarisation des inscriptions et des supports épigraphiques dans son ensemble et, d'un autre côté, de la modélisation des surfaces des champs épigraphiques pour le déchiffrement des textes endommagés, érodés ou détériorés. Nous nous intéresserons ici à ce deuxième volet.

Des techniques variées sont utilisées pour acquérir des données scientifiquement mesurables, ainsi que pour les analyser, que ce soit dans le but de déchiffrer ce qui est difficilement perceptible à l'œil nu, ou de préserver le patrimoine virtuel des objets, et par voie de conséquence, d'avoir la possibilité de réinterroger leurs modèles ultérieurement. Dans leur variété, ces techniques se structurent néanmoins autour d'une série de processus, d'abord de création de la donnée (récolte, modélisation, conservation) et ensuite d'analyses appliquées aux données acquises. Si les processus de création dépendent entièrement de la solution technologique utilisée, ce n'est pas le cas pour les processus d'analyse. Ceux-ci sont réalisés avec un autre ensemble logiciel, non spécifique à l'acquisition, mais propre au format des données créées, dont on connaît les limites applicatives : on ne peut analyser de la même manière des nuages de points, des maillages ou des images rectifiées (voir infra).

6 Ainsi, les débats suscités par la falsification d'inscriptions et les méthodes établies pour savoir distinguer les vraies des fausses sont aussi vieux que la discipline. On peut citer en guise d'exemple l'ouvrage d'Antoni Agustí i Albanell, *Dialogos de Medallas inscripciones y otras antiguedades*, publié à Tarragone en 1587. Mais, au-delà des textes interpolés ou forgés pouvant apparaître sur les recueils d'épigraphes, au XVIII<sup>e</sup> siècle, la démocratisation du goût pour les antiquités, dont les inscriptions anciennes, provoqua l'essor des contrefaçons physiques (Billanovich 1967, 42).

7 Malzbender *et al.* 2001, 6-7. Voir dans ce volume Ganga, 59.

8 Or, même si les innovations technologiques nous donneront tort d'ici peu de temps (nous l'espérons en tout cas), le RTI ne peut pas être considéré à l'heure actuelle comme une solution concurrente des différents types de modélisation 3D, mais plutôt comme une solution complémentaire (issue de l'imagerie scientifique), et ce, pour plusieurs raisons, que ce soit en termes de types de données générées, de limites et d'usages.

## Récolte de données

La récolte des données ne repose pas uniquement sur le choix d'une solution technologique, mais doit faire coïncider au mieux différents critères, certains liés au contexte de récolte et d'autres liés au sujet d'étude. Par exemple, pour les tablettes d'argile en Linéaire B<sup>9</sup>, il a été décidé – en raison de la fragilité et de la spécificité de ces supports – de les placer sur une plaque tournante lors de l'acquisition, afin de les manipuler le moins possible. D'autres projets, comme The Digital Rosetta Stone Project, visant à une étude et une analyse globale de cette inscription, ont dû mettre en œuvre des approches spécifiques comme la modélisation par *shape-from-shading*<sup>10</sup>.

### La photogrammétrie

Pour autant, la méthode dominante pour l'étude virtuelle en épigraphie reste le *Structure-for-Motion* par corrélation photogrammétrique dense, plus habituellement appelée "photogrammétrie" (**fig. 1**). Pour faire simple, en utilisant une collection de photos qui mosaïquent la surface de l'objet, la photogrammétrie, en corrélant ces différents points de vue, analyse les variations pour reconstruire une représentation en 3 dimensions du sujet (avec plus ou moins de précision)<sup>11</sup>. Elle possède certains avantages, notamment sa robustesse, sa maturité, sa versatilité et son faible coût opératif.

Ainsi, équipé des accessoires nécessaires et avec un protocole strict mis en place au préalable, il est possible de récolter des données optimales pour la recherche. Si l'appareil – correctement paramétré – et l'objectif sont des éléments fondamentaux, il n'en demeure pas moins qu'utiliser divers flashes, filtres, panneaux LED, échelles, équerres, sphères de réflexion, systèmes d'ombrages et trépieds constitue un véritable avantage pour améliorer la phase d'acquisition. Car, contrairement aux méthodes métrologiques (voir infra), les résultats de la photogrammétrie sont directement liés à la perfection des images sources<sup>12</sup>. Toutefois, l'usage grandissant de l'acquisition avec la caméra d'un smartphone tend à montrer depuis quelque temps qu'il est tout à fait possible d'acquérir des données sources utilisables, tant que l'approche reste qualitative (aide à la lecture) et non strictement quantitative (précision de la mesure)<sup>13</sup>, en raison de la faiblesse des dites caméras (résolution, capteur, filtres, formule optique, etc.).

À n'en pas douter, la place dominante de la photogrammétrie s'explique aussi par le fait que le système de logiciels et de méthodes est propice aux améliorations, et a transformé la pratique à de nombreuses reprises. En l'occurrence, les études morphologiques n'ont été possibles qu'à partir du moment où les solutions photogrammétriques ont permis de suffisamment densifier les modèles (voir infra) pour étudier des détails extrêmement fins.

9 <https://hexagon.com/resources/resource-library/linear-b-tablets-palace-nestor> (consulté le 4/05/2022).

10 Bozia & Barmpoutis 2018. Voir leur contribution dans le présent volume, p. 79-94.

11 En réalité, la photogrammétrie est, actuellement, une méthode de mesure spatiale basée sur le modèle de la géométrie épipolaire, et qui s'utilise généralement dans les solutions de *structure-for-motion*, d'une part, pour la reconstruction spatiale de la scène (positionnement des points analogues et des caméras), et d'autre part, pour la création des cartes de profondeur inhérentes à la densification du nuage de surface.

12 Ainsi, ses erreurs sont estimées, et pas réellement absolues : par exemple, les erreurs d'homothétie se basent sur la méthode des moindres carrés pour estimer l'erreur d'échelle, et l'erreur de reprojection moyenne dépend de la stratégie d'optimisation des points analogues. La perfection de la collection de clichés sources est donc primordiale.

13 Voir, par exemple, Aounallah et al. 2022 ou, dans ce volume, Bozia & Barmpoutis, 84.



Fig. 1. Acquisition photogrammétrique : échantillon d'images séquencées de la partie supérieure d'un support épigraphique.

Enfin, si la pratique actuelle semble être devenue triviale sur certains logiciels, il ne faut pas oublier que la valeur de la modélisation est proportionnelle à la rigueur des photographies acquises ; ce problème exclut, de fait, certains types d'acquisitions dont on ne peut ni connaître le paramétrage, ni enregistrer les limites, éléments obligatoires à toute expérience scientifique.

### *Les méthodes métrologiques*

Face à cette méthode, certaines équipes préfèrent recourir à divers outils métrologiques, comme les *Terrestrial LiDaR Scanners* (TLS)<sup>14</sup> ou les *Coordinates Measuring Machines* (CMM)<sup>15</sup>, mais surtout – pour répondre au besoin de mobilité inhérent à la modélisation épigraphique – à des scanners lasers à triangulation optique. Ces derniers appareils projettent une croix laser ou une lumière "structurée"<sup>16</sup> sur le sujet, alors que des caméras, décalées les unes par rapport aux autres, observent la déformation du motif induite par le relief. Ainsi, par calcul trigonométrique, il est possible de numériser des surfaces et de les enregistrer à échelle réelle.

Dans ce cas aussi, les évolutions matérielles et logicielles des solutions applicables lors de la dernière décennie expliquent l'essor de leur usage. Si la numérisation en musée ou en laboratoire existe depuis longtemps, la nécessité d'être relié à une source de courant électrique constituait, jusqu'à récemment, un gros handicap limitant l'usage en extérieur, notamment sur

14 Bryan *et al.* 2013, 126.

15 Les premiers ont des usages particulièrement pertinents pour des grandes surfaces. Les seconds sont extrêmement coûteux et peuvent être trop invasifs sur des pièces fragiles.

16 C'est-à-dire une lumière possédant un motif unique qui est reconnu par chaque caméra de l'appareil.

les sites archéologiques<sup>17</sup>. De plus, les anciens modèles n'étaient pas en mesure d'enregistrer la couleur<sup>18</sup>, mais uniquement le relief, ce qui limitait l'usage général des données acquises.

Enfin, chaque appareil possédait (et possède) une gamme d'utilisation restreinte, pour un volume donné, avec une précision fixe. Certains sont donc utiles sur de petits objets, de quelques centimètres, mais restent trop consommateurs en énergie pour être utilisés sur de larges sujets. D'autres, au contraire, scannent sur une surface plus large, mais avec moins de résolution. Ainsi, suivant les objectifs, chaque scanner laser peut-être, ou non, pertinent. Il n'en reste pas moins que chacun des appareils professionnels actuels permet d'atteindre une précision infra-millimétrique, très utile pour le sujet qui nous importe dans ce siège.

On comprendra alors comment, sur ce cliché (**fig. 2**), S. Ganga, collaborateur dans le présent volume, avec les professeurs A. Gavini et M. Sechi, sont parvenus à déchiffrer certaines lettres peu visibles à l'œil nu sur une colonne votive, à l'aide d'un scanner laser à triangulation optique projetant une croix laser à la surface à numériser.



Fig. 2. Numérisation d'une inscription avec un scanner laser à triangulation optique dans Ganga et al. 2015, 1578.

17 Et ce, même si les premiers scanners autonomes datent de 2012. Mais leur usage était très laborieux pour diverses raisons (ordinateurs forcément branchés, obligation d'ombrage, faible résistance aux températures estivales, etc).

18 Ou seulement en niveaux de gris pour les plus perfectionnés.



L'usage de ces scanners se faisait avec un ordinateur relié pour calculer et enregistrer les surfaces numérisées. Bien que ces appareils soient toujours utilisés, les scanners de dernière génération sont indéniablement plus faciles à employer. Ils possèdent une interface intégrée, permettant de créer le modèle directement sur place, ce qui évite de les relier à un ordinateur. De même, leur autonomie est largement suffisante permettant de travailler des journées entières sur les sites. De plus, les données acquises sont polychromes. En revanche, ces appareils sont très onéreux.

## Conception des modèles

Une fois l'acquisition réalisée, la conception de la donnée, pérenne et utilisable, passe par un traitement fournissant, *in fine*, un modèle standardisé. Par ce mot, on entend que le modèle doit contenir nécessairement les données acquises dans un format utilisable pour répondre à la problématique de recherche, mais aussi les métadonnées utiles pour comprendre ses biais, voire – pour les plus rigoureux – des paradonnées renseignant le contexte d'acquisition lui-même. Ainsi, le modèle peut être conservé et utilisé en tenant compte de ses limites, qui sont généralement, pour les modèles 3D, des erreurs d'échelles, des distorsions morphologiques, des aberrations colorimétriques ou des zones occultées.

Suivant les outils d'acquisitions utilisés, la conception des modèles est réalisée au moyen de logiciels propriétaires ou libres. Un exemple du premier cas est l'ensemble des solutions pour les scanners lasers, qui fournissent avec l'appareil la suite permettant l'exploitation des numérisations. En revanche, la photogrammétrie fait, là aussi, office d'exception : comme la donnée source est une collection de photos, plusieurs logiciels concurrents permettent de réaliser des modèles avec des algorithmes concurrents. Ils peuvent être propriétaires, libres, concerner un ou plusieurs types de modèles, ou encore demander un usage coordonné avec des logiciels tiers<sup>19</sup>. Toujours-est-il que la photogrammétrie démontre sur ce sujet une versatilité incomparable.

## Analyses des modèles

Comme l'a exprimé G. Verhoeven, l'accumulation de données numériques ne sert le propos scientifique que si elle en fournit une analyse pertinente<sup>20</sup>, ainsi, d'ailleurs, que le cadre de cette analyse. À ce titre, l'usage des modèles 3D par les épigraphistes est assez exemplaire, car il y a, depuis longtemps, un objectif parfaitement délimité : aider à déchiffrer, communiquer ces déchiffrements et conserver le patrimoine virtuel des inscriptions sur une base visuelle, accessible et quantifiable. S'il est entendu qu'il est possible de réaliser sur le modèle, lorsqu'il possède un haut niveau de précision, les mêmes types d'observation que sur l'objet lui-même (application d'une lumière rasante, par exemple)<sup>21</sup>, nous nous concentrerons par la suite sur les analyses uniquement réalisables sur les modèles virtuels.

Ainsi, comme on le verra, une série d'usages s'est progressivement démocratisée au sein de la communauté, d'une part, en raison de la pertinence des analyses et, d'autre part, grâce à la

19 Cette coordination obligatoire est souvent une limitation des logiciels libres (à part MicMac), qui ne permettent pas de mettre à l'échelle et de positionner l'inscription ou de réaliser le maillage. Il faut donc passer par des logiciels de traitement des modèles, comme Meshlab, ou CloudCompare.

20 Verhoeven 2019, §3.

21 Pour les analyses similaires à celles réalisées sur le sujet réel, voir Comte 2018, 95-97.

mise à disposition de logiciels et solutions libres permettant de les réaliser<sup>22</sup>. On peut considérer le “nuage de points dense” (*dense cloud*)<sup>23</sup> et le “maillage” (*mesh*)<sup>24</sup> comme les principaux sujets des analyses pour diverses raisons, autant bibliographiques (ces éléments reviennent le plus souvent dans la plupart des publications) que techniques.

En effet, même des nuages de points extrêmement denses (et donc potentiellement précis) peuvent être analysés morphologiquement, et certains logiciels permettent donc d’en étudier les courbures ou la rugosité. Le maillage (que l’on peut qualifier de surface virtuelle) quant à lui, contient d’autres informations comme la direction de chaque face<sup>25</sup>. Il est ainsi possible d’éclairer simplement un maillage, de montrer les orientations (la carte des normales), de calculer l’ombrage ambiant local (la carte d’occlusion ambiante), d’en enregistrer les profondeurs (la carte de cavité), de calculer les pentes, ou de créer entièrement des modes de rendus optimisés pour l’étude épigraphique. Nous pensons ici à deux types de rendus : le *shader* “*Radiance Scaling*”, disponible sur des logiciels libres comme Meshlab ou 3DHOP, et certaines *MatCap* utilisables dans le logiciel libre Blender ou dans d’autres logiciels propriétaires.

Par la suite, nous aborderons des exemples d’autres techniques, plus complexes à mettre en place, qui, depuis quelques années, permettent de travailler au plus près du relief et de la morphologie du sujet. Nous nous attarderons en particulier sur le MRM et le dépliage de surface courbe.

### Le MRM

Le Modèle de Résidu Morphologique<sup>26</sup>, ou MRM, traduit les différences spatiales entre un modèle précis et un modèle approximatif d’un même objet en informations en couleur. Il permet de faire ressortir les différences morphologiques discrètes tout en occultant les plus grandes<sup>27</sup> (**fig. 3**). Il s’est révélé comme un outil formidable pour le déchiffrement d’inscriptions sur du granite, pierre à gros grain pour laquelle cette technique a permis de déchiffrer même des inscriptions méticuleusement martelées. Certains exemples permettent de discuter de ces apports analytiques. Voici une sélection des plus éloquentes.

Ainsi, Hugo Pires, de l’Universidade do Porto, a développé il y a une décennie cette technique, et un exemple de son travail, réalisé en collaboration avec Maria João Correia Santos, concerne une inscription rupestre sur granite du sanctuaire de Panoias (**fig. 4**). Initialement interprétée

22 Au risque de nous répéter, comme Meshlab et CloudCompare.

23 Ce terme renvoie à la représentation spatiale des données reconstruites dans la scène sous forme de points (x,y,z) contenant un ou plusieurs champs supplémentaires de caractéristique. On appelle ce nuage de points “dense”, car il est généré suite à l’opération de densification qui consiste à multiplier le nombre de points du nuage initial des points homologues (qui sert à placer les caméras dans l’espace 3D) grâce à la projection 3D des cartes de profondeur calculées pour chaque caméra. Voir dans ce volume Ganga, 49.

24 Ce terme renvoie à une modélisation géométrique qui reconstruit une véritable “surface” virtuelle en créant une série de mailles juxtaposées qui suivent la morphologie du sujet. À la différence d’un nuage de point, ou chaque élément renvoie à une position (on peut donc passer au travers), la maille, triangulaire ou quadrangulaire le plus souvent, renvoie à une surface (on ne peut pas passer au travers). Plus la maille est petite, plus la morphologie sera respectée, mais le maillage sera aussi plus lourd à manipuler. Voir dans ce volume Ganga, 53 et Triguero, 66.

25 Ce vecteur normal de la face, c’est-à-dire perpendiculaire à la face (généralement appelée simplement “normale”), peu mis en avant, est, à notre avis, le plus grand intérêt des analyses de maillages, car il permet de travailler sur les orientations du relief virtuel, comme un véritable double numérique de la surface réelle. C’est avec cette normale que les améliorations visuelles et spéculaires sont réalisées.

26 Il s’agit d’une technique développée par H. Pires : Pires *et al.* 2015.

27 À la différence des cartes de profondeur, par exemple, qui permettent de mettre en avant les différences de profondeur d’une surface par rapport à une valeur absolue.

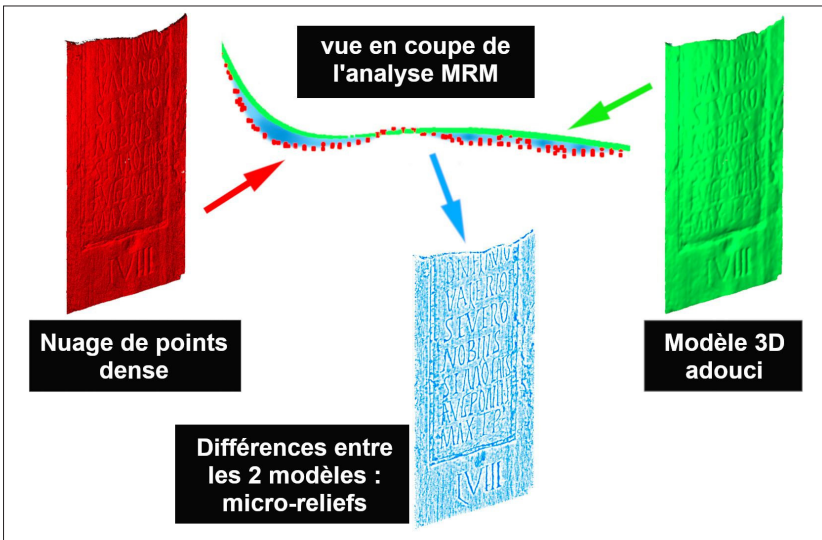

Fig. 3. Schéma du principe d'une analyse de microreliefs par MRM.



Fig. 4. CIL, II, 2395a dans Pires et al. 2014.

comme dédiée aux *Dii Severi* par Géza Alföldy, l'application de cette technique a permis de proposer une réinterprétation pointant un culte oriental, puisque l'inscription est vouée à Serapis et à Isis.

Un autre exemple concerne les sculptures tauriformes connues comme les Taureaux de Guisando (un site archéologique près d'Avila en Castille centrale). Il s'agit de quatre taureaux faisant partie d'une tradition de sculpture pré-romaine de la tribu des Vettones dans la partie centre-ouest de la péninsule Ibérique. Pour autant, ces monuments précis datent de l'époque romaine et ont servi de support à des inscriptions latines. Depuis la fin du Moyen Âge, différentes lectures de leurs textes ont ainsi été proposées. Étant donné la difficulté de l'exercice, une équipe hispano-portugaise a décidé, il y a quelques années, d'appliquer un procédé similaire à celui du sanctuaire de Panóias sur ces sculptures (**fig. 5**). Les résultats ont bouleversé la compréhension de ces textes, bien plus complète qu'auparavant. Il s'agit ainsi d'un groupe particulier d'inscriptions funéraires, dont les dédicacées, des familles des *Lancii* et des *Longinii*, faisaient partie de la même *cognatio* ou clan, les *Calaetici*.



Fig. 5. Taureau 1 avec inscription CIL, II, 3052, dans Fabián et al. 2021.

Un dernier exemple, cette fois-ci sur du calcaire, intéresse le déchiffrement complet d'un règlement agraire pour la mise en culture de domaines impériaux en Afrique proconsulaire connu comme le *sermo procuratorum*. Il a été mené par H. González Bordas, grâce, entre autres choses, à la lecture des modèles 3D des quatre faces de l'inscription de Lella Drebbliia, en Tunisie septentrionale (**fig. 6**)<sup>28</sup>. La pierre était divisée en un fragment supérieur, resté exposé aux intempéries, car remployé dans un cimetière musulman, et un fragment inférieur, enterré et qui ne présentait pas d'érosion. Le travail de modélisation s'est donc concentré sur le premier. Si son érosion était très importante, elle restait néanmoins homogène sur toute la surface, ce qui contribua au succès de l'opération. Le processus de lecture exigea néanmoins une certaine exhaustivité dans la mesure où l'on mit en œuvre une photogrammétrie et de nombreuses analyses<sup>29</sup>. Certains rendus du logiciel Meshlab se sont révélés particulièrement efficaces, comme le *depthmap* ("carte de profondeur", un gradient de couleurs qui représente les profondeurs dans l'axe de la caméra) ou le *radiance scaling* (qui nuance la luminosité du modèle en fonction de ses courbures locales et de l'incidence de la lumière). En parallèle, une analyse de type MRM, doublée d'un traitement en V-RTI<sup>30</sup>, a permis de travailler sur les détails de surface depuis le logiciel *RTI Viewer*. Cette inscription, trouvée en début du siècle, avait été publiée de façon très incomplète par l'équipe de M. de Vos en raison de son caractère fragmentaire et des problèmes d'érosion évoqués<sup>31</sup>.



Fig. 6. AE, 2001, 2083 (face 1).  
Analyse sur le sujet réel : rendu "Radiance Scaling" (Meshlab).

28 González Bordas & France 2017.

29 Grâce au travail de l'entreprise Geokali (voir fig. 1) et d'H. Pires et F. Comte, respectivement.

30 Le V-RTI est une méthode insolite, reprenant l'idée du RTI mais en l'appliquant virtuellement au maillage. Si ce système ne peut servir à l'analyse fine de la réflectance de l'objet réel, il permet néanmoins un usage léger des manipulations des lumières sur le modèle 3D et sur les analyses qui y sont liées (<https://ausohnum.hypotheses.org/177>).

31 De Vos 2000.

## L'aplatissement de surfaces courbes

Certains corpus d'inscriptions se présentent sur des surfaces non droites, c'est par exemple le cas des bornes milliaires<sup>32</sup>. Pour autant, leurs modèles 3D peuvent être virtuellement déroulés, et elles deviennent ainsi plus facilement analysables, déchiffrables et publiables<sup>33</sup>.

Imaginé, au départ, pour trouver une solution à la publication d'images orthorectifiées de structures semi-cylindriques (des chevets d'églises médiévales), ce traitement du nuage dense permet une meilleure intégration des méthodes développées plus haut pour les épigraphes sur surfaces courbes. À plus forte raison, il peut s'appliquer à des objets dont les surfaces n'ont qu'un axe de courbure (en l'occurrence l'axe vertical), comme les bornes miliaries. Le principe a été de créer le chemin de dépliage de l'objet virtuel qui consiste en une ligne polygonale (c'est-à-dire une suite de segments de droites suivant lequel le développé est effectif). Chaque segment de ce chemin de dépliage sélectionne les points de nuage les plus proches de lui, et les replace de manière linéaire lors de son dépliage. Cette mise à plat de surfaces développables permet ainsi de déplier une surface à courbure constante sans la déformer, comme si l'on déroulait une feuille de papier.

Nous pouvons observer ce déroulement en prenant une borne milliaire inédite, mais en cours de publication, provenant du centre-nord de la Tunisie<sup>34</sup>. Datant des années 306-307 p.C., elle marque la mille 58 de la voie *a Carthagine Thevestem* et honore l'accession de Flavius Valerius Severus à l'augustat. Il s'agit de la seule dédiée exclusivement à ce tétrarque en Proconsulaire et la deuxième en Afrique (**fig. 7 et 8**).

L'intérêt est triple : d'une part, les analyses sur le modèle virtuel déplié peuvent être appliquées et visualisées à l'échelle de l'ensemble de l'inscription, et non pas d'une seule partie à la fois ; d'autre part, l'inscription devient bien plus facilement lisible et communicable en deux dimensions ; enfin, contrairement à d'autres techniques de "dépliage" numérique (comme le *primitive-baking* qui consiste à projeter les informations à la surface d'un cylindre parfait déplié en 2 dimensions), il y a une conservation morphologique des microreliefs. Le modèle aplati n'est pas alors juste un modèle de publication, mais, à son tour, un véritable support d'analyse.

Extrêmement facile à réaliser, cette méthode présente donc un intérêt comme alternative aux présentations traditionnelles, autant celles des photos qui montrent le texte du milliaire de façon incomplète, que celle des estampages, invasifs<sup>35</sup> et présentant un rendu souvent imparfait à cause du dépliage.

Une limite d'utilisation majeure de cette technique réside dans la déformation des reliefs, proportionnelle à l'éloignement de la ligne polygonale de développement. Ceci peut constituer un problème dans le cas de la modélisation de certains bâtiments à cause de la profondeur des portes et fenêtres. Dans ce cas, il faut diviser les plans de développement pour éviter des déformations gênantes. Mais, dans le cas de la modélisation d'inscriptions, il n'y a pas d'incidence puisque la gravure des lettres ne représente qu'une profondeur négligeable par rapport au diamètre du support lui-même. Ces déformations sont donc infimes et, par conséquent, cette limite ne concerne pas l'épigraphie.

32 C'est aussi le cas des *cupae* funéraires ou de certaines inscriptions rupestres.

33 Nous avons notamment mis au point une technique simple, toujours grâce au logiciel CloudCompare, essentiel à l'étude numérique des corpus épigraphiques.

34 Comte & González Bordas (à paraître).

35 Voir dans ce volume l'article de S. Ganga, p. 48 "calco a umido con carta da filtri".

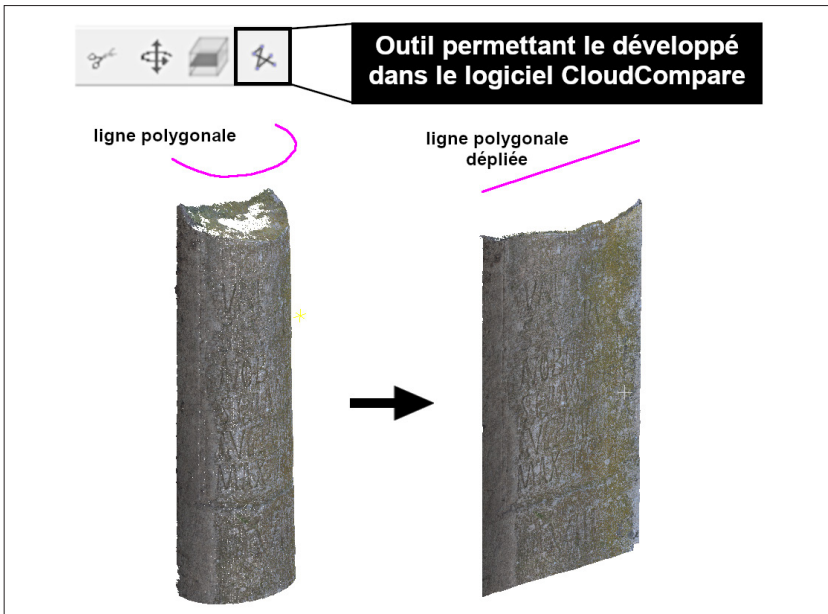

Fig. 7. Sch ma du d veloppement d'un nuage dense suivant une ligne polygonale.



Fig. 8. Analyses morphologiques des d tails de la borne milliaire de Flavius Valerius Severus.

## CONCLUSIONS ET OUVERTURES

Cette rapide introduction a montré l'aspect foisonnant et divers d'une pratique ni uniforme ni homogène, construite sur un empirisme en constante évolution. La question de la conservation pérenne des données – éminemment importante aujourd'hui – renvoie, elle aussi, pour l'instant, à une prise de conscience disparate de la communauté (en tout cas à l'échelle française). Certes, l'affaire est complexe et la somme des données générées – entre données sources, intermédiaires, finales, métadonnées et paradonnées – confine à un débat sans cesse renouvelé entre, d'un côté, la pertinence de tout conserver et de l'autre côté, la perte des éléments de l'interprétation scientifique<sup>36</sup>. Ainsi, et même si une expérience solide existe et encadre les standards de la pratique, les objectifs et les solutions applicables, nous sommes seulement au milieu du gué de l'épigraphie virtuelle.

On le disait au début de cette introduction : nous assistons aujourd'hui à une augmentation du nombre d'outils et d'analyses pouvant contribuer à conserver les informations les plus détaillées et à mieux déchiffrer les textes épigraphiques. Pourtant, cela ne veut pas dire que ces technologies sont toutes également pertinentes. Leurs capacités varient bien selon la gravure, le matériau du support ou le type d'érosion<sup>37</sup> et leur mise en œuvre dépend d'éléments aussi variés que l'emplacement des inscriptions objet d'étude, la possibilité d'utiliser certains dispositifs ou l'utilisation de logiciels libres ou bien propriétaires pour la conception et l'analyse des modèles. En ce sens, notre ouvrage réunit des contributions questionnant ces implications pour des inscriptions problématiques, que ce soit sur une seule inscription ("The Forum Cippus. New elements from the laser scanning" de Giovanna Rocca et Giulia Sarullo) ou une série préétablie ("L'impiego di nuove tecniche digitali per la lettura delle iscrizioni: un esempio di disegno automatico dal modello 3D e un'applicazione virtuale della RTI" de Salvatore Ganga), chacune présentant des problèmes de contexte ou de lecture très particuliers ayant demandé l'usage d'analyses virtuelles très variées. De plus, notre pratique avançant, il convient d'aborder la dissémination des méthodes et des outils, là aussi – pour être le plus pertinent entre théorie et application – depuis des retours d'expériences de corpus aux caractéristiques particulières ("Sinergías digitales para la lectura de epígrafes: casuística y metodología" d'Ignacio Triguero). L'intérêt est d'autant plus grand, alors, de pouvoir s'appuyer sur les avancées de projets épigraphiques d'ampleur, comme le *Digital Epigraphy and Archaeology* (DEA) *Project*, qui, depuis 2010, questionne et supporte l'imbrication entre épigraphie et numérique, avec des solutions misant sur l'accessibilité d'acquisition et de consultation ("Reinscribing the 3rd dimension in epigraphic studies and transcending disciplinary boundaries" d'Eleni Bozia et Angelos Barmpoutis).

En matière d'épistémologie, nous nous trouvons aussi au milieu du gué : les auteurs de ces contributions se questionnent sur les problèmes théoriques posés par l'usage assumé des nouvelles technologies en général et par la modélisation 3D en particulier : E. Bozia et A. Barmpoutis reviennent sur les concepts d'authenticité, d'imitation et de copie ; S. Ganga met en exergue le lien entre les méthodes traditionnelles de lecture épigraphique et les nouvelles technologies et rappelle combien ces dernières s'inspirent des premières ; I. Triguero aborde le problème épistémologique qui pose le progressif remplacement de l'autopsie par des

36 Nous nous bornons ainsi à rappeler que, en France, les dépôts d'archives numériques froides (c'est-à-dire sans usage pour un temps long et réclamant une conservation à faible coût et durable) au Centre Informatique National de l'Enseignement Supérieur concernent de manière obligatoire uniquement les données sources et les résultats finaux, en suivant la forme minimale attendue d'un dépôt via Altag3D (le logiciel permettant la création d'une archive validée par le CINES).

37 Pour les caractéristiques des pierres utilisées comme supports épigraphiques et pour les processus d'érosion dont elles sont atteintes, voir dans ce volume, Triguero, 69-72.



modélisations et intelligences artificielles, tandis que G. Rocca et G. Sarullo voient la nouvelle autopsie des inscriptions comme une action synergique combinant la lecture directe du support et celle des modèles 3D<sup>38</sup>.

Enfin, nous sommes au milieu du gué des stratégies d'analyses, car de nouvelles manières d'analyser les données se présentent encore aujourd'hui : notamment sur la forme, avec la recherche de solutions analytiques depuis des outils surprenants, comme les analyses d'inscriptions dans des logiciels de SIG (Florent Comte et Coline Ruiz Darasse).

## BIBLIOGRAPHIE

- Aounallah, S., González Bordas, H. et Maurin, L. (2022) : "Deux nouvelles inscriptions municipales de Dougga", *Chroniques d'archéologie maghrébine. Revue de l'Association Historique et Archéologique de Carthage (AHAC)*, 2022-1, 126-129.
- Billanovich, M. P. (1967) : "Falsi epigrafici", *Italia medioevale e Umanistica*, X, 25-110.
- Bost, J.-P. (à paraître) : *Inscriptions Latines d'Aquitaine (ILA)*, Lemovices, Bordeaux.
- Bryan, P., Abbott, M. et Dodson, A. J. (2013) : "Revealing the Secrets of Stonehenge through the Application of Laser Scanning, Photogrammetry and Visualisation Techniques", *ISPRS Archives/International Archives of the Photogrammetry, Remote Sensing and Spatial Information Sciences XL (July)*, 125-129.
- Comte, F. (2018) : "L'utilisation des nouvelles technologies dans l'étude des inscriptions anciennes", *Travaux d'archéologie Limousine*, 38, 91-102.
- Comte, F. et González Bordas, H. (à paraître) : "Une nouvelle technique pour la publication des milliaires et sa mise en œuvre pour une borne inédite de Flavius Valerius Severus", in : Chaouali, M., Marmouri, K. et Rossignol, B. éd. : *Itinera Africana, L'épigraphie routière des provinces d'Afrique en perspective*, Bordeaux.
- Comte, F., González Bordas, H., Navarro Caballero, M., et Prevot, N. (2021) : "Tools Integration for Understanding and Deciphering Inscriptions PETRAE", in : Velázquez & Espinosa Espinosa, éd. 2021, 71-82.
- De Vos, M., dir. (2000) : *Rus Africum, Terra acqua olio nell'Africa settentrionale. Scavo e ricognizione nei dintorni di Dougga (Alto Tell tunisino)*, Trente.
- Fabián, J. F., Gimeno Pascual, H., Hernando Sobrino, R. et Pires, H. (2021) : "The 'Toros de Guisando' in the Digital Age", in : Velázquez & Espinosa Espinosa, éd. 2021, 91-104.
- Ganga, S., Gavini, A. et Sechi, M. (2015) : "Nuove tecnologie applicate alla ricerca epigrafica: alcuni esempi", in : Ruggeri, P., éd. : *L'Africa romana, Atti del XX Convegno Internazionale di studi, Alghero-Porto Conte Ricerche, 26-29 settembre 2013*, Rome, 1561-1584.
- González Bordas, H. et France, J. (2017) : "A new edition of the imperial regulation from the Lella Drebbilia site near Dougga (AE, 2001, 2083)", *Journal of Roman Archaeology*, 30, 407-428.
- Malzbender, T., Gelb, D. et Wolters, H. (2001) : "Polynomial Texture Maps", in : Pocock, L. éd. : *Proceedings of ACM SIGGRAPH. ACM*, New York, 519-528.
- Pires, H., Fonte, J., Gonçalves-Seco, L., Correia Santos, M. J. et Sousa, O. (2014) : "Morphological Residual Model - A tool for enhancing epigraphic readings of highly eroded surfaces. Information Technologies for Epigraphy and Cultural Heritage", in : Orlandi, S., Santucci, R., Casarosa, V. et Liuzzo, P. M. éd. : *Information Technologies for Epigraphy and Cultural Heritage, Proceedings of the First EAGLE International Conference*, Rome, 133-144.
- Pires, H., Martínez Rubio, J. et Elorza, A. (2015) : "Techniques for revealing 3D hidden archaeological features: Morphological Residual Models as Virtual-Polynomial Texture Maps", in : *ISPRS Archives, Volume Spatial*

38 Ces contributions ont pu être présentées et débattues dans le cadre du XVI<sup>e</sup> Congrès International d'Épigraphie grecque et latine, qui s'est tenu à Bordeaux en 2022 : <https://ciegl2022.sciencesconf.org/>.

XL-5/W4, 2015 3D Virtual Reconstruction and Visualization of Complex Architectures, 25-27 February 2015, Ávila, 415-421.

Velázquez Soriano, I. et Espinosa Espinosa, D., éd. (2021) : *Epigraphy in the Digital Age: Opportunities and Challenges in the Recording, Analysis and Dissemination of Inscriptions*, Oxford.

Vergniew, R., Bernard, J.-F., Chayani, M., Abergel, V., Benistant, P., et al., dir. (2017) : *Livre blanc du Consortium 3D SHS* [En ligne] <https://hal.science/hal-01683842v1> (consulté le 27/10/2023).

Verhoeven, G. (2019) : "Creating a digital future for the past through unanticipated directions", in : Del Medico, C., Dessaint, M., et Gorin, C. éd. : *Méthodes d'enregistrement des données en archéologie*, Paris [En ligne] <https://books.openedition.org/psorbonne/38461> (consulté le 27/10/2023).

Florent Comte

UMR 3495 MAP – MAP-Gamsau

Hernán González Bordas

UMR 5607 Ausonius, CNRS – Université Bordeaux Montaigne

Retrouvez la version en ligne gratuite  
et ses contenus additionnels



# THE FORUM CIPPUS NEW ELEMENTS FROM THE LASER SCANNING

Giovanna Rocca, Giulia Sarullo

---

## PRESENTATION OF THE INSCRIPTION

The inscription is engraved on a cippus known as the Forum Cippus<sup>1</sup> (**fig. 1**), from which it takes its name. The Cippus has been mutilated and it is missing its upper part for an unknown extension. The actual measuring is: 90 cm high, 47.90 cm wide and 52 cm long. It is still *in situ* in the Roman Forum, *Comitium* area, covered sacral compound of the *Lapis Niger*. In the literature it is generally dated to  $\pm$  VI c. BC; in EDR the dating is more precise: 580 BC/551 BC.<sup>2</sup>

The inscription is arranged on the four sides of the Cippus and on the edge between the fourth and the first side, on a total of 16 lines, the *ductus* is boustrophedonic with the exception of l. 12 and l. 16; lines 8 and 9 are capsized but continue the boustrophedonic *ductus*. Words are generally divided by three aligned vertical dots; the two cases in which only two dots are incised find a justification in a lack of space for the midpoint.

*Editio princeps*: Boni 1899. Concordances: *CIL*, I<sup>2</sup>, 1; *CIL*, VI, 36840; *ILLRP* 3; *ILS* 4913; EDR071720.

## FOREWORD (GR)<sup>3</sup>

From the year of the discovery, in 1899, to this day the literature on the Forum inscription tallies to 240 publications, a great majority of which is concentrated in the first two years – a testimony to the importance of the discovery. The debate resumed after P. G. Goidanich<sup>4</sup> published his work and then abated; from 1945 on, only a few articles on specific segments of the text were published and the inscription was inserted in some wide-ranging epigraphic works with an emphasis on its *ductus* and lettering.<sup>5</sup> The inscription caught the interest of several scholars of different fields: the linguists dealt with the “language” and tried to fit the new data in the peculiar picture of the very archaic Latin; on the other hand, epigraphists, historians, jurists and religious historians took an active part in the debate about the *ductus*, that offers hints for

- 1 Sometimes it is also called *Lapis Niger* through a metonymic process: this name comes from the association with a passage by Festus (L185) where the *niger lapis in comitio* “black stone in the Comitium” is mentioned.
- 2 EDR = *Epigraphic Database Roma* available at the URL: [online] [www.edr-edr.it](http://www.edr-edr.it) (seen on 27/1/2023).
- 3 The sections labeled as GR were written by Giovanna Rocca, those labeled as GS were written by Giulia Sarullo. The paragraphs that are not labeled are the product of both the authors.
- 4 Goidanich 1943, 317-501.
- 5 More specifically, there are 50 articles on newspapers as notice of the discovery; 23 academic papers in 1899, 27 in 1900 and only 34 in the 1903-1940 span; 21 papers from 1943 (Goidanich) to 1970; 39 from 1971 to 2000 and, finally, 33 from 2001 to 2021.



Fig. 1. Forum Cippus in situ, shot of side A, the inscribed edge (side E) and, partly, of side D. Photo by M. Muscariello.

the reading technique, on the typology of the inscription (“law” or “laws” inside the legislative corpus of the Rome of the Kings preserved by the ancient sources) and on the religious issues connected to specific words or interpretations.

Two monographs, published in 2009 and in 2016<sup>6</sup> respectively, did not add anything new. They simply offer an interpretation, selected among the several already proposed, and speculate on old data that the authors did not check in person.

It seems then that a scholar who would like to deal with this inscription could only provide a historiographic update that summarizes the epigraphic and interpretative *status quaestionis* with a comment and a revision due to the new epigraphic findings in the *Latium vetus* and to the new studies on the alphabets and the literacy of the archaic Latin.

One should also take into consideration the difficulty of an autopsy, essential in this kind of research, because the area of the *Comitium* has been closed to the public for several years now for safety reasons. The Soprintendenza, always very helpful and open to the requests

6 Battaglini 2009; Santoro 2016.

by the scholars, cannot obviate to the objective technical issues that make really difficult the observation of two of the sides of the Cippus, placed in an internal position and scarcely illuminated. The last scholar who had seen the Cippus in person was A. L. Prosdocimi in 2010. Most of the researchers who have studied the inscription have worked on the photographs and on the drawings which sometimes are highly dissimilar.

A new event reversed the situation.

### THE *LAPIS NIGER* PROJECT (GR)

The progress in the use of the new technology in support to the study and preservation of the cultural heritage – that has recently attracted the attention of several Universities aiming at facing the study of the inscriptions in an innovative way – was actively adopted by the Soprintendenza Speciale per il Colosseo, il Museo Nazionale Romano e l'Area Archeologica di Roma. In the context of the program of protection and valorization of the Roman Forum and the Palatine, in 2015 the Soprintendenza started a plan for the acquisition of the scientific documentation using the most updated digital technologies in order to obtain the tridimensional volumetry with the laser scanner, the videophotographic documentation in high definition and the digital mapping of the area.

The intervention on the Forum inscription was part of this wide project directed by the archaeologist Patrizia Fortini and the architect Maddalena Scoccianti. In the future, the results will be used not only for research and preservative purposes, but also as a tool of touristic promotion of high cultural content. An example of this will be the augmented and virtual reality of the *Lapis Niger* area presented by means of a 3D model in high definition. This model will be used through a mobile app (one of the sections of the App of the Roman Forum known as “Imperial For a”) compatible with the last generation mobile phones. Also the Cippus will be tridimensionally observable from every angle: the 3D modeling represents a modern tool, scientifically valid and, at the same time, attractive for the public.

The digital acquisition of the inscription by the technicians took place on July 3rd, 2015 and it was presented to the press (*Il Messaggero*, July 4th, 2015) together with a development version of the mobile app; the participants had the possibility to test the virtual reality technology and to look at the tridimensional model of the Cippus.

For this project, the Soprintendenza availed itself of a collaboration with the VisivaLab S.L. society, who operated in partnership with FARO (world leader in the research on laser scanning<sup>7</sup>) as beta-tester of the most innovative products and with the Roman start-up Oniride s.r.l., that is specialized in the designing of cutting edge ways to access the cultural heritage, taking into consideration both the necessity to preserve it and access it as well as its gamification. The team was made up by the archaeologist Patrizia Fortini, at the time responsible for the Roman Forum area for the Soprintendenza Speciale per i Beni archeologici di Roma, by the group of linguists from the IULM University in Milan (G. Rocca, G. Sarullo and M. Muscariello) and by Riccardo Auci of VisivaLab S.L. who operated in collaboration with Oreste Adinolfi (who represented FARO) for the analysis commissioned by the Soprintendenza.

7 In the past, the Soprintendenza used the high-tech FARO devices in its excavation sites of the segment of the *Cloaca Maxima* comprised in the Roman Forum area, which was digitally acquired by means of FARO's laser scanner technology used together with a prototype of the automatized survey device called *Archeorobot*.

The analysis ended in the morning and the possibility to see the preliminary results of the laser scanning on a computer on site was very helpful in guiding the technicians on the most critical points; contextually, an autopsy of the Cippus was conducted with the help of a very powerful source of light.

The great amount of data resulting from the digital acquisition, besides the usual commitments of the Soprintendenza, including the emergency interventions in Rome, and the necessity of continuous checking and analysis of previous excavations, dilated the time of the publication of the comprehensive volume, entitled *Il Comizio dei Re*, soon to be published by L'“Erma” di Bretschneider.

## THE LOCATION OF THE CIPPUS (GR)

The Forum Cippus is located below the *Lapis Niger*, a “platea lastricata di marmo nero” (a slab paved with black marble), in G. Boni's words, in a location that is still visible but difficult for archaeologists and researchers to access, such that it prevents study in detail.

The *Comitium* and the sacred area of *Lapis Niger* represent one of the fundamental sites in the history of Rome: frequented from ancient times,<sup>8</sup> from the period of the monarchy to imperial times, it has always held a strong symbolic value. The team's archaeologists have reviewed the excavation records and compared old and new data to offer a more detailed view useful for the reinterpretation of the complex context of the area. This has yielded, among other results, a plan of the area from its origins to the Republican age.<sup>9</sup> G. Boni meticulously reports in his “Excavation Diaries” and in his private correspondence with Minister Baccelli the results of his excavations: on Tuesday, January 30th, 1899, the *lapis niger*, resting on topsoil covering an esplanade holding two bases, was found; beyond the western one, behind a truncated cone, our Cippus was found on May 30th.<sup>10</sup> Excavations in the area continued after a substantial interval due to the difficult situation in Europe at the turn of the two wars. They were conducted by P. Romanelli and M. Floriani Squarciapino between 1954 and 1961, and only the former published some data in an independently published pamphlet after thirty years.<sup>11</sup> I briefly summarize the events that characterized the period between the late VI and first half of the V c. BC, that concerns the presence of the Cippus, by drawing on the work of archaeologists:

- the arrangement of the area rises on the previous phase and constitutes the first monumental phase up until the end of VI/first half of V c. BC with a plaza bordered by terraces;
- the steps do not consist of a series of parallel steps but have a fan-shaped arrangement at the beginning of which the Cippus will be placed;
- in the second half of the VI c. BC the Cippus is placed on the part of the highest steps, but rests with the front portion of the base directly on the *Comitium* square, configuring itself as the fulcrum of the staircase arrangement;

8 The most ancient stratigraphic phase can be dated to the Iron Age (second Latial phase, IX-beginning of the VIII c. BC).

9 The news on the excavation of the *Comitium* and of the Curia will be published in *Il Comizio dei Re*, edited by A. Russo, published by L'“Erma” di Bretschneider.

10 The data were published in the following June, with four reports by G. Boni (archaeological context), G. Gamurrini (paleography), L. Ceci (interpretation of the text), G. Cortese (content of the inscription).

11 Romanelli 1984. The first systematization of the data resulting from the research by Maria Floriani Squarciapino and the first critical re-edition of P. Romanelli excavations can be found in Carafa 1998.

- ▶ the original base of the Cippus is at the same height as the highest step of the second royal steps;
- ▶ the layout of the square remains unchanged until the beginning of the Republican age, and even after the construction of the *Rostra* the Cippus will be visible; the new pavement will cover the lower part of it.

The dating within the VI c. BC remains confirmed: the junction of data between ancient tradition and modern analysis for the place where the Cippus is placed alludes to a chronological span in which the legal/religious ideology is significant and the position of the Cippus implies a strong motivation for the quality of the text written on it.

## THE MATERIAL OF THE CIPPUS (GR)

G. Boni describes it simply as a tuff cippus. Tuff is the label currently employed in archaeology and geology in a way that is not entirely correct because the volcanological component of this pumice-rich material is left out.<sup>12</sup> Different designations exist in the literature starting with “lionate tuff” or “lithoid tuff”, often accompanied by color descriptions such as yellow or red brown lionate tuff, *tophus ruber*, *lapis pallens*.<sup>13</sup> These characteristics derive from the typical tawny color of its most characteristic facies, but in fact brown, yellowish, and gray variants are also common. Lately there has been a return in the terminology to the classic “lionate tuff” version, which has supplanted the others.

The lithoid tuff of the Albani Hills Volcano is widely spread in the Roman area, especially south and southeast of Rome; initially quarried from the Capitoline Hill latomies and later from the quarries along the Aniene River, it is the material used for the construction of many monuments and it is excellent for its intrinsic characteristics: it is light, porous, insulating, easy to extract, and inexpensive, being locally available and, as a consequence, guaranteeing speed of extraction and economy of transport.

An analysis of some monuments between the Republican and Imperial ages has shown the use of large blocks (111-200 cm long; 52-90 cm wide; 52.5-67 cm wide<sup>14</sup>) that could offer a basis for comparison with the surviving measurements of the Cippus.

How is the material of the Cippus described from G. Boni onward? Scholars generally limit themselves only to observations about the ruin of the stone. F. Ribezzo, points out the particularities of the material:

*Nel mezzo dei rigli i guasti provengono da contusioni o corrosioni naturali del tufo, nella parte superiore da decurtazione violenta o da riduzione necessaria dell'altezza della stele, ragione per cui i margini presentano scheggiature o sverzature più o meno estese e più o meno profonde. Appunto perciò nel costituire il testo bisogna guardarsi dal mettere in valore cavità o intacchi che risultino a un piano inferiore del fondo delle incisioni delle lettere. Di questi falsi piani calco e fotografie<sup>15</sup> ne presentano parecchi [...].<sup>16</sup>*

P. G. Goidanich, however, reopens the issue in a special chapter, entitled “Il materiale litico” (The Lithic Material), of his “almost” monograph, actually a nearly 200-page article, which is worth mentioning for some interesting points:

12 Of pyroclastic origin, that is, formed by the accumulation of fragments of volcanic materials.

13 A rich overview of the terminology used for description can be found in De Casa *et al.* 1999, 1, fn. 2.

14 Frank 1924 and Lugli 1957.

15 On this matter, see paragraph 5.

16 Ribezzo 1933, 63.

*ò l'impressione che gli studiosi dell'iscrizione non si siano soffermati a considerare la natura geologica del materiale adoperato per la stele, o non l'abbiano fatto con sufficiente attenzione. Era utile il farlo perché da siffatto materiale sono provenute nel corso dei secoli certe alterazione della superficie che si vedono più o meno chiaramente anche sulle fotografie e che furono variamente e in definitiva non bene interpretate quali segni di lettere; taluno fu portato perfino a ritenere che l'iscrizione fosse un palinsesto, dato che tali segni anche strani non si comprendeva come fossero originati; inoltre si sono formati sulla superficie una gran quantità di buchi e bucherelli che pur si vedono chiaramente nelle fotografie. Esaminando direttamente la stele mi pareva che una parte di questi buchi si fossero otturati, dopo il seppellimento, con terriccio e pertanto fossero preesistiti all'iscrizione.<sup>17</sup>*

The polemical and critical stance and a certain attitude of superiority toward those who proceeded him, a constant in his work, alongside an accomplished knowledge of the previous literature,<sup>18</sup> emerges from the argumentation of his discourse. There he shows his astonishment that neither the autopsy nor the photographic analysis had raised questions about the stone. The consideration that the importance of the Cippus, placed in a relevant position in an equally relevant area, was not also followed by the choice of a quality material prompted him to ask for an analysis of the material. He turned for this to G. De Angelis D'Ossat, referred to him by a colleague for his excellent knowledge of the subsoil of Rome.

However, this is not an original procedure: in 1919 T. Frank had met A. Verri, who had been working on the geology of Latium for some time and who, at that moment, constituted an authority on the subject. A. Verri showed T. Frank his method conducted on chemical analysis and by means of microscopic images, to identify the provenance of the tuff of various monuments.

P. G. Goidanich reports:

*ò appreso che il materiale della stele è una ben nota specie di tufo litoide in cui si trova commista molta pomice: al momento dell'estrazione dalle cave, in siffatto materiale litico il tufo e le pomici formano una massa compatta, come è visto in un esemplare didattico mostratomi; ma col volgere del tempo le pomici marciscono, assumendo un aspetto terroso, e quando cadono dan luogo a questi buchi e lacune.<sup>19</sup>*

As T. Frank had done previously, so P. G. Goidanich takes advantage of a demonstration lecture. G. De Angelis d'Ossat, in 1950,<sup>20</sup> takes up the subject by publishing a more detailed analysis of the stone of the Cippus, believed until then, by the vulgate, to be yellow tuff from Grotta Oscura, coming to the conclusion that a more generic provenance, with no precise location, identified with the Veientina-Capenate area of eastern Sabazia, should be thought of.

A. L. Prosdocimi, in a tight critique of Goidanich, whose *modus operandi* he disagrees with, addresses the issue of punctuation for which the scholar had warned "nell'attribuir valore di interpunzione, a bucolini che possono essere conseguenza della composizione geologica del masso." On the basis of an unspecified source, A. L. Prosdocimi states that "è un tufo che, a differenza di altro tufo, è resistente al dilavamento: pertanto la pietra dovrebbe essere ben conservata rispetto alla data del rinvenimento", *i.e.*, in 1899 the surface was already deteriorated and the current conditions were not due to washouts occurred after the discovery.<sup>21</sup> The two positions are not mutually exclusive.

A combination of factors may have contributed to the deterioration of the stone by altering its appearance, texture, and properties; mostly these are due to a combination of

17 Goidanich 1943, 387.

18 The palimpsest quote is taken from the reading by Leifer & Goldmann 1932 and Warren 1907, 376.

19 Goidanich 1943, 388.

20 De Angelis d'Ossat 1950.

21 Prosdocimi 2010, 391.



external factors related to environmental conditions and internal factors related to physical and mechanical strength. The intensity and speed of these processes depend on the stone quality. It is often not easy to identify the causes and mechanisms of deterioration since they can be numerous and act in parallel, in different ways and with different timing.<sup>22</sup> In this regard, the question posed by P. G. Goidanich whether the high level of quality required by a public document is matched by an equally happy choice of material to be used should be taken up. Indeed, the inadequate choice of stone and the method of quarrying, processing and finishing that can cause superficial microfractures are concomitant among the reasons for accelerating the natural process of decay. Moreover, lithoid tuff is a porous material of varying percentages, and porosity is a determining parameter for the possibility of water absorption, which is the main trigger of decay, and the *Lapis Niger* area was rich in water and springs. Therefore, it seems reasonable that the Cippus was found in the condition we know, then further aggravated by human intervention that caused the breakages it suffered after its discovery.

Further clarification will come from the results of the petrological analyses conducted by the team of geologists, that will be published in the volume dedicated to the *Comitium* edited by the Soprintendenza (see footnote 9).

## TECHNOLOGY (GS)

The Soprintendenza chose to use the next-generation technology of the FARO's CAM2 ARM device for the laser scanning procedure. This device provided a very high-precision (0.051 mm) acquisition of the archaic Latin inscription engraved in boustrofedic *ductus* on the cippus below the *Lapis Niger* (fig. 2).

The CAM2 ARM was at that time a state-of-the-art instrument in the field of laser scanning acquisition, which allowed scanning 460 thousand points of the inscription in one second with a very high resolution. It consists of a mechanical arm that moves around the support detecting all data to the hundredth of a millimeter. The portable and easy-to-use CAM2 measuring arm enables highly accurate 3D measurements on large and small volumes as early as the production stages:

*Le ridotte dimensioni dello strumento (per un peso complessivo di circa 200 gr) e la presenza di sensori intelligenti integrati permettono di effettuare misurazioni precise in contesti ristretti, e con caratteristiche termiche variabili. La definizione del braccio è di 36 µm, precisione invisibile all'occhio umano, che permette dunque di individuare tracce archeologiche importanti (ad esempio direzione e profondità di segni di scalpellatura ormai erosa) non rilevabili con una normale strumentazione.*<sup>23</sup>

The scanning activity was followed by a laborious phase of data processing, conducted by the VisivaLab team under the guidance of R. Auci, which led, on the one hand, to the development of the high-definition 3D model mentioned above in paragraph 1 and, on the other hand, to the

22 In a study that is highly valuable to non-geologists, some data obtained from constructions frequent from 143 B.C. to the imperial era are reported, the most relevant to us being the manifestations and causes of degradation such as, among the most frequent, micro-cracking, scaling, exfoliation followed by salt efflorescence and the presence of moss and lichen, cf. De Casa *et al.* 1999.

23 Information taken from the description of the "Lapis Niger. Acquisizione digitale dell'iscrizione sacra" Project, sponsored by the Soprintendenza Speciale per il Colosseo, il Museo Nazionale Romano e l'area archeologica di Roma, 3. The document is available online at the following address [online] <https://www.beniculturali.it/mibac/multimedia/MiBAC/documents/feed/pdf/Progetto-imported-51773.pdf> (seen on 24/01/2023).



*Fig. 2. The laser scanning of the Forum Cippus (July 3rd, 2015) with the CAM2 ARM device by FARO. Photo by M. Muscariello.*

production of images that highlight details invisible to the naked eye that were of great interest for the study of the execution of the inscription.

From the point cloud obtained with the laser scanning different types of images were processed, to which we had access thanks to our collaboration with the Soprintendenza, in particular with Dr. P. Fortini, head of the project, whom we would like to thank.

Specifically, for each of the sides of the Cippus (4 sides plus an inscribed edge) 5 different types of images were produced that offer different points of view of the inscribed surface: 3 rendering with a different degree of grazing resulted in images that are as close as possible to an actual grayscale photograph; in addition to these, a rendering with contour lines and another with the gradation of depth highlighted by a color scale were created.

Each of these types of images highlights in turn different peculiarities of the stone surface and, consequently, of the epigraphic signs: in some renderings, for example, the depths of the signs emerge more clearly, while in others the contours of the carvings are better outlined. In order to make the most of the laser scanning results and avoid the risk of a partial view an in-depth analysis was necessary with a continuous comparison of all digital rendering for each individual portion of the surface undergoing analysis.

## PROBLEMS AND SOLUTIONS (GS)

As mentioned above, the location of the Cippus has played an important role in the history of studies of the inscription. It is, in fact, located under the floor of the *Lapis Niger* and surrounded by other ancient structures, as well as by the supports placed by archaeologists to prevent the collapse of the mentioned floor. There is less than a meter of height between the floor on which the Cippus rests and the floor above. The sum of these conditions indicates that the place where the Cippus is located is rather cramped and dark, factors that have significantly influenced not only the (rare) in-person examinations by scholars, but also the making of reproductions (photographs and apographs).

The issue of accessibility also involves a difficulty in arranging sufficient and valid lighting for the examination of such a heavily damaged inscription engraved on such an easily compromised surface. In the course of the laser scanning, a very powerful portable light source was used, which allowed the technicians to operate safely and, at the same time, allowed us linguists to examine in more detail some of the controversial points of the inscription (**fig. 3**).

The specific characteristics of the instrument chosen for scanning, the CAM2 ARM described above, allowed to overcome the difficulties posed by the narrow space.<sup>24</sup> Due to the position of the Cippus in relation to the surrounding structures, side C and, to a lesser extent, side D are significantly less accessible than sides A and B and edge E.<sup>25</sup> Thanks to the articulated arm of the instrument, which was positioned from time to time at precise points or manually maneuvered by the technician in charge of scanning, it was possible to digitize the entire surface of the Cippus.



*Fig. 3. A moment of the autopsy of the Forum Cippus carried out with the help of a portable light source. Photo by M. Muscariello.*

- 24 To get an idea of how complex it was to carry out the laser scanning of the Forum Cippus, you can view the video available at this link: [online] <https://vimeo.com/217805081> (seen on 27/1/2023).
- 25 It is not by chance that the photographer D. Anderson only took pictures of sides A and B. Cf. Sarullo 2023. Already D. Comparetti, immediately after the discovery, had posed the problem of the difficulty of taking photographs of the cippus.

The presence of a multidisciplinary team during the digitization operations led to a fruitful collaboration between linguists, epigraphists, archaeologists and technicians, which had as a happy outcome the possibility of contributing profitably, each for his or her part, to the realization of the scanning. The task of us linguists and epigraphists, who are well acquainted with the graphic and epigraphic peculiarities of the inscription and the difficulties posed by the tuffaceous surface, was to indicate the points that required more attention from the technicians operating the instrument and then to verify on the stone, with the help of a portable light source, the first tentative results that emerged from observing the images produced in real time by the scanner (**fig. 4**).

We will discuss some of these points in detail hereinafter. Here we would like to emphasize the interaction between different scientific fields. Methodologically speaking, any study of an epigraphic text cannot be separated from an autopsy of the support. This, of course, is strictly theoretical. We are well aware that an autopsy of the support is not always possible, for a wide variety of reasons (*e.g.* object dispersed or kept in unreachable storage or, as in our case, still *in situ* but not accessible), and this is why reproductions (plaster copies, photographs and apographs) are used. Unfortunately, these can sometimes be misleading and lead to erroneous readings. The case of the Forum Cippus, in this sense, is emblematic. Due to the monument's hypogeal location and the resulting poor lighting conditions, high-resolution photographs of the object with appropriate illumination have never been taken. Moreover, for some of the sides only shots that are more than 120 years old are available<sup>26</sup> and thus in a quality that is certainly not sufficient to allow an accurate reading of the most controversial points of the inscription; of the inscribed edge no photographs exist. The most recent shot of the Forum Cippus is 40 years old and depicts only face A and part of face B.<sup>27</sup>

The plaster copies are certainly valuable witnesses to the state of preservation of the Cippus before the various breaks that further damaged the Cippus, which was already in poor condition at the time of discovery. However, they are not always trustworthy: the patinas covering the surface of the plaster, for example, make it very difficult to distinguish between punctuation and accidental holes. Finally, the apographs, due to the inaccessibility of the original Cippus, were often traced from the plaster copies and are therefore not always accurate.

From this account, it is clear that the autopsy of the Forum Cippus is crucial in order to settle some doubtful points about the reading of what remains of the inscription. Nonetheless, an autopsy can always be "flawed" by the eye of the beholder who may perhaps be looking on the stone for what he or she wants to see. An autopsy, however, that is supported by the images resulting from laser scanning, which returns a most accurate reconstruction of the stone surface, acquires greater objectivity and, consequently, greater authority and provides the basis for as faithful a reading as possible. In the words of R. Auci<sup>28</sup>:

"survey in 3D of the 'Cippo del Foro' allows the documentation [...] of every single mark that may be drawn on the memorial. Research on the meaning of the text may thus avail itself of an instrument apt at facilitating its transcription and its reading."

26 These are R. Moscioni's shots, now in the Photography Archive of the American Academy in Rome, depicting all four faces inscribed but not the edge. The images are accompanied by the following caption: "Roman Forum (Rome, Italy), archaic stele with inscription, found under the Lapis niger. 4 photographic prints: black and white; 11x16 cm." In the copy available to us, the image of face C appears cropped at the left margin. A complete copy of the positive is available from the Istituto Centrale per la Grafica, [online] <https://www.calcografica.it/fotografie/inventario.php?id=F-P4273> (seen on 27/1/2023). Moscioni's four photographs were published, without attribution, in Diehl 1912, tav. 1. Cf. Sarullo 2023.

27 Gordon 1983.

28 Auci 2021, 268.



*Fig. 4. A moment of the laser scanning. The articulated arm of the CAM2 ARM device is visible, as well as the computer that was showing the first results of the scanning. Photo by M. Muscariello.*

#### A SYNERGIC APPROACH TO THE EXEGESIS OF THE INSCRIPTION (GS)

An epigraphic document of the complexity of the Forum inscription has several critical issues, ranging from the interpretation of lacunae or damaged signs to the identification of a punctuation system. The examination of the different types of images resulting from laser scanning allowed us to have a new, privileged point of view to try to give answers to some of these critical issues. Of course, scanning cannot give us back what has been irretrievably lost over time, but it allows us to work on the inscription almost as if we had the actual object in front of us. It should, however, be emphasized that, on more than one occasion, the autopsy examination of the stone surface was instrumental in dissolving some of the doubts that the observation of the different types of images could not resolve because the renderings returned partially discordant results.

We can therefore define our approach to the exegesis of the inscription as a synergic one, in that it involves the contextual recourse to all types of images derived from laser scanning (continually compared with each other) and in-person observations of the monument, as well as to reproductions (photographs, apographs, plaster copies) made in the past.

We will illustrate below some of the aspects of the reading and exegesis of the inscription of the Forum Cippus that have benefited from the possibility of making use of this synergic approach, thanks to which it has been possible to definitively set aside some past hypotheses and, above all, to advance new interpretative proposals.

## Preparatory lines (GS)

Before we proceed to describe some important new features that have emerged in the reading of the text of the inscription, we would like to dwell on an epigraphic element present on the Cippus, which no scholar in the past had previously accounted for. On side D, between l. 14 and l. 15, more precisely between UQEN and the underlying OD:IO, the analysis of the images produced by the laser scanning have made it possible to identify a remnant of a line (fig. 5 and 6) that runs almost parallel to the lines of writing, slightly waning, and appears to be interrupted at the fourth letter from the left (N for l. 14 and O for l. 15). An even milder line, for which identification is therefore less certain, is perhaps detectable below l. 15,<sup>29</sup> particularly below the same O above which the upper line is interrupted. These lines, which are not perfectly horizontal and regular, appear to have been engraved freehand, without the aid of a specific tool. The most likely hypothesis is that they are a remnant of the tracing of preparatory lines executed on the sides of the Cippus in the *quadratura* stage to distribute the lines of writing in a more balanced and precise manner. The fact is definitely of some significance because it would document the use of this practice, which would later be the norm for most public inscriptions on Cippus and stelae, even in the early days of Roman epigraphy. The use of preparatory lines on the Forum Cippus, however, should not be interpreted in the same way as the guide lines were used in the inscriptions of the Republican and Imperial ages, in which these tracings are the reference point for the engraving of the letters, all of which start at the same height on the writing field. In our case this would more likely be an expedient to better distribute the lines of writing on the surface, as evidenced by the fact that the letters on the Forum Cippus, in most cases, are not aligned at the base.

A hint of the possible presence of preparatory lines on this monument is already found in P. Graffunder, whose unpublished observations on the Forum inscription we only know through the account by F. Leifer.<sup>30</sup> Indeed, the scholar refers to the presence, alongside the axe blows responsible for the damage to the Cippus, of a *Vorzeichnungslinie* on side D:

*[Graffunder] verweist auf die an der Stele deutlich sichtbaren Spuren von Axtschlägen sowie auf eine Vorzeichnungslinie, die angeblich am jetzigen oberen Rand des Cippus z. T. durch die erhaltenen Buchstabenreste hindurchgeht*<sup>31</sup>.

Footnote 5 then specifies that *Diese Linie, teilweise den Duktus der eingehauenen Buchstaben folgend, ist unterhalb des oberen Randes der Seite D in der Tat bemerkbar*. It would seem that, according to P. Graffunder, this line ran below the upper edge of face D and not between the lines. To our knowledge, the scholar based his observations on images of the plaster copies circulating at the time and not on the original. It is then possible that the line he describes is in fact one of the cut lines<sup>32</sup> that characterize the plaster copies. In any case, this element has never been given any relevance by later scholars, and F. Leifer himself seems to prefer the possibility of a “Steinpalimpsest”, already suggested at the time by M. Warren (1907, p. 376), that is, that the stone was reused and these marks are traces of an earlier inscription.

29 The tracing of the line between l. 14 and l. 15 is also clearly evident on the surviving plaster copies of the Cippus, particularly on the Viennese specimen, while there appears to be no line below l. 15. For a survey of the plaster copies, see Sarullo 2023.

30 Cf. Leifer & Goldmann 1932, 1, n. 5.

31 Leifer & Goldmann 1932, 15.

32 The plaster copies were fashioned from a cast made by applying a thick layer of clay to the surface of the Cippus; once dried, the cast was sectioned for removal and then reassembled by joining the individual sections together. At the areas where the clay cast was incised and then joined, lines, called cut lines, can be found on the plaster copies.



Fig. 5. Forum Cippus, side D, where the preparatory line can be seen between l. 14 and l. 15. Photo by M. Muscariello.



Fig. 6. Forum Cippus, detail of side D, rendering from the laser scanning where the preparatory line can be seen between l. 14 and l. 15. Soprintendenza di Roma.

An element similar to what we detected on side D had been identified by D. Comparetti<sup>33</sup> on side C between l. 9 and l. 10. This line ran above the OD:I segment, so close to the upper end of the graphs as to make the I look almost like a T. D. Comparetti<sup>34</sup> speculates that this was an expedient to mark the beginning of a new part of the inscription, a kind of *paragraphos*. Unfortunately, the surface on which this section subsisted was affected by a break<sup>35</sup> that led to the loss of a small portion of the tuff, and as a result, only the lower portion of the line identified by D. Comparetti remains on the original, barely visible above D:I in the renderings of the laser scans, while it is still well preserved on the plaster copies.

The fact that this line is at the same height as the one we identified on side D and shares its characteristics of length and thickness would seem to be further confirmation of the existence of preparatory lines on the Forum Cippus. This has important consequences for our knowledge of the preparatory stages that preceded the engraving and distribution of the text on the writing field.

### Reading improvements (GS)

Our synergic approach to the exegesis of the inscription resulted in some significant improvements in the reading, particularly on sides A and B. Our attention focused mainly on the letters along the upper margin of the Cippus, those most damaged by the destructive intervention that occurred in antiquity and deteriorated by the smoothing of the surface caused by the washouts that have affected the Cippus over the centuries. This is the case, for example, of l. 2, where what appears to be the result of water runoff has practically obliterated the first surviving marks, in particular, the A of *ŞAKROS*, of which only the upper part of the two oblique strokes joining at the top remains (**fig. 7**). The laser scanning, on the other hand, allowed to identify the upper section of the S, given for certain in the text by almost all editors but actually to be marked as an uncertain letter because its actual condition on the stone makes it almost invisible to the naked eye (**fig. 8**).

On the same face, at l. 3, the letter nearest the upper margin has been the subject of numerous interpretations. What remains is a vertical stroke on which an oblique stroke is grafted at the vertex, variously read as A, D or M. Laser scanning images made it possible to rule out the possibility of a D because near the bottom of the vertical stroke there are no traces of the possible loop of the D. One can see, instead, a hint of a crossbar, ascending in the direction of writing, similar to the A of l. 13 (**fig. 8**).

Digital rendering analysis has made the most substantial contribution in the reading of side B, particularly for l. 4. This is the most battered row of what remains of the Cippus, with only 3 letters still clearly legible: ]-a--as, around which the most daring and imaginative interpretations have been proposed, which we cannot go over here, for obvious reasons. Our approach was to start from what the stone preserved and what the digital images returned. First, we were able to identify as an isolated trait, and therefore not belonging to an epigraphic element, the oblique sign located at an intermediate height between l. 4 and l. 5. In the past, this stroke had been read as a lower portion of a three-stroke S or as another letter, an option that has to be ruled out now. Our attention then focused on l. 4, comparing what we had verified by autopsy and what the digital images allowed us to integrate. The sum of these two procedures led us to identify, to the left of the first A, a vertical stroke that curved to the right at the top.

33 Comparetti 1900, 9.

34 Comparetti 1900, 12.

35 On the breakings occurred after the discovery of the cippus, see Sarullo 2023.





*Fig. 7. Forum Cippus, side A, where the corrosion of the stone is clearly visible between l. 2 and l. 3. Photo by M. Muscariello.*

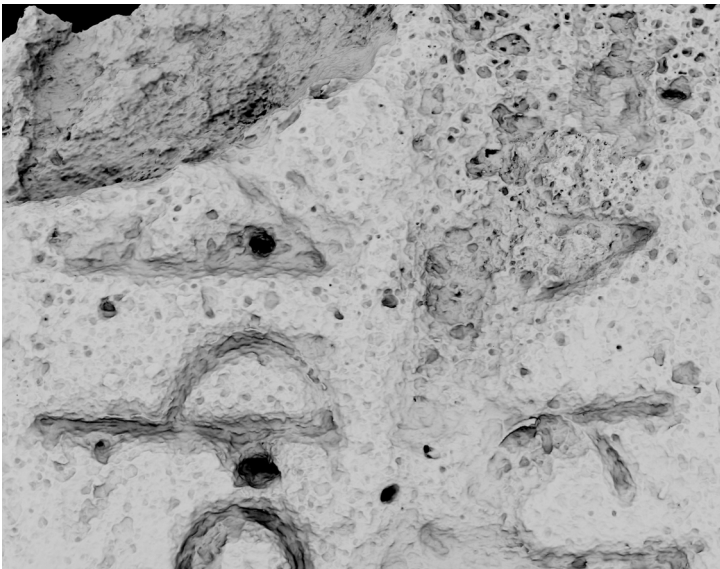

*Fig. 8. Forum Cippus, detail of side A, rendering from the laser scanning showing the letters immediately under the upper margin. Soprintendenza di Roma.*

The proximity to the next A and the slight curvature of the upper section led to the hypothesis that this letter was a P, a hypothesis later confirmed by superimposing on this unknown mark the only surviving P specimen on the Cippus, attested at l. 11, and obtaining an almost complete match. We then proceeded to observe the portion of the stone between the two A and were able to identify a semicircular outline that fits that of a C such as that found on the next l. 5. Then, color rendering, that shows the different depths of the carvings, allowed us to see that the vertical stroke preceding the second A, contrary to what had been thought in the past, is an isolated stroke that should therefore be interpreted as I. We thus read l. 4 as PACIAS (**fig. 9**).

Finally, at l. 6, the possibility of the D]EUAM restoration, so successful in the past, cannot be eliminated, but too many interpretive possibilities remain open to allow one to be selected at the expense of others.

### Writing errors (GS)

The presence of errors in the execution of the inscription of the Forum Cippus had already been pointed out by early editors, as can be seen, for example, from Comparetti's apograph in which an error in the anticipation of Y over Q in l. 13 is evident (**fig. 10**). Another example can be discerned in the insertion of I after P in KAPIA at l. 11: the size of I seems to be a clear indication that this was the result of an intervention after the engraving of the later A. In the course of the autopsy that took place the day of the laser scanning we were able to observe another example of an error on this same line, and again it is an anticipatory error, here of T over O in DOTAU[ (**fig. 11** and **12**). Some of the images of the laser scanning later confirmed this correction. It should be pointed out here that not in all digital renderings is this corrective intervention actually clearly visible; in this case, therefore, but it is definitely not the only one, the association of autopsy and digital image observation was decisive, further confirming that these are not mutually exclusive procedures but, on the contrary, gain much in authority and allow much more accurate results when both can be used.

### Identification of punctuation marks (GS)<sup>36</sup>

Throughout the inscription of the Forum Cippus there is a punctuation mark separating individual words. In the past, scholars have offered the most diverse explanations in an attempt to account for an alleged randomness in the distribution of the punctuation marks. The tuff of which the Cippus was made (for which see *supra*, at paragraph 3) has a rather irregular surface in which there is no shortage of holes of various sizes that can easily be mistaken for the holes intentionally incised by the stone mason as punctuation marks. To solve the punctuation puzzle on the Forum Cippus we have, once again, relied on laser scanning images, which, again, was decisive, but not without some difficulty. The extreme precision with which the laser scanner captures every minute detail of the stone surface has as an inevitable consequence that of returning images studded with significantly more holes than those visible to the naked eye. It was therefore necessary to establish precise criteria that would guide us in identifying the punctuation marks and allow us to distinguish them from accidental holes on the surface. We therefore identified three characteristics that could be distinctive:

36 We share here some remarks resulting from our team's observation of the inscription, within which the topic of punctuation was explored in depth by Marta Muscariello, who devoted to this topic an article now in print, see Muscariello forthcoming.



Fig. 9. Forum Cippus, detail of side B, rendering from the laser scanning showing l. 4 and 5. Soprintendenza di Roma.

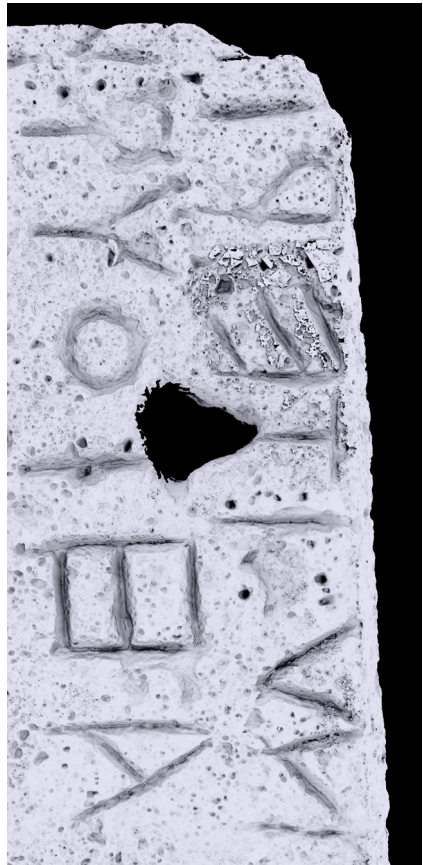

Fig. 10. Forum Cippus, detail of side D, rendering from the laser scanning showing l. 12 and l. 13. Soprintendenza di Roma.

- contour: it is more regular in punctuation marks while it is generally more jagged in accidental holes;
- depth of engraving: for this criterion we made use mainly of images with the gradation of depth highlighted by a color scale;
- alignment: holes that constitute a punctuation mark are generally well aligned vertically with each other, while accidental holes have a more random arrangement.

Following these guiding criteria, careful observation of the different types of images available to us was carried out, and it was possible to establish that the use of punctuation throughout the inscription is far from random and, in fact, follows a certain rigor. Indeed, the punctuation mark always consists of three vertically aligned dots except on two occasions when it presents itself with two dots, in l. 14 and l. 15. In both cases, the absence of the midpoint could be due to a lack of space. As a matter of fact, here, as elsewhere, the punctuation seems



Fig. 11. Forum Cippus, detail of side C, showing the anticipatory error on l. 11. Photo by M. Muscariello.

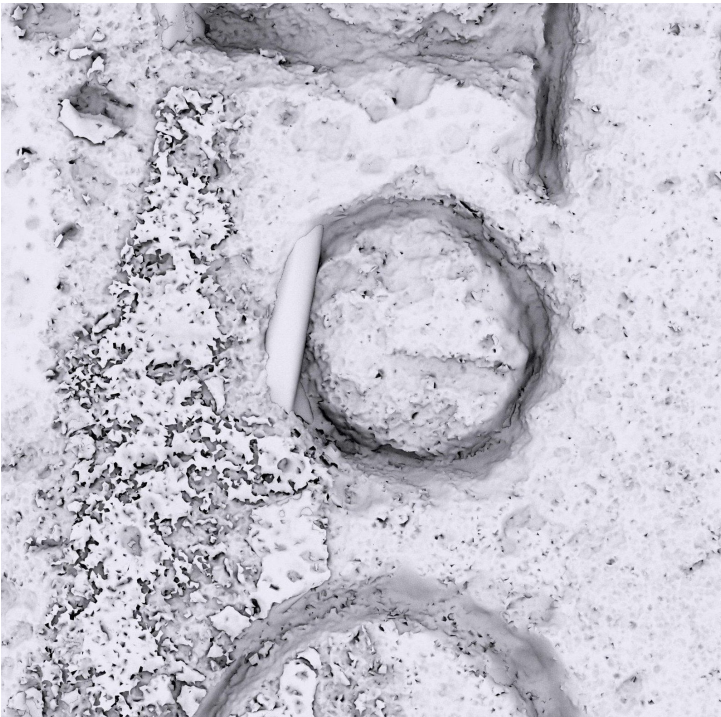

Fig. 12. Forum Cippus, detail of side C, rendering from the laser scanning, where the anticipatory error on l. 11 is barely visible. Soprintendenza di Roma.

to have been added at a later time than the incision of the letters,<sup>37</sup> and the prominent loop of the D, which on both occasions is the letter preceding the punctuation, may have resulted in the impossibility of the incision of the midpoint. A further case could perhaps also be found on the inscribed edge, side E, where the laser scans revealed the presence of a dot at the bottom after the last remaining letter. It is possible that on the edge, too, the stone mason opted for the two dots because of the available surface area, not much because of the proximity of the preceding letter, which is at some distance, but because of the reduced height of the line carved on the edge.

We note that the regularity of the use of punctuation concerns all the sides of the inscription, including side A, which in the literature has always been considered without punctuation and thus an exception to the rest of the inscription. During the autopsy, thanks to the use of strong grazing light, it was possible to identify the three-dots dividing form in two occurrences, specifically at l. 2 and l. 3 (**fig. 13**). The identification of these punctuation marks was later confirmed by examination of the digital images.

A survey work on the text by autopsy and a laborious comparison with digital rendering then led to a new possible segmentation of l. 12, MITERI (fig. 10). In this portion of the stone the surface is studded with accidental holes, compounded by the presence of a large hole that occurred after the inscription was carved and resulted in the loss of the lower portion of the



*Fig. 13. A moment of the autopsy of the Forum Cippus when the punctuation mark on side A was identified. Photo by M. Muscariello.*

37 The most striking example in our view is at l. 11, between TA and KAPIA, where the midpoint is slightly misaligned from the other two because of the left oblique stroke of the preceding A. But throughout the inscription the punctuation marks often lie close to the letters they separate and sometimes follow their slant. It therefore seems to be safe to assume that punctuation was not intended when the letters were carved and that the space for the dots was not considered. Is it possible that punctuation was added to facilitate the reading of a monumental boustrophedonic text?

first l. Because of the “pockmarked”<sup>38</sup> aspect of the stone, this line was variously segmented by the different editors who, in some cases, elected a few accidental holes as punctuation marks in order to make the text on the stone collimate with the interpretation they had in mind. This portion of the stone is currently the object of further digital analyses that will hopefully give us a clearer picture of the punctuation on this line.

In addition to determining which holes were accidental and which were intentional, examination of the digital images revealed a slight difference in the manner in which the dots were incised: in some cases (e.g., on side A), they appear to have been engraved more weakly, perhaps with a tool of smaller diameter than that used for engraving the letters.

Finally, the absence of punctuation in the QUOIHO (l. 1) and QUOIHA (l. 13) segments is confirmed, a peculiarity that could find justification in the interpretation of these elements as sequences of relative pronoun *quoi* + clitic (*ho-* at l. 1 and *ha = haud* at l. 13).<sup>39</sup> The dividing form is also missing when the end of the word coincides with the end of the line, probably because it is considered superfluous, the separation between words being already sufficiently guaranteed by the transition to the next line of writing.

## CONCLUSIONS

The working methodology that has guided our research clearly emerges from what we have outlined so far. The images obtained from laser scanning of the Cippus proved more than valuable both for the recognition of some uncertain letters and for the identification of the consistent use of the punctuation system throughout the inscription. In our case, in which we were able to witness the digitization operations live, they also “guided” us during the autopsy of the monument, allowing us to identify with a higher degree of precision the areas to be examined more carefully. Finally, they constituted a fundamental support for the research work that followed the time of the autopsy, ensuring that we could “revisit” the object whenever we needed to in order to recheck the most critical points of the inscription.

This is certainly not intended to claim that this will solve all the many interpretive problems still posed by the inscription on the Forum Cippus more than 120 years after its discovery. However, a reading that rests on this foundation can certainly be a new starting point for future hermeneutic paths.

## REFERENCES

- Auci, R. (2021): “Historical documentation revisited with new technologies”, in: Fortini, P. and Krusche, K. ed.: *From Pen to Pixel: Studies of the Roman Forum and Digital Future of World Heritage*, Rome, 251-283.
- Battaglini, S. (2009): *Il complesso del Niger Lapis nella storia della prima Roma. Note sull'iscrizione e i monumenti*, Rome.
- Boni, G. (1899): “Relazione sopra la scoperta”, in: Boni, G. ed.: *Stele con iscrizione latina arcaica scoperta nel Foro romano*, Rome, 3-10 (=NSA, serie 5, VII, 1899, 151-158).
- Carafa, P. (1998): *Il Comizio di Roma dalle origini all'età di Augusto*, Rome.
- Comparetti, D. (1900) : *Iscrizione arcaica del Foro Romano*, Romea.

38 P. G. Goidanich (1943, 426) uses the word “butterate” (pockmarked) to describe the irregular conditions of the surface of the Cippus.

39 For a more detailed discussion of these forms, see Rocca forthcoming.

- De Casa, G. and Lombardi, G. (1999): "Il tufo lionato dei monumenti romani: caratteri petrografici, geomeccanici e trattamenti conservativi", *Geologica romana*, 35, 1-25.
- De Angelis d'Ossat, G. (1950): "Le pietre dei cippi arcaici", *Bullettino della Commissione Archeologica Comunale di Roma*, 83, 3-11.
- Diehl, E. (1912): *Inscriptiones Latinae*, Bonn.
- Frank, T. (1924): *Roman Buildings of the Republic: An Attempt to Date them from their Materials*, Rome.
- Goidanich, P. G. (1943): "Rapporti culturali e linguistici tra Roma e gli Italici. Origine antica della cultura in Roma. L'iscrizione arcaica del Foro Romano e il suo ambiente archeologico. Suo valore giuridico", *Atti della Reale Accademia d'Italia*, serie 7, 3, fasc. 7, 317-501.
- Gordon, A. E. (1983): *Illustrated Introduction to Latin Epigraphy*, Berkeley-Los Angeles-London.
- Leifer, F. and Goldmann, E. (1932): *Zum Problem der Foruminschrift unter dem Lapis Niger*. 1. *Zwei neuere Lösungsvorschläge (Graffunder und Stroux) von Franz Leifer; Deutungsversuch von Emil Goldmann*, Leipzig (=Klio, XXVII, N.F. 14).
- Lugli, G. (1957): *La tecnica edilizia romana, con particolare riguardo a Roma e Lazio*, Vol. 1, Rome.
- Muscariello, M. (forthcoming) : "Moduli di divisione nell'iscrizione sul cippo del Foro: la punteggiatura e i nuclei testuali", in: Rocca, G., Muscariello, M. and Notti, E. ed.: *Po-ro-wi-to-jo. Studi in onore di Mario Negri*, Alessandria.
- Prosdocimi, A. L. (2010): "La Roma 'Tarquinia' nella lingua: forme e contenuti tra il prima e il dopo", in: Della Fina, G. M. ed.: *La grande Roma dei Tarquini, Atti del XVII Convegno Internazionale di Studi sulla Storia e l'Archeologia dell'Etruria*, Annali della Fondazione per il Museo "Claudio Faina" 17, Rome, 387-397.
- Ribizzo, F. (1933): "L'iscrizione dell'età regia presso la Tomba di Romolo nel Foro Romano", *RIGI*, 17, 51-79.
- Rocca G. (forthcoming): "Annotazioni sulle 'forme': un primo bilancio sulla nuova lettura", in: Rocca, G. and Sarullo, G.: *Il cippo del Foro. Nuove letture e prospettive euristiche*.
- Romanelli, P. (1984): *Ricerche intorno ai monumenti del "Niger Lapis" al Foro Romano (1955)*, Accademia Nazionale dei Lincei, Monumenti Antichi, Serie miscellanea 3, 1, Rome.
- Santoro, S. (2016): *Il cippo del foro romano. Inquadramento storico e linguistico del più antico documento epigrafico di Roma redatto in latino arcaico*, Verona.
- Sarullo, G. (2023): "Il contributo delle copie in gesso alla lettura dell'iscrizione del cippo del Foro", *Latomus*, 82, 277-299.
- Warren, M. (1907): "The Stele Inscription in the Roman Forum. II", *AJPh*, 28, 4, whole no. 112, 373-400.

Giovanna Rocca  
IULM University, Milan

Giulia Sarullo  
eCampus University

Retrouvez la version en ligne gratuite  
et ses contenus additionnels







# L'IMPIEGO DI NUOVE TECNICHE DIGITALI PER LA LETTURA DELLE ISCRIZIONI: UN ESEMPIO DI DISEGNO AUTOMATICO DAL MODELLO 3D E UN'APPLICAZIONE VIRTUALE DELLA RTI

Salvatore Ganga

---

## PREMESSA

Nelle operazioni di rilievo, inteso in senso generale, i migliori risultati si ottengono dalla stretta integrazione di tecniche diverse, ognuna con le sue peculiarità e il proprio grado di precisione: così nel rilievo topografico che, con l'ingresso delle nuove tecnologie, vede l'impiego coordinato di *Total Station*, ricevitori satellitari e fotogrammetria oppure nel rilievo architettonico o archeologico con l'integrazione di misure dirette ed indirette, scanner laser e fotogrammetria di prossimità. Allo stesso modo il rilievo epigrafico trae grande giovamento dall'impiego sinergico e coordinato delle vecchie metodiche manuali<sup>1</sup> e delle nuove tecnologie<sup>2</sup>, sempre in continua evoluzione e con frequenti aggiornamenti<sup>3</sup>. Non ha molto senso istituire graduatorie di importanza tra le diverse tecniche, contribuendo ognuna con la propria specificità al risultato finale. Solo in rari casi di emergenza si può ricorrere a metodi semplificati, introducendo qualche approssimazione<sup>4</sup>. Il risultato migliore deriva dalla stretta integrazione tra l'osservazione diretta dell'iscrizione e le ispezioni e le elaborazioni su modelli 3D ottenuti applicando le nuove tecnologie al rilievo epigrafico<sup>5</sup>.

In passato il rilievo delle iscrizioni, dopo un preliminare eidotipo schizzato sul carnet di appunti (pratica sempre attuale e consigliabile anche oggi, utilissima per appuntare una prima lettura, le misure dell'iscrizione, la natura del supporto e utili osservazioni sul contesto) prevedeva l'utilizzo di pochi metodi di calco diretto:

- calco a secco (*frottage*) su carta da schizzi sottile con qualche variante nell'esecuzione: matite o bastoncini di grafite sfregati manualmente, polvere di grafite distribuita con tamponi di garza, fogli di carta carbone pressati con ruvida tela di juta<sup>6</sup>. Il calco aveva le dimensioni dell'originale, ma la qualità era legata al tipo di pietra e allo stato di conservazione perché per sua natura incapace di distinguere gli elementi intenzionali (i solchi delle lettere, i segni di interpunzione, le linee di preparazione) da quelli accidentali (scheggiature, alveoli, abrasioni ecc.). Aveva da un lato il grande vantaggio della rapidità di esecuzione, ma soprattutto poteva evidenziare anche deboli solchi poco evidenti all'osservazione diretta, sia perché così già in origine come le linee di preparazione, sia a

1 Ganga 1997.

2 Sechi *et al.* 2015.

3 Mastino & Ganga 2020.

4 Ganga *et al.* 2021.

5 Aounallah *et al.* 2019.

6 Di Stefano Manzella 1987, 30.

causa della consunzione nel tempo. Dall'altro limitava fortemente il controllo critico al momento dell'esecuzione, obbligando ad una fase di revisione dei particolari. Purtroppo non consentiva la registrazione di informazioni sul fondo del solco delle lettere. Questo aspetto ha condizionato negativamente per molto tempo la modalità di restituzione grafica (lettere con campiture nere anche per i solchi di sezione triangolare, quindi senza il disegno dello spigolo vivo al fondo);

- ▶ calco a umido con carta da filtri: il calco aveva le dimensioni dell'originale, salvo una leggera contrazione durante l'asciugatura e registrava in modo permanente anche il fondo dei solchi. Veniva eseguito adagiando sulla pietra preventivamente bagnata uno o più fogli di carta del tipo privo di colla. Con un pennello bagnato si picchiava la superficie cercando di farla aderire in tutti i punti, anche all'interno delle lettere. Ad essiccazione avvenuta il foglio poteva essere staccato e arrotolato senza difficoltà. Poteva conservarsi indefinitamente. Per la restituzione grafica però era necessario ricalcare il bordo delle lettere dal lato a contatto con la pietra, operando "al rovescio";

- ▶ apografo su pellicola trasparente fissata in modo stabile sul pezzo, servendosi talvolta di un particolare dispositivo<sup>7</sup>. Il calco grafico veniva effettuato seguendo fedelmente con grande attenzione il contorno delle lettere a mezzo di pennarelli indelebili a punta superfine. Dato lo spessore minimo della pellicola e la sua cedevolezza alla pressione esercitata dalla punta scrivente, la mano avvertiva la sensazione tattile del bordo dei solchi ed era, in un certo senso, come guidata dalla risposta data dalla pietra. Con l'esperienza si raggiungeva una perfetta integrazione tra la sensazione tattile e la coordinazione occhio-mano. Il metodo ha giustamente avuto una larga diffusione. Poiché non consisteva nella registrazione passiva delle informazioni, obbligava a sciogliere i dubbi sul momento, selezionando i soli elementi necessari. Il principale svantaggio nei confronti degli altri metodi era costituito dai tempi di esecuzione più lunghi. Per alcuni si tratterebbe di una pratica non oggettiva, quasi priva di scientificità a motivo della percentuale di soggettività introdotta dal rilevatore-disegnatore per cui si dovrebbe privilegiare la sola rappresentazione fotografica, l'unica a riprodurre "oggettivamente" le iscrizioni. Questa proposizione è nulla più che un infondato pregiudizio e non vale discuterne oltre. La fotografia non è un atto oggettivo, anche quando si pone finalità di documentazione. Essa è stata e rimane uno strumento utilissimo nel rilievo epigrafico quando utilizzata con consapevolezza e soprattutto in stretta integrazione con gli altri metodi. Le fotografie digitali che hanno sostituito quelle di tipo analogico sono diventate oggi fondamentali per lo sviluppo delle tecniche fotogrammetriche di tipo automatico.

Il rapido excursus sui metodi tradizionali di rilievo diretto delle iscrizioni, impiegati per lungo tempo, non ha il carattere di rievocazione storica, né ha intenti nostalgici. Del resto le stringenti norme di tutela dei beni archeologici indirizzano verso metodi di calco indiretto. Serve invece per evidenziare similitudini e punti di contatto con gli attuali metodi di rilievo indiretto resi possibili dall'adozione delle nuove tecnologie. La famiglia dei calchi diretti, di cui il calco a umido con la carta da filtri è il componente più economico e rapido, è stata sostituita dai modelli digitali in tre dimensioni, ottenuti con metodi anche molto diversi tra di loro: la fotogrammetria degli oggetti vicini o *close range photogrammetry*, di tipo automatico *Structure from Motion (SfM)* e il *3D scanning* eseguito con strumenti laser o a luce strutturata.

I modelli 3D che si ottengono hanno il grande vantaggio di poter essere misurati, ruotati nello spazio virtuale, ingranditi per una migliore ispezione, illuminati con fasci di luce provenienti dalle direzioni più convenienti, variamente manipolati ad es. sezionandoli quando necessario oppure srotolandone la superficie come nel caso dei miliari, utilizzati per ricavarne disegni metricamente corretti ed infine condivisi a distanza con la più larga platea di soggetti

7 Ganga 1997, 358.

interessati<sup>8</sup>. La possibilità di trasferire sulla superficie dei modelli la consistenza materica (*texture*) degli oggetti completa l'operazione di sostituzione pressoché integrale della realtà col suo modello virtuale. Tuttavia nel caso di iscrizioni con le superfici variamente degradate o ricoperte da agenti biologici risulta invece utile e, talvolta, decisivo poter esplorare il modello privato della colorazione della nuvola di punti<sup>9</sup> e della *texture*, ma solo con i toni neutri del grigio. Questa è una prima similitudine con i calchi di carta. Dal modello 3D può essere ricavato (questo è un altro punto in comune con le vecchie metodiche) il disegno bidimensionale. Si arriva ora al nocciolo della questione: una volta che tutti gli studiosi interessati siano in possesso del modello 3D, ci si potrebbe legittimamente chiedere se abbia ancora un senso ricavarne un disegno che qualcuno potrà sempre definire non oggettivo, quindi privo di valore. Ma ogni disegno, qualsiasi disegno di una realtà tridimensionale, è una "riduzione" del continuo al discreto operata da un "soggetto" che seleziona i soli punti e linee che ritiene necessari. Operazione di riduzione della realtà, non certo di impoverimento, non banale e non priva di rischi, da condurre con criteri scientifici. Purtroppo manca ancora un *corpus* di convenzioni grafiche studiato specificamente per le necessità epigrafiche e condiviso da tutti che possa uniformare le rappresentazioni grafiche come da molto tempo è stato fatto per altri ambiti del disegno. Altri strumenti a disposizione dell'epigrafista per comunicare il suo personale punto di vista, per il momento, non ne vediamo.

Ho l'onore di presentare in questa sede una breve sintesi delle innovazioni introdotte nell'ambito della collaborazione con i Dipartimenti umanistici dell'Università di Sassari, analizzando due esempi emblematici: nel primo caso si tratta del celebre cippo di *Forum Traiani* in Sardegna, che indistintamente tutti gli editori avevano collocato nell'età di Caracalla e Geta Augusti<sup>10</sup>, ma che va anticipato di una quarantina di anni, con Marco Aurelio e Commodo con il nome di quest'ultimo eraso ma non re inciso; il che ha conseguenze significative sul governo provinciale della Sardinia provincia imperiale anche nel corso dell'età degli Antonini. Nel secondo caso, studiato per iniziativa del Laboratorio di Epigrafia per l'Archeologia, si tratta della dedica a Nettuno Augusto effettuata a *Thignica* in Africa Proconsolare, durante l'età di Gallieno con la XIII potestà tribunicia, il cui nome è completamente eraso assieme a quello di Cornelia Salonina. Siamo negli anni immediatamente successivi alla cattura di Valeriano da parte dei Persiani e nell'anno della *deductio ex forma* di una parte di nuovi coloni arrivati nell'area oltre la Fossa Regia.

## L'OGGETTO N. 1

Cippo altare rinvenuto nel 1995-1996 all'interno del complesso delle grandi terme romane di Fordongianus (OR), in tenera ignimbrite locale, rozzamente modanato e dedicato alle Ninfe per la *salus* del governatore della Sardinia *Q. Baebius Modestus* (AE, 2001, 1112). Il monumento è in buono stato di conservazione, le lettere sono nitidamente incise e ancora presentano tracce di rubricatura (**fig. 1**).

8 Comte & González Bordas (à paraître); vedere anche il contributo degli stessi autori a questo volume, 20-21.

9 Sulla nuvola di punti (*point cloud, nuage de points*), si veda Comte & González Bordas in questo volume, 16, n. 23.

10 Serra & Bacco 1998; AE 1998, 671; Zucca 2003.



Fig. 1. Il cippo altare da Fordongianus. Foto A. Ibba.

### La problematica

L'eccellente conservazione del monumento e il disegno già pubblicato sembravano rendere superflua ogni ulteriore analisi. Tuttavia l'interpretazione fino allora data del nome eraso, lasciava spazio a qualche dubbio. Per questo motivo l'attenzione si è concentrata sulla *damnatio* del secondo imperatore alla fine della linea 4 che era stato interpretato come Geta, elemento che permetteva di datare il testo al 211 d.C., nel breve lasso di tempo intercorso fra la morte di Settimio Severo e l'assassinio del suo secondogenito. A condizionare la lettura dei primi editori (**fig. 2**) furono probabilmente la prima lettera, marginalmente interessata dall'erosione e intesa come una G, e il tratto superiore della terza lettera, facilmente interpretabile come i bracci di una T. In realtà se la prima lettera poteva essere alternativamente intesa come una C o una G, la seconda lettera, normalmente interpretata come E, mostra superiormente un tratto curvilineo, ben distinguibile e privo di riscontri con quelli delle altre E presenti nel testo, tutte fra loro molto simili: dato il contesto, si tratta invece senza ombra di dubbio di una O. A queste

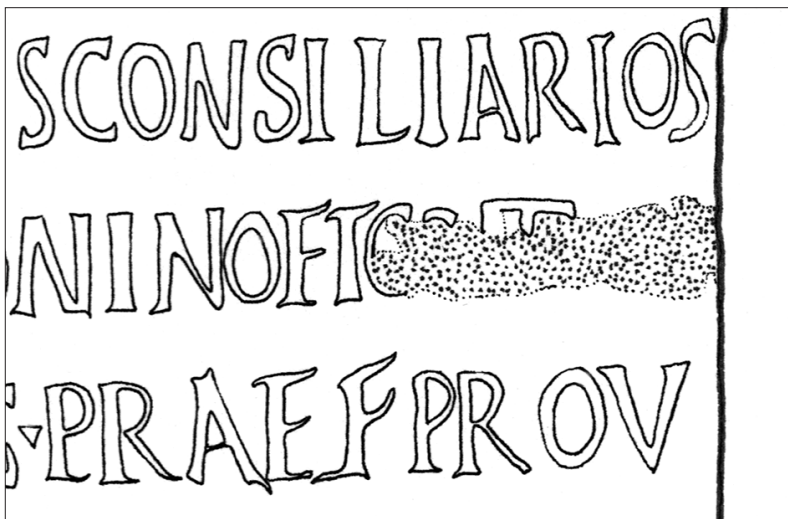

Fig. 2. Disegno con la lettura del nome di Geta.

osservazioni si aggiunga che gli stessi bracci della supposta T sono troppo rigidi rispetto a quelli ondulati e brevi delle altre T presenti nel resto dell'iscrizione ed infine che la lacuna finale AE avrebbe dovuto occupare uno spazio ridotto rispetto alla superficie erasa<sup>11</sup>.

Sulla base di queste considerazioni si è cominciato a ragionare su una restituzione alternativa che, per la presenza di ANTONINO, non poteva che essere [[COMMODO]]. Verso questa interpretazione ci spingono infatti (fig. 3) sia i tratti evidenti delle prime due lettere, sia quelli meno percepibili, ma leggibili sulla pietra con l'uso della luce radente, delle lettere OD e delle aste della seconda M, finora interpretati come parte di una A. Per quanto riguarda la presunta T, l'asta potrebbe in realtà appartenere ad una M (rimangono visibili tracce anche dell'altra asta montante nella parte superiore); i supposti bracci invece sembrano con molta evidenza essere stati prodotti dal tagliante trasversale della martellina usata dal lapicida. Il probabile uso di questo utensile per l'erasione è giustificato dalla natura del supporto (ignimbrite), molto più tenero di molti calcari, basalti o graniti: si può notare in questo caso come questo solco, così anomalo rispetto a quello delle altre T, abbia invece un andamento straordinariamente parallelo a quello delle altre tracce della scalpellatura ed è quindi più verosimilmente frutto della lavorazione effettuata per eradere il testo, secondo il tipico *modus operandi* di un operaio che scalpelli una superficie lapidea impugnando una martellina<sup>12</sup>. Nella porzione di superficie interessata dall'erasione bisogna distinguere quindi le parti residue dei solchi delle lettere (ricavati presumibilmente con una unghietta) dalle tracce tra loro parallele lasciate dall'impatto del tagliante della martellina. La superficie rimanente è irregolare e dovuta al distacco di scaglie, più o meno grandi, della pietra.

11 La scoperta è stata effettuata su segnalazione del compianto Giuseppe Oppo.

12 La martellina è caratterizzata da due taglianti opposti all'impugnatura, dei quali uno parallelo al manico di legno, l'altro ortogonale. Nell'uso indifferente dell'uno o dell'altro, i colpi assestati in rapida successione per cancellare le lettere lasciano sulla pietra tracce pressoché parallele tra di loro.



Fig. 3. Particolare dell'erosione. Foto G. Oppo.

### Le soluzioni adottate e i risultati

Un modello digitale 3D della base fu realizzato nel mese di dicembre 2014 con l'uso del laser scanner brandeggiabile Creaform *HandyScan*. Tuttavia, a causa di settaggi della risoluzione non appropriati, il modello 3D privo di *texture* non si era rivelato utile, né suscettibile di ulteriori sviluppi<sup>13</sup>.

Nell'esempio presentato il modello virtuale tridimensionale è stato realizzato con tecniche di fotogrammetria automatica del tipo "*Structure from Motion*" (*SfM*), struttura dal movimento, una tecnica appartenente al campo della *computer vision*, la visione artificiale. Quest'ultima tende a riprodurre la vista umana mediante l'interpretazione automatica del contenuto delle fotografie. Si tratta di un insieme di processi che hanno lo scopo di creare modelli approssimati della realtà tridimensionale a partire da immagini bidimensionali. La *Structure from Motion* è analoga alla visione biologica che ricostruisce la struttura tridimensionale degli oggetti a partire dalle immagine retiniche<sup>14</sup>. Muovendosi nell'ambiente reale gli oggetti intorno si muovono, quindi le informazioni sulla struttura 3D sono ottenute da immagini in movimento. Nel mondo virtuale l'individuazione automatica di punti caratteristici necessaria per mettere in correlazione le foto avviene per mezzo di diversi algoritmi. Nel caso in esame il dato di partenza è costituito da un set di 128 foto digitali dell'iscrizione, che sono state elaborate col software Agisoft *Metashape Pro*. Ne è risultata una nuvola densa di oltre 51 milioni di punti da cui poi è stato ricavato un DEM (*Digital Elevation Model*) di circa 4,5 milioni di facce. Dal modello complessivo

13 Per superare queste difficoltà di recente la Scuola Archeologica Italiana di Cartagine (SAIC) si è dotata di uno scanner brandeggiabile a luce strutturata, di ultima generazione, che permette di ottenere modelli 3D completi di *texture*.

14 Si può supporre grossolanamente infatti che l'occhio si comporti come una macchina fotografica. La metafora può risultare fuorviante perché non esistono immagini statiche nella visione. I continui movimenti e micromovimenti saccadici dell'occhio sono di frequenza variabile e sottendono angoli visuali di ampiezza variabile. Si tratta in realtà di un meccanismo biologico estremamente complesso.

del monumento è stato estrapolato un modello parziale relativo alla sola zona interessata dall'erosione di cui mostriamo sinotticamente la *mesh*<sup>15</sup> nella visualizzazione *wire-frame*, il modello solido e il modello ombreggiato (**fig. 4**). Queste elaborazioni non costituiscono però il risultato finale ma solo il punto di partenza di altre che ci proponiamo di descrivere nel seguito.

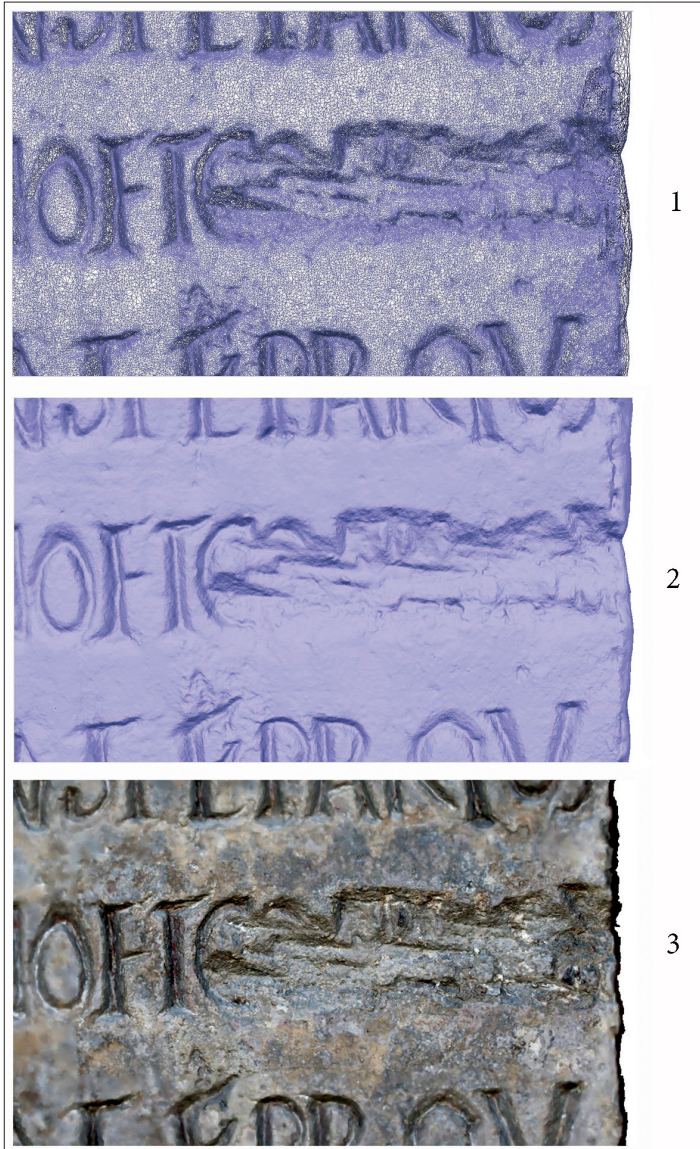

Fig. 4. Elaborazioni del modello 3D:  
1. Mesh o modello a filo di ferro; 2. Modello solido; 3. Modello ombreggiato.

15 Sulla mesh (*maillage, malla*) si veda in questo volume Comte & González Bordas, 16, n. 24 e Triguero, 66.

## L'ortomosaico (fig. 5)

Si tratta di una particolare elaborazione che restituisce una foto perfettamente rettificata e con punto di vista all'infinito, esente da deformazioni prospettiche. Non è una foto semplicemente raddrizzata: la si può ottenere infatti solo se si dispone di un modello matematico della superficie dell'oggetto e di molte foto prese da differenti punti di vista. Una volta messa in scala costituisce la base ideale per ottenere il disegno dell'iscrizione.

## Il disegno elettronico

Nella pratica, servendosi di una tavoletta grafica<sup>16</sup> e di un software CAD<sup>17</sup>, si può disegnare sull'ortomosaico in formato vettoriale ricalcando con la penna attiva direttamente la forma delle lettere come un tempo si ricavavano gli apografi su pellicola trasparente. La differenza sostanziale con la classica esecuzione dell'apografo è costituita dal fatto che si perde la risposta tattile della pietra nei confronti della punta scrivente. In compenso con la tecnica digitale c'è il vantaggio di poter ingrandire a piacimento i particolari col solo limite dato dalla risoluzione dell'immagine digitale. Si ottengono così disegni metricamente corretti, (fig. 6) caratterizzati dalla flessibilità di trattamento grafico ai diversi ingrandimenti richiesti, cosa non possibile con i disegni in formato *raster*<sup>18</sup>.

## IL DEM (Digital Elevation Model)

Il modello digitale della superficie dell'iscrizione può risultare utilissimo per ulteriori elaborazioni. In questo caso, in stretta analogia alle rappresentazioni cartografiche, è stata ricavata una restituzione "a curve di livello" del settore interessato dall'erosione. Le curve di livello<sup>19</sup>, (fig. 7) di equidistanza ridottissima, consentono di apprezzare la diversa profondità dei solchi delle lettere, quella dei colpi assestati dalla martellina impiegata per l'erosione, distinguendole da quelle della superficie di distacco delle scaglie in conseguenza di tale operazione. Si noti come è possibile leggere l'iscrizione senza che un solo tratto risulti opera di un disegnatore. Questo elaborato può essere considerato una sorta di disegno "automatico", passando dal continuo al discreto senza l'intervento "soggettivo" di un disegnatore e superando così le obiezioni mosse in passato sulla mancanza di "obiettività" dell'apografo su pellicola trasparente per il rilievo delle iscrizioni.

16 È stata usata una tavoletta Wacom Cintiq Pro 16 con strumento di puntamento Pro Pen 2.

17 Software Autodesk Autocad. È stata utilizzata la funzione "schizzo" a mano libera, per il disegno di polilinee. I parametri relativi all'incremento nella acquisizione dei segmenti della polilinea e alla tolleranza dipendono dalla risoluzione dell'immagine utilizzata, per cui non è possibile dare indicazioni generali. Le polilinee sono state arrotondate trasformandole in spline.

18 Dal tedesco: griglia. Le immagini sono composte da una griglia di quadratini, i *pixel*. Ingrandendo l'immagine si ingrandiscono i *pixel* e l'immagine perde di qualità. Nei disegni vettoriali invece le primitive geometriche (punti, linee) sono definiti da funzioni matematiche, i vettori. Possono essere facilmente manipolati senza che la qualità cambi con l'ingrandimento dell'immagine.

19 Le curve di livello sono le linee che uniscono i punti di uguale distanza verticale rispetto a un piano di riferimento. L'equidistanza tra due curve adiacenti corrisponde alla differenza di quota.



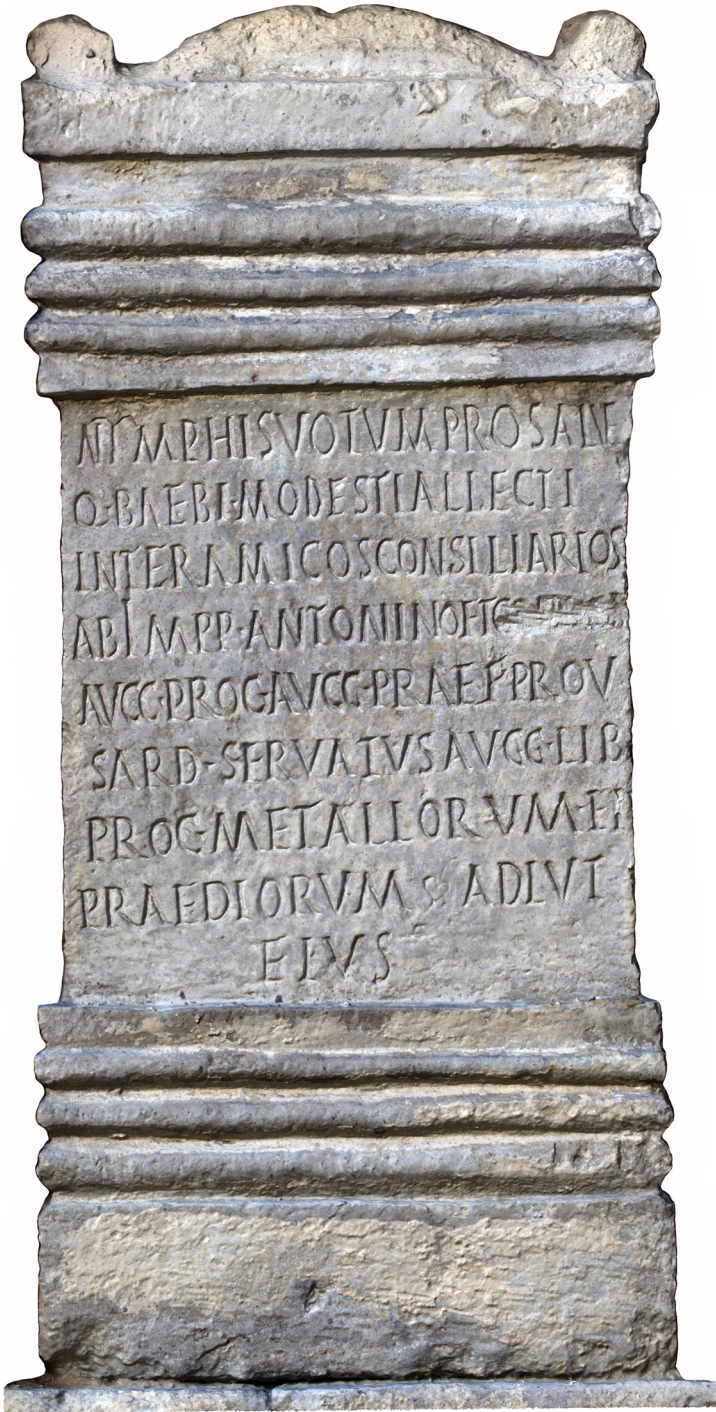

Fig. 5. Ortofoto dal modello 3D.

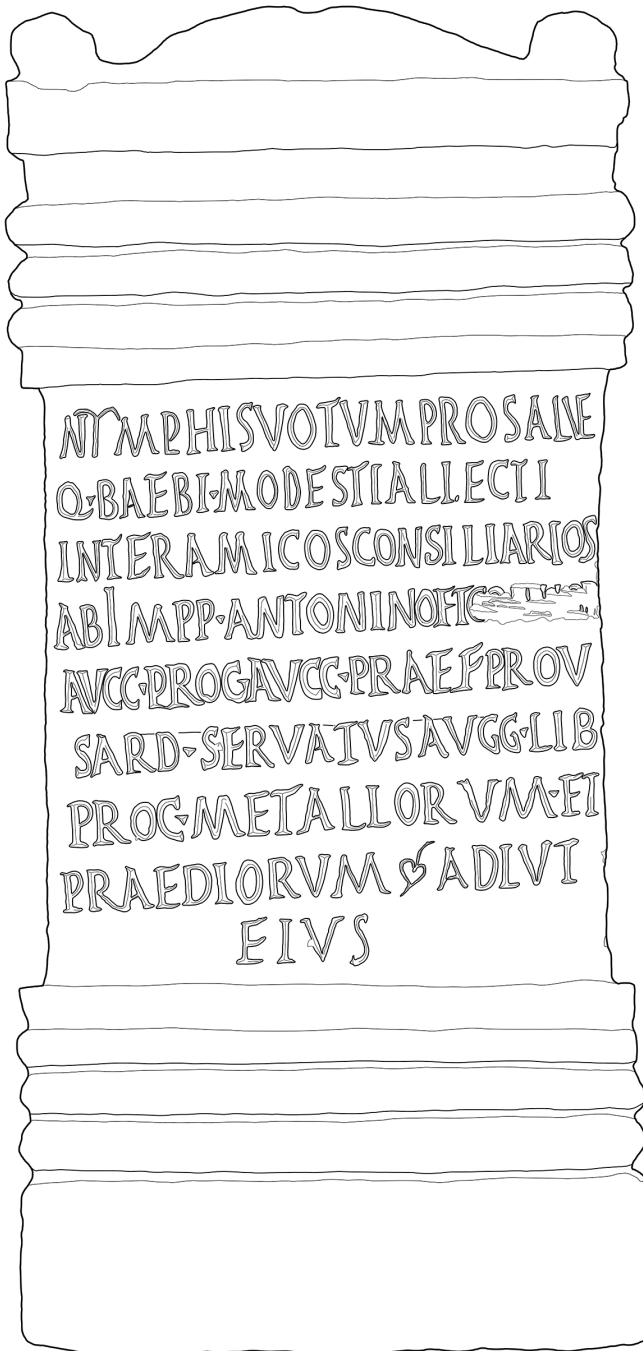

Fig. 6. Disegno vettoriale dell'iscrizione.



Fig. 7. Restituzione a curve di livello.

### Il DEM colorato (fig. 8)

Si tratta di una elaborazione del *DEM* a falsi colori dove i toni più caldi corrispondono ai punti più elevati e quelli più freddi corrispondono a quelli più bassi. Risulta molto efficace per restituire visivamente in modo molto intuitivo la profondità dei solchi delle lettere, in questo caso abbastanza uniforme a cui si contrappone la scalpellatura, irregolare e localmente più profonda.

Con specifici programmi di grafica 3D<sup>20</sup> (fig. 9) è possibile rielaborare ed esaltare alcune caratteristiche dei modelli virtuali a seconda delle esigenze di studio. Nell'esplorazione delle superfici delle iscrizioni risulta molto utile poter indirizzare fasci di luce virtuale nelle zone di interesse con le inclinazioni e le direzioni di provenienza più adatte a favorire la visibilità dei solchi. L'esplorazione della superficie di modelli privati della *texture* e anche della colorazione dei punti si rivela efficacissima nel caso di superfici dove siano presenti macchie di colore, non importa di quale origine, che possono essere confuse con l'ombra dei solchi delle lettere.

Si possono ricavare poi degli *snapshot*, ossia delle istantanee bidimensionali dei modelli rielaborati. Ne conseguono vantaggi per lo studioso, che può evitare di tornare sul luogo di conservazione per ulteriori ricerche, e per il reperto, che non deve essere sottoposto a continue manipolazioni.



Fig. 8. Digital Elevation Model a falsi colori.

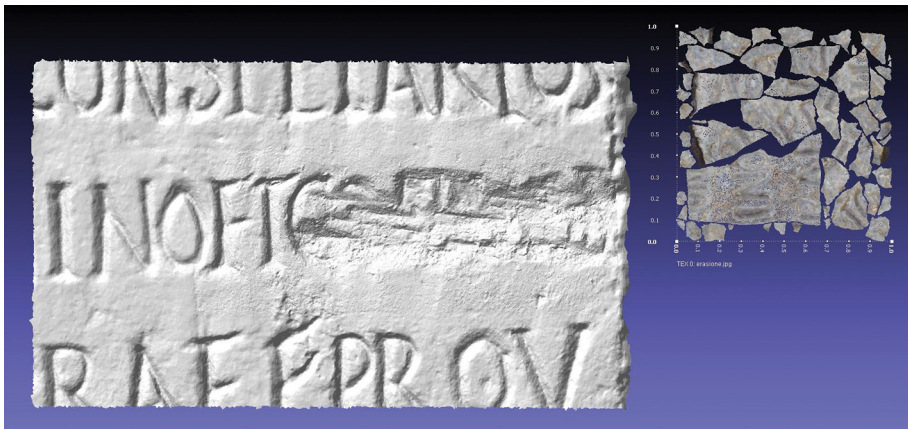

Fig. 9. Ombreggiatura virtuale a luce radente con Mesh Lab.

## L'OGGETTO N. 2

Iscrizione monumentale proveniente dal santuario delle acque, poi *Aedes Neptuni a Thignica* (attuale Ain Tounga, Tunisia) contenente la dedica all'imperatore Gallieno e a sua moglie Salonina<sup>21</sup>. L'iscrizione, in origine collocata probabilmente sopra l'architrave della porta di ingresso della cella del santuario si compone di due blocchi di lunghezza sensibilmente differente. Il secondo – il più corto – risulta spezzato secondo un piano orizzontale in due frammenti esattamente combacianti. La titolatura è stata erasa con l'impiego di una piccozza, ma non così accuratamente, tanto che è ancora possibile intravederne le lettere<sup>22</sup>.

21 Ruggeri & Ganga 2020, 73-91.

22 Mastino 2018, 181-200.

## La problematica

I due blocchi iscritti giacciono separati tra di loro a breve distanza dal monumento, su di un terreno leggermente in pendenza. Il primo si trova rovesciato rispetto alla giacitura che aveva nel monumento. La posizione è assolutamente sfavorevole per l'applicazione *in situ* della particolare tecnica che si intende utilizzare, né è possibile movimentare i blocchi a causa del loro peso (si stimano circa 1,1 tonnellate per il primo blocco e 0,6 tonnellate per il secondo) senza l'intervento di mezzi meccanici.

## La soluzione adottata e i risultati

Una tecnica sempre più utilizzata per la documentazione dei Beni Culturali è la *Reflectance Transformation Imaging (RTI)* dovuta ai ricercatori di Hewlett-Packard Labs<sup>23</sup>, tramite *Polynomial Texture Mapping (PTM)*<sup>24</sup>. Il software che abbiamo utilizzato per l'applicazione della *RTI* è stato sviluppato da "CHI"<sup>25</sup>. La *RTI* è un metodo di fotografia computazionale per l'acquisizione della forma e del colore della superficie degli oggetti. Le immagini digitali dell'oggetto da rilevare vengono scattate da un unico punto di vista, ma a ciascuna di esse corrisponde una fonte di luce proveniente da direzioni e con angolazioni incidenti sempre diverse. Conseguentemente le ombre prodotte sono variabili. Un software di visualizzazione<sup>26</sup> consente di riprodurre sullo schermo del computer l'illuminazione secondo le direzioni e gli angoli desiderati, evidenziando dettagli non altrimenti visibili ad una esplorazione diretta. Ogni immagine *RTI*, infatti, è solo apparentemente bidimensionale: essa contiene invece informazioni sulla riflettanza<sup>27</sup> derivanti dalla forma del soggetto che vengono condensate in ogni singolo *pixel* insieme all'informazione sul colore. Nel momento in cui l'utilizzatore interrogherà l'immagine, ogni *pixel* sarà in grado di riflettere la luce a seconda della direzione richiesta, offrendo spunti percettivi che possono risultare superiori alla manipolazione di un modello 3D. L'acquisizione delle immagini per soggetti di non grande dimensione viene effettuata normalmente utilizzando cupole rigide o analoghi dispositivi che allo stesso tempo fanno da supporto alle sorgenti di luce puntiforme (normalmente vengono impiegati LED di potenza a luce bianca) e allo stesso tempo impediscono l'ingresso della luce dall'esterno. Un apposito dispositivo di sincronizzazione luce-scatto fotografico rende abbastanza veloce l'intero processo.

Tuttavia sia per la posizione sul terreno, sia per le dimensioni ed il peso dei blocchi che rendono difficoltoso il loro spostamento, oltre alla difficoltà di isolare il soggetto dalla luce ambiente naturale, si è preferito optare per una soluzione alternativa. La tecnica *RTI* è stata applicata sperimentalmente in modo totalmente virtuale. Anziché sull'oggetto reale, si è operato separatamente sui modelli 3D dei due blocchi realizzati con la tecnica della fotogrammetria degli oggetti vicini del tipo *SfM*. Le foto necessarie da processare con la *RTI* sono state quindi ottenute dai modelli utilizzando una fonte di illuminazione anch'essa virtuale sistemata di volta in volta in punti prestabiliti.

23 Malzbender *et al.* 2001. Vedere Comte & González Bordas in questo volume, 11.

24 Zhang & Drew 2014.

25 *RTI Builder* vers. 2.0.2 GPL - V3.0 liberamente scaricabile da <https://culturalheritageimaging.org/> (consultato il 31/10/2023). "CHI" (*Cultural Heritage Imaging*) è una organizzazione no profit che sviluppa software e favorisce l'adozione di pratiche di *imaging* digitale con lo scopo di preservare e proteggere il patrimonio culturale.

26 *RTI viewer* 1.1.0 liberamente scaricabile da <https://culturalheritageimaging.org/> (consultato il 31/10/2023).

27 È la misura della frazione di radiazione luminosa incidente che viene riflessa da una superficie.

Ecco una sintetica esposizione delle diverse fasi:

sono stati preliminarmente realizzati con la fotogrammetria *image based* i modelli 3D dei due blocchi dell'iscrizione. Al modello solido è stata applicata la *texture* fotorealistica. Ogni modello così creato è stato trasportato in uno "studio" virtuale costituito dall'ambiente del software open source di modellazione tridimensionale "Blender"<sup>28</sup>. Lo scopo era di replicare virtualmente ciò che avviene nell'applicazione della tecnica RTI nel mondo reale: l'oggetto è sostituito dal modello 3D fotorealistico; la cupola rigida è replicata non nella sua consistenza materica, ma nel solo reticolo geometrico indispensabile per fissare le sorgenti luminose nella posizione corretta. Non è necessario infatti isolare l'oggetto dalla luce ambiente dato che si ha un controllo totale delle luci. La "cupola" emisferica (fig. 10) di dimensioni adeguate al blocco iscritto è costituita, utilizzando una metafora geodetica, da 16 "semi-meridiani" equidistanti e una serie di 6 "paralleli" equidistanti a partire da 15 gradi fino a 65 gradi di "latitudine" ai cui incroci sono state fissate le sorgenti di illuminazione *spot* (alternativamente 3 per ogni quarto di meridiano, nella figura rappresentate da pallini rossi). La camera da presa è stata posta in corrispondenza del "polo nord", con direzione normale alla superficie iscritta del blocco posta centralmente sul piano "equatoriale". Il dimensionamento della cupola è in funzione della grandezza dell'oggetto: questo non deve superare il 25-30 % del diametro della cupola per la buona riuscita del procedimento. A lato del modello 3D del blocco sono state poste due sfere di colore nero e dalla superficie lucida riflettente, in perfetta analogia al caso reale. Ciò affinché, dopo la sessione di acquisizione, il software *RTI Builder* usato per l'elaborazione possa ricavare la direzione di provenienza della luce di ogni foto mediante la traccia da essa prodotta sulla superficie lucida delle sfere. Ogni istantanea scattata con una sola fonte di luce proveniente da una direzione sempre diversa è costituita da un *render* del modello 3D (fig. 11).

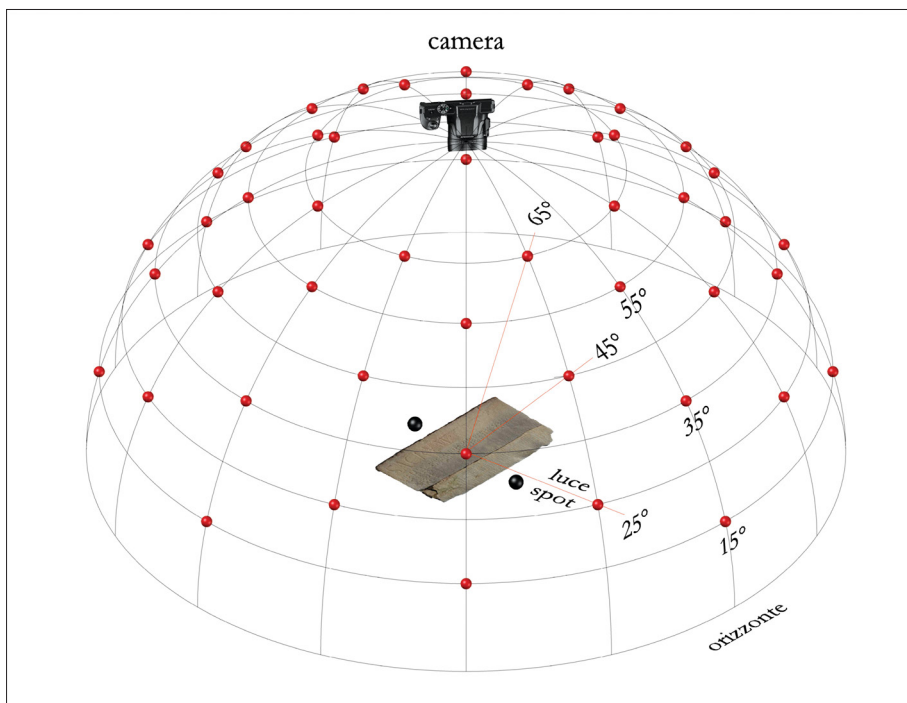

Fig. 10. Gli elementi della RTI riprodotti nell'ambiente del software Blender.

28 La versione 2.78 di Blender disponibile al momento (2016).



Fig. 11. Render fotorealistico del secondo blocco iscritto, ottenuto con Blender.

I 148 diversi *render* ottenuti per sessione sono stati elaborati con *RTI Builder* come se si trattasse di immagini scattate dal vero. Al termine del processo sono possibili svariate elaborazioni avendo la facoltà di variarne i parametri. Nella **fig. 12** raccogliamo alcuni dei risultati che possono essere ottenuti con una visualizzazione mediante *RTI Viewer*. La migliore elaborazione, tra le diverse possibili, soprattutto ai fini dell'esecuzione del successivo disegno dell'iscrizione è risultata essere quella denominata "*specular enhancement*". L'amplificazione delle ombre che si ottiene, dato che nella stessa immagine coesistono ombre relative a direzioni multiple della luce, unita a una resa della superficie iscritta priva di texture può risultare decisiva nella decifrazione di iscrizioni di difficile lettura. Le immagini prescelte (**fig. 13**) sono state importate in un software idoneo per la vettorizzazione manuale<sup>29</sup>. Dopo averla opportunamente scalata, utilizzando una tavoletta grafica<sup>30</sup> è stato ricavato il disegno<sup>31</sup> (**fig. 14**) come se si stesse operando sull'oggetto reale. Nell'operazione di disegno vettoriale si aveva la possibilità di confrontare l'immagine su cui si lavorava con altre dello stesso oggetto diversamente elaborate. Oppure era possibile visualizzare contemporaneamente l'iscrizione su un secondo schermo con *RTI Viewer*, variando in tempo reale la direzione della luce radente per evidenziare meglio i particolari da disegnare (**fig. 15**).

Questo procedimento è senz'altro utile quando per svariati motivi non c'è la possibilità di una applicazione diretta della tecnica *in situ*. Per contro esso richiede tempi di elaborazione sensibilmente più lunghi.

29 Al momento (2016) si disponeva del software di raddrizzamento fotografico con CAD integrato Giotto Plus-Trace 4.0.2012.

30 Tavoletta Wacom Graphite mod. ET-0405-U con area di lavoro da 4×5". Questo tipo di tavolette grafiche obbliga a tracciare il disegno con la penna attiva su di un'area di lavoro abbastanza ristretta senza un riscontro diretto, dovendo controllare sullo schermo del computer la traccia prodotta.

31 Mastino 2018, 186.



Fig. 12. Elaborazioni del secondo blocco ottenute con RTI Builder:  
 1. Specular enhancement; 2. Luminance unsharp masking; 3. Image unsharp masking;  
 4. Specular enhancement (con utilizzo di parametri differenti da 1).



Fig. 13. Elaborazione "specular enhancement" dell'iscrizione completa, utilizzata per il disegno.

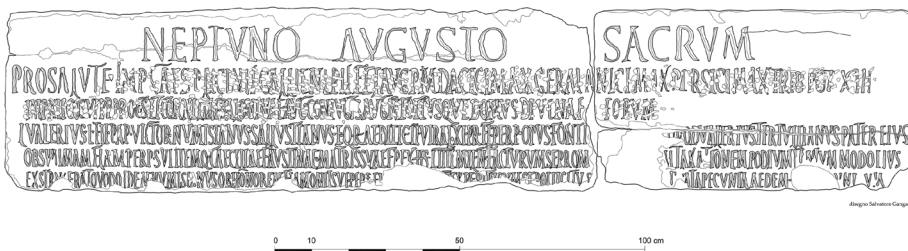

Fig. 14. Disegno vettoriale dell'iscrizione.



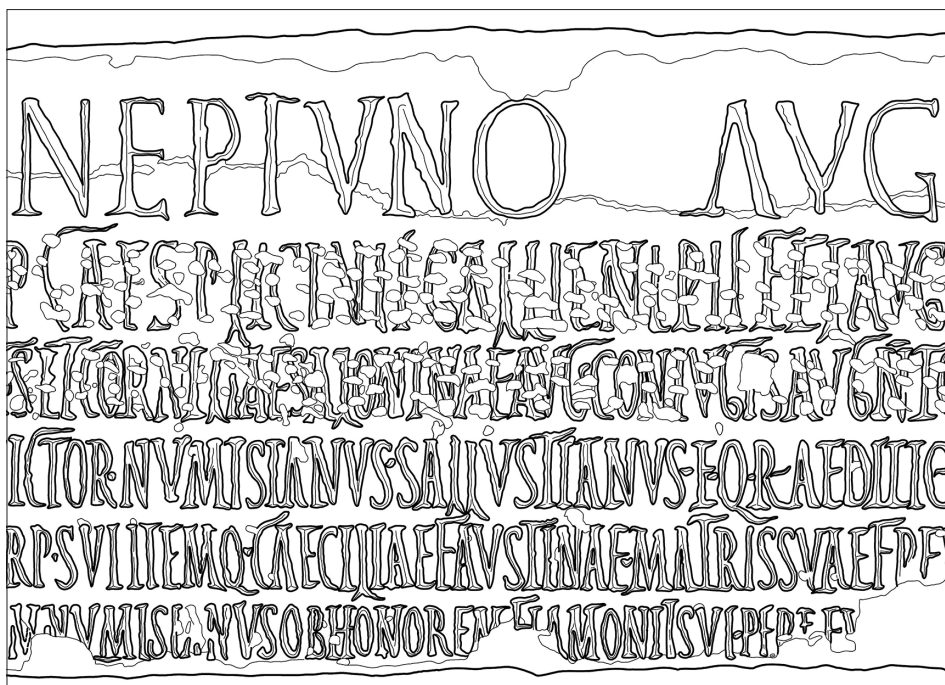

Fig. 15. Particolare del disegno dell'area erasa.

## CONCLUSIONI

La fotogrammetria degli oggetti vicini è un utilissimo strumento nello studio delle iscrizioni, consentendo di ottenere modelli tridimensionali fotorealistici con facilità e a basso costo. Ci sono casi però dove può risultare decisivo esplorare il modello 3D privo di colorazione e *texture*. La RTI risulta invece preziosa nell'analisi e nell'interpretazione dei testi epigrafici quando è importante osservare come la luce interagisce con la superficie iscritta e come si comportano la riflettanza e la *texture*. In entrambi i casi presi in esame sono stati utilizzati modelli 3D ottenuti con la fotogrammetria SfM.

Nel primo caso abbiamo mostrato alcune delle elaborazioni possibili dei modelli digitali che possono risultare utili nella lettura delle iscrizioni. Ci sembra importante avere, in casi particolari, la possibilità di ricavare un disegno automatico dell'iscrizione.

Nel secondo caso è stata proposta l'applicazione in modo totalmente virtuale della RTI. Il risultato assolutamente soddisfacente dell'esperimento ne incoraggia l'uso nei casi in cui risulta impossibile l'applicazione della modalità normale.

## RIFERIMENTI BIBLIOGRAFICI

- Aounallah A., Ganga S. e Mastino, A. (2019): "[E]x permissu [et indulgentia] optimi maximique principis: tra il 159 e il 162 (con appendice nel 389): grandi lavori alle terme a mare di Antonino Pio, Marco Aurelio, Lucio Vero", in: Sartori, A. ed.: *L'iscrizione nascosta, Atti del Convegno Borghesi 2017*, Epigrafia e antichità 42, Faenza, 203-230.
- Di Stefano Manzella, I. (1987): *Mestiere di epigrafista. Guida alla schedatura del materiale epigrafico lapideo*, Roma.
- Drew, M.S., Hel-Or, Y., Malzbender, T. e Hajari, N. (2012): "Robust Estimation of Surface Properties and Interpolation of Shadow/Specularity Components", <http://www.cs.sfu.ca/~mark/ftp/lvc2012/lvc2012.pdf> (consultato il 31/10/2023).
- Ganga, S. (1997): "Nota sui metodi di rilevamento epigrafico", in: Khanoussi, M. e Mastino, A. ed.: *Uchi Maius 1, scavi e ricerche epigrafiche in Tunisia*, Sassari, 357-360.
- Ganga, S. e Ibba, A. (2021): "La Sardinia sotto Marco Aurelio: Nuova lettura di AE 2001, 1112 = EDR153329 da Forum Traiani", *Zeitschrift für Papyrologie und Epigraphik*, 217, 271-278.
- Ganga, S., Mastino, A. e Valente, M. (2021): "Guerra e scavi clandestini in Libia: il *monumentum* funerario inedito di Caius Valerius Romanus reimpiegato in un gasr alla periferia occidentale di Tarhuna", *Quaderni di Archeologia della Libya*, 23, n.s. 3, 159-171.
- Malzbender, T., Gelb, D. e Wolters, H. (2001): "Polynomial Texture Maps", <http://www.hpl.hp.com/research/ptm/papers/ptm.pdf> (consultato il 31/10/2023).
- Mastino, A. (2018): "Neptunus Africanus: a Note", *CaSteR*, 3, 181-200, doi: 10.13125/caster/3457, <http://ojs.unica.it/index.php/caster/> (consultato il 31/10/2023).
- Mastino, A. e Ganga S. (2020): "Le futur du patrimoine : l'informatique et les nouvelles recherches sur l'épigraphie latine d'Afrique", in: Ben Damir, A. ed.: *Présence de l'Africa romana dans l'antiquité et à l'époque moderne et contemporaine, regards croisés*, Tunis, 271-295.
- Ruggeri, P. e Ganga, S. (2020): "Il tempio di Nettuno a Thignica e la colonizzazione di Thugga e Thubursicum Bure sotto Gallieno", in: Aounallah, S. e Mastino, A. ed.: *L'epigrafia del Nord Africa: novità, riletture, nuove sintesi*, Epigrafia e Antichità 45, Faenza, 73-91.
- Sechi, M., Gavini, A. e Ganga, S. (2015): "Nuove tecnologie applicate alla ricerca epigrafica: alcuni esempi.", in: Ruggeri, P. ed.: *L'Africa romana, Atti del XX Convegno Internazionale di studi, Alghero-Porto Conte Ricerche, 26-29 settembre 2013*, Roma, 1561-1584.
- Zhang, M. e Drew, M.S. (2014): Efficient robust image interpolation and surface properties using polynomial texture mapping, *EURASIP Journal on Image and Video Processing*, 25, <https://doi.org/10.1186/1687-5281-2014-25> (consultato il 31/10/2023).

Salvatore Ganga

Università di Sassari

Retrouvez la version en ligne gratuite  
et ses contenus additionnels



# SINERGÍAS DIGITALES PARA LA LECTURA DE EPÍGRAFES: CASUÍSTICA Y METODOLOGÍA

*Ignacio Triguero*

---

## INTRODUCCIÓN

El registro gráfico tridimensional se ha convertido en una herramienta indispensable para la documentación del patrimonio, especialmente en aquellos casos en los que la intervención conlleva una destrucción total o parcial del contexto objeto de estudio, algo que sucede sin excepción durante una excavación arqueológica. De este modo sus efectos quedan en parte paliados mediante una conservación exhaustiva de todas sus etapas, susceptibles de reevaluaciones ulteriores. Muchos pensamos que su implantación definitiva como requisito inherente a toda intervención debe completarse lo antes posible, conscientes de los problemas de estandarización prácticos que aún hoy persisten<sup>1</sup>.

El ámbito de estudio al que aquí nos referimos, que *grosso modo* podemos delimitar dentro del campo de la actividad gráfica, no se encuentra sujeto a la misma metodología que un yacimiento y su destrucción no es, en principio, inherente a la investigación. Sin embargo, aunque lentamente, el paso del tiempo destruye de forma inexorable los soportes inscritos, lo que ha empujado el desarrollo de técnicas de conservación. Ahora bien, son precisamente algunas de estas técnicas las que se han revelado como potentes herramientas de estudio. Es por ello que el objetivo principal de registrar y conservar ha dado el salto al análisis, permitiendo una interpretación superior en muchos aspectos a la que se pueda obtener *in situ*.

Entre las primeras aproximaciones al análisis gráfico tridimensional, destaca el empleo de la cámara estereométrica de Thompson-Watts aplicada por R. Atkinson en Stonehenge<sup>2</sup> o la amplia documentación que C. Ogleby y L. Rivett realizaron para el arte aborigen de Australia y Tailandia<sup>3</sup>. Las actuaciones de estos últimos dieron lugar a la obra clásica *Handbook of Heritage Photogrammetry*<sup>4</sup>, un hito utilizado como texto de referencia durante los años posteriores. Ha sido tras el cambio de milenio cuando se han generado los entornos digitales adecuados para la democratización en los análisis de los modelos obtenidos.

El siguiente paso lógico suponía resolver una doble problemática. Por un lado, estas herramientas se encaminaban hacia una mejora de la visibilidad de los soportes gráficos y, por otro lado, se resolvía la cuestión del empleo de métodos invasivos; un problema que chocaba frontalmente con la dirección y propósitos del método arqueológico.

Recordemos que, hasta momentos muy recientes – e incluso hasta la actualidad –, era común la realización de calcos directos o la aplicación de pasta de papel, silicona y otros materiales más agresivos como el yeso. El exponencial aumento de la capacidad de procesamiento de las

1 Vid. Sapirstein & Murray 2017.

2 Atkinson 1968.

3 Rivett 1983.

4 Ogleby & Rivett 1985.

computadoras ha permitido la emergencia de varios *softwares* específicos que proporcionan entornos digitales para el tratamiento de los modelos. La difusión de estas herramientas ha sido tal, que ha llegado prácticamente a todas las modalidades gráficas prehistóricas e históricas. Esto incluye reveladores resultados en varios conjuntos de petroglifos gallegos<sup>5</sup>, los extensos paneles grabados de Val Camonica<sup>6</sup>, los yacimientos paleolíticos al aire libre del occidente de la península ibérica<sup>7</sup>, el arte megalítico<sup>8</sup>, las estelas de la edad del Bronce del suroeste europeo<sup>9</sup> o las diversas manifestaciones presentes en cavidades<sup>10</sup>. El salto al terreno epigráfico se ha realizado recientemente, donde destacan los primeros trabajos realizados por H. Pires<sup>11</sup>, pionero de la técnica *MRM* (*morphological residual model*) o el proyecto Epigrafía 3D, que registra y difunde el patrimonio epigráfico contenido en el Museo Romano de Mérida<sup>12</sup>.

No es el objeto del presente texto realizar un recorrido por todas las técnicas disponibles, por lo que vamos a restringirlo a la metodología y herramientas concretas que nos han aportado resultados satisfactorios hasta ahora<sup>13</sup>. Este proceso, desarrollado durante los trabajos llevados a cabo por el profesor J. Gómez-Pantoja y quien firma este artículo desde 2017, ve aquí la luz en su forma más completa, como era nuestro deseo. Esto no es óbice para continuar implementando mejoras, dado que, de hecho, cada nueva pieza obliga a introducir nuevos tratamientos exclusivos para esta, en lo que se ha convertido en una amplia variedad de metodologías *ad hoc*.

El proceso puede ser definido en tres pasos: la toma de datos, la generación del modelo tridimensional y el tratamiento posterior de ese objeto. El material utilizado para la toma de datos ha estado compuesto principalmente por una cámara réflex Canon 2000D y un ordenador personal para el tratamiento posterior. Sin embargo, debido a la escasez de tiempo y a la dispersión de los hallazgos, en algunas ocasiones se ha recurrido a cámaras digitales compactas para el registro, mediante imágenes tomadas por los propios descubridores y remitidas a nosotros. Los softwares utilizados han consistido en Agisoft Metashape® para la restitución fotogramétrica y Meshlab<sup>14</sup> para la visualización y tratamiento de los modelos digitalizados. Adicionalmente y en algunas ocasiones, ha sido preciso el empleo de herramientas complementarias como Photoshop© y Dstretch®.

La restitución fotogramétrica que realizamos con Agisoft Metashape® emplea la tecnología conocida como *Structure from Motion* – Sfm en adelante –, complementada con tratamientos de visualización topográfica específica sobre la malla<sup>15</sup> 3D obtenida.

Explicado de forma sucinta, Sfm permite localizar una serie de puntos coincidentes en un conjunto de fotografías tomadas desde diferentes perspectivas para, mediante triangulación, extraer una nube densa<sup>16</sup> de puntos del objeto documentado – *Point Set Surface* – y posteriormente generar una malla 3D. De esta manera se obtiene tanto un rápido acceso al objeto en un entorno tridimensional como la posibilidad de crear una imagen ortonormalizada.

5 Vázquez *et al.* 2018.

6 Medici & Rossi 2015.

7 Baptista *et al.* 2010.

8 Cerrillo *et al.* 2019.

9 González-Cordero *et al.* 2022.

10 Aragoncillo & Triguero 2021.

11 Pires *et al.* 2014.

12 Ramírez *et al.* 2017.

13 González-Cordero *et al.* 2022; Triguero *et al.* 2021; Aragoncillo & Triguero 2021; Gómez-Pantoja & Triguero 2021a, Gómez-Pantoja *et al.* 2019.

14 Cignoni *et al.* 2008.

15 Malla, *mesh*, *maillage*, ver en este volumen Comte & González Bordas, 16, n. 23 y Ganga, 53.

16 Nube densa, *dense cloud*, *nuage de points dense*, *nuvola densa*, ver en este volumen Comte & González Bordas, 16, n. 24.

Las tecnologías que se sirven de conjuntos de imágenes para generar mapas topográficos tienen tras de sí más de medio siglo de desarrollo, desde los primeros vuelos militares hasta las actuales *apps* para smartphones<sup>17</sup>. Sin lugar a dudas, una de las grandes ventajas de esta técnica es su nulo impacto sobre el soporte.

## METODOLOGÍA

### La toma de datos

En aquellos casos en los que las condiciones de documentación son óptimas, se procede al fotografiado de los soportes, tomando una cantidad de imágenes que normalmente oscila entre 20 y 50, almacenadas tanto en formato Raw, cuando existe la posibilidad, como en *jpeg* de alta calidad. Las fotografías se realizan de forma consecutiva, tratando de cubrir todos los ángulos posibles con un solapamiento entre imágenes de entre un 70-80%. Una vez seleccionadas las mejores tomas, se procede a una restitución fotogramétrica, un proceso automático que finaliza con la creación de un archivo *.ply* o *.3ds* que se exporta para su uso en las posteriores herramientas. Ahora bien, esto solo puede ser realizado cuando las condiciones son adecuadas y tenemos un cómodo acceso al objeto de estudio, algo que sucede en raras ocasiones.

Algunas de las situaciones que obligan a ajustar la metodología son aquellas en las que el objeto se sitúa en algún punto elevado o estrecho, como la pieza localizada en el Palacio de los Ovando, en Cáceres (España)<sup>18</sup> (**fig. 1**). Se trata de una inscripción situada en una alta torre, abierta a un estrecho callejón, que fue identificada en un primer momento por J. Sanguino y Michel<sup>19</sup>, quien distinguió las letras VIR, y posteriormente relocalizada por R. Núñez y reestudiada por nosotros. La inaccesibilidad de la pieza nos obligó a tomar las imágenes desde una distancia y un ángulo incómodos, lo que fue óbice para ofrecer un registro completo de la pieza. Dado que el examen preliminar reveló la existencia de al menos tres líneas de texto, tomamos una serie de fotografías desde diferentes posiciones en nivel del suelo y con la misma distancia focal, utilizando una cámara Canon EOS 2000D con objetivo 18-55. Debido a la estrechez del ángulo y la oblicuidad de los planos de cámara, fue necesario registrar gran parte de la fachada de esta parte del edificio para facilitar la triangulación y evitar aberraciones ópticas (**fig. 2**). En futuras intervenciones se contempla la utilización de otros medios para el estudio de este tipo de casos, como el empleo del dron, cuya metodología específica está actualmente en desarrollo.

Una vez generado el fotomosaico, se obtuvo una nube de puntos de alta densidad seleccionando solo las partes que muestran la inscripción. El resultado fue una lectura casi completa de la inscripción, así como un registro completo de la misma.

La lectura fue aumentada, desde el original VIR, hasta completar la inscripción:

Urbana | Virgi[ni f(ilia) vel u(xor) vel s(erva)] | Hic s(ita) [e(st)].

En otro caso reciente, durante la última actualización del catálogo epigráfico de la ciudad romana de Complutum, en Alcalá de Henares (Madrid), nos enfrentamos a un problema similar<sup>20</sup>. Algunas de sus piezas se encuentran reutilizadas como elementos constructivos en la Catedral Magistral de Alcalá de Henares (**fig. 3**), y fueron estudiadas hace algunos años gracias a unas

17 Vid. Micheletti *et al.* 2015. Para un recorrido por las diferentes aplicaciones de esta técnica.

18 Gómez-Pantoja & Triguero 2021a, 98-99.

19 Sanguino y Michel 1996.

20 Rascón & Sánchez-Montes 2020.



Fig. 1. Inscripciones situadas en lugares elevados o difícilmente accesibles. Palacio de los Ovando, en Cáceres (izquierda), y Palacio Arzobispal de Alcalá de Henares (derecha). Imágenes tomadas por R. Núñez e I. Triguero respectivamente.

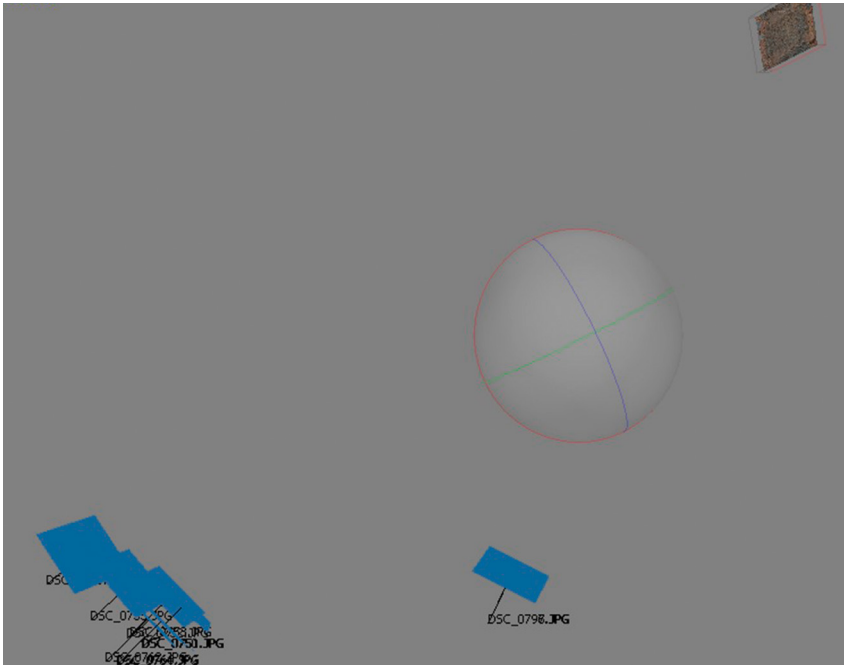

Fig. 2. Toma de imágenes de la inscripción del palacio de los Ovando. Arriba a la derecha, la lápida; abajo a la izquierda, los rectángulos azules indican la posición desde la cual se tomaron las fotografías. El resto de la fachada ha sido eliminado. Imagen de I. Triguero.

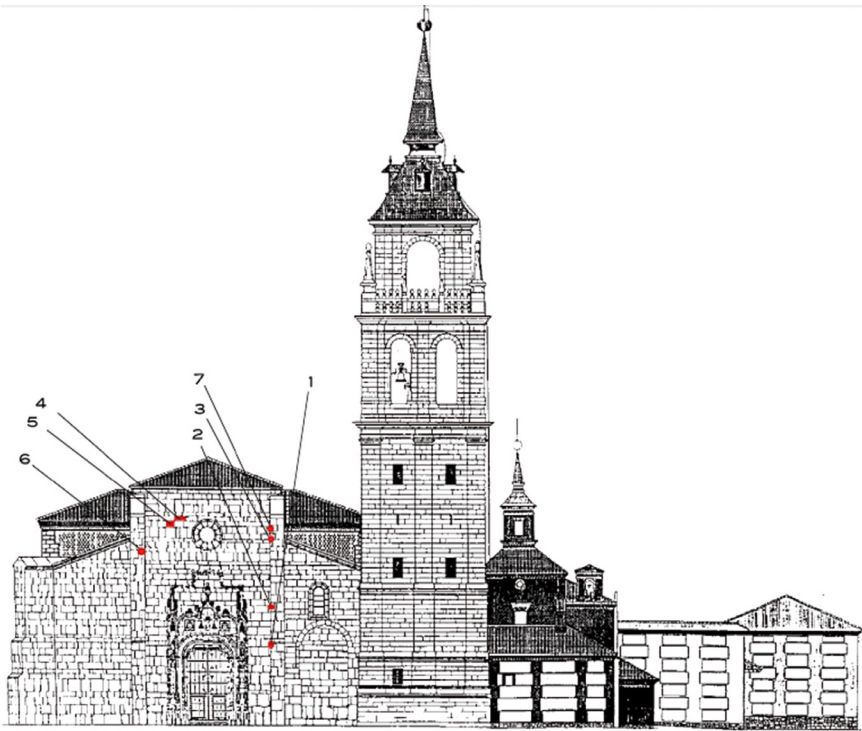

Fig. 3. Plano de la fachada de la catedral Magistral de Alcalá de Henares con indicación de las inscripciones reaprovechadas. Según J. Gómez-Pantoja (2003).

obras de mantenimiento que permitieron el acercamiento mediante el andamiaje<sup>21</sup>. Sin embargo, no se había realizado el registro gráfico adecuado que permitiese su consulta posterior para fines divulgativos. Por ello, y ante la imposibilidad de acceso, recurrimos al empleo de teleobjetivo desde el nivel de suelo para conseguir todas las imágenes necesarias para la reconstrucción<sup>22</sup>. Obraos de la misma forma en otra inscripción localizada en el Palacio Arzobispal de la misma ciudad<sup>23</sup> (fig. 1 derecha). En esta ocasión, la lectura no presentaba problemas, dado lo nítido de los caracteres y el buen estado de conservación. Sin embargo, la imposibilidad de obtener una imagen frontal obligó a emplear de nuevo la restitución fotogramétrica.

### La modificación morfológica del objeto

La siguiente operación se realiza dentro del software Meshlab, que permite tanto modificar las iluminaciones, las características físicas del modelo como realizar el posterior proceso de falso color. Esta herramienta, desarrollada en la universidad de Pisa, es gratuita y de uso libre.

Una vez que el modelo ha sido importado, se realiza una inspección de la visibilidad de la inscripción mediante la herramienta de *iluminación dinámica* incluida en Meshlab. Este

21 Gómez-Pantoja 2003.

22 Rascón & Sánchez-Montes 2020, 148.

23 *Ibid.*, p. 142.

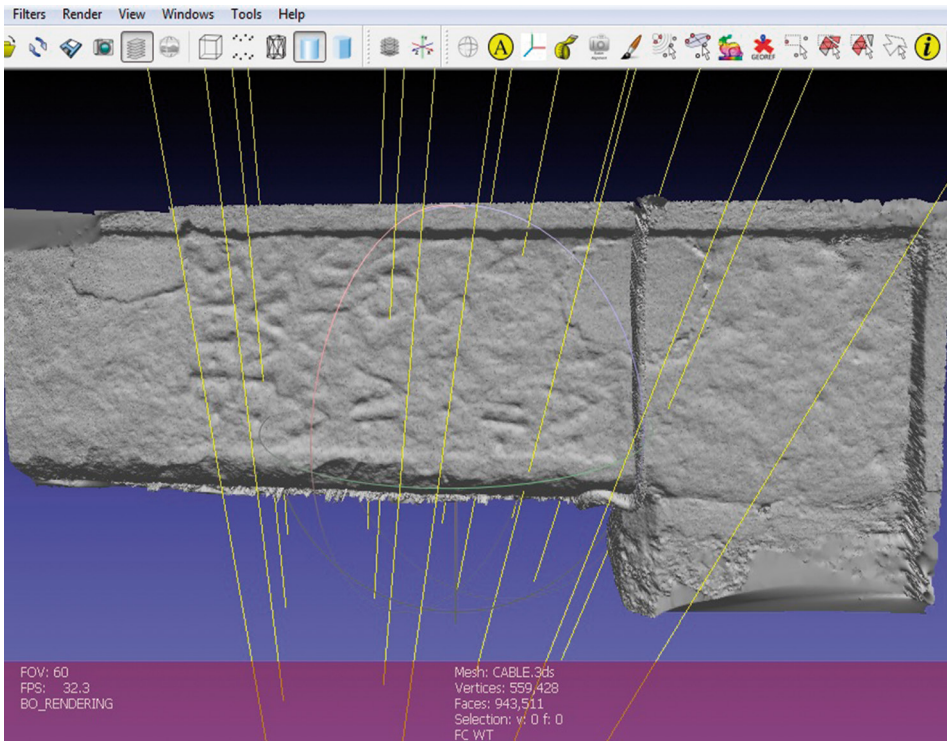

Fig. 4. Análisis mediante iluminación dinámica de una inscripción inédita reutilizada como dintel en el municipio cacereño de Madroñera. Imagen de I. Triguero

procedimiento no se diferencia mucho del tradicional uso de la luz rasante, sin embargo, la capacidad de establecer parámetros de luminosidad en un entorno tridimensional permite generar diversos focos opuestos que mejoran la lectura ostensiblemente. Esto mejora la calidad de los resultados y elimina la dependencia de factores ambientales, tan habitual en entornos exteriores.

Si mediante esta inspección se detectan problemas de lectura, el siguiente paso consiste en identificar los impedimentos físicos existentes. Esto tiene tanto que ver con las características morfológicas del soporte como con el tipo de deterioro al que haya sido sometido.

Podemos distinguir las características de las rocas y los procesos que sufren dentro de los siguientes grupos:

**Meteorización:** sucede habitualmente sobre rocas metamórficas de grano grueso, como granitos o gneises. En estos casos, es frecuente que la superficie rocosa presente un aspecto de desintegración, en la que fragmentos de mediano o gran tamaño han abandonado el soporte (**fig. 5.2**). Los vestigios de inscripción sufren también este proceso, lo que los hace indistinguibles del resto de roturas. Consiste en uno de los casos más difíciles de recuperar y el proceso que realizamos conlleva una inherente pérdida de información. Este tipo de destrucción es muy frecuente en los miliarios de la mitad occidental de la península ibérica, habitualmente situados a la intemperie y sobre los que opera más a menudo la gelifracción.

En estos casos es preciso aplicar un proceso de *downsampling*, esto es, una simplificación de la malla mediante la reducción de la nube de puntos que suavice la superficie y la vuelva más homogénea. Este proceso se realiza mediante la herramienta *Simplification: Clustering*



*decimation*, que permite introducir el porcentaje de reducción al que vamos a someter al objeto. Normalmente, con una reducción de un 10% a un 20%, ya se consigue alcanzar un aspecto más redondeado de las aristas; un exceso de simplificación puede desembocar en una excesiva pérdida de información.

De este modo, aunque parezca lo contrario, las incisiones antrópicas, habitualmente generadas por percusión indirecta y perpendicular sobre el soporte, consiguen distanciarse de los desperfectos, que presentan generalmente un patrón más caótico. Dentro de este apartado también incluimos las roturas generadas por la acción humana, en todo caso ajenas a la intención gráfica, tales como el reaprovechamiento posterior como elementos edilicios o mecánicos.

*Abrasionado*: el resultado que produce ofrece un aspecto diametralmente opuesto al anterior. Se da en rocas situadas a la intemperie sobre las que se ejerce algún tipo de desgaste continuo y uniforme, como puede ser el que realiza el agua (abrasión hídrica) o el viento (abrasión eólica) (**fig. 5.4**). Es habitual en la epigrafía rupestre, tanto en superficies horizontales de afloramientos graníticos o areniscas expuestas al agua como en calizas situadas a la intemperie<sup>24</sup>. El perfil de destrucción de esta última roca es mucho mayor, algo que repercute en el número de ejemplos rupestres respecto a rocas más duras, a menos que se encuentren en abrigos o cavidades. Pese a ello destacamos la existencia de honrosas excepciones como el santuario de Villalba de Peñastar, en Teruel.

En esta ocasión, el tratamiento del objeto tridimensional va a buscar un realce artificial de las condiciones topográficas de la inscripción, ante la inexistencia de imperfecciones en el campo epigráfico que dificulten la lectura. La amplificación de las interrupciones en el relieve se incluye dentro de los procesos comúnmente conocidos como *upsampling*. El renderizado *Radiance Scaling* de Meshlab<sup>25</sup> permite exagerar el sombreado de las concavidades y convexidades abruptas de la malla mediante una iluminación artificial, consiguiendo una mejor visualización de los trazos poco profundos no apreciables en condiciones normales. Entre las variantes de realce topográfico de esta herramienta se encuentran *Lambertian Radiance Scaling*, *Lit Sphere Radiance Scaling*, *Colored Descriptor* y *Grey Descriptor*. Aunque nos decantamos normalmente por las dos primeras, el resto pueden ofrecer resultados interesantes. En concreto, *Lit Sphere Radiance Scaling* cuenta con un mayor margen de personalización con respecto al resto, puesto que permite sustituir las esferas de iluminación por otras que confeccionemos nosotros. Esto nos permite adecuar la coloración de las concavidades y las convexidades, así como el efecto de sombreado a las necesidades de cada inscripción.

*Pulimentado*: íntimamente relacionado con el punto anterior, reservamos este apartado para los casos en los que el roce continuo de la superficie le confiere un aspecto aún más exagerado que en el abrasionado, llegando a alcanzar un aspecto brillante o barnizado (**fig. 5.1**). A este estado se llega normalmente por el continuo paso de animales o por la reutilización de la pieza como elemento constructivo, susceptible de ser pisado o frotado de forma frecuente. La mayoría de estos ejemplos están más allá de toda recuperación.

*Disolución*: casi exclusivo de las rocas de origen sedimentario, este tipo de degradación aparece principalmente sobre calcáreas: calizas, dolomías y margas. El frente del campo epigráfico retrocede, habitualmente de modo regular y constante hasta alcanzar el fondo del surco de las incisiones o el piqueteado (**fig. 5.3**).

Este tipo de inscripciones, siempre que quede un mínimo rastro de incisión, aunque esta no sea apreciable a simple vista, son altamente recuperables, ofreciendo resultados muy positivos

24 Vid. Gómez-Pantoja & Triguero 2021b, donde revisamos dos casos de epigrafía rupestre con las características mencionadas.

25 Vergne *et al.* 2010.

(fig. 6, arriba). De nuevo se precisa el empleo de las herramientas de *upsampling*, tal y como hemos mencionado para el caso del abrasionado. En el caso de las inscripciones situadas en cuevas, el tratamiento es más complejo; la filtración de agua, en el caso de producirse, tiende a incidir de un modo local, produciendo tanto la mencionada disolución como la redeposición en forma de coladas estalagmíticas. El resultado es un aspecto amorfo de difícil recuperación.

*Factores biológicos:* Por último, debemos mencionar la acción que elementos biológicos como musgos y líquenes producen sobre la superficie. Además de la obvia pérdida de visibilidad por la coloración que provocan, estos elementos, junto con la tierra que retienen, tienden a consolidarse con el paso del tiempo, añadiendo una cantidad de material nada desdeñable. Los métodos invasivos de limpieza que puedan realizarse están fuera del ámbito de este estudio, por lo que solo podemos limitarnos a retirar todos los atributos de color que puedan dificultar la visualización y obrar del mismo modo que con la meteorización, aplicando un *downsampling* que permita suavizar estas imperfecciones.

Podríamos añadir un grupo extra para los diversos factores antrópicos ejercidos sobre las piezas, pero su número es casi infinito; desde el borrado a causa de una *damnatio memoriae*, al piqueteado para acercar su morfología a la de un sillar, a la aplicación de materiales constructivos como cementos o pinturas, hasta el continuo desgaste producido por maquinaria agrícola.



Fig. 5. Diversas degradaciones a las que se ha visto sometido el campo epigráfico. De izquierda a derecha y de arriba a abajo: estela reutilizada como escalón localizada en Trujillo con aspecto de pulimentado, imagen de I. Triguero; lápida emergida próxima a la ciudad romana de Augustobriga, fuertemente meteorizada, imagen de A. González Cordero; estela que muestra los efectos de la disolución localizada en el jardín de la mansión “La Viña” en Trujillo, imagen de I. Triguero; inscripción de Fonte da Tigela, Guarda, situada en un berrocal granítico de disposición horizontal, según Cómez-Pantoja & Triguero (2021b).

## El color artificial

Es posible que, tras el paso anterior, y con una correcta iluminación, no precisemos realizar ninguna acción posterior. Sin embargo, para piezas profundamente erosionadas se puede proceder con un coloreado artificial mediante la herramienta *Algebraic Point Set Surface (APSS)*<sup>26</sup>. Tomando como punto de partida la nube densa de puntos orientados – *oriented normals*<sup>27</sup> –, APSS genera una nueva superficie a través de una aproximación a los datos mediante mínimos cuadrados promedio (MLS), disminuyendo así el error cuadrático y el residuo; especialmente eficaz para reconstruir pequeñas variaciones en el relieve. Como complemento adicional, los vértices son etiquetados por colores según su orientación e inclinación de manera regular respecto a los adyacentes. Visualmente, esto nos permite diferenciar entre aquellas imperfecciones producidas por la meteorización del soporte de aquellos trazos incisos o piqueteados, realizados por lo general de una manera perpendicular al plano. El objetivo de esta herramienta, así como gran parte del resto, no es el que aquí le damos, por ello requieren un tiempo considerable para su calibración. De forma previa a la aplicación de este filtro la pieza debe estar correctamente orientada en el espacio, esto es, alineada con los ejes X, Y, Z, con especial atención a la profundidad.

Los valores susceptibles de manipulación en APSS se refieren a los umbrales de actuación del filtro. Resultaría muy extenso pormenorizar todas las posibles combinaciones y configuraciones aquí, pero pueden ser resumidas mediante la regla de que a valores más altos, se produce una actuación más agresiva sobre el soporte. Sin embargo, para un mejor resultado en APSS es preciso seleccionar el tipo de curvatura "*approxmean*" cuando estemos tratando con inscripciones.

Recomendamos utilizar esta herramienta junto con las anteriormente mencionadas *Radiance Scalling* y la *iluminación dinámica* hasta alcanzar el grado de visibilidad deseado.

## Herramientas 2D auxiliares

Para algunos casos especialmente difíciles, existe una serie de actuaciones, menos establecidas o regladas, para intentar aumentar la legibilidad de la pieza. Nosotros utilizamos preferentemente Adobe Photoshop®, si bien hemos empleado en alguna ocasión Dstretch<sup>28</sup>, de modo completamente experimental. Dado que los productos gráficos obtenidos de las fases anteriores pueden ser traducidos a imágenes, podemos proyectar sobre ellas tratamientos bidimensionales "clásicos", que casi siempre destinamos a fines divulgativos.

Entre las acciones que podemos realizar mediante Adobe Photoshop®, destacamos la herramienta de ajuste *Camera Raw*, con la que podemos recalibrar las propiedades de color, para realzar aquellos que resulten más relevantes, o *Reemplazar Color*, si queremos ajustar los tonos de base ofrecidos por Meshlab a nuestras necesidades.

De igual modo, la herramienta Dstretch, software gratuito bajo petición a su creador, puede aportar resultados interesantes. Si bien fue originalmente diseñada para detectar pigmentos presentes en el arte rupestre, debido a los atributos de color que poseen nuestras imágenes tratadas, este software ayuda a revelar aquellos que nos interesen atenuando el resto.

26 Guennebaud & Gross 2007.

27 Para las normales, ver en este volumen Comte & González Bordas, 16, n. 25.

28 Harman 2015.

En algunas ocasiones todos nuestros esfuerzos resultan infructuosos, o alcanzamos “pequeñas victorias” como dotar, al menos, de nombre al difunto o al dedicante. Así sucede en una pieza de la desaparecida *Augustobriga*, emergida del embalse de Valdecañas durante una sequía, con una primera lectura de González Cordero<sup>29</sup>, sobre la que nosotros presentamos otra versión<sup>30</sup> (**fig. 6**, abajo). Sin embargo, a pesar de la agresiva meteorización, la integridad de la pieza nos empuja a redoblar esfuerzos en este tipo de casos, que creemos en parte recuperables.

Es necesaria una correcta distribución de las herramientas descritas y los filtros empleados para obtener un efecto satisfactorio. Incluso obrando así, el resultado nunca puede considerarse cerrado, del mismo modo que las lecturas tradicionales tampoco han sido nunca definitivas. Cada equipo de trabajo sigue su propio método que, lejos de ser unitario y fijado, no para de evolucionar y diversificarse. Es por tanto necesario un acceso abierto a los resultados obtenidos, los objetos digitales y la metodología de registro empleada, mediante un repositorio digital que evite la pérdida de un volumen de datos que no cesa de aumentar.

## EL PROBLEMA EPISTEMOLÓGICO

En otro lugar ya apuntamos el debate que suscita el empleo de estas tecnologías, esencialmente la aplicación “automática” de falso color, y alegamos cómo el factor humano continúa siendo decisivo, al menos dentro de nuestra metodología concreta<sup>31</sup>. El campo de las humanidades digitales avanza rápidamente y las distancias entre el investigador y los medios para responder a sus preguntas se dilatan, de tal modo que la imagen del humanista autosuficiente se diluye. La tan necesaria interdisciplinariedad no suele acarrear disputas si los resultados de las diferentes aproximaciones convergen en una hipótesis común, sin embargo, las fricciones afloran cuando esto no es así.

Podemos recordar algunos ejemplos cercanos en el tiempo de desavenencias entre las ciencias humanas e investigadores provenientes de disciplinas más “duras”. La datación del arte rupestre más antiguo de Europa mediante series de Uranio en algunas cuevas de la península ibérica, – Ardales, Maltravieso o La Pasiiega –, adjudicaba estas obras al *homo neanderthalensis*<sup>32</sup>. Esto trajo consigo una fuerte reacción de una facción de arqueólogos europeos en varios artículos, donde se aducía, entre otros argumentos, la falta de bases arqueológicas para aseverar una edad dentro del Paleolítico medio para estos pigmentos<sup>33</sup>. Del otro lado de los Pirineos, la *grotte Chauvet* se encuentra envuelta en un debate similar; las fechas obtenidas mediante AMS (*Espectrometría de Masas con Acelerador*, por sus siglas en inglés, método más preciso que el radiocarbono para determinar la presencia de Carbono-14) pusieron en tela de juicio muchos de los asertos sobre el desarrollo gráfico de la Europa occidental. Es por todo ello que aquellas evidencias que cuestionan los paradigmas actuales se escrudiñan con detalle y sus puntos débiles son inmediatamente expuestos.

Durante 2018, otro debate adquirió similares proporciones en cuanto a difusión. En un diario español de tirada nacional se publicó una noticia con el impactante titular “*Una invasión borró del mapa a los hombres de la península Ibérica hace 4.500 años*”<sup>34</sup>. Esta investigación, realizada por medio de análisis genéticos y dirigida por la universidad de Harvard, provocó una gran reacción entre arqueólogos portugueses y españoles pertenecientes al ámbito de la Prehistoria

29 González Cordero 2001, 141.

30 Gómez-Pantoja & Triguero 2021a, 102.

31 Gómez-Pantoja & Triguero 2021a, 102-103.

32 Hoffmann *et al.* 2018.

33 White *et al.* 2020.

34 Ansedo 2018.



Fig. 6. Análisis mediante color artificial de dos inscripciones. Arriba, estela del Jardín de la mansión "La Viña"; abajo, lápida aparecida en las inmediaciones de Augustóbriga. En ellas se ha empleado APSS, Radiance Scalling y Adobe Photoshop©. Ambas imágenes modificadas a partir de Gómez-Pantoja & Triguero 2021a.

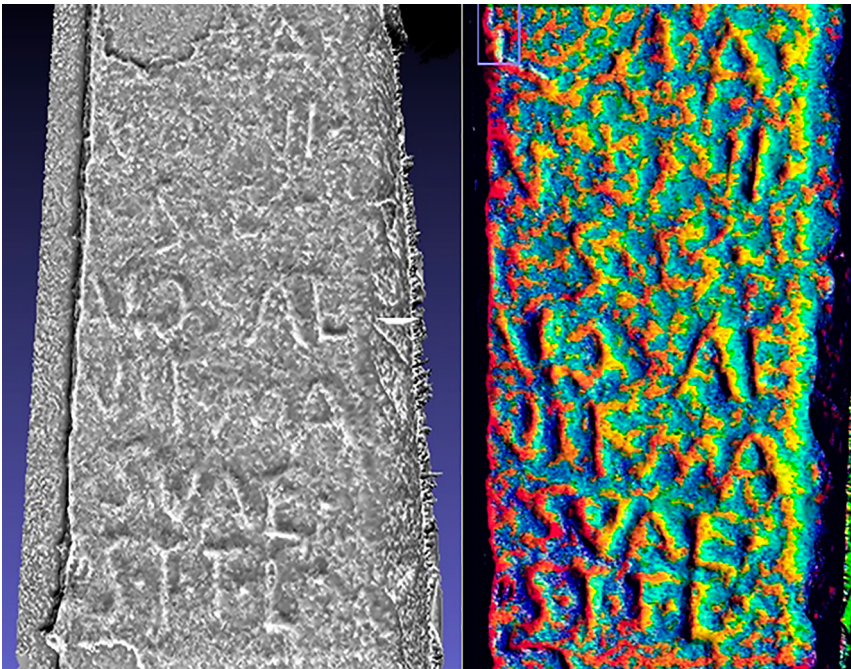

Fig. 7. Aplicación de Radiance Scalling y Dstretch® a la inscripción de la fig. 4, localizada en Madroñera, Cáceres y actualmente en estudio. Imágenes de I. Triguero.

reciente que desembocó en una carta abierta de amplio alcance. En esta réplica, redactada por F. Criado y secundada por 91 arqueólogos<sup>35</sup>, no solo se critica el lenguaje efectista empleado por el redactor de la noticia, sino que se posiciona de forma clara dentro del debate entre ciencia y arqueología. Uno de sus fragmentos dice lo siguiente:

“Aunque el desarrollo de la Arqueogenética es una de las novedades más potentes y de más profundo efecto de la llamada Tercera Revolución Científica en Arqueología, [...] la validez de sus resultados dependerá siempre del conocimiento proporcionado por la Arqueología, en su concepción de ciencia social y humanística centrada en el estudio de la dimensión material de la conducta humana”<sup>36</sup>.

Los casos expuestos parecen un tanto extremos en comparación con el alcance del método que ofrecemos aquí. Ahora bien, los recientes estudios que introducen la AI mediante Machine Learning<sup>37</sup> o Deep Learning<sup>38</sup> suscitan nuevos debates cuando la inspección directa desaparece de la ecuación, o bien de la fase de recogida de datos. Recientemente, S. Orlandi<sup>39</sup> ha realizado una lúcida reflexión en torno a estas herramientas. La autora recoge, de forma sistemática, algunos casos concretos, dentro de las ciencias de la Antigüedad, en los que, por ahora, el factor humano es indispensable. No solo eso, además pone el acento en “la capacidad de análisis, de reflexión y de crítica” necesarias para hacer válido cualquier conocimiento científico, así como para su efectiva divulgación social.

Otros investigadores han intentado obtener un cierto consenso en torno a este tipo de rápidas disrupciones del paradigma, concluyendo que el debate siempre ha sido una de las características necesarias del método científico<sup>40</sup>.

Por nuestra parte, solo podemos continuar observando y supervisando los progresos técnicos sin olvidar que la ciencia responde preguntas, ante la creciente tendencia en la que los métodos se convierten en fines en sí mismos.

## AGRADECIMIENTOS

Agradecemos a todos los colegas que han colaborado en los casos incluidos aquí, así como en otros que están en curso de estudio: Antonio González-Cordero, Francisco Pérez Solís, Eduardo Alfaro y Rubén Núñez Quesada.

35 Criado 2018.

36 Criado 2018.

37 Eyharabide *et al.* 2022.

38 Rizk *et al.* 2022.

39 Orlandi 2019.

40 Vid. Alcolea-González & González-Sainz 2015.

## BIBLIOGRAFÍA

- Alcolea-González, J. y González-Sainz, C. (2015): "'Science' versus Archaeology: Palaeolithic Rock Art at the beginning of the 21st century", in: Bueno, P. y Bahn, P. ed: *Prehistoric Art as Prehistoric Culture. Studies in Honour of Professor Rodrigo de Balbín-Behrmann*, Archaeopress Archaeology, 1-10.
- Ansede, M. (2018): "Una invasión borró del mapa a los hombres de la península Ibérica hace 4.500 años", *El País*, 2 Oct. 2018 - 21:25 (consultado el 5/01/2023) [https://elpais.com/elpais/2018/10/01/ciencia/1538416630\\_736638.html](https://elpais.com/elpais/2018/10/01/ciencia/1538416630_736638.html).
- Aragoncillo, J., y Triguero, I. (2021): "Simbolismo de la Edad del Bronce en la Meseta oriental: un depósito cerámico con Arte Pospaleolítico en la cueva del Cojillo (Checa, Guadalajara)", *Munibe Antropologia-Arkeologia*, 72(1), 111-122.
- Atkinson, K. B. (1968): "The recording of some prehistoric carvings at Stonehenge", *The Photogrammetric Record*, 6(31), 24-31.
- Cignoni, P., Callieri, M., Corsini, M., Dellepiane, M., Ganovelli, F. y Ranzuglia, G. (2008): "MeshLab: an Open-Source Mesh Processing Tool", *Sixth Eurographics Italian Chapter Conference, Salerno, Italy*, 129-136.
- Criado, F. (2018): "Genética de una 'fake news': respuesta a las noticias sobre 'invasiones' y 'exterminios' en el III milenio Antes de Nuestra Era en la Península Ibérica", publicada por El País y otros medios esta semana", *Publicado en el perfil personal de Facebook*: <https://www.facebook.com/felipe.criadoboado/posts/1748078708651060>.
- Eyharabide, V., Caseau, B., Cheynet, E. C., Orlandi, L., Huang, Q. y Bloch, I. (2022): "Byzantine Sigillography meets Artificial Intelligence: The BHAI Project", *Numismatics, Sphragistics and Epigraphy*, In press.
- Gómez Pantoja, J. (2003): "Inscripciones romanas de la Catedral magistral de Alcalá de Henares", *Vrbs Aeterna*, 493-511.
- Gómez-Pantoja, J.L., Triguero, I. y Núñez, R. (2019): "Up & Down: sendos epígrafes del Palacio de Las Cigüeñas en Cáceres y de Aldea del Cano (Conventus Emeritensis)", *Ficheiro epigrafico*, 191, 706-707.
- Gómez-Pantoja, J.L. y Triguero, I. (2021a): "Rough-and-Ready: 3D Models Rescuing some Roman Inscriptions from Lusitania", in: Velázquez Soriano, I. y Espinosa, D. ed.: *Epigraphy in the Digital Age: Chances and Challenges of the Recording, Analysis and Dissemination of Epigraphic Texts*, Oxford, 105-114.
- Gómez-Pantoja, J.L. y Triguero, I. (2021b): "Háblenme Montes Y Valles, Crittenme Piedras Del Campo: Grabados Rupestres Singulares Del Interior Peninsular", in: Mayoral, V., Bellón J. P. y Grau, I. ed.: *Arqueología y sociedad de los Espacios Agrarios: en busca de la gente invisible a través de la materialidad del paisaje*, Anejos de Archivo Español de Arqueología, 91, Madrid, 185-196.
- González Cordero, A. (2001): "Catálogo de las inscripciones romanas del Campo Arañuelo, La Jara y Los Lobos", in: Quijada González, D. ed.: *VII Coloquios Histórico-culturales del Campo Arañuelo. Dedicados a Don Justo Corchón García, Navalmoral de la Mata, del 20 al 24 de Noviembre de 2000*, Navalmoral de la Mata, 115-164.
- González Cordero, A., Mederos, A. y Triguero, I. (2022): "Una nueva estela de guerrero del Bronce Final en Ibahernando (Cáceres)", *Cuadernos de Prehistoria y Arqueología de la Universidad Autónoma de Madrid*, 48(1), 63-104 <https://doi.org/10.15366/cupauam2022.48.1.003> (consultado le 30/10/2023).
- Guennebaud, G. y Gross, M (2007): "Algebraic point set surfaces", *ACM Transactions on Graphics*, 26(3), article 23.
- Harman, J., ed. (2005): "Using decorrelation stretch to enhance rock art images", *American Rock Art Research Association Annual Meeting*, 28, 1-4.
- Hoffman, D.L., Standish, C.D., García-Diez, M., Pettitt, P.B., Milton, J.A., Zilhão, J., Alcolea-González, J., Cantalejo-Duarte, P., Collado, H., de Balbín, R., Lorblanchet, M., Ramos-Muñoz, J., Weniger, G.C. y Pike, A.W. (2018): "U-Th dating of carbonate crusts reveals Neandertal origin of Iberian cave art", *Science*, 359, 912-915.
- Micheletti, N., Chandler, J.H. y Lane, S.N. (2015): "Structure from Motion (SfM) photogrammetry", in: Cook, S.J., Clarke, L.E. y Nield, J.M. ed.: *Geomorphological Techniques (Online Edition)*, Londres <https://hdl.handle.net/2134/17493>.
- Ogleby, C. y Rivett, L. (1985): "Handbook of Heritage Photogrammetry", *Australian Heritage Commission, Special Australian Heritage Publication Series*, 4, Canberra.

- Orlandi, S. (2019): "Digital Epigraphy. Tra automazione e singolarizzazione. Lexicon Philosophicum", *International Journal for the History of Texts and Ideas*, 7, 159-168.
- Pires, H., Fonte, J., Gonçalves-Seco, L., Correia Santos, M.J. y Sousa, O. (2014): "Morphological residual model. A tool for enhancing epigraphic readings of highly eroded surfaces", in: Orlandi, S., Santucci, R., Casarosa, V. y Liuzzo, ed.: *Information Technologies for Epigraphy and Cultural Heritage, Proceedings of the First EAGLE International Conference*, Roma, 133-144.
- Ramírez-Sánchez, M., Suárez Rivero, J. y Guerra Soto, H. (2017): "La epigrafía romana de Augusta Emerita más allá del Museo: digitalización, modelización 3D y difusión a través de dispositivos móviles", *Revista de Humanidades Digitales*, 1, 96-115 <https://doi.org/10.5944/rhd.vol.1.2017.16680> (consultado el 30/10/2023).
- Rascón, S. y Sánchez-Montes, A. L. (2020): *Ciudad Romana de Complutum 2020*, con la colaboración de J. Gómez-Pantoja, Serie guías arqueológicas de Alcalá de Henares, Madrid
- Rizk, R., Rizk, D., Rizk, F. y Kumar, A. (2021): "A Hybrid Capsule Network-based Deep Learning Framework for Deciphering Ancient Scripts with Scarce Annotations: A Case Study on Phoenician Epigraphy", in: *2021 IEEE International Midwest Symposium on Circuits and Systems (MWSCAS)*, 617-620.
- Rivett, L. J. (1983): "The application of photogrammetry to the recording of rock art and archaeological sites in the Kakadu National Park", in: Gillespie, D. ed.: *The Rock Art Sites of Kakadu National Park*, Canberra, 87-125.
- Sanguino y Michel, J. (1996): *Notas referentes a Cáceres* (facsimile del manuscrito autógrafo, transcrito por M. y M. Pulido Cordero y A. Martín Cordero), Cáceres.
- Sapirstein, P. y Murray, S. (2017): "Establishing best practices for photogrammetric recording during archaeological fieldwork", *Journal of Field Archaeology*, 42(4), 337-350.
- Triguero, I., Luque, L., Castillo-Jiménez, S. y Alcaraz-Castaño, M. (2021): "El abrigo de Haza La Viña: un yacimiento de arte rupestre esquemático en el valle del río Sorbe (Muriel, Guadalajara, España)", *Munibe Antropologia-Arkeologia*, 72, 1, 85-95.
- Vázquez, A., Rodríguez, C. y Fábregas, R. (2018): "Petroglifos gallegos, una perspectiva desde el siglo XXI", *Cuadernos de Arte Prehistórico*, 6, 61-83.
- Vergne, R., Pacanowski, R., Barla, P., Granier, X. y Schlick, C. (2010): "Radiance Scaling for Versatile Surface Enhancement", in: *IBD '10: Proc. Symposium on Interactive 3D graphics and games*, Boston.
- White, R., Bosinski, G., Bourrillon, R., Clottes, J., Conkey, M.W., Corchón, M.S., Cortes-Sanchez, M., De La Rasilla, M., Delluc, B., Delluc, G., Feruglio, V., Floss, H., Foucher, P., Fritz, C., Fuentes, O., Garate, D., Gonzalez-Gomez, J., Gonzalez-Morales, M.R., González-Pumariega, M., Groenen, M., Jaubert, J., Martínez-Aguirre, M.A., Medina-Alcaide, M.A., Moro, O., Ontañón, R., Paillet-Man-Estier, E., Paillet, P., Petrognani, S., Pigeaud, R., Pinçon, G., Plassard, F., Ripoll, S., Rivero, O., Robert, E., Ruiz-Redondo, A., Ruiz Lopez, J.F., San Juan-Foucher, C., Sanchidrián, J.L., Sauvet, G., Simón-Vallejo, M.D., Tosello, G., Utrilla, P., Vialou, D. y Willis, M.D. (2020): "Still no archaeological evidence that Neanderthals created Iberian cave art", *Journal of Human Evolution*, 144, Article n° 102640, 1-7 <https://doi.org/10.1016/j.jhevol.2019.102640> (consultado el 30/10/2023).

Ignacio Triguero

Universidad de Alcalá

Retrouvez la version en ligne gratuite  
et ses contenus additionnels





# REINSCRIBING THE 3RD DIMENSION IN EPIGRAPHIC STUDIES AND TRANSCENDING DISCIPLINARY BOUNDARIES

*Angelos Barmpoutis, Eleni Bozia*

---

## INTRODUCTION

Over the past decade, archaeology and epigraphy have been reconsidering their *modus operandi*. Prompted and facilitated by technological advances, motivated by new research questions, and challenged by growing calls to engage with contemporary audiences, they have been experimenting with methodological approaches and interdisciplinary collaborations. Within this context, the Digital Epigraphy and Archaeology project (DEA) has been developing 3D digitization techniques that accommodate various types of artifacts, has been incorporating multidisciplinary approaches to achieve a more holistic stance towards the objects of study, and has focused on the reproducibility and accessibility of both its techniques and the 3D models.

The methods developed by the DEA project ([www.digitalepigraphy.org](http://www.digitalepigraphy.org)) have been widely adopted and used so far in several projects, including the digitization of the collection of squeezes from the Monumentum Ancyranum, a collection of Abraham Lincoln's Letters housed at the Library of Congress, collections of squeezes from Thasos housed at the University of Lyon 2, the Rosetta Stone at the British Museum, and several other projects that required different configuration of methods and accommodation of needs both in terms of the collections and the researchers.

This paper presents the DEA's introspective and reembodyed ways of preserving and studying the past by reconsidering historical artifacts and their digital re-materialization. The following sections discuss the project's approach to copies and digital copies, 3D digitization and enhanced visualization processes, comprehensive cloud services, and 3D printing to present the DEA steps toward facilitating and advancing archaeology and epigraphy. Through such approaches that combine traditional rigor with technological novelty and affordances, the team's vision is to popularize archaeology and epigraphy within and beyond academia and pinpoint the significance of the world's heritage to the new generations of students and the public.

## AUTHENTICITY AND AUTHENTICITY OF EXPERIENCE

### Appreciations of authenticity and the art of copying

Ancient Greco-Roman inscriptions were engraved on stones, temple walls, funerary monuments, and objects of everyday use. They documented life and death as part of life, events, and historical milestones. Since then, they have been a living record. The first archaeologists, anxious to save the fleetingness of history, copied them on sketchbooks and made copies of them on paper and latex (known as squeezes). Later, photography facilitated their work and preserved a copy of those vanished(-ing) worlds. Still, the written word is only accessible to a

few if it has not been destroyed altogether. So, giving access to this treasure trove of information will enable everyone to better understand the significance of archaeology and epigraphy for studying ancient societies.

Epigraphic squeezes, essentially being copies of the originals, may raise questions about their importance compared to the actual stone inscription. Still, their significance is undeniable, hence the need for their close study and preservation. Nonetheless, when we add to these considerations their 3D reproduction in the form of a digital squeeze, we need to address questions, such as: “Can the 3D model of the squeeze re-embody the real artifact, or is it a poor copy that cannot compare let alone rival the original?” And “What do we envision the impact of a 3D model to be when we move beyond its technological novelty?”

This section discusses authenticity as a concept and practicality in an attempt to create a framework for the appreciation of squeezes and digital squeezes. So, we begin with the fundamental question of how to determine authenticity. Below, we relay two diametrically opposing views on the subject—the debate resting on the monolithic and intransigent or the malleable and discursive.

**“The authenticity of a thing is the essence of all that is transmissible from its beginning, ranging from its substantive duration to its testimony to the history which it has experienced. Since the historical testimony rests on the authenticity, the former, too, is jeopardized by reproduction when substantive duration ceases to matter. And what is really jeopardized when the historical testimony is affected is the authenticity of the object.”** (Benjamin 2010)

**“Beyond the cult of the valuable object... the predominant element in these museums, much more than the object in itself, is the discourse – the logical sequence, the syllogistic chain, the reasoning process which each individual display and the overall script of the exhibition as a whole seek to expound.”** (Montaner 1990, 18-21)

The issue of copying is not new. Ancient Roman sculptors copied Greek originals. Are they any less valuable now? Do they have less to convey, or do they simply convey something else—different yet equally meaningful?<sup>1</sup> The debate regarding originality and imitation is not new. Aristotle and Plato were the first to consider imitation and its value. Aristotle (Aristot., *Poet.*, 1448b; *Rhet.* 1370a) thought it a worthy pursuit, an elevated action that validated the original and its creator. Plato (Plat., *Rep.*, 602d-603e; 605a-c) famously disagreed and relegated imitation to the realm of poorness of thought.<sup>2</sup> In literature, the period of the Second Sophistic was the time of reinventing the classical canon in an utterly innovative manner that encompassed imperial socio-cultural dynamics. Dionysius of Halicarnassus in *On Imitation* and Longinus in *On the Sublime* suggest sublimity through imitation and emulation. From the Roman perspective, Cicero suggests that Brutus imitates Cato but also improves on his work, changing the latter’s rougher words (*horridiora verba*, *Brut.* 68). And Quintilian considers imitation an intrinsic part of the learning process (*Inst.*, 2.2.8; 2.4.12). Similarly, scholarship tended to judge the imitative spirit of the Second Sophistic harshly, and it was not until relatively recently that scholars were able to appreciate the uniqueness of imitation, both as a purveyor of the original and an original on its own accord.<sup>3</sup>

1 See Anguissola, Anna “Greek Originals and Roman Copies”. In *obo* in Classics, <https://www.oxfordbibliographies.com/view/document/obo-9780195389661/obo-9780195389661-0213.xml> (accessed 19 Jan. 2023). See also Ridgeway (1984).

2 For a full discussion of *mimēsis* in Plato and Aristotle, see Ferrari 1989, 108-141, Halliwell 1989, 151-164, Vernant & Zeitlin 1991, 164-185.

3 van Groningen (1965) failed to appreciate the works of the Second Sophistic, and his views found proponents in the work of Bowersock (1969) and Perry (1955). On the other hand, De Jonge (2008), Swain (1996), Whitmarsh (2001), and others reappraised the creativity in the imitative practices of the period.

## The artifact

When it comes to material culture, one can understand the seminal significance of the artifact, its value, aura, material, and constructional details that a copy cannot match.<sup>4</sup> However, the situation is more complex when we consider the fragility of historical objects that limits their accessibility, their potential weathering or loss over time, or even the simple description of the field of archaeology as one of destruction—once the field is excavated, its originality is violated and ultimately destroyed.<sup>5</sup>

Beyond the perils of destruction, though, there are other parameters to consider. The goal of studying the past is to share this knowledge with younger generations and make it accessible to the global community. So, any effort to reproduce ancient art to make it approachable to students and the public is worth pursuing and retroactively again validates and reconfirms the importance of the field.

An example closer to our times and the discussion of artifacts and their accessibility is the Next Rembrandt Project (<https://www.nextrembrandt.com/>). A team of art scholars, museum experts, and computer scientists collaborated to train a computer in Rembrandt's techniques and mannerisms. Their goal was to create paintings resembling the master's handwork. The attempt has received mixed reviews, and one can understand both the excitement and the quibbles. Starting with the latter, reactions included apprehension at relegating the mastery of a genius to a soulless machine, endangering the creative process, and undermining the art world by insinuating copies that can very easily deceive.

"What a horrible, tasteless, insensitive and soulless travesty of all that is creative in human nature. What a vile product of our strange time when the best brains dedicate themselves to the stupidest 'challenges', when technology is used for things it should never be used for and everybody feels obliged to applaud the heartless results because so revere everything digital..." (Jones, *The Guardian* 2016)<sup>6</sup>

Conversely, individuals who are visually impaired and need to touch a piece of art to "see" it appreciated similar successful attempts to make the world's treasures touchable and approachable to more.<sup>7</sup> In such cases, the issue of accessibility takes a new meaning, as we are not debating the singularity of the artifact and the hubris of technological advances. Instead, we are faced with the reality that archaeology and epigraphy exclude a number of people whose only chance to "see" the artifacts is via their copies.<sup>8</sup>

"This blind man, an old friend of my wife's, he was on his way to spend the night...Something about the church and the Middle Ages was on the TV...the TV showed this one cathedral... Then something occurred to me and I said: 'Do you have any idea what a Cathedral is?'... 'Cathedrals' the blind man said... 'If you want the truth, bub, that's about all I know...But maybe you could describe one to me?'" (Carver 1989, 209, 222-224)

4 For a detailed discussion of authenticity in digital epigraphy, see Bozia 2018.

5 See Meskell (2018) for a thorough discussion on the significance of and perils threatening world heritage as well as the history of organizations working towards its protection. See also Elia 1997.

6 <https://www.theguardian.com/artanddesign/jonathanjonesblog/2016/apr/06/digital-rembrandt-mock-art-fools> (accessed January 30, 2023).

7 <https://www.businessinsider.com/3d-printed-works-of-art-for-the-blind-2016-1> (accessed January 30, 2023).

8 See Rossetti *et al.* (2018a, b) who detail their use of 3D models to increase the accessibility of architectural details for the visually impaired. See also Montusiewicz *et al.* 2022, Themistocleous *et al.* 2016.

Therefore, it is evident that reproducibility and its effect on the perception of authenticity are more complex than simply assigning polarizing black-and-white terms. We could argue that the value of any artifact and its historical significance only increases when it becomes a shared world heritage object valued by many. Working within this new mental and research framework, instead of scholars monopolizing the fields and subsequently struggling to explain their significance, archaeology and epigraphy can become a matter of public interest and concern.

## DIGITAL EPIGRAPHY: A NEW VERSION OF EPIGRAPHY AS A NEWFOUND RE-EMBODIMENT

### Squeeze and digital squeeze: an approved copy and its copy

Squeezes have always answered the call for preservation, dissemination, and tactility of inscriptions, as those involved found a way to re-embodiment the inscribed text and carry it with them. Also, as inscriptions undergo an expected level of wear and tear in addition to cases when dramatic changes in the geopolitical landscape jeopardize their existence, squeezes can be elevated into the only reliable and remaining descendants of the stone inscriptions. To that effect, Meskell very astutely observes:

“This trend of increasing heritage destruction uncomfortably suggests that there is something specific about the World Heritage stamp that has rendered sites valuable targets. Their imputed protected legal status under international treaties, the resources channeled to them, their visibility and symbolic value as the purported ‘heritage of humanity,’ and the outrage of the international community at their targeting have attracted new modalities of danger.” (Meskell 2018, 192)

With this in view, the DEA project focuses on the 3D digitization, preservation, accessibility, and dissemination of the squeeze in the form of a digital squeeze. The team has designed novel algorithms that can capture the 3D information contained on the surface of an epigraphic squeeze, using a minimal setup that utilizes accessible technologies, such as regular flatbed office scanners or digital cameras. Such a setup makes the digitization process affordable and practical for epigraphists and archaeologists to use and integrate within their existing workflow. Furthermore, the use of modern web technologies facilitates the storage and dissemination of the 3D digital squeezes on the cloud without additional software requirements or technical expertise from the end users who can easily access and seamlessly study the inscriptions from mainstream devices like computers, tablets, and smartphones.

## The Digital Epigraphy and Archaeology Project

Specifically, the DEA project provides novel and technologically advanced scientific tools for the effective study and comparative analysis of inscriptions and other artifacts. It provides archaeologists and epigraphists with cost-effective and efficient methods for 3D digitization and options for enhanced visualizations and further automatic analyses.

The most popular and widely used DEA technology is the shape-from-shading (SFS) tool, which provides a framework to digitize squeezes with the use of an office scanner. The SFS tool runs as a web application focusing on digitizing, 3D visualization, data mining, and electronic dissemination of artifacts. The tridimensional digitization is achieved through the bidirectional scanning of the squeeze using a typical 2D office scanner. The scanned images are then processed by the SFS algorithm, which analyses the depicted shading in the images and captures in 3D the surface of the scanned squeeze. The advantages are numerous: 1) The process requires no expensive equipment. 2) The squeeze can be safely preserved in a digitized form, thus eliminating the possibility of deterioration of the squeezed paper. 3) The squeezes can also be distributed electronically, facilitating epigraphic studies. 4) Finally, the digital squeezes can be more effectively visualized compared to the 2D images, as they can be viewed from different angles and under different artificial lighting conditions.

The first version of the SFS tool was released to the public in 2012<sup>9</sup> with generous support from a start-up grant from the US National Endowment for the Humanities.<sup>10</sup> The toolbox was implemented in Java as a software application that could be downloaded and run on any computer with Java Runtime Environment installed. The software could process images of scanned squeezes, reconstruct the 3D model of the squeeze, and instantly upload it to the [digitalepigraphy.org](http://digitalepigraphy.org) server for web-based visualization and dissemination. Many research universities adopted the SFS tool to facilitate their squeeze digitization projects, such as Cornell University for the digitization of the squeezes from the Monumentum Ancyranum,<sup>11</sup> the University of Lyon 2 for the digitization of the squeezes from the HiSoMA laboratory,<sup>12</sup> and the digitization of the squeezes from the Ca' Foscari University of Venice,<sup>13</sup> among others. The total volume of tens of thousands of 3D digitized squeezes produced by these projects familiarized the epigraphic community with the newly formed concept of the digital squeeze and its advantages, as well as the best practices for digitizing and organizing them into databases.

### The Digital Squeeze

To define the concept of the digital squeeze, we first need to identify the characteristics of the traditional epigraphic squeezes that need to be maintained in the digital form and then pinpoint which additional features can be added to enhance their use. An epigraphic squeeze can accurately document the details of a flat inscribed surface in the form of an embossed paper replica of the original surface. Creating a squeeze requires only paper material; therefore, it is cost-effective and easy to handle (acquire, prepare, process, carry, and store). However,

9 Barmpoutis 2013.

10 Grant HD-51214-11 for the Digital Epigraphy Toolbox. Office of Digital Humanities, National Endowment for the Humanities <https://securegrants.neh.gov/publicquery/main.aspx?f=1&gn=HD-51214-11> (accessed January 30, 2023).

11 Bozia 2018.

12 Levivier 2016.

13 Antonetti 2017.

despite the many advantages of the usability and ease of use of squeezes, there are also many limitations. Due to the flat nature of the paper, squeezes cannot easily capture non-flat objects, such as round surfaces, or multiple sides of a larger object at once. Furthermore, the size of the squeeze is limited by the size of the paper, which may be smaller than the size of the raw inscription, and in such cases, multiple squeezes are required to capture the entire surface. Finally, although squeezes can be easily stored and carried as rolls, the soft nature of the material makes them rather sensitive to pressure and other environmental conditions, such as humidity or dryness. As a result, the embossed details may be flattened over time, and the paper itself can deteriorate.

When comparing the paper squeeze with the digital and considering the latter's possibilities, our team maintains that the digital equivalent of an epigraphic squeeze should be at least of the same quality or even superior, in terms of captured details, compared to the paper squeeze. Acquiring a digital squeeze must also be as easy and affordable as the traditional process. Also, the data need to be readily captured and processed within a few minutes and easily viewed, copied, and transferred. In terms of the current technology, this is translated to a sampling distance of at most 170  $\mu\text{m}$  or spatial resolution of at least 150 DPI, which is equivalent to a squeeze of size 67.7 cm  $\times$  50.8 cm (an area covered by 5.5 A4 pages) captured with a conventional 12 Megapixel digital camera sensor (4000  $\times$  3000 pixels). The same camera can be used to digitize smaller inscriptions (33.8 cm  $\times$  25.4 cm, an area slightly larger than an A4 page) at even higher resolutions (85  $\mu\text{m}$ , 300 DPI). The camera resolution of modern smartphones exceeds the above specifications, making image-based techniques such as SFS accessible and cost-effective in terms of technological requirements. Obviously, the use of higher resolution camera sensors such as 48 Megapixels (iPhone 14 Pro) allows for even smaller sampling distance (85  $\mu\text{m}$  instead of 170  $\mu\text{m}$ ) or larger digitized surfaces, which in this case is equivalent to a squeeze of size 135.4 cm  $\times$  101.6 cm or an area covered by 22 A4 pages.

Furthermore, the ease of use and handling of a digital squeeze must be at least comparable to the convenience of a traditional paper squeeze, which in the digital case, is translated to small file sizes and convenient file formats. Based on the resolutions above, a photograph taken by a 12 MP camera can be stored in a file of size 3.6 MB using JPEG format at 100% quality compression, and in the case of a 48 MP camera, the size is 14.4 MB. The SFS algorithm requires 2 or 4 photos of the inscription or the paper squeeze taken from the same point of view under different lighting orientations.<sup>14</sup> The result of the 3D digitization process is a depth map and an orientation map (also known as a normal map),<sup>15</sup> which are images of the same size as the original photographs. These renderings capture the 3D information contained in the depicted artifact in a way similar to how a paper squeeze captures the details of a raw inscription. So, even if we account for the size of all input and output files together, the size of a 3D digital squeeze in terms of digital storage is equivalent to the size of 6 pictures at the most, which is about 20 MB, in the most typical scenario. Files of this size can be easily stored in low-cost digital storage or conveniently transferred over the internet. For example, a low-cost 128 GB USB thumb drive can store more than 6000 3D digital squeezes, and an internet connection with downloading speed of 300 Mbps can transfer a 3D squeeze at about half a second, which is fast enough for real-time browsing through an extensive collection of digital squeezes. The above numbers clearly demonstrate that, from many aspects, the ease of use of a digital squeeze is at least comparable to the convenience of a traditional paper squeeze.

However, a digital squeeze has many additional advantages that make it significantly superior to the paper one. First, the 3D details of a digital squeeze cannot deteriorate over

14 Barmpoutis *et al.* 2010.

15 For the depth map and the normals, see, in this volume, Comte & González Bordas, 19 and 16, n. 25 respectively.

time and can be easily stored in a minimal digital medium without requiring sizeable physical storage space. The digital squeeze can be viewed and studied conveniently, such as on a tablet computer, and interactively relit by reorienting the tablet with respect to a virtual light source.<sup>16</sup> Furthermore, it can be visualized with different shading schemes to highlight various geometric features of the inscribed surface.<sup>17</sup> The depth map and the edge map are two examples of such visualizations that can be used to better present the inscribed content compared to a regular photograph of the original object. Therefore, a digital squeeze can also be used to produce better illustrations for scholarly publications in the fields of epigraphy and archaeology. Finally, one crucial characteristic of the digital squeezes is that they can capture both raw inscriptions and paper squeezes because the method can be seamlessly applied to photographs of raw inscribed objects as well as paper squeezes. Therefore, digital squeezes can be used for the digital preservation of both types of artifacts in addition to many others, such as paper embossments, seals, casts of coins, and other flat inscribed or embossed surfaces.

The above discussion and observations have clearly defined the concept of the digital squeeze and formed our expectations about its affordances, which our team took under consideration when developing the most recent release of our digitization software.

### Shape-from-shading software as a publicly available cloud service

In 2022, 10 years after the release of the first version of the SFS toolbox and after accumulating a decade-long experience in 3D digitization of a large variety of artifacts of different sizes, materials, and conditions, we released a cloud-based version of the algorithm that significantly improves the digitization process, the dissemination of the digital squeezes, and the overall user experience (**fig. 1**). One of the key improvements is that the application is available across devices through a web browser and without the need to install additional software, a significant advantage over the previous version of the software. Furthermore, the users have access to cloud storage provided by the University of Florida,<sup>18</sup> which is integrated with the SFS toolbox, to store the digital squeezes and organize them into collections. To access the cloud service, the users can log in with institutional or personal accounts through third-party authentication providers using state-of-the-art information technology protocols, such as the reliable JSON Web Token (JWT) exchange mechanism. Users from universities and research institutes that utilize such services can automatically login with their institutional email accounts through a single sign-on (SSO) protocol without the need to create separate accounts for this software. Once they log in, the users can organize their digitization projects in collections or batches of digital squeezes through cloud folders, similarly to how paper squeezes are cataloged and organized in physical storage. The software guides the users through the process of creating a digital squeeze, which involves three steps: 1) uploading the images of the artifact, 2) aligning the images, and 3) running the SFS algorithm.

The input images can be either photographs taken from a stationary camera or images acquired from a flatbed scanner, depending on the type and size of the artifact. For example, smaller objects, such as paper squeezes, and casts of coins can be easily placed on a typical office scanner and scanned 2 or 4 times by rotating them 90 degrees between the scans. This process produces images of the same artifact under different lighting directions. The shading differences

16 Barmpoutis & Bozia 2017.

17 Gallen *et al.* 2015.

18 Our open-source software can also be installed within the web infrastructure of other institutions in order to accommodate local or national mandates related to digital data sovereignty.

between these images capture the fine tridimensional details analyzed by the SFS algorithm to produce the 3D digital squeeze. A similar process can be followed for larger objects, such as raw inscriptions, using a fixed camera and a portable light source to illuminate the object from the top, bottom, left, and right to take the respective 4 pictures. After uploading the images and identifying the corresponding lighting directions, the user can align them with a manual registration process and finally perform the 3D reconstruction by running the SFS algorithm.

The produced digital squeeze is saved on the cloud and linked to its input images, the reconstructed depth map, the normal map, and their associated metadata (**fig. 2**). This comprehensive record of the digital squeeze allows reproducibility, an essential component of the modern research process that enables other scholars to repeat or even improve the 3D reconstruction results in the future. Another benefit of this integrated cloud record is that it can be viewed with different visualizations that combine the original image data and the 3D reconstructed surface. Our software provides a web-based 3D viewer that contains several options for manipulating and visualizing the digital squeeze, such as the depth map, a grey-scale visualization that highlights the deeper inscribed areas of the surface, and the edge map that highlights the curvature of the surface (**fig. 3**). The contrast between the brighter and darker areas in these maps gives better readings of the inscribed surface by intensifying the shape of the inscribed letters.

Finally, given the multitude of electronic devices available and the need to accommodate different audiences and users with varying needs, use-case scenarios, skillsets, and financial means, our team has devoted significant efforts so that the SFS toolbox and the 3D viewer can run on any mainstream web browser and a plethora of devices, including desktop computers, tablets, and smartphones. These devices can easily access a digital squeeze or collection of squeezes through a unique URL generated for each squeeze, which can be shared with others, can be embedded in online databases and curatorial software, or even disseminated through social platforms and learning management systems.

### COPY VS. ORIGINAL: HOW A COPY VERIFIES THE ORIGINAL

This section presents two case studies that demonstrate the process of making digital squeezes from a raw inscription and a paper squeeze.

An interesting case study is that of the Rosetta Stone housed at the British Museum. Undeniably one of the most famous artifacts, yet understandably so untouchable and over the past several decades unreadable in many parts. Our team successfully produced a high-resolution 3D digital squeeze based on photographs we took using 4 different lighting directions. We then processed it with our SFS algorithm, increasing its legibility and advancing the dissemination of its contents.<sup>19</sup>

The Digital Rosetta Stone project is a collaboration between the University of Leipzig, the Saxon Academy of Sciences and Humanities, the British Museum, and the University of Florida. For the 3D digitization, we extended the DEA's previous methods to accommodate an artifact of this material, size, and placement by taking a series of photographs under controlled lighting and processing them to produce the first 3D digital squeeze in such high resolution and publish it as an open access resource.<sup>20</sup> In our setup, we fixed a DSLR camera (Nikon D3400) on a tripod

19 Amin *et al.* 2023.

20 Amin *et al.* 2018.



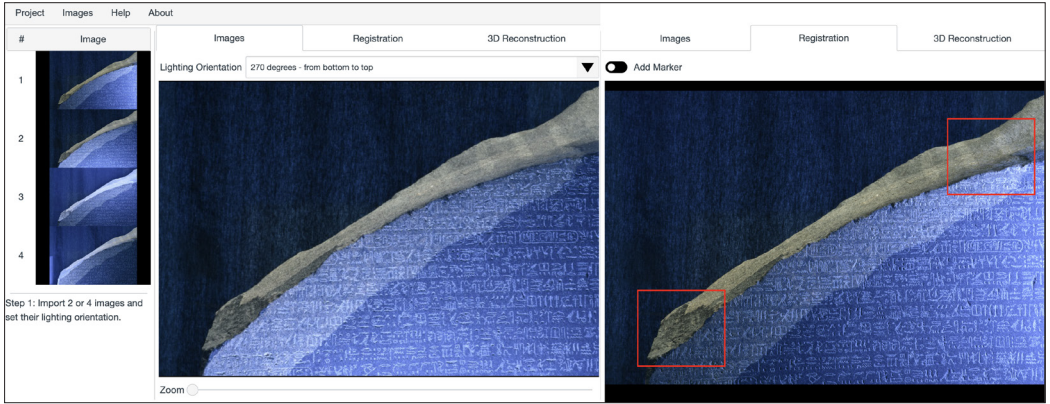

Fig. 1. An example of input images in the SFS digitization tool. Left: 4 input images from the Rosetta Stone with different lighting directions. Right: The images can be manually aligned with each other if necessary, using custom markers shown here as red squares.

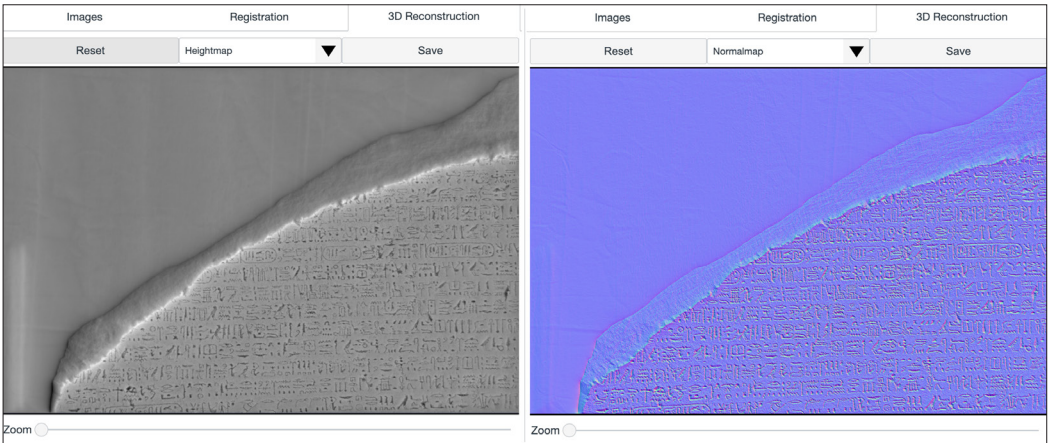

Fig. 2. An example of the output of the SFS algorithm. The deeper inscribed points appear darker in the depth map (left). The normal map (right) shows the curvature of the inscribed surface.

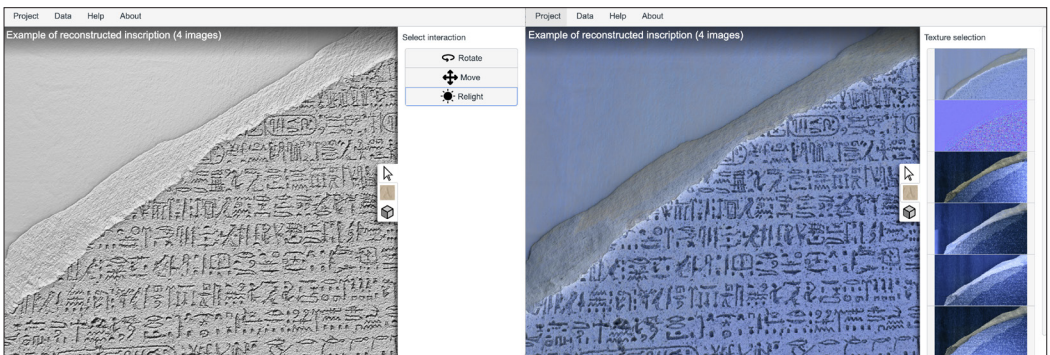

Fig. 3. Our web viewer shows an example of the 3D digital squeeze from the Rosetta Stone. Left: The digital squeeze can be interactively relit by the user. Right: Different visualization options can help scholars study the digital squeeze better.

in front of the inscription. We used a hand-held lightsaber-type light source to illuminate the inscription from the top, bottom, left, and right to take photographs under 4 different lighting directions. By extending our algorithm to handle 4 lighting directions instead of 2, which was the requirement in the previous version, it can better separate the chromatic information from the structural information and handle non-uniform lighting distribution caused by the manual handling of the light source.

To assess the quality of the produced 3D digital squeeze, we identified several publicly available photographs and 3D models of the Rosetta Stone, which we use here as a benchmark. **Fig. 4** shows a visual comparison of our digital squeeze with two 3D models of the Rosetta Stone by Jon Beck<sup>21</sup> and the British Museum.<sup>22</sup> To the best of our knowledge, these were the only publicly available 3D models of the Rosetta Stone at the time of publication. The 3D digital squeeze produced from our SFS tool demonstrates sharper details that significantly improve the legibility of the inscription compared to the other 3D models. Furthermore, we used as additional benchmarks two readable, high-contrast photographs of the inscription by the Wikipedia article on the Rosetta Stone<sup>23</sup> and the British Museum online collection,<sup>24</sup> both commonly referenced online resources on the artifact. **Fig. 5** compares the depth map of our digital squeeze with these benchmarks. Based on this comparison, it is evident that the clarity and detail of the depth map<sup>25</sup> are superior to the other images, and it is further demonstrated in **fig. 6** by a side-by-side comparison of symbol 39, in line 11 of plate 6 (Sharpe 1871). The comparison also includes the hand-drawn illustration by Samuel Sharpe,<sup>26</sup> which we consider here as the expert's benchmark. From a simple observation, it is evident that the depth map of our digital squeeze closely resembles the original illustration, and the amount of detail captured in our digital squeeze exceeds the quality of the other images.

In sum, our goal was to create a visually enhanced 3D model of an artifact that is challenging in its physical positionality and readability and offer the scholars and the public enhanced engagement opportunities. Furthermore, such an attempt showcases the (re)constructive power of technological advances and the educational and research potential that such an integrated project can yield.

Finally, another case study showcasing our SFS method's use is the 3D digitization of the squeezes from the *Monumentum Ancyranum* in collaboration with Cornell University. This collection contains squeezes from the expedition that the university had launched to Asia Minor and the Assyro-Babylonian Orient in 1907-1908. At the beginning of the expedition, team members spent two weeks creating squeezes of the *Res Gestae* of the emperor Augustus inscribed on the walls of the *Monumentum Ancyranum*. The squeezes traveled back to Cornell and have been housed there ever since, weathered by environmental conditions, humidity, dryness, and tear. The squeezes are large (greater than 1 meter in length) and, therefore, cannot be easily scanned on a typical flatbed office scanner. For this project, we used the scanner Super6k manufactured by Better Light, which is ideal for larger scanning jobs like this. The scanning process was repeated 4 times using an external light source on the top, bottom, left, and right side of the squeeze, respectively.

21 3D Model of the Rosetta Stone by Jon Beck <https://www.myminifactory.com/object/3d-print-rosetta-stone-at-the-british-museum-london-4537> (accessed January 30, 2023).

22 3D Model of the Rosetta Stone by the British Museum <https://sketchfab.com/3d-models/the-rosetta-stone-1e03509704a3490e99a173e53b93e282> (accessed January 30, 2023).

23 High-contrast readable photograph of the Rosetta Stone. Attributed to the European Space Agency [https://upload.wikimedia.org/wikipedia/commons/c/ca/Rosetta\\_Stone\\_BW.jpeg](https://upload.wikimedia.org/wikipedia/commons/c/ca/Rosetta_Stone_BW.jpeg) (accessed January 30, 2023).

24 <https://www.britishmuseum.org/collection/image/6109003> (accessed January 30, 2023).

25 Amin *et al.* 2018.

26 Sharpe 1871.

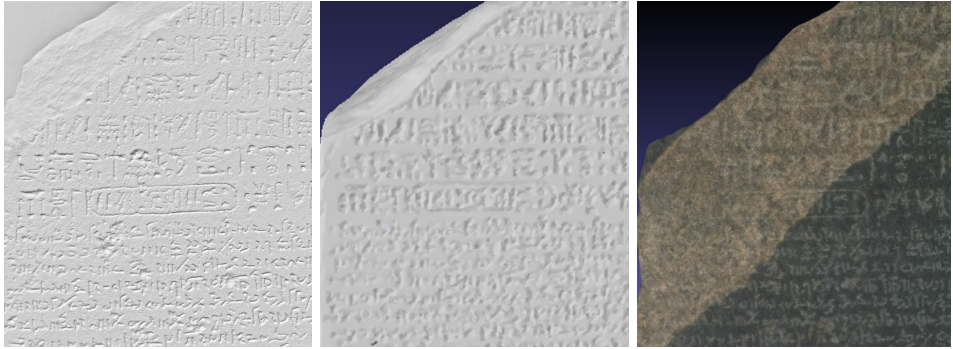

Fig. 4. Visual comparison of our 3D digital squeeze with other publicly available 3D models of the Rosetta Stone. Left: The 3D digital squeeze produced from our SFS tool in 2018. Middle: The 3D model created by Jon Beck in 2015. Right: The 3D model published by the British Museum in 2016.



Fig. 5. Visual comparison of the depth map of our digital squeeze with publicly available photographs of the Rosetta Stone. Left: Part of the image from Wikipedia/Wikimedia Commons. Middle: Part of the photograph from the British Museum. Right: The depth map produced from our SFS tool (Amin et al. 2018).

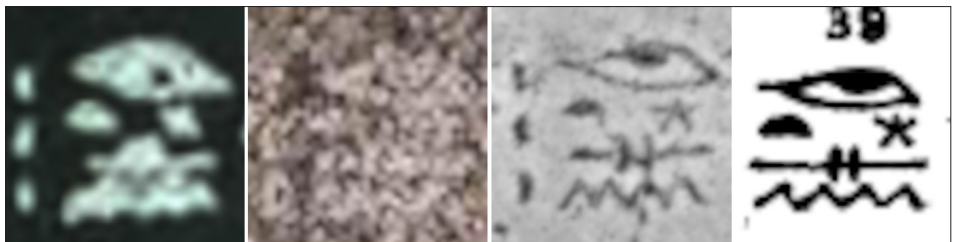

Fig. 6. Side-by-side comparison of a detail from the Rosetta Stone (Plate 6, Line 11, Symbol 39, Sharpe 1871). From left to right: image from Wikipedia/Wikimedia Commons, photograph from the British Museum, the depth map of our digital squeeze, drawing by Samuel Sharpe, 1871.

One of the scanned photographs from the collection of the digitized squeezes is shown in **fig. 7**. The squeeze is from the Greek Column 18, lines 17-24 of the *Res Gestae Divi Augusti* inscription. The size of the squeeze is 111.13 cm×53.18 cm and was scanned at 162 DPI, producing images of size 7088 px×3392 px. The 3D digital squeeze produced by our SFS tool is shown in **fig. 8**. **Fig. 9** shows the edge map visualization of the digital squeeze, highlighting the inscribed edges.

## MAKING THE TANGIBLE INTANGIBLE AND VICE VERSA: 3D PRINTING AND AUGMENTED REALITY

Thus far, the discussion has focused on the need to advance the opportunities for enhanced interaction with squeezes and the affordances of digital copies. However, another equally important aspect of tangibility is the physicality of the artifact, or its copy, for that matter. So, how does a digital initiative that advocates for more accessibility can contribute to that?

Our project works with 3D printing, essentially rematerializing the digital file into a tangible copy of the inscription in an attempt to physically re-embody the inscriptions and provide students and researchers with more meaningful experiences that materialize tactility. Additionally, we employ augmented reality devices that can virtually bring the artifacts into one's workspace. Such an opportunity enhances the research and pedagogical experiences, as the user can "see" and interact with the artifacts in their own "physical" space.<sup>27</sup>

Experiential learning and its contribution to pedagogy is a well-studied research area (Alibali & Nathan 2009; Eisenberg & Pares 2014, 344-8; Goldin-Meadow 1999). Also, several studies have explored the significance of embodiment to learning (Abrahamson & Lindgren 2014; Eisenberg & Pares 2014, 347-8; Goldin-Meadow 2009). Additionally, mixed-reality environments have been shown to enrich educational experiences, leading to better learning outcomes (Lindgren & Johnson-Glenberg 2013).

Within this framework of a reembody pedagogy, the DEA project works toward the re-physicalization of the digital copy through 3D printing. In this case, utilizing the advantages of the digital squeeze and the unique way it preserves the original stone inscription, we are bringing it back to human hands as an object that can now be touched and studied safely and anew. These new 3D-printed models are new objects that can assist more people in realizing the authenticity of the originals, as they afford accessibility that may lead to closer study and scrutiny of details, physical contact that is otherwise prohibitive, and the ability to provide new experiences to people. Our hope is that by re-incorporating inscriptions in a tangible form into our research, teaching, and everyday life, we will engage new audiences and animate new authentic user experiences.

To this end, our team works with the Marston Science Libraries at the University of Florida, which uses Fusion F400s, F306s, Lulzbot Taz6, and Ultimaker 3 Extended 3D printers. The printers also offer options for different materials, such as ceramics and metal. The digital squeeze is imported into the 3D model software and printed as an object. This "new artifact" preserves the information that the digital squeeze holds but can be touched, read closely, and consequently bring more unique and authentic experiences to the student and the scholar, beyond what a 2D image or even a digital copy can effect.<sup>28</sup>

27 On tactility and re-embodiment both as theories and in archaeological practice, see Bozia 2023.

28 See Ford & Minshall (2019) and Pearson & Dubé (2022) who discuss 3D printing as an educational technology. Also, Neely and Langer (2013) present the contributions of 3D printing to the engagement with and embodiment and understanding of the artifact to enhance museum experiences.

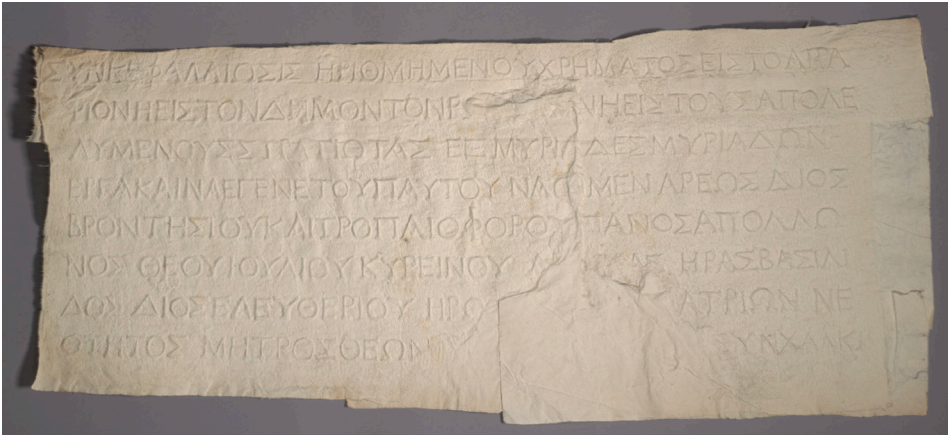

Fig. 7. One of the four scans of the squeeze with accession number MA.G.18.17.24 from Cornell University. Greek Column 18; Lines 17-24 of the Res Gestae Divi Augusti inscription from Monumentum Ancyranum.

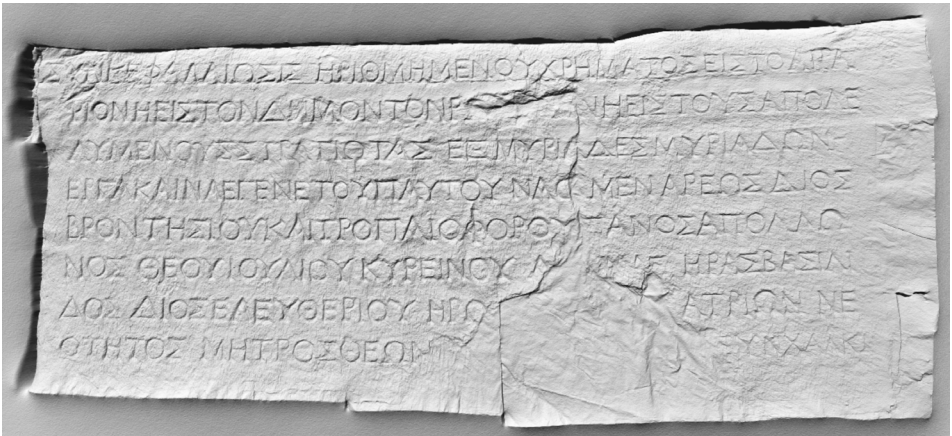

Fig. 8. Visualization of the 3D digital squeeze with interactive relighting.

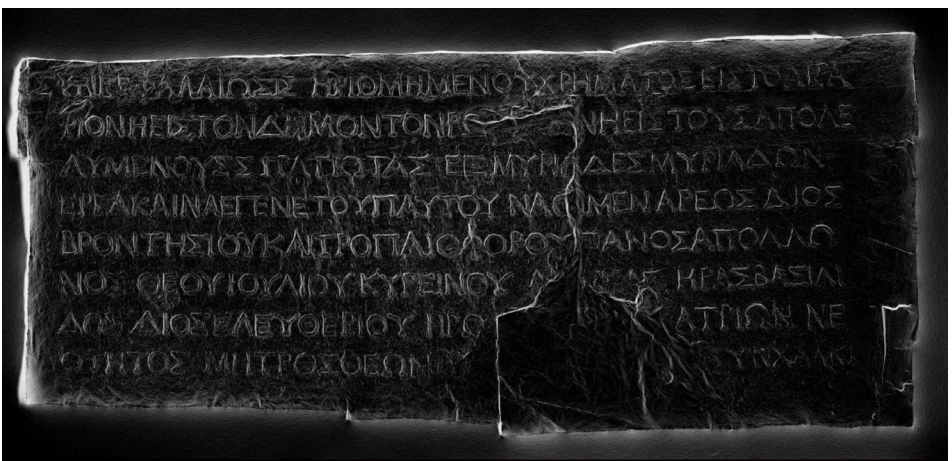

Fig. 9. Edge map visualization of the 3D digital squeeze to highlight the inscribed edges.

Finally, within this scope, our project has begun utilizing virtual and augmented reality head-mounted displays, such as Meta Quest and Microsoft's HoloLens headsets. The interface allows the users to browse through 3D databases of artifacts and visualize them within their actual physical space. Such uses of the available technology do not interfere with the integrity of the field of study or undermine scholarly rigor. *Au contraire*, scholars and students showcase the evolution of the discipline and enhance their research. Standardizing technologies for extended reality, such as openXR and webXR, has enabled immersive visualizations within web applications such as our web 3D viewer. Visualizing a 3D digital squeeze in virtual and augmented reality allows the users to naturally interact with them within their physical space and perform various tasks intuitively.

Digitization, 3D printing, and augmented reality that allow for virtual reconstructions of ancient sites and artifacts do not simply reignite the public's interest but also allow every new generation to develop personal connections with the artifacts and contribute to their study and understanding, henceforth to their preservation. The DEA project aims to preserve squeezes and other historical artifacts and envisions democratizing their use. We believe that our methodologies, approaches, and worldview will result in the appreciation of world heritage, not as a mandate for the few but as an exigency for everyone. Ultimately, we hope to turn the concept of world heritage into one world heritage and our heritage.

## CONCLUSION

In closing, the overall mission of the DEA is to fulfill the potential to further a diverse audience's understanding of historically significant inscribed texts and promote new modes of research and teaching that embrace the multidimensionality of ancient artifacts. Such approaches will help to contemporize the discipline, engage a multidisciplinary scholarly audience, and hopefully serve the interests of communities around the world. In *The Library at Night*, Albert Manguel said:

"We can roam the bloated stacks of the Library of Alexandria, where all imagination and knowledge are assembled; we can recognize in its destruction the warning that all we gather will be lost, but also that much of it can be collected again; we can learn from its splendid ambition that what was one man's experience can become, through the alchemy of words, the experience of all, and how that experience, distilled once again into words, can serve each singular reader for some secret, singular purpose." (p. 33)

Creativity filtered through and assisted by technology should have an impact on the historical record. World heritage, both in terms of artifacts and texts, is not only a concern, prerogative, or object of study for epigraphists, archaeologists, historians, humanists, and artists. It should be an integral part of the human experience; it should be re-studied, re-lived, and re-experienced so that it may preserve the past, better the present, and guarantee the future. Digital preservation projects can enrich arts and humanities research and move them beyond the academic sphere in an attempt to: quoting UNESCO, "maintain, increase, and diffuse knowledge by assuring the conservation and protection of the world's heritage."<sup>29</sup>

29 <https://whc.unesco.org/en/conventiontext/> (accessed January 30, 2023).

## REFERENCES

- Abrahamson, D. and Lindgren, R. (2014): "Embodiment and embodied design", in: Sawyer, ed. 2014, 358-376.
- Alibali, M. W. and Mitchell, J. N. (2009): "Teachers' gestures as a means of scaffolding students' understanding: Evidence from an early algebra lesson", in: Goldman, R., Pea, R., Barron, B., and Derry, S. J. ed.: *Video Research in the Learning Sciences*, New York, 349-365.
- Amin, M., Barmpoutis, A., Berti, M., Bozia, E., Hensel, J. and Naether, R. (2018): "Depth map of the Rosetta Stone", *Humanities Commons*, 1-1 <http://dx.doi.org/10.17613/t1e2-0w02> (accessed October 31, 2023).
- Amin, M., Barmpoutis, A., Berti, M., Bozia, E., Hensel, J. and Naether, F. (2023): "The Digital Rosetta Stone Project", in: Lucarelli, R., Roberson, J. A. and Vinson, S. ed.: *Ancient Egypt, New Technology: The Present and Future of Computer Visualization, Virtual Reality and other Digital Humanities*, Harvard Egyptological Studies 17, Leiden-Boston, 58-84.
- Antonetti, C., Matijašič, I., De Vido, S. and Mignosa, V. (2017) : "Digital Epigraphy at the Greek Epigraphy Laboratory, Ca' Foscari University of Venice", *Historika*, 7, 491-502.
- Barmpoutis, A., Bozia, E. and Wagman, R. (2010): "A novel framework for 3D reconstruction and analysis of ancient inscriptions", *Journal of Machine Vision and Applications*, 2, 6, 989-998.
- Barmpoutis, A. (2013): "Digital Epigraphy Toolbox", *Humanities Commons*, 1-11 <http://dx.doi.org/10.17613/M64W9R> (accessed October 31, 2023).
- Barmpoutis, A. and Bozia, E. (2017): "Augmenting the Workspace of Epigraphists. An interaction design study", in: Orlandi, S., Santucci, R., Mambrini, F. et Liuzzo, P., ed.: *Digital and Traditional Epigraphy in Context: Proceedings of the EAGLE 2016 Conference*, Collana Convegni 36, 209-220.
- Benjamin, W. (2010): "The Work of Art in the Age of Mechanical Reproduction", in: Gale, M., Deeney, J. and Rebellato, D. ed.: *Routledge Drama Anthology and Sourcebook*, London, 445-468.
- Bozia, E. (2018): "Ektypa and 3D models of ektypa: the reality(ies) of a digital object", in: Di Giuseppantonio Di Franco, P., Galeazzi, F. and Vassallo, V. ed.: *Authenticity and cultural heritage in the age of 3D digital reproductions*, Cambridge, 97-110.
- Bozia, E. (2023): "'Please, touch the exhibits': 3D archaeology for experiential spatialization", in: Landeschi, G. and Betts, E. ed.: *Capturing the Senses, Digital Methods for Sensory Archaeologies*, New York.
- Carver, E. (1989): *Cathedral*, New York.
- De Jonge, C.C. (2008): *Between Grammar and Rhetoric*, Leiden-Boston.
- Eisenberg, M. and Pares, N. (2014): "Tangible and full-body interfaces in learning", in: Sawyer, ed. 2014, 339-357.
- Elia, R.J. (1997): "Looting, collecting, and the destruction of archaeological resources", *Nonrenewable Resources*, 6, 85-98.
- Ferrari, G.R.F. (1989): "Plato and Poetry", in: Kennedy, ed. 1989, 92-148.
- Ford, S. and Minshall, T. (2019): "Where and how 3D printing is used in teaching and education", *Additive Manufacturing*, 25, 131-150.
- Gallen, R., Eastop, D., Bozia, E. and Barmpoutis, A. (2015): "Digital imaging: the application of shape-from-shading to lace, seals and metal object", *ICON Journal of Conservation*, 38, 1, 41-53.
- Goldin-Meadow, S. (1999): "The role of gesture in communication and thinking", *Trends in cognitive sciences*, 3, 11, 419-429.
- Goldin-Meadow, S. (2009): "How gesture promotes learning throughout childhood", *Child Development Perspectives*, 3, 106-111.
- Halliwell, S. (1989): "Aristotle's Poetics", in: Kennedy, ed. 1989, 149-183.
- Kennedy, G., ed. (1989): *The Cambridge History of Literary Criticism*, Cambridge.
- Levivier, A., Leblanc, E. and Brunet, M. (2016): "E-STAMPAGES: archivage et publication en ligne d'une ectypothèque d'inscriptions grecques", *Les nouvelles de l'archéologie*, 145, 24-27 <https://journals.openedition.org/nda/3801> (accessed October 31, 2023).
- Lindgren, R. and Johnson-Glenberg, M. (2013): "Emboldened by embodiment: Six precepts for research on embodied learning and mixed reality", *Educational Researcher*, 42, 8, 445-452.

- Manguel, A. (2009): *The Library At Night*, Yale-New Haven.
- Meskel, L. (2018): *A Future in Ruins: UNESCO, World Heritage, and the Dream of Peace*, Oxford.
- Montaner, J.M. (1990): *New Museums*, London.
- Montusiewicz, J., Barszcz, M. and Korga, S. (2022): "Preparation of 3D Models of Cultural Heritage Objects to Be Recognised by Touch by the Blind—Case Studies", *Applied Sciences*, 12, 23, 11910.
- Neely, L. and Langer, M. (2013): "Please feel the museum: The emergence of 3D printing and scanning", in: Proctor, N. and Cherry, R. ed.: *Museums and the Web*, Sliver Spring <https://mw2013.museumsandtheweb.com/paper/please-feel-the-museum-the-emergence-of-3d-printing-and-scanning/> (accessed October 31, 2023).
- Pearson, H.A. and Dubé, A.K. (2022): "3D printing as an educational technology: theoretical perspectives, learning outcomes, and recommendations for practice", *Educ Inf Technol*, 27, 3037-3064.
- Ridgeway, B.S. (1984): *Roman Copies of Greek Sculptor*, Michigan.
- Rossetti, V., Furfari, F., Leporini, B., Pelagatti, S. and Quartam, A. (2018a): "Enabling Access to Cultural Heritage for the visually impaired: an Interactive 3D model of a Cultural Site", *Procedia Computer Science*, 130, 383-391.
- Rossetti, V., Furfari, F., Leporini, B., Pelagatti, S. and Quarta, A. (2018b): "Smart Cultural Site: an Interactive 3d Model Accessible to People with Visual Impairment", *IOP Conf. Ser.: Mater. Sci. Eng.*, 364, 12-19.
- Sawyer, R., ed. (2014): *The Cambridge handbook of the learning sciences*, Cambridge.
- Sharpe, S. (1871): *The Rosetta Stone, in Hieroglyphics and Greek; with Translations, and an Explanation of the Hieroglyphical Characters; and followed by an Appendix of Kings' Names*, London.
- Swain, S. (1996): *Hellenism and Empire*, Oxford.
- Themistocleous, K., Agapiou, A. and Hadjimitsis, D. (2016): "Experiencing Cultural Heritage Sites Using 3D Modeling for the Visually Impaired", in: Ioannides, M., Fink, E., Moropoulou, A., Hagedorn-Saupe, M., Fresa, A., Liestøl, G., Rajcic, V. and Grussenmeyer, P. ed.: *Digital Heritage. Progress in Cultural Heritage: Documentation, Preservation, and Protection. EuroMed 2016*, Information Systems and Applications, incl. Internet/Web, and HCI 10059, 171-177.
- Vernant, J.P. and Zeitlin, F. I., ed. (1991): *Mortals and Immortals: Collected Essays*, Princeton.
- Whitmarsh, T. (2001): *Greek Literature and the Roman Empire*, Oxford.

Angelos Barmpoutis  
University of Florida

Eleni Bozia  
University of Florida

Retrouvez la version en ligne gratuite  
et ses contenus additionnels





# QGIS, UNE SOLUTION ALTERNATIVE POUR LA LECTURE DES INSCRIPTIONS

*Florent Comte, Coline Ruiz Darasse*

---

## INTRODUCTION

Actuellement, les Systèmes d'Informations Géographiques (SIG) sont communément utilisés pour leur pertinence dans l'étude topographique et cartographique, y compris dans le cadre de l'épigraphie. Notre propos n'est pas de revenir sur leur intérêt, clairement démontré depuis longtemps, pour la géolocalisation des corpus<sup>1</sup>, mais de proposer un usage inhabituel de ce type de logiciels pour l'étude directe des inscriptions. Les solutions SIG sont multiples, et nous nous concentrerons ici sur le logiciel libre QGIS, afin de nous inscrire pleinement dans le cadre de la science ouverte et des principes FAIR actuellement en vigueur.

Dans un travail d'analyse morphologique de modélisations virtuelles, il est possible d'utiliser les nuages de points 3D et les maillages 3D, mais aussi les Modèles Numériques de Surfaces (MNS), c'est-à-dire des rasters<sup>2</sup> contenant des informations de profondeur. À ce titre, le MNS s'apparente à une modélisation 2.5D (un format à deux dimensions, la hauteur étant enregistrée comme valeur de chaque pixel), et non pas à une modélisation 3D *stricto sensu* (**fig. 1**). Pour autant, dans le cas où aucun point ne se trouve par-dessus un autre (ce chevauchement altimétrique demandant forcément d'enregistrer soit le point le plus haut, soit le plus bas, soit la moyenne des deux), les MNS peuvent enregistrer un échantillon régulier de la surface d'un sujet, et permettent ainsi de travailler sur des sujets assez plats (car il n'y a aucun chevauchement altimétrique de points). Ils servent ainsi de supports pour des analyses morphologiques de territoire depuis des décennies, grâce aux captations aériennes et satellitaires. Mais, loin de cantonner ce type de modèle aux reliefs de paysages, il est possible de réaliser le MNS de n'importe quelle surface majoritairement plane, comme un mur encore en élévation, ou même des blocs portant une inscription<sup>3</sup>.

- 1 À ce titre-là, voir le travail réalisé sur le corpus d'inscriptions du site archéologique d'Ensérune par C. Ruiz Darasse, bientôt disponible sous la forme d'un webGis : <https://msha.maps.arcgis.com/apps/webappviewer/index.html?id=782012ed0b9a435f809b5a5f384b3d24>.
- 2 Les rasters sont considérés comme des images, mais le terme définit exactement un fichier matriciel dont les colonnes et les lignes forment une grille où chaque case (un pixel) contient un nombre variable de champs de valeurs. Si la plupart des images peuvent donc être considérées comme des rasters (où chaque pixel contient une information de couleur RGBA), les rasters peuvent contenir bien d'autres informations, par exemple la profondeur (dans le plan de projection du raster). De plus, les rasters possèdent une échelle et une position spatiale, qui leur permet d'être utilisés dans n'importe quel logiciel dédié sans avoir besoin de modifier la taille ou la position des objets.
- 3 Nous utilisons ici le terme de MNS, mais d'autres noms sont utilisés pour ces rasters : MNT, MNE, Heightmap, etc. Loin d'être synonymes, ces noms recouvrent des réalités issues du monde de la géographie, de la cartographie et de la modélisation. Une certaine plasticité permet, à notre sens, de les utiliser indifféremment dans notre contexte, mais, parmi eux, la notion de MNS nous semble la plus juste.

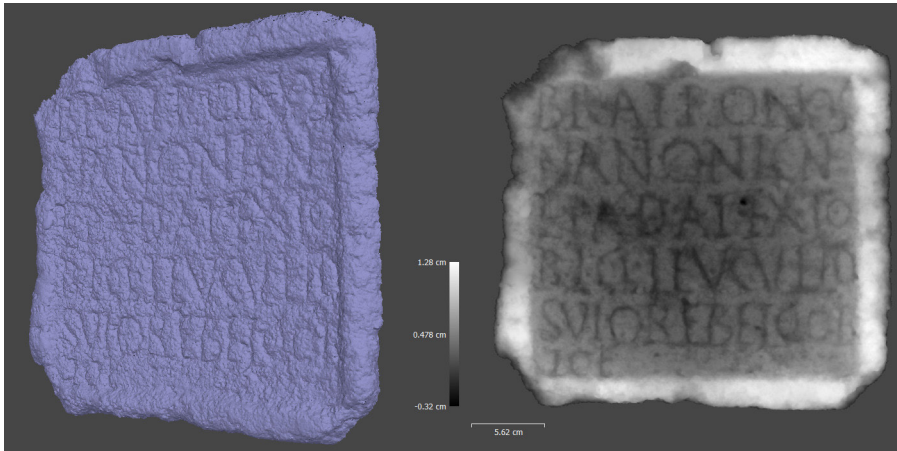

Fig. 1. Visualisation d'un Modèle 3D (gauche) et d'un Modèle Numérique de Surface (droite).

## DÉTOURNER QGIS

Il est entendu que les SIG et autres systèmes dérivés spécifiques aux Sciences Humaines et Sociales, comme les composantes cartographiques des Système d'Informations Archéologiques<sup>4</sup> ou Système d'Informations Référencées en 3D<sup>5</sup>, ont pour vocation principale de gérer des informations spatialisées et de les analyser. Deux grands types de données peuvent ainsi être intégrés à un SIG : d'une part, des données vectorielles, c'est-à-dire dans laquelle la composante spatiale est enregistrée dans des représentations mathématiques (points, lignes, courbes, polygones, etc.) ; d'autre part, des rasters, où l'information est enregistrée dans une "image" qui a une position, une rotation et une échelle connues. Le SIG permet aussi une gestion de ces données au travers d'outils de base de données dédiés (PostGIS par exemple), et un nombre très conséquent d'outils d'analyse spatiale et statistique. Ceux-ci sont habituellement utilisés pour des espaces larges, mais ils sont tout aussi pertinents à petite échelle. Les informations doivent nécessairement être importées dans un SIG avec un système de coordonnées : certains de ces systèmes sont généraux (WGS84), alors que d'autres sont spécialisés sur un territoire (comme le système de coordonnées Lambert pour la France)<sup>6</sup>.

Notre méthode se cantonne actuellement aux analyses que QGIS fournit pour étudier les rasters (nous laissons de côté les bases de données, les outils statistiques, etc.). Nous détournons donc l'usage du logiciel pour analyser des données spatialisées à l'intérieur d'une inscription. Notre MNS n'a pas de réalité géographique, car il s'agit de la surface d'un objet. Nous avons donc créé, un système de projection "local", c'est-à-dire qu'il n'est pas déformé par une quelconque caractéristique géodésique terrestre, et nous avons adapté l'échelle en fonction de nos analyses<sup>7</sup>.

4 Le projet est consultable ici : <https://abp.hypotheses.org/le-programme-bassin-parisien/les-projets/les-projets-associes-au-programme/fsn>.

5 Le projet est consultable ici : [https://archeovision.cnrs.fr/recherche\\_sir3d/](https://archeovision.cnrs.fr/recherche_sir3d/).

6 Cette différence est importante, car si les systèmes généraux ont tendance à nuancer les caractéristiques géodésiques locales, les systèmes locaux les incluent, mais déforment ce qui se trouve en dehors du territoire pour lequel ce système est réalisé.

7 En cela, nous nous rapprochons de la projection d'ingénierie, et nous avons choisi le millimètre comme unité de référence (voir Annexe 1).

## ANALYSES MORPHOLOGIQUES SUR QGIS

Une fois le MNS paramétré et importé dans QGIS, il est possible de faire des analyses sans déformation et à une échelle micromorphologique. Notre but est ici de lister les possibilités offertes par le logiciel afin d'apprécier les avantages de l'outil. Il est possible :

- de jouer sur la symbologie du MNS pour changer les couleurs, avec des gradients et des rendus de type *hillshade*, à la manière de CloudCompare<sup>8</sup>. Il est donc possible de convertir de manière efficace les informations de profondeur en gradients de couleurs ;
- de réaliser des analyses sur ce MNS et de générer des rasters dérivés, notamment en fonction de l'orientation, qui permet de connaître la direction du relief, mais aussi la pente, la rugosité, etc. ;
- de faire des opérations spéciales sur le MNS avec des couches de vecteurs, pour le découper par exemple, créer des courbes de niveau, ou détourner des sous-espaces du MNS, analysables indépendamment et comparables à d'autres zones ;
- d'utiliser la calculatrice de rasters pour créer des analyses personnalisées à partir des rasters déjà générés, mais aussi d'opérations booléennes<sup>9</sup>, d'opérateurs arithmétiques et de fonctions trigonométriques, pour accentuer des résultats d'analyse par exemple, les convertir entre différentes unités, ou même cumuler les résultats entre eux.

Certaines extensions gratuites du logiciel (directement téléchargeables depuis le menu d'extension) permettent également de réaliser des analyses et des traitements plus complexes, comme des échantillonnages ou des filtrages particuliers.

Prenons quelques exemples. Dans QGIS, des rasters de pente et d'orientation peuvent être directement générés à partir d'un MNS. Grâce à la calculatrice de rasters et la formule adéquate<sup>10</sup>, il est possible de créer une carte des orientations du relief, équivalente au rendu des vecteurs normaux (appelé carte des normales ou *normal map*<sup>11</sup>) généré habituellement en 3D (**fig. 2a**). Il est aussi possible de créer rapidement des ombres rasantes, si utiles à l'épigraphie, en utilisant la technique du *hillshading* (**fig. 2b**). Ensuite, certaines analyses micro-morphologiques, similaires au *Morphological Residual Model*<sup>12</sup>, sont réalisables grâce aux différences entre MNS précis et adoucis par des filtres gaussiens présents dans le logiciel. Il est enfin possible de calculer divers rendus, comme des gradients répétitifs, un peu à la manière du *plane shading*<sup>13</sup> (**fig. 2c**).

Ensemble, ces éléments font de QGIS un logiciel capable de générer une série d'analyses morphologiques intéressantes pour les études épigraphiques. Le logiciel est également capable de fournir des rendus rigoureux avec un certain nombre d'éléments automatiques (des échelles, des légendes, des grilles).

8 Comte 2018 ; Pires *et al.* 2014.

9 Il s'agit des opérations AND, OR, XOR, etc... permettant de faire interagir deux opérandes dont les valeurs en entrée, permettent de moduler le résultat de sortie.

10 Voir Annexe 2.

11 Voir Comte & González Bordas dans ce volume, 16, n. 25.

12 Voir Comte & González Bordas dans ce volume, 16-19.

13 Comme réalisé pour l'étude des inscriptions sur le site de Stonehenge, en 2013. Cette technique de visualisation permet de réaliser des gradients blanc-noir répétés et rapprochés pour faire sortir les microdétails morphologiques ([https://www.researchgate.net/publication/274052702\\_Revealing\\_the\\_secrets\\_of\\_stonehenge\\_through\\_the\\_application\\_of\\_laser\\_scanning\\_photogrammetry\\_and\\_visualisation\\_techniques](https://www.researchgate.net/publication/274052702_Revealing_the_secrets_of_stonehenge_through_the_application_of_laser_scanning_photogrammetry_and_visualisation_techniques)).

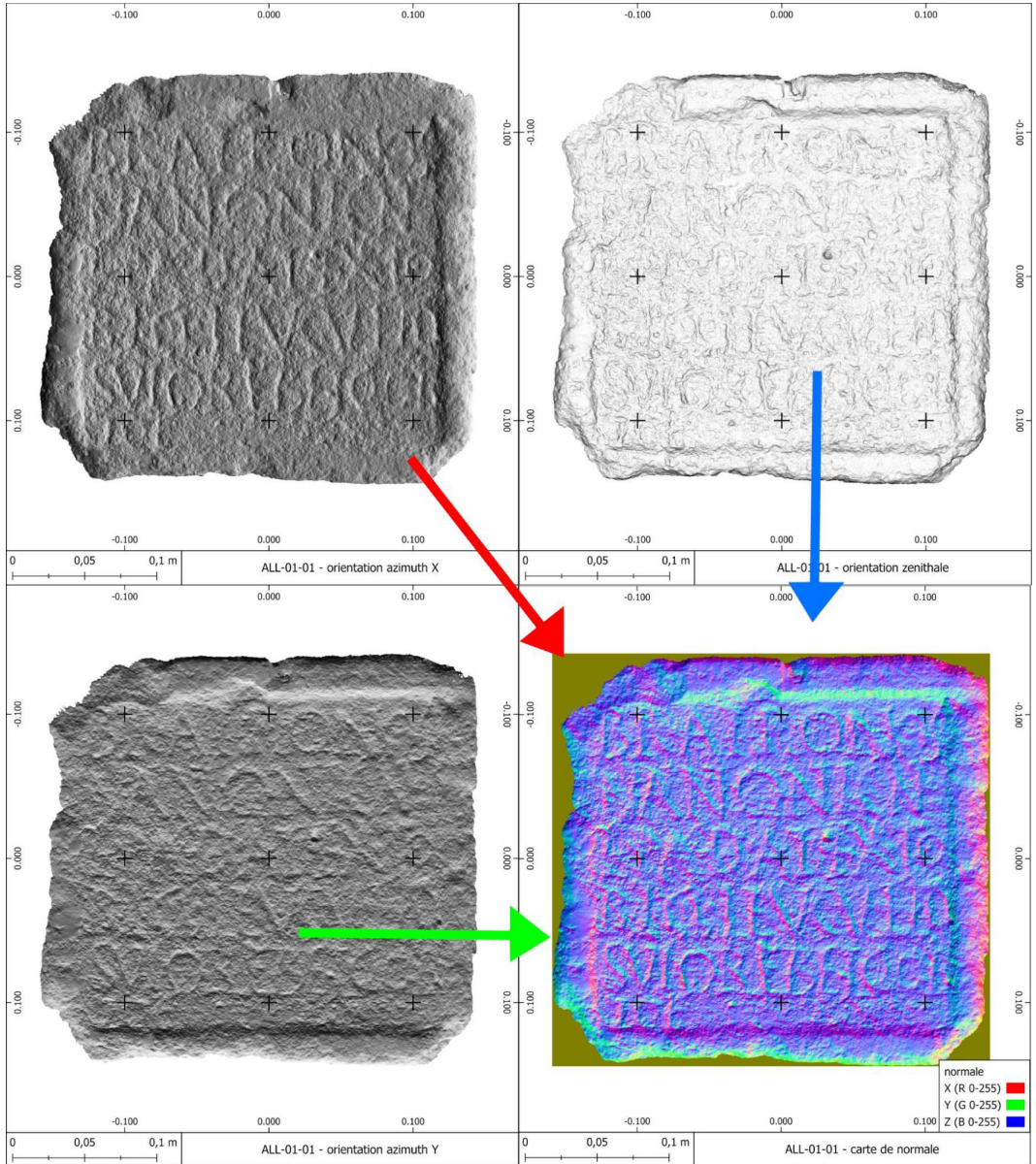

Fig. 2a. Création d'une carte de normale avec QGIS. Clichés : RIIG, avec l'aimable autorisation du musée de Cluny. Traitement : F. Comte.

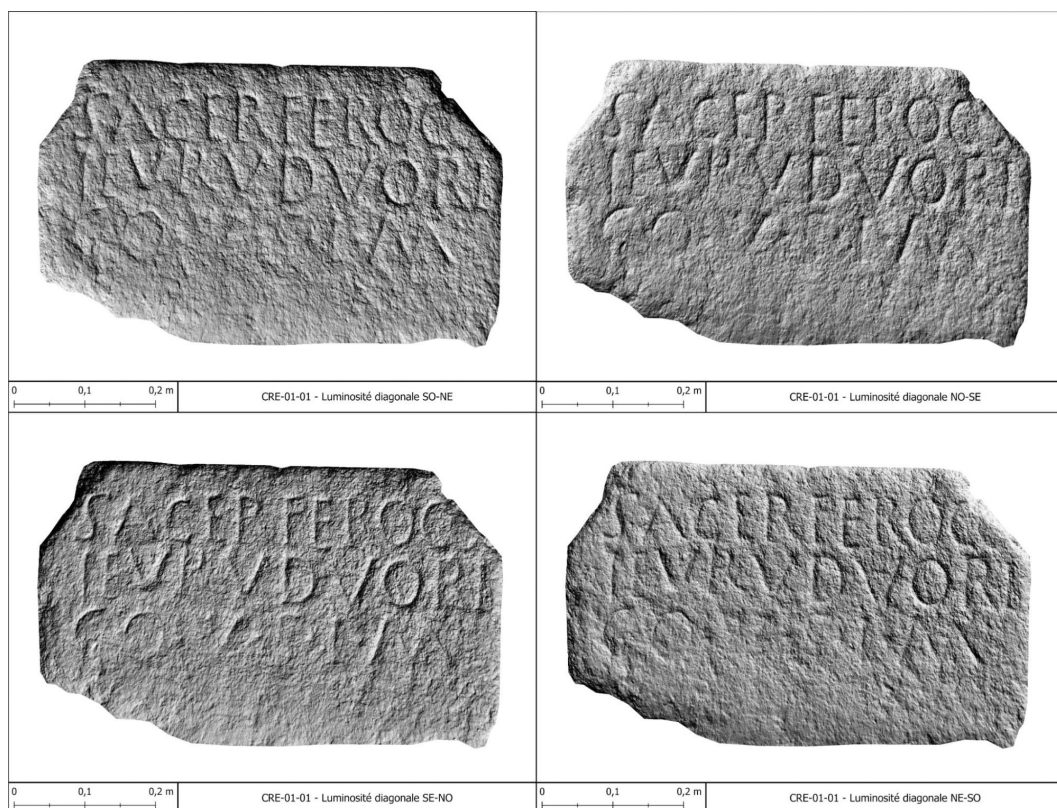

Fig. 2b. Ombres orientées avec QGIS. Clichés : RIIG, avec l'aimable autorisation du musée d'art et d'archéologie de Guéret. Traitement : F. Comte.

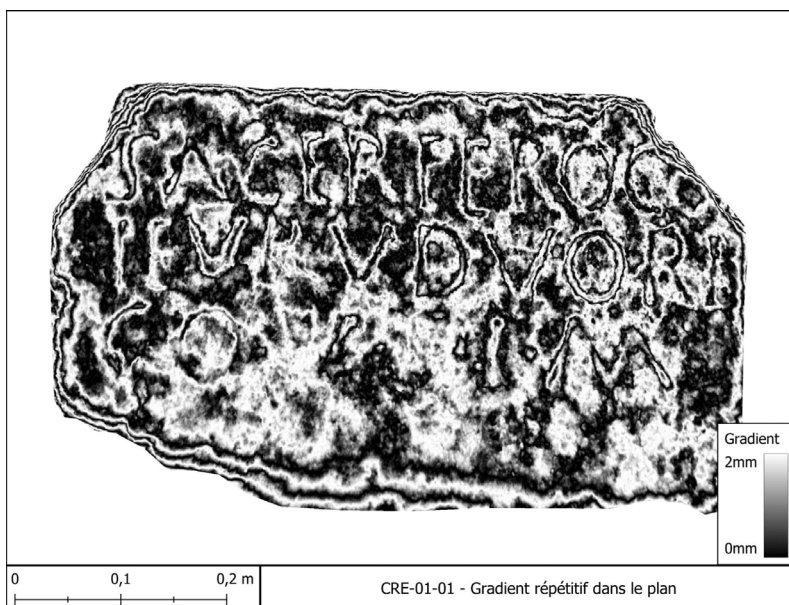

Fig. 2c. Création d'un rendu plane shading avec QGIS. Clichés : RIIG, avec l'aimable autorisation du musée d'art et d'archéologie de Guéret. Traitement : F. Comte.

Nous utiliserons, pour illustrer notre méthode, deux exemples tirés du corpus du Recueil Informatisé des Inscriptions Gauloises (RIIG) dont l'acquisition photogrammétrique a été réalisée dans le cadre du projet ANR 19-CE27-0003<sup>14</sup>.

### CRE-01-01

Trouvée au milieu du XIX<sup>e</sup> siècle lors des travaux du chemin de Limoges à Montluçon, dans le tronçon Saint-Sulpice-Laurière/Guéret, sur le territoire communal d'Arrènes, cette inscription en langue gauloise, mais avec un formulaire votif latin, est actuellement conservée dans les réserves du musée d'art et d'archéologie de Guéret. Inventoriée L-7 dans le *Recueil des inscriptions gauloises* (RIG II-1) publié par Michel Lejeune en 1988, elle correspond à l'inscription CRE-01-01 du projet RIIG.

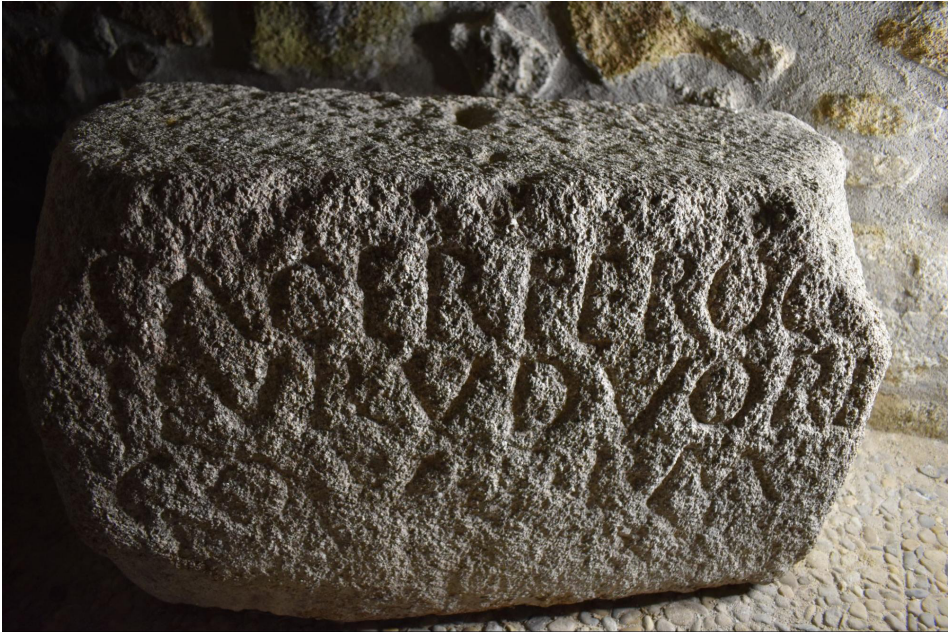

Fig. 3. L'inscription CRE-01-01 dans les réserves du musée d'art et d'archéologie de Guéret. Photo : H. Blanchet, avec l'aimable autorisation du musée.

14 *Recueil informatisé des inscriptions gauloises* (ANR 19-CE27-0003) : <https://riig.huma-num.fr/>.

## ACQUISITION ET MODÉLISATION

La pierre inscrite CRE-01-01 est conservée dans un espace non éclairé, étroit et difficile d'accès (**fig. 3**). H. Blanchet a pu la photographier en novembre 2021 directement sur place. Il a utilisé un Nikon D5600 avec flash afin de récupérer une luminosité correcte dans l'obscurité et pour aplatir les couleurs de ce granit à gros grains<sup>15</sup>. La pierre étant posée sur le sol, à proximité d'autres blocs et avec un angle collé au mur, il a été extrêmement compliqué d'en faire une acquisition rigoureuse<sup>16</sup>. Au final, la collection de 180 photographies réalisées a permis de modéliser la pierre sur plusieurs échelles : des prises de vues éloignées pour sa morphologie générale, et une acquisition linéaire proche pour la face inscrite.

Si, dans le cadre du RIIG, l'ensemble de la pierre a été généré, nous nous sommes concentrés, ici, sur la modélisation de la face inscrite grâce aux 69 images les plus pertinentes. Pour réaliser le MNS, nous avons utilisé Agisoft Metashape, mais nous aurions pu tout aussi bien le réaliser avec des solutions libres<sup>17</sup>.

Le MNS exporté de Metashape<sup>18</sup> (réalisé depuis le nuage dense en qualité maximale) a ainsi pu être utilisé directement dans QGIS (le même travail a été fait pour l'orthomosaïque générée dans le même temps) pour réaliser diverses analyses morphologiques, calcul de pente, calcul des courbes de niveaux, MRM et *planeshading*.

## LECTURE (**fig. 4**)

L'inscription de Sazeirat est une pierre qui présente un double texte votif. Une première phrase est écrite en langue gauloise, avec le verbe de dédicace bien identifié *ieuru* (prétérit à la 3<sup>e</sup> personne du singulier) suivi d'une formule latine très usuelle et communément abrégée : V.S.L.M. (*uotum soluit libens merito* : "Il s'est acquitté de son vœu volontiers et comme il faut"). L'objet de cette dédicace est *duorico(n)*, un terme qui désigne probablement un portique dans la langue gauloise. La mixité de cette inscription est redoublée dans le nom du dédicant (ou des dédicants) qui porte un *cognomen* latin (*Sacer*), malgré l'origine probablement très locale de l'individu.

L'enjeu de la modélisation de la pierre était double : d'une part sa conservation numérique évidente, mais aussi et surtout sa visualisation améliorée afin de mieux comprendre et le bloc et l'inscription qu'il porte. Le granit à gros grain n'est pas propice à une gravure fine et une des questions était de vérifier que la formule latine était bien de la même main que la phrase gauloise, ce qui semble pouvoir être affirmé sans difficulté à présent.

15 Sous peine que le logiciel ne puisse reconnaître assez de points analogues, entre les différences de couleurs et d'ombrage sur cette pierre rugueuse et mouchetée.

16 Le paramétrage manuel était loin des extrêmes pour éviter les distorsions (voir Annexe 3). La balance des blancs a été reprise dans Rawtherapee, mais la luminosité n'a pas pu être linéarisée en raison d'un enregistrement initial au format JPEG et non NEF.

17 Nous pensons ici à un processus croisé entre MicMac (pour la réalisation d'un nuage dense BigMac via C3DC), et CloudCompare pour la réalisation du MNS avec l'outil de conversion de nuage de points vers raster 2D.

18 Voir Annexe 3. Il faut remarquer que nous travaillons avec un système de coordonnées en millimètre afin d'éviter de travailler uniquement sur les 2<sup>e</sup> et 3<sup>e</sup> décimales, et que nous exportons le MNS et l'orthomosaïque dans ce système.

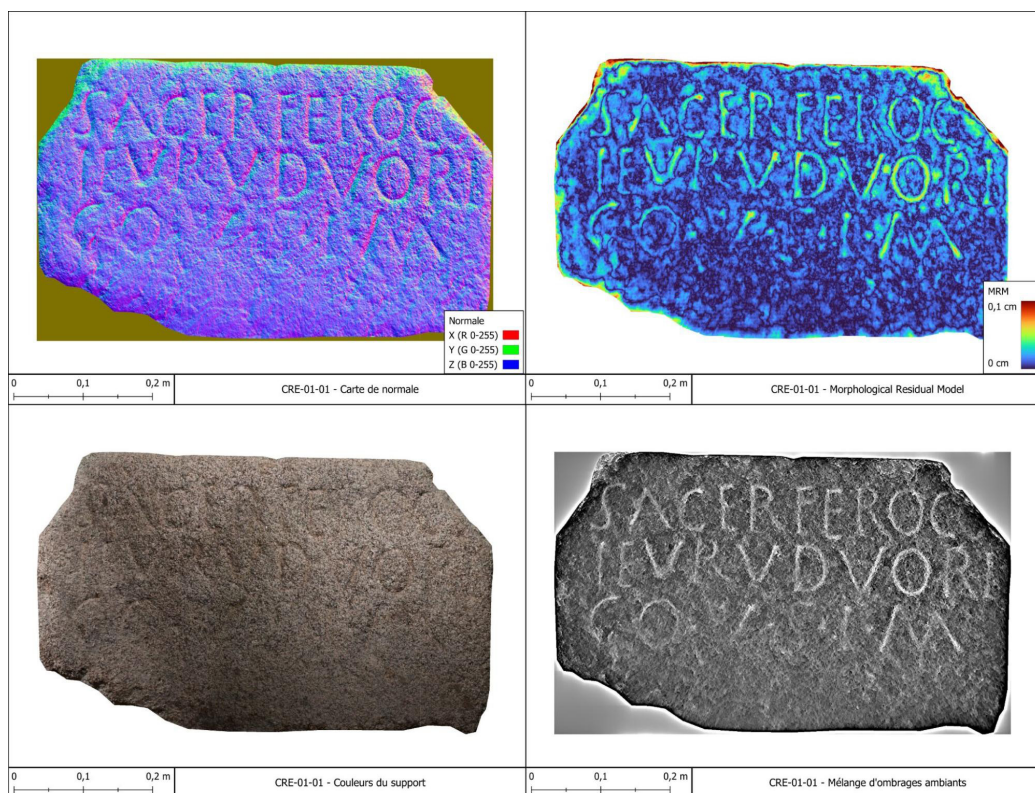

Fig. 4. Analyses morphologiques de CRE-01-01. Clichés : RIIG. Traitement : F. Comte.

## ALL-01-01

La pierre de Nérès-les-Bains est une inscription gallo-latine (ALL-01-01 = RIG II.1, L-6) découverte en 1836 et conservée au musée de Cluny où elle a été exposée pendant de nombreuses années dans la salle du frigidarium des thermes. Il s'agit d'une plaque de grès pratiquement carrée qui est datée du I<sup>er</sup> s. p.C.

### ACQUISITION ET MODÉLISATION

La pierre inscrite, actuellement conservée dans les réserves du musée de Cluny, a été numérisée par Coline Ruiz Darasse en mai 2023. Elle a été relevée avec un éclairage latéral, avec le même appareil que pour CRE-01-01. Le paramétrage de l'appareil a été fait différemment, avec une ouverture plus grande (parallèle à une distance de prise de vue éloignée pour éviter les flous focaux) et un ISO plus important pour garantir une vitesse d'obturation assez rapide pour



éviter les flous de mouvements. Sur les 400 images acquises sous différentes illuminations, 83 ont été sélectionnées pour réaliser finement la face inscrite, et ont permis de générer un MNS précis dans Metashape<sup>19</sup>.

### LECTURE (fig. 5)

L'inscription de Nérès-les-Bains est gravée sur un support en grès brunâtre, dont Michel Lejeune signale qu'il est "très impropre à la gravure". Les différents clichés dont nous disposons et qui dataient de la fin des années 1970 début des années 1980, montraient déjà l'embarras des photographes pour disposer d'un éclairage permettant de lire correctement l'inscription. En 2023, la pierre était dans un très bon état sanitaire, mais la surface s'était encore érodée et a rendu l'interprétation de la modélisation plus difficile. Le recours au dessin initial préparé par Michel Lejeune pour la publication du RIG II.1 en 1988 a été, pour certaines lettres, indispensable. Le niveau de lecture actuel, grâce à cette modélisation, est identique à celui de 1988, malgré la dégradation de la pierre. En revanche, l'utilisation des différents traitements proposés a révélé l'existence d'empattements assez élégants dans la gravure des lettres (notamment les N), invisibles à l'observation directe et non retranscrits dans le dessin du RIG II.1. Cette nouveauté permet de remettre en question la datation de l'inscription : l'influence latine plus marquée dans le traitement de la gravure pourrait venir s'accorder avec différents traits linguistiques propres au gaulois tardif.

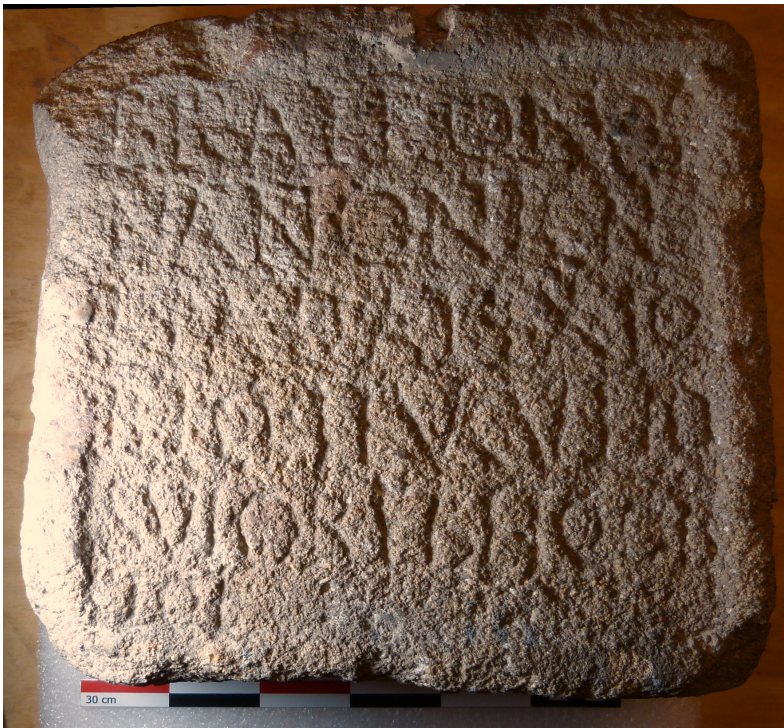

Fig. 5. L'inscription ALL-01-01. Clichés : C. Ruiz Darasse, avec l'aimable autorisation du musée de Cluny.

19 Là aussi, le format NEF a permis de travailler l'image brute pour sortir la meilleure image possible pour la photogrammétrie (voir Annexe 3).

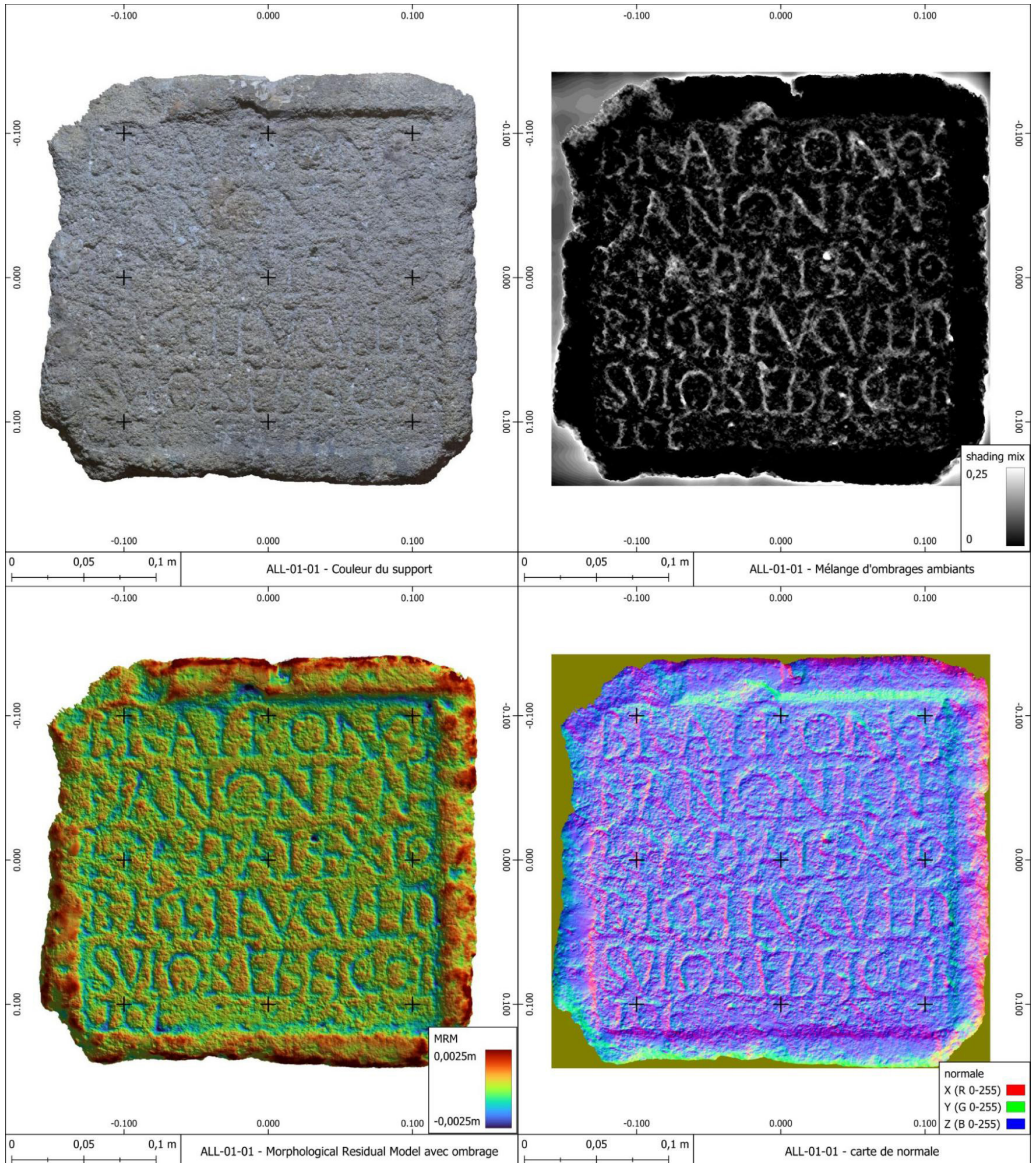

Fig. 6. Analyses morphologiques de ALL-01-01. Clichés : RIIG. Traitement : F. Comte.

## CONCLUSIONS

Cette première expérience avec le logiciel QGIS permet de montrer la palette de possibilités offertes par un usage pour le déchiffrement et la communication des données morphologiques du corpus épigraphique. Logiciel libre déjà extrêmement utilisé par les SHS, la personnalisation de l'espace de travail permet de le détourner à moindres frais, pour y réaliser des analyses similaires à celles que l'on effectue généralement sur les nuages de points denses, mais sur un autre type de modèle : le Modèle Numérique de Surface. Le niveau d'analyse nous semble remarquable, et la possibilité de réaliser des extensions dédiées permettraient, à terme, de systématiser ce type d'étude sans trop de manipulations. Enfin, le logiciel – spécialisé dans la création de cartes géographiques – possède un nombre conséquent d'outils pour affiner la publication même des analyses. Ces différents outils contribuent de manière notable à l'amélioration de la lecture de certaines inscriptions, dont certaines sont d'interprétation très difficile à cause de la nature du support employé.

## ANNEXES

### Annexe 1

Système de projection personnalisé au format WKT :

```
LOCAL_CS["Local Coordinates (mm)", LOCAL_DATUM["Local Datum"], UNIT["millimetre", 0.001], AUTHORITY["EPSG", "1025"]], CS[Cartesian, 2], AXIS["x", east, ORDER[1], LENGTHUNIT["millimetre", 0.001, ID["EPSG", 1025]]], AXIS["y", north, ORDER[2], LENGTHUNIT["millimetre", 0.001, ID["EPSG", 1025]]].
```

### Annexe 2

Le vecteur normal [X, Y, Z] est défini dans QGIS par le calcul de deux rasters depuis un MNS, "pente" et "exposition" (en radians, sinon en "degré \* (pi /180)") :

Bande R =  $\sin(90 - \text{"exposition"}) * \sin(\text{"pente"})$ ,

Bande G =  $\cos(90 - \text{"exposition"}) * \sin(\text{"pente"})$ ,

Bande B =  $\cos(\text{"pente"})$

### Annexe 3

Inscription	Acquisition				Images	Traitement			
	Ouverture	Iso	Vitesse d'obturation	Format		Nombre	Format	Erreur RMS de modélisation	Précision d'échelle
CRE-01-01	f/11	100	1/200	JPG	69	JPG	0.094 (0.54 px)	0.07 mm	0.05 mm/px
ALL-01-01	f/4	400	1/125	NEF	83	JPG	0.132 (0.70 px)	0.02 mm	0.14 mm/px

## BIBLIOGRAPHIE SÉLECTIVE

- Comte, F. (2018) : "L'utilisation des nouvelles technologies dans l'étude des inscriptions anciennes", *Travaux d'archéologie Limousine*, 38, 91-102.
- Pires, H., Fonte, J., Gonçalves-Seco, L., Correia Santos, M. J. et Sousa, O. (2014) : "Morphological Residual Model – A tool for enhancing epigraphic readings of highly eroded surfaces. Information Technologies for Epigraphy and Cultural Heritage", in : Orlandi, S., Santucci, R., Casarosa, V., Liuzzo, P. M. éd. : *Information Technologies for Epigraphy and Cultural Heritage, Proceedings of the First EAGLE International Conference*, Rome, 133-144.
- Ruiz Darasse, C., Blanchet, H., Mullen, A., Chevalier, N. et Prévôt, N. : "RIIG ALL-01-01", in : Ruiz Darasse, C. éd. : *Recueil informatisé des inscriptions gauloises*, <https://riig.huma-num.fr/>. DOI : [https://doi.org/10.21412/petrae\\_riig\\_ALL-01-01](https://doi.org/10.21412/petrae_riig_ALL-01-01) (consulté le 10/11/2023).
- Ruiz Darasse, C., Blanchet, H., Estarán, M.-J., Mullen, A., Chevalier, N. et Prévôt, N. : "RIIG CRE-01-01", Ruiz Darasse, C. éd. : *Recueil informatisé des inscriptions gauloises*, <https://riig.huma-num.fr/>. DOI : [https://doi.org/10.21412/petrae\\_riig\\_CRE-01-01](https://doi.org/10.21412/petrae_riig_CRE-01-01) (consulté le 10/11/2023).

## Corpus

- RIG : Lejeune, M. (1988) : *Recueil des inscriptions gauloises*. II, fasc. 1, *Textes gallo-étrusques, textes gallo-latins sur pierre*, Gallia Suppl. 45, Paris.
- RIIG : *Recueil informatisé des inscriptions gauloises. Édition, contexte archéologique, analyse linguistique, étude sociolinguistique* [En ligne] <https://riig.huma-num.fr/>.

Florent Comte

UMR 3495 MAP – MAP-Gamsau

Coline Ruiz Darasse

CNRS, UMR 5607 Ausonius – Université Bordeaux Montaigne

Retrouvez la version en ligne gratuite  
et ses contenus additionnels



## Numérique et lecture de textes épigraphiques altérés

est un livre numérique en libre accès contenant des annexes  
et des bibliographies Zotero.

Ausonius Éditions, Collection PrimaLun@ 27.

ISSN 2741-1818 ; Pessac (Université Bordeaux Montaigne)

Ce livre est imprimé en 50 exemplaires et ne peut pas être vendu.

Version html et pdf sur <https://una-editions.fr>



Récemment, les nouvelles technologies et, en particulier, la modélisation 3D se sont fait une place incontournable dans la discipline épigraphique. Ce développement a eu lieu simultanément dans différentes institutions où les chercheurs ont mis en place des méthodes variées et personnelles, que ce soit lors de l'acquisition des données, de leur traitement, de leur analyse ou de leur communication.

Dans ce cadre hétérogène, le présent ouvrage reflète à la fois les premières avancées et les défis actuels. Commencant par un état des lieux des travaux réalisés depuis l'adoption de ces nouvelles technologies jusqu'à nos jours, il met en avant des cas d'étude variés, d'une façon accessible pour les chercheurs non-initiés. Au travers de ces situations, il propose des solutions adaptées pour faire face à la variété des conditions de travail, des matériaux du support, du type de gravure ainsi que du niveau d'érosion ou d'endommagement de l'inscription, chacune de ses collaborations constituant une démonstration méthodologique issue d'un ou de plusieurs exemples précis. Par ce biais, ce volume sert également en tant que guide pour les collègues voulant s'ouvrir à l'usage de ces nouveaux outils.

Recently, new technologies and, in particular, 3D modelling, have made their mark on the discipline of epigraphy. This development has taken place simultaneously in a number of different institutions, whose researchers have used a variety of different methods to acquire, process, analyse and communicate data.

From this heterogeneous context, the present book takes up these initial advances while addressing the current challenges. Beginning with an overview of the work carried out since the adoption of these new technologies up to the present day, it highlights a variety of case studies, in an accessible way to uninitiated researchers. Through these situations, it offers solutions tailored to the variety of working conditions, support materials, type of engraving and level of erosion or damage to the inscription, as each contribution constitutes a methodological demonstration for one or more specific cases. In this way, this book also serves as a guide for colleagues wishing to open up to the use of these new tools.



Cet ouvrage a obtenu le soutien financier de l'Institut Ausonius, UMR 5607-CNRS ainsi que de l'Université Bordeaux Montaigne dans le cadre de la PSE3-2023.



## Numérique et lecture de textes épigraphiques altérés

est un livre numérique en libre accès contenant des liens et une bibliographie Zotero.



Ne peut être vendu. À retrouver sur <https://una-editions.fr>



Ausonius éditions. Collection PrimaLun@ 27 ; ISSN 2741-1818 ; Pessac ; EAN imprimé 9782356135476