



HAL
open science

Sinyar and SBB (Central Sudanic): genetic relationship or contact?

Pascal Boyeldieu

► **To cite this version:**

Pascal Boyeldieu. Sinyar and SBB (Central Sudanic): genetic relationship or contact?. *Linguistique diachronique et reconstruction : méthodes, acquis, avancées récentes*, Labex EFL, Jul 2013, Paris - Inalco, France. halshs-04579986

HAL Id: halshs-04579986

<https://shs.hal.science/halshs-04579986>

Submitted on 18 May 2024

HAL is a multi-disciplinary open access archive for the deposit and dissemination of scientific research documents, whether they are published or not. The documents may come from teaching and research institutions in France or abroad, or from public or private research centers.

L'archive ouverte pluridisciplinaire **HAL**, est destinée au dépôt et à la diffusion de documents scientifiques de niveau recherche, publiés ou non, émanant des établissements d'enseignement et de recherche français ou étrangers, des laboratoires publics ou privés.

Sinyar and SBB (Central Sudanic): genetic relationship or contact?





Pascal Boyeldieu (CNRS, Llacan) – boyeldieu@vjf.cnrs.fr

1. Vocabulary

Sinyar	Modo	Bongo	Yulu	Gula Zura	Sar	
wife/wije	ɔyɔ	fɔ	ɔofa	ɔjɔ	ɔja	beget, to
wèl	yàlɪ	hòlɪ	sáal(ə)	sel	yɛl	bird
mbàár	mbà	màyà	ɔmb(ə)	mvà	mbà	breast
wille	ɔlɛ	yɔ	ɪlɛ	ɔy	ɔy	die, to
ɔisì	bɪ	bɪhɪʔ	bɪis(ə)	ɔis	bɪsə	dog
iya	ɪwɛ	yɛ	ɔyɛ	āy	āy	drink, to
wɪj	ɔpɔ	pɔ	ɔpɛ	ɔpɔ	ɔo, ɔu	eat, to
kwòm	kɔmɔ	kɔmɔ	kāam(ə)	kām	kùm	eye
fɔdɔ	pàdɔ	fɔdɔ	vük(ə)	hād	hɔr	fire
kwùnjó	kɛnzɛ	kɪnjɪ	kɛɛnj(ə)	kānz	kānjɛ	fish
ɪbì	bɪ	hɪbɪ	kiit(ə)	kūb	yɪbɛ	grease, oil
kòjjù	kàzɔ	lingɛ	ngāj(ə)	kàz	gājɛ	horn
uŋŋa	ɔŋmá	(ngbá ?)	ɔŋɛ	ām	təngā	hot, to be
màá	má	máʔ	māa(nɛ)	mā	māā	I
ugol/ungol	ɪkàlɪ	ɔhitù	ɛɛdɛ.gāayɔ	ngɛl	gɛl	know, to
uɓa/umba	ɔbá	ɔbá	ɔɔbɛ	ɔb	ɔbá	make a pot, to
ɪjjà	yɪdá	mɛhì	ɛj(ə)	dā	dā	meat
tàar	kpà	kò, tàrà	tāa	tā	tā	mouth
èerè	mòyɪ	rɔ	cāa	rɔ	rɪ	name
ìccà	sá	cāa	ɛc(ə)	vāl	māng	ox, cow
kùfò	fɔ, kúpɔ	fɔ, kóhɔ	kɔof(ə)	kɔhɔ	kɔ	seed
affa	ápá	ápá, áfá	āapə	ət	kàtə	sharp, to be
ànnà	ɔaná, kɪlákà	hɪbáʔná	wāan(ə)	ndár	ndāɾ	skin
sudɔ/sunjo	ɔdɔ	dɔ	ndɔɔdɛ	tɔd	tɔ	sleep, to
mùttà	mùtá	mùtá	mɔdɔfá	mɛtá	mɛtá	three
kàggá	ŋgɛrɪ	kágá	kāag(ə)	kāg	kāgɛ	tree
ród	rɪyɔ	ngɔrɪ	jɔoy(ə)	dɔ	jɔɔ	two
dɛʔe- who?	wádɪ	dɪ	āadɛ	dɪ	rɪ	what?

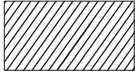
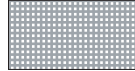
Table 1. Similar vocabulary: a selection (highlighting indicates cognates)

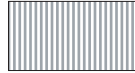
THE CENTRAL SUDANIC LANGUAGES

	MORU-MADI		MANGBUTU-EFE
	LENDU		SBB
	MANGBETU		Others

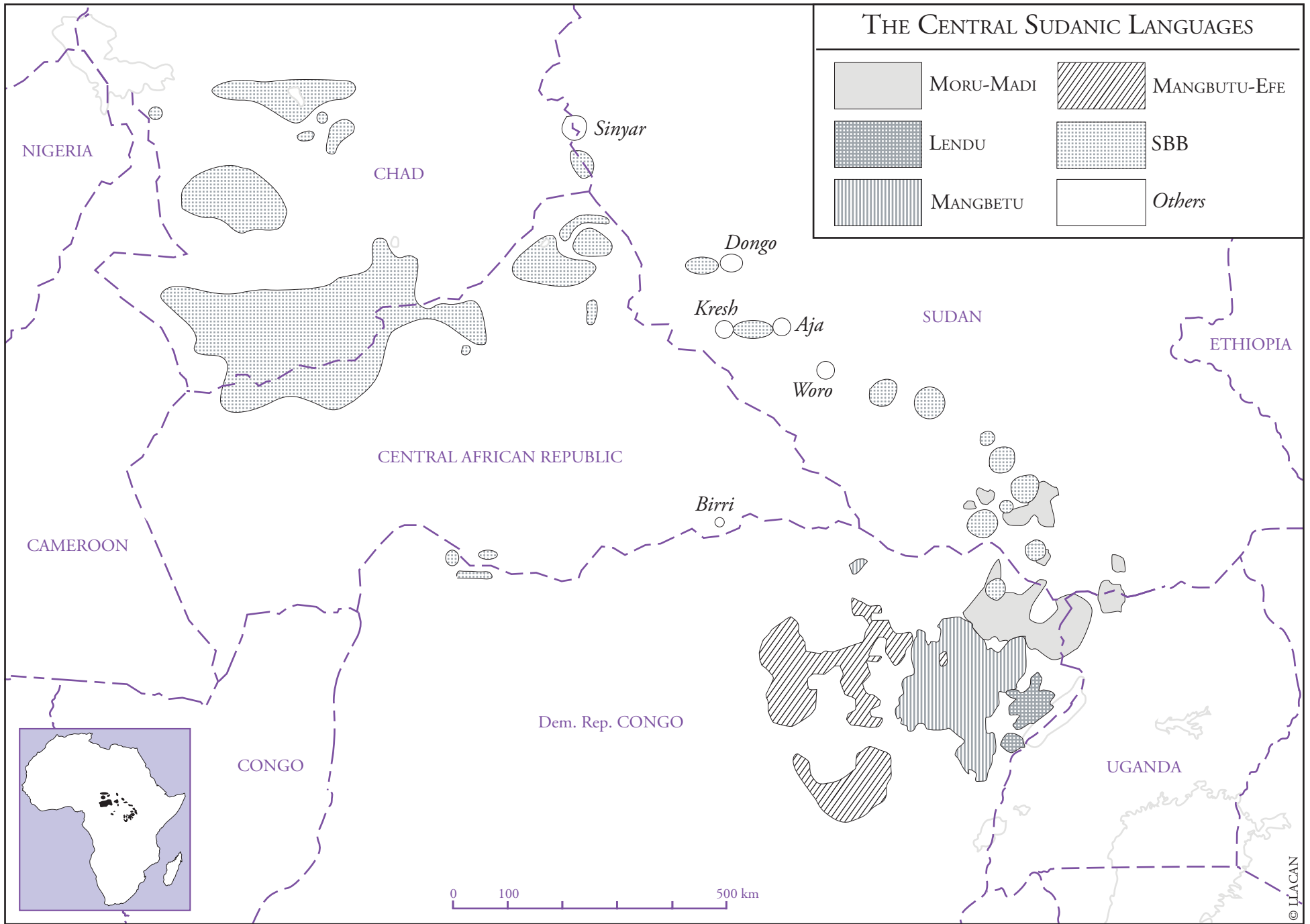

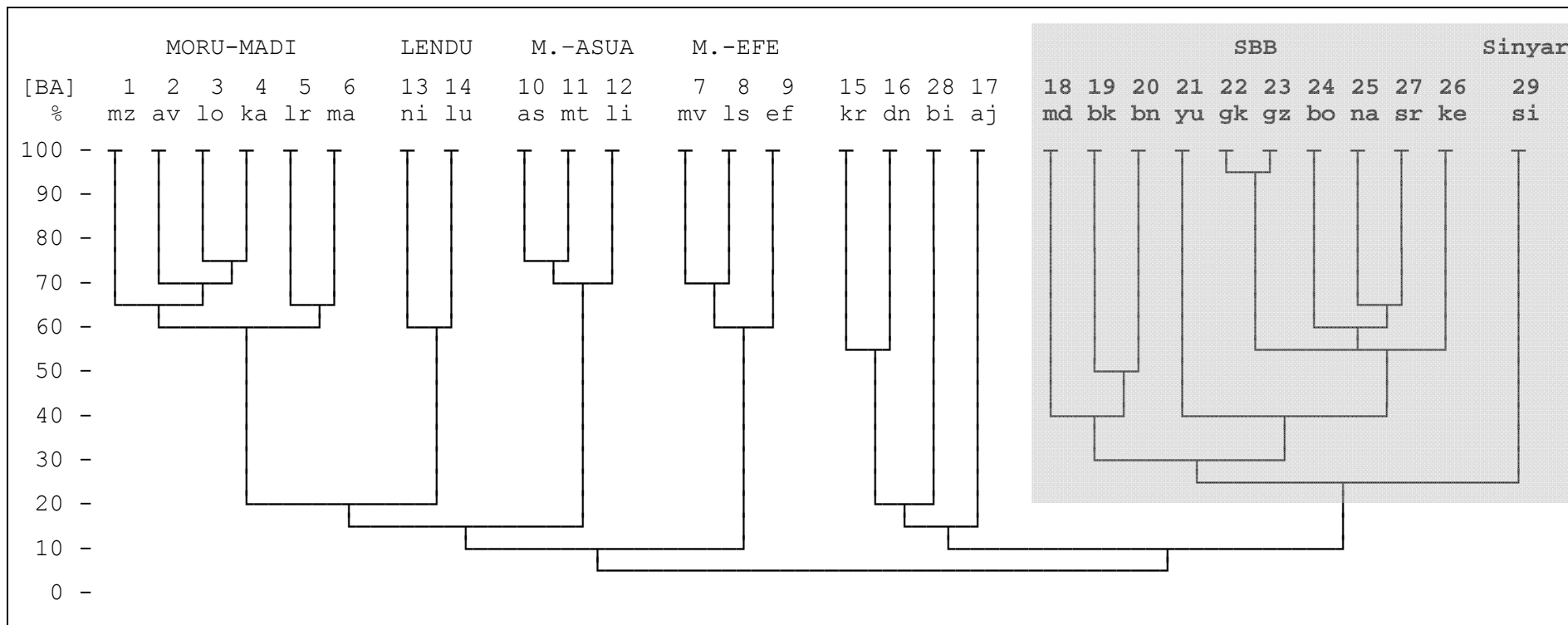

Table 2. Lexicostatistical distances for 29 Central Sudanic languages (based on a 100-word Swadesh list; Branch Average)

18	md	Modo	23	gz	Gula Zura	29	si	Sinyar
19	bk	Baka	24	bo	Bagiro			
20	bn	Bongo	25	na	Na			
21	yu	Yulu	27	sr	Sar			
22	gk	Gula Koto	26	ke	Kenga			

Sinyar	*SBB	Modo	Bongo	Yulu	Gula Zura	Sar	
f- fiyà firyà fií fòdú	*b- >	b- (bàpà ?)	b- bíná' bìí bòdú	b- í(ə) bàad(ə)	v- vɔɔ vɔɔ vād	b- bīyā bīyā bīī bòr	goat gruel, porridge hair warthog
-j(j)- kàjjà kùjá water, thirst wèrjí wirja/wirnja	*-d- >	-d- kàdà kùdà yàdí (ùdòdù ?)	-d- kàdà kùdà hèdí dà	-j- kàaj(ə) kòoj(ə) sáj(ə) èejā	-d- kád kéd kád, sád	-d- (kəndā ?) yèdā ədā	sun thirst urine tie, to

Table 3. Regular (?) correspondences

Sinyar	Modo	Bongo	Yulu	Gula Zura	Sar	
sìmir	tàgí	(tángá' ?)	māaj(ə)	tēj	tējē	bee, honey
kittì	òlù	lùtì	jíyà, tūlè/túlè	tál	ìl, ndùl	black, to be
kàjìbil	kòbì	kóbí	sòob(ə) dòog(ə)	dògā	dògā	buffalo
uwe/weep	ákú	áí	āayā	ē	rèè	come, to
cuggol	(àlú ?)	(əl(ú) ?)	èelā	īī	(dúù, lúú ?)	deep, to be
arfa	ùtùtù, (èlé, òlé)		njèʔó	ndùtù	tùtā, ày	dry, to be
- ùrà ear - ìi leaf	mbúí	mbíí	ēemb(ə)	mvi ear kámv` leaf	mbī ear kámbe leaf	ear, leaf
kártí	kèdē	kìdì	mòng(ə)	kéd	kèdā	elephant
- gwàar foot - kàffà leg	ndí, gbòndò	gbòndò	sìnj(ə)	kɔɔnz	njà	foot, leg
kàanà	mòlì	ndùmá	njòom(ə)	ngel	mù	grass
sùbó	dò	dò	jāa	dò	dò	head
mùsù	bó	bóo	ndāal(ə)	bō	bōo	hunger
wii	úpò	túnú	òofā	tēlē	təl	kill, to
jùggòl	òwò, àkpà	àkpà	òwā	ngāi	ngāi	long, to be
kwànjà	népé	níhí	nēep(ə)	lēhē	nā	moon
kwàalà	mùgù	gò	gòo	gō	míndè	neck
sìyèer	làfā	kándá'	bāay(ə)	jā	kìjè	new
dìkittì	kòròndò	hìndò	gbāal(ə), kèjìyà	nónq	ndò	night

nàrmá	kànó	hòmò	sāam(ə)	ngóhō	kón	nose
– cé/céè – jíti	biláká	fí	káac(ə)	dēb	dēē	person
đi	bí	bì	gàa		lòo	place
kàđũ	kòngò	nù	ĩn(ə)	nē	(yèe ?)	placenta
urba/urmba	úfó	fú	bofá	ojó	əjò	plait, to
weeri (-ooru)	áđí	éđí	āadā	ēđ	ēdā	rain, to
abbal	āsí	əhí	écə	āc	(kāsə)	red, to be
kwàár	kàbí	kèbí		kāl	kàlā	rope
đúfú	kòtù	cúká ⁺	ĩees(ə)	sà	sà	smoke
nđùbbòl	múré	kìràná	nāamb(ə)	ĩĩ	lĩ	snake
maggal/ mangal	úđògò	đògò	wóogə	đògò, mòg	đògə	steal, to
gòl	ĩtú	ĩtú	kòt(ə)	kòt	mbàl	stone, grindstone
wicce (-ucce)	àfí, idíđí	kíđí	ná?ə	ēj	ùn	wet, to be

Table 4. Non-similar vocabulary: a selection

2. Personal pronouns

	Sinyar	*SBB	Modo	Bongo	Gula Zura
S1	màalé, (màá)	*má	má	má	mā
S2	illé	*(?)í	ní	í	ī
S3	nàalé, (nàá)	*nE ?	<i>masc.</i> bù <i>fem.</i> lòkú	<i>masc.</i> bá <i>fem.</i> hó <i>neutral</i> nà	ō
P1 excl./dual	<i>dual</i> cìngé ? cìyé	*jE	zé	jé	zē
P1 incl.	cèesá	*jE-PL			zēg
P2	? sìngé ? sèesá	*SE	kpé	hé	sē
P3	nìngé	*d/dE ?	lìjé	yé	tē

Table 5. Independent personals (Sinyar: subject pronouns)

	Sinyar	*SBB	Modo	Bongo	Gula Zura
S1	m-	*m(ǎ)- H	m- H	m(í)-	m(ǎ)- H
S2	n-	*(í)- H	ø- H	(í)-	ø- H
S3	ø/w-	*ø- B	ø- B	<i>masc.</i> b(í)- <i>fem.</i> h(ó)- <i>neutral</i> (ù)-	ø- B
P1 excl./dual	c-	*d/j(ǎ)- B	d- B	j(í)- ~ -jé	z(ǎ)- B
P1 incl.	c-...-sà	*d/j(ǎ)- B ...-(?)			z(ǎ)- B ...-gǎ
P2	n-...-sà	*(í)- H ...-(?)	ø- H ...-ké	h(í)- ~ -hé	ø- H ...-gǎ
P3	ø...-(V)n	*ø- B ...-(?)	ø- B	y(í)-...-H	ø- B ...-gǎ

Table 6. Personal subject indices on verb (Aorist)

	Sinyar	Modo	Bongo	Gula Zura	Yulu	Sar
S1	m-úŋ	m-únyù	m-óʔŋ	m-ás̄	m-òosè	m-ésà
S2	n-úŋ	únyù	óʔŋ	ás̄	òosè	ésà
S3	wíŋ	ùnyù	<i>masc.</i> bóʔŋ <i>fem.</i> hóʔŋ <i>neutral</i> èŋ	ás̄	òosè	èsà
P1 excl./dual	c-úŋ	d-ùnyù	j-óʔŋ ~ èŋ-jé	z-ás̄	j-òosè	j-èsà
P1 incl.	c-úŋ-sà			z-ás̄-gǎ	j-òosè-kē	j-èsà-ī
P2	n-úŋ-sà	únyù-ké	h-óʔŋ ~ óʔŋ-hé	ás̄-gǎ	òosè-kē	ésà-ī
P3	wíŋ-ín	ùnyù	y-óʔŋ	ás̄-gǎ	òosè-kē	èsà-ñ

Table 7. Conjugations of verb 'to eat' (Aorist)

3. Verbal derivatives

i. Sinyar infinitive prefixed with **ø-** (consonant initial verbs) or **t-** (vowel initial verbs):

- (1) **ɖaar** 'look at' > inf. **ɖáár**
maggal/mangal 'steal' > inf. **màggàl**
ika 'seize' > inf. **t-íká**
urku 'climb' > inf. **t-úrkú**

SBB languages derive infinitives with **ø-** (consonant initial verbs) or a consonant (modo **t-**, yulu **l-**, others **k-**) in case of vowel initial verbs:

- (2) Modo (no consonant initial verb)
unyù 'eat' > inf. **t-únyù**
Yulu
kēemō 'fear' > inf. **kēem(ō)**
èedō 'see' > inf. **l-èed(ō)**
Gula Zura
túv̄ 'spit' > inf. **túv̄**
èt 'open' > inf. **k-èt**

Sar
mbātá ‘refuse’ > inf. **mbātá**
àsō ‘fall’ > inf. **k-àsō**

ii. Sinyar derive adjectives by prefixing **k-** to vowel initial verbs:

- (3) **affa** ‘be sharp’ > **k-áffá** ‘sharp’
abbal ‘be red’ > **k-àbbàl** ‘red’

This is probably also an old feature of SBB languages although the device has become lost (or frozen) and maybe merged with the **k-** formative of infinitives/nouns in many ‘western’ languages (like Gula Zura, Bagiro, and Sar):

- (4) Modò¹
èyí ‘be cold’ > **k-èyí** ‘cold’
 Bongo
èmbì ‘be fat’ > **k-èmbì** ‘fat’
 Yulu
njèʔá ‘dry up’ > **njèʔ(á)** ‘dry’
ēyà ‘be wide’ > **k-ēy(à)** ‘wide’
 Gula Zura
èd ‘rain (v.)’ > **kéd** ‘rain (n.)’
āc ‘be/become red, ripe’ > **kāc** ‘redness (?)’
 Bagiro
àsū ‘be bad’ > inf. **k-àsū**; **k-àsū** ‘badness, bad’
 Sar
***aKε** ‘be red’ > **kàsə** ‘brown red’

4. Subject focalizer

Both Sinyar and Yulu share a verb prefix **k(V)-** to mark focus on the subject:

Sinyar

- (5) **mùsù-n** **wìŋ-m'à-tá**
 hunger:NOM:SG hurt-S1:ACC-NEG
 ‘I am not hungry.’

- (6) **ìngá-n** **k-ùŋ-l'á**
 what?:NOM:SG FOC-hurt-S2:ACC
 ‘WHAT does hurt you?’

Yulu

- (7) **bīisá** **òosə** **èjə**
 dog:DEF S3:eat meat:DEF
 ‘The dog ate the meat.’

- (8) **bīisá** **k-òosə** **èjə**
 dog:DEF FOC-eat meat:DEF
 ‘The DOG ate the meat.’

¹ Andersen (1981:48) analyses these forms as dependent verbs (prefixed with **k-**) that may be regarded as shortened relative clauses when used in this way.

5. Noun plural in (-ɲà) (Sinyar only)

Common plural marker **-ɲà** (cp. Fur?). May be dropped if number marked otherwise (irregular plural suffix **-aar** or plural case marker, see below). Examples:

- (9) **ɲà** /pl. **ɲà-ɲà** ‘thing’
gòl /pl. **gòl-ɲà** ‘stone, grindstone’
kártí /pl. **kártí-ɲà** ‘elephant’

6. Some noun plurals in -aar (Sinyar only)

Some nouns referring to animates have a special plural marker **-aar**. Examples:

- (10) **nímmí** /pl. **nìmàar(-ɲà)** ‘sister’
ngùbbò /pl. **ngùbàar(-ɲà)** ‘old woman’
ɓìsì /pl. **ɓìsàar(-ɲà)** ‘dog’
ɗòŋ /pl. **ɗòŋàar(-ɲà)** ‘bull’
kòɗɗù /pl. **kòdáar(-ɲà)** ‘ram’

7. Double radical-verbs (Sinyar only)

Some Sinyar verbs have two complementary radicals following a ‘non-past/past’ (or ‘imperfective/perfective’?) distribution of the TAM form. In most cases the 2^d radical is characterized by some affixation of a nasal element. Examples:

- (11) **erbi/ermbi** ‘run’
sudò/sunjo ‘lie (down)’
wife/wipe ‘beget, bear’
ɗup/ndup ‘crunch (fruit, vegetable)’
juwe/njuwe ‘cut (with knife)’
ugo/ungon ‘meet, find, get’

	‘to run’	‘to cut’	‘to find, get’
Present	érbí	jùw^è	úgó^ʌ
Future	érbí (= Present)	júwé^ʌ	úgó^ʌ (= Present)
Recent past (?)	èrmb^ʷ	njúwé	ùngóp
Far past 1 (?)	èrmbìy^ʷà	njúwá^ʷà	ùngóŋ^ʷà
Far past 2 (?)	èrmbàándí	?	?
Imperative (2 ^d sg.)	èrb^ʷ	jùw^è (?)	ùgò
Prohibitive (2 ^d sg.)	k-érbí-tá	kù-jùwè-t^ʷà	k-úgó-t^ʷà

Table 8. Distribution of radicals according to TAM forms (3^d pers. sg.)

8. Factitive verbs suffixed with -oo/-uu (Sinyar only)

Examples:

- (12) **anju** ‘not have’ **anjuu** ‘let not have’
arfa ‘be dry’ **arfoo** ‘let dry, make dry’

ette ‘burn’	ettoo ‘let burn’
icel ‘be/become full’	iceluu ‘fill, make full’
ndolle ‘learn’	ndooluu ‘make learn, teach (ditransitive)’

9. Intensive/frequentative in -r- (Sinyar only)

Infix **-r-** (mostly frozen?) expressing intensivity or frequency of the process (active verbs).
Examples:

- (13) ? > **arja/arnja** ‘show, explain’
dekke/ndekke ‘kick, lash out’ > **derke/nderke** ‘kick (frequentative)’
? > **erce** ‘whip’
uba/umba ‘make, mould (pot)’ ? > **urba/urmba** ‘weave (basket, fishtrap, fit with ropes (bed)’
? > **urgo/urngo** ‘wash (body, body part)’ (cp. SBB *?**igbo** ‘wash’)
? > **urku** ‘climb’ (cp. SBB ***oku**/***eki** ‘climb’)
? > **werji/wernji** ‘urinate’ (cp. SBB ***Sađi** ‘urinate’)
? > **werse** ‘sew’ (cp. SBB ***isa**)
? > **wirca** ‘(let) fry’ (cp. SBB ***EkE**/***ika**/etc. ‘catch, seize’)
? > **wirja/wirnja** ‘tie, bind’ (cp. SBB ***uđa** ‘bind, tie up’)
? > **wirji/wirnji** ‘remain, stay, sit down’

10. Double case marker system (Sinyar only)

- i. Nominal phrases whose head = common noun (including interrogative ‘what?’):
unmarked (= Absolute) / Nominative / Adverbial²

	Absolute form	Nominative	Adverbial
Sg.	∅	-n / -Ni	-ti
Pl.		-si	

Table 9. Case markers (postpositions) for common noun phrases

- ii. Nominal phrases whose head = proper name, deictic, or personal pronoun:³
unmarked (= Absolute)⁴ / Nominative / Genitive / Accusative / Adverbial

	Absolute form	Nominative	Genitive	Accusative	Adverbial
Sg.	∅	-n / -lè	-na (L)	-(y)àa (H)	-lèe (H)
Pl.		-ngè (H)		-ngàá (H)	-ngèer (H)

Table 10. Case markers (postpositions) for proper name phrases (and assimilated)

Proper names include:

- personal names (also personified animals), ‘God’, ‘chief’, ‘grandmother’, names of places, rivers, mountains, and countries;
- ‘who?’, ‘what’s-his/her-name, So-and-So’;

² Adverbial = locative, instrumental, and comitative.

³ Deictics and personal pronouns have forms of their own that are not displayed here.

⁴ Proper names only.

- some animal names: ‘(home) cat’, ‘(home) duck’, ‘fox’, ‘owl sp.’, ‘bird sp.’, ‘stork’, ‘locust sp.’ (2x), ‘chameleon’, ‘fish sp.’;
- points of the compass borrowed from Arabic.

Case markers usually distinct for number.

Appear at the end of the nominal phrase (order: head–modifiers) = postpositions.

Examples:

- (14) **kàjjà-n ámbíy'à**
sun-NOM:SG 3:go:PF
‘The time is over’ (lit. the sun has gone)
- (15) **bís-lè èrmbìy'à nùnnúù**
cat-NOM:SG 3:run:PF far_away
The (our) cat run away.’
- (16) **àkìp'in kúurà**
3:play:PL ball[Ar.]
‘They play ball.’
- (17) **nààlé fùggòl.bí Zàkàríyàa**
S3:NOM 3:be_tall.pass Zakariya:ACC:SG
‘He is taller than Zakariya.’
- (18) **ǎà-ǎà Kùnyaa-nà-sì wèèpinn'aa firàngà**
father-PL Kunyaa-GEN:SG-NOM:PL 3:come:PL:PF yesterday
‘Kunyaa’s fathers have come yesterday.’

11. Genetic relationship or contact: which historical scenario?

SBB-like	SBB-unlike
<ul style="list-style-type: none"> • part of the lexicon (including ‘basic’) • part of the personal pronouns • personal indices 2 & 3 distinguished for number plural suffixes on the verb • infinitive in t- (?) (vowel-initial verbs) • adjectives in k- (vowel-initial verbs) • subject focalizer in k(V)- 	<ul style="list-style-type: none"> • part of the lexicon (including ‘basic’) • no tonal alternation on verbs • noun plural in (-ǎà) • some noun plurals in -àar (animates) • many double (related) radicals for verbs • Intensive/frequentative in -r- • factitive verbs suffixed with -oo/-uu • double case marker system

Table 11. Summary: Sinyar features compared to SBB

2 historical hypotheses:

- Sinyar is a historically SBB language (substrate = SBB) that came into contact with another language/group of languages (but which one?) and consequently
 - replaced part of its lexicon,
 - lost the tonal alternations on verbs,
 - acquired new morphological features (nominal plurals, double verb radicals, original factitives),
 - integrated a double system of case markers (including several sets of deictics and personal pronouns according to case).

- ii. Sinyar is a historically foreign language (substrate unidentified) that came into contact with SBB languages (more likely of the Yulu-Gula type, its actual neighbours) and consequently
- replaced part of its lexicon while preserving its own ways of marking plural nouns,
 - integrated part of the SBB personal pronouns/indices and verb morphology (namely verb plural, infinitive, adjectives, subject focalizer), but did not acquire verb tonal alternations and preserved a specific part of the verb morphology (some double radicals, factitive),
 - preserved its own system of case marking.

In the current state of things, and without any clue concerning the possible socio-historical development of these languages, it is uncertain which explanation is the most likely. The following elements should be investigated more deeply:

- origin/affiliation of the non-SBB vocabulary (if not an isolate?),
- tonal systems (Sinyar has a two-tone system with numerous downstepped Lows; ‘western’ SBB languages have no less than three distinctive levels); tone classes of Sinyar verbs correspond to some extent to those of the SBB languages; tonal identity of Sinyar nouns needs further study,
- distribution of similar vocabulary within SBB,
- specific form of the similar lexical units, that sometimes display features not compatible with regular correspondences.

Glosses and abbreviations

ACC	Accusative	FOC	Focalizer (of subject)	PF	Perfective
Ar.	Arabic	GEN	Genitive	PL	Plural
DEF	Definite	incl.	inclusive	S2	2 ^d person sing.
excl.	exclusive	masc.	masculine	S3	3 ^d person sing.
fem.	feminine	NOM	Nominative	SG	Singular

References

- Andersen T., 1981, *A Grammar of Modo, A Preliminary Sketch*, University of Aalborg (Denmark).
- Boyeldieu P., 2000, *La langue bagiro (République Centrafricaine), Systématique, textes et lexique*, Frankfurt am Main, Peter Lang, (Schriften zur Afrikanistik/Research in African Studies, 4).
- Boyeldieu P. et P. Nougayrol, 2004, Les marques personnelles des langues SBB : traits systématiques et perspectives historiques, *Systèmes de marques personnelles en Afrique* (D. Ibrizimow et G. Segerer éd.), Louvain-Paris, Peeters (Afrique et Langage), 23-42.
- Boyeldieu P., P. Nougayrol & P. Palayer, 2006, *Lexique comparatif historique des langues sara-bongo-baguirmiennes*, Paris, CNRS-LLACAN (document électronique) : [<http://sumale.vjf.cnrs.fr/SBB/>]
- Doornbos P. & M.L. Bender, 1983, Languages in Wadai-Darfur, *Nilo-Saharan Language Studies* (M.L. Bender ed.), East Lansing, Michigan State University (African Studies Center), 42-79.
- Nougayrol P., 1999, *Les parlers gula (Centrafrique, Soudan, Tchad), Grammaire et lexique*, Paris, CNRS Editions.
- Palayer P., 1970, (avec la collaboration de M. Fournier et E. Moundo), *Eléments de grammaire sar (Tchad)*, Lyon-Fort-Archambault, Afrique et Langage-Collège Charles Lwanga (Etudes linguistiques 2).
- Palayer P., 1992, *Dictionnaire Sar-Français (Tchad)*, Paris, Geuthner.