



HAL
open science

Study of the medieval mining tools at Castel-Minier, France, in the European context between the 14th and 15th centuries

Jean-Charles Méaudre, Florian Téreygeol, Manon Gosselin, Philippe Dillmann

► To cite this version:

Jean-Charles Méaudre, Florian Téreygeol, Manon Gosselin, Philippe Dillmann. Study of the medieval mining tools at Castel-Minier, France, in the European context between the 14th and 15th centuries. *Acta rerum naturalium*, 2023, 28, pp.69-83. halshs-04697827

HAL Id: halshs-04697827

<https://shs.hal.science/halshs-04697827>

Submitted on 14 Sep 2024

HAL is a multi-disciplinary open access archive for the deposit and dissemination of scientific research documents, whether they are published or not. The documents may come from teaching and research institutions in France or abroad, or from public or private research centers.

L'archive ouverte pluridisciplinaire **HAL**, est destinée au dépôt et à la diffusion de documents scientifiques de niveau recherche, publiés ou non, émanant des établissements d'enseignement et de recherche français ou étrangers, des laboratoires publics ou privés.

Study of the medieval mining tools at Castel-Minier, France, in the European context between the 14th and 15th centuries

JEAN-CHARLES MÉAUDRE¹, FLORIAN TÉREYGEOL¹, MANON GOSSSELIN¹, PHILIPPE DILLMANN¹

¹IRAMAT-LAPA, NIMBE, CEA, CNRS, Université Paris-Saclay, France, e-mail: jean-charles.meaudre@cea.fr

Abstract: Castel-Minier, located in the French Pyrenees, was a polymetallic production site where silver, lead and copper using ores extracted on-site and from neighbouring valleys were produced by metallurgists from the 13th to 15th centuries. Through necessity and opportunism, they also produced iron for export and on-site use. The archaeological excavations carried out over the last twenty years have brought to light a series of tools associated with mining, including chisels, which are emblematic tools of miners. These chisels represent rare specimens in Western Europe for this period and are the only ones discovered in the French Pyrenees. We describe these discoveries and then focus on the chisels to highlight the durability and variability of the manufacturing methods of these tools. Indeed, different skills have been used on the site.

Abstrakt: Castel-Minier, situovaný ve francouzských Pyrenejích, byl polymetalické výrobní místo, kde hutníci vyráběli stříbro, olovo a měď za použití rud vytěžených na místě a ze sousedních údolí od 13. do 15. století. Z nutnosti a oportunistu také vyráběli železo na vývoz i místní použití. Archeologické vykopávky provedené během posledních dvaceti let přinesly na světlo řadu nástrojů spojených s těžbou, včetně dlát jako emblematických nástrojů horníků. Tato dláta jsou exempláře pro toto období vzácné v Západní Evropě a jsou jediné objevené ve francouzských Pyrenejích. Tyto objevy popisujeme, pak se na tato dláta zaměříme a zabýváme se odolností a variabilitou výrobních metod těchto nástrojů. Skutečně byly na tomto místě využívány různé rutiny.

Keywords: Castel-Minier, chisel, galena, iron metallurgy, mine, non-ferrous metallurgy

INTRODUCTION

Castel-Minier was a polymetallic production site situated in the Viscounty of Couserans in the French Pyrenees and isolated in a valley four kilometres upstream from the village of Aulus-les-Bains. From the 13th to 15th centuries, metallurgists produced silver, lead and copper from ores extracted on-site and from neighbouring valleys. Through necessity and opportunism, they also produced iron, using ore extracted from the Rancié mine located in a nearby valley under the control of the Count of Foix. Iron ore crossed the boundaries, despite the historic opposition between the Counties of Foix and Comminges on which the Viscounty of Couserans depended. In 1347–1348, Gaston Count of Foix, the community of Sem and the Viscount of Couserans signed an exchange agreement (Verna 2002, 125). This agreement ratified an exchange of iron ore from Vicdessos (Rancié mine) delivered to the Couserans in exchange for the right to produce charcoal in the forests of the viscounty. Moreover, the archaeometric study conducted confirmed that ore from Rancié was used at Castel-Minier (Leroy 2012).

The main ore extracted at Castel-Minier was galena, a lead ore containing silver. The Castel-Minier site was also characterised by the presence of a group of ores without commercial value such as sphalerite (ZnS). The main host rocks surrounding these ores were schist, a soft rock, as well as dolomite and quartz. Medieval miners excavated schists with tools and used fire settings for

dolomite and quartz. Thus, miners in Castel-Minier used chisels, picks, wedges and hammers. The archaeological excavations carried out over the last 20 years have brought to light a series of tools associated with mining activity, including chisels (Fig. 30 and Fig. 31). These chisels constitute rare specimens in Western Europe for this period and the only ones discovered in the French Pyrenees. We describe these discoveries and focus on the chisels, the miner's emblematic tools. We aim to highlight the persistence and variability of the manufacturing methods of these tools.



Fig. 1. Location of Castel-Minier and view of the valley.
Obr. 1. Místo Castel-Minier a pohled do údolí.

The 14th century

The layers dated to the 14th century revealed workshops associated with non-ferrous or ferrous metallurgy, as well as dwellings (Fig. 2). These strata yielded eight chisels, three pointed fragments (pre-prepared or broken-off tips), one hoe and one wedge (Fig. 3 to 5). We discovered two pointed fragments in the upper part of the site (foundry, upper level) (Fig. 3/5–6). These items have a square cross-section of 22 mm. The hoe was associated with a dwelling and is 18 cm long and 9 cm wide. The eye of the hoe has not been preserved (Fig. 5/1). Hoes were primarily used by miners to excavate waste from mines. This can be connected to two finds from

the Altenberg in Westphalia. These similar-sized hoes date to the 13th century (Dahm et al. 1998, Tafel 62. 19/20). We also found five chisels in this area: two worn, two re-forged and one broken (Figure 4) and additionally an 11 cm long wedge in the slag heap area (Fig. 5/2). Similar examples come from the French Alps at Brandes (12th–14th centuries) (Bailly-Maitre, Bruno-Dupraz 1994, 66–67 and Figures 38-39, Bailly-Maire 2019, 132 and figure 107/D). The slag heap was associated with a smelting structure destroyed during the construction of the castle in the late 14th century. We discovered three chisels in this area, including the strongly deformed chisel CL12470 and one pointed fragment (Figure 3/1-4).

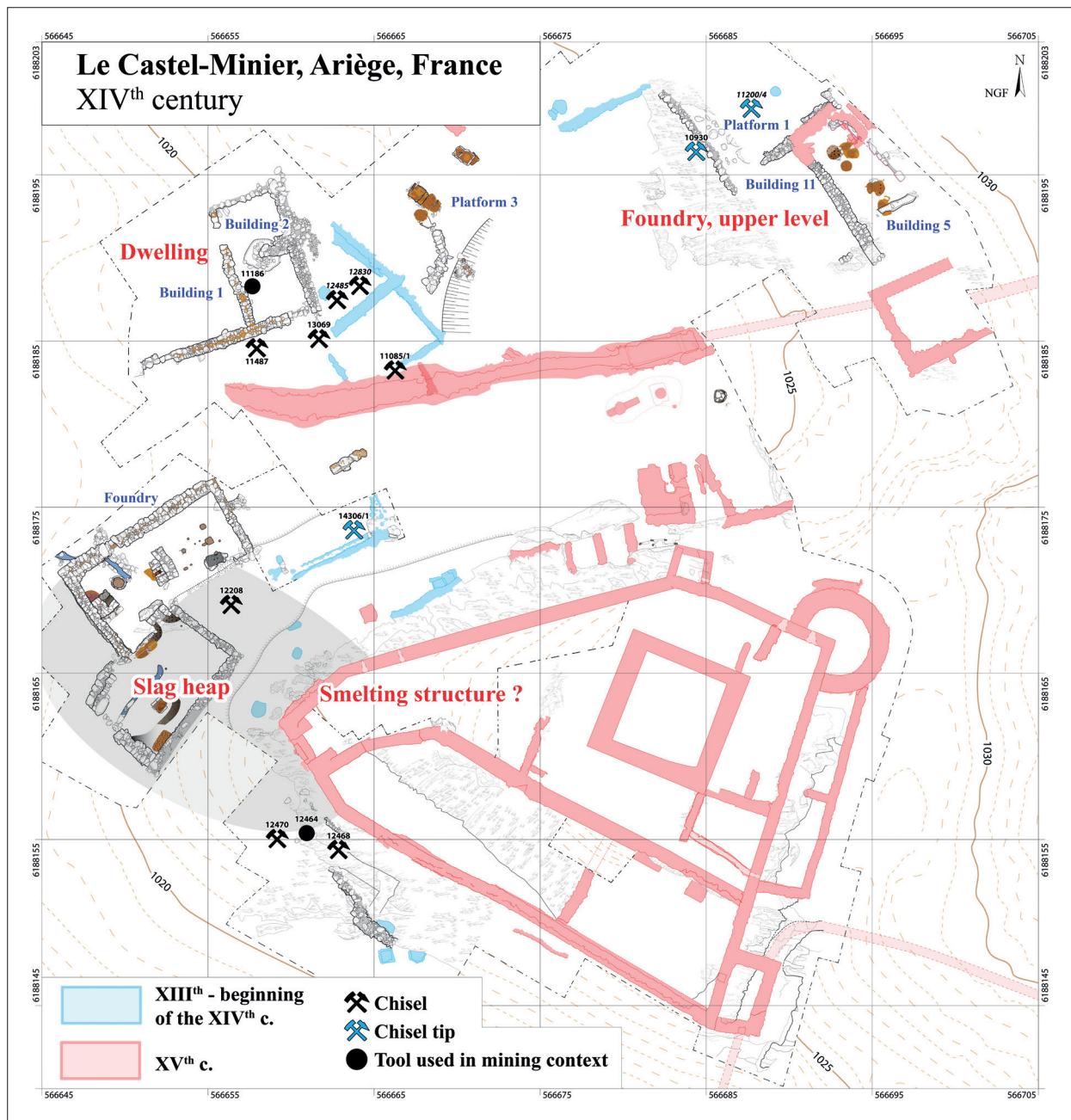

Fig. 2. Castel-Minier, structures dated to the 14th century.
Obr. 2. Castel-Minier, stavby datované do 14. století.

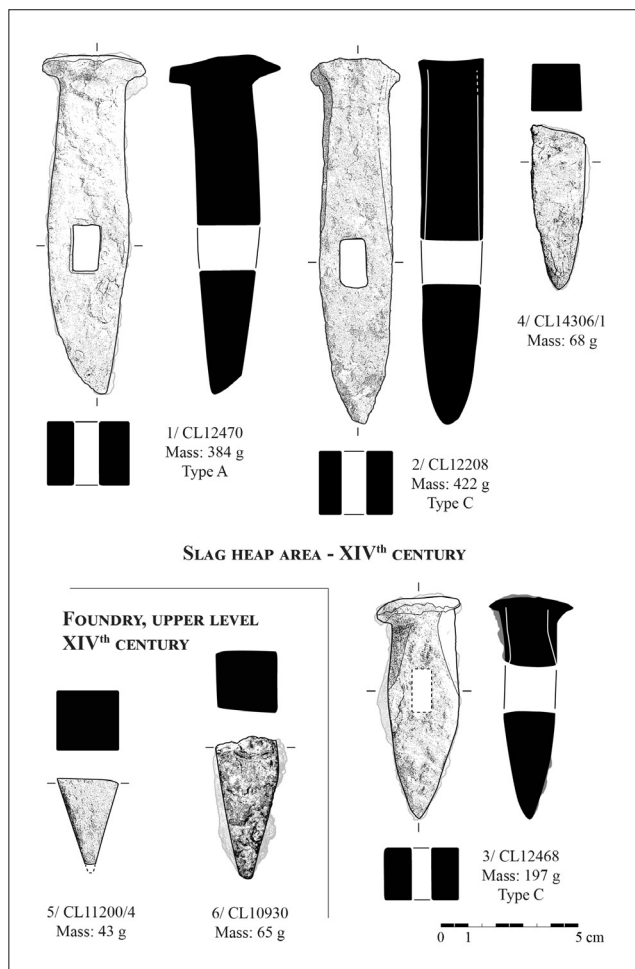

Fig. 3. Castel-Minier, chisels and tips dated to the 14th century.
Obr. 3. Castel-Minier, dláta a hroty datované do 14. století.

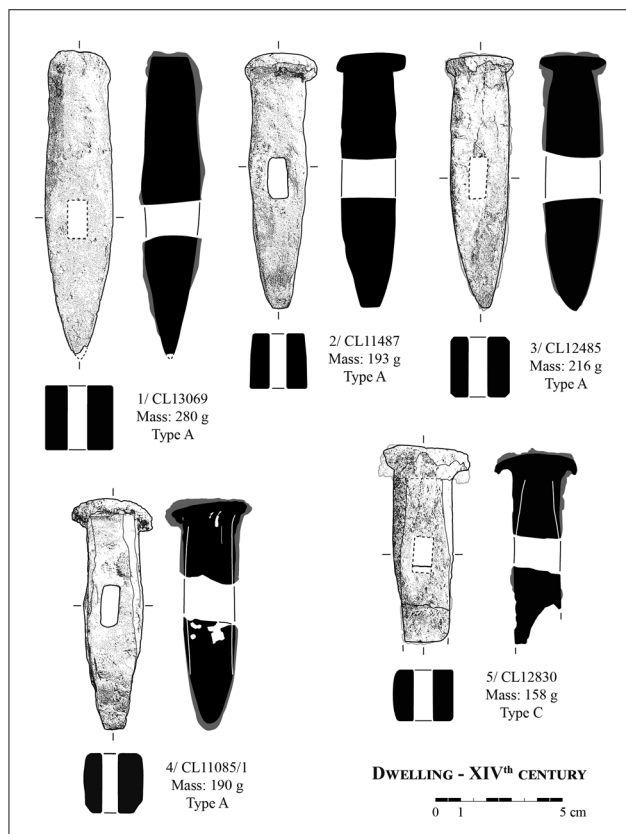

Fig. 4. Castel-Minier, chisels from the dwelling dated to the 14th century.
Obr. 4. Castel-Minier, dláta z obydlí datovaná do 14. století.

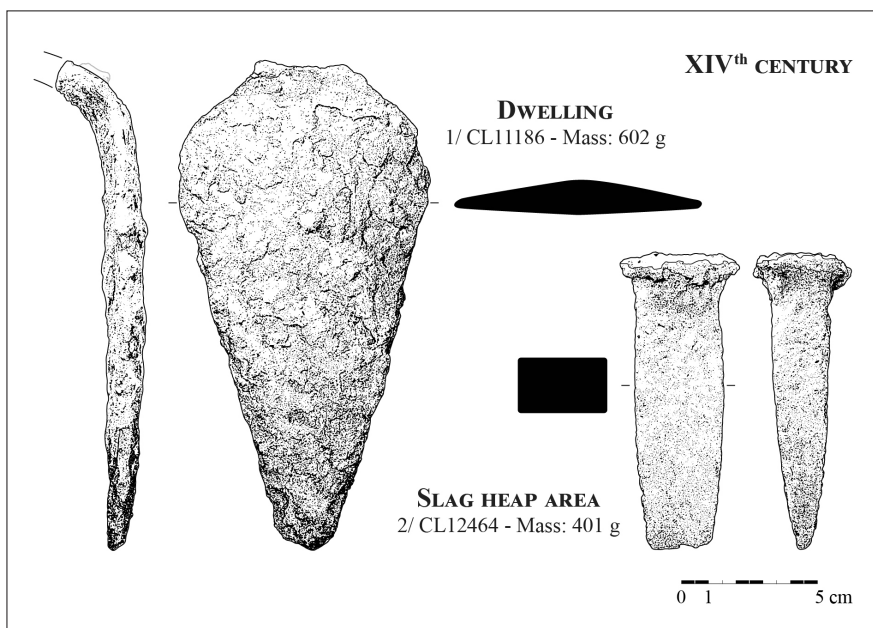

Fig. 5. Castel-Minier, tools dated to the 14th century.
Obr. 5. Castel-Minier, nástroje datované do 14. století.

The 15th century

The 15th century is characterised by the presence of a castrum (Fig. 6). The construction of the castrum followed the takeover of the site by the Viscount of Couserans where a dwelling and a foundry coexisted. Additionally, they established an assayer's workshop to the north of Castel-Minier. Metallurgists intensified iron production with the implementation of a new smelting furnace and a water-powered hammer. All the layers dated to the 15th century yielded many more items, including chisels, pointed fragments (pre-prepared or broken-off tips), chisel scraps, tools used in a mining context (such as a pincers, a miner's lamp, a sledgehammer and axes), as well as some hardware, chain links and a wooden trough.

Les Ouels mining area is located in front of Castel-Minier (Fig. 1). The discoveries made in this area date from its last period of exploitation, i.e. from the second half of the 15th century. We can divide the discoveries made in this area into two groups. The first group includes finds from the

dewatering gallery, which was only connected to the mining network during the modern exploitation attempt (1864–1867) (Téreygeol 2015, 26). Among the twenty-six chisels found in this gallery, one notable set stands out: nine concretion chisels (Fig. 7 and 8). These tools, ready for use, constituted a batch, as shown by their positioning and the remains of the leather used to bind them. Although probably incomplete, this batch corresponds to the daily consumption of a miner. A comparison can be made with the Pampailly mine located in France (Rhône). The mine regulations published in 1455 set the daily consumption of chisels for a miner at twelve (Benoit 1997, 59). The Kutná Hora Hymn Book (1490) also shows a miner with a set of tools tied around his waist.

We found only two handle fragments associated with the chisels, and these were made of wood. However, it is impossible to determine the size and type of wood. The mines also yielded several waterlogged wooden tool handles but, unfortunately, it is impossible to link them to any particular type of tool.

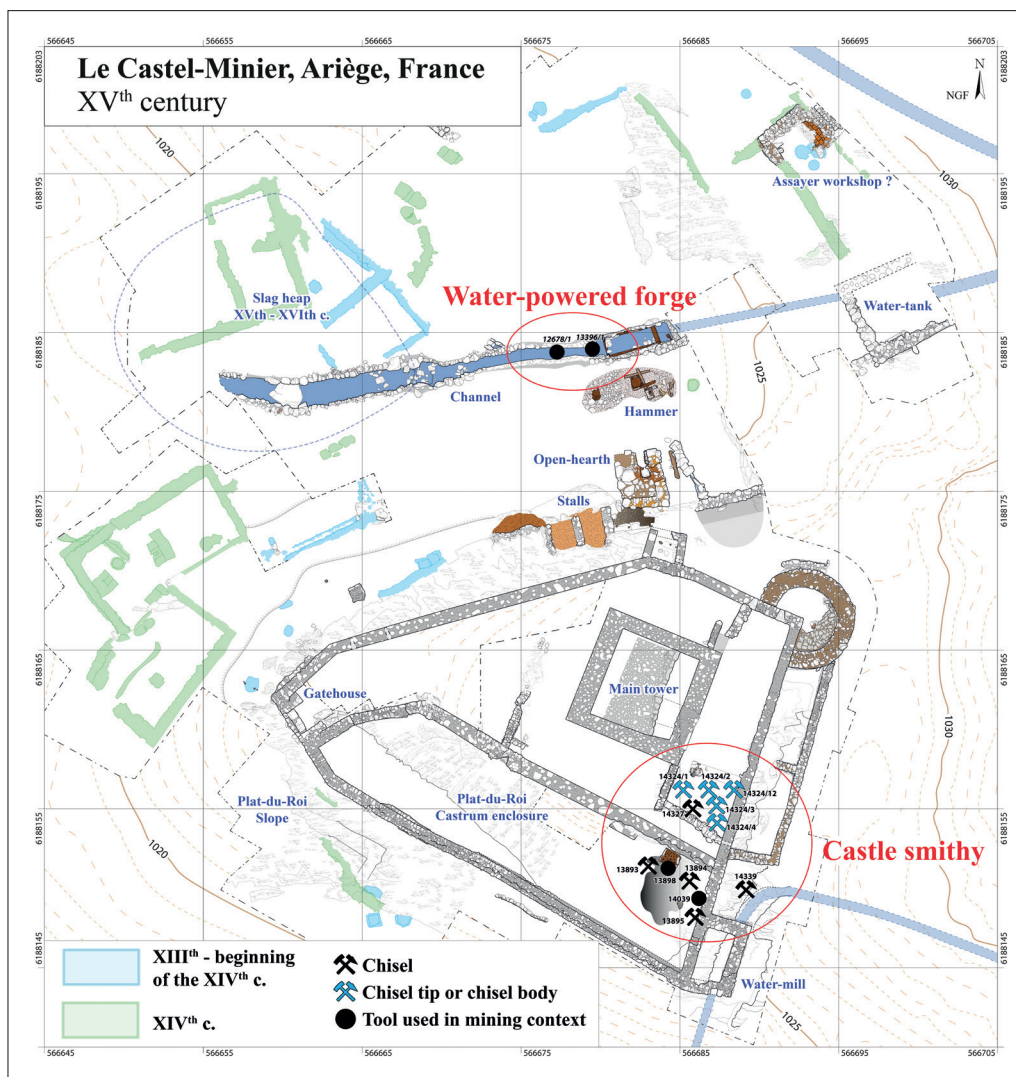

Fig. 6. Castel-Minier, structures dated to the 15th century.
Obr. 6. Castel-Minier, stavby datované do 15. století.

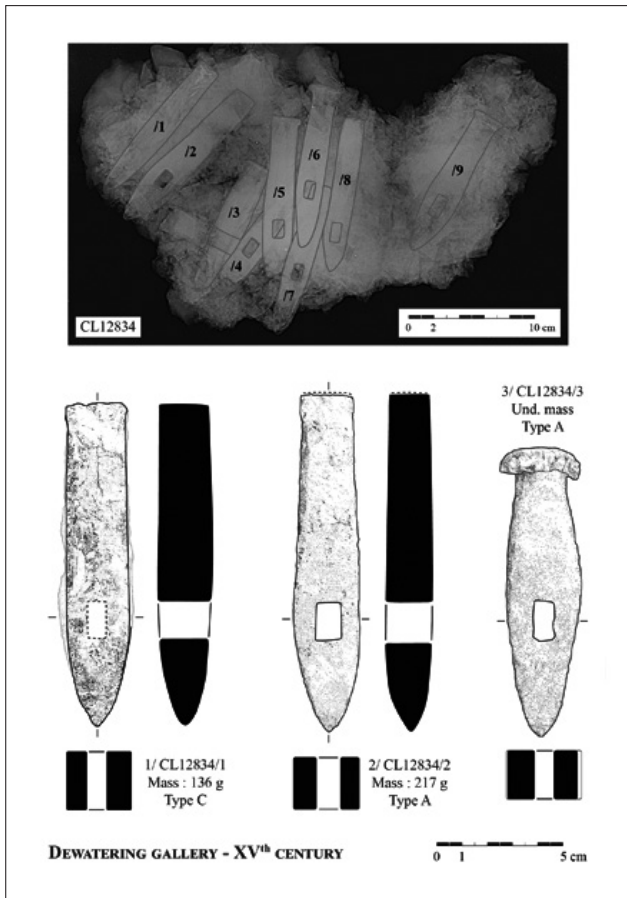

Fig. 7. Les Ouels, chisels from the dewatering gallery, 15th century.
Obr. 7. Les Ouels, dláta z odvodňovací štoly, 15. století.

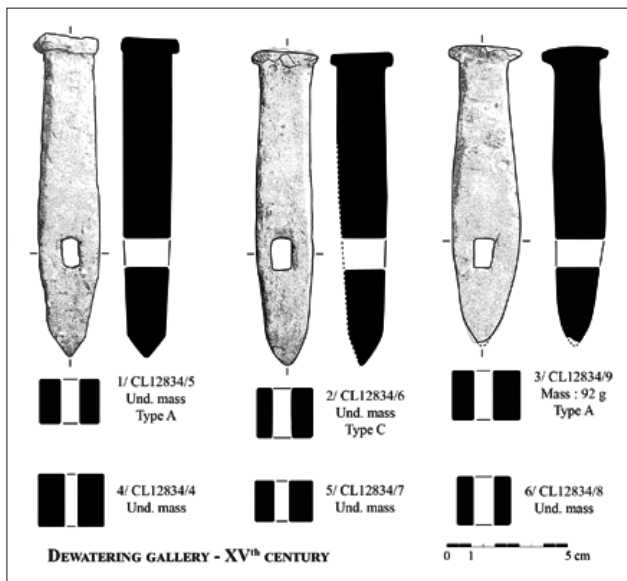

Fig. 8. Les Ouels, chisels from the dewatering gallery, 15th century.
Obr. 8. Les Ouels, dláta z odvodňovací štoly, 15. století.

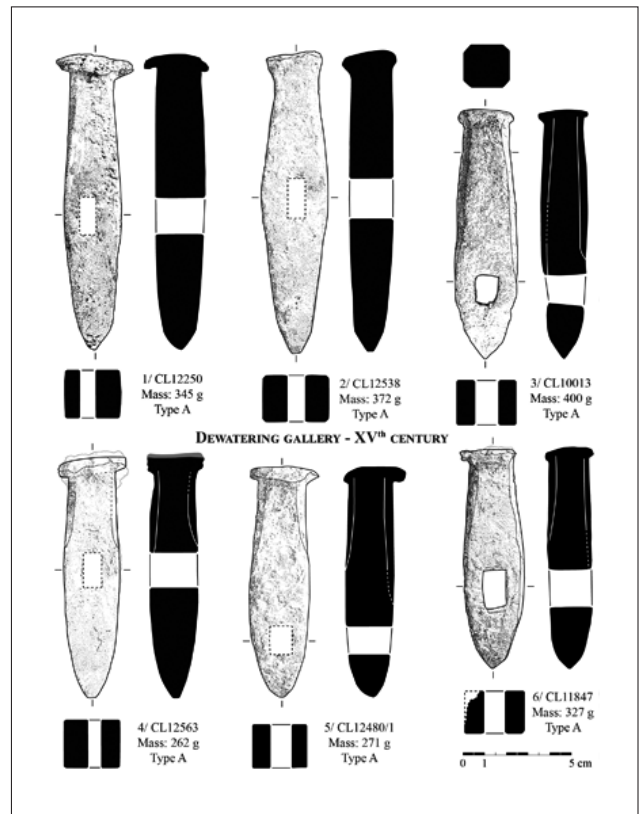

Fig. 9. Les Ouels, chisels from the dewatering gallery, 15th century.
Obr. 9. Les Ouels, dláta z odvodňovací štoly, 15. století.

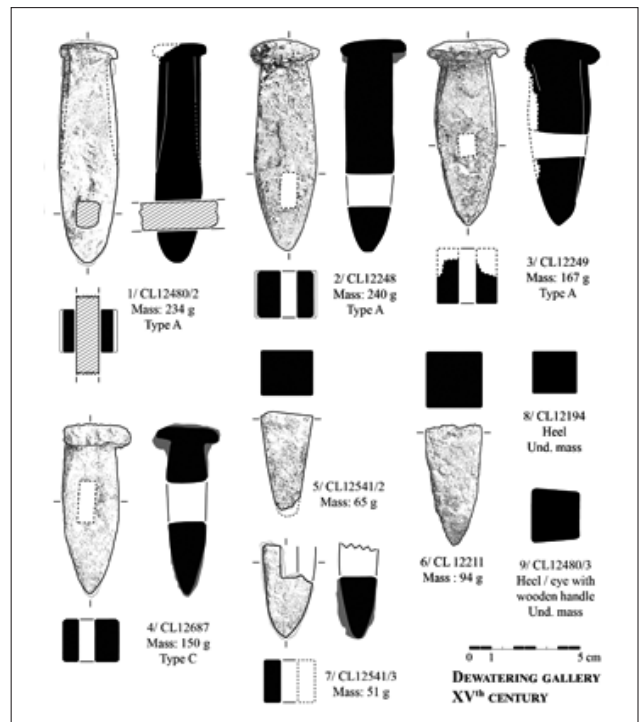

Fig. 10. Les Ouels, chisels from the dewatering gallery, 15th century.
Obr. 10. Les Ouels, dláta z odvodňovací štoly, 15. století.

We also found two picks in the dewatering gallery (Fig. 11). However, compared to the chisels discovered at Castel-Minier, this tool is under-represented. The use of picks can be seen in the details of the Freiburg im Breisgau miner's stained-glass window (1320–1330) (Goldenberg, Frölich 2006, 8). One of the picks has two tips (Fig. 11/1), while the other only shows a worn one (Fig. 11/2). A third pick discovered in the slag heap area could be added, although this tool is difficult to interpret.

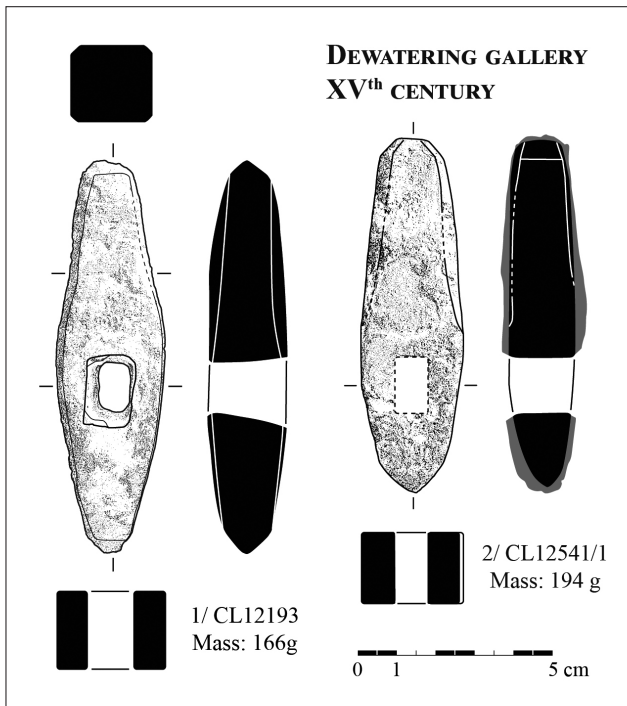

Fig. 11. Les Ouels, picks from the dewatering gallery, 15th century.
Obr. 11. Les Ouels, krumpáče z odvodňovací štoly, 15. století.

An ore trough was also uncovered in the dewatering gallery (Fig. 12), which is a monoxyle trough, 44 cm long and 22 cm wide. Two quadrangular holes are visible, indicating probable repairs. We estimate that the complete object was 61 cm long, 22 cm wide and 10 cm high. Agricola (1556a, VI, 121) mentioned a length of 2 feet and a width of 1 foot for a small trough (*alveus minor*), which closely corresponds to the object found at Les Ouels. Miners used this trough to take ore out of the underground as can be seen in the Kutná Hora Hymn Book. The preserved end has a fold in the upper part with a lower bulge to improve the hand grip. This grip bulge is not shown in Agricola's illustration, which emphasises the monoxyletic nature and coarse size of the object. The trough is one of the oldest known examples and the only one found in the Pyrenees.

The second group includes two adits. Adit +21 served as a means of circulation for the miners. We discovered hardware elements, namely nails, pins, flat bars and an angle iron associated with pincers (Fig. 13). These elements, some of which were found in situ, bear witness to the use of iron for

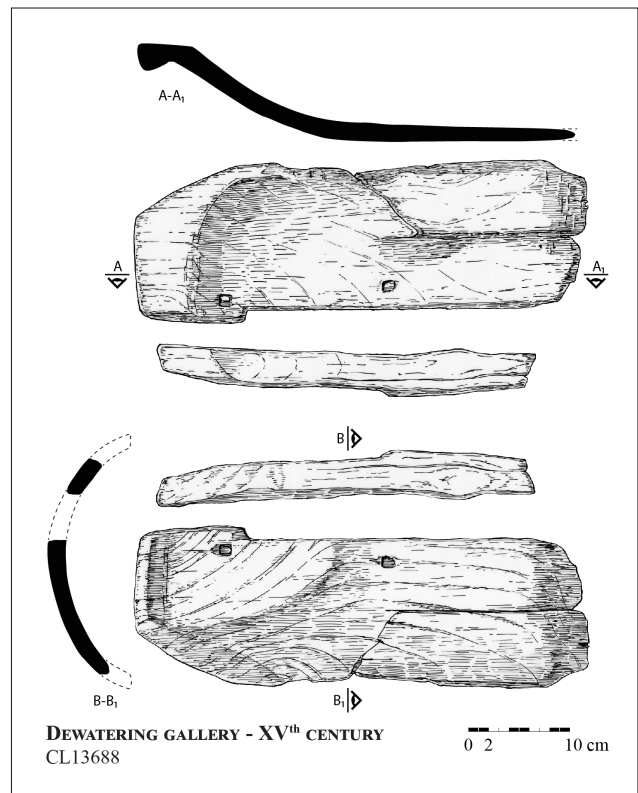

Fig. 12. Les Ouels, a wooden trough from the dewatering gallery, 15th century.
Obr. 12. Les Ouels, dřevěné koryto z odvodňovací štoly, 15. století.

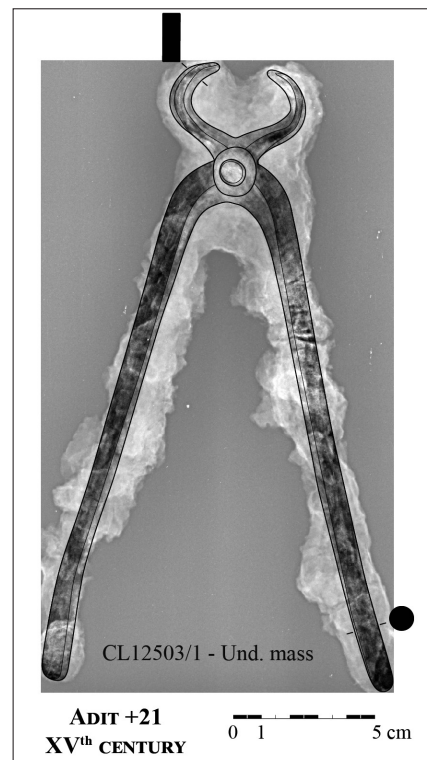

Fig. 13. Les Ouels, pincers from Adit +21, 15th century.
Obr. 13. Les Ouels, kleště ze štoly +21, 15. století.

mining carpentry. Despite the heavy concretion, it was possible to determine the shape of these pincers. It is a 22 cm long tool with jaws with a cross-section of 17×3 mm and levers with a diameter of 9 mm. We found similar hardware in Adit+19, with the addition of chain links (Fig. 14). These items are associated with a lifting device for dewatering. Two timbers, still joined with a flat iron, are probably part of this lifting device (Fig. 15). We found another element probably related to this device (CL12657), which is an 18 cm long, 4 cm wide (at most) and 1 cm thick trapezoidal flat piece. The piece has two square holes and is welded to another piece, which is 25 cm long, 4 cm wide and 2.5 cm thick. These two elements are connected at an angle of about 50 degrees, making their function enigmatic.

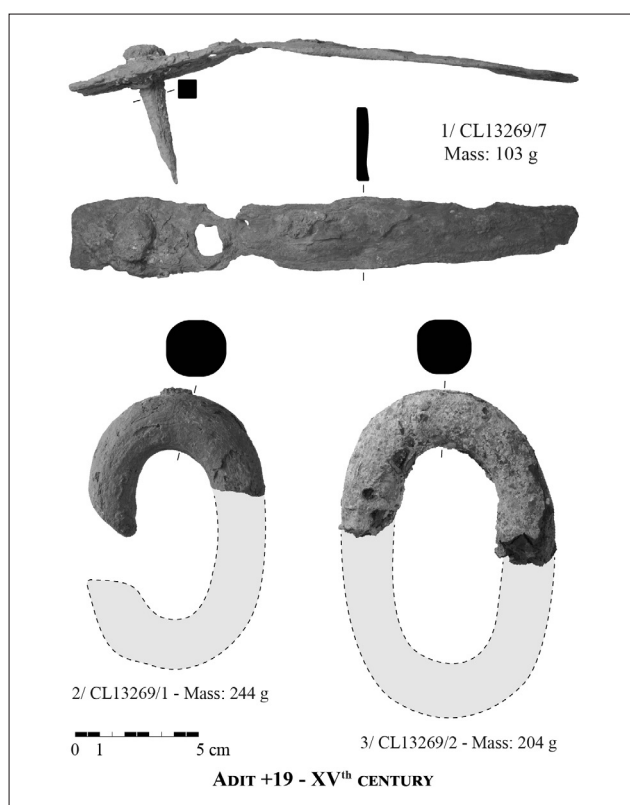

Fig. 14. Les Ouels, hardware from Adit +19, 15th century.
Obr. 14. Les Ouels, technické vybavení ze štoly +19, 15. století.



Fig. 15. Les Ouels, timbers joined with a flat iron from Adit +19, 15th century.
Obr. 15. Les Ouels, dřeva spojená s plochým železem ze štoly +19, 15. století.

Metallographic examinations were performed on the fragments of a hook and a ring with a circular cross-section (Gosselin 2021, I, 402–412 and II, 272–276). Their respective diameters are 25 and 20 mm, similar to the same type of circular cross-section produced at Castel-Minier. Their nature and method of shaping are also similar. The metal consists of an alternation of carburised and ferritic zones and was shaped by the gradual folding and hammering of a flat piece of iron.

We also discovered on the surface workshops, specifically in the water-powered forge raceway, further evidence of carpentry work: two pieces of axes (*marlana ferri*) (Fig. 16). The metallographic analysis of the small fragment reveals longitudinal-axis welding of two types of steel (Gosselin 2021, I, 412 and II, 270–271).

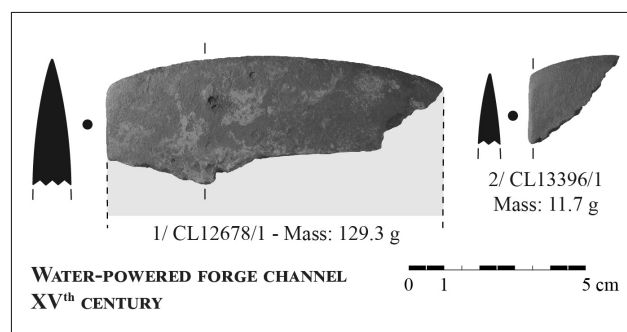

Fig. 16. Pieces of axes from the water-powered forge channel, 15th century.
Obr. 16. Kusy seker z kanálu vodou poháněné kovárny, 15. století.

During excavations of the castrum, we uncovered a set of five re-forged or broken chisels (Fig. 17), three tips (pre-prepared or broken off) and two scraps of square-section bars (Fig. 18). This set is evidence of the presence of a smithy dedicated to mining activities inside the castle foundry. The discovery of a sledgehammer also supports the existence of a blacksmith's smithy (Fig. 19/2). The discovery of a miner's lamp reinforces the connection with the mining activity (Fig. 19/1). This was a tall lamp similar to discoveries made in Brandes in the Alps and Saint-Laurent-le-Minier located in Le Massif Central (Bailly Maitre 2019, 136–137).

The chisels found in the castle smithy are particularly intriguing (Fig. 17). One of the tools, larger than usual, has a potential rectangular maker's mark (Fig. 17/1). However, this is far less sophisticated compared to the marks visible on tools found in Bohemia-Moravia (Hrazdil et al. 2007, Fig. 14) and in Samson (1542–1610) (Sainte-Croix-aux-Mines, Haut-Rhin) (Conin et al. 1995, 376–377, fig. 10). Another tool, although hugely deformed, is characterised by its small size (Fig. 17/3). These two items represent the upper and lower limits of our corpus in terms of the basic forms encountered. One chisel shows a welded sheet on the heel, a probable but difficult-to-understand repair attempt (Fig. 17/2). This tool also has a potential circular maker's mark. Finally, one chisel is distinguished by

a break at the heel (Fig. 17/4) rather than the usual locations such as the eye or the tip (Fig. 17/5). The break of CL13893 is the probable consequence of a forging defect. We also discovered three tips (Fig. 18/3-5) and distinguishing between pre-prepared and broken-off tips remains challenging.

The presence of two scrap bars (Fig. 18/1–2), which have a cross-section similar to the chisels (20×20 mm) highlights a production dedicated to mining. Among more than 50 kg of by-products found in the 15th-century water-powered forge raceway, no by-products with this type of square cross-section were discovered. This specific production does not match the production of the forge for export. In contrast, the flat bars, pins and round bars (used for chain links) associated with mining, are similar to those produced at Castel-Minier. These discoveries reinforce the evidence of internal use of some of the products intended for export. A smithy intended for mining tools would thus exist within the foundry, operating alongside while a water-powered hammer.

Focus on the chisels

An interesting question is whether the thirty-eight chisels found in Castel-Minier indicate an evolution in forging practices. First, we will examine their typology, which refers to the shape, followed by their metrology. Finally, based on the results of the metallographic examinations, we will consider how these tools were shaped.

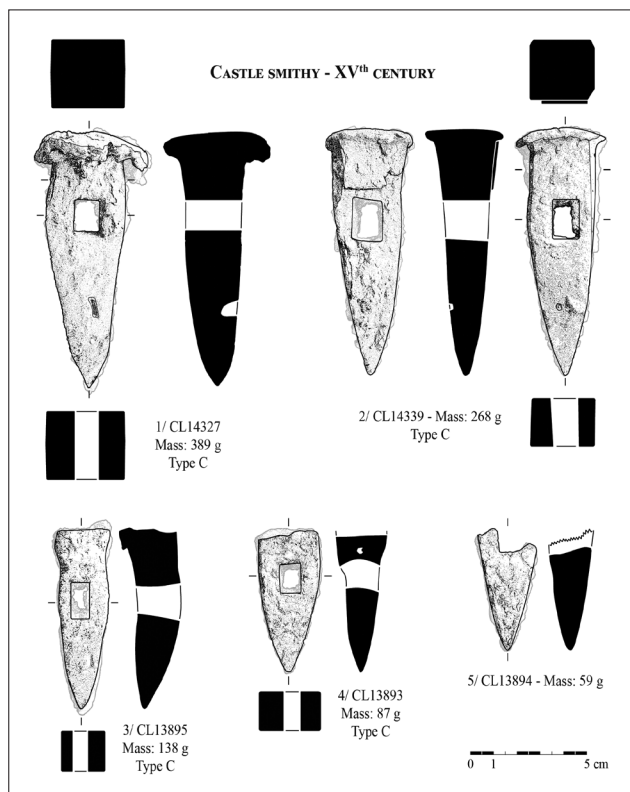

Fig. 17. Castel-Minier, chisels from the castle smithy, 15th century. Obr. 17. Castel-Minier, dláta ze zámecké kovárny, 15. století.

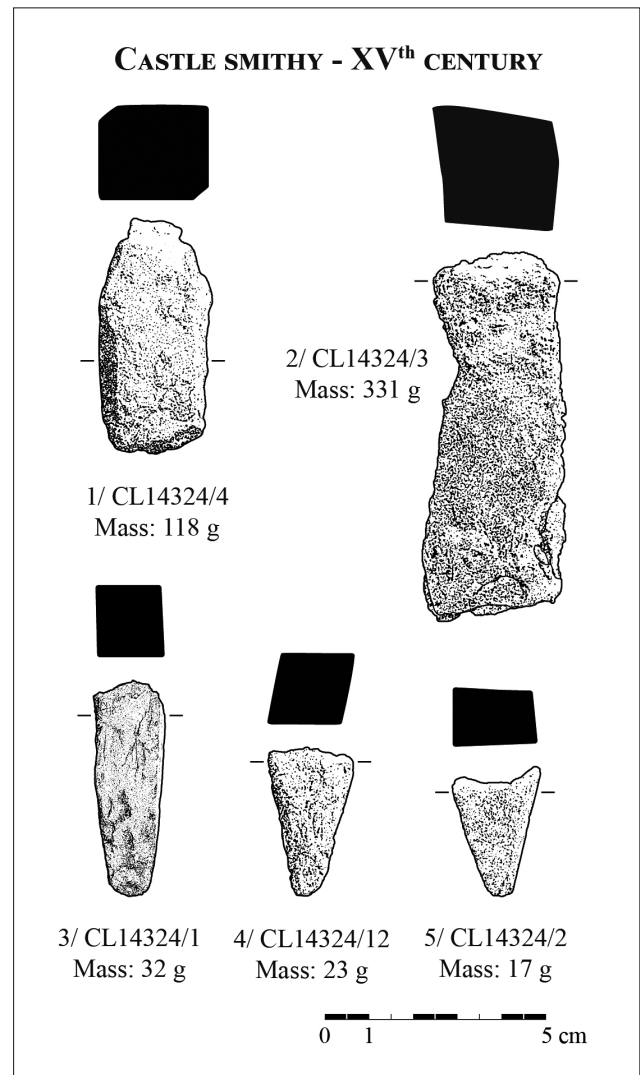

Fig. 18. Castel-Minier, scrap bars and tips from the castle smithy, 15th century. Obr. 18. Castel-Minier, fragmenty tabulí scrap bars a hrotů ze zámecké kovárny, 15. století.

Fifteen years ago, Jan Luna and David Zimola presented a study on mining tools from the central part of the Bohemian-Moravian Highlands during the *Stříbrná Jihlava 2007* colloquium (Luna et Zimola 2007, 306). They created a typology based on 108 chisels. The first type, A, is the most common with one hundred tools. These tools were characterised by an ovoid shape with a bulge at the eye of the tool, similar to the tools described by Agricola (Agricola 1556a, VI, 114–115). Eight others were classified as type B, characterised by a triangular shape. In the same year, another study appeared that focused on forty-two tools from the Bohemian-Moravian Highlands, some of which had a straight body (Hrazdil et al. 2007, for example, 284, fig. 1/59). We referred to this form as type C. We utilised this typology to classify the chisels from Castel-Minier and two characteristics made the classification possible. The first is the ratio between the widths at the eye (Y2) and at the heel (Y1) (Fig. 20). If

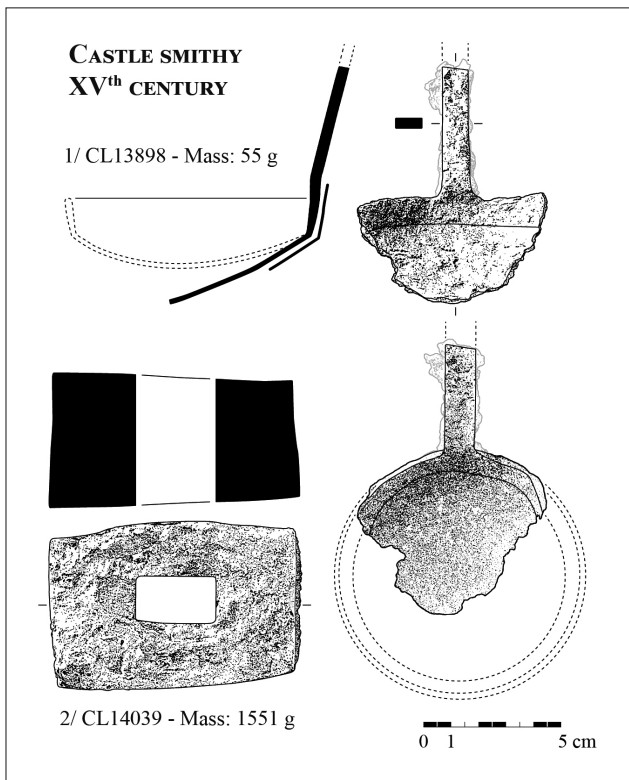

Fig. 19. Castel-Minier, mining tools from the castle smithy, 15th century. Obr. 19. Castel-Minier, důlní nástroje ze zámecké kovárny, 15. století.

$Y2/Y1$ is higher than 1.1, we considered the chisel to be ovoid-shaped, thus corresponding to type A. If $Y2/Y1$ is lower than or equal to 1.1, we considered the tool to have a straight shape corresponding to type C. This difference in shape is significant because it assumes an additional step in forging. The easiest method for a craftsman is to shape a straight bar. The smith first hammered the bar to achieve the correct cross-section and then sliced this bar to the appropriate length. The next step of the forging process was shaping the tip as mentioned below. The last step was to make the eye using a punch. During the opening of the eye, the metal was pushed to the sides, giving the characteristic ovoid shape of type A. To produce type C, the smith left the punch in place and hammered the bulb formed around the eye. The smith could then make then final quench.

Following this typology, we classified the chisels from Castel-Minier into two families: type A and type C. Of the thirty-eight chisels uncovered, eighteen belong to family A while eleven belong to family C (Fig. 21). Family A, which was easier to forge, was the most common, accounting for around 60 % of the total. The distribution between these two families remained identical for two centuries, reflecting the coexistence of two technical cultures on the Castel-Minier site throughout its history.

Another notable feature we observed was the presence of chamfers between the eye and heel, typically four, sometimes only two. The presence of this chamfer is unusual

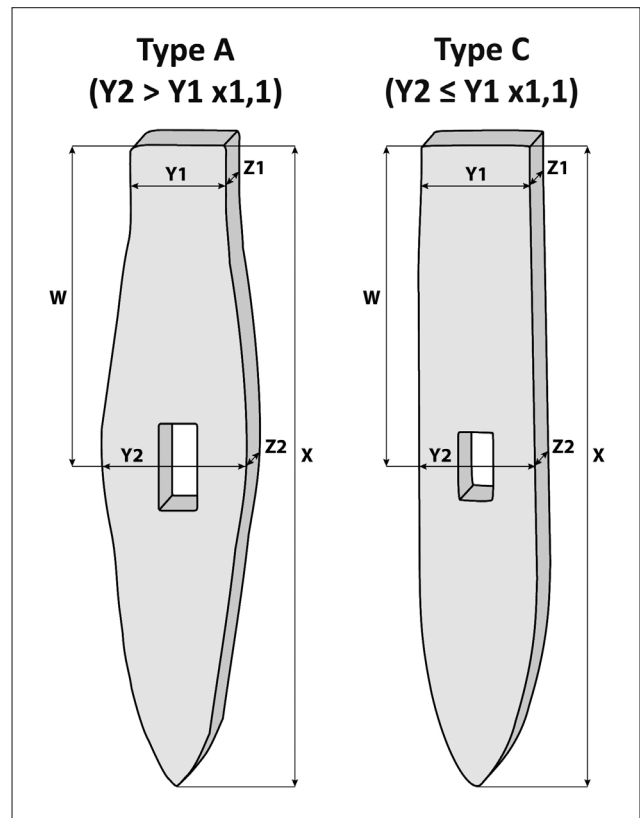

Fig. 20. Typology and measurements of chisels. Obr. 20. Typologie a míry dlát.

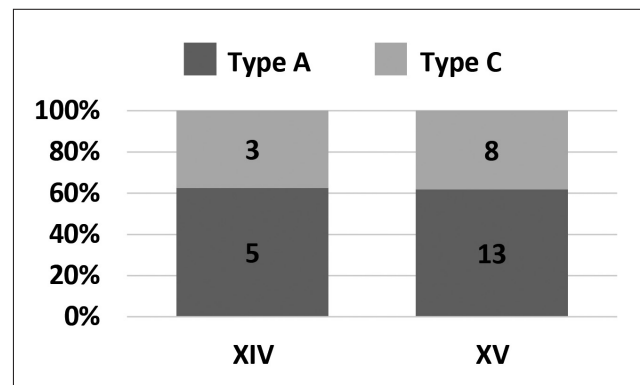

Fig. 21. Typology of chisels. Obr. 21. Typologie dlát.

in this type of tool. It is likely a shaping mark specific to individual smiths. The two picks found in the dewatering gallery also share this characteristic. The proportion of bevelled chisels decreased by about 20 % in the 15th century, from 57 % to 33 %. However, the proportion remained similar for both types (Fig. 22). Thus, the combination of these two parameters shows that there was no apparent trend. Consequently, we can conclude that the bevelling of chisels was a technical choice made by individual blacksmiths and not the result of chronological evolution.

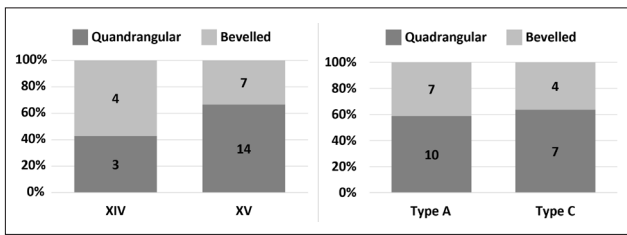

Fig. 22. Distribution of chisels according to the presence of a chamfer.
Obr. 22. Distribuce dlát podle přítomnosti úkosu.

Concerning their dimensions, the sections of heels (Y1-Z1) are consistently square and usually around 20 mm on each side, although their width (Y1) exceeds their thickness (Z1) by an average of 2 mm. There was no change in this trend over time (Fig. 23 left), although type C generally exhibits a heel whose width exceeds its thickness by 3 mm, while in the case of type A, this difference was only 1 mm (Fig. 23 right). The greater thickness of chisel CL14339 (24.5 mm) is due to the sheet metal welded on its surface (Figure 17/2). Thus, only the dimensions of chisel CL14327 are truly above average, with a width of 32 mm and a thickness of 27 mm (Fig. 17/1). Tool

CL12687 is characterised by a width-to-thickness ratio of 1.5 (23 × 15 mm) (Fig. 10/4).

We observed the total length (X) remains consistent at around 110 mm regardless of the period (Figure 24). However, since the total length of these tools is not a significant factor due to wear, we took into account the length between the eye and the heel (W). There was a slight increase in the 15th century, around 15 mm. Considering that chisels from this century showed more wear, we can conclude that the overall size of chisels increased by more than 30 mm between the 14th and the 15th centuries. A similar increase was observed in the two previously described studies on the Bohemian-Moravian Highlands (Luna et Zimola 2007, Hrazdil et al. 2007). Additionally, it is noteworthy that a constant thickness of about 20 mm was observed between the 13th and 16th centuries.

If we exclude the chisels with a very strong heel crush, such as CL14327 (Fig. 17/1), or heavily worn tips (CL12480/1, Fig. 9/5 and CL12480/2, Fig. 10/1), the average W/X ratio is 0.6. Seven chisels even have a ratio of 0.5 (Fig. 25), indicating relatively balanced chisels. Although our corpus predates *De Re Metallica*, the parallel is

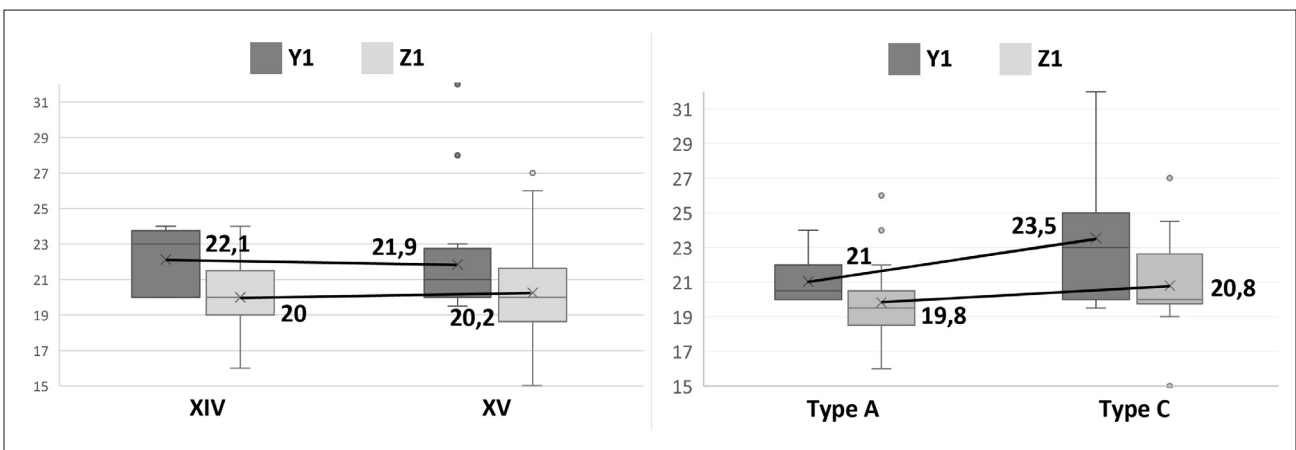

Fig. 23. Sections of heels (Y1-Z1).
Obr. 23. Části pat (Y1-Z1).

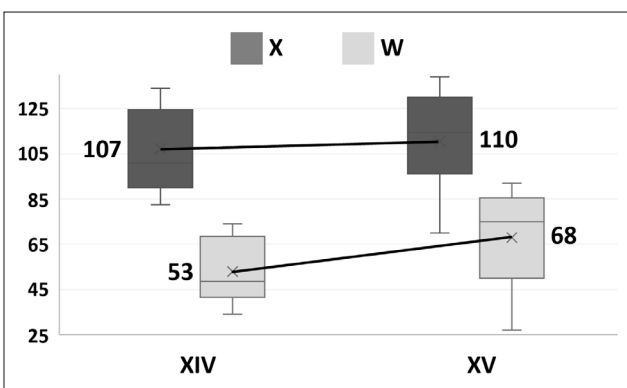

Fig. 24. To the left, total length (X) and length heel-eye (W).
Obr. 24. Vlevo: celková délka (X) and délka od paty k čepci (W).

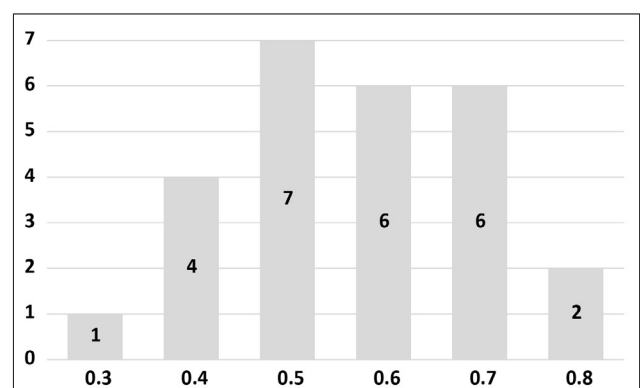

Fig. 25. Ratio W/X (14th–15th centuries).
Obr. 25. Poměr W/X (14.–15. století).

instructive. This position of the eye contradicts the descriptions made by Agricola. The chisels described in book VI have an eye closer to the heel than to the tip, with a W/X value close to 0.4 (Agricola 1556a, VI, 114–115, Guillot et al. 1995, 510). We can explain this difference by the wear on our tools. By applying this ratio of 0.4, the maximum projected length is then 22 cm (CL12834/2, CL12834/5 and CL12834/8: $9 \text{ cm} \times 2.5$).

Agricola defines three basic forms of chisels, each designed for specific uses: for daily use, for „shattering the hardest veins“, and for „digging the bottoms of those shafts which slowly accumulate water“ (Agricola 1556b, VI, 150). The first and second forms have the same cross-section, but the second one is twice as long. The third form has the same length as the second one, but a larger cross-section. Given the wear and tear on the tools, it is impossible to categorise our corpus in this way. Nevertheless, observing the cross-sections and assuming that the back part of the tool is less worn than the tip, it appears that were different tool sizes at Castel-Minier. There are tools with a cross-section of 20 mm and a length of over 20 cm. On the other hand, tools of lesser length with variable cross-sections, but still around 20 mm, form the majority.

Measurement of the eye is often difficult due to the corrosion still present on the surface of many tools. On average, chisel eyes are 15 mm long and 8 mm wide. However, these measurements are not representative due to a large fluctuation in the length/width ratio. These elements exhibit great variability, ranging from square (CL14327) to rectangular holes (CL12485, length $3 \times$ width). No trend in eye shape or size is apparent regardless of the type or period.

Metallographic studies

We conducted metallographic examinations on ten chisels: nine complete and one tip (Gosselin 2021, Leroy 2010). The distribution of these tools was identical across the 14th and 15th centuries. Among the nine complete tools, four belong to Family A and five to Family C. All eight identifiable tips consist of quenched steel, but the nature of the bodies varies. Five chisels have a body made of ferritic-pearlitic steel and four have a heterogeneous material composed of

a mixture of steel and ferritic iron (Fig. 26 left). There is wide variability in the way the chisels were provided with their tips; we identified three types: one-piece forged chisels and those with butt welded-on and cleft welded-in tips (Fig. 26 right and 27).

Regardless of the period, we did not observe any significant changes in the nature of the bodies or the methods used to provide them with steel tips (Fig. 26). The absence of cleft welded-in tips in the 14th century is not significant, as three techniques for eight identifiable pieces make any interpretation hazardous. Nevertheless, it is interesting to compare them with five chisels discovered at Pampailly and dated to the 15th century (Benoit 1997, 60–63, Guillot et al. 1995, Gosselin 2021, 468–470). The metallographic studies revealed only one technique: cleft welded-in tips. Additionally, comparing the nature of the bodies or the assembly methods (how the chisels were provided with steel tips) according to their typology does not reveal anything significant (Fig. 28). The distribution of different materials and assembly methods is similar within types A and C. The existence of the two types of chisels is linked to the concomitance of different skills and does not reflect any adaptation to the raw material.

We also found several examples of repairs. Chisel CL13895 has three successive welds, indicative of a repair (Fig. 29). Tool CL14339, as mentioned earlier, has a plate welded onto the heel (Fig. 17/2). It is important to note that these chisels are associated with the castle smithy (Fig. 6). These repairs, along with the advanced degree of wear on many of the chisels (tip wear and heel crush), provide evidence of the attention paid to these tools. They were re-forged and repaired to extend their lifespan as much as possible.

Conclusion

Two notable observations emerge from this study. First, apart from chisels and picks, the metal furniture associated with mining is similar to the other pieces found at Castel-Minier. It is not a specific production but part of a broader production intended for export or on-site use. Everything indicates that the smiths also produced chisels using iron produced on-site. Provenance analysis confirms that chisel

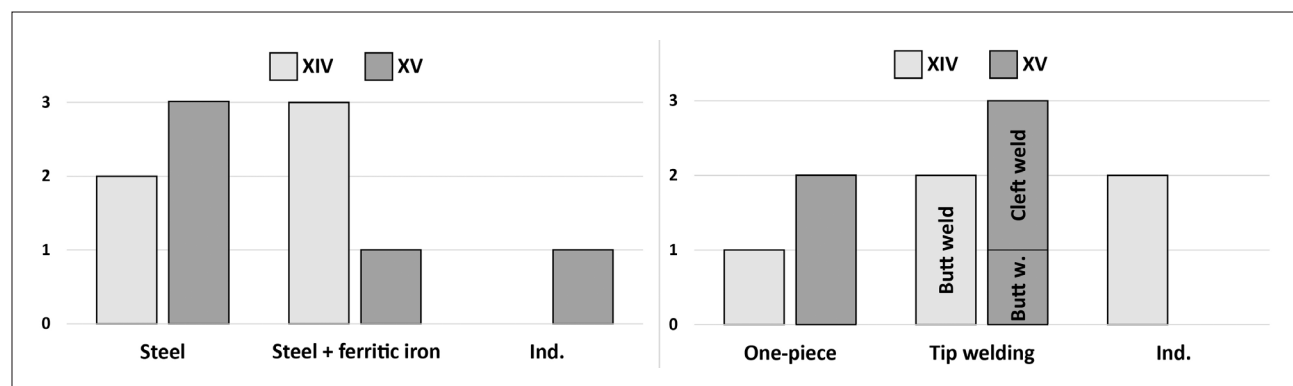

Fig. 26. Left, nature of bodies, right, assembly of tips according to the period.
Obr. 26. Vlevo: druh těles, vpravo: montáže hrotů podle období.

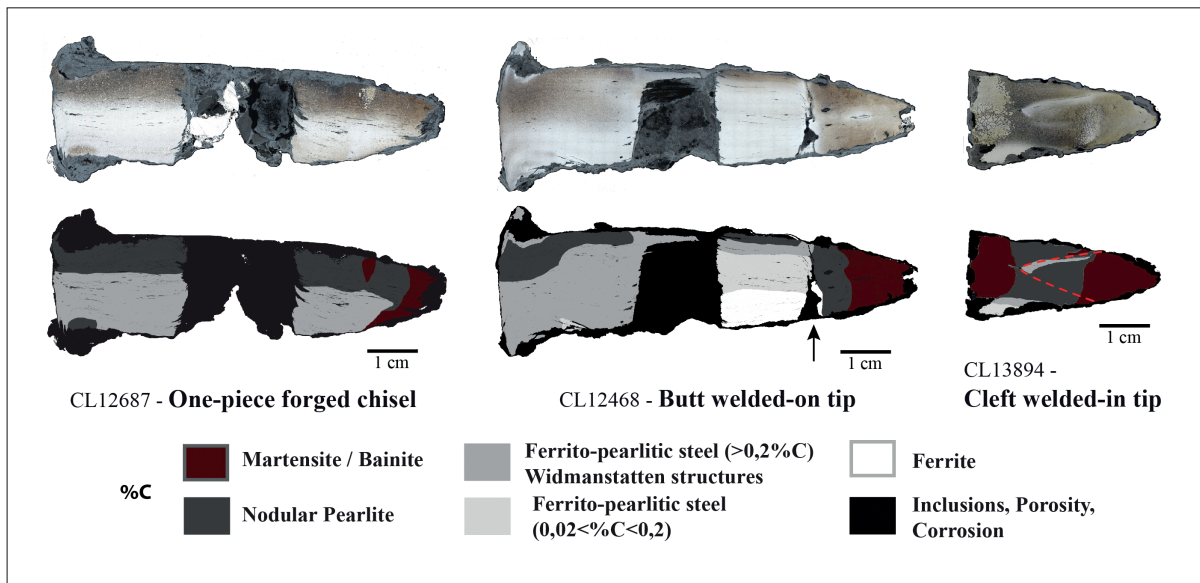

Fig. 27. Metallographic studies showing the three assembly types.
Obr. 27. Metallografické studie ukazující tři typy montáže.

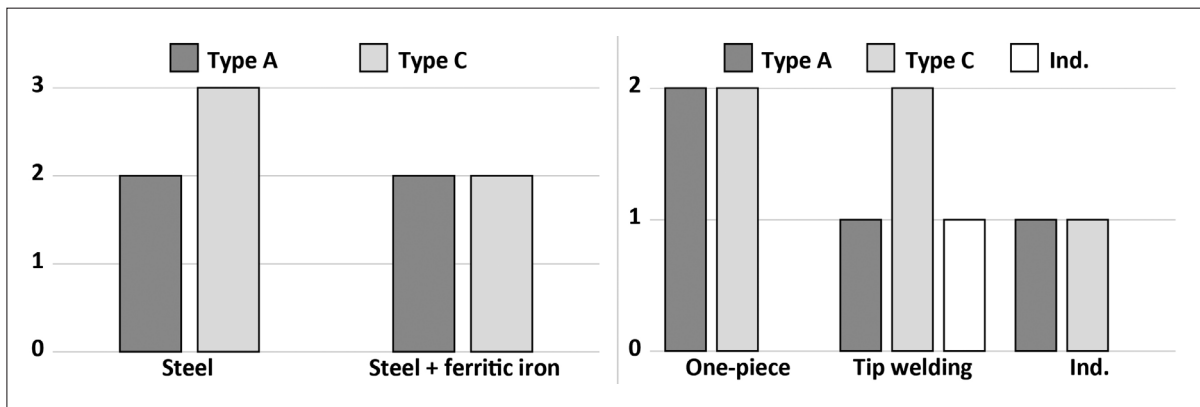

Fig. 28. Left, nature of bodies, right, assembly of tips according to typology.
Obr. 28. Vlevo: druh těles, vpravo: montáž hrotů podle typologie.

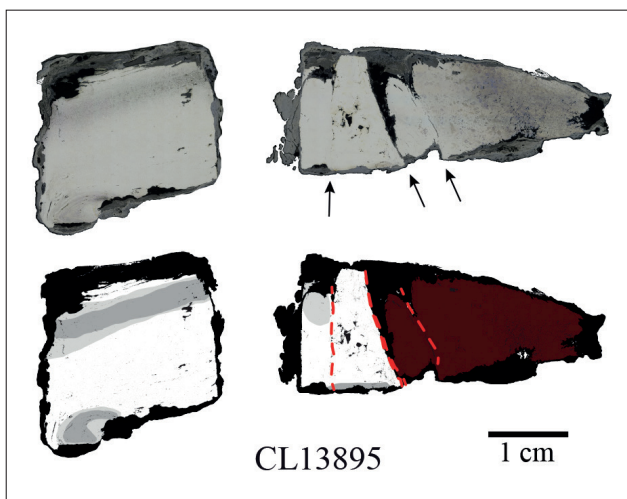

Fig. 29. Metallographic study, chisel CL13895.
Obr. 29. Metallografická studie, dláto CL13895.

CL10013 (Dewatering gallery) was made from Rancié ore, consistent with the by-products found at Castel-Minier (Leroy 2012). However, this production is evidently specific in terms of shaping, as indicated by the distribution of finds on the site, which is disconnected from the iron production areas.

Second, the study of these chisels revealed an absence of evolution in the forging process. However, we can observe the concomitance of several skills, such as types A and C, bevelled and unbevelled chisels. The existence of two types of chisels is linked to the simultaneous presence of different technical skills rather than being an adaptation to the raw material. The presence of a chamfer is uncommon on this type of tool and is likely a shaping mark specific to individual smiths. The only notable change between the 14th and the 15th century is the increase in the size of the chisels. This coexistence of different skills is not unique to Castel-Minier, similar observations were made regarding the shaping of bellow noses (Méaudre, Téreygeol 2018). Thus,

different practices coexisted at Castel-Minier, indicating the presence of craftsmen from various origins.

Two questions remain unanswered: the shaping of eye and the wear on the tools. We will conduct new metallographic studies along an axis perpendicular to the eye to observe the shaping of the eye. Additionally, we will conduct experiments on our experimental platform of “Les

Arts du feu” in Melle (France, Deux-Sèvres) to produce iron with archaeological ore, and then type C shape tools. The second question concerns tool wear. We will use these tools to quantify the daily tool consumption and observe the material losses at the tip and heel. If the heel crush is low compared to the tip wear, we can conclude that there were different tool lengths at Castel-Minier.

CL	Description	Family	Chamfer	Condition	X	W	Y2	Z2	Y1	Z1	Y2/Y1	Eye
Chisels - 14th century												
Castel-Minier - Foundry, upper level												
10930	Tip	--		Pre-prepared or broken-off	51	--	22 x 22		--	--		
11200/4	Tip	--			35 (estimate)	--	22 x 21		--	--		
Castel-Minier - Dwelling												
11487	Complete	A	0	To be reforged	100	49	23	21	20	20	1.2	16*7
12485	Complete	A	0	Reforged	101	48	24	24	20	16	1.2	15*5
13069	Complete	A	Ind.	Reforged	119	64	27	23	23	19	1.2	15*7.5
11085/1	Complete	A	1	To be reforged	90	41	23	23	20	20	1.2	16*7
12830	Frag.	C	1	Broken	78 min	43	24	20	23	19	1.0	13*7
Castel-Minier - Slag heap area												
12208	Complete	C	1	Reforged	134	74	26	22	24	22	1.1	18*10
12468	Complete	C	1	Worn out	82.5	34	26	19	23	20	1.1	14.5*6.5
12470	Complete	A	0	To be reforged	124.5	70	29	23	24	24	1.2	15.5*8.5
14306/1	Tip	--	0	Pre-pr. or br.-off	60	--	19 x 17		--	--		
Chisels - 15th century												
Castel-Minier - Castle smithy												
13895	Complete	C	0	To be reforged	70	27	22	19	20	20	1.1	14*8
14327	Complete	C	0	Reforged	100	33	34	26	32	27	1.1	12*11
14339	Complete	C	1	Reforged	96	36	29	19	28	24.5	1.0	16*12
13893	Frag.	C	0	Broken	55	18	27	15	26	22	1.0	11*9
13894	Frag.	Ind.	Ind.	Broken	47	--	25	19	--	--	--	Ind.*10
14324/3	Body	--	0	Scrap	82	--	26 x 26		--	--		
14324/4	Body	--	1	Scrap	52	--	24 x 22		--	--		
14324/1	Tip	--	0	Pre-prepared or broken-off	48	--	16 x 16		--	--		
14324/12	Tip	--	0		34	--	19 x 16		--	--		
14324/2	Tip	--	0		30	--	20 x 13		--	--		
Chisels - 15th century												
Les Ouels - Dewatering gallery												
10013	Complete	A	1	Reforged	115	82	28	20	21	20	1.3	13.5*11
11847	Complete	A	1	Reforged	101	64	27	20	21	19	1.3	17*11
12248	Complete	A	0	Worn out	95	68	25	20	23	22	1.2	16*8
12249	Complete	A	1	Reforged	83	48	26	25	22	26	1.2	10*8
12250	Complete	A	0	Reforged	137	75	26	22	20	22	1.3	17.5*7.5
12538	Complete	A	0	Reforged	139	68	30	21	20	19	1.5	18*8.5
12563	Complete	A	1	Reforged	114.5	52	26.5	22	21.5	19	1.2	16*8.5
12687	Complete	C	0	Reforged	78.5	34.5	25	19	23	15	1.1	19*7.5
12480/1	Complete	A	1	Worn out	106.5	81	25.5	20	22	20	1.2	12.5*10.5
12480/2	Complete	A	1	Worn out	102	77	26	19	21	18.5	1.2	15*10
12834/1	Complete	C	0	Reforged	128	86	25	23	23	20	1.1	14.5*7.5
12834/2	Complete	A	0	Reforged	134	90	26	18	20	16	1.3	19*9
12834/3	Complete	A	0	Reforged	115	68	27.5	18.5	20	18.5	1.4	14*8
12834/5	Complete	A	0	Reforged	132	90	25	18	20	20	1.3	12*6.5
12834/6	Complete	C	0	Reforged	130	84	22	18	20	20	1.1	12.5*6
12834/9	Complete	A	0	Reforged	122	86	27	19	20	18	1.4	18*9
12211	Frag.	Ind.	Ind.	Broken	54	--	25 x 25		--	--		
12560	Frag.	Ind.	0	Ind.	--	--			21	--	--	--
12834/4	Frag.	Ind.	0	Ind.	Ind.	--	27	22	--	--	--	14*7
12834/7	Frag.	Ind.	Ind.	Ind.	Ind.	Ind.	23	17	Ind.	Ind.	--	13*8
12834/8	Frag.	C	0	Ind.	Ind.	92	22	20	19.5	20.5	1.1	15*9
12194	Heel	Ind.	Ind.	Broken	Ind.	--	20		20	--	--	--
12480/3	Heel-eye	Ind.	Ind.	Broken	85 (preserved)	85 (est.)	23	23	23	20	--	Ind.
12541/2	Tip	Ind.	Ind.	Broken	45 (preserved)	--	23 x 20.5		--	--		
12541/3	Tip	Ind.	Ind.	Broken	45 (preserved)	--	24 (estimate x 19)		--	--		Ind.*8
Pick - 14th century - Slag heap area												
12831	Frag.	--	Ind.	Broken	60 (preserved)	34 (pr.)	32 x 19		--	--		18*7
Picks - 15th century - Les Ouels - Dewatering gallery												
12541/1	Complete	--	1	Worn out	92	63	25 x 18		--	--		14.5*8.5
12193	Complete	--	1	Reforged	100	57/43	26.5 x 20		--	--		13*8

Fig 30. Summary table of chisels and picks (mm).

Obr. 30. Souhrnná tabulka dlát a krumpáčů (mm).

CL	Type	Condition	Length	Width	Thickness	Head	Body	Diverse
Tools - 14th century								
Castle-Minier - Slag heap area								
12464	Wedge	Complete	108	--		44*38	32*22	--
Castle-Minier - Dwelling								
11186	Hoe	Frag.	180	91	15		--	
Tools - 15th century								
Castle-Minier - Water-powered forge								
12678/1	Axe	Frag.	95.5	35	11		--	
13396/1	Axe	Frag.	25	25	6		--	
Castle-Minier - Castle smithy								
13898	Lamp	Frag.	--	92 (est.) - 11	--		--	
14039	Sledgehammer	Complete	92	61	46		--	Eye 29*17
Les Ouels - Dewatering gallery								
13688	Wooden trough	Frag.	61 (estimate)	22 (estimate)	10 (estimate)		--	
Les Ouels - Adit +19								
13269/1	Chain link	Frag.	110 (estimate)		--			∅ 25
13269/2	Chain link	Frag.	130 (estimate)		--			∅ 24
13269/6	Flat iron	Complete	144	28			--	
13269/7a	Flat iron	Complete	206	33			--	Eye 11.5*9
13719	Flat iron, nail & timber	Complete					--	
13511	Ind.						--	
13513	Ind.						--	
13269/5	Nail	Complete	75		--	14*13.5	10.5*10.5	--
13269/7b	Nail	Complete	59		--	20*14	9*9	--
13270	Pin	Complete	172		--	28*8	12*10	--
13460	Pin	Complete			--			
13512	Pin	Complete	280		--	31*27	31*18	--
13269/3	Pin	Complete	177		--	22*11	16*11	--
13269/4	Pin	Complete	132		--	19*7	7.5*7.5	--
Les Ouels - Adit +21								
12657/1	Ind.	--	260		--			2 square holes
12670	Ind. & chain link ?				--			
12503/2	Nail ?				--			
12657/2	Nail ?	--	75		--		7*7	--
12503/1	Pincers	Complete	220	Jaw 3	Jaw 17		--	Arm ∅ 9

Fig. 31. Summary table of tools (mm).
Obr. 31. Souhrnná tabulka nářadí (mm).

BIBLIOGRAPHY

- AGRICOLA G. (1556a): *De Re Metallica*, VI, Bâle, translation France-Lanord A., 1992, Thionville.
- AGRICOLA G. (1556b): *De Re Metallica*. Translated by Herbert Clark Hoover and Lou Henry Hoover. Salisbury House, London 1912.
- BAILLY-MAITRE M.-C., BRUNO-DUPRAZ J. (1994): *Brandes en Oisans, La mine d'argent des Dauphins (XII-XIVe s.)*, Isère.
- BAILLY-MAITRE M.-C. (dir.) (2019): *L'entreprise minière de Brandes – XIe-XIVe siècles Huez-Oisans (Isère). – Extraction et transformation de minerais argentifères*, DARA, 47, ALPARA-Maison de l'Orient, Lyon, 318 p.
- BENOIT P. (1997): *La mine de Pampailly, XVe-XVIIIe siècles*, Brussieu – Rhône, Lyon, 137 p.
- CONIN A., GRANDEMANGE J., BENOIT P., GUILLOT I., FLUZIN P. (1995): "La forge minière du Samson (Haut-Rhin)". – In: Benoit P., Fluzin P. (ed.), *Paléométaballurgie du fer et cultures*. Symposium international du Comité pour la Sidérurgie Ancienne, Belfort – Sévenans, 1-2-3 novembre 1990, Belfort, Paris, 375–386.
- DAHM C., LOBBEDEV U., WEISGERBER G. (1998), *Der Altenberg. Bergwerk und Siedlung aus dem 13. Jahrhundert im Sieger land, Band 2, Die Funde*, 1998, 264 p., 89 pl.
- GOLDENBERG G. et FRÖHLICH M. (2006): *Der Birkenberg bei Bollschweil – St. Ulrich. Ein Bergbaurevier aus dem Mittelalter*, 63 p.
- GOSSELIN M. (2021): *Qualités des alliages ferreux : une approche diachronique et statistique*, Thèse de doctorat, Université Paris Nanterre, 2 volumes.
- GUILLOT I., BERTIN F., FLUZIN P., BENOIT P. BERANGER G. (1995): „La pointerolle, outil des mineurs du XVIe siècle: synthèse des études métallographiques“. – In: Benoit P., Fluzin P. (ed.), *Paléométaballurgie du fer et cultures*. Symposium international du Comité pour la Sidérurgie Ancienne, Belfort – Sévenans, 1-2-3 novembre 1990, Belfort, Paris, 509–524.
- HRAZDIL V., DOČKAL P. et VOKÁČ M. (2007): *Rudní lokality na Českomoravské vrchovině s nálezy hornických nástrojů. Gezähefunde aus polymetallischen Erzlagerstätten des Böhmischemährischen Berglandes. – Stříbrná Jihlava 2007, Silberne Stadt Jihlava 2007, Archeologické výzkumy na Vysočině, Supplementum 1, Jihlava – Brno 282–305.*
- LEROY S. (2010): *Circulation au Moyen Age des matériaux ferreux issus des Pyrénées ariégeoises et de la Lombardie. Apport du couplage des analyses en éléments traces et multivariées*, Université Technologie Belfort-Montbéliard, 2 volumes.
- LEROY S., COHEN S. X., VERNA C., GRATUZE B., TÉREYGEOL F., FLUZIN P., BERTRAND L., DILLMANN P. (2012): *The medieval iron market in Ariège (France). Multidisciplinary analytical approach and multivariate analyses. – Journal of Archaeological Science*, 39: 1080–1093.
- LUNA J. et ZIMOLA D. (2007): *Historické hornické nástroje z centrální části Českomoravské vrchoviny, Historische Gezähe aus dem Zentralraum des Böhmischemährischen Berglandes. – Stříbrná Jihlava 2007, Silberne Stadt Jihlava 2007, Archeologické výzkumy na Vysočině, Supplementum 1, Jihlava – Brno, 306–325.*
- MEAUDRE J.-CH. et TÉREYGEOL F. (2018): *Discovery of a set of copper tuyere imprints on the site of Castel-Minier (Ariège, France). – Historical Metallurgy*, 52(1): 33–37.
- TÉREYGEOL F. (dir.) (2015): *Le Castel-Minier (Aulus-les-Bains, 09), Rapport intermédiaire*, DRAC Midi-Pyrénées, 187 p.
- TÉREYGEOL F. (2016): *L'apogée de la mouline: Castel-Minier au XVIe siècle*, in Gasquet D., *Actes du colloque Les Chemins du fer*, Belledonne, 22–25 mai 2013, 105–112.
- VERNA C. (2002): *Le temps des moulins, Fer, technique et société dans les Pyrénées centrales (XIIIe-XIVe siècles)*, Paris, 425 p.