



HAL
open science

Les implications de la réglementation sur le marché des semences et l'innovation : Les droits de Propriété Intellectuelle et les règles de commercialisation

Adrien Hervouet

► **To cite this version:**

Adrien Hervouet. Les implications de la réglementation sur le marché des semences et l'innovation : Les droits de Propriété Intellectuelle et les règles de commercialisation. Economies et finances. IEMN-IAE (Université de Nantes), 2015. Français. NNT : . tel-01808233

HAL Id: tel-01808233

<https://theses.hal.science/tel-01808233>

Submitted on 5 Jun 2018

HAL is a multi-disciplinary open access archive for the deposit and dissemination of scientific research documents, whether they are published or not. The documents may come from teaching and research institutions in France or abroad, or from public or private research centers.

L'archive ouverte pluridisciplinaire **HAL**, est destinée au dépôt et à la diffusion de documents scientifiques de niveau recherche, publiés ou non, émanant des établissements d'enseignement et de recherche français ou étrangers, des laboratoires publics ou privés.

Thèse de Doctorat

Adrien HERVOUET

*Mémoire présenté en vue de l'obtention du
grade de Docteur de l'Université de Nantes
sous le label de L'Université Nantes Angers Le Mans*

École doctorale : *Droit, Économie, Gestion, Environnement, Sociétés et Territoires (DEGEST)*

Discipline : *Science Économique (Section 05)*

Unité de recherche : *LEMNA EA4272 (Chemin de la Censive de Tertre 44322 Nantes, France)*

UFR: *Institut d'Économie et de Management de Nantes - IAE*

Soutenue le 16/07/2015

Thèse N° :

Les implications de la réglementation sur le marché des semences et l'innovation : Les droits de Propriété Intellectuelle et les règles de commercialisation

JURY

Rapporteurs :	Yann MÉNIÈRE , Professeur à l'école des Mines de Paris, MINES ParisTech Stéphane LEMARIÉ , Directeur de recherches, INRA Grenoble (UMR GAEL)
Examineurs :	Sophie LARRIBEAU , Professeur des Universités, Université de Rennes 1 Corinne LANGINIER , Professeur étranger (Associate Professor), University of Alberta Thomas VALLÉE , Professeur des Universités, Université de Nantes
Directeur de Thèse :	Olivier DARNÉ , Professeur des Universités, Université de Nantes
Co-directeur de Thèse	Marc BAUDRY , Professeur des Universités, Université de Paris Ouest Nanterre la Défense

Résumé

La thèse s'intéresse aux implications des réglementations sur le marché des semences. Deux types de réglementations sont analysés : la réglementation commerciale et les droits de propriété intellectuelle. Concernant la réglementation commerciale des différences sont à noter entre les règles européennes, très strictes, et les règles américaines qui sont plus souples. Des voies divergentes ont également été prises entre l'Europe et les États-Unis pour la mise en place de droits de propriété intellectuelle sur ce secteur. En effet, en Europe seul un droit *sui generis* est disponible pour protéger une variété végétale alors qu'aux États-Unis les brevets sont également disponibles. Le premier chapitre présente une estimation économétrique de la valeur des certificats d'obtention végétale en France. Le résultat principal de cette étude est que l'exemption de l'agriculteur semble avoir un effet plus important que l'exemption de recherche. Le second chapitre analyse l'ensemble des réglementations et s'intéresse plus spécifiquement à l'exemption de recherche. Il analyse également leurs impacts sur la biodiversité. Ce chapitre montre que le système américain offrant plus de souplesse en terme de choix de droits de propriété intellectuelle est plus optimal que le système européen. Le troisième chapitre utilise un modèle théorique différenciant des stratégies de bien durable et de bien non-durable adoptées par le semencier. Il permet de prendre en compte l'une des spécificités de ce marché : les semences de ferme. Ce chapitre montre également que le système américain permet d'obtenir un niveau de dépense en R&D plus optimal que le système européen.

Mots clés : Variété Végétale, Droit de Propriété Intellectuelle, Certificat d'Obtention Végétale, Innovation, Biodiversité, Exemption de Recherche, Exemption de l'Agriculteur, Catalogue

The Implications of the regulation on the seed market : The Intellectual Property Rights and commercialization rules

abstract

This thesis focuses on the implications of regulations on the seed market. Two kinds of regulation are analyzed : commercialization rules and intellectual property rights. Regarding commercialization rules, differences exist between European rules, very strict, and U.S. rules, more flexible. Divergent paths have also been taken between Europe and the U.S. for the establishment of intellectual property rights in this sector. Indeed, in Europe only a *sui generis* right is available to protect a plant variety while in the U.S. patents are also available. The first chapter presents an econometric estimation of the value of plant breeders' rights in France. The main result of this study is that the farmers' exemption seems to have a higher effect than the research exemption. The second chapter analyzes all the regulations and focuses specifically on the research exemption. It also analyzes their impacts on biodiversity. This chapter shows that the U.S. system, which provides more flexibility in terms of choice of intellectual property rights, is more optimal than the European system. The third chapter uses a theoretical model that differentiates durable good strategies and non-durable goods strategies adopted by the innovator. It allows to take into account one of the specificity of this market : farm-saved seeds. This chapter also shows that the U.S. system provides a level of R&D expenditures more optimal than the European system.

Key Words : Plant Variety, Intellectual Property Right, Plant Breeders' Rights, Innovation, Biodiversity, Research Exemption, Farmers' Exemptions, Catalogue

Résumé substantiel

Pour promouvoir la création variétale deux instruments réglementaires distincts ont été développés répondant à deux objectifs différents : les règles de commercialisation et les Droits de Propriété Intellectuel (DPI). Les règles de commercialisation répondent à un problème informationnel limitant le développement du secteur des semences agricoles. En effet, sans un signal crédible sur la qualité des semences, les agriculteurs ne peuvent pas faire la différence entre des semences de mauvaise ou de bonne qualité. Ce problème fait référence à la théorie de la sélection adverse en économie. Il faut donc, dans un premier temps, pour développer le marché des semences, créer une réglementation commerciale permettant d'envoyer un signal crédible sur la qualité des produits. Le moyen adopté pour apporter ce signal crédible, la certification, se base sur des spécificités des semences comme le taux de germination, et induit également un phénomène de réputation. En effet, les semences certifiées ont des appellations distinctes ce qui rend illégal la commercialisation d'une autre variété sous le même nom. Les DPI permettent également de répondre à une autre défaillance : les semences ont certaines caractéristiques des biens publics. En effet, elles possèdent la caractéristique de non exclusion à travers le temps. Une fois la variété achetée, il est facile et peu coûteux de la reproduire et de la réutiliser de campagne en campagne. Des semenciers pourraient alors commercialiser une variété développée par une autre société sans avoir à supporter les coûts associés à ce développement. Les agriculteurs peuvent également reproduire cette variété pour ne plus acheter les semences à chaque nouvelle période. Cette reproductibilité donne un aspect de bien durable aux semences. Or, pour inciter les acteurs du secteur privé à investir dans la création variétale il faut leur permettre de rendre rentable cette activité comportant des coûts fixes et surtout de nombreuses

années de développement. Dans ce but, la mise en place de DPI au cours du 20^{ième} siècle c'est faite progressivement en permettant aux semenciers d'obtenir un monopole temporaire sur la commercialisation de leur variété protégée.

Néanmoins, des choix différents ont été effectués selon les pays afin de répondre au problème d'asymétrie d'information. En effet, certaines règles de commercialisation s'arrêtent au niveau de la qualité intrinsèque des semences alors que d'autres réglementations portent également sur les produits récoltés. C'est le cas en Europe où les règles de commercialisation sont très strictes et répondent principalement aux spécificités des variétés modernes. Ces variétés modernes répondent aux besoins de l'agriculture intensive et des entreprises agroalimentaires. Cependant, des marchés de niche peuvent exister, et demander des variétés locales et anciennes ne répondant pas aux critères actuels de commercialisation. Ce cas peut être souligné à travers le mouvement des semences paysannes qui promeut une agriculture locale, plus respectueuse de la nature et favorisant une biodiversité plus importante des variétés agricoles (Demeulenaere, 2013). De plus, l'éviction de variétés locales ou anciennes, par des règles de commercialisation trop strictes, est en contradiction avec l'une des visions de la conservation de la biodiversité. En effet, la conservation de la biodiversité, pour les signataires de la Convention sur la Diversité Biologique, doit, en partie, être *in-situ* c'est-à-dire que la création variétale locale doit promouvoir la biodiversité dans les champs, par opposition à la conservation *ex-situ* où la biodiversité végétale est conservée dans des « banques » de graines. Or, les règles de commercialisation très strictes en Europe ne permettent pas de commercialiser ou d'échanger ce genre de semences au niveau professionnel.

De même, des choix relativement différents ont été fait en matière de protection intellectuelle. Ainsi, pour un certain nombre de pays la brevetabilité du vivant n'est pas acceptable éthiquement. En Europe, il n'est pas possible de breveter des variétés végétales ainsi que des procédés qui sont « essentiellement biologiques », c'est-à-dire des phénomènes naturels tel que le croisement ou la sélection végétale, tandis qu'aux États-Unis toute invention est potentiellement brevetable. Pour les pays qui n'autorisent pas la brevetabilité des variétés végétales, un système *sui generis* a été établi. Les Certificats

d'Obtention Végétale qui découlent de ce système ont deux importantes exemptions par rapport à un système de brevet. L'exemption de recherche permet de prendre en compte l'une des spécificités des variétés végétales. Les innovations dans la création variétale sont, en effet, essentiellement cumulatives. Plus précisément, il est nécessaire d'avoir des variétés parentes pour créer une nouvelle variété. Si les variétés parentes nécessaires à la création variétale étaient protégées, alors cela pourrait freiner l'innovation dans ce secteur. Ensuite, l'exemption de l'agriculteur vise à prendre en compte une autre spécificité de ce secteur. Depuis des siècles, les agriculteurs sélectionnent une partie de leur récolte pour la réutiliser comme semence à la saison suivante. C'est de cette façon que jusqu'à la fin du 19^{ième} siècle la création variétale a eu lieu. Les semences de ferme sont pour beaucoup d'agriculteurs un droit inaliénable provenant d'une pratique ancestrale.

Ces différents système de réglementation vont être analysés à travers les trois chapitres de la thèse.

Le second chapitre présente une analyse empirique des COV. Plus précisément, il comble un vide sur la quantification de l'importance économique des COV. En effet, il fournit une estimation de la valeur des COV pour six grandes cultures en France en utilisant une méthode économétrique basée sur les décisions de renouvellement. Cette méthode a d'abord été introduite par Schankerman et Pakes (1986), puis approfondie par de nombreux auteurs (dont Barney, 2002 ; Bessen, 2008 ; Baudry et Dumont, 2012) pour analyser la valeur des brevets. Dans le but d'insérer des variables micro-économiques influençant la valeur des COV, la méthode utilisée dans le premier chapitre s'inspire essentiellement de celle proposée par Baudry et Dumont (2012). Comme pour les brevets, le maintien d'un COV passe par le paiement d'une annuité. Si l'obtenteur ne s'acquitte pas de cette annuité alors son COV tombe dans le domaine public. En faisant l'hypothèse que l'obtenteur est un agent rationnel il doit alors continuer de payer l'annuité tant que celle-ci n'excède pas les gains que lui apportera le maintien de son droit. Les informations tirées de ce comportement révèlent indirectement la valeur des COV.

Les résultats montrent que, conformément à la littérature sur les brevets et les études de Srinivasan (2003, 2012), la majorité des COV ont une valeur très faible tandis qu'un nombre restreint d'entre eux a une très forte valeur. Au-delà de la mise en évidence d'une forte asymétrie de la distribution de la valeur des COV, la méthode appliquée à l'originalité de permettre d'estimer l'effet de variables spécifiques non seulement à la cohorte mais aussi à chaque COV. Les renouvellements de COV ont été étudiés séparément pour les six espèces agricoles traitées dans le chapitre. L'étude montre ainsi que l'arrivée des COV européens ont eu un effet négatif sur la rente initiale, probablement du fait d'une auto-sélection induisant que les meilleurs variétés parmi les nouvelles variétés créées sont dorénavant protégées directement au niveau européen plutôt qu'au niveau national (excepté pour le tournesol). De plus, les COV appartenant à des sociétés françaises s'avèrent avoir une valeur plus forte pour le maïs, le tournesol et les pommes de terre mais une valeur plus faible pour le blé et le colza (aucun effet pour le pois). L'introduction de variables micro-économiques, permet surtout d'examiner l'effet de l'exemption de recherche et de l'exemption de l'agriculteur. En effet, il est supposé que si l'exemption de l'agriculteur était levée, alors la demande de semence augmenterait, *ceteris paribus*. L'augmentation de la demande passe par l'augmentation de la surface allouée aux cultures à prix inchangé, ce qui a un effet sur la rente initiale des COV. Afin de contrôler l'effet prix, les prix des cultures ont également été introduits comme déterminant de la rente initiale. Dans ce cadre, l'arrêt de l'exemption de l'agriculteur augmenterait la valeur des COV de 3 à 5% pour les pommes de terre, d'environ 10% pour les pois et de plus de 50% pour le colza. Concernant les autres variétés, l'effet n'a pas pu être analysé, soit parce que le coefficient de la variable de surface allouée n'avait pas le bon signe (cas du blé), soit parce que les semences hybrides représentent déjà l'essentiel du marché, (cas du maïs et du tournesol). L'effet de l'exemption de recherche est analysé à travers son influence sur le taux de dépréciation de la rente. Il faut rappeler que cette exemption permet aux concurrents de se servir de la variété protégée pour en créer une autre sans avoir besoin de l'autorisation de l'obtenteur. Ainsi, l'impact de cette exemption est estimé en combinant l'effet de l'arrivée de nouvelles variétés concurrentes

et de la sortie de variétés concurrentes sur le taux de dépréciation de la rente initiale. Pour que l'exemption de recherche ait un effet négatif et, par conséquent, augmente le taux de dépréciation, il faut que ces deux variables augmentent globalement le taux de dépréciation. Ce résultat est seulement obtenu pour le maïs où la concurrence semble être plus forte au vu du nombre de COV beaucoup plus important pour cette espèce que pour les cinq autres étudiées. Cette étude montre donc que l'exemption de l'agriculteur semble avoir un effet plus important sur la valeur des COV que l'exemption de recherche.

Le troisième chapitre développe une étude théorique de l'exemption de recherche avec une application empirique pour le cas du blé en France. La singularité de cette analyse est de prendre en compte l'effet de la réglementation commerciale conjointement à celle des DPI ainsi que l'effet des ces réglementations sur la biodiversité. La demande des agriculteurs est d'abord modélisée à l'aide d'un modèle de différenciation verticale provenant de Prescott et Visscher (1977) qui permet de prendre en compte la différence en terme de réglementation commerciale entre l'Europe et les États-Unis. La biodiversité est introduite en ayant un effet endogène *via* la productivité des agriculteurs. Ensuite, l'offre des semenciers est modélisée différemment selon le type de DPI, brevets ou COV. Avec un COV, l'exemption de recherche permet à un concurrent d'entrer sur le marché à la seconde période, alors qu'avec un brevet et donc sans exemption de l'agriculteur, l'innovateur de la première période restera en monopole lors de la seconde période car l'innovation sur le marché des semences est particulièrement incrémentale. Le comportement stratégique des semenciers est analysé à l'étape amont de R&D en prenant en compte un coût fixe de R&D et un taux de réussite exogène de l'innovation. Le régulateur public peut choisir entre plusieurs couples de réglementions sur les DPI et les règles commerciales. Son choix se fait en intégrant le comportement stratégique des semenciers avec pour objectif de maximiser le bien-être.

Dans un cadre statique, en simulant les quatre couples possibles de réglementations, le chapitre montre que le couple COV/standards minimum apporte le bien-être le plus élevé grâce à des profits plus importants de la part des agriculteurs. Cela est dû à des

prix plus faibles pratiqués par les semenciers. Cependant, l'indice de la biodiversité est le plus élevé dans le cadre brevet/standards minimum bien que, sous un système de brevets, il n'y a que deux variétés sur le marché tandis qu'avec un COV il y en a trois. Ce résultat provient du fait que les parts de marché sont plus également réparties avec un système de brevets qu'avec un système de COV. Ensuite, dans le cadre dynamique, un résultat proche de celui obtenu par Moshini et Yerokhin (2008) apparaît. Avec un coût fixe de R&D faible, il est préférable d'avoir un système de COV alors qu'avec un coût fixe de R&D élevé un système de brevet semble socialement préférable. Plus surprenant, la situation européenne avec le couple de réglementation COV/catalogue n'est quasiment jamais optimale. En réalité, les couples de réglementation les plus souvent optimaux pour la société sont le couple COV/standards minimum lorsque la probabilité de succès est élevée et le coût fixe de R&D faible et le couple brevet/standards lorsque la probabilité de succès et le coût fixe de R&D sont élevés. En analysant le choix optimal pour les semenciers et non pas pour la société dans son ensemble, on remarque également que les semenciers préfèrent un système de COV lorsque les coûts fixes de R&D sont faibles et la probabilité de succès n'est pas trop élevée. Il faut noter que ce choix de système de DPI est en adéquation avec le choix du régulateur. On conclut, que le système américain offrant plus de flexibilité dans le choix des DPI pour les semenciers semble comme être préférable pour la société au système européen. Ce résultat est d'autant plus marquant que le modèle a été calibré sur données françaises.

Le quatrième et dernier chapitre analyse la seconde exemption d'un système de COV, à savoir l'exemption de l'agriculteur autorisant les semences de ferme, même sur les variétés protégées par un COV. Les semences de ferme apportent une forme de durabilité au bien. Pour prendre en compte cet aspect, le chapitre 4 s'appuie donc sur une partie de la littérature utilisant une modélisation théorique des biens durables (e.g. Ambec et al., 2008). Deux points importants sont apportés à la modélisation. D'abord, il y a une étape de R&D. Ensuite, il y a un choix entre deux formes de droit de propriété intellectuelle, soit un système de COV autorisant les semences de

ferme, soit un système de brevets interdisant les semences de ferme mais plus onéreux à obtenir pour le semencier qu'un COV. Dans le cadre où le semencier choisit le système de COV pour protéger son innovation il doit, ensuite, choisir entre deux stratégies différentes : soit une stratégie de bien durable où il incite les agriculteurs à n'acheter qu'en première période et, ensuite, à la seconde période les agriculteurs utilisent des semences de ferme ; soit une stratégie de bien non durable où le semencier doit choisir les prix pour la première et la seconde périodes qui incitent les agriculteurs à ne pas utiliser de semences de ferme. Enfin, à l'image de la CVO en France mais aussi d'autres systèmes de *royalty* sur les semences de ferme, une taxe sur les semences de ferme est introduite. Elle est supposée être redistribuée à l'innovateur, soustraction faite du coût administratif.

Dans ce cadre, lorsque le semencier a le choix entre un système de brevets ou un système de COV, il ne choisira pas toujours un système de brevets bien que celui-ci protège plus efficacement son innovation. Dans certain cas où l'agriculteur reste très productif en utilisant des semences de ferme et où la taxe n'est pas très élevée, le semencier conservera une stratégie de bien durable et préférera donc que les agriculteurs utilisent des semences de ferme à la seconde période. L'introduction d'un système de brevets peut permettre d'augmenter les incitations à innover et diminue les situations d'investissement sous optimal d'un point de vue social, sans toutefois les faire complètement disparaître. L'introduction d'une taxe sur les semences de ferme peut faire augmenter les incitations à innover, notamment lorsque celle-ci fait passer le semencier d'une stratégie de bien durable à une stratégie de bien non durable. Cependant, certains niveaux de la taxe peuvent avoir un effet contreproductif. En effet, si la stratégie choisie par le semencier est celle des biens durables et si l'introduction de la taxe ou son augmentation n'implique pas de changement dans le comportement du semencier, alors cela diminuera les gains des agriculteurs. En conséquence, les semenciers devront diminuer leur tarification pour prendre en compte le manque à gagner des agriculteurs. Pour conclure, comme pour le chapitre précédent, le système américain offre donc une flexibilité plus importante dans le choix des DPI, ce qui permet d'augmenter les incita-

tions à innover d'une façon plus importante que ne le fait l'introduction d'une taxe sur les semences de ferme.

Remerciements

Je tiens tout d'abord à remercier mes co-directeurs de thèse, Marc Baudry et Olivier Darné, pour m'avoir fait confiance et pour m'avoir apporté leurs aides tout au long de ce travail de recherche. Je remercie plus spécifiquement Marc Baudry avec qui j'ai co-écrit deux des chapitres de ma thèse. Je remercie également Corinne Langinier pour m'avoir permis de passer un séjour de cinq mois à l'Université d'Alberta au Canada. Durant ce séjour, j'ai amélioré ma pratique de la langue anglaise ainsi que commencé à développer, avec Corinne Langinier, le quatrième chapitre de ma thèse.

Je souhaite ensuite remercier la région des Pays de la Loire pour avoir financé les trois premières années de ma thèse ainsi que l'Université de Nantes et l'Université d'Auvergne qui m'ont permis d'avoir une poste d'ATER lors de ma quatrième et cinquième année.

Je remercie l'ensemble des membres du jury de ma thèse : Yann Ménière, Stéphane Lemarié, Sophie Larribeau, Thomas Vallée et Corinne Langinier pour le temps et les remarques qu'ils m'apporteront.

J'exprime ma gratitude à l'ensemble des chercheurs que j'ai pu rencontrer lors de conférences, de séminaires et qui ont apporté des conseils avisés dans le but d'améliorer mes articles. Je pense notamment à Stéphane Lemarié, Michel Trommetter, Ariane Gaunand, Martin Bortzmeyer, Philippe Marcoul, David Zilberman, Andrew Toole et Russell Thomson.

Enfin je remercie chaleureusement l'ensemble des docteurs et doctorants avec qui j'ai partagé beaucoup de temps et d'émotions dont Gabriel Figueiredo, Léo Le Mener, Sterenn Lucas, Rémy Le Boennec, Marianne Lumeau, Marie-Laure Nauleau, Marie-Sophie Hervieux et Gino Baudry. Sans oublier mes amis et ma famille qui ont été d'un soutien inaliénable.

Table des matières

Table des matières	xiv
Liste des tableaux	xvii
Table des figures	xix
Sigles	xxi
1 Introduction	1
1.1 D'une activité paysanne à la domination des semenciers	6
1.2 Réglementation commerciale	9
1.3 Les Droits de Propriété Intellectuelle	13
1.4 Revue de la littérature	21
1.5 Bibliographie	31
2 The Value of the Plant Variety Protection and the Impact of Exemption Rules	38
2.1 Introduction	40
2.2 Model Setting	44
2.2.1 The value maximization problem	44
2.2.2 Assumptions to obtain a simple decision rule	45
2.2.3 Model specification	47
2.2.4 The econometric model	49

2.3	Data and results	51
2.3.1	Data	51
2.3.2	Results	57
2.3.3	A test of the exemption rules	66
2.4	<i>Conclusion</i>	72
2.5	Bibliography	73
3	Innovation on the seed market: the role of IPRs and commercialisation rules	78
3.1	Introduction	80
3.2	Model setting	84
3.2.1	The demand side of the market	84
3.2.2	The supply side of the market	91
3.2.3	The program of the regulator	98
3.3	Simulation results	100
3.3.1	Model calibration	100
3.3.2	Numerical results for pricing	102
3.3.3	The optimal choice of the regulator	107
3.4	Conclusion	111
3.5	Bibliography	111
	Appendices	116
3.A	Variety choice under a patent regime and in the absence of a feedback effect of biodiversity	116
3.B	Effect of a change of the commercialisation rule in a patent regime . . .	119
3.C	Variety choice under a PBR regime and in the absence of a feedback effect of biodiversity	121
3.D	Comparative analysis of pricing	123
3.E	Comparative statics of oligopoly prices with respect to c_0 and σ_0 when $N = 2$	126

3.F	Isoprofit equation for the first breeder variety	127
4	Plant Breeders' Rights, Patents and Incentives to Innovate	128
4.1	Introduction	130
4.2	The model	136
4.3	Price Equilibrium, Plant Breeder Right and Patent	138
4.3.1	Plant Breeder Right Regime	139
4.3.2	Patent Regime	144
4.3.3	Choice between PBRs and Patents	145
4.4	Research Investment Decision	148
4.4.1	Plant Breeder Right Regime	148
4.4.2	Patent and Plant Breeder Right Regimes	154
4.5	Incentive to Innovate and Welfare	161
4.5.1	Incentive to Innovate	161
4.5.2	Welfare Analysis	165
4.6	Extensions and Robustness	168
4.6.1	Heterogeneous Farmers	168
4.6.2	Different Functional Forms for $\mu(I)$	175
4.7	Conclusion	176
4.8	Bibliography	178
	Appendices	181
4.A	Price Equilibrium with a PBR	181
4.B	Choice between a PBR and a Patent	181
4.C	Optimal levels of investment	182
4.D	Incentive to Innovate	190
4.E	Welfare	193
4.F	Payoffs with heterogeneous farmers	194
5	Conclusion	196

Liste des tableaux

2.1	Summary Statistics	56
2.2	Wheat Results	60
2.3	Maize Results	61
2.4	Rapeseed Results	62
2.5	Sunflower Results	63
2.6	Peas Results	64
2.7	Potatoe Results	65
2.8	Farmers' privilege impact for rapeseed	69
2.9	Farmers' privilege impact for peas	69
2.10	Farmers' privilege impact for potatoe	70
3.1	Matrix A	94
3.2	Matrix B	95
3.3	Matrix C	95
3.4	Matrix \bar{A}	96
3.5	Matrix \bar{C}	97
3.6	Parameters	101
3.7	Results with one "breeder" seed	104
3.8	Results with two "breeder" seeds	106
4.1	IPRs and methods of compensation for different countries	133
4.C.1	Results under a PBR regime	187
4.C.2	Results under a patent/PBR regime	189

4.F.1 Results with heterogeneous farmers 195

Table des figures

2.2.1 Renewal fees and annual rents	48
3.3.1 Optimal choice of Regulator at $t = 1$	107
3.3.2 Optimal choice of Breeders at $t = 1$	109
3.3.3 Optimal choice of Breeders at $t = 1$ when minimum standards are imposed	110
3.B.1 Impact of a switch from minimum standards to the catalogue	119
3.D.1 Bertrand-Nash equilibrium with $N=2$	124
4.3.1 Seed producer strategies under a PBR regime	143
4.3.2 Seed producer strategies under both PBR and patent regimes	146
4.4.1 Seed producer strategies under a PBR regime with $\theta \in [\underline{\theta}, \bar{\theta}]$	148
4.4.2 Optimal Investment under a PBR regime	152
4.4.3 Private and social optimal Investment under a PBR regime	153
4.4.4 Seed producer strategies under both PBRs and patent regimes with $\theta \in$ $\{\underline{\theta}, \bar{\theta}\}$	156
4.4.5 Optimal investment under both PBRs and patent regimes	157
4.4.6 Private and social optimal investment under both PBRs and patent regimes	158
4.4.7 Seed producer strategies under both PBR and patent regimes	160
4.4.8 Private and social optimal investments under both PBR and patent regimes	161
4.5.1 Incentive to innovate under a PBR regime	162
4.5.2 Incentive to innovate under both PBR and patent regimes	164
4.5.3 Welfare under a PBR regime	166
4.5.4 Welfare under both PBR and patent regimes	167

4.6.1	Seed producer strategies under a PBR regime with heterogeneous farmers	171
4.6.2	Seed producer strategies under both PBR and patent regimes with heterogeneous farmers	173
4.6.3	Seed producer strategies under both PBR and patent regimes with heterogeneous farmers and $\theta \in \{\underline{\theta}, \bar{\theta}\}$	174
4.C.1	Seed producer strategies under a PBR regime with $\theta \in \{\underline{\theta}, \bar{\theta}\}$	183

Sigles

- **ADPIC** : Aspects de Droits de Propriété Intellectuelle qui touchent au Commerce
- **AOSCA** : *Association of Official Seed Certifying Agencies*
- **CDB** : Convention sur la Diversité Biologique
- **CNUCED** : Conférence des Nations Unies sur le Commerce et le Développement
- **COV** : Certificat d’obtention végétale
- **CTPS** : Comité Technique Permanent de Sélection
- **CVO** : Cotisation Volontaire Obligatoire
- **ETC** : *Erosion, Technology and Concentration*
- **EPR** : *End Point Royalty*
- **DHS** : Distinction, Homogénéité, Stabilité
- **DUS** : *Distinctness, Uniformity, Stability*
- **DPI** : Droit de Propriété Intellectuel
- **EPC** : *European Patent Convention*
- **EPO** : *European Patent Office*
- **FSS** : *Farm-Saved Seeds*
- **GNIS** : Groupement National Interprofessionnel des Semences
- **IPR** : *Intellectual Property Right*
- **JPO** : *Japanese Patent Office*
- **OGM** : Organisme Génétiquement Modifié

- **ONG** : Organisation Non Gouvernementale
- **PBR** : *Plant Breeders' Right*
- **PCT** : *Patent Cooperation Treaty*
- **PPA** : *Plant Patent Act*
- **PPVFRA** : *Protection of Plant Varieties and Farmers' Rights Act*
- **PVPA** : *Plant Variety Protection Act*
- **PVP** : *Plant Variety Protection*
- **PVR** : *Plant Variety Right*
- **RR** : *Roundup Ready*
- **TRIPS** : *Trade-Related aspects of Intellectual Property Rights*
- **TUAs** : *Technology Use Agreements*
- **UE** : Union Européenne
- **UPOV** : Union internationale pour la Protection des Obtentions Végétales
- **U.S.** : *United States*
- **USDA** : *United States Department of Agriculture*
- **USPTO** : *United States Patent and Trademark Office*
- **VATE** : Valeur Agronomique Technologique et Environnementale
- **VCU** : *Value for Cultivation and Use*

Chapitre 1

Introduction

L'importance de la biodiversité est de plus en plus soulignée, comme en témoigne la mobilisation d'instances internationales telles que le CNUCED (Conférence des Nations Unies sur le Commerce et le Développement) qui a collaboré activement à la Convention sur la Diversité Biologique (CDB) de 1992. De nombreuses questions sur la biodiversité sont posées, comme sa préservation ou encore son partage. Dans le domaine agricole, son importance apparaît cruciale pour favoriser la création variétale et pour répondre le plus efficacement possible contre les nuisibles. La réduction de la biodiversité dans le domaine agricole est une idée qui s'est développée dans les deux dernières décennies. Cependant, l'appréciation que l'on peut avoir de la biodiversité est dépendante de la façon dont on la mesure. En effet, la mesure de la biodiversité se calcul à partir d'indices très simples et faciles à mettre en oeuvre à des indices plus complexes mais également plus précis.

Le rapport rédigé par la fondation pour la biodiversité (Goffaux et al., 2011), portant plus spécifiquement sur le blé tendre de 1912 à 2006 en France, illustre combien les conclusions peuvent être différentes selon la mesure retenue. Ce rapport commence avec la mesure la plus simple qui est le nombre de variétés¹ cultivées d'une espèce² sur un espace géographique donné. Ce premier indice a été multiplié par 6 ou 7 sur la période de l'analyse en raison d'une augmentation de la création variétale. Ensuite, les auteurs calculent des indices de concentration des différentes variétés dans un espace donné qui revient à calculer les parts de l'espace qui sont allouées aux différentes variétés. Ces indices sont particulièrement stables sur la période étudiée. En s'appuyant sur une mesure de la distance des caractéristiques génétiques, une troisième catégorie d'indices calcule la diversité génétique inter-variétale, c'est-à-dire entre variétés distinctes. Ces indices sont également stables sur la période. Enfin, le dernier type d'indices contient à fois la diversité génétique inter-variétale et la diversité intra-variétale. Ce dernier indice

1. Au sein d'une espèce, ces dernières constituent des populations homogènes ayant des caractéristiques propres. Par exemple, le maïs est une plante qui, en Europe, ne peut se croiser avec d'autres espèces. En revanche, les variétés cultivées de maïs (plus de 1 000) peuvent se croiser entre elles. Définition provenant du GNIS.

2. D'un point de vue scientifique, l'espèce se définit comme unité de base de la classification des êtres vivants. Ses individus peuvent se reproduire entre eux et leur descendance peut également se reproduire. Définition provenant du GNIS.

a connu une très forte réduction au cours de la période due à la démocratisation de variétés homogènes. Ainsi, les résultats sont très différents selon les indices de biodiversité retenus.

Pour soutenir la biodiversité végétale, deux visions coexistent : favoriser la diversité au sein des variétés (géotypale ou phénotypale), vision prônée par des associations ou des ONG comme Kokopeli, ou maximiser le nombre de variétés *via* la création variétale comme le soutiennent les industriels du secteur. Cette seconde vision est également soutenue par certaines puissances publiques, notamment en Europe, pour différentes raisons. L'une d'entre elles a été de développer le secteur agricole pour permettre de fournir suffisamment de nourriture, à un prix abordable, à une population en augmentation ainsi que répondre à l'objectif de l'autosuffisance alimentaire. Pour cela, un accroissement des rendements était nécessaire à la sortie de la seconde guerre mondiale. En conséquence, le développement d'une agriculture intensive et d'une création variétale plus importante paraissait essentiel. Par exemple, une étude sur une période récente montre qu'entre 1990 et 2010 la création variétale a permis une augmentation des rendements compris entre 0,93% à 1,60% par an selon les espèces (Gate et al., 2013). La création variétale joue donc un rôle très important dans l'augmentation de la productivité agricole.

Pour promouvoir la création variétale deux instruments réglementaires distincts ont été développés répondant à deux objectifs différents : les règles de commercialisation et les Droits de Propriété Intellectuel (DPI). Les règles de commercialisation répondent à un problème informationnel limitant le développement du secteur des semences agricoles. En effet, sans un signal crédible sur la qualité des semences, les agriculteurs ne peuvent pas faire la différence entre des semences de mauvaise ou de bonne qualité. Ce problème fait référence à la théorie de la sélection adverse en économie. Il faut donc, dans un premier temps, pour développer le marché des semences, créer une réglementation commerciale permettant d'envoyer un signal crédible sur la qualité des produits. Le moyen adopté pour apporter ce signal crédible, la certification qui est décrite plus précisément dans la section 3 de cette introduction, se base sur des spécificités des

semences comme le taux de germination, et induit également un phénomène de réputation. En effet, les semences certifiées ont des appellations distinctes ce qui rend illégal la commercialisation d'une autre variété sous le même nom. Les DPI permettent également de répondre à une autre défaillance : les semences ont certaines caractéristiques des biens publics. En effet, elles possèdent la caractéristique de non exclusion à travers le temps. Une fois la variété achetée, il est facile et peu coûteux de la reproduire et de la réutiliser de campagne en campagne. Des semenciers pourraient alors commercialiser une variété développée par une autre société sans avoir à supporter les coûts associés à ce développement. Les agriculteurs peuvent également reproduire cette variété pour ne plus acheter les semences à chaque nouvelle période. Cette reproductibilité donne un aspect de bien durable aux semences. Or, pour inciter les acteurs du secteur privé à investir dans la création variétale il faut leur permettre de rendre rentable cette activité comportant des coûts fixes et surtout de nombreuses années de développement³. Dans ce but, la mise en place de DPI au cours du 20ième siècle c'est faite progressivement en permettant aux semenciers d'obtenir un monopole temporaire sur la commercialisation de leur variété protégée.

Néanmoins, des choix différents ont été effectués selon les pays afin de répondre au problème d'asymétrie d'information. En effet, certaines règles de commercialisation s'arrêtent au niveau de la qualité intrinsèque des semences alors que d'autres réglementations portent également sur les produits récoltés. C'est le cas en Europe où les règles de commercialisation sont très strictes et répondent principalement aux spécificités des variétés modernes. Ces variétés modernes répondent aux besoins de l'agriculture intensive et des entreprises agroalimentaires. Cependant, des marchés de niche peuvent exister, et demander des variétés locales et anciennes ne répondant pas aux critères actuels de commercialisation. Ce cas peut être souligné à travers le mouvement des semences paysannes⁴ qui promeut une agriculture locale, plus respectueuse de la na-

3. Il faut compter onze années pour passer du début du développement à la commercialisation d'une variété (GNIS).

4. Semences sélectionnées et reproduites par les paysans dans leurs champs de production. A l'opposé des semences industrielles standardisées, ce sont des populations diversifiées et évolutives, issues de méthodes de sélection et de renouvellement naturelles, non transgressives et à la portée des paysans (sélection massale, pollinisation libre, croisements manuels, etc.). Leurs caractéristiques les rendent

ture et favorisant une biodiversité plus importante des variétés agricoles (Demeulenaere, 2013). De plus, l'éviction de variétés locales ou anciennes, par des règles de commercialisation trop strictes, est en contradiction avec l'une des visions de la conservation de la biodiversité. En effet, pour certaines associations, comme Kokopelli, la conservation de la biodiversité doit être *in-situ* c'est-à-dire que la création variétale locale doit promouvoir la biodiversité dans les champs, par opposition à la conservation *ex-situ* où la biodiversité végétale est conservée dans des « banques » de graines. Or, les règles de commercialisation très strictes en Europe ne permettent pas de commercialiser ou d'échanger ce genre de semences au niveau professionnel⁵. Malgré cette réglementation, l'association Kokopelli distribue ces variétés locales qui ne répondent pas aux critères légaux. En conséquence, en 2007, la tribunal de Nancy a condamné l'association Kokopelli pour vente illicite de semences. Cette décision a ensuite été partagée par la Cour de Justice de l'Union Européenne en 2012. Si pour certains les règles de commercialisation vont trop loin, à l'inverse pour d'autres le signal qu'elles apportent n'est pas assez fort. En effet, dans le secteur des échalotes les producteurs français se plaignent d'un signal qui n'est pas suffisant pour différencier les échalotes traditionnelles, dont la production à principalement lieu en Bretagne, et les échalotes de semis produites aux Pays-Bas. Pour les producteurs français il y a pourtant des différences très importantes aux niveaux de la mise en culture où la reproduction des échalotes traditionnelles est réalisée à partir de ses bulbes alors que celle des échalotes de semis se réalise à partir de graines. Il y a aussi pour les défenseurs des échalotes traditionnelles d'importantes différences en terme de qualité gustative.

De même, des choix relativement différents ont été fait en matière de protection intellectuelle. Ainsi, pour un certain nombre de pays la brevetabilité du vivant n'est pas acceptable éthiquement. En Europe, il n'est pas possible de breveter des variétés végétales ainsi que des procédés qui sont « essentiellement biologiques », c'est-à-dire des

adaptables à la diversité et à la variabilité des terroirs, des climats, des pratiques paysannes et des besoins humains sans nécessaire recours aux intrants chimiques. Reproductibles et non appropriables par un titre de propriété, ces semences sont échangées dans le respect de droits d'usage définis par les collectifs qui les ont sélectionnées et conservées. Définition provenant du site web infoOGM.

5. Cela peut être autorisé pour des pratiques de jardinage privé.

phénomènes naturels tel que le croisement ou la sélection végétale, tandis qu'aux États-Unis toute invention est potentiellement brevetable. Il s'ensuit des litiges notamment pour les multinationales qui transposent à des pays en voie de développement des pratiques commerciales s'appuyant sur les DPI qu'elles utilisent dans les pays développés. Par exemple, au Brésil, l'entreprise Monsanto prélevait des royalties sur les semences de ferme⁶ de variétés préalablement achetées à Monsanto. Or, cette pratique n'est pas prévue par la réglementation brésilienne. Monsanto a été condamné en 2012⁷ à arrêter de collecter les redevances et rembourser celles qui ont été perçues depuis la campagne 2003/2004.

Pour comprendre les divergences entre ces différentes pratiques réglementaires, il apparaît nécessaire de retracer l'émergence du secteur dans une première section. Les sections 2 et 3 sont consacrées à la discussion des fondements et de l'évolution de la réglementation, respectivement pour les règles de commercialisation et les DPI. Dans la section 4 nous proposons une revue de la littérature en sciences économiques qui aborde ces questions et nous discutons de notre contribution et comment les trois chapitres de la thèse complètent la littérature ou comblent certains de ses vides.

1.1 D'une activité paysanne à la domination des semenciers

L'agriculture est née grâce à la domestication du monde végétal et animal en sélectionnant les espèces qui avaient le plus d'intérêt. Cela a eu lieu durant la révolution du néolithique, il y a plus de 10 000 ans. La sélection restera durant des siècles et des millénaires une activité réalisée par les paysans qui adaptent les espèces aux conditions climatiques et locales en créant des multitudes de variétés différentes. Au fil des siècles, deux méthodes de sélection apparaissent : la première consiste à choisir directement dans les champs les variétés que l'on souhaite conserver pour la campagne suivante

6. La semence fermière est prélevée sur la récolte de grains et triée par l'exploitant lui-même. Définition provenant du GNIS.

7. Décision du tribunal du Rio Grande do Sul.

(sélection massale), l'autre technique est un croisement manuel pour les plantes autogames⁸ où l'agriculteur « castre » l'un des épis et dépose le pollen d'une autre plante sur cet épis « castré ». Le début de la première révolution agricole ne changera aucunement ce processus millénaire. Il faut attendre le 19^{ème} siècle pour voir des réussites entrepreneuriales fondées sur la spécialisation dans la sélection du végétal.

En France, l'un des premiers sélectionneurs reconnu est Henry de Vilmorin qui créa les premières variétés de lignés pures qui sont aujourd'hui définies comme une souche où tous les individus sont identiques et homozygotes (deux allèles identiques). Les lois de Mendel en 1866⁹, qui définissent la transmission des gènes de génération en génération, permettent de poser les bases scientifiques au développement de la création variétale moderne. En conséquence, au début du 20^{ème} siècle commencent à être développées les variétés hybrides F1 notamment avec la société Pioneer Hi-Bred née en 1926 aux États-Unis. La création d'une variété hybride F1 consiste à croiser deux variétés de lignés pures différentes pour bénéficier de la « vigueur » hybride nommé *heterosis*. Le croisement des deux variétés de lignés pures, créant un « brassage » génétique, a pour conséquence un gain potentiel en terme de rendement, par exemple. Cependant, la seconde génération sera marquée par une dégénérescence des propriétés présentant les intérêts de la première génération. Les semences de ferme s'avèrent alors beaucoup moins intéressantes pour les agriculteurs. Les variétés hybrides apportent, donc, une appropriation plus forte de la création variétale que les variétés de lignés pures car les agriculteurs ne vont plus utiliser de semences de ferme.

Les règles commerciales et les DPI n'existant pas encore (fin 19^{ème} siècle), les semences sont donc encore considérées comme des biens en partie publics. De plus, il est primordial pour certaines puissances publiques de développer leur secteur agricole. C'est notamment le cas des États-Unis qui cherchent à développer et renforcer leur indépendance alimentaire et agricole. En outre, les variétés en provenance de l'Europe ne sont pas complètement adaptées aux conditions locales que l'on peut trouver aux États-

8. Une plante hermaphrodite qui s'autoféconde.

9. Cependant les réactions du monde scientifique à cette époque restent inexistantes. Il faut attendre leurs redécouvertes en 1900 par Vries, Correns et von Tschermak pour que les travaux de Mendel soit répliqués et développés.

Unis. Il faut donc sélectionner de nouvelles variétés adaptées aux conditions locales et faire en sorte que les agriculteurs ne manquent pas de semences pour la campagne suivante. Ainsi, en 1839, l'US Patent and Trademark Office (USPTO), qui vient de créer une division agricole, lance un programme de collecte et de redistribution gratuite des semences. Cette activité sera reprise par l'US Department of Agriculture (USDA) lors de sa création en 1862 et représentera un tiers de son budget.

Au début du 20^{ième} siècle, en Europe comme aux États-Unis les semenciers commencent à faire pression pour favoriser le développement du secteur privé. Pour cela une première vague de règles de commercialisation mais aussi la création de DPI (Plant Patent Act en 1930 aux USA) vont voir le jour ainsi que l'arrêt de la distribution des semences par l'USDA en 1924. Additionnée à l'arrivée des variétés de lignés pures et des variétés hybrides, le développement du secteur privé devient plus important. Cependant, c'est surtout après la seconde guerre mondiale et l'arrivée de nouvelles règles commerciales favorisant les variétés modernes en Europe et le développement de DPI pour l'ensemble des espèces végétales en Amérique du Nord comme en Europe que la part du secteur privé va augmenter dans la dépense en recherche et développement (R&D). Ainsi aux États-Unis la dépense en R&D du secteur privé a dépassé celle du secteur public au cours des années 1980 (Fernandez-Cornejo, 2004). Dans l'ensemble des pays développés c'est au milieu des années 1990 que la dépense en R&D privée atteint le niveau de dépense en R&D publique alors qu'elle ne représente encore que 5% pour les pays en développement (Pardey and Beintema, 2001).

Actuellement, aux États-Unis, la dépense en R&D du secteur privée compte pour plus des 2/3 des dépenses totales (Moschini, 2010). Celle-ci est due à une appropriation des innovations plus importante grâce à une diminution des semences de ferme suite à une hybridation de plus en plus importante et également l'apparition des Organismes Génétiquement Modifiés (OGM), à l'instar des espèces Roundup Ready (RR). Ces variétés sont résistantes aux Roundup (commercialisées par Monsanto) et permettent ainsi un épandage massif de ce produit. Incidemment, les espèces RR se prête à une vérification rapide de l'utilisation de semences de ferme illégales dans les champs des

agriculteurs. En effet, il suffit de pulvériser avec du désherbant Roundup quelques plants dans les champs des agriculteurs pour savoir si ces plants sont porteurs du gène appartenant à Monsanto. De plus, les principaux acteurs ne sont plus des petites et moyennes entreprises mais sont dorénavant des multinationales ayant des liens importants dans l'industrie chimique et/ou pharmaceutique permettant de réaliser des investissements plus coûteux. D'après l'*Erosion, Technology and Concentration (ETC) group*, en 2009 les 10 premiers groupes mondiaux représentent 74% du marché mondial contre 63% en 2007¹⁰. La concentration assez récente de ce marché provient en grande partie d'un nombre important d'acquisitions qui a commencé à partir du milieu des années 90, avec par exemple le rachat de Pioneer Hi Bred, leader dans le secteur du maïs hybride aux États-Unis, par DuPont (Howard, 2009). L'évolution de la concentration est encore plus frappante si l'on s'attarde sur des secteurs particuliers : aux États-Unis, les variétés de maïs de Monsanto représentent 21,8% des surfaces plantées en maïs en 2000 et passent ensuite à 81,1% en 2009 (Moschini, 2010). On retrouve également cette concentration dans les DPI. Ainsi, les brevets d'utilité concernant le maïs et le soja sont partagés respectivement à 80,4% et 63,6% entre Monsanto et DuPont (Moschini, 2010). Les Certificats d'Obtention Végétale (COV), présentés plus bas, ne sont pas en reste. En effet, les 10 premiers obtenteurs possèdent, aux États-Unis, 95,4% des COV sur le maïs ou encore 87% des COV sur le soja. En France, on retrouve des chiffres similaires avec, pour le blé, 73,5% des COV répartis entre 10 obtenteurs. La concentration la plus importante se trouve pour le colza avec un chiffre atteignant 94,6% (Srinivasan, 2003).

1.2 Réglementation commerciale

La première vague de réglementation commerciale se met en place au début du 20ième siècle. La première loi, en France, exclusivement dédiée au marché des semences est établie en 1922. Cette loi crée un registre des semences ainsi qu'un comité de contrôle. Le but étant d'empêcher l'utilisation frauduleuse de la dénomination de certaines va-

10. Dont Monsanto, Dupont/Pioneer Hi-Bred, Syngenta, Limagrain, Land O' Lakes, KWS, Bayer, Dow, Sakata et DLF Trifolium.

riétés. La dénomination des variétés inscrites dans le registre est protégée pendant une période de 12 ans. Ensuite, en 1932, une nouvelle loi crée le « catalogue des espèces et variétés de plantes cultivées ». Le but est de nouveau la protection du nom des variétés et empêche que deux variétés distinctes aient la même appellation ou qu'une variété ait différentes appellations. Dans le même période, en 1919, aux États-Unis, l'*International Crop Improvement Association* qui deviendra par la suite *the Association of Official Seed Certifying Agencies* (AOSCA) est créée par des universitaires américains. Le but de cette association est d'aider les producteurs et les consommateurs de semences agricoles à produire, identifier, distribuer et promouvoir les semences et plants agricoles. Dès le départ, cette organisation est internationale pour permettre au Canada d'en faire parti. D'autres pays s'y joindront, par la suite : l'Afrique du Sud, l'Australie, la Nouvelle Zélande mais également le Brésil et l'Argentine. L'AOSCA met en place une certification volontaire des semences dans le but de signaler la qualité de certaines variétés. Pour cela, différents tests sont effectués sur les variétés (test de pureté, de germination, etc.). Une première différence dans la création d'un signal crédible entre les États-Unis et la France est qu'aux États-Unis la sphère privée met en place le signal crédible, alors qu'en France cela passe par les pouvoirs publics.

Une seconde vague de règles de commercialisation a lieu durant les années 1940. Aux États-Unis, il y a la mise en place du *Federal Seed Act*¹¹, en 1940, qui va réglementer la commercialisation des semences importées et des semences vendues entre les différents états américains. À cette législation au niveau fédéral s'ajoute dans chaque état une régulation locale. Des agences sont mises en place dans chaque états pour faire respecter la législation en place et aussi certifier les variétés. Les semences commercialisées doivent être étiquetées avec un certain nombre d'informations comme, par exemple, le taux de germination attendu. Généralement, Il n'y a pas de standard obligatoire à respecter mais la véracité des informations étiquetées peut être testée par les agences. La certification reste volontaire et est réalisée en coordination avec l'AOSCA qui a créé les *Variety Review Boards* (VRB) donnant un avis sur la certification possible des variétés.

11. Le *Federal Seed Act*, accessible sur <http://www.ams.usda.gov/AMSV1.0/getfile?dDocName=STELPRD3317283>, dernier accès en mars 2015.

Cependant, celle-ci reste à la discrétion de chaque agence au sein de chaque état. En France, pour évaluer les performances des semences, deux agences vont être instituées : le Groupement National Interprofessionnel des Semences et plants (GNIS) en 1941 et le Comité Technique Permanent de la Sélection (CTPS) en 1942. Le décret 49-773 du 11 juin 1949 rend obligatoire l'inscription au catalogue officiel pour toutes les nouvelles variétés, importées ou non, dont les semenciers souhaitent la commercialisation. Ce décret impose également les principaux critères pour qu'une semence puisse être inscrite au catalogue, par exemple la pureté, la faculté germinative ou encore l'état sanitaire. Une nouvelle différence voit le jour entre les États-Unis où la certification est volontaire, et la France où l'inscription au catalogue officiel est obligatoire.

Avec le développement du marché commun en Europe, il a été nécessaire d'uniformiser au niveau européen les règles de commercialisation des semences. Ainsi, des catalogues européens ont été créés pour un certain nombre d'espèces à partir des années 1970¹². Pour qu'une variété soit dans un catalogue européen il faut simplement qu'elle soit déjà présente dans un catalogue national. La régulation du secteur des semences passe, dorénavant, d'abord par l'Europe et est ensuite appliquée dans chacun des états membres.

En 1981, en France, le décret 81-605 rappelle que seules les variétés inscrites au catalogue peuvent être commercialisées. De plus, pour être inscrite au catalogue une variété doit respecter une triple condition : être Distincte, Homogène et Stable, résumé par le critère DHS. Ce critère est en lien avec les Certificats d'Obtention Végétale qui seront présentés dans la section suivante. La distinction demande que la variété soit suffisamment différente de toutes celles qui sont déjà connues. L'homogénéité nécessite que les particularités de la variété soit suffisamment uniforme, c'est notamment le cas pour les variétés de lignés pures modernes ainsi que les hybrides F1. Enfin, la stabilité exige que l'homogénéité de la variété soit conservée à la suite de plusieurs reproductions ou multiplications.

12. Directives 70/457/CEE et 70/458/CEE, accessibles sur <http://eur-lex.europa.eu/legal-content/en/ALL/?uri=CELEX:31970L0457> et <http://eur-lex.europa.eu/legal-content/EN/TXT/?qid=1427467214212&uri=CELEX:31970L0458>, dernier accès en mars 2015.

Ainsi, au cours du 20^{ième} siècle, les critères pour commercialiser une variété végétale sont devenus de plus en plus exigeants en France et en Europe alors qu'aux États-Unis seules certaines normes doivent être respectées pour le commerce à travers différents états et le commerce international mais la certification restent encore volontaire. Le signal crédible permettant de faire disparaître les problèmes informationnels du marché des semences a donc été mise en place mais des conséquences négatives peuvent apparaître pour le système européen. En effet, la solution apportée par la théorie économique est de mettre en place un signal crédible mais pas de le rendre obligatoire. En rendant obligatoire le respect de normes exigeantes, il y a un risque de voir disparaître un certain nombre de variété ne pouvant pas répondre à ces critères, notamment les semences anciennes, appelées semences de population (Tripp et Louwaars, 1997).

Aujourd'hui, en Europe, cinq étapes doivent être respectée dans la réglementation commerciale des semences. La première étape consiste à répondre au critère DHS. La seconde, qui ne concerne que les espèces de grande culture, teste les performances de la variété. Ce test est nommé Valeur Agronomique Technologique et Environnementale (VATE) ou encore *Value for Cultivation and Use* (VCU). Pour réussir ce test la variété doit montrer des gains de rendements ou une meilleur réponse face aux nuisibles ou encore une utilisation plus efficace des intrants chimiques par rapport aux variétés déjà existantes. Ces deux tests, s'ils sont réussis, donnent accès à la troisième étape qui est l'inscription au catalogue et l'autorisation de mise sur le marché. Jusqu'ici, ces étapes ne concernaient que du matériel végétal apporté par le semencier, le créateur de la variété. Ensuite la quatrième étape est la certification qui est basée sur le début de la production, dans les champs, des semences par les agriculteurs multiplicateurs qui se servent de la semence de base provenant du semencier. La certification permet, notamment, de vérifier que les caractéristiques des semences produites respectent bien la variété de départ du semencier qui a été inscrite au catalogue. Enfin la dernière étape, le contrôle de qualité, qui permet de se faire une idée globale des qualités intrinsèques des lots de semences qui seront vendus aux agriculteurs et leurs permettront de faire un choix entre les différentes variétés qui leurs sont proposées.

Plus récemment, la CDB, dont l'Europe est signataire, impose de mettre en place une conservation *in-situ* des espèces végétales. Jusque là, la réglementation européenne avec le critère DHS ne permettait pas aux variétés anciennes de pouvoir être commercialisées ou échangées entre les agriculteurs. En effet, les variétés anciennes sont très hétérogènes et instables à travers les générations et ne peuvent donc pas répondre au critère DHS. L'Europe a donc mis en place des critères moins exigeants pour des variétés dites de conservation¹³. Cependant, pour les associations comme le « réseau de semences paysannes » ces critères paraissent encore trop exigeants pour certaines variétés de population qui sont très hétérogènes.

Au-delà de la réglementation européenne et américaine, les pays émergents ont également développé des règles commerciales très similaires. Par exemple, en Inde, avant 2004, la certification n'était pas obligatoire et il n'y avait pas de registre pour les variétés provenant du secteur de la création variétale privée. Cependant, après la réforme sur la commercialisation des semences, avec *the Seed Bill*, la certification reste optionnelle mais l'enregistrement des variétés est devenu obligatoire. Dans ce but, les variétés doivent passer le test VCU. Au Brésil, les variétés doivent également passer le test VCU pour être inscrites dans le registre national. En Afrique du Nord, comme, par exemple, au Maroc ou en Algérie, les tests DHS et VCU doivent être, comme en Europe, passés avec succès pour commercialiser une variété.

1.3 Les Droits de Propriété Intellectuelle

L'innovation est fondamentale pour promouvoir la croissance économique. Elle permet, notamment, de réaliser des gains de productivité *via* la création de nouveaux produits ou encore de nouveaux procédés de fabrication. Toutefois, les coûts fixes et le temps imparti à son développement sont souvent très importants. En conséquence, s'il n'y a pas de contreparties incitatives, les innovations risquent d'être trop souvent

13. Directives 98/95 et 2008/62, accessibles sur <http://eur-lex.europa.eu/LexUriServ/LexUriServ.do?uri=OJ:L:1999:025:0001:0026:FR:PDF> et <http://eur-lex.europa.eu/LexUriServ/LexUriServ.do?uri=OJ:L:2008:162:0013:0019:FR:PDF>, dernier accès en mars 2015.

rares ou venant seulement des pouvoirs publiques. Les premiers outils mis en place pour inciter les entrepreneurs à innover sont les brevets. Les premières lois sur les brevets sous leurs formes contemporaines ont été promulguées en 1623 au Royaume-Uni, en 1790 aux États-Unis et en 1791 en France. Les brevets donnent un droit d'exclusivité sur les développements technologiques, quels qu'ils soient, et sur les applications commerciales des inventions brevetées. Le premier brevet sur un organisme vivant a été accordé en 1843, en Finlande (Gros, 2001). Il faut attendre 1865, en France, et 1873, aux États-Unis, pour voir les premiers brevets concernant une souche de levure brevetée par Louis Pasteur. Cependant, il faut noter qu'à cette époque, la levure n'est pas encore considérée comme un organisme vivant. À partir de 1889, le commissaire aux brevets de l'USPTO, prend la décision que les plantes préexistantes dans nature ne peuvent pas être brevetables, sinon il deviendrait possible d'exclure le reste des hommes de leur utilisation alors même qu'à l'origine elles sont librement disponibles à tous dans la nature :

« *It would be possible for an element or a principle to be secured by patent, and the patentee would obtain the right, to the exclusion of all other men, of securing by his new process from the trees of the forest [...] the fiber which nature has produced and which nature has intended to be equally for the use of all men.* »¹⁴

Pour autant, au cours du 20^{ième} siècle, la brevetabilité du vivant va commencer à se développer. Les premiers DPI du végétal apparaissent entre les deux premières guerres mondiales. À partir de 1930, aux États-Unis, le *Plant Patent Act* (PPA) va permettre de breveter les variétés végétales dont la multiplication est « asexuée ». Cela concerne principalement l'horticulture et l'arboriculture, les plantes multipliées par tubercule, comme les pommes de terre, ne peuvent pas faire appel au PPA. Pour accéder au PPA, il faut que la plante soit nouvelle, différente de celles qui sont déjà connues, stable après reproduction et l'invention ne doit pas être évidente pour ceux travaillant dans ce secteur (*nonobviousness*). Le *plant patent* a une durée de 20 ans après la date de dépôt

14. *Ex parte* Latimer, 1889 Dec. Comm'r. Pat. 123, 126, 46 O.G. 1638, 1639, accessible sur <http://patentltyo.com/media/docs/2012/05/1889deccommrpat123-ex-parte-latimer.pdf>, dernier accès en mars 2015.

et permet d'obtenir un monopole sur la reproduction, la vente ou toute utilisation de la plante protégée. En Europe, des choix différents seront fait selon les pays. En Allemagne, à partir de 1932, un nouveau processus de production ou une nouvelle plante sont des inventions pouvant être brevetées (Llewelyn et Adcock, 2006). La même année, en France, un « registre des plantes sélectionnées de grande culture » est introduit dans la loi pour protéger les nouvelles variétés¹⁵. Le commerce de ces variétés nécessite l'autorisation de l'obtenteur. De plus, la protection dure six années et est renouvelable une fois. En 1941, les Pays-Bas mettent en place un système de protection, le *Het Kwekersbesluit* qui existera jusqu'en 1966. Après la seconde guerre mondiale, l'Autriche adoptera également un système spécifiquement dédié aux variétés végétales en 1946, ainsi que l'Allemagne en 1953. L'Italie commence à accorder des brevets sur les plantes à partir de 1951. D'autres pays comme le Royaume-Uni n'auront aucun système de protection pour les variétés végétales (Llewelyn et Adcock, 2006).

Malgré la possibilité de breveter des variétés dans certains pays, il est en réalité très difficile d'obtenir un brevet pour une nouvelle variété végétale car les conditions pour obtenir un brevet sont souvent trop strictes pour la création variétale. La nécessité de créer un système uniformisé et plus efficace va alors émerger en Europe et un premier système harmonisé verra le jour en France à la suite de la conférence pour la protection des obtentions végétales en 1961. La convention UPOV (Union internationale pour la Protection des Obtentions Végétales) va mettre en place un droit de propriété *sui generis* concernant l'ensemble des espèces végétales. La convention UPOV sera ensuite révisée en 1972, 1978 et 1991¹⁶. Actuellement, 72 pays ont signé une convention UPOV : 52 pays sont sous la convention de 1991, 19 pays sous la convention de 1978 et 1 pays sous celle de 1961 (Giovanoli, 2014). Ce droit de propriété *sui generis* est appelé Certificat d'Obtention Végétale (COV) en France et PBR (*Plant Breeders' Right*) ou PVR (*Plant Variety Right*) ou encore PVP (*Plant Variety Protection*) dans les pays anglo-saxons. Pour obtenir un COV, une variété végétale doit être nouvelle, distincte,

15. JORF du 19 novembre 1932, page 12066. Les JO avant 1947 ne sont pas accessibles sur le site Légifrance.

16. Convention UPOV de 1991, accessible sur <http://www.upov.int/upovlex/fr/conventions/1991/act1991.html>, dernier accès en mars 2015.

homogène, stable¹⁷ et avoir une appellation différente de celles déjà existantes. Il est nécessaire d'obtenir l'autorisation de l'obtenteur pour produire, reproduire, conditionner les semences dans l'objectif de reproduction ou multiplication ainsi que pour la vente ou toute forme de commercialisation, l'importation et l'exportation de la variété protégée. La durée du droit peut s'étendre à 20 années, 25 années pour les vignes et les arbres, à partir de la date d'obtention. Cependant, il y a des exceptions aux droits de l'obtenteur. La variété protégée peut être utilisée sans l'accord de l'obtenteur, soit pour des raisons privées et dans un but non lucratif, soit à titre expérimental, soit pour la création variétale, soit sous forme de semences de ferme. Les deux dernières exceptions sont les plus importantes et les plus discutées. Elles sont appelées respectivement l'exemption de recherche et l'exemption de l'agriculteur ou privilège de l'agriculteur. L'exemption de recherche permet de prendre en compte l'une des spécificités des variétés végétales. Les innovations dans la création variétale sont, en effet, essentiellement cumulatives. Plus précisément, il est nécessaire d'avoir des variétés parentes pour créer une nouvelle variété. Si les variétés parentes nécessaires à la création variétale étaient protégées, alors cela pourrait freiner l'innovation dans ce secteur. Le chapitre 3 analyse, notamment, cette exemption. Ensuite, l'exemption de l'agriculteur vise à prendre en compte une autre spécificité de ce secteur. Depuis des siècles, les agriculteurs sélectionnent une partie de leur récolte pour la réutiliser comme semence à la saison suivante. C'est de cette façon que jusqu'à la fin du 19^{ième} siècle la création variétale a eu lieu. Les semences de ferme sont pour beaucoup d'agriculteurs un droit inaliénable provenant d'une pratique ancestrale. Le chapitre 4 s'intéresse, en partie, à l'impact de cette exemption. Néanmoins, la convention UPOV de 1991 vient remettre en cause une partie de ces deux exemptions. Premièrement, elle introduit les variétés « essentiellement dérivées » qui sont des variétés dérivées de la variété initiale et conservent ses caractères essentiels. L'obtenteur acquiert les mêmes droits sur les variétés essentiellement dérivées de sa variété initiale. Deuxièmement, l'utilisation des semences de ferme est toujours possible mais à la condition de la « sauvegarde des intérêts légitimes de l'obtenteur ». Cela aura

17. Cela fait référence au critère DHS expliqué plus haut.

pour conséquence la mise en place de *royalties* sur les semences de ferme dans différents pays.

Aux États-Unis, c'est en 1970 que sont mis en place les COV avec le *Plant Variety Protection Act* (PVPA)¹⁸. Cet acte ne concerne que les variétés sexuées et ne prend pas en compte les variétés hybrides F1 ni les plantes multipliées par tubercule. L'exemption de l'agriculteur est très importante aux États-Unis car elle autorise la revente des semences de ferme. La durée des droits est de 18 ans. La réforme du PVPA en 1994, pour se mettre en conformité avec la convention UPOV de 1991, permet, toujours, l'utilisation des semences de ferme sans aucune contrepartie mais interdit dorénavant leur revente. Les variétés hybrides F1 et les plantes multipliées par tubercule peuvent également être protégées par ce système et la durée des droits passe alors à 20 ans. C'est également dans les années 1970 que la France met en place un système de COV. Ce système est régi par l'article L623 du code de la propriété intellectuelle¹⁹. Avant 2011, l'exemption de l'agriculteur n'était pas inscrite dans la loi mais acceptée dans les faits. Cependant, contrairement aux États-Unis, la revente de semences de ferme a toujours été strictement interdite. La durée des droits est passée en 2006 à 25 ou 30 ans selon les espèces. Fin 2011, le système de protection végétale en France est réformé pour se conformer au droit européen et à la convention de l'UPOV de 1991. De plus, depuis 1995 une variété végétale peut-être directement protégée dans l'ensemble des pays de l'Union Européenne (UE). Le système de COV européen est rattaché à la convention de 1991 et prévoit que pour 20 espèces, dont le blé tendre, les semences de ferme sont autorisées mais sujettes à une contrepartie que chaque état membre doit mettre en place sur son territoire²⁰. Les droits ont une durée de 25 à 30 ans selon les espèces.

Concernant la brevetabilité des variétés végétales, les États-Unis et L'UE ont pris

18. Le PVPA accessible sur <http://www.ams.usda.gov/AMSV1.0/getfile?dDocName=STELDEV3002796>, dernier accès en mars 2015.

19. Article L623 du code de la propriété intellectuelle accessible sur <http://www.legifrance.gouv.fr/affichCode.do?idArticle=LEGIARTI000024958437&idSectionTA=LEGISCTA000006179068&cidTexte=LEGITEXT000006069414&dateTexte=20150401>, dernier accès en mars 2015.

20. Directive 2100/94 accessible sur <http://eur-lex.europa.eu/LexUriServ/LexUriServ.do?uri=CELEX:31994R2100:FR:HTML>, dernier accès en mars 2015.

des directions très différentes. En Europe, en 1963, la convention du conseil de l'Europe laisse la liberté pour chaque état d'autoriser la brevetabilité des variétés végétales et des procédés essentiellement biologiques ce qui permet, à cette époque, de prendre en compte la diversité des systèmes qui existait en Europe. En 1973 un autre choix est fait, la Convention sur le Brevet Européen (EPC) exclut les variétés végétales, les races animales et les procédés essentiellement biologiques de la brevetabilité. Depuis de cette date, la seule protection possible pour les variétés végétales, en Europe, est le système COV. Malgré cette réglementation, certaines variétés végétales ont pourtant été brevetées comme un chou broccoli par *Plant Bioscience* ou encore une tomate ridée par le ministère israélien de l'agriculture. De plus, avec l'apparition des Organismes Génétiquement Modifiés (OGM), il est possible de breveter des traits ou caractères d'une plante n'étant pas à l'origine présents dans la plante. Néanmoins, la plante en elle-même n'est pas brevetable. Très récemment, le *European Patent Office* (EPO) a pris la décision d'autoriser le produit des plantes comme les fruits ou les semences à être brevetables sous la convention EPC²¹. Aux États-Unis, un important changement a eu lieu en 1980, avec une opposition sur la brevetabilité de micro-organismes entre Diamond et Chakrabarty²². Jusqu'en 1980, l'unique être vivant à avoir été breveté aux États-Unis était la souche de levure de Louis Pasteur en 1873 (Kevles, 1994). La cour d'appel fédérale américaine va faire grandement évoluer la doctrine, passant d'une volonté de ne pas breveter ce qui touche au monde du vivant à, possiblement, breveter tout ce qui est inventé par l'homme (« *anything under the sun that is made by man* »). En conséquence, dès 1985 une première variété végétale est brevetée²³. D'autres décisions de la cours d'appel, de même nature, suivront, la dernière souvent citée étant le cas J.E.M. Ag Supply et Pioneer Hi-Bred pour lequel la cours d'appel américaine prend la décision

21. La décision est accessible sur http://www.ip-watch.org/2015/04/01/epo-backs-patents-on-conventional-plants-broccoli-tomato-cases-decided/?utm_source=IP-Watch+Subscribers&utm_campaign=73816812f8-MONTHLY_SUMMARY&utm_medium=email&utm_term=0_b78685696b-73816812f8-352155405, dernier accès en mars 2015.

22. Le cas Chakrabarty est accessible sur <http://caselaw.lp.findlaw.com/cgi-bin/getcase.pl?court=us&vol=447&invol=303>, dernier accès en mars 2015.

23. Ex parte Hibberd, lexsee 227 USPQ 447, accessible sur http://www.iplawusa.com/resources/227_USPQ_443.pdf, dernier accès en mars 2015.

qu'une variété végétale peut être protégée *via* le PPA ou le PVPA et, également, par un brevet d'utilité ou une combinaison de ces différents instruments²⁴. Pour obtenir un brevet d'utilité, il faut que l'invention soit nouvelle, utile et sa conception doit être inventive dans le sens où elle ne doit pas être évidente par rapport aux connaissances techniques (*nonobviousness*). Le brevet donne une exclusivité totale sur l'utilisation de l'invention. L'exemption de recherche et celle de l'agriculteur n'existent donc pas dans ce cadre. D'autres pays permettent, également, de breveter une variété végétale comme le Japon, l'Australie ou encore la Nouvelle Zélande. Cependant, les variétés végétales répondent rarement au critère d'inventivité dans ces pays alors que c'est le cas aux États-Unis (Curtis et Nilsson, 2012).

Suite aux accords sur les Aspects de Droits de Propriété Intellectuelle qui touchent au Commerce (ADPIC)²⁵ en 1994, les pays membres de l'OMC doivent mettre en place un système de brevet ou un système *sui generis* ou une combinaison des deux pour protéger les inventions impliquant des végétaux ou des animaux autres que les micro-organismes. À cette date, une grande partie des pays développés avait déjà mis en place un système de protection pour les variétés végétales. Dans les pays en développement, la brevetabilité du vivant n'est pas acceptée pour des raisons, en partie, éthiques et éventuellement économique compte tenu de la charge financière supplémentaire que peuvent représenter ces systèmes pour les agriculteurs. La Chine et le Brésil ont opté pour le système de l'UPOV. Cependant, ils ont choisi la convention de 1978 qui permet de conserver une exemption de l'agriculteur totale. L'Inde est un cas particulier car elle n'est pas membre de l'UPOV mais elle a mis en place un système similaire (*the Protection of Plant Varieties and Farmers' Rights Act*, PPVFRA²⁶). Ce système donne la possibilité de protéger la création variétale provenant des agriculteurs ainsi que les anciennes variétés provenant de l'activité de recherche publique (Ramanna et Smale, 2004 ; Ramanna, 2006).

24. Le cas *J.E.M. Ag Supply versus Pioneer Hi-Bred* est accessible sur <http://caselaw.lp.findlaw.com/scripts/getcase.pl?court=US&vol=000&invol=99-1996>, dernier accès en mars 2015.

25. ADPIC, accessible sur https://www.wto.org/french/docs_f/legal_f/27-trips.pdf, dernier accès en mars 2015.

26. PPVFRA, accessible sur <http://agricoop.nic.in/PPV&FR%20Act,%202001.pdf>, dernier accès en mars 2015.

Comme il a déjà été dit précédemment la convention UPOV 1991 restreint l'exemption de l'agriculteur. La mise en place de *royalties* sur les semences de ferme dans les pays développés est assez récente. En France, une Cotisation Volontaire Obligatoire (CVO) a été établie en 2001 pour le blé tendre. La CVO est en cours d'extension à d'autres espèces suite à la réforme de 2011. Les *royalties* sur l'achat de semences certifiées et sur les semences de ferme (la CVO) sont décidées au niveau sectoriel par les représentants des semenciers et des agriculteurs. La CVO est payée, en bout de chaîne, sur la production des agriculteurs et elle est plus faible que les *royalties* sur les semences certifiées. S'ils rachètent des semences certifiées pour la campagne suivante, les agriculteurs auront un rabais sur les royalties des semences certifiées pour ne pas la payer deux fois. Au Royaume-Uni, les *royalties* sont payées selon les déclarations des agriculteurs. Cependant, une grande partie des semences de ferme sont traitées par des sites spécialisés qui font directement payer les *royalties* sur leur facture ce qui permet de conserver un système efficace (Giovanolli, 2014). En Australie, les *royalties* sont payées sur la production²⁷ et leurs tarifs sont les mêmes entre semences certifiées et semences de ferme et ils sont choisis par chaque obtenteur et non pas au niveau sectoriel. En Amérique du Nord, il n'y a, pour le moment, aucun système de *royalty* mis en place sur les semences de ferme.

Au-delà des brevets et des COV, d'autres moyens existent pour protéger une variété végétale. Tout d'abord, les variétés hybrides permettent de faire disparaître les semences de fermes à cause d'une baisse de rendement substantielle pour les semences de seconde génération. C'est par exemple le cas pour les variétés de maïs où les variétés hybrides représentent l'ensemble du marché. De plus, avec les progrès dans le domaine génétique, il est possible de rendre les semences infertiles, c'est ce qu'on appelle variétés « *terminator* ». Cependant, ces variétés ne sont pas commercialisées et même, parfois, interdites. La mise en place de contrats entre agriculteurs et semenciers aux États-Unis permet aux semenciers de renforcer leur DPI en interdisant la production de semences de ferme²⁸. Enfin, une fois que le droit de propriété est épuisé, il est toujours possible

27. *End Point Royalty (EPR) system.*

28. *Technology Use Agreements (TUAs).*

de conserver le nom d'une marque permettant de conserver un niveau d'appropriabilité, plus faible, de son invention.

1.4 Revue de la littérature

Les droits de propriété intellectuelle dans le domaine du végétal ont été assez largement étudiés dans la littérature économique. De nombreuses descriptions et approches factuelles de ces DPI ont été réalisées, notamment par Lesser (1999, 2000), Louwaars et al. (2005) et Trommetter (2008). Graff et al. (2003) ont montré, en utilisant les données provenant de l'USPTO, de l'EPO, du *Japanese Patent Office* (JPO) et du *Patent Cooperation Treaty* (PCT), que les dépôts de brevets concernant les biotechnologies ont fortement augmenté, et plus spécifiquement aux États-Unis au cours des années 2000. De même, Louwaars et al. (2009) ont montré une même tendance pour les COV néerlandais excepté qu'il y a eu une très forte diminution à partir de la moitié des années 1990. Ceci est dû à la mise en place des COV européens qui ont remplacé une grande partie des COV nationaux en Europe. Les DPI dans ce domaine sont donc plus nombreux. En conséquence, leur impact est également de plus en plus étudié dans la littérature économique que l'on peut séparer en quatre branches distinctes : i) des contributions empiriques sur les rendements agricoles, la recherche et développement ainsi que sur la valeur des COV ii) des analyses empiriques et théoriques de l'impact des COV sur le bien être, iii) des modèles théoriques examinant l'exemption de recherche, ce qui peut être relié à la littérature sur les innovations cumulatives et iv) des modèles théoriques qui étudient l'exemption de l'agriculteur.

La première branche se concentre sur des analyses empiriques de l'impact des COV sur la croissance de la productivité agricole. Les résultats varient selon la culture et le pays étudiés. L'une des premières contributions, Perrin *et al.* (1983) utilise des données sur des variétés d'essai en culture de 1960 à 1979, dans trois différents états des États-Unis, pour évaluer l'augmentation des rendements pour le soja. Les auteurs trouvent que l'adoption des COV a eu un impact positif et significatif sur la tendance à la hausse

du rendement agricole. En utilisant, également, des variétés d'essai en culture, Babcock et Foster (1991), pour le tabac de 1954 à 1987, et Alston et Venner (2002), pour le blé de 1950 à 1993, ne trouve pas d'effet positif significatif des COV sur le rendement agricole. Avec des données concernant du blé commercial, de 1950 à 1994, Alston et Venner (2002) mettent en évidence un résultat similaire alors que Carew et Devadoss (2003), avec des données en panel, décèlent un effet positif mais limité des COV. En utilisant, la même méthodologie que Carew et Devadoss (2003), Naseem et al. (2005) ont analysé des données en panel pour le coton aux États-Unis, couvrant la période de 1950 à 2000. Leurs résultats montrent un impact positif et significatif des COV. Plus récemment, Carew et al. (2009) essaient de mettre en lumière les facteurs influençant le rendement du blé et du canola, dans la province canadienne du Manitoba de 2000 à 2006, en étudiant les fonctions de rendement moyen et de variance des rendements. Ils trouvent un impact positif et significatif quoique faible des COV. Selon Kolady et Lesser (2009), il est difficile d'être exhaustif sur des variables comme l'impact météorologique lorsque l'étude est menée sur des données commerciales du blé. C'est la raison pour laquelle ces auteurs reprennent des données portant sur du blé d'essai en culture dans l'état américain de Washington de 1975 à 2006. Ils reprennent une partie de la méthodologie de Babcock et Foster (1991) et Alston et Venner (2002) et trouvent un impact positif des COV. Dans une contribution récente qui n'analyse pas les rendements agricoles mais étudie le déplacement probable de la frontière des possibilités de production suite à la mise en place des COV, Thomson (2013) ne trouve pas d'effet pour le blé en Australie avec de données allant de 1968 à 2009.

Des analyses empiriques ont également été réalisées pour savoir si les COV ont eu des conséquences sur le niveau de recherche et développement du secteur des semences. Perrin et al. (1983) réalisent une enquête sur les semenciers concernant leur dépense en recherche et montrent que celle-ci a augmenté, pour certaines espèces, à la suite de l'introduction des COV américains en 1970. L'étude de Butler and Marion (1985) associe une enquête sur les semenciers et les données sur les COV américains et montre que l'investissement privé a augmenté mais seulement pour le blé et le soja. Dans une

autre étude, Butler (1996) trouve des résultats similaires. Jaffe et al. (1995) procèdent à une enquête sur les semenciers en Argentine suite à l'introduction des COV en 1973. Une augmentation des investissements de 1986 à 1992 est avérée, mais cela proviendrait davantage d'autres politiques économiques que de la mise en place de COV. Leger (2005) sonde également les organisations publiques, mais se concentre seulement sur les variétés de maïs au Mexique et montre que l'introduction des COV n'aurait augmenté que légèrement la création variétale. Diez (2002) étudie le nombre de variétés enregistrées en Espagne et conclue à un effet positif de l'apparition des COV en Espagne sur la recherche du secteur privée des semences dans ce pays. Concernant le PPA, Moser et Rhode (2011) se concentrent sur le secteur des roses et montrent que seulement 16% des variétés de roses enregistrées entre 1930 et 1970 sont brevetées sous le PPA. De plus, cette proportion a tendance à diminuer depuis 1950. Ils en concluent que le PPA a, au mieux, un effet secondaire sur la création variétale de roses.

Il y a aussi, dans les analyses purement empiriques, des travaux se concentrant sur l'estimation de la valeur des COV. Lesser (1997) a adopté la méthode des prix hédoniques pour l'état américain de New York et a trouvé une valeur très faible des COV. Srinivasan (2003b, 2012) a, quant à lui, utilisé une méthode similaire à celle adoptée dans la littérature sur les brevets, à savoir une méthode basée sur les décisions de renouvellement, développée initialement par Shankerman and Pakes (1986). Il trouve des résultats similaires à ceux obtenus dans la littérature sur les brevets : beaucoup de COV ont une très faible valeur pendant que d'autres, en très faible quantité, ont une très grande valeur.

Le second chapitre de la thèse est une analyse de la valeur des COV en s'inspirant de la méthode proposée par Shankerman and Pakes (1986). Plus précisément, la méthode appliquée exploite les améliorations suggérées par Baudry et Dumont (2012) sur le cas des brevets. Son intérêt est de permettre l'introduction de variables micro-économiques (spécifiques aux DPI et non pas à la cohorte) comme, par exemple, la nationalité des obtenteurs. Dans ce chapitre, les droits sont différenciés selon les espèces en faisant des estimations différentes pour les six espèces que nous analysons contrairement à

Srinivasan (2003b, 2012) qui a étudié l'ensemble des droits en différenciant seulement les variétés agricoles des variétés horticoles. De plus, la prise en compte de certaines variables micro-économiques s'avère cruciale pour l'estimation de l'effet de l'exemption de recherche ainsi que l'effet de l'exemption de l'agriculteur. L'exemption de recherche est appréhendée à travers l'effet de la variation du portefeuille de droits des semenciers sur la dépréciation de la rente initiale. La suppression de l'exemption de l'agriculteur est évaluée en considérant une augmentation de la surface allouée à la culture de l'espèce en question calculée au pro-rata de la part des semences de ferme. La surface allouée à la culture de l'espèce est supposée avoir un effet direct sur le niveau initial de la rente. Les résultats obtenus dans le chapitre 2 suggèrent que la disparition de l'exemption de l'agriculteur pourrait augmenter la valeur des COV de 3% pour le pois à plus de 50% pour le colza. Concernant l'exemption de recherche, le chapitre 2 met en évidence un résultat cohérent avec les attentes pour le maïs, le renouvellement du portefeuille des droits des concurrents augmentant la dépréciation des COV. L'exemption de recherche a donc un effet négatif sur la valeur des COV via l'augmentation de la dépréciation de la rente initiale en rendant le renouvellement du portefeuille plus facile pour les concurrents. Toutefois, l'exemption de recherche ne semble avoir aucun impact pour les cinq autres espèces étudiées.

La deuxième branche de la littérature s'intéresse à l'impact des nouvelles innovations, sur le marché des semences, pour l'ensemble de la société. Alston et al. (1995) ont montré que, historiquement, les innovations dans le secteur agricole provenaient aussi bien du secteur public que du secteur privé, structurellement peu concentré et donc sujet à une compétition intense. Cependant, le développement récent du marché des semences et des DPI du végétal peuvent changer les outils théoriques utilisés habituellement pour analyser la distribution des surplus provenant d'une innovation dans le secteur agricole. En introduisant le rôle des DPI, Moschini et Lapan (1997) déterminent l'effet de la création variétale dans la distribution du surplus qu'elle génère entre les semenciers, les agriculteurs et les consommateurs. Moschini et Lapan (1997) trouvent que les semenciers peuvent largement monopoliser les surplus grâce à un pouvoir de

marché provenant de la création des DPI. Cependant, ils soulignent également que ce résultat dépend fortement du niveau de certaines variables comme, par exemple, la rapidité d'adoption de l'innovation.

En utilisant le modèle théorique développé par Moschini et Lapan (1997), Moschini et al. (2000) analysent la distribution des gains de surplus après l'adoption du soja RR. Ils montrent que le semencier propriétaire de cette variété capte la plus grande part des surplus. Une analyse similaire sur le coton Bt et le soja RR réalisée par Falck-Zepeda et al. (2000) donne des résultats très différents. Du fait de la difficulté à trouver les données nécessaires à la méthode développée par Moschini et Lapan (1997), ils utilisent plutôt une méthode développée par Alston et al. (1995) et trouvent alors que ce sont les agriculteurs qui sont les plus importants bénéficiaires de la création variétale. Une autre étude, réalisée sur la technologie RR en Argentine montre également que les agriculteurs sont les principaux bénéficiaires des innovations. Pour les auteurs, Quaim et Traxler (2005), ces résultats sont dus à une faible protection provenant des DPI et une très forte rapidité de l'adoption de ces nouvelles variétés.

La troisième branche de la littérature se penche plus spécifiquement sur l'exemption de recherche qui permet aux semenciers d'utiliser une variété sous un COV pour en créer une autre sans avoir besoin d'un accord du propriétaire de la variété protégée. Avec un modèle d'innovation séquentielle à horizon temporel infini, Moschini et Yerokhin (2008) et Yerokhin et Moschini (2008) montrent que le brevet n'est pas toujours préférable à un système de COV. Lorsque le coût de recherche et développement est faible, un système de COV (avec l'exemption de recherche) est préféré à un système de brevet (sans l'exemption de recherche) tandis que c'est le contraire avec un coût élevé de recherche. En effet, quand le coût de recherche est faible, un système de COV permet à différents semenciers d'entrer sur le marché sans créer une trop forte désincitation pour la première innovation. À l'inverse, si le coût de recherche est élevé, la compétition engendrée par l'entrée de nouveaux innovateurs va fortement diminuer les incitations du premier innovateur. Nagaoka and Aoki (2009) analysent également l'effet de l'exemption de recherche sur les incitations à innover, sans toutefois faire spécifiquement référence au

marché des semences. Avec un modèle où la concurrence en R&D est perpétuelle, ils montrent que l'exemption de recherche décroît les incitations du premier innovateur et accroît celle des innovateurs suivants. Ils obtiennent, également, que l'exemption de recherche permet d'améliorer globalement le processus d'innovation en faisant disparaître les coûts liés aux licences et en réduisant le taux d'échec des innovations.

Le troisième chapitre s'inscrit dans cette branche de la littérature. L'originalité du modèle théorique proposé est d'analyser conjointement l'effet de l'exemption de recherche et celle de la règle de commercialisation adoptée. Un système de demande basé sur une différenciation verticale des produits inspiré du modèle développé par Prescott et Visscher (1977) est dans un premier temps présenté. Ce système de demande est à adapter à la prise en compte de la différence entre les règles de commercialisation appliquées aux États-Unis et celle en vigueur en Europe. Ensuite, le chapitre examine la stratégie des semenciers soit avec un système de brevets soit avec un système de COV. Avec un système de brevets (sans l'exemption de recherche) l'innovateur qui réussit à rentrer sur le marché à la première période restera ensuite le seul à pouvoir innover à la seconde période. Avec le système de COV (avec l'exemption de recherche), il y aura de nouveau une concurrence entre semenciers pour une création variétale incrémentale à la seconde période. L'étape de recherche et développement est analysée en introduisant une probabilité de succès de l'innovation et un coût fixe de R&D. Le chapitre a également pour originalité d'introduire un effet endogène de la biodiversité sur la productivité des agriculteurs. Le modèle est testé en calibrant les variables sur le cas du blé en France. Compte tenu des comportements stratégiques des semenciers, le régulateur public peut alors choisir quel est le système qui maximise le bien-être (calculé à partir du surplus des agriculteurs et des semenciers). Les résultats du chapitre 3 montrent que le système européen avec le catalogue comme règle de commercialisation stricte et les COV comme DPI n'est que très rarement le couple de réglementations optimal. À l'image des résultats obtenus par Moschini et Yerokhin (2008), le chapitre met en évidence qu'avec un coût fixe de R&D faible, les COV comme DPI et les standards minimum comme règle de commercialisation souple constituent le couple de réglementations apparaissant

comme le plus souvent optimal. Avec un coût fixe élevé, le couple de réglementations choisi par la puissance publique est, le plus souvent, le brevet associé aux standards minimum.

Les problématiques dues à l'exemption de recherche sont liées à l'aspect des innovations cumulatives. Les questions sur les innovations cumulatives et l'impact des brevets sur les incitations à innover ont été étudiés par Merges et Nelson (1990), Scotchmer (1991), Green et Scotchmer (1995), O'Donoghue et al.(1998), Denicolò (2000) parmi d'autres. Dans Merges et Nelson (1990), le premier innovateur peut exclure le second d'innover (*hold-up*) en établissant notamment des niveaux très élevés de *royalties*, lesquelles font chuter les incitations à innover du second innovateur. Scotchmer (1991) discute des effets de la seconde génération d'innovation sur la première. Elle conclue que si largeur des brevets n'est pas suffisante, les incitations pourraient être trop faibles pour la première génération d'innovations. Green et Scotchmer (1995) développent un modèle théorique pour étudier les licences *ex ante* avec des hypothèses d'information parfaite et de pouvoir de négociation efficace (excluant les problèmes de *hold-up*). Ils notent que, selon la situation, les innovations devraient avoir une protection plus large ou moins large. En effet, le dernier innovateur peut menacer de ne pas investir dans une innovation profitable. O'Donoghue et al.(1998) distinguent deux régimes de brevets : soit la protection permet de seulement se prémunir contre les imitations, soit la protection porte également sur les produits améliorés. Ils montrent qu'une protection qui ne protégerait que contre les imitations n'est pas suffisante. Denicolò (2000) propose trois régimes de brevets : soit la seconde innovation n'est pas brevetable et enfreint la première, soit la seconde est brevetable mais enfreint toujours la première, soit la seconde est brevetable et n'enfreint pas la première innovation. Il trouve qu'il est préférable d'autoriser de breveter la seconde innovation avec une largeur de brevets ajustée selon différentes situations possibles. Plus récemment, Bessen et Maskin (2009), dans un modèle séquentiel, établissent que le bien-être peut être supérieur en absence de brevets. En effet, le premier innovateur peut également profiter de l'absence de brevet avec des effets de *spillover* apportés par les innovations suivantes. Les innovations cu-

mulatives ne sont pas présentes seulement dans le secteur des semences mais également dans beaucoup d'autres secteurs comme par exemple l'informatique. Une illustration est l'article de Lévêque et Ménière (2007) qui étudient l'impact de la brevetabilité des logiciels propriétaires sur les logiciels « libres ».

La quatrième branche de la littérature étudie l'exemption de l'agriculteur qui permet aux agriculteurs d'utiliser le fruit de leur récolte pour réensemencer la saison suivante. Dans un modèle considérant l'équilibre simultané sur trois marchés (celui de l'innovation, celui des semences et celui des grains), Lence et al. (2005) examinent l'impact de différents niveaux d'appropriation des innovations. Dans leur modèle, les agriculteurs peuvent choisir entre deux intrants, une variété ancienne ou une nouvelle variété, mais ils ne considèrent pas la possibilité de générer des semences de ferme à partir de la nouvelle variété. En calibrant le modèle à partir du marché nord américain, les auteurs montrent qu'il existe un niveau optimal d'appropriation qui se trouve entre le système de DPI des États-Unis et une protection totale qui pourrait être perçue comme étant celle conférée par les variétés « *terminator* ». Dans un papier récent, Yiannaka (2014) distingue deux possibilités pour empêcher les agriculteurs d'utiliser des semences de ferme : les contrats (*Technology Use Agreements, TUAs*) et les variétés « *terminator* ». L'auteur met en lumière que les semenciers préfèrent la mise en place de contrats avec les agriculteurs car les consommateurs ont une forte aversion (de nature éthique) envers les variétés « *terminator* », même si les semenciers doivent faire des efforts supplémentaires pour empêcher l'utilisation de semences de ferme.

Lorsque les agriculteurs utilisent des semences de ferme, celles-ci peuvent alors être perçues comme un bien durable. En effet, les semenciers peuvent concevoir la vente de leurs semences aux agriculteurs comme la livraison d'un bien durable que les agriculteurs n'auront plus besoin d'acheter lors de périodes suivantes car ils pourront utiliser une partie de leur récolte précédente. Un certain nombre de contributions appliquent la conjecture de Coase au marché des semences. Selon Coase (1972), un monopole, vendant un bien durable, va perdre sa rente en diminuant ses prix au cours du temps. En effet, les acheteurs anticipant une baisse des prix, vont préférer différer leur achat de bien durable.

En conséquence, les prix du monopole tendront vers ceux de la concurrence pure et parfaite. Perrin et Fulginiti (2008) examinent la conjecture de Coase avec différents types de DPI et différentes conditions de marché. Ils montrent que la conjecture de Coase est vérifiée lorsque les acheteurs sont capables de prévoir les prix et que les vendeurs ne peuvent pas s'engager sur les prix futurs. Ce n'est plus le cas si les acheteurs sont « myopes » et que les vendeurs peuvent s'engager de manière crédible sur le niveau des prix. Avec un modèle à deux périodes, Ambec et al. (2008) analysent le choix entre différentes stratégies du semencier. Ainsi, le producteur de semences peut décider soit de vendre ses semences comme un bien non-durable (à chaque période les agriculteurs peuvent acheter des semences), soit comme un bien durable (en choisissant des prix tels que les agriculteurs vont acheter des semences une fois et vont ensuite utiliser des semences de ferme), soit produire des semences hybrides (comme un bien non-durable). Ils trouvent que le semencier peut préférer le développement de semences hybrides même si c'est socialement moins efficace. Ils analysent également l'introduction d'une taxe sur les semences de ferme et son impact sur les différentes stratégies du producteur. La taxe améliore l'efficacité en réduisant les incitations des agriculteurs à utiliser des semences de ferme. Dans ces deux dernières contributions, l'étape d'innovation n'est pas formellement modélisée. Celle-ci, l'est dans Galushko (2008) qui montre que le brevet semble être préférable, sauf si le coût marginal du producteur de semences excède le coût de reproduction des agriculteurs. Sous cette condition, il est alors préférable d'autoriser l'utilisation de semences de ferme. Dans sa modélisation, l'auteur ne prend pas en compte la possibilité de mettre en place un système de *royalty* sur les semences de ferme.

Les *royalties* sur les semences de ferme peuvent prendre différentes formes selon leur mode de recouvrement et selon les pays. Kingwell (2001) compare quatre systèmes de *royalty* : une taxe fixe sur le nombre d'hectare, une taxe fixe sur la production, une taxe *ad valorem* sur la production et une taxe basée sur le profit des agriculteurs. Il montre que les agriculteurs averses au risque préfèrent soit une taxe basée sur les profit ou une taxe *ad valorem* sur la production, tandis que les semenciers averses au risque

préfèrent une taxe fixe appliquée sur la production ou sur la surface. En comparant quatorze pays différents, Curtis and Nilsson (2012) analysent l'efficacité du système de recouvrement des *royalties* pour le blé tendre concernant les variétés protégées par un COV. De nombreux pays semblent avoir un système peu efficace, notamment vis-à-vis des semences de fermes, avec parfois absence totale de *royalty* (États-Unis, Canada²⁹), tandis que d'autres pays semblent avoir un système particulièrement efficace (Australie, France, Suède).

Le quatrième chapitre analyse les semences de ferme en reprenant, en partie, une forme de modélisation proche de celle développée par Ambec et al. (2008). Il y ajoute toutefois une étape d'innovation ainsi qu'une étape où le semencier peut choisir son système de protection entre brevet (sans semences de ferme) et COV (avec semences de ferme). Lorsque le semencier choisit un système de COV pour protéger son innovation, il a alors le choix entre la stratégie de bien durable et de bien non-durable. Le chapitre introduit, également, une taxe payée par les agriculteurs lorsqu'ils utilisent des semences de ferme. Cette taxe, à laquelle est soustrait un coût administratif, est ensuite reversée au semencier. Ainsi, le modèle théorique développé dans le chapitre 4 permet d'analyser l'impact des semences de ferme, notamment sur les incitations à innover, et également de regarder si l'instauration d'une taxe sur les semences de ferme ou la mise en place de brevets sur les variétés végétales permet de restaurer les incitations à innover. Les principaux résultats du chapitre 4 montrent qu'en l'absence de brevet, un niveau inapproprié de la taxe peut réduire les incitations à innover et réduire le bien être. De plus, s'il y a une coexistence du système de brevets et de COV, alors cela ne supprime pas la présence des semences de ferme car dans certaines situations, le semencier préférera protéger son innovation avec un COV et avoir une stratégie de bien durable. Enfin, l'introduction des brevets peut, dans certains cas, améliorer les incitations à innover et le bien être ainsi que réduire les situations sous optimal, sans les faire disparaître, par rapport à un système où il n'y aurait que les COV comme possibilité de protection.

29. Des réformes sont en cours d'élaboration pour mettre en place des *royalties* sur les semences de ferme au Canada (Giovanoli, 2014).

1.5 Bibliographie

- Alston, J. and Venner, R. The effects of the us plant variety protection act on wheat genetic improvement. *Research Policy*, 31(4) :527–542, 2002. doi:10.1016/S0048-7333(01)00123-8.
- Alston, J. M., Norton, G. W., Pardey, P. G., et al. *Science under scarcity : principles and practice for agricultural research evaluation and priority setting*. Ithaca NY : Cornell University Press, 1995.
- Ambec, S., Langinier, C., and Lemarié, S. Incentives to reduce crop trait durability. *American Journal of Agricultural Economics*, 90(2) :379, 2008. doi:10.1111/j.1467-8276.2007.01110.x.
- Babcock, B. A. and Foster, W. E. Measuring the potential contribution of plant breeding to crop yields : Flue-cured tobacco, 1954–1987. *American Journal of Agricultural Economics*, 73(3) :850–859, 1991. doi:10.2307/1242837.
- Baudry, M. and Dumont, B. Valuing patents using renewal data : an inquiry into the feasibility of an automated patent scoring method. Working Paper, 2012.
- Bessen, J. and Maskin, E. Sequential innovation, patents, and imitation. *The RAND Journal of Economics*, 40(4) :611–635, 2009. doi:10.1111/j.1756-2171.2009.00081.x.
- Butler, L. J. Plant breeders' rights in the us : Update of a 1983 study. In : J. van Wijk & W. Jaffe (Eds) : Proceedings of a Seminar on the Impact of Plant Breeders' Rights in Developing Countries Held at Santa Fe Bogota, Colombia, March 7-8. Amsterdam : University of Amsterdam, 17-33., 1996.
- Butler, L. J. and Marion, B. W. impacts of patent protection on the us seed industry and public plant breeding. North Central Regional Research Bulletin No. 304, University of Wisconsin, Madison, WI., 1985.
- Carew, R. and Devadoss, S. Quantifying the contribution of plant breeders' rights and transgenic varieties to canola yields : Evidence from manitoba. *Canadian Journal*

- of Agricultural Economics/Revue canadienne d'agroeconomie*, 51(3) :371–395, 2003. doi:10.1111/j.1744-7976.2003.tb00181.x.
- Carew, R., Smith, E., Grant, C., et al. Factors influencing wheat yield and variability : Evidence from manitoba, canada. *Journal of Agricultural and Applied Economics*, 41 (3) :625–639, 2009. URL <http://purl.umn.edu/56649>.
- Coase, R. Durability and monopoly. *Journal of Law and Economics*, 15(1) :143–149, 1972.
- Curtis, F. and Nilsson, M. Collection systems for royalties in soft wheat : An international study. Technical report, International Seed Federation, 2012.
- Demeulenaere, É. Les semences entre critique et expérience : les ressorts pratiques d'une contestation paysanne. *Revue d'Études en Agriculture et Environnement*, 94 (4) :421–441, 2013. doi:10.4074/S1966960713014033.
- Denicolò, V. Two-stage patent races and patent policy. *the RAND Journal of Economics*, 31(3) :488–501, 2000. URL <http://www.jstor.org/stable/2600997>.
- Diez, M. The impact of plant varieties rights on research : the case of spain. *Food Policy*, 27(2) :171–183, 2002. doi:10.1016/S0306-9192(02)00010-6.
- Falck-Zepeda, J. B., Traxler, G., and Nelson, R. G. Surplus distribution from the introduction of a biotechnology innovation. *American Journal of Agricultural Economics*, 82(2) :360–369, 2000. doi:10.1111/0002-9092.00031.
- Fernandez-Cornejo, J. The seed industry in us agriculture. Technical report, USDA Economic Research Service, Agriculture Information Bulletin, 2004.
- Galushko, V. *Intellectual Property Rights and the Future of Breeding in Canada*. PhD thesis, University of Saskatchewan, 2008.
- Gate, P., Escriou, H., Maupas, F., Lorgeou, J., Piraux, F., Gouache, D., Chaillet, I., Gallais, A., and Biarnes, V. Évolution des rendements des grandes cultures : du rôle

de la création variétale, des pratiques culturales et du climat, aux solutions adaptatives et axes de recherche prioritaires. *Le sélectionneur français*, 64 :51–70, 2013.

Giovanoli, S. M. Farm saved seed (fss) and royalty generation for wheat in France, United Kingdom and Australia - policy implications for Canada. Master's thesis, University of Saskatchewan, 2014.

Goffaux, R., Goldringer, I., Bonneuil, C., Montalent, P., and Bonnin, I. Quels indicateurs pour suivre la diversité génétique des plantes cultivées. Technical report, Fondation pour la Recherche sur la Biodiversité (FRB), 2011.

Graff, G. D., Cullen, S. E., Bradford, K. J., Zilberman, D., and Bennett, A. B. The public-private structure of intellectual property ownership in agricultural biotechnology. *Nature biotechnology*, 21(9) :989–995, 2003. doi:10.1038/nbt0903-989.

Green, J. and Scotchmer, S. On the division of profit in sequential innovation. *Rand Journal of Economics*, 26(1) :20–33, 1995. URL <http://www.jstor.org/stable/2556033>.

Gros, F. *Les sciences du vivant : Éthique et société*. Paris : Odile Jacob, 2001.

Howard, P. Visualizing consolidation in the global seed industry : 1996–2008. *Sustainability*, 1(4) :1266–1287, 2009. doi:10.3390/su1041266.

Jaffe, W., Kukovics, S. T., Hanrahan, J., García Betancourt, O., García Betancourt, O., García, B., Bravo, P., Laben, R., El Cuji, E. E., Solkner, J., et al. The impact of plant breeder rights in developing countries. debate and experience in Argentina, Chile, Colombia, México y Uruguay. Technical report, University of Amsterdam, Amsterdam (The Netherlands) and IICA, San José (Costa Rica), 1995.

Kevles, D. J. Ananda Chakrabarty wins a patent : biotechnology, law, and society, 1972–1980. *Historical studies in the physical and biological sciences*, 25(1) :111–135, 1994. URL <http://www.jstor.org/stable/27757736>.

- Kingwell, R. S. Charging for the use of plant varieties. *Australian Journal of Agricultural and Resource Economics*, 45(2) :291–305, 2001. URL <http://EconPapers.repec.org/RePEc:ags:aareaaj:117468>.
- Kolady, D. E. and Lesser, W. But are they meritorious? genetic productivity gains under plant intellectual property rights. *Journal of Agricultural Economics*, 60(1) : 62–79, 2009. ISSN 1477-9552. doi:10.1111/j.1477-9552.2008.00171.x.
- Léger, A. Intellectual property rights in mexico : Do they play a role? *World Development*, 33(11) :1865–1879, 2005. doi:10.1016/j.worlddev.2005.07.003.
- Lence, S., Hayes, D., McCunn, A., Smith, S., and Niebur, W. Welfare impacts of intellectual property protection in the seed industry. *American Journal of Agricultural Economics*, 87(4) :951–968, 2005. doi:10.1111/j.1467-8276.2005.00780.x.
- Lesser, W. Assessing the implications of intellectual property rights on plant and animal agriculture. *American Journal of Agricultural Economics*, 79(5) :1584–1591, 1997. doi:10.2307/1244385.
- Lesser, W. Intellectual property rights and concentration in agricultural biotechnology. *AgBioForum*, 1(2) :56–61, 1999.
- Lesser, W. An economic approach to identifying an effective sui generis system for plant variety protection under trips. *Agribusiness*, 16(1) :96–114, 2000. URL <http://EconPapers.repec.org/RePEc:wly:agribz:v:16:y:2000:i:1:p:96-114>.
- Lévêque, F. and Ménière, Y. Copyright versus patents : The open source software legal battle. *Review of Economic Research on Copyright issues*, 4(1) :21–46, 2007. URL <http://ssrn.com/abstract=997191>.
- Llewelyn, M. and Adcock, M. *European Plant Intellectual Property*. Portland : Hart Publishing, 2006.
- Louwaars, N., Dons, H., Van Overwalle, G., Raven, H., Arundel, A., Eaton, D. J., and Nelis, A. Breeding business. the future of plant breeding in the light of developments

- in patent rights and plant breeder's rights. Technical report, Center for Genetic Resources, The Netherlands (CGN), Wageningen and Wageningen Universiteit and Research Centrum, 2009. URL <http://ssrn.com/abstract=1720088>.
- Louwaars, N. P., Tripp, R., Eaton, D., Henson-Apollonio, V., Hu, R., Mendoza, M., Muhhuku, F., Pal, S., and Wekundah, J. Impacts of strengthened intellectual property rights regimes on the plant breeding industry in developing countries. Technical report, World Bank, 2005.
- Merges, R. P. and Nelson, R. R. On the complex economics of patent scope. *Columbia Law Review*, 90(4) :839–916, 1990. URL <http://www.jstor.org/stable/1122920>.
- Moschini, G. Competition issues in the seed industry and the role of intellectual property. *Choices*, 25(2) :1–12, 2010. URL <http://www.econ.iastate.edu/sites/default/files/publications/papers/p11611-2010-06-08.pdf>.
- Moschini, G. and Lapan, H. Intellectual property rights and the welfare effects of agricultural r&d. *American Journal of Agricultural Economics*, 79(4) :1229–1242, 1997. doi:10.2307/1244280.
- Moschini, G. and Yerokhin, O. Patents, research exemption, and the incentive for sequential innovation. *Journal of Economics & Management Strategy*, 17(2) :379–412, 2008. doi:10.1111/j.1530-9134.2008.00182.x.
- Moschini, G., Lapan, H. E., and Sobolevsky, A. Roundup ready soybeans and welfare effects in the soybean complex. *Agribusiness*, 16(1) :33–55, 2000. URL <http://EconPapers.repec.org/RePEc:wly:agribz:v:16:y:2000:i:1:p:33-55>.
- Moser, P. and Rhode, P. W. Did plant patents create the american rose? In *The Rate and Direction of Inventive Activity Revisited*, pages 413–438. University of Chicago Press, 2011.
- Nagaoka, S. and Aoki, R. An economic analysis of patent law exemption for research on a patented invention. Working Paper, 2009.

- Naseem, A., Oehmke, J. F., and Schimmelpfennig, D. E. Does plant variety intellectual property protection improve farm productivity? evidence from cotton varieties. *AgBioForum*, 8(2&3) :100–107, 2005.
- O'Donoghue, T., Scotchmer, S., and Thisse, J. Patent breadth, patent life, and the pace of technological progress. *Journal of Economics & Management Strategy*, 7(1) : 1–32, 1998. doi:10.1111/j.1430-9134.1998.00001.x.
- Pardey, P. G. and Beintema, N. M. *Slow magic : Agricultural R&D a century after Mendel*. Washington D.C. : International Food Policy Research Institute, 2001.
- Perrin, R. and Fulginiti, L. Pricing and welfare impacts of new crop traits : The role of iprs and coase conjecture revisited. *AgBioForum*, 11(2) :134–144, 2008.
- Perrin, R. K., Kunnings, K., and Ihnen, L. Some effects of the us plant variety protection act of 1970. Economics Research Report No. 46, North Carolina State University Dept. of Economics and Business, Raleigh, N.C., 1983.
- Prescott, E. C. and Visscher, M. Sequential location among firms with foresight. *Bell Journal of Economics*, 8(2) :378–393, 1977. URL <http://www.jstor.org/stable/3003293>.
- Qaim, M. and Traxler, G. Roundup ready soybeans in argentina : farm level and aggregate welfare effects. *Agricultural Economics*, 32(1) :73–86, 2005. doi:10.1111/j.0169-5150.2005.00006.x.
- Ramanna, A. *Farmers' Rights in India : A Case Study*. The Fridtjof Nansen Institute, 2006.
- Ramanna, A. and Smale, M. Rights and access to plant genetic resources under india's new law. *Development Policy Review*, 22(4) :423–442, 2004. doi:10.1111/j.1467-7679.2004.00258.x.

- Schankerman, M. and Pakes, A. Estimates of the value of patent rights in european countries during the post-1950 period. *The Economic Journal*, 96(384) :1052–1076, 1986. URL <http://www.jstor.org/stable/2233173>.
- Scotchmer, S. Standing on the shoulders of giants : cumulative research and the patent law. *The Journal of Economic Perspectives*, 5(1) :29–41, 1991. doi:10.1257/jep.5.1.29.
- Srinivasan, C. S. Concentration in ownership of plant variety rights : some implications for developing countries. *Food Policy*, 28(5-6) :519–546, 2003a. doi:10.1016/j.foodpol.2003.10.003.
- Srinivasan, C. S. Exploring the feasibility of farmers’ rights. *Development Policy Review*, 21(4) :419–447, 2003b. doi:10.1111/1467-7679.00218.
- Srinivasan, C. S. Modelling economic returns to plant variety protection in the uk. *Bio-based and Applied Economics*, 1(2) :151–174, 2012. doi:10.13128/BAE-10557.
- Thomson, R. The yield of plant variety protection. *American Journal of Agricultural Economics*, 97(3) :762–785, 2015. doi:10.1093/ajae/aau099.
- Tripp, R. and Louwaars, N. Seed regulation : choices on the road to reform. *Food Policy*, 22(5) :433–446, 1997. doi:10.1016/S0306-9192(97)00033-X.
- Trommetter, M. Intellectual property rights in agricultural and agro-food biotechnologies to 2030. Technical report, OECD, 2008.
- Yerokhin, O. and Moschini, G. Intellectual property rights and crop-improving r&d under adaptive destruction. *Environmental and Resource Economics*, 40(1) :53–72, 2008. doi:10.1007/s10640-007-9140-5.
- Yiannaka, A. Market acceptance and welfare impacts of genetic use restriction technologies. Working paper, 2014.

Chapitre 2

The Value of the Plant Variety Protection and the Impact of Exemption Rules

The Value of the Plant Variety Protection and the Impact of Exemption Rules

Baudry Marc^{*†} Hervouet Adrien[‡]

Abstract

Plant Breeders Rights (PBRs) are *sui generis* intellectual property rights that are specifically intended to promote plant variety creation. Two important characteristics distinguish PBRs from patents: the research exemption and the farmers' exemption. This article attempts to assess the impact of these two exemption rules on the private value of PBRs. For this purpose, a micro-econometric model of PBRs renewal decisions is developed and estimated. This model extends previous models of patents renewal decisions by allowing the use of PBRs-specific variables in addition to cohort-specific variables. It is argued that simple tests on the coefficients associated to key PBRs-specific variables can provide insights into the impact of the two exemption rules on PBRs private value. Implementation to PBRs in France over the period 1973-2011 for six major crops suggests that the farmers' exemption has a higher and more significant negative effect on the value of PBRs than the research exemption. An eventual reform of PBRs should thus focus on the relevance of the farmers' exemption rather than on the relevance of the research exemption.

Keywords: Revealed Value, Inventors' exemption, Farmers' exemption, Variety creation

JEL classifications: O34, Q16, C41

*. Université de Paris Ouest Nanterre la Défense, EconomiX (UMR CNRS 7235), 200 Avenue de la République, 92001 Nanterre Cedex, France

†. Climate Economics Chair, Palais Brongniart, 4th floor, 28 place de la Bourse, 75002 Paris, France

‡. Institut d'Économie et de Management de Nantes-IAE, LEMNA, Chemin de la Censive de Tertre, BP 52231, 44322 Nantes, France, Tel.: +33 2 40 14 17 19, adrien.hervouet@univ-nantes.fr

2.1 Introduction

A noticeable factor of agricultural productivity growth is innovation in plant variety creation, also known as plant breeding (Evenson, 2001). Like any other innovative activity, plant breeding is subject to an appropriability problem of return on R&D investment by investors. Consequently, the socially detrimental disconnection between private and social returns on R&D, highlighted by Arrow (1962) and Dasgupta and Stiglitz (1980), also appears on the seeds sector. Moreover, plant variety creation relies intrinsically on incremental innovation. Therefore, while some countries consider that patents are relevant to provide proper incentives to invest in plant variety creation, other countries have rather established *sui generis* Intellectual Property Rights (IPRs), namely Plant Breeders' Rights (PBRs). A PBR gives exclusive rights on production/reproduction and commercialization that relate to rights given by a patent. Nevertheless, PBRs differ from patents due to several exemption rules. The first one is the 'research' exemption which allows any innovator to use protected varieties to create a new variety without the agreement of the holder. The second exemption is the 'farmers' privilege' that enables farmers to use farm-saved seeds (see Lesser, 2000; Louwaars et al., 2005, for a more detailed comparison between PBRs and patents). Both exemptions negatively affect the private returns on R&D in counterpart of higher expected social returns. These two exemptions could have a negative impact on the value of a PBR in comparison with a patent.

How large are the social returns from variety creation has been studied by several authors but is still controversial. Alston and Venner (2002), for instance, examine the effect of PBRs on the agricultural productivity growth for wheat in the U.S. and find no evidence of a positive impact. Other authors such as Carew and Devadoss (2003) for canola in Canada or Thomson (2015) for wheat in Australia also conclude that there is no evidence of a positive impact. In an other contribution, Diez (2002) finds a positive effect of PBRs on private research. The aim of this paper is rather to assess by how much private incentives to invest in plant variety creation may be affected by the two exemption rules of PBRs. Indeed, little is known about this key element of the

discussion on merits of PBRs compared to patents.

For this purpose, the paper builds on the literature that deals with the use of patent statistics to value patents (see Griliches, 1990, for a review). PBRs statistics are, to some extent, similar to patent statistics and allow an analysis that will focus on the assessment of the PBRs value. Indeed, as for a patent, a breeder has to pay an annual renewal fee to keep his PBR in force (excepted in the U.S.). If the breeder fails to pay, the right is permanently withdrawn and falls into the public domain. Assuming that a breeder is a rational economic agent, he will stop to pay the renewal fee if it exceeds the value obtained from keeping the PBR for an additional year. The method for assessing the value of PBRs presented in this article is thus based on data on renewal fee schedules and on the information revealed by breeders' decisions on whether to keep their PBRs in force or not. One of the first attempt to assess the value of patents was Pakes and Schankerman (1984) with a deterministic model of renewal decisions. Their contribution focuses on five European countries before the second world war. The main result is that the somewhat arbitrarily fixed rate of decay used in the literature for the rent that accrues from the detention of a patent is far too small compared to their estimation. Schankerman and Pakes (1985, 1986) use post second world war patent statistics for three european countries and obtain a similar result (e.g. a rate of decay included between 0.07 and 0.25). Moreover, they find that the distribution of patent values is sharply skewed. Indeed, a noticeable part of the value is concentrated in the right tail of the distribution. Schankerman (1998) ameliorates the assessment of patent value by distinguishing different technology fields but his work still relies on the key assumption of a decreasing rent, net of the renewal fee. This assumption is relaxed by Pakes (1986), Lanjouw et al. (1998) or Baudry and Dumont (2006), who develop an option approach to renewal decisions where the time path of the rent is stochastic. Nevertheless, this approach more or less confirms the idea that the probability of an increase of the rent is unlikely. To our knowledge, Srinivasan (2003, 2012) is the first to adopt the model developed by Schankerman and Pakes (1986) to estimate the value of

PBRs. He obtains results similar to those from the literature on patents value regarding the depreciation rate and the skewness of the distribution of values. An alternative approach is proposed by Lesser (1994) who suggests to estimate the impact of PBRs with an hedonic price method. He concludes that American PBRs have a very limited value. His approach admits some similarities with alternative methods used to estimated the value of patents, more specifically Tobin's Q methods (see Bessen, 2009; Bloom and Van Reenen, 2002; Hall et al., 2005, for example). A pitfall of all these works is that they do not account for observed heterogeneity at the microeconomic level. We argue that it is an important drawback if one intends to assess the loss of value generated by the farmers' exemption and the research exemption.

The farmers' exemption that distinguishes PBRs from patents implies that only a fraction of the potential market for commercialized seeds can be captured by the breeders. *A contrario*, a removal of the farmers' exemption is expected to influence the value of PBRs, as if the potential market had increased independently of an increase of the price of the crop. In order to capture such an impact, a modelling of PBRs renewal decisions that accounts for the influence of cohort-specific variables is required. The impact of the research exemption cannot be assessed as directly as the farmers' exemption. We are inclined to think that the research exemption increases the rate of decay of the rent that accrues from PBRs, due to more competitors creating new varieties around the existing ones. Research exemption thus results in an accelerated downgrading of existing PBRs. Consequently, it is crucial that the modelling of PBRs is consistent with the introduction of PBRs-specific variables to deal with the research exemption. Besides the effect of exemption rules, it is also expected that other factors can impact the value of PBRs at the microeconomic level. More specifically, it is expected that the degree of specialization and of product differentiation can influence the value of a given PBR. Said in other words, it is expected that the portfolio of PBRs on the same crop that a breeder holds affects the value of the PBRs embedded in this portfolio. Disregarding such a source of microlevel observed heterogeneity can bias the estimates of the rate of

decay of the rent and of the impact of the price of the crop. By contrast with Srinivasan (2003, 2012), we rather follows Barney (2002), Bessen (2008) and Baudry and Dumont (2012) who adapt the model of Schankerman and Pakes (1986) in order to incorporate microeconomic variables as a source of observed heterogeneity.

Section 2 presents a modelling of renewal decision that is suitable for the introduction of not only cohort-specific but also PBR-specific variables. A discrete time duration model of PBRs is derived from the microeconomic modelling. Section 3 presents PBRs statistics and estimation results for PBRs granted in France from 1973 to 2011 for six major crops. It also discusses a test of what could be the consequence of suppressing exemption rules on the simulated values of PBRs. Section 5 concludes that the farmers' exemption matters more than the inventors' exemption for the value of PBRs.

2.2 Model Setting

Renewal data are a corner stone to assess the value of Intellectual Property Rights. Rational agents will decide to renew their IPR if and only if the value they expect from renewing it exceeds the renewal cost. Schankerman and Pakes (1986) have shown that, under reasonable conditions regarding the dynamics of the rent and the dynamics of the renewal fees, the optimal renewal decision resumes to a simple comparison between the current rent and the current renewal fee. Consequently, data on renewal decisions reveal information about the value of rents and *in fine* about the private value of IPRs. This key idea is developed in the first subsection. The second subsection presents the econometric strategy used to estimate the model on microlevel data.

2.2.1 The value maximization problem

Like patents, PBRs confer to their holder an exclusivity right on the commercial opportunities that arise from the protected variety. The rent that accrues from this exclusivity right is denoted by $R_{i,t}$ where i denotes the new variety protected by the PBR and t is the age of the PBR expressed in years. $R_{i,t}$ is generally not observed by others than the PBR holder and, in particular, is unknown to the econometrician. More precisely, $R_{i,t}$ stands for the flow of revenues net of the unobserved costs of keeping the PBR alive. From year to year, the PBR holder has to pay a renewal fee $C_{i,t}$, which is the observed component of the cost of renewing the PBR. Failure to pay the renewal fee implies the irreversible loss of the PBR. As will be stressed latter on, the renewal fee may vary with the age t of the PBR. It may also change from one cohort of PBRs to another one, due to administrative decisions, which is reflected by the index i of the renewal fee. The loss of the PBR results in the total dissipation of the rent. Renewing the PBR is not feasible beyond the statutory lifespan T . The aim of the PBR holder is to determine the optimal decision rule that maximizes the value of the PBR defined as the expected and discounted sum of the rents minus the renewal fees at the different ages of the PBR. The problem that the PBR holder is facing is formally identical to

the following optimal stopping rule:

$$V_i = \text{Max}_{\tau \in \{1, \dots, T\}} E_0 \left[\sum_{t=0}^{\tau} \frac{R_{i,t} - C_{i,t}}{\rho_{i,t}} \right] \quad (2.1)$$

where

$$\rho_{i,t} = \begin{cases} 1 & \text{for } t = 0 \\ \prod_{s=1}^t (1 + r_{i,s}) & \text{for } t > 0 \end{cases} \quad (2.2)$$

is the discount factor and $r_{i,s}$ is the interest rate that prevails at age t for PBR i . We assume that the PBR holder is risk neutral so that the interest rate of government bonds can be used for $r_{i,s}$. The time path of the rent is unknown to the PBR holder at age $t = 0$ but the PBR holder is assumed to know the stochastic process that generates the rent and to observe the realizations of the rent from date to date as time goes. E_t stands for the operator of mathematical expectation conditional on the information at age t . We are ultimately interested in assessing how the value V_i would be impacted by a removal of the farmers exemption and a removal of the inventors exemption. For this purpose, we need to characterize the dynamics of the rent $R_{i,t}$ and to determine the optimal stopping rule τ^* .

2.2.2 Assumptions to obtain a simple decision rule

Solving optimal stopping rule programs like (2.1) is generally not straightforward and requires the use of stochastic calculus. Pakes (1986) has been the first to develop a real option approach to this problem in the context of patent renewal decisions. In parallel, Schankerman and Pakes (1986) have proposed an alternative to the real option approach that relies on the fact that the rent and the renewal fees generally satisfy a convenient property.

In most cases, renewal fees for PBRs, like those for patents, increase with the age of the Intellectual Property Right (IPR). Scotchmer (1999) and Cornelli and Schankerman (1999) develop arguments, based on information asymmetries, for public authorities in

charge of granting patents and/or PBRs to implement a profile of renewal fees that is increasing and convex with the age of IPRs. Together with the assumption that the rent decreases with the age of the IPR, due to competitors inventing around the protected invention, a phenomenon referred to as depreciation, there is a single crossing property of the time path of the rent with the time path of renewal fees. In other words, the holder of the IPR knows that once the rent is less than the renewal fee it is the case forever. Consequently, there is no point renewing the IPR because it will always cost more than it generates. The optimal stopping rule solving program (2.1) is then to renew the PBR as long as the rent exceeds the renewal fee and to withdraw the PBR as soon as the rent is below the renewal fee. This simple renewal rule due to Schankerman and Pakes (1986) is synthesized by the following proposition.

Proposition 1 *If the renewal fee increases with the age of the PBR whereas the rent decreases due to depreciation, then $\tau^* = \text{Inf} \{t \in \{0, \dots, T\}; R_{i,t} < C_{i,t}\}$ is the optimal stopping time that solves the value maximization program (2.1).*

An important consequence of Proposition 1 is that the optimal decision to renew or to withdraw a PBR relies on the current values of the rent and of the renewal fee, but does not involve any expectation of future flows of profits, future flows of costs and future interest rates. It also explains why the approach proposed by Schankerman and Pakes (1986) has received much more attention in applied econometric works than the more general real option approach examined by Pakes (1986) or Baudry and Dumont (2006). In most of these applied econometric contributions, unobserved heterogeneity between IPRs is generally limited to unobserved heterogeneity in the initial rent at the date of application, or the date of grant. This is consistent with their goal to measure the pace of innovation at a sectoral, or even a macroeconomic, level. Nevertheless, we need to go one step further in order to identify which key variables may affect the rent and to assess the impact of exemption rules that is applied to PBRs and make them different from patents.

2.2.3 Model specification

Figure 2.2.1 highlights how heterogeneity in the initial rent and heterogeneity in the depreciation rate affect the optimal decision, described in Proposition 1, to renew or withdraw a PBR. Three PBRs with different time paths of the rent are considered. All of them face the same schedule of renewal fees that increase as the PBR ages. The two first PBRs (with respectively the time paths corresponding to R_1 and R_2) have a different initial rent due to vertical and/or horizontal differentiation between the two protected varieties but they face the same changes in economic conditions and thus have the same depreciation rate of the rent. As shown by Figure 2.2.1, the difference in the initial rent is a sufficient condition to generate a difference in lapse dates. As already stressed, the empirical literature on renewal decisions for IPRs (mainly for patents) focuses on this source of heterogeneity. In their seminal work, Schankerman and Pakes (1986) assume that heterogeneity in the initial rent is unexplained and show how to derive the probability distribution of lapse dates for a given cohort of patents from the probability distribution of the initial rent. Their model captures the influence of cohort specific variables but not the influence of patent specific variables. Srinivasan (2003, 2012) applies their approach to the case of PBRs. This approach is not suitable if one wants, for instance, to assess by how much the rent that accrues from a PBR protecting a given variety is sensitive to the size of the portfolio of PBRs protecting other varieties of the same crop and held by the same owner. Yet, the size of this portfolio is likely to be a key determinant of the market power of the PBRs holder and, consequently, a key determinant of the level of rent that can be extracted from a specific PBR. Following what Barney (2002) and Bessen (2008) suggest for patents, we assume that the initial rent has two components. The first one is a function of observed cohort specific variables or PBR specific variables that affect the initial level of the rent. The second component is unobserved heterogeneity captured by a random term that takes positive values. It is more convenient to assume that not only these two components as well as the different observed variables of the first component, act multiplicatively. Indeed, the resulting specification of the initial rent guarantees that it always takes

positive values. Accordingly, the initial rent $R_{i,0}$ for a PRB i may be written as

$$R_{i,0} = \alpha_0 \left(\prod_{k=1}^K x_{i,k}^{\alpha_k} \right) \epsilon_i, \tag{2.3}$$

where α_k ($k \in \{0, \dots, K\}$) are parameters and the $x_{i,k}$ ($k \in \{1, \dots, K\}$) are variables that can be specific to the PBR and that influence the initial level of the rent. ϵ_i is a i.i.d. random term that captures unobserved heterogeneity.

Figure 2.2.1: Renewal fees and annual rents

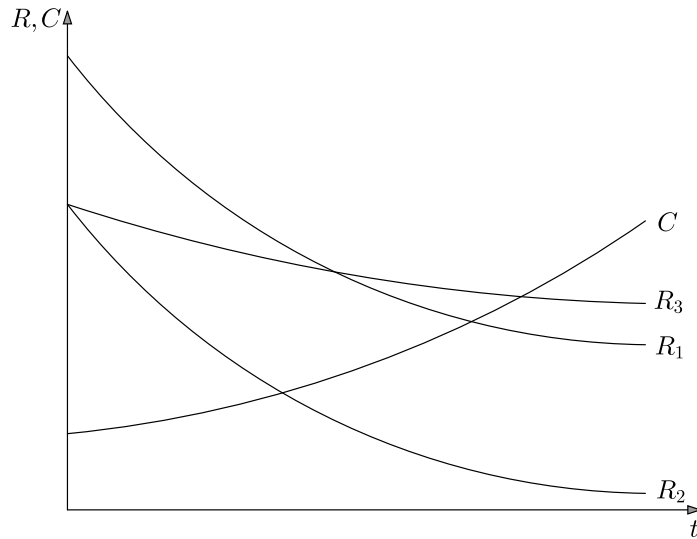

Differences in lapse dates of IPRs as a consequence of heterogeneity in the rate of depreciation of the rent have been largely disregarded in the literature. Yet, as emphasized by Figure 2.2.1, different rates of depreciation lead to different withdrawal dates. In Figure 2.2.1, the PBR with the time path of the rent denoted R_3 has the same initial rent than the PBR with the time path R_2 but benefits from a lower depreciation rate. As a result, its is renewed longer. Again, a difference in the depreciation rates can be induced by the dynamics of portfolios of PBRs owned by two PBR holders. The firm that holds the PBR with R_3 may have, for instance, been granted new PBRs on the same crop and, as a result, may have gained market power whereas the firm that holds the PBR with R_2 has not been granted new PBRs on this crop. As a result, the

firm with R_3 has gained market power and is able to limit the erosion of the rent due to the arrival of new varieties whereas the firm with R_2 is passive, and thus incurs a loss of market power which induces a higher depreciation rate of the rent. In order to make this idea consistent with Proposition 1, we build on the model developed by Baudry and Dumont (2012) and postulate a logistic specification for the rate of depreciation $\delta_{i,s}$ of PBR i at age s :

$$\delta_{i,s} = \frac{1}{1 + \exp(\beta * Z_{i,s})}, \tag{2.4}$$

where $Z_{i,s}$ is a vector of variables that explain the dynamics of the depreciation rate. β is the associated vector of parameters. It follows on that the rent $R_{i,t}$ of PBR i at age t is specified as

$$R_{i,t} = R_{i,0} \prod_{s=1}^t (1 - \delta_{i,s}), \tag{2.5}$$

where $R_{i,0}$ and $\delta_{i,s}$ are respectively given by (2.3) and (2.4).

2.2.4 The econometric model

Combining equations (2.5) and Proposition 1, the optimal rule for a breeder to let his PBR lapse becomes $R_{i,0} \prod_{s=1}^t (1 - \delta_{i,s}) < C_{i,t}$ and can be rearranged in the following log-linearized form

$$\ln \epsilon_i < \ln C_{i,t} - \ln \alpha_0 - \alpha_k * \sum_{k=1}^K \ln x_{i,k} - \sum_{s=1}^t \ln \left(1 - \frac{1}{1 + \exp(\beta * Z_{i,s})} \right), \tag{2.6}$$

The right hand side of this inequality provides a series of threshold values of the random term ϵ_i , which increase with the age t , and are denoted $\Omega_{i,t}$. Above $\Omega_{i,t}$ abandonment of the PBR i at age t is optimal. Inequality (2.6) poses the basis for the econometric model.

For econometric purposes, we are interested in computing the optimal probability,

$Pr_{i,t}$, to withdraw PBR i at age t , conditional on the fact that it has been kept in force until age $t - 1$. A PBR i is optimally abandoned at age t only if $\ln \epsilon_i < \Omega_{i,t}$ and if it has survived until the previous period, $t - 1$, and thus $\ln \epsilon_i \geq \Omega_{i,t-1}$. Consequently, the probability $Pr_{i,t}$ is defined by the difference between the cumulative distribution function of ϵ_i evaluated at the two thresholds, divided by the cumulative distribution of the survival function at $t - 1$

$$Pr_{i,t} = \frac{\Phi(\Omega_{i,t}) - \Phi(\Omega_{i,t-1})}{1 - \Phi(\Omega_{i,t-1})}, \quad (2.7)$$

where Φ represents the cumulative distribution function of ϵ_i whereas $(1 - \Phi(\Omega_{i,t-1}))$ is the probability to keep the PBR in force until age $t - 1$ and corresponds to the survival function. Notice that $Pr_{i,t}$ is similar to the hazard rate in the literature of duration models. According to (2.5) and (2.3), in order to make sure that the rent always takes positive values we assume that the random term ϵ_i is also positive. Therefore, we postulate that the random term ϵ_i is drawn from a log normal distribution.¹ Given that it has not yet lapsed, the log-likelihood of renewal *versus* withdrawal of PBR i at age t is defined as

$$L_{i,t} = v_{i,t} * \ln Pr_{i,t} + (1 - v_{i,t}) \ln(1 - Pr_{i,t}), \quad (2.8)$$

where $v_{i,t}$ equals 1 if i is kept in force at age t and $v_{i,t}$ equals 0 if i is withdrawn at age t . The total log-likelihood for a sample of N PBRs is obtained by summing the different $L_{i,t}$ over the period of life of each PBR i and summing over the different PBRs i :

$$L_{tot} = \sum_{i=1}^N \sum_{t=1}^{T_i} L_{i,t}. \quad (2.9)$$

where T_i is the observed age of withdrawal for PBR i . The parameters estimates are obtained as the outcome of the maximization of the total log-likelihood (2.9).

1. In the literature, a discussion between different probability distributions exists. Indeed, it will have an impact on the right tail of the distribution of the value. We have tested other distributions, such as the Weibull and the Pareto distributions, but they did not fit the data as well as the log-normal distribution.

2.3 Data and results

This section first presents the data used to estimate the model presented above. Estimation results are then broadly discussed. Last but not least, we present a test that provides some insights into the potential impact of the two exemption rules. It is argued that the impact of the farmers' exemption on the renewal decision and, as a consequence, on the value of a PBR on a variety of a specific crop, can be assessed through the impact *ceteris paribus* of the total acreage devoted to that crop. The test of the impact of the inventors' exemption is more subtle. It is based on a joint test of the impact of a grant of a new PBR and the withdrawal of a granted PBR on the same crop.

2.3.1 Data

The dataset on PBRs originates from the UPOV website. For each PBR granted in France, it provides information on the grant date, the withdrawal date, the nationality of the holder, the variety protected and, in the case of wheat, whether it is a winter or a spring variety. It covers the period from 1973 to 2011 for France. We extracted data for six species: the two main cultivated grain crops in France, wheat and maize; two oilseeds, sunflower and rapeseed; one protein crop, peas; and one tuberous crop, potatoes. These crops have been chosen for two reasons. First, because of their economic importance in the French agricultural sector. Second, a sufficiently high number of PBRs have been granted in France over the period studied. Other crops, like sugar beet, may have a high economic importance for the French agricultural sector but the number of PBRs granted is too small for econometric purpose. Data on prices come from Eurostat.

The variables used to explain heterogeneity in the initial value of the rent are either time invariant characteristics of PBRs or variables which value at the date of grant is a key determinant of the initial rent while their variation will affect the dynamics of the rent. Continuous variables affect the initial rent as specified in (2.3) and thus

appear in a log-linear way in the threshold expression (2.6). Discrete variables appears in the form $\exp(\alpha_k x_{i,k})$ in (2.3) and thus in a linear form in the threshold expression (2.6). Descriptive statistics of these variables are reported in Table 2.1. The list of these variables is the following:

- *EU PBR* is a dummy variable that takes the value 1 from 1996 onward to account for the creation of European rights in 1996. It is expected that this variable will have a negative effect on the initial rent because innovations with a greater potential are likely to be protected at the European level rather than the national level. For wheat, corn, sunflower and peas, between 22-38% of the rights are concerned. For potatoes only 8% are concerned because there are very few rights granted during the most recent years. Conversely, we observe the opposite for rapeseed with 78% of PBRs granted in the post 1996 period.

- *Init. price* is the initial price of the crop at the date of grant. The higher the price of a crop is, the higher the demand for seed of this crop. Consequently, the initial price of the crop is expected to have a positive impact on the initial rent. Unfortunately, data on prices for sunflower from 1973 to 1989 are not available. A two-year moving average was used to capture a time lag between the variation of the price and the shift of the demand for seeds of the crop. Wheat and maize varieties have a similar mean price (respectively 14.81€/q and 15.04€/q). Rapeseed have the highest mean of the initial price (22€/q), just after peas (20.75€/q) for which the standard deviation is also important compared to other crops (6.03€/q). Potatoes obtain the lowest mean price (9,04€/q).

- *Init. Area* is the total acreage of land allocated to the crop. It measures the market size for PBRs of varieties of this crop. As such, it is expected to positively impact the initial rent for any PBR protecting a new variety of the crop. As will be detailed latter in this section, it is a key variable to test the impact of farmers' exemption. Because of the high magnitude of the variable, it has been normalized by its mean value over the whole period studied.

- *PBRs Applicant* measures the number of PBRs on the same crop in the portfolio

of the PBR holder at the date of grant. This variable may capture two opposite effects, so that its net impact on the initial value of the rent is uncertain. On the one hand, if the portfolio already contains numerous PBRs on the same crop, the grant of a new right is more likely to signal a minor improvement than if the portfolio contains less PBRs. Then, the initial rent for an additional PBR is expected to be lower and the size of the portfolio at the date of grant will have a negative impact on the initial rent. On the other hand, a larger portfolio of PBRs at the date of grant may reveal *ceteris paribus* (and more specifically for a given number of PBRs on the same crop held by competitors) a higher market power on the market of seeds for that crop. Then, it is expected that the size of the portfolio of PBRs on the same crop at the date of grant has a positive impact on the initial rent. The average size of PBRs portfolio is higher for Maize (45 in average at the grant date) than for other crops, but it is probably due to the population size. In view of the population size, the mean is very high for rapeseeds (22). Indeed, the concentration of rights is higher for rapeseeds. The standard deviation is very close to the mean for every species, which is high and means that some applicants have very few rights in their portfolio whereas other may have more than hundreds.

- *PBRs Competitors* is similar to *PBRs Applicant* but for competitors. The two effects mentioned for *PBRs Applicant* occur but they both act negatively on the initial rent. Indeed, the larger the portfolio of PBRs on the same crop held by competitors, the more difficult it is to propose an original and innovative new variety. At the same time, it is more difficult to exercise a significant market power.

- *French* is a dummy variable that takes the value 1 if the PBRs' holder is French. Indeed, a national bias may appear. It is generally alleged that a national applicant has greater incentives to keep a right in force, because the domestic market is a major market for her and/or she has a better knowledge of the domestic agricultural sector. Approximately half of the rights are concerned, except for wheat where it is up to 75% and only a quarter for rapeseeds.

- *Spring* is a dummy variable, available only for wheat, that takes the value 1 if the

right protects a spring wheat variety. Only 8% of PBRs on wheat are concerned. The underlying idea is that the market of the spring wheat is a separate market.

The variables that are assumed to affect the initial rent but are not time invariant are all assumed to have their variation or their variation rate affecting the depreciation rate of the rent. The corresponding variables are the following:

- *Price change* is the rate of variation of the price of the crop. An increase of the price of the crop may foster the demand for seeds of newly protected varieties at the detriment of older protected varieties. Indeed, the increase of the price of crops can encourage farmers to renew their seeds rather than use farm-saved seeds and/or can incentivize them to switch to the newest varieties. Both effects will increase the depreciation rate.

- *Area change* is the rate of variation of the total acreage of the crop. Like *Price change*, an increase of this variable can impact the dynamics of the rent in a positive or a negative direction. Intuitively, it is expected that an increase in acreage implies an increase of the market size for seeds and, consequently, it is intuitively expected that an increase in acreage induces a slow down of the depreciation. Nevertheless, an increase in the acreage of a crop may also result from the diffusion of new very competitive varieties that favors the conversion of land that was initially devoted to other crops. In such a case, it logically fosters the depreciation of the rent of previously granted PBRs.

- *New Rights App.* is the flow of new PBRs obtained by the holder of the PBR in interest. Like the impact of *PBRs Applicant* on the initial rent, and for the same reasons, its effect on the depreciation rate can be ambivalent. On the one hand, an increase of the size of the portfolio of PBRs on the same crop held by the same owner can reduce the market opportunities for the PBR in interest and, consequently, can accelerate its depreciation. On the other hand, it can also strengthen the market power of the PBR owner and can thus slow down the depreciation of the rent.

- *Exit Applicant* is the opposite of *New Rights App.*, it is the flow of PBRs withdrawn during the life of the PBRs in interest. Again, the withdrawal of PBRs on the same crop can release some room for the remaining PBR and slow down the depreciation of

the rent. At the same time, it can also weaken the market power of the PBR holder and can thus accelerate the depreciation of the rent.

- *New Rights Comp.* is the flow of new PBRs granted to other applicants during the life of the PBR in interest. It is clearly expected to increase the depreciation of the rent because of an increased competition due to newly PBRs granted to competitors.

- *Exit Competitors* is the opposite of *New Rights Comp.*, it is the flow of PBRs held by other applicants and withdrawn during the life of the PBR in interest. It is thus expected to have a symmetric effect and to slow down the depreciation of the rent.

The last two variables play a key role to test the impact of the inventors' exemption. This point will be made more explicit later in the article. For all these variables introduced as components of the vector $Z_{i,s}$ in the expression (2.4) of the depreciation rate, a positive (respectively negative) coefficient means that an increase of the variable weakens (respectively strengthens) the depreciation of the rent. In addition to these variables, a trend is introduced. It aims at capturing the fact that the depreciation rate may vary *ceteris paribus* as the PBR ages.

Table 2.1: Summary Statistics

Variables	Wheat	Maize	Sunflower	Rapeseed	Potatoe	Peas
EU PBR	0.23	0.37	0.38	0.74	0.08	0.22
French	0.75	0.56	0.59	0.41	0.26	0.52
Spring	0.08
Init. Price (€/q)						
mean	14.81	15.04	.	22.01	9.04	20.75
std	2.64	2.33	.	3.19	2.9	6.03
min	10.43	11.8	.	17.85	5.5	10.68
max	18.72	19.76	.	33.15	14.98	31.47
Init. Area						
mean	1	1	1	1	1	1
std	0.07	0.08	0.23	0.28	0.38	0.77
min	0.74	0.81	0.04	0.24	0.07	0.0003
max	1.10	1.17	1.28	1.34	1.56	31.92
PBRs Applicant						
mean	5.91	45.15	16.85	20.66	7.31	4.69
std	5.63	41.68	13.62	18.78	7.6	3.6
min	0	0	0	0	0	0
max	30	163	52	72.5	35	17
PBRs Competitors						
mean	106.33	699.7	240.34	55.28	122.42	61.62
std	41.42	319.2	102.31	31.17	56.16	27.50
min	2	0	0	0	2.3	0
max	161	1123	377	140	215	113
Price change						
mean	0.04	0.05	.	0.09	0.06	-0.01
std	0.03	0.03	.	0.03	0.08	0.04
min	-0.23	-0.26	.	-0.28	-0.52	-0.32
max	0.45	0.38	.	0.3	1.11	0.71
Area change						
mean	0.007	-0.002	0.01	0.05	-0.005	0.15
std	0.01	0.02	0.04	0.04	0.04	0.44
min	-0.12	-0.29	-0.20	-0.21	-0.43	-0.40
max	0.19	0.16	1.08	0.88	0.71	5.2
New Rights App.						
mean	0.46	3.22	1.12	2.29	0.34	0.37
std	0.37	2.29	1.3	1.62	0.48	0.25
min	0	0	0	0	0	0
max	9	63	30	24.5	9	7
Exit Applicant						
mean	0.64	4.92	1.55	2.71	0.46	0.49
std	0.86	3.23	1.4	2.28	0.36	0.26
min	0	0	0	0	0	0
max	23	70	33	38	12	7
New Rights Comp.						
mean	10.38	63.8	19.9	7.85	6.23	6.4
std	2.04	18.48	9.83	4.4	5.31	1.4
min	0	0	0	0	0	0
max	49	330	131	60	63	37
Exit Competitors						
mean	13.49	85.21	26.93	8.63	8.23	7.87
std	1.98	15.95	6.11	3.1	1.50	1.04
min	0	0	0	0	0	0
max	45	286	91	69	40	25
Population size	505	2 879	829	247	382	323

2.3.2 Results

Tables 2.2 to 2.7 display the estimation results of the PBRs renewal model for each of the six crops studied. Six versions of the model have been considered. Model 1 is a basic model where neither the initial rent nor its depreciation rate are influenced by observed exogenous variables. Differences across PBRs in terms of renewal decisions thus only rely on unobserved heterogeneity in the initial rent. The initial values of parameters μ and σ used for the numerical maximization of the log-likelihood are derived from the assumption that the depreciation rate amounts to 20% and that the value of the initial rent for each PBR is just consistent with the observed age of withdrawal. In other words, if a PBR i has been withdrawn at age τ we assume that $R_{i,0} = C_{i,\tau} (1 - 0.2)^{-\tau}$ where $C_{i,\tau}$ is the renewal fee at age τ for PBR i . The two parameters μ and σ are then obtained as the mean and standard deviation of the distribution of the natural logarithm of $R_{i,0}$ over the different PBRs. The estimated constant depreciation rate is reported in the row "Year 1". This depreciation rate substantially varies from one crop to another one. It ranges from 9.48% for potatoes to 19.63% for rapeseeds. PBRs for Peas have a low depreciation rate (10.75%) whereas PBRs for sunflower and wheat have a high depreciation rate (18.08% and 18.91%). PBRs for maize are characterized by a medium depreciation rate (14.46%). For all crops, the estimated value of μ is close to 6 whereas more important differences are observed in terms of dispersion (parameter σ) which is relatively low for peas (at 0.8934) and high for wheat (at 1.3147). Applying formula (2.1), we have been able to simulate the value of each PBR in the dataset. The main features of the distribution of these values (mean value and quantiles) are reported at the bottom of each Table. PBRs on Potatoes have the highest mean and median value, followed by PBRs on wheat. PBRs on peas have the lowest mean and median values. For all crops, the distribution of PBRs' values is highly skewed, which is in line with results usually obtained for patents.

Model 2 may be thought of as the equivalent of the model developed by Schankerman and Pakes (1986) in the sense that the distribution of the initial rent can be affected by cohort specific variables. These cohort-specific variables are an indicator variable

Cohort of the cohort that starts at zero for the first cohort (PBRs with application year 1973) and is incremented by one from a given cohort to the subsequent cohort; the indicator variable *EU PBR* that takes value one for cohorts posterior to the introduction of a European PBR system in 1996; the market price *Init price* of the crop at the date of application and the total acreage of the crop *Init Area* at the date of application. Estimates obtained for Model 1 are used as initial values of parameters common with Model 2 for the numerical maximization of the log-likelihood whereas the initial values of other coefficients are set at zero. Model 3 extends Model 2 with the inclusion of PBR-specific variables (*PBRs Applicant*, *PBRs Competitors*, *French* and, for wheat only, *Spring*) influencing the initial rent. Again, the initial values of parameters that are common with Model 2 are set to the estimated values obtained in Model 2 whereas the initial value of new coefficients are set to zero. Model 4 is a variant of Model 3 which allows for age-specific depreciation rate. More precisely, a trend is introduced in addition to the constant coefficient in the expression (2.4) of the depreciation rate. The last two rows of the top part of Tables 2.2 to 2.7 display the log-likelihood and the statistic LR used for the log-likelihood ratio test of restricting the model to the variant used to initialize the parameters. The log-likelihood ratio test always supports the extension made. Models 2 and 3 lead to marginal changes in the distribution of PBR values compared to Model 1. Model 4 results in a more drastic change. It systematically results in an increase of all quantiles, which suggests that the whole distribution of PBRs values shifts to the right. Models 5 and 6 respectively extend Model 3 and 4 with the inclusion of variables that impact the depreciation of the rent (either cohort specific variables like *Price change* and *Area Change* or PBR specific variables like *New Rights App*, *Exit Applicant*, *New Rights Comp.* and *Exit Competitors*). Estimation results of Model 5 for Sunflower are not reported because the maximization of the log-likelihood does not converge. For the other crops, Model 5 always induces a shift of the distribution of PBRs values to the right although the depreciation rates at ages one, ten and twenty, are generally higher. This result suggests that in Model 5 higher depreciation rates at different ages are more than counterbalanced by higher estimated

initial values of the rent. Model 6 generates the highest mean and median values of PBRs, except for rapeseeds.

When the coefficient of *Cohort* is significant, it systematically indicates that the initial rent is *ceteris paribus* lower for recent cohorts compared to old cohorts. We conclude that, *ceteris paribus*, PBRs tend to have lower values as time goes. Similarly, when significant, the introduction of a European PBR system had a negative impact on the initial rent for French PBRs, except for sunflower. Notice that sunflower is the only crop for which data on prices were not available for the beginning of the period so that the variable has not been introduced in the model. It may explain why estimation results sometimes contrast with those obtained for the other crops. More surprisingly, *Init. Price* is found to have a low, albeit positive, significance for the initial rent. A more significant positive coefficient was expected. *Price change*, for its part, has a significant and negative impact on the depreciation rate of the rent for wheat, maize and, to a less extent, for rapeseeds. For these crops, an increase of the market price induces a higher depreciation rate, probably because farmers are then keen to switch to more recent (and more expensive) varieties due to more favorable economic conditions.

Table 2.2: Wheat Results

	Model 1	Model 2	Model 3	Model 4	Model 5	Model 6
μ	6.3226 ^a 20.8007	4.7588 ^a 2.7573	4.6651 ^a 2.6529	5.9453 ^c 1.7555	7.6391 ^a 3.0889	9.1972 ^a 2.8886
σ	1.3147 ^a 5.6798	1.2787 ^a 5.7532	1.2817 ^a 5.7156	2.3297 ^a 2.5605	1.8332 ^a 4.6056	2.3907 ^a 8.1084
δ_{cons}	1.4560 ^a 6.6747	1.4533 ^a 6.6797	1.4444 ^a 6.5758	-0.0589 -0.0855	0.7470 ^b 2.3697	
δ_{trend}				0.0716 ^a 3.1386		0.0625 ^a 4.5607
Depreciation rate						
Year one	0.1891	0.1895	0.1909	0.4968	0.2870	0.4396
Year 10				0.3413	0.2466	0.3117
Year 20				0.2020	0.2733	0.2239
Cohort		-0.0123 -0.9612	-0.0178 -0.8332	-0.0344 -0.8538	-0.0194 -0.6250	-0.0155 -0.3967
EU PBR		-0.3178 -1.2105	-0.2927 -1.0865	-0.5322 -1.0127	-0.5882 -1.5206	-0.7513 -1.4892
Init. Price		0.6813 1.1200	0.6917 0.9772	1.1826 0.8520	0.4518 0.4601	0.5637 0.4314
Init. Area		-0.7137 -0.7137	-0.9001 -0.5591	-1.8061 -0.5806	-2.0377 -0.9077	-2.5320 -0.8554
PBRs Applicant			-0.0955 -1.3547	-0.1670 -1.1700	0.2798 ^c 1.8507	0.4316 ^b 2.3071
PBRs Competitors			0.0941 0.4165	0.1957 0.4742	-0.2190 -0.6719	-0.3286 -0.7497
French			-0.1578 -1.0136	-0.2858 -0.9627	-0.7564 ^a -2.6533	-0.9300 ^a -2.8396
Spring			-0.0101 -0.0478	0.0108 0.0283	-0.0543 -0.1749	-0.0279 -0.0689
Price change					-1.6856 ^a -2.7083	-2.1279 ^a -3.1505
Area change					0.5238 0.4338	0.3615 0.2927
New Rights App.					0.1208 ^c 1.7435	0.1365 ^c 1.8980
Exit Applicant					-0.2389 ^a -6.8439	-0.2876 ^a -7.8174
New Rights Comp.					0.0013 0.2258	0.0010 0.1771
Exit Competitors					0.0254 ^a 2.8934	0.0135 1.5856
Log L	-1 447	-1 433	-1 431	-1 424	-1 339	-1 326
LR	9.33	29.65	3.74	12.51	182.97	196.20
Simulated Values (in thousands of constant 2005 euros)						
Mean	4.93	5.12	5.22	20.26	29.57	281.18
10%	0.08	0.07	0.07	0.19	0.08	0.17
25%	0.38	0.37	0.37	1.44	0.62	1.41
Median	1.44	1.45	1.47	9.08	3.38	9.65
75%	4.57	4.71	4.77	51.08	14.95	57.85
90%	11.67	12.23	12.37	230.16	52.23	276.97
99%	52.80	55.05	56.71	3 074	425.47	4 002
99.9%	151.93	161.89	166.74	19 696	1 953	29 067

Note a, b and c mean significant at 1%, 5% and 10% respectively

Table 2.3: Maize Results

	Model 1	Model 2	Model 3	Model 4	Model 5	Model 6
μ	5.7999 ^a 76.6626	5.7668 ^a 13.3839	5.8113 ^a 13.2678	8.1531 ^a 8.2408	5.6741 ^a 9.5422	8.0735 ^a 6.6224
σ	1.1139 ^a 16.1566	1.0714 ^a 16.5902	1.0652 ^a 16.7792	2.0013 ^a 7.4814	1.3217 ^a 13.4654	2.5282 ^a 20.0138
δ_{cons}	1.7776 ^a 22.9925	1.7358 ^a 22.3016	1.7330 ^a 22.4496	0.0238 0.0989	1.7559 ^a 16.5154	
δ_{trend}				0.0883 ^a 9.4009		0.1037 ^a 18.5788
Depreciation rate						
Year one	0.1446	0.1498	0.1502	0.4720	0.1435	0.4417
Year 10				0.2877	0.1878	0.3424
Year 20				0.1432	0.1683	0.1506
Cohort		-0.0344 ^a -7.3446	-0.0295 ^a -3.6793	-0.0549 ^a -3.2620	-0.0252 ^a -2.3910	-0.0340 ^c -1.7662
EU PBR		-0.2220 ^a -3.3079	-0.2318 ^a -3.2358	-0.4599 ^a -3.2319	-0.3488 ^a -3.5480	-0.7155 ^a -3.6689
Init. Price		0.2822 ^c 1.8426	0.2716 1.5785	0.4695 1.3233	0.2340 1.0191	0.1286 0.2733
Init. Area		0.5936 ^a 2.0926	0.6833 ^b 2.3935	1.4408 ^b 2.4781	0.7124 ^b 1.9518	1.3030 ^c 1.7870
PBRs Applicant			-0.1043 ^a -5.2453	-0.1928 ^a -4.3975	0.0471 ^c 1.7010	0.1613 ^a 2.7769
PBRs Competitors			0.0230 0.5701	0.0468 0.6043	0.0217 0.4075	0.0884 0.8169
French			0.1882 ^a 4.0491	0.3596 ^a 3.7154	0.2268 ^a 3.7936	0.3985 ^a 3.5578
Price change					-0.5436 ^b -2.3546	-1.0753 ^a -4.1087
Area change					-1.2302 ^a -3.3277	-1.0027 ^b -2.5101
New Rights App.					0.0317 ^a 9.4843	0.0391 ^a 11.4354
Exit Applicant					-0.0428 ^a -29.5284	-0.0543 ^a -24.5726
New Rights Comp.					-0.0023 ^a -7.2540	-0.0021 ^a -6.3440
Exit Competitors					0.0012 ^a 2.8540	0.0004 0.9153
Log L	-8 197	-8 031	-8 009	-7 960	-7.471	-7 323
LR	94.61	333.38	43.66	99.27	1 077	1 274
Simulated Values (in thousands of constant 2005 euros)						
Mean	2.12	2.42	2.44	53.23	4.52	295.23
10%	0.04	0.04	0.04	0.10	0.04	0.14
25%	0.21	0.20	0.20	0.70	0.26	1.19
Median	0.74	0.77	0.77	3.97	1.12	8.50
75%	2.22	2.41	2.42	19.46	3.91	53.21
90%	5.30	5.99	6.01	77.55	10.60	267.88
99%	19.91	24.20	24.48	805.60	51.66	4 258
99.9%	48.87	62.88	63.46	4 326	158.84	32 309

Note a, b and c mean significant at 1%, 5% and 10% respectively

Table 2.4: Rapeseed Results

	Model 1	Model 2	Model 3	Model 4	Model 5	Model 6
μ	6.0063 ^a 18.3551	5.9607 ^a 3.4058	8.8623 ^a 5.5004	14.1913 ^a 4.5056	9.1346 ^a 3.3073	12.5400 ^a 3.3122
σ	1.1566 ^a 4.5975	1.0907 ^a 4.7871	1.0510 ^a 4.6726	1.9031 ^a 2.7798	1.4076 ^a 3.3575	1.9767 ^a 5.8106
δ_{cons}	1.4099 ^a 4.9296	1.1918 ^a 4.2109	1.2148 ^a 4.2595	-0.2642 -0.3701	1.1531 ^a 2.8314	
δ_{trend}				0.0748 ^b 1.9975		0.0988 ^a 4.1949
Depreciation rate						
Year one	0.1963	0.2329	0.2288	0.5472	0.1773	0.3864
Year 10				0.3813	0.2718	0.3287
Year 20				0.2258	0.2147	0.1369
Cohort		-0.1524 ^a -3.8988	-0.1508 ^a -3.5564	-0.2742 ^b -2.5328	-0.2061 ^a -2.6003	-0.2661 ^a -2.7751
EU PBR		-0.4078 -1.5212	-0.1251 -0.4137	-0.2400 -0.4142	0.0369 0.0820	0.1857 0.2841
Init. Price		1.1770 ^b 1.9736	0.5704 0.9843	0.7990 0.5194	0.6101 ^b 2.0815	0.3279 ^b 2.2216
Init. Area		1.1597 ^c 1.6858	1.3449 ^b 2.3935	2.4003 ^c 1.9525	2.0005 ^b 2.1312	2.5908 ^c 1.9093
PBRs Applicant			-0.0534 -0.7314	-0.1074 -0.8139	0.1519 0.7994	0.2534 0.9530
PBRs Competitors			-0.2655 ^c -1.7706	-0.4693 -1.6071	-0.1049 -0.3772	-0.0590 -0.1366
French			-0.3902 ^b -2.2152	-0.7249 ^c -1.7907	-0.6507 ^c -1.8575	-0.9142 ^b -2.2405
Price change					-1.7107 -1.4233	-2.4082 ^b -1.9592
Area change					1.7393 1.3941	1.5836 1.2468
New Rights App.					0.0911 ^a 2.7850]	0.0900 ^a 2.6800
Exit Applicant					-0.0904 ^a -6.3149	-0.1098 ^a -6.0303
New Rights Comp.					-0.0079 -0.7570	-0.0088 -0.7567
Exit Competitors					-0.0026 -0.2836	-0.0053 -0.5261
Log L	658.23	-609.43	-604.02	-602.25	-542.84	-531.30
LR	7.14	97.58	10.84	3.52	122.34	141.91
Simulated Values (in thousands of constant 2005 euros)						
Mean	2.04	3.94	3.72	183.02	8.70	78.63
10%	0.04	0.05	0.05	0.12	0.06	0.16
25%	0.21	0.23	0.23	0.78	0.34	1.00
Median	0.72	0.85	0.83	4.44	1.56	5.65
75%	2.10	2.81	2.68	24.87	5.97	28.16
90%	5.04	8.31	7.88	134.01	18.31	115.93
99%	19.54	52.26	50.08	2 950	114.46	1 249
99.9%	49.60	163.75	154.46	22 784	418.24	6 320

Note a, b and c mean significant at 1%, 5% and 10% respectively

Table 2.5: Sunflower Results

	Model 1	Model 2	Model 3	Model 4	Model 5	Model 6
μ	6.1491 ^a 30.1062	7.8075 ^a 17.8517	9.1739 ^a 15.7564	15.6415 ^a 9.1993	-	15.3923 ^a 11.0836
σ	1.2500 ^a 7.6399	1.1842 ^a 8.4575	1.0806 ^a 9.5098	2.2816 ^a 5.8407	-	2.4641 ^a 9.9328
δ_{cons}	1.5110 ^a 9.2793	1.4929 ^a 9.8668	1.5412 ^a 11.2685	-0.3529 -1.0945	-	
δ_{trend}				0.0921 ^a 6.0575		0.0698 ^a 6.9532
Depreciation rate						
Year one	0.1808	0.1764	0.2288	0.5648	-	0.4102
Year 10				0.3617	-	0.3474
Year 20				0.1841	-	0.1916
Cohort		-0.1113 ^a -5.7361	-0.0669 ^a -3.2020	-0.1484 ^a -2.7996	-	-0.1974 ^a -4.0111
EU PBR		0.5327 ^a 3.3351	0.5662 ^a 3.8536	1.2506 ^a 3.6321	-	1.8171 ^a 5.3918
Init. Area		0.4696 ^a 3.5417	0.9421 ^a 4.6117	1.9507 ^a 4.2450	-	2.5536 ^a 4.5614
PBRs Applicant			-0.3769 ^a -6.5506	-0.7955 ^a -5.1384	-	-0.1172 -1.0337
PBRs Competitors			-0.2746 ^b -2.3352	-0.5403 ^b -1.9902	-	-0.7136 ^b -2.3309
French			0.4158 ^a 4.2979	0.9314 ^a 3.7301	-	0.6842 ^a 3.0865
Area change					-	0.0264 0.0590
New Rights App.					-	0.0787 ^a 5.6726
Exit Applicant					-	-0.1785 ^a -13.5477
New Rights Comp.					-	-0.0025 -1.4770
Exit Competitors					-	0.0052 ^b 2.1231
Log L	2 359	-2 305	-2 257	-2 240	-	-2 073
LR	16.71	109.00	96.51	32.39	-	335.20
Simulated Values (in thousands of constant 2005 euros)						
Mean	3.11	3.28	3.01	301.46	-	403.29
10%	0.05	0.05	0.05	0.17	-	0.18
25%	0.26	0.26	0.26	1.30	-	1.45
Median	0.98	1.02	0.94	8.97	-	10.29
75%	3.06	3.21	2.95	55.59	-	65.77
90%	7.61	8.00	7.37	280.52	-	339.49
99%	31.56	33.30	30.25	4 432	-	5 624
99.9%	83.07	89.41	81.97	33 020	-	43 225

Note a, b and c mean significant at 1%, 5% and 10% respectively

Table 2.6: Peas Results

	Model 1	Model 2	Model 3	Model 4	Model 5	Model 6
μ	5.5042 ^a 42.1747	5.0429 ^a 5.9700	6.1773 ^a 6.2350	7.7924 ^a 4.2923	6.1268 ^a 5.2792	8.5308 ^a 3.7596
σ	0.8934 ^a 10.0399	0.8593 ^a 7.7611	0.8445 ^a 7.9237	1.3163 ^a 3.8495	0.9674 ^a 6.6564	1.7168 ^a 7.3771
δ_{cons}	2.1162 ^a 13.7617	2.1120 ^a 11.8199	2.1079 ^a 11.9233	0.65029 1.2317	1.6743 ^a 6.1990	
δ_{trend}				0.0848 ^a 3.3572		0.1015 ^a 6.3265
Depreciation rate						
Year one	0.1075	0.1079	0.1083	0.3241	0.1386	0.4140
Year 10				0.1827	0.1118	0.2129
Year 20				0.0874	0.1249	0.1049
Cohort		-0.0279 -1.4920	-0.0371 ^b -2.0384	-0.0575 ^c -1.8645	-0.0342 -1.6132	-0.0628 ^c -1.7078
EU PBR		-0.0087 -0.0345	-0.0789 -0.3016	-0.1180 -0.2953	-0.0638 -0.2073	-0.1011 -0.1870
Init. Price		0.3103 1.3040	0.1787 0.7919	0.2887 0.7233	0.1357 -0.0705	0.1337 0.0203
Init. Area		0.0474 1.1015	0.0878 ^b 1.9631	0.1377 ^c 1.8015	-0.0190 -0.2683	0.0103 0.0751
PBRs Applicant			-0.2261 ^a -3.0757	-0.3487 ^b -2.5136	-0.0742 -0.8457	-0.0236 -0.1451
PBRs Competitors			-0.0624 -0.4940	-0.0993 -0.4830	-0.0528 -0.3880	-0.0754 -0.2913
French			0.1005 1.0096	0.1532 0.9689	0.0758 0.6225	0.1076 0.4896
Price change					0.2549 0.2999	0.5913 0.7408
Area change					-0.2473 -2.7829	-0.1472 -1.3942
New Rights App.					0.0835 0.9541	0.1143 1.4562
Exit Applicant					-0.3565 ^a -7.6894	-0.3904 ^a -7.1133
New Rights Comp.					0.0361 ^a 2.7996	0.0298 ^b 2.3460
Exit Competitors					0.0282 ^c 1.7313	0.0212 1.4508
Log L	-900.62	-887.51	-881.08	-871.28	-850.08	-840.68
LR	23.94	26.21	12.86	32.39	61.63	69.19
Simulated Values (in thousands of constant 2005 euros)						
Mean	1.58	1.64	1.65	6.70	2.67	30.32
10%	0.05	0.05	0.05	0.10	0.05	0.14
25%	0.21	0.20	0.20	0.45	0.24	0.75
Median	0.66	0.66	0.67	1.74	0.86	3.60
75%	1.78	1.85	1.86	5.74	2.67	15.16
90%	3.95	4.16	4.17	15.42	6.57	52.72
99%	13.11	13.56	13.85	76.50	26.49	445.62
99.9%	29.39	28.98	29.86	236.60	68.15	2 066

Note a, b and c mean significant at 1%, 5% and 10% respectively

Table 2.7: Potatoe Results

	Model 1	Model 2	Model 3	Model 4	Model 5	Model 6
μ	6.1244 ^a 23.7069	5.4388 ^a 11.2466	5.1279 ^a 8.3157	5.5670 ^a 6.8347	6.4203 ^a 7.3208	9.5942 ^a 5.6757
σ	1.1139 ^a 5.5130	1.1041 ^a 5.5704	1.0750 ^a 5.4879	1.3057 ^a 4.0874	1.3165 ^a 4.3970	2.6982 ^a 7.2482
δ_{cons}	2.2569 ^a 10.5366	2.2057 ^a 10.0592	2.2227 ^a 9.9825	1.5307 ^a 3.8413	1.8235 ^a 5.9387	
δ_{trend}				0.0327 ^b 2.5455		0.0618 ^a 5.9545
Depreciation rate						
Year one	0.0948	0.0992	0.0976	0.1732	0.1131	0.3839
Year 12				0.1276	0.1306	0.2448
Year 25				0.0873	0.1202	0.1463
Cohort		-0.0036 -0.2898	-0.0074 -0.4661	-0.0069 -0.3577	-0.0401 -1.4653	-0.0597 -1.2428
EU PBR		-0.9624 ^b -2.4355	-0.9654 ^b -2.4047	-1.2040 ^b -2.2704	-0.8267 ^c -1.7151	-1.7763 ^c -1.9097
Init. Price		0.4295 ^c 1.9494	0.4320 ^b 1.9659	0.5362 ^c 1.8663	0.3634 1.3174	0.7673 1.3585
Init. Area		0.3357 ^c 1.8304	0.3508 ^c 1.7670	0.4382 ^c 1.7686	-0.1492 -0.5822	0.2953 0.6225
PBRs Applicant			0.1236 ^c 1.8530	0.1489 ^c 1.7508	0.2580 ^b 2.2978	0.4965 ^b 2.1994
PBRs Competitors			0.0085 0.0664	-0.0079 -0.0496	-0.1006 -0.6239	-0.2799 -0.8198
French			0.3346 ^b 2.1830	0.4112 ^b 2.0516	0.2644 1.3617	0.5480 1.4277
Price change					0.1176 0.3912	0.0356 0.1178
Area change					6.0003 ^a 5.7748	4.4421 ^a 4.0869
New Rights App.					0.3776 ^a 4.0876	0.3791 ^a 4.2699
Exit Applicant					-0.2926 ^a -8.9435	-0.3372 ^a -8.2176
New Rights Comp.					0.0004 -0.0441	0.0001 -0.0177
Exit Competitors					0.0359 ^a 3.0833	0.0448 ^a 3.8644
Log L	-1 199	-1 182	-1 178	-1 174	-1 108	-1 106
LR	28.21	34.11	9.43	6.43	139.64	136.20
Simulated Values (in thousands of constant 2005 euros)						
Mean	5.63	6.41	6.12	12.60	3.47	3 249
10%	0.16	0.14	0.14	0.20	0.76	0.62
25%	0.60	0.60	0.20	0.91	2.99	5.47
Median	2.12	2.29	2.24	3.56	10.38	45.45
75%	6.04	6.80	6.56	11.52	31.38	344.01
90%	13.85	15.88	15.20	29.70	80.00	2 059
99%	51.01	60.03	56.05	135.54	380.52	44 251
99.9%	128.40	151.43	138.55	410.76	1 121	396 870

Note a, b and c mean significant at 1%, 5% and 10% respectively

Concerning the impact of PBR-specific variables, the fact that the applicant is a French firm (variable *French*) implies that the initial rent is significantly higher *ceteris paribus* for maize, sunflower, and potatoes (in Model 3 and Model 4) but significantly lower for wheat (in Model 5 and 6) and rapeseed. The initial rent is neither higher nor lower for spring wheat compared to other varieties of wheat (variable *Spring* in Table 2.2). According to the size and significance of the coefficient of *PBRs Applicant*, the market power effect seems to prevail on the minor incremental effect for wheat, maize, potatoes. Conversely, the minor incremental effect seems to prevail on the market power effect for sunflower and peas (in Model 3 and Model 4). None of the two effects prevails for rapeseeds. The ambivalent effect of variables *New Rights App.* and *Exit Applicant* on the depreciation rate of the rent is confirmed by the signs obtained for these variables in the case of wheat and the signs obtained (when significant) for maize, rapeseeds, sunflower, peas and potatoes. In the case of wheat, the gain in terms of a higher market power seems to be more important than the dilution effect, so that *New Rights App.* weakens the depreciation rate whereas *Exit Applicant* strengthens the depreciation rate. It is exactly the opposite for the six other crops. This contrasted effect can result from the importance (in terms of acreage and economic stakes) of wheat in France. The expected negative effect of *PBRs Competitors* on the initial rent is significant only for rapeseeds (in Model 3) and sunflower. Estimation results for variables *Init Area*, *New Rights Competitors* and *Exit Competitors* deserve more comments because they do not only explain either the initial rent or the depreciation of the rent, but their coefficients are also key coefficients to test the potential impact of a removal of exemption rules that distinguish PBRs from patent.

2.3.3 A test of the exemption rules

We now turn to a discussion of the way we can test the impact of exemption rules.

The farmers' exemption rule allows farmers to self-produce seeds from their harvested crops for their own usage. For this exemption rule to affect the value of PBRs, it is required that the initial rent is sensitive *ceteris paribus* to the total acreage of land

devoted to the crop. Indeed, a removal of the exemption rule is expected to induce a switch of farmers previously using farm-saved seeds to breeders' seeds. Consequently, if a proportion x of seeds currently used for a crop are farm-saved seeds, removing the farmers exemption potentially implies a maximum increase by $100 * (x/(1-x))\%$ of the market size for seeds of the crop. This is only an upper bound of the expected increase because farmers may prefer to switch to other crops rather than buying certified seeds of the initial crop. It is worthwhile stressing that the *ceteris paribus* clause plays a crucial role to correctly assess this effect. It is crucial to control for the price of the crop in order to distinguish between, on the one hand, an increase of the total acreage induced by an increase of the price of the crop and, on the other hand, an increase of the total acreage that occurs independently of an increase of the price of the crop. The model we have estimated allows for this distinction and is thus suitable for the test, except in the case of sunflower for which we did not manage to obtain price data for a sufficiently long period. Moreover, for the farmers' exemption to matter, it is required that the initial rent is positively and significantly impacted by variations in the total acreage of the crop for an unchanged price of the crop. This precludes the case of wheat for which Table 2.2 reports a negative, albeit not significant, coefficient of the variable *Init. Area*, whatever the model considered. We interpret this as a consequence of the low dispersion of the observed acreage compared to the average acreage over the period studied. Another prerequisite to test the impact of a removal of the farmers' exemption is that the share of farm-saved seeds for the crop is sufficiently high. This is not the case for maize. Consequently, the focus is only on three crops to test the impact of farmers' exemption: rapeseeds, peas and potatoes. Moreover, Model 5 is eliminated in the case of peas and potatoes because the coefficient of *Init. Area* is negative. Table 2.8, Table 2.9 and Table 2.10 present detailed results on the distribution of the relative increase of the value of PBRs that would result from a removal of the farmers exemption for these three crops². The first row of the bottom part of the three Tables yields the simulated relative increase of the mean of values whereas the next rows report the

2. The corresponding change of values in thousand of 2005 constant euros are reported in smaller just below.

simulated relative increase of the values according to the initial quantile of value.

The upper row of the three Tables reports the current share of farm-saved seeds in the total quantity of seeds of the corresponding crop in France. The relative increase of the value of PBRs has been computed for each PBR in the dataset with a statutory life limit that was anterior to the end of the period studied. Indeed, we wanted to avoid having to rely on forecasts of the variables affecting the dynamics of the rent and thus the study has been restrained to cohorts for which the time path of these variables was completely observed. Simulation results are very consistent from one model to another one in the case of potatoes. In average, a removal of the farmers' exemption would generate, at best, an increase of 3% to 5% of the value of PBRs. Although the coefficient of *Init. Area* is not significant in Table 2.10, the simulated increase for Model 6 is still reported. The simulated impact of the removal of the farmers' exemption is slightly higher for peas. It is close to a 10% increase of values, whatever the initial quantile of values considered, with Models 3 and 4. It is lower with Model 2 and much lower with Model 6, but the result is less reliable for these two models as far as the corresponding coefficient of *Init. Area* reported in Table 2.9 is positive but not significantly different from zero. Similarly, in the case of rapeseeds, we focus on the results for Models 3 and 5 because the corresponding coefficient of *Init. Area* in Table 4 is more significant for these models than for models 2, 4 and 6. Notwithstanding this precaution, results in the case of rapeseeds depend on the model considered. Nevertheless, the simulated increase of the value of PBRs is more than 50% whatever the model considered and whatever the initial quantile of value considered. We conclude that the value of PBRs for rapeseeds would be much more sensitive to the removal of the farmers' exemption than for peas and potatoes.

Table 2.8: Farmers' privilege impact for rapeseed

Share of FSS	30%				
	Model 2	Model 3	Model 4	Model 5	Model 6
Mean	54% 10.11	65% 11.13	136% 1659	108% 332.86	2.8% 181.37
10%	69% 0.92	84% 1.14	143% 11.99	160% 1.35	3.4% 0.10
25%	62% 2.11	75% 2.53	138% 44.68	133% 3.75	30% 0.59
Median	57% 4.90	68% 5.72	137% 192.35	115% 10.71	2.9% 3.96
75%	54% 11.39	65% 12.76	136% 816.77	109% 29.30	2.8 25.691
90%	53% 23.46	64% 26.17	136% 2893	106% 73.49	2.8% 141.66
99%	52% 77.74	62% 84.80	136% 24696	105% 347.28	2.8% 2539
99.9%	52% 180.04	62% 187.0	136% 121040	105% 1223	2.8% 21444

Normal size numbers are the relative increase of the value of PBRs whereas small size numbers are the absolute increase of the value of PBRs in thousands of 2005 constant euros.

Table 2.9: Farmers' privilege impact for peas

Share of FSS	51%			
	Model 2	Model 3	Model 4	Model 6
Mean	4% 0.11	8% 0.35	11% 1.18	0.8% 0.43
10%	8% 0.01	16% 0.03	18% 0.06	1% 0.01
25%	6% 0.03	12% 0.7	14% 0.15	0.9% 0.02
Median	5% 0.07	10% 0.18	12% 0.43	0.8% 0.07
75%	5% 0.14	9% 0.40	11% 1.15	0.8% 0.23
90%	4% 0.26	8% 0.79	11% 2.68	0.8% 0.81
99%	4% 0.67	7% 2.53	10% 11.63	0.7% 5.81
99.9%	4% 1.33	7% 5.85	10% 34.68	0.7% 24.46

Normal size numbers are the relative increase of the value of PBRs whereas small size numbers are the absolute increase of the value of PBRs in thousands of 2005 constant euros.

Table 2.10: Farmers' privilege impact for potatoe

Share of FSS	10%			
	Model 2	Model 3	Model 4	Model 6
Mean	4% 0.11	4% 0.40	5% 1.00	3% 0.43
10%	7% 0.03	7% 0.03	8% 0.05	4% 0.11
25%	6% 0.08	6% 0.09	6% 0.14	3% 0.64
Median	5% 0.21	5% 0.21	6% 0.40	3% 4.23
75%	4% 0.47	4% 0.47	5% 1.01	3% 28.10
90%	4% 0.94	4% 0.92	5% 2.29	3% 152.76
99%	4% 3.09	4% 2.96	5% 9.43	3% 2844
99.9%	4% 7.35	4% 6.92	5% 27.20	3% 24112

Normal size numbers are the relative increase of the value of PBRs whereas small size numbers are the absolute increase of the value of PBRs in thousands of 2005 constant euros.

The inventors exemption allows breeders to freely use varieties created by competitors and protected by a PBR for developing new varieties. It originates in the generally accepted idea that plant variety creation is essentially an incremental innovation process. The removal of the inventors exemption is thus expected to slow down the pace of variety creation. For this exemption rule to affect the value of PBRs, it is not only required that the depreciation rate is increased when competitors are granted new PBRs and decreased when competitors withdraw their PBRs, but also that the depreciation accelerates when the variety protected by the PBR in interest is "downgraded". What is meant by "downgraded" greatly matters for the test. It actually means that varieties can be ranked unequivocally and that the rank of the PBR in interest is deteriorated to reflect the effect of ongoing innovation. Downgrading just implies a change of the rank of the PBR in interest, independently of an increase of the number of PBRs to be ranked. It is thus crucial, in order to correctly capture this phenomenon, to control for the number of total PBRs on varieties of the crop. In other words, downgrading a PBR in our model results from the simultaneous grant of a new competing PBR and the withdrawal of an old one. It is thus measured as the net effect of the variables *New Rights Comp.* and *Exits Competitors* on the depreciation rate of the rent. The

inventors' exemption will be considered to affect the value of PBRs if and only if the following three effects are observed simultaneously : a significant and negative coefficient of *New Rights Comp.* (variety creation by competitors accelerates the depreciation of the PBR in interest), a significant and positive coefficient of *Exists Competitors* (the withdrawal of PBRs by competitors slows down the depreciation of the PBR in interest) and a negative net cumulated effect of *New Rights Comp.* and *Exists Competitors* (downgrading the PBR in interest accelerates its depreciation). We consider the net effect of these variables rather than considering the net effect of variables *New Rights App.* and *Exists Applicant* as our focus is on the effect of innovation by competitors. Indeed, new varieties created by the same applicant may be strategically designed to avoid a "cannibalization" of the rent of her previously granted PBRs. Notice that only Model 5 and Model 6 that allow for an effect of these variables on the depreciation rate are suitable for the test.

The only crop that satisfies simultaneously the three conditions for the inventors' exemption to matters for the value of PBRs is maize, at least with Model 5 (the coefficient of *Exists Competitors* is not significant with Model 6). This is consistent with the fact that the number of PBRs granted during the period studied is much higher for maize than for other crops. The high number of PBRs granted suggests that variety creation is at the core of the market of seeds for that crop. For the other crops, most of the time, the relevant coefficients are not significantly different from zero. More surprisingly, the coefficient of *New Rights App.* is significantly different from zero but positive in the case of peas. Even if the significance of coefficients is disregarded, at least one of the three conditions to test that the inventors' exemption matters is not satisfied. A possible explanation of the absence of sensitivity of the value of PBRs to the inventor's exemption is that each applicant actually targets a specific niche and develops new varieties within this niche but does not attempt to compete with other firms outside this niche. Thus, following the logic of horizontal differentiation, the value of PBRs are not affected by the grant of PBRs to competitors because the distance between PBRs of different applicants is sufficiently wide to substantially lessens the effects of

competition.

2.4 *Conclusion*

In order to assess whether the farmers' exemption and the inventors' exemption significantly affect the value of PBRs compared to what it would amount to in the absence of these exemption rules, a model of renewal decisions suitable for estimation on PBR level micro data has been developed. The estimation of the model on French PBRs for six major crops over the last decades yields mitigated results as regards the importance of the two exemption rules.

Empirical evidence of a detrimental impact of the inventors' exemption is found for only one of the six crops, maize. The farmers' exemption is found to have a more significant impact, at least for the three crops for which the total acreage affect the value of PBRs and the proportion of farm-saved seeds is relatively high. These results suggest that product differentiation is likely to alleviate the consequences of the inventors' exemption whereas the farmers exemption has contrasted consequences depending on the crop in interest.

2.5 Bibliography

- Alston, J. and Venner, R. The effects of the us plant variety protection act on wheat genetic improvement. *Research Policy*, 31(4):527–542, 2002. doi:10.1016/S0048-7333(01)00123-8.
- Arrow, K. Economic welfare and the allocation of resources for invention. In *The rate and direction of inventive activity: Economic and social factors*, pages 609–626. Princeton University Press, 1962. URL <http://papers.nber.org/books/univ62-1>.
- Barney, J. A. Study of patent mortality rates: Using statistical survival analysis to rate and value patent assets. *AIPLA Quarterly Journal*, 30(3):317, 2002.
- Baudry, M. and Dumont, B. Patent renewals as options: improving the mechanism for weeding out lousy patents. *Review of Industrial Organization*, 28(1):41–62, 2006. doi:10.1007/s11151-006-0001-0.
- Baudry, M. and Dumont, B. Valuing patents using renewal data: an inquiry into the feasibility of an automated patent scoring method. Working Paper, 2012.
- Bessen, J. The value of us patents by owner and patent characteristics. *Research Policy*, 37(5):932–945, 2008. doi:10.1016/j.respol.2008.02.005.
- Bessen, J. Estimates of patent rents from firm market value. *Research Policy*, 38(10):1604–1616, 2009. doi:10.1016/j.respol.2009.09.014.
- Bloom, N. and Van Reenen, J. Patents, real options and firm performance. *The Economic Journal*, 112(478):C97–C116, 2002. doi:10.1111/1468-0297.00022.
- Carew, R. and Devadoss, S. Quantifying the contribution of plant breeders’ rights and transgenic varieties to canola yields: Evidence from manitoba. *Canadian Journal of Agricultural Economics/Revue canadienne d’agroeconomie*, 51(3):371–395, 2003. doi:10.1111/j.1744-7976.2003.tb00181.x.

- Cornelli, F. and Schankerman, M. Patent renewals and r&d incentives. *The RAND Journal of Economics*, 30(2):197–213, 1999. URL <http://www.jstor.org/stable/2556077>.
- Dasgupta, P. and Stiglitz, J. Uncertainty, industrial structure, and the speed of r&d. *The Bell Journal of Economics*, 11(1):1–28, 1980. URL <http://www.jstor.org/stable/3003398>.
- Diez, M. The impact of plant varieties rights on research: the case of spain. *Food Policy*, 27(2):171–183, 2002. doi:10.1016/S0306-9192(02)00010-6.
- Evenson, R. Economic impacts of agricultural research and extension. In *Handbook of agricultural economics*, volume 1, pages 573–628. Elsevier, 2001. doi:10.1016/S1574-0072(01)10014-9.
- Griliches, Z. Patent statistics as economic indicators: A survey. *Journal of Economic Literature*, 28(4):1661–1707, 1990. URL <http://www.jstor.org/stable/2727442>.
- Hall, B. H., Jaffe, A., and Trajtenberg, M. Market value and patent citations. *RAND Journal of Economics*, 36(1):16–38, Spring 2005. URL <http://www.jstor.org/stable/1593752>.
- Lanjouw, J., Pakes, A., and Putnam, J. How to count patents and value intellectual property: The uses of patent renewal and application data. *The Journal of Industrial Economics*, 46(4):405–432, 1998. URL <http://www.jstor.org/stable/117497>.
- Lesser, W. Valuation of plant variety protection certificates. *Review of Agricultural Economics*, 16(2):231–238, 1994. URL <http://www.jstor.org/stable/1349465>.
- Lesser, W. An economic approach to identifying an effective sui generis system for plant variety protection under trips. *Agribusiness*, 16(1):96–114, 2000. URL <http://EconPapers.repec.org/RePEc:wly:agribz:v:16:y:2000:i:1:p:96-114>.

- Louwaars, N. P., Tripp, R., Eaton, D., Henson-Apollonio, V., Hu, R., Mendoza, M., Muhhuku, F., Pal, S., and Wekundah, J. Impacts of strengthened intellectual property rights regimes on the plant breeding industry in developing countries. Technical report, World Bank, 2005.
- Pakes, A. Patents as options: Some estimates of the value of holding european patent stocks. *Econometrica*, 54(4):755–784, 1986. URL <http://www.jstor.org/stable/1912835>.
- Pakes, A. and Schankerman, M. The rate of obsolescence of patents, research gestation lags, and the private rate of return to research resources. In *R & D, Patents, and Productivity*, pages 73–88. University of Chicago Press, 1984.
- Schankerman, M. How valuable is patent protection? estimates by technology field. *the RAND Journal of Economics*, 29(1):77–107, 1998. URL <http://www.jstor.org/stable/2555817>.
- Schankerman, M. and Pakes, A. Valeur et obsolescence des brevets: une analyse des statistiques de renouvellement des brevets européens. *Revue économique*, 36(5):917–941, 1985. URL <http://www.jstor.org/stable/3501560>.
- Schankerman, M. and Pakes, A. Estimates of the value of patent rights in european countries during the post-1950 period. *The Economic Journal*, 96(384):1052–1076, 1986. URL <http://www.jstor.org/stable/2233173>.
- Scotchmer, S. On the optimality of the patent renewal system. *The RAND Journal of Economics*, 30(2):181–196, 1999. URL <http://www.jstor.org/stable/2556076>.
- Srinivasan, C. S. Exploring the feasibility of farmers’ rights. *Development Policy Review*, 21(4):419–447, 2003. doi:10.1111/1467-7679.00218.
- Srinivasan, C. S. Modelling economic returns to plant variety protection in the uk. *Bio-based and Applied Economics*, 1(2):151–174, 2012. doi:10.13128/BAE-10557.

Thomson, R. The yield of plant variety protection. *American Journal of Agricultural Economics*, 97(3):762–785, 2015. doi:10.1093/ajae/aau099.

Chapter 3

Innovation on the seed market: the role of IPRs and commercialisation rules

Innovation on the seed market: the role of IPRs and commercialisation rules

Baudry Marc^{*†} Hervouet Adrien[‡]

Abstract

This article deals with the impact of legal rules that apply to the seeds sector on incentives to create new plant varieties. The first category of rules consists in intellectual property rights and is intended to address a problem of sequential innovation and R&D effort. The second category concerns commercial rules that are intended to correct a problem of adverse selection. We propose a dynamic model of market equilibrium with vertical product differentiation that enables us to take into account the economic consequences of imposing either Plant Breeders' Rights (PBRs) or patents as IPRs and either compulsory registration or minimum standards as commercialisation rules. The main result is that the combination of minimum standards and PBRs (patents) provides higher incentives for sequential and initial innovation and may be preferred by a public regulator when sunk investment costs are low (high) and the probability of R&D success is sufficiently high (low).

Keywords: Intellectual Property Rights, Plant Breeders' Rights, Catalogue, Product differentiation, Seed market, Biodiversity

JEL classifications: D43, K11, L13, Q12, Q16

*. Université de Paris Ouest Nanterre la Défense, EconomiX (UMR CNRS 7235), 200 Avenue de la République, 92001 Nanterre Cedex, France

†. Climate Economics Chair, Palais Brongniart, 4th floor, 28 place de la Bourse, 75002 Paris, France

‡. Institut d'Économie et de Management de Nantes-IAE, LEMNA, Chemin de la Censive de Tertre, BP 52231, 44322 Nantes, France, Tel.: +33 2 40 14 17 19, adrien.hervouet@univ-nantes.fr

3.1 Introduction

Since the early twentieth century, public authorities have been very active/keen to set up instruments that aim at preserving and enhancing the diversity of plants and seeds used in the agricultural sector. Such diversity is seen as a public good (non rivalry and non excludability) subject to underinvestment due to the non-cooperative behaviour of private agents in the sector (see Polasky and al., 2005; Altieri, 1999, for a review of biodiversity's economic aspects). The use of different varieties of the same plant by neighbourhood farmers may, for instance, limit the risk of spreading of plant diseases to the whole community of farmers. Two complementary types of instruments have been set up: Intellectual Property Rights (IPRs) and seeds commercialisation rules. Yet, the existing literature has never dealt with them simultaneously. Therefore, little is known about the respective merits of the different combinations of instruments. This article aims at filling the gap and, more specifically, it focuses on the contrasted solutions adopted in the United States and in Europe.

The rationale for defining intellectual property rights for plant varieties is that anthropic intervention is essential to obtain new varieties, thanks to seed selection for instance. Such interventions are costly and may thus be rewarded to occur as the outcome of a planned research and development activity of rational economic agents (Scotchmer, 2004). Although this general idea is widely acknowledged and is part of the international agreement on Trade-Related aspects of Intellectual Property Rights (TRIPS), whether *sui generis* IPRs or patents have to be used is controversial. Partisans of *sui generis* IPRs argue that inventions in the seed sector are essentially incremental/cumulative and that a "research exemption" enabling breeders to freely develop new varieties from protected varieties created by others is required to efficiently promote innovation and biodiversity. Cumulative innovation was discussed by Scotchmer (1991) who gives an overview of the main related issues and by O'Donoghue et al. (1998) who highlight problems arising from the choice of patents length and breadth of in a context of cumulative inventions. In accordance with the International Union for the Protec-

tion of New Varieties of Plants (UPOV) convention¹, the European Union has set up specific Plant Breeders' Rights (PBRs) also known as Plant Variety Rights (PVRs) or Plant Variety Protection (PVP). Like patents, PBRs are granted to the breeder of a new variety of plant and give her exclusive control over its marketing and use for a predefined number of years, but they come with the research exemption described above. Partisans of patents, and among them the United States, contest the fact that new plant varieties have to be systematically treated as specific inventions² and argue that patents can also be used to protect plant variety creation.

IPRs in agricultural biotechnology are discussed by Lesser (1999, 2000), Louwaars et al. (2005), Trommetter (2008). Ramanna and Smale (2004) and Ramanna (2006) focus on the particular IPRs system on plant variety in India. Nevertheless, the economic literature that more specifically deals with PBRs has mainly focused on the empirical assessment of the effectiveness of incentives to innovate that intellectual property rights are supposed to generate. No definitive conclusions can be drawn from this literature. Like Alston and Venner (2002), Carew and Devadoss (2003) attempt to test whether yields have significantly increased thanks to PBRs for respectively wheat in the United States and canola in Canada. They find no significant impact. By contrast, Diez (2002) scrutinises the role of PBRs in Spain and concludes in favour of a positive impact. Whereas these works have attempted to assess whether the grant of PBRs impacts productivity of farms, Lesser (1997) and Srinivasan (2003, 2012) are rather interested in assessing the value of PBRs for breeders. An exception is Srinivasan (2003) who also aims at evaluating farmers' rights in India. Among theoretical works which address the design and the role of IPRs in agriculture, Ambec et al. (2008) and Perrin and Fulginiti (2008) examine the Coase conjecture with different assumptions concerning the behaviour of farmers and breeders and market conditions. Lence et al. (2005), for their part, develop a model with three possible equilibria to look at the impact of the appropriability level.

1. The UPOV promotes PBRs as IPRs on plants, at the time of writing there were 72 signatories of the UPOV convention. The convention can be found at http://www.upov.int/upovlex/en/upov_convention.html.

2. However, the U.S. have also a PBRs system but only for sexually reproduced plants.

More generally, the academic literature lacks discussions of the respective merits of patents and PBRs for stimulating innovation in the seed sector. Noticeable exceptions are Moschini and Yerokhin (2008) and Yerokhin and Moschini (2008) who find that when research cost is high, PBRs is not the best option. Bessen and Maskin (2009) and Nagaoka and Aoki (2009) look at "innovation imitation" which is quite similar to research exemption, however they do not really compare PBRs and Patents. Nevertheless, these works do not address the question of the optimal coupling of commercialisation rules and IPRs. Little has been said from an academic economist's point of view about what combination of commercialisation rules and IPRs should be preferred and about who could gain or lose from a switch in the current system to this combination, if different from the current system. This article brings insights into the key question of how to optimally combine IPRs rules and commercialisation rule.

Divergence across countries about the relevant IPRs overlaps divergence regarding the second type of instrument; seed commercialisation rules. Commercialisation rules are specifically designed to address the adverse selection problem that arises in the seed market (Akerlof, 1970). When faced with the opportunity to buy seeds of a new plant variety or of an old plant variety that is not widely grown, farmers need a credible assessment of the characteristics of the variety. In the absence of such a credible assessment, they would not accept to pay different prices for differentiated seeds and the eviction of "high quality" varieties by "low quality" varieties would occur. Without the opportunity to buy seeds that better fit their needs, farmers would then incur a loss in terms of yields and profitability. Addressing the adverse selection problem in the seed market thus not only matters for the promotion of biodiversity but is also important in boosting agricultural production. Instruments set up to circumvent the problem of adverse selection generally consist of regulatory approval based on the fulfilment of minimum standards by commercialised seeds. How stringent these minimum standards are greatly depends on the country. In the European Union, registration in an official catalogue is mandatory and requires to pass the Distinctness Uniformity and Stability

(DUS) test and the Value for Cultivation and Use (VCU) test. The DUS and VCU tests are carried out by the authority which is also competent for granting Plant Breeders' Rights or by separate institutions, such as public research institutes, acting on behalf of that authority. Commercialisation approval is thus tightly linked to Plant Breeders' Rights in the European Union. By contrast, commercialisation rules in the United States rely on less stringent criteria and, last but not least, it is not tight to the grant of a patent or a PBR on the commercialised variety (see Tripp and Louwaars, 1997, for a description of the regulation of the seed market for different countries around the world). As a result, a "free seeds" movement has developed in Europe to stress that the way Plant Breeders' Rights are coupled with commercialisation rules is detrimental to the promotion of biodiversity. Some NGOs that belong to the "free seeds" movement even contest the principle of property rights. The key point is that landrace varieties contributing to biodiversity can not be commercialised because they do not fulfil one or several of the three DUS criteria. The debate in Europe is thus bipolarised with opponents (mainly NGOs and some farm unions) to current commercialisation rules and/or property rights on the one side and partisans (mainly large firms from the seed industry) of the current coupled system of PBRs and DUS based commercialisation rules on the other side. This article tries to highlight the debate from an academic perspective.

Section 2 proposes a theoretical model to analyse the optimal combination of commercialisation rules and IPRs for the seed market. It starts with an adaptation to the seed market of the vertical differentiation model proposed by Prescott and Visscher (1977) and used, among others, by Bresnahan (1987) to describe the U.S. car market. A feedback effect of biodiversity is introduced. It implies that the equilibrium of the seeds market has to be determined as a fixed point. Moreover, plant varieties are assumed to result from a sequence of incremental inventions that follows on from an initial drastic invention. Each invention results from an uncertain R&D process that induces sunk R&D costs. It is shown that both the type of IPRs and the type of commercialisa-

tion rule that are set up by public authorities affect market structure at each period and consequently affect the dynamic innovation game. Section 3 presents numerical simulations based on calibration of the model for wheat in France. It is intended to provide some insights on which combination of IPRs and commercialisation rules may be preferred by a public regulator. It is found that the European choice of coupling PBRs and a catalogue commercialisation rule can hardly be considered as a good choice for the regulator. Section 4 concludes with a proposal for improving regulation of the seed market.

3.2 Model setting

Though innovation is intrinsically a dynamic process, we first attempt to develop a static analysis of the seed market. The underlying idea is that the market structure is influenced by the type of IPRs that prevails for plant varieties. Therefore, prior considering the dynamic effects of IPRs on innovation, we have to determine their static effects. For this purpose, we adapt a standard market equilibrium model with vertical differentiation to our problem. We first characterise the demand addressed by heterogenous farmers to different varieties of seeds for a same crop. We then turn to the analysis of the supply side. We distinguish between a landrace variety and "breeder" varieties. "Breeder" varieties are supplied and created by breeders whereas the landrace already exists. Suppliers of the landrace variety have no market power whereas breeders of created varieties have a market power that crucially depends on the type of IPRs that prevail for plant varieties. In addition to the distinction between a patent regime and PBRs, we furthermore examine the impact of opting for minimum standards or a catalogue for regulating the commercialisation of seeds.

3.2.1 The demand side of the market

The analysis of incremental innovation, whether on the seed market or on any other market, requires to account for product differentiation. In order to reflect the fact that

new varieties of seeds generally improve the performance of crops compared to previous varieties, we adapt the model of vertical differentiation by Prescott and Visscher (1977) to the seeds market. For this purpose, we first present the behaviour of farmers and then turn to the analysis of the demand system. We finally discuss why the choice of a commercialisation rule for seeds matters and how biodiversity interacts with market equilibrium.

Farmers behaviour

We consider farmers growing the same crop by means of three different types of input: land L , seeds S and a vector Z of other inputs including capital and labor. We more specifically consider the nested production function

$$Y = A \text{Min} [\alpha S; \beta L; \gamma f(Z)] \epsilon_i \tag{3.1}$$

where Y stands for the output level, $f(Z)$ is a sub-production function with constant returns to scale and ϵ_i is a random term with mean μ_i and standard deviation σ_i . The underlying idea is that seeds land and the whole set of other inputs are perfect complements but that substitution between other inputs (namely capital and labour) is possible. A is a productivity parameter, the value of which may depend on a measure of biodiversity assumed to be exogenous for the time being. The random term ϵ_i captures the fact that the variety i of crop grown affects both the average production level and its variability. The random profit level $\tilde{\pi}_i$ for a farmer that chooses variety i when the unit price of seeds is w_i may be expressed as

$$\tilde{\pi}_i = P A \alpha S \epsilon_i - \delta_i S \tag{3.2}$$

where $\delta_i = w_i + w_z \alpha/\gamma$ is obtained from the standard linear unit cost function associated with a Leontieff production function. w_z is the minimum cost at which elements of the vector Z of variable inputs may be combined to obtain the efficient aggregate level $f(Z) = S \alpha/\gamma$ associated to a given quantity of seeds S . Land is

treated as a fixed input so that its price does not appear in the expression of the profit level. If land was a variable input with unit price w_L , then $w_L\alpha/\beta$ would have to be added to δ_i . The profit level is expressed in terms of S rather than in terms of L or Z in order to focus on the demand of seeds.

Farmers are assumed to have a constant relative risk aversion index in the sense that the risk premium they associate to their random profit level $\tilde{\pi}_i$ is proportional to the surface of land they use and, as a direct consequence of perfect complementarity between land and seeds, proportionnal to the quantity of seeds they buy. In order to capture this attitude toward risk, the mean-standard deviation version of Markowitz's criteria is used (Markowitz, 1952). Accordingly, the risk adjusted profit level of a farmer choosing variety i of the crop is given by

$$\pi_i = (P A \alpha S \mu_i - \delta_i S) - \theta (P A \alpha S \sigma_i) \tag{3.3}$$

where θ is a risk aversion parameter and $\theta (P A \alpha S \sigma_i)$ is the risk premium. Note that farmers are assumed to choose the same variety for the whole surface of land they use. Allocation of different plots of land to different varieties is not considered. A reason for this may be, for instance, that such a mix implies too high organisational costs. In order to analyse the optimal choice of variety, it is more specifically convenient to rewrite the risk adjusted profit level in the following form

$$\pi_i = S (A P \alpha (\mu_i - \theta \sigma_i) - \delta_i) \tag{3.4}$$

Thereafter, varieties are indexed according to their rank once sorted according to the mean value of the random component ϵ_i in the production function, corrected to take account of risk aversion (i.e. $i > j \Leftrightarrow \mu_i - \theta \sigma_i > \mu_j - \theta \sigma_j$).

The demand system

It is assumed that there are two kinds of seeds. The first type is variety $i = 0$ referred to as the landrace variety, i.e. a variety that has been used since long ago and generates

the lowest per unit of seed expected value of production with the highest risk (i.e. $\mu_0 < \mu_i \forall i > 0$ and $\sigma_0 \geq \sigma_i \forall i > 0$). The second type of seeds gathers all other varieties and is referred to as the "breeder" type. Varieties of the "breeder" type have to pass an uniformity and stability test that aims to provide a guarantee that production will not vary due to heterogeneity among seeds of a same variety. For these varieties, the risk affecting production is thus limited to meteorological conditions and is thus assumed to be of the same magnitude for all of them (i.e. $\sigma_i = \sigma \forall i > 0$). As a result, "breeders" varieties are differentiated only in terms of their value of μ_i that may be thought of as a quality parameter. Farmers are heterogeneous in terms of the productivity of their land measured by parameter A . Under these additional assumptions, the optimal choice of variety for farmers is formally identical to the optimal choice of quality by consumers in example 4 of Prescott and Visscher (1977). More specifically, the linear utility function of consumers with a heterogeneous marginal rate of substitution is replaced by the risk adjusted profit level which is linear with respect to parameter A that captures heterogeneity among farmers. Farmers prefer variety i to variety j if and only if $\pi_i > \pi_j$. This inequality yields

$$\begin{aligned} A &> \frac{\delta_i - \delta_j}{P \alpha ((\mu_i - \theta \sigma_i) - (\mu_j - \theta \sigma_j))} && \text{if } i > j \\ A &< \frac{\delta_i - \delta_j}{P \alpha ((\mu_i - \theta \sigma_i) - (\mu_j - \theta \sigma_j))} && \text{if } i < j \end{aligned} \quad (3.5)$$

Farmers who choose variety i among a set $\{0, \dots, I\}$ of varieties of a same crop are thus farmers with a productivity parameter A of land that satisfies

$$\begin{aligned} \frac{\delta_0}{P \alpha \eta_0} &< A < \frac{\delta_1 - \delta_0}{P \alpha (\eta_1 - \eta_0)} && \text{for } i = 0 \\ \frac{\delta_i - \delta_{i-1}}{P \alpha (\eta_i - \eta_{i-1})} &< A < \frac{\delta_{i+1} - \delta_i}{P \alpha (\eta_{i+1} - \eta_i)} && \text{for } 0 < i < N \\ \frac{\delta_i - \delta_{i-1}}{P \alpha (\eta_i - \eta_{i-1})} &< A && \text{for } i = N \end{aligned} \quad (3.6)$$

with $\eta_i = \mu_i - \theta \sigma_i$ and $\eta_j = \mu_j - \theta \sigma_j$. The left hand side threshold for $i = 0$ follows the condition that farmers decide to grow variety $i = 0$ of the crop if and only if they make a positive risk adjusted profit with that variety. If this condition of a positive risk adjusted profit is satisfied for $i = 0$ then it is also satisfied when farmers prefer

a variety $i > 0$ because this choice implies that they reach a higher level of their risk adjusted profit.

For the problem to make sense, it is expected that the minimum costs δ_i ($i \in \{0, \dots, I\}$) per unit of seed are consistent with a positive demand for each variety. Therefore, we assume that $A_{\max} > (\delta_N - \delta_{N-1}) / (P \alpha (\eta_N - \eta_{N-1}))$ (i.e. there is a positive demand for variety $i = N$) and that $A_{\min} < (\delta_1 - \delta_0) / (P \alpha (\eta_1 - \eta_0))$ (i.e. there is a positive demand for variety $i = 0$). We also introduce the simplifying assumption that production is profitable for all farmers. For this purpose, assumption $A_{\min} > \delta_0 / (P \alpha \eta_0)$ is added. It guaranties that farmers with the lowest productivity can make profits at least by choosing variety $i = 0$. Farmers may also be heterogeneous as regards the surface of land they use but their distribution in terms of acreage L (and thus of S) is supposed to be independent of their distribution in terms of productivity A . Given these assumptions and given the fact that $\delta_i = w_i + w_z \alpha / \gamma$ for all varieties, the demand system for the different varieties may be expressed in terms of their prices w_i ($i \in \{0, \dots, I\}$) as follows

$$q_i = \begin{cases} \bar{q} \left(\frac{w_1 - w_0}{P \alpha (\eta_1 - \eta_0)} - A_{\min} \right) & \text{for } i = 0 \\ \bar{q} \left(\frac{w_{i+1} - w_i}{P \alpha (\eta_{i+1} - \eta_i)} - \frac{w_i - w_{i-1}}{P \alpha (\eta_i - \eta_{i-1})} \right) & \text{for } 0 < i < N \\ \bar{q} \left(A_{\max} - \frac{w_i - w_{i-1}}{P \alpha (\eta_i - \eta_{i-1})} \right) & \text{for } i = N \end{cases} \quad (3.7)$$

with $\bar{q} = M \bar{L} \frac{\beta}{\alpha} / A_{\max} - A_{\min}$ where M is the number of farmers and \bar{L} the average surface they use³. $M \bar{L} \frac{1}{\alpha}$ is a measure of market size for seeds.

Minimum standards versus registration in a catalogue

Landraces play a key role in the analysis. They constitute a low quality but cheap alternative to varieties created by breeders. In the model, they may correspond to either ancient varieties that have never been protected by IPRs or to varieties created by breeders but are no longer protected by IPRs due to voluntary lapse or because the legal maximum lifespan of the protecting IPR has been reached. Due to the absence

3. The way the average surface appears in the demand system directly follows on from the simplifying assumption that the distribution of surface and the distribution of productivity are independent.

of protecting IPRs, anyone can breed and reproduced them. Therefore, landraces are priced at their marginal cost of reproduction. By contrast, breeders take advantage of the legal protection conferred by IPRs to exert a market power on the varieties of seeds they sell. Moreover, the marginal cost of reproducing breeders' varieties is assumed to be higher or equal to that of landraces because uniformity and stability of seeds has to be guaranteed. As a result, breeders varieties are necessarily sold at a higher price than landraces. Nevertheless, as will be shown latter in the paper, the magnitude of the difference in prices crucially depends on the commercialisation rules that applies on the market for seeds. Indeed, in order to remedy to information asymmetries about the quality of seeds, two kind of commercialisation rules are typically used: minimum standards or a catalogue.

Minimum standards just require to inform farmers about what kind of seeds they buy. Registration in the catalogue requires to pass the DUS and VCU tests. Landrace seeds can succeed in passing these tests only at an additional unit cost. In counterpart, if they meet these criteria, the uncertainty surrounding the performance of landrace seeds is lowered to the same level than the one characterising seeds of the breeders varieties. In the model, we thus assimilate minimum standards to a situation where $c_i \geq c_0 \forall i > 0$ and $\sigma_0 > \sigma_i \forall i > 0$. By contrast, registration in a catalogue is assimilated to a situation where $c_i = c_0 \forall i > 0$ and $\sigma_0 = \sigma_i \forall i > 0$. The structure (3.7) of the demand system for seeds suggests that the choice of commercialisation rule impacts the demand for breeders' varieties and thus affects the whole market of seeds. Opponents to a compulsory registration in a catalogue for landraces typically argue that such a commercialisation rule narrows the market share of landraces compared to minimum standards and is thus detrimental to biodiversity. A comprehensive approach of the problem then requires to introduce biodiversity and its feedback effect in the model.

Endogeneous biodiversity

In order to tackle with the endogeneity of biodiversity and with its positive external effects, it is assumed that the productivity parameter A introduced in the production

function (3.1) linearly depends on a measure *bio* of biodiversity:

$$A = \bar{A} + \lambda \textit{bio} \tag{3.8}$$

where \bar{A} is an heterogeneous component that varies from one farmer to an other one and λ is a constant parameter. \bar{A} reflects the minimum productivity level that would be obtained in the absence of biodiversity and $\lambda \textit{bio}$ is the part of productivity to be attributed to biodiversity. We assume that \bar{A} is uniformly distributed on the interval $[\bar{A}_{\min}, \bar{A}_{\max}]$ so that A is also uniformly distributed on an interval $[A_{\min}, A_{\max}]$ with $A_{\min} = \bar{A}_{\min} + \lambda \textit{bio}$ and $A_{\max} = \bar{A}_{\max} + \lambda \textit{bio}$. A direct and convenient consequence of this specification is that the derivation of the demand system and market equilibrium for a given level *bio* of biodiversity is similar to that presented in the previous section. Most of the usual biodiversity measures that can be used for *bio* depend on the number of varieties and possibly on the quantity of each variety that is effectively grown. The level of biodiversity and market shares at equilibrium are then determined simultaneously and *bio* has to be found as a fixed point of the model. Unfortunately the demand system and equilibrium prices conditional on the level of *bio* are highly nonlinear with respect to this biodiversity measure so that we will not be able to find the corresponding fixed point analytically and we will have to rely on numerical simulations. The problem is compounded by the fact that commonly used measures of biodiversity are themselves highly nonlinear expressions of the quantities of crops of the different varieties.

A first and simple way to measure biodiversity is to count the number N of varieties effectively grown at a given period of time. Note that for a variety to be taken into account it is required that it is not only supplied but also effectively bought and grown by farmers. Put another way, N is not the total number of varieties listed in a catalogue but the total number of varieties effectively found in fields (Baumgärtner, 2006). Even this simple measurement of biodiversity is endogenous to market equilibrium in a dynamic setting. Indeed, breeders decide to invest in R&D and to create a new variety or not. Their decision to create a new variety affects biodiversity which, in turn, affects the demand system and the return on R&D investment.

A second way to capture biodiversity is to use an index that depends on the proportion of the different varieties that are grown by farmers. The Simpson index of diversity is chosen for two reasons. Firstly, it is quite similar to the Herfindahl and Hirschmann Index (HHI), commonly used in industrial economics to measure market concentration. Given that the current article deals simultaneously with market concentration and market power on the one hand, and biodiversity on the other hand, it is worth using a common measure of concentration *versus* diversity that makes sense for both aspects of the problem. Secondly, from a purely computational point of view, the quadratic form of the Simpson index is more convenient for the numerical search of a fixed point than alternative measures of biodiversity like, for instance, entropy and the Pielou index. According to the Simpson index, biodiversity is measured as

$$bio = 1 - \sum_{i=0}^N g_i^2 \tag{3.9}$$

where g_i is the share of variety i in the total quantity of seeds bought⁴. As defined in (3.9), bio reflects the probability that two randomly selected units of land are cultivated with the same variety. bio goes to zero when biodiversity decreases and is bounded by one as biodiversity is very high, which is consistent with the way biodiversity is assumed to affect the production function (3.1) through the productivity parameter defined in (3.8).

3.2.2 The supply side of the market

The behaviour of breeders is crucially influenced by the type of IPRs that prevails for plant varieties and that shapes the structure of the seed market. We consider successively the supply side of the market for seeds under a patent system and under a PBRs system. In both cases, we start with a characterization of profit flows in a static framework and we then present a two periods and two breeders dynamic game for the decision to invest in R&D and to develop new varieties. We more specifically focus

4. Due to the perfect complementarity between seeds and land, this is also the share of total land allocated to variety i .

on the distinction between radical invention, associated with the obtention of a first variety protected by an IPR at the first period, and incremental invention associated with the obtention of a second variety derived from the first one at the second period.

The supply side under a patent system

For ease of presentation, we start with the case of a patent system to protect plant varieties. As already mentioned, varieties of the "breeder" type are ranked according to the increasing value of the quality parameter $\eta_i = \mu_i - \theta\sigma_i$. The implicit assumption is that the development of "breeder" type varieties begins with variety $i = 1$ and proceeds variety by variety from i to $i+1$ up to variety $i = N$ characterised by the highest quality level. In this sense, varieties $i > 1$ are incremental inventions developed from the initial invention $i = 1$. Since patents convey an exclusivity right on all incremental inventions that may be derived from an initial invention, we consider that the inventor of variety $i = 1$ is *de facto* the patent holder of all subsequent varieties and has a monopolistic position on all these other varieties⁵. For a given number N of developed varieties at a given period of time, the objective of the patent holder is thus to maximise the flow of joint profits that accrues from supplying all or part of the N varieties:

$$\text{Max}_{\{w_i, \dots, w_N\}} \sum_{i=1}^N (w_i - c_i)q_i \text{ subject to } q_i \geq 0 \forall i \in \{i, \dots, N\} \quad (3.10)$$

where c_i stands for the constant unit cost of producing seeds for variety i and q_i is defined by (3.7). It is expected that, depending on the magnitude of the increase in c_i that is required for a given improvement in η_i , it is optimal for the patent holder to either supply all varieties or to supply only part of them (and more specifically only the highest quality). This point is further examined in Appendix A for the simple case where there is no feedback of biodiversity on the productivity parameter A (i.e. $\lambda = 0$ in 3.8). Furthermore, in keeping with the assumption of no feedback of the biodiversity, the Appendix B analyses theoretically the impact of a switch from minimum standards

5. If the production of incremental varieties is licensed to other firms then the inventor of the initial variety is assumed to extract the rent of the licensee so that she formally behaves as if she was in a monopolistic position.

to the catalogue as commercialisation rules. For now, let v_N^{mon} denote the resulting optimal joint profit flow when up to N varieties have been derived from variety $i = 1$. By convention, v_1^{mon} denotes the optimal profit when the only variety available is variety $i = 1$.

With the aim to analyse the impact of patents *versus* PBRs on both radical innovation and incremental innovation, we focus on a two periods dynamic framework with two breeders initially competing for the monopolistic position conferred by the patent. In order to be able to commercialize a new variety, breeders have to invest and incur a sunk cost of R&D that amounts to FC . Due to its uncertain outcome, investing in R&D is a necessary but not sufficient condition to develop a new variety. The intrinsic randomness of the R&D process is captured by a probability Λ that the R&D process effectively leads to the obtention of the new variety. When the two breeders are successful in their R&D process, a lottery affects the patent to only one of them with equal probability. Breeders are assumed to have full information about the state of demand so that there is no option value of delaying the R&D investment. At each date, each breeder has to decide whether to invest in R&D in order to obtain a new variety or not. The subgame perfect Nash equilibrium of the finite dynamic game is solved by backward induction. Multiple equilibria in pure strategies may arise at one of the two periods or at both periods. They typically correspond to situations where only one of the two breeders invests but there is indeterminacy about which one invests (ascendant diagonal of the payoff matrix). We address this problem by using the concept of mixed strategies rather than pure strategy. In our context, mixed strategies may be thought of as a way for breeders to tackle with the eventuality of facing the same competitor on markets for the seeds of other plants and the risk of being considered, for instance, as the one who let competitors invest when there is room for only one breeder. Tables 3.1, 3.2, 3.3 display the payoff matrices A B and C of the game respectively at period $t = 2$ if the variety $i = 1$ has been obtained at $t = 1$ (and thus $N = 1$ at the beginning of period $t = 2$), at period $t = 2$ if the variety $t = 1$ has not been obtained at $t = 1$ (i.e. $N = 0$ at the beginning of period $t = 2$), and finally at $t = 1$. Cells in these tables

are numbered from top to bottom and from left to right. Payoffs are denoted by X_s^j where $X = A$ or B or C with a superscript $j \in \{1, 2, 3, 4\}$ that refers to the cell in the relevant table and a subscript $s \in \{r, c\}$ that specifies whether we consider the player in row or in column.

There is no strategic consideration in Table 3.1 because the patent confers the exclusivity on all varieties $i > 1$ derived from variety $i = 1$. The only risk that the patent holder is facing is a risk of failure of the R&D process that aims at obtaining variety $i = 2$ if the breeder engages in such a program. Nevertheless, we use the presentation of a payoff matrix for A in order to ease the comparison with the payoff matrix \bar{A} in the case of a PBRs system. If the patent holder succeeds in developing variety $i = 2$, profits from sells amount to v_2^{mon} instead of the profit flow v_1^{mon} received in case of failure or if there is no investment at all. By contrast, there is a strategic choice in Table 3.2 because no patent has yet been granted at period $t = 2$ in the case considered in matrix B . Firms then compete for v_1^{mon} at period $t = 2$. There is a risk of failure of their R&D program if they decide to invest, and a additional risk of not being granted the patent if both firms invest and are successful in obtaining variety $i = 1$. The combination of these two risks also shapes the payoffs in matrix C . The difference between matrix C and matrix B is that failure to obtain variety $i = 1$ at $t = 1$ (either because of a failure of R&D programs or due to the absence of R&D) yields the equilibrium expected payoff of matrix B (denoted B^*), discounted at the rate ρ .

Table 3.1: Matrix A

$t = 2 \ N = 1$		Breeder c with IPR	
		Invest	Does not invest
Breeder r without IPR	Invest	$A_c^1 = \emptyset$ $A_r^1 = \emptyset$	$A_c^2 = \emptyset$ $A_r^2 = \emptyset$
	Does not invest	$A_c^3 = (1 - \Lambda)v_1^{mon} + \Lambda v_2^{mon} - FC$ $A_r^3 = 0$	$A_c^4 = v_1^{mon}$ $A_r^4 = 0$

Table 3.2: Matrix B

$t = 2 \quad N = 0$		Breeder c without IPR	
		Invest	Does not invest
Breeder r without IPR	Invest	$B_c^1 = (\Lambda(1 - \Lambda) + \frac{\Lambda^2}{2})v_1^{mon} - FC$ $B_r^1 = B_c^1$	$B_c^2 = 0$ $B_r^2 = \Lambda v_1^{mon} - FC$
	Does not invest	$B_c^3 = B_r^2$ $B_r^3 = 0$	$B_c^4 = 0$ $B_r^4 = 0$

 Table 3.3: Matrix C

$t = 1 \quad N = 0$		Breeder c without IPR	
		Invest	Does not invest
Breeder r without IPR	Invest	$C_c^1 =$ $(\Lambda(1 - \Lambda) + \frac{\Lambda^2}{2})(v_1^{mon} + \frac{A_c^*}{1+\rho})$ $+((1 - \Lambda)\Lambda + \frac{\Lambda^2}{2})(\frac{A_r^*}{1+\rho})$ $+(1 - \Lambda)^2 \frac{B_c^*}{1+\rho} - FC$ $C_r^1 = C_c^1$	$C_c^2 =$ $\Lambda \frac{A_r^*}{1+\rho}$ $+(1 - \Lambda) \frac{B_c^*}{1+\rho}$ $C_r^2 = C_c^3$
	Does not invest	$C_c^3 =$ $\Lambda(v_1^{mon} + \frac{A_c^*}{1+\rho})$ $+(1 - \Lambda) \frac{B_c^*}{1+\rho} - FC$ $C_r^3 = C_c^2$	$C_c^4 =$ $\frac{B_c^*}{1+\rho}$ $C_r^4 = C_c^4$

The supply side under a PBRs system

Like a patent, a Plant Breeder Right entitles its owner exclusivity on the commercialization of the protected plant. Nevertheless, unlike a patent, a PBR is subject to research exemption. Research exemption enables a breeder to freely develop a new variety from a variety obtained by a competitor and protected by a PBR. Said another way, a PBR confers exclusivity on the protected variety but not on subsequent varieties that can be derived from the initial variety. As a result, the reference market structure

for seeds is rather oligopolistic than monopolistic. Of course, it may happen that a same breeder creates several varieties from an initial one, an eventuality that we take into account in the dynamic framework. For now, we focus on pricing in the context of several breeders, each one supplying a different variety. In an oligopolistic framework where each variety is supplied by a different breeder, prices are obtained as the outcome of a Bertand Nash game in prices. When up to N varieties have been derived from variety $i = 1$, the objective of each breeder i is to maximise her own profit flow that accrues from supplying variety $i \in \{1, \dots, N\}$ given prices of all other varieties:

$$\underset{w_i}{\text{Max}}(w_i - c_i)q_i \text{ subject to } q_i \geq 0 \tag{3.11}$$

Under the assumption that there is no feedback of the biodiversity, several theoretical results can be found, there are presented in Appendix C. Moreover, the theoretical results shown in Appendix A and Appendix C allow to elaborate a comparative static analysis of pricing between a patent regime and a PBR regime in Appendix D.

Table 3.4: Matrix \bar{A}

$t = 2 \ N = 1$		Breeder c with IPR	
		Invest	Does not invest
Breeder r without IPR	Invest	$\bar{A}_c^1 =$ $(\Lambda(1 - \Lambda) + \frac{\Lambda^2}{2})v_2^{mon}$ $+((1 - \Lambda)\Lambda + \frac{\Lambda^2}{2})v_{1/2}^{oli}$ $+(1 - \Lambda)^2v_1^{mon} - FC$ $\bar{A}_r^1 = (\Lambda(1 - \Lambda) + \frac{\Lambda^2}{2})v_{2/2}^{oli} - FC$	$\bar{A}_c^2 =$ $(1 - \Lambda)v_1^{mon}$ $+\Lambda v_{1/2}^{oli}$ $\bar{A}_r^2 = \Lambda v_{2/2}^{oli} - FC$
	Does not invest	$\bar{A}_c^3 = (1 - \Lambda)v_1^{mon} + \Lambda v_2^{mon} - FC$ $\bar{A}_r^3 = 0$	$\bar{A}_c^4 = v_1^{mon}$ $\bar{A}_r^4 = 0$

The maximized profit flow that results from this program is denoted $v_{i/N}^{oli}$. Like in the case of a patent system, we thereafter focus on a two periods context where $i = 1$ refers to the radical innovation whereas $i = 2$ refers to the incremental innovation. The

resolution of the dynamic R&D investment problem proceeds backwards. Tables 3.4 and 3.5 display the payoff matrices \bar{A} and \bar{C} that parallels matrices A and C from the dynamic game with a patent system. Note that the payoff matrix \bar{B} that would prevail at period $t = 2$ with $N = 0$ is not displayed because it is strictly similar to the payoff matrix B given in Table 3.2. Strategic consideration matters at period $t = 2$ even if one of the two breeders has been granted a PBR for variety $i = 1$ at $t = 1$. Indeed, the grant of a PBR on variety $i = 1$ does not preclude the challenger of the PBR holder to obtain and commercialize variety $i = 2$ at period $t = 2$. The grant of the PBR only generates an asymmetry between the patent holder (in column) and its challenger (in row) in the payoff matrix \bar{A} . If both players choose to invest in a R&D program at period $t = 2$, the patent holder competes for extending her monopolistic position from $N = 1$ to $N = 2$, whereas her competitor competes for entering in a duopoly position by supplying the highest quality seeds (those of variety $i = 2$). The payoff matrix \bar{C} is structurally similar to the payoff matrix C except the reference to the discounted and expected equilibrium payoffs \bar{A}^* and \bar{B}^* for the second period.

 Table 3.5: Matrix \bar{C}

$t = 1 \ N = 0$		Breeder c without IPR	
		Invest	Does not invest
Breeder r without IPR	Invest	$\bar{C}_c^1 =$ $(\Lambda(1 - \Lambda) + \frac{\Lambda^2}{2})(v_1^{mon} + \frac{\bar{A}_c^*}{1+\rho})$ $+((1 - \Lambda)\Lambda + \frac{\Lambda^2}{2})(\frac{\bar{A}_r^*}{1+\rho})$ $+(1 - \Lambda)^2 \frac{\bar{B}_c^*}{1+\rho} - FC$ $\bar{C}_r^1 = \bar{C}_c^1$	$\bar{C}_c^2 =$ $\Lambda \frac{\bar{A}_r^*}{1+\rho}$ $+(1 - \Lambda) \frac{\bar{B}_c^*}{1+\rho}$ $\bar{C}_r^2 = \bar{C}_c^3$
	Does not invest	$\bar{C}_c^3 =$ $\Lambda(v_1^{mon} + \frac{\bar{A}_c^*}{1+\rho})$ $+(1 - \Lambda) \frac{\bar{B}_c^*}{1+\rho} - FC$ $\bar{C}_r^3 = \bar{C}_c^2$	$\bar{C}_c^4 =$ $\frac{\bar{B}_c^*}{1+\rho}$ $\bar{C}_r^4 = \bar{C}_c^4$

3.2.3 The program of the regulator

The aim of the regulator is to determine the optimal combination of IPRs rule and commercialization rule that maximizes the expected and discounted sum of profits of breeders and farmers, conditionally on the optimal decisions of breeders to invest or not to invest in R&D (i.e. conditionally on the equilibrium probabilities of investing that characterize the optimal mixed strategies). Farmers are directly affected by the type of commercialization rule. Indeed, we already have stressed that the type of commercialization rule chosen by the regulator influences the pricing of seeds for landraces. Breeders are indirectly affected because the price of seeds for landraces influences the demand system and, as a consequence, their own pricing. As shown by the previous development on R&D investment, breeders are directly affected by the choice of IPRs. Farmers are also affected by this choice, although it is indirectly and by two different means. First, the type of IPRs modifies the probability of obtaining higher quality varieties. Second, the type of IPRs that prevails for plant variety creation affects the structure of the seeds market. Therefore, the choice of IPRs and commercialization rules are intrinsically linked and cannot be made independently by the regulator.

In order to write the total welfare that the regulator attempts to maximize, we start by characterizing the total profit flow of farmers conditional on the varieties available at the date under consideration. By combining (3.6) and the assumption of a continuous and uniform distribution of the productivity parameter A specified in (3.8), the total profit flow of farmers if varieties $i = 1$ and $i = 2$ are available (i.e. if $N = 2$) is given by

$$\pi_{N=2}^{tot} = \frac{1}{\bar{A}_{\max} - \bar{A}_{\min}} \left(\int_{\bar{A}_{\min} + \lambda^{bio}}^{A_0^1} \pi_0(A) dA + \int_{A_0^1}^{A_1^2} \pi_1(A) dA + \int_{A_1^2}^{\bar{A}_{\max} + \lambda^{bio}} \pi_2(A) dA \right) \tag{3.12}$$

where $\pi_i(A)$ is the risk adjusted profit flow of farmers buying variety i and defined in (3.4). A_{i-1}^i denotes the threshold value $\frac{w_i - w_{i-1}}{P\alpha(\eta_i - \eta_{i-1})}$ of the productivity parameter A above which a farmer prefers variety i to variety $i - 1$. The total profit flow $\pi_{N=1}^{tot}$ of farmers if variety $i = 1$ is available but not variety $i = 2$ (i.e. $N = 1$) is similar except

that the last term inside the brackets vanishes and A_1^2 is replaced by $\bar{A}_{\max} + \lambda \text{ bio}$. When neither variety $i = 1$ nor variety $i = 2$ are available, the total profit flow $\pi_{N=0}^{\text{tot}}$ is given by (3.12) with only the first term inside the brackets and $\bar{A}_{\max} + \lambda \text{ bio}$ in place of A_0^1 . The total profit flows $\pi_{N=2}^{\text{tot}}$ and $\pi_{N=1}^{\text{tot}}$ are sensitive to the type of IPRs in force because this type affects the structure of the market of seeds supplied by the breeders and, consequently, the pricing of varieties $i = 1$ and $i = 2$. By essence, the total profit flow $\pi_{N=0}^{\text{tot}}$ is insensitive to the type of IPRs in force. Finally, the three expressions are affected by the type of commercialization rule which directly influences the price of landraces (and thus $\pi_0(A)$) which in turn has an direct effect on the prices of varieties $i = 1$ and $i = 2$ that are part of $\pi_1(A)$ and $\pi_2(A)$ but also part of A_0^1 and A_1^2 .

As already mentioned, the choice of IPRs and commercialization rules also modifies the equilibrium mixed strategies of the dynamic investment game. If we let $\theta_{C_c^*}$ and $\theta_{C_r^*}$ denote the equilibrium probabilities of investing for respectively the breeder in column and the breeder in row associated with the payoff matrix C of the investment game at period $t = 1$ under a patent regime, then the expected and discounted total welfare associated with the subgame perfect Nash equilibrium may be written as

$$\begin{aligned}
 W_C = & \theta_{C_c^*} \theta_{C_r^*} \left(C_c^1 + C_r^1 + (1 - \Lambda)^2 \left(\pi_{N=0}^{\text{tot}} + \frac{W_B}{1 + \rho} \right) + (2\Lambda(1 - \Lambda) + \Lambda^2) \left(\pi_{N=1}^{\text{tot}} + \frac{W_A}{1 + \rho} \right) \right) \\
 & \theta_{C_c^*} (1 - \theta_{C_r^*}) \left(C_c^2 + C_r^2 + (1 - \Lambda) \left(\pi_{N=0}^{\text{tot}} + \frac{W_B}{1 + \rho} \right) + \Lambda \left(\pi_{N=1}^{\text{tot}} + \frac{W_A}{1 + \rho} \right) \right) \\
 & (1 - \theta_{C_c^*}) \theta_{C_r^*} \left(C_c^3 + C_r^3 + (1 - \Lambda) \left(\pi_{N=0}^{\text{tot}} + \frac{W_B}{1 + \rho} \right) + \Lambda \left(\pi_{N=1}^{\text{tot}} + \frac{W_A}{1 + \rho} \right) \right) \\
 & + (1 - \theta_{C_c^*}) (1 - \theta_{C_r^*}) \left(C_c^4 + C_r^4 + \left(\pi_{N=0}^{\text{tot}} + \frac{W_B}{1 + \rho} \right) \right) \tag{3.13}
 \end{aligned}$$

Each line in (3.13) is associated with a cell of the payoff matrix C and its probability of occurrence is the product of probabilities for the strategies of the two players. The term C_s^j (with $j \in \{1, 2, 3, 4\}$ and $s \in \{r, c\}$) refers to the payoff in cell j for the player s . Depending on the success of at least one R&D program, the total profit flow for farmers on each line is either $\pi_{N=1}^{\text{tot}}$ or $\pi_{N=0}^{\text{tot}}$. The welfare is written in a recursive

form. Therefore, the discounted welfare W_A (in case of success of at least one R&D program) and W_B (if none of the two breeders invests or none of them is successful in her R&D program) appear on each line of (3.13). Their expressions are similar to that of (3.13) except that the terms C_s^j are replaced by the terms A_s^j and B_s^j respectively, the equilibrium probabilities $\theta_{C_c^*}$ and $\theta_{C_r^*}$ are $\theta_{A_c^*}$ and $\theta_{A_r^*}$ for W_A and $\theta_{B_c^*}$ and $\theta_{B_r^*}$ for W_B , and there is no further value of welfare to discount (no terms similar to $\frac{W_A}{1+\rho}$ and $\frac{W_B}{1+\rho}$). Similar expressions of the welfare can be derived if the intellectual property system relies on PBRs. Finally, one has to keep in mind that each expression of welfare is also affected by the choice of commercialization rule.

3.3 Simulation results

The complexity of optimally matching an IPRs regime and a commercialisation rule for seeds, with the aim to induce strong enough incentives for breeders to engage in a R&D process while refraining them from exercising a too high market power, makes the choice of the public regulator difficult, if not impossible, to solve analytically. Therefore, this section turns to numerical simulations. It has to be thought of as an attempt to highlight whether one or several combinations of IPRs regime and commercialisation rule are likely to be preferred to the others. For this purpose, the calibration of the model on the case of wheat in France is first detailed. Static results as regards pricing and welfare are then considered. The dynamic R&D game is finally presented and the optimal choice of the regulator is discussed.

3.3.1 Model calibration

The calibration of the model enables us to find a fixed point for the market shares given the biodiversity feedback effect on productivity. Parameters' numerical values are shown in Table 3.6, they all correspond to the case of wheat in France. They were worked out using data from *Groupement National Interprofessionnel des Semences* (GNIS), from the *Farm Accountancy Data Network* (FADN) and from *Banque*

de France. The FADN provides average data on the agricultural sector of the European Union, and the GNIS provides data on the seeds sector. Note that, in addition, the GNIS performs tests to certify seeds.

Table 3.6: Parameters

P	19€/q	μ_0	1
L	14.42	μ_1	1.04
M	356,070	μ_2	1.08
c_0^s (<i>minimum standards</i>)	11.25€/q	σ (<i>minimum standards</i>)	0.2
c_0^c (<i>catalogue</i>)	40.56€/q	σ_i	0.18
c_i	49.85€/q	λ	13
A_{min}	$20 + \lambda bio$	$c_z * \alpha / \gamma$	722
A_{max}	$110 + \lambda bio$	θ	0.25

In order to compute the first (constant) part of A_{min} and A_{max} we use data from the FADN on differences of yields for wheat across different populations of farmers. Parameter λ , which captures the feedback of biodiversity on productivity, was set to a value that makes the impact of biodiversity significant. Indeed, under the assumption of a continuous uniform distribution for parameter A , the feedback effect of biodiversity amounts to about 20% of the global productivity for the median farmer in our simulation results. Data for the production cost c_0^s per unit of landrace seeds under minimum standards, for the production cost c_0^c per unit of landrace seeds under a catalogue rule for commercialization and for the production cost c_i per unit of certified seeds were collected from the GNIS. On the basis of information provided by experts from the *Institut National de la Recherche Agronomique* (INRA), the unit cost c_i incurred to produce breeders varieties is assumed to be invariant with respect to the quality index $\eta_i = \mu_i - \theta \sigma_i$ of seeds. Consequently, the sequence of unit costs $\{c_i\}$ is not strictly convex with respect to the sequence $\{\eta_i\}$ of the quality index and, according to Appendix A, we conclude that a monopoly would prefer to supply only the higher quality of seeds if there was no feedback effect of biodiversity. Knowing that the cost of seeds represents

roughly six percent⁶ of the total production cost of farms, the cost $c_z * \alpha / \gamma$ of the other inputs per unit of production was evaluated to 722€/q. The mean μ_0 of the random term ϵ_0 is normalised to 1 and μ_i is worked out through the ratio of the amount of seeds required to sow one hectare with either landraces seeds or certified seeds, namely the ratio $\frac{1.4}{1.3} = 1.076$. Parameters σ_0 and σ_i were calibrated so as to obtain realistic prices for breeders varieties in our simulations. σ_i is lower than σ_0 because of the homogeneity and stability criteria. There are 356,070 farmers in France with an average acreage of 14.42 hectares of land allocated to wheat⁷. This information allows us to compute the product $L M$ that is part of the market size expression \bar{q} in the demand system (3.7). Finally, based on Brink and McCarl (1978) and Saha (1997), we set the risk aversion parameter θ to 0.25.

3.3.2 Numerical results for pricing

Prior presenting the results of numerical simulations for the pricing decision when $N = 2$, it is worth recalling the main policy options. Indeed, in addition to the choice between two commercialization rules, the regulator is also facing two options for the IPRs regime. The PBRs system is assumed to lead to an oligopoly with Bertrand-Nash equilibrium while the patent system gives a monopolistic position to only one breeder. Crossing the different possible choices generates four cases. Firstly, a "European case" with PBRs-catalogue rules. Indeed, patents on plants are not allowed in Europe and seeds have to be registered in an official catalogue to be commercialized. The symmetric case with patents and minimum standards is referred to as the "U.S. case" to reflect the fact that the United States are among the few countries which allow such a combination. The two other possibilities are a PBR-minimum standards case and a patent-catalogue case. These four cases somewhat simplifies the reality. A PBRs system and a patent system can for instance make together, like in the United States. They are intended to give an idea of the impact of regulation in the seed industry rather than to provide a

6. According to the FADN database.

7. The FADN only takes professional farmers into account, for more information visit <http://ec.europa.eu/agriculture/rica/>.

comprehensive modelling of this industry.

With only one breeder variety that competes with the landrace variety (i.e. with $N = 1$), results for the pricing under a PBRs system and under a Patent system are similar whatever the commercialisation rule used for seeds. Recall that the profit for suppliers of the landrace amounts to zero because this market segment constitutes a competitive fringe for the monopoly breeder that supplies variety 1 (see Table 3.7). Under a catalogue rule, the seed market splits into roughly 45% for the landrace seeds and 55% for the "breeder" seeds. In comparison, under a minimum standards rule, the breeder who sells the certified seeds supplies only 47% of the seeds demanded by farmers. The difference is due to a higher ratio between the price of the breeder variety and the price of the landrace variety under the minimum standards case (2.43584) compared to the catalogue rule (1.85774). Biodiversity, as measured by the Simpson index, is slightly higher under minimum standards than under the catalogue rule, but it seems that the result is highly sensitive to the values of parameters. Unsurprisingly, the price of seeds for the breeder variety and the profit of the breeder are higher under the catalogue rule than with minimum standards whereas the risk-adjusted profit of farmers is lower. The net effect produces a higher total flow of welfare under minimum standards.

With two breeder varieties (i.e. with $N = 2$), the four combinations of rules mentioned above may appear. In Table 3.8, the system of IPRs used for seeds corresponds to the column whereas rows refer to the different commercialization rules. With the oligopolistic market structure that is assumed to prevail under a PBRs system, the presence of the high quality certified variety ($i = 2$) induces a decrease of the price of the low quality certified variety ($i = 1$) compared to the case $N = 1$. The impact of the presence of variety $i = 2$ is even more drastic under a patent regime since the monopolistic breeder who has exclusivity on both certified varieties will choose to no longer supply variety $i = 1$. The price of the variety $i = 2$ is higher under the patent system than under the PBRs system, whatever the commercial rule that is in force.

Table 3.7: Results with one "breeder" seed

Varieties	Minimum standards		Catalogue	
	landrace	variety 1	landrace	variety 1
μ_i	1	1.04	1	1.04
w_i (€/quintal)	31.25	76.12	40.56	76.8
q_i (thousand)	3752	3435	3222	3966
π_i (million)	.	90	.	106.9
$A_{min}(bio)$	26.5		26.4	
$thresholdA_0^1$	73.5		66.7	
$A_{max}(bio)$	116.5		116.4	
$\pi_{farmers}$ (euros)	3727		3445	
$Welfare$ (bil- lion)	1.346		1334	
bio^a	0.499		0.494	

^a bio is the Simpson endogenous index of biodiversity

Comparing the "European" case with the "U.S." case, we notice that the "U.S." system is better for breeders who will have higher joint profits than in the context of European rules. Regarding farmers, the European system seems preferable because the conjunction of competition between breeders, that is allowed with the PBRs system, and sequential innovation, pushes prices down for variety 1. Nevertheless, the total welfare is lower in the European context because the higher risk adjusted profits for farmers do not counterbalance the lower profits of breeders. The Simpson biodiversity index is slightly higher in the "U.S." system in spite of the absence of variety $i = 1$. This result clearly emphasises that measuring biodiversity as a simple count of varieties grown by farmers may be misleading and that the concentration of market shares matters.

Looking at the four cases all together, the maximum profit that a breeder can earn is found in the patent-catalogue case thanks to higher prices whereas the PBR-standards situation is the best for farmers due to lower prices of the seeds of both breeder varieties and of the landrace variety (thanks to lower indirect commercialisation costs). As a consequence, the best situation for total welfare is found in the PBR-standards case. By contrast, the value of the Simpson biodiversity index is far from being the highest in

the PBR-standards case. This finding shows that although higher competition lowers market concentration, it does not systematically enhance biodiversity in spite of the strong link between the two concepts when biodiversity is measured by the Simpson index. Our simulations indicate that, in a static framework, strengthening competition thanks to PBRs in place of patents may lower the price of the highest quality of seeds more drastically than it does for other qualities of seeds, which induces a concentration of the market in favour of the two polar qualities (the highest quality of seeds and landrace seeds) but at the detriment of biodiversity. More generally, our simulation results stress that *ceteris paribus* (i.e. for unchanged commercialisation rules) PBRs do not promote biodiversity compared to a patent regime, at least in a static framework. Conversely, *ceteris paribus* (i.e. for an unchanged IPRs regime) minimum standards in place of a catalogue commercialisation rule are more efficient at promoting biodiversity. Nevertheless the story can substantially differ if we consider incentives to invest in R&D in a dynamic framework.

Table 3.8: Results with two "breeder" seeds

Varieties	Oligopoly+Catalogue ("European" case)				Monopoly+Catalogue			
	landrace	variety 1	variety 2	variety 2	landrace	variety 1	variety 1	variety 2
μ_i	1	1.04	1.08	1.08	1	1.04	1.04	1.08
w_i (€/quintal)	40.54	56.16	84.39	84.39	40.54	75.35	75.35	108.31
q_i (thousand)	249	1857	5082	5082	2888	0	0	4301
π_i (million)	.	12	176	176	.	0	0	251
$A_{min}(bio)$		25.6				26.2		
$thresholdA_0^1$		28.7				.		
$thresholdA_1^2$		52				62.4		
$A_{max}(bio)$		115.6				116.2		
$\pi_{farmers}$ (euros)		3789				3601		
$Welfare$ (billion)		1.536				1.534		
bio^a		0.432				0.481		
Seeds	Oligopoly+Standards				Monopoly+Standards ("U.S." case)			
	landrace	variety 1	variety 2	variety 2	landrace	variety 1	variety 1	variety 2
μ_i	1	1.04	1.08	1.08	1	1.04	1.04	1.08
w_i (€/quintal)	31.25	54.42	83.66	83.66	31.25	74.46	74.46	107.7
q_i (thousand)	942	1271	4974	4974	3183	0	0	4005
π_i (million)	.	6	168	168	.	0	0	232
$A_{min}(bio)$		26.1				26.4		
$thresholdA_0^1$		37.9				.		
$thresholdA_1^2$		53.9				66.3		
$A_{max}(bio)$		116.1				116.4		
$\pi_{farmers}$ (euros)		3966				3707		
$Welfare$ (billion)		1.586				1.552		
bio^a		0.473				0.493		

^a bio is the Simpson endogenous index of biodiversity

3.3.3 The optimal choice of the regulator

Figure 3.3.1 shows the optimal choice of regulator as defined in 3.2.3 on the basis of our calibrated model. Nevertheless, the calibration described in 3.3.1 focuses on the value of parameters that play a crucial role in pricing but says nothing about the value of parameters FC and Λ that characterize the innovation game. The sensitivity analysis of the optimal regulatory choice with respect to these two parameters is illustrated by Figure 3.3.1. We consider values of the probability Λ of success of the R&D program that range from 0 to 1 with steps of 0.05. As regards the sunk cost FC of R&D, we choose values that range from 0 to 150 with steps of 25. The upper value of FC was chosen in order to make investment in R&D almost never profitable, except for very high values of Λ .

Figure 3.3.1: Optimal choice of Regulator at $t = 1$

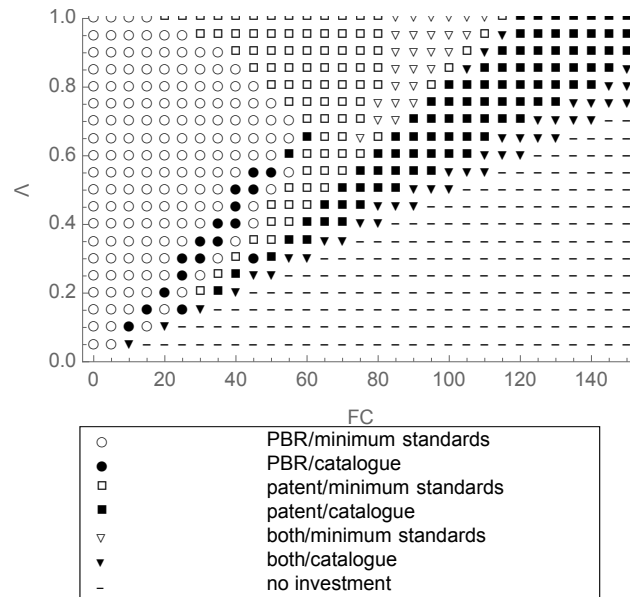

Figure 3.3.1 highlights that PBRs have to be preferred to patents for a cone of values of $\{FC, \Lambda\}$ which admits the Λ -axis as its base and which narrows as FC increases. For most values of $\{FC, \Lambda\}$ inside this cone, the optimal choice of the regulator consists in coupling PBRs with minimum standards. Coupling PBRs with a catalogue is optimal

only for a fringe of values of $\{FC, \Lambda\}$ on the lower part of the cone, though not just on its border. Indeed, close to the lower bound of the cone, there is a kind of instability in terms of the optimal choice of commercialisation rule. This instability follows on from the fact that a small change in parameters FC and/or Λ makes the situation switch from an innovation race between the two players at period $t = 2$ to a simple R&D investment decision by the holder of the PBR on variety $i = 1$, if any, without strategic interaction. Outside the cone, patents are either preferred to or just indifferent with PBRs from the regulator's point of view. Indifference occurs in two configurations. Firstly when under a PBRs regime only the holder of the PBR on variety $i = 1$ decides to invest in R&D at period $t = 2$ and thus the PBR makes no difference with a patent. Secondly, when investment at period $t = 2$ is unprofitable whatever the IPRs regime in force. Coupling patents with a catalogue is optimal when $\{FC, \Lambda\}$ is close to the diagonal under which no investment at all occurs at period $t = 1$. The range of values of $\{FC, \Lambda\}$ that lead to such an optimal coupling of patents with a catalogue is much more wider than the range of values that justify coupling PBRs with a catalogue. Roughly speaking, coupling patents with a catalogue is the optimal choice of the regulator when Λ is small compared to FC but high enough to justify investing in R&D at period $t = 1$ for at least one of the two players. For a higher ratio Λ/FC and high values of FC and/or of Λ , the regulator would better do coupling patents with minimum standards. By contrast, if the ratio Λ/FC is high but FC is low, the regulator's best choice is to combine minimum standards with PBRs.

A noticeable feature of Figure 3.3.1 is that the European choice of coupling PBRs with a catalogue is seldom obtained as the optimal choice of the regulator by our simulations. This is particularly striking given that the model is calibrated on data for France which is a major wheat producer in Europe. It is less obvious to conclude as regards the relevance of the American regulatory choice for three reasons. Firstly, the model is not calibrated on American data and this may bias the results. Secondly, in the U.S., commercialisation rules differ whether we consider the intrastate trade or the interstate trade of seeds, an eventuality that our model can not deal with. Last but

not least, in the U.S., breeders can choose between applying for a patent or applying for a PBR when they seek to protect their seeds. What we can examine is whether this flexibility introduced in the American IPRs regime could make sense for France according to our model. For this purpose, we first examine what would be the optimal choice of breeders if, at period $t = 1$, they were free to choose both the commercialisation rule and the IPRs regime but had to commit to this choice on period $t = 2$. We then turn to their optimal choice if they have flexibility in terms of the type of IPRs but not in terms if the commercialisation rule.

Figure 3.3.2: Optimal choice of Breeders at $t = 1$

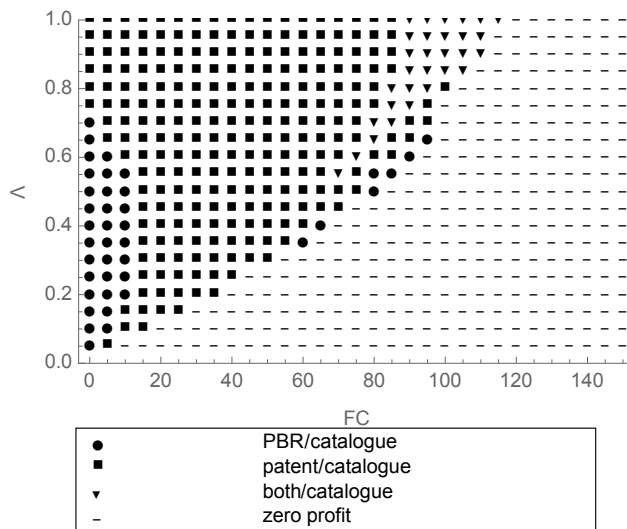
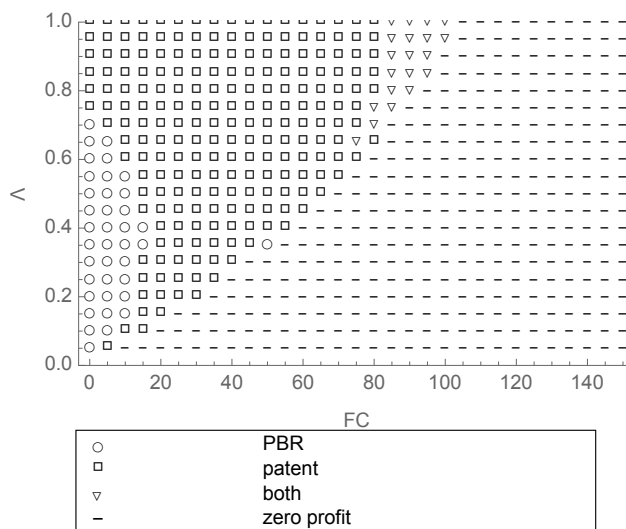

Figure 3.3.2 shows the optimal choice of breeders if they were free to choose both the commercialisation rule and the IPRs regime at period $t = 1$ but had to commit to this choice at period $t = 2$. With this kind of flexibility, breeders would always opt for a catalogue rather than for minimum standards but, more interestingly, for small values of FC and not too high values of Λ , they would opt for PBRs rather than patents. The rationale for such a choice is that, with small values of the sunk cost of R&D and a limited probability of success of R&D programs, breeders anticipate that it will be profitable to engage in a R&D program to obtain variety $i = 2$ at period $t = 2$, even if they do not hold the property right on variety $i = 1$. The limited probability of success

Figure 3.3.3: Optimal choice of Breeders at $t = 1$ when minimum standards are imposed



of R&D program guarantees some chance to be the only one to obtain variety $i = 2$ whereas a too high probability implies that both the incumbent and its challenger are likely to obtain the new variety. An interesting feature of this result is that, whenever breeders find it optimal to opt for a PBRs regime in this context, it is always consistent with the optimal choice of the regulator illustrated by Figure 3.3.1. In other to go one step further, we examine what would be the optimal choice of breeders if minimum standards were imposed by the regulator but the choice of the IPRs regime was let to breeders.

This latter case is illustrated by Figure 3.3.3. Again, for small values of FC and not too high values of Λ , breeders opt for PBRs and this choice is consistent with the optimal choice of the regulator. The cone of values of $\{FC, \Lambda\}$ that leads to a convergence between the interest of breeders and the interest of the regulator is even enlarged compared to Figure 3.3.2. This key result suggests that, rather than imposing the IPRs regime, the regulator should better do letting breeders choose between patents and PBRs.

3.4 Conclusion

The dynamic vertical differentiation model developed in this article to tackle with both the problem of asymmetric information and the problem of a lack of incentives to innovate on the seed market, in connection with the role of biodiversity as a public good subject to under-provision, suggests that the combination of IPRs regime and commercialisation rule that a public regulator may choose to maximise the expected and discounted total surplus crucially depends on the level of sunk R&D costs and on the probability of R&D success.

Numerical simulations obtained with a calibration of the model for wheat in France more or less confirm the intuitive idea that PBRs combined with minimum standards have to be preferred when sunk costs of R&D are low or medium and when the probability of R&D success is sufficiently high to justify investment in R&D programs. Otherwise, patents combined with minimum standards have to be preferred, except in some peculiar cases where patents may preferably be coupled with a catalogue. Although it is calibrated on French data, our model thus only weakly supports the coupling of PBRs with a catalogue that has been adopted in Europe. Our simulation results better support the solution adopted in the U.S., although the model is calibrated for France. More precisely, we highlight that imposing minimum standards but allowing for flexibility as regards the choice of the IPRs may substantially increase the chance that breeders choose a type of protection that is consistent with the regulator's will. This key result suggests a direction for further research. Indeed, assuming asymmetric information between the regulator and breeders as regards key parameters of the R&D investment game, contract theory could help better understanding why flexibility as to be preferred to fixing the IPRs regime.

3.5 Bibliography

Akerlof, G. The market for "lemons": Quality uncertainty and the market mechanism. *The quarterly journal of economics*, 84(3):488–500, 1970. doi:10.2307/1879431.

- Alston, J. and Venner, R. The effects of the us plant variety protection act on wheat genetic improvement. *Research Policy*, 31(4):527–542, 2002. doi:10.1016/S0048-7333(01)00123-8.
- Altieri, M. A. The ecological role of biodiversity in agroecosystems. *Agriculture, Ecosystems & Environment*, 74(1):19–31, 1999. doi:10.1016/S0167-8809(99)00028-6.
- Ambec, S., Langinier, C., and Lemarié, S. Incentives to reduce crop trait durability. *American Journal of Agricultural Economics*, 90(2):379, 2008. doi:10.1111/j.1467-8276.2007.01110.x.
- Baumgärtner, S. Measuring the diversity of what? and for what purpose? a conceptual comparison of ecological and economic biodiversity indices. Working Paper, 2006.
- Bessen, J. and Maskin, E. Sequential innovation, patents, and imitation. *The RAND Journal of Economics*, 40(4):611–635, 2009. doi:10.1111/j.1756-2171.2009.00081.x.
- Bresnahan, T. F. Competition and collusive in the american automobile industry : The 1955 price war. *The Journal of Industrial Economics*, 35(4):457–482, jun 1987. doi:10.2307/2098583.
- Brink, L. and McCarl, B. The tradeoff between expected return and risk among corn-belt farmers. *American Journal of Agricultural Economics*, 60(2):pp. 259–263, 1978. doi:10.2307/1240057.
- Carew, R. and Devadoss, S. Quantifying the contribution of plant breeders’ rights and transgenic varieties to canola yields: Evidence from manitoba. *Canadian Journal of Agricultural Economics/Revue canadienne d’agroeconomie*, 51(3):371–395, 2003. doi:10.1111/j.1744-7976.2003.tb00181.x.
- Diez, M. The impact of plant varieties rights on research: the case of spain. *Food Policy*, 27(2):171–183, 2002. doi:10.1016/S0306-9192(02)00010-6.

- Lence, S., Hayes, D., McCunn, A., Smith, S., and Niebur, W. Welfare impacts of intellectual property protection in the seed industry. *American Journal of Agricultural Economics*, 87(4):951–968, 2005. doi:10.1111/j.1467-8276.2005.00780.x.
- Lesser, W. Assessing the implications of intellectual property rights on plant and animal agriculture. *American Journal of Agricultural Economics*, 79(5):1584–1591, 1997. doi:10.2307/1244385.
- Lesser, W. Intellectual property rights and concentration in agricultural biotechnology. *AgBioForum*, 1(2):56–61, 1999.
- Lesser, W. An economic approach to identifying an effective sui generis system for plant variety protection under trips. *Agribusiness*, 16(1):96–114, 2000. URL <http://EconPapers.repec.org/RePEc:wly:agribz:v:16:y:2000:i:1:p:96-114>.
- Louwaars, N. P., Tripp, R., Eaton, D., Henson-Apollonio, V., Hu, R., Mendoza, M., Muhhuku, F., Pal, S., and Wekundah, J. Impacts of strengthened intellectual property rights regimes on the plant breeding industry in developing countries. Technical report, World Bank, 2005.
- Markowitz, H. Portfolio selection. *The journal of finance*, 7(1):77–91, 1952. doi:10.2307/2975974.
- Moschini, G. and Yerokhin, O. Patents, research exemption, and the incentive for sequential innovation. *Journal of Economics & Management Strategy*, 17(2):379–412, 2008. doi:10.1111/j.1530-9134.2008.00182.x.
- Nagaoka, S. and Aoki, R. An economic analysis of patent law exemption for research on a patented invention. Working Paper, 2009.
- O’Donoghue, T., Scotchmer, S., and Thisse, J. Patent breadth, patent life, and the pace of technological progress. *Journal of Economics & Management Strategy*, 7(1):1–32, 1998. doi:10.1111/j.1430-9134.1998.00001.x.

- Perrin, R. and Fulginiti, L. Pricing and welfare impacts of new crop traits: The role of iprs and coase conjecture revisited. *AgBioForum*, 11(2):134–144, 2008.
- Polasky, S. and al. The economics of biodiversity. In *Handbook of environmental Economics*, volume 3, chapter 29, pages 1517–1560. Elsevier, 2005. doi:10.1016/S1574-0099(05)03029-9.
- Prescott, E. C. and Visscher, M. Sequential location among firms with foresight. *Bell Journal of Economics*, 8(2):378–393, 1977. URL <http://www.jstor.org/stable/3003293>.
- Ramanna, A. *Farmers' Rights in India: A Case Study*. The Fridtjof Nansen Institute, 2006.
- Ramanna, A. and Smale, M. Rights and access to plant genetic resources under india's new law. *Development Policy Review*, 22(4):423–442, 2004. doi:10.1111/j.1467-7679.2004.00258.x.
- Saha, A. Risk preference estimation in the nonlinear mean standard deviation approach. *Economic Inquiry*, 35(4):770–782, 1997. doi:10.1111/j.1465-7295.1997.tb01963.x.
- Scotchmer, S. Standing on the shoulders of giants: cumulative research and the patent law. *The Journal of Economic Perspectives*, 5(1):29–41, 1991. doi:10.1257/jep.5.1.29.
- Scotchmer, S. *Innovation and incentives*. The MIT Press, 2004.
- Srinivasan, C. S. Exploring the feasibility of farmers' rights. *Development Policy Review*, 21(4):419–447, 2003. doi:10.1111/1467-7679.00218.
- Srinivasan, C. S. Modelling economic returns to plant variety protection in the uk. *Bio-based and Applied Economics*, 1(2):151–174, 2012. doi:10.13128/BAE-10557.
- Tripp, R. and Louwaars, N. Seed regulation: choices on the road to reform. *Food Policy*, 22(5):433–446, 1997. doi:10.1016/S0306-9192(97)00033-X.

Trommetter, M. Intellectual property rights in agricultural and agro-food biotechnologies to 2030. Technical report, OECD, 2008.

Yerokhin, O. and Moschini, G. Intellectual property rights and crop-improving r&d under adaptive destruction. *Environmental and Resource Economics*, 40(1):53–72, 2008. doi:10.1007/s10640-007-9140-5.

Appendix

3.A Variety choice under a patent regime and in the absence of a feedback effect of biodiversity

Assuming there is no feedback effect of biodiversity on crops yields, the first order conditions for $i \in \{i, \dots, N - 1\}$ associated with program (3.10) may be written as⁸

$$w_i = \frac{c_i}{2} + \frac{w_{i+1}}{2} \frac{\eta_i - \eta_{i-1}}{\eta_{i+1} - \eta_{i-1}} + \frac{w_{i-1}}{2} \frac{\eta_{i+1} - \eta_i}{\eta_{i+1} - \eta_{i-1}} + \left(\frac{w_{i+1} - c_{i+1}}{2} \right) \frac{\eta_i - \eta_{i-1}}{\eta_{i+1} - \eta_{i-1}} + \left(\frac{w_{i-1} - c_{i-1}}{2} \right) \frac{\eta_{i+1} - \eta_i}{\eta_{i+1} - \eta_{i-1}} \quad (3.14)$$

Note that for $i = 1$ we have $w_{i-1} = c_0$ so that the last term vanishes. For $i = N$, the first order condition is

$$w_N = P \alpha \frac{\eta_N - \eta_{N-1}}{2} A_{\max} + \frac{c_N}{2} + \frac{w_{N-1}}{2} + \frac{w_{N-1} - c_{N-1}}{2} \quad (3.15)$$

This set of first order conditions is linear with respect to the unknown prices w_i ($i \in \{1, \dots, N\}$) so that it is expected that one and only one solution exists. In order to determine this solution, we re-express (3.14) and (3.15) in terms of the threshold values of the productivity parameter involved in (3.6). Let A_{i-1}^i denote the threshold value $\frac{w_i - w_{i-1}}{P\alpha(\eta_i - \eta_{i-1})}$ of the productivity parameter A above which a farmer prefers variety i to variety $i - 1$. Then, (3.14) and (3.15) simplify to

8. The absence of feedback effect of biodiversity on yields implies that we do not have to take the derivative of the productivity parameter with respect to prices (via the market shares).

$$A_{i-1}^i = \frac{A_{\max}}{2} + \frac{1}{2P} \frac{c_i - c_{i-1}}{\alpha (\eta_i - \eta_{i-1})} \quad \forall i \in \{1, \dots, N\} \quad (3.16)$$

that directly yields the optimal expression of each threshold. According to (3.16), a monopolistic pricing implies that the value of thresholds remain unchanged when the total number of varieties increases. It follows on from this first result and from the demand system (3.7) that the equilibrium quantity sold for each variety is not affected by an incremental invention taking the form of a new variety with a higher value of parameter η except for the breeder variety prior to the new breeder variety, due to the truncation of demand resulting from the arrival of the latest variety. Furthermore, the equation (3.16) enables us to determine a necessary and sufficient condition for the monopolist to supply each of the varieties $i \in \{1, \dots, N\}$ in order to maximise its total profit.

Proposition 1 *A monopolist breeder optimally supplies each of varieties $i \in \{1, \dots, N\}$ if and only if the sequence $\{c_i, \eta_i\}$ of unit costs and quality indexes forms a convex curve in space $\{c, \eta\}$.*

Proof 1 *According to equation 3.16 and to the demand system 3.7, a positive demand is addressed to each variety $i \in \{1, \dots, N\}$ if and only if $\frac{c_i - c_{i-1}}{\eta_i - \eta_{i-1}}$ increases with i , which is equivalent to the stated convexity property.*

If, conversely, the sequence $\{c_i, \eta_i\}$ of unit costs and quality indexes forms a concave curve in space $\{c, \eta\}$, then the monopolist breeder will only supply the variety $i = N$ characterised by the highest quality.

Under the condition stated in Proposition 1 and using the expression $\frac{w_i - w_{i-1}}{P \alpha (\eta_i - \eta_{i-1})}$ of threshold A_{n-1}^n , we conclude that prices are defined by the following recursive formula for a monopolist:

$$w_i = w_{i-1} + A_{i-1}^i P \alpha (\eta_i - \eta_{i-1}) \quad \forall i \in \{1, \dots, N\} \quad (3.17)$$

Given that $w_0 = c_0$ because multiple suppliers of the landrace variety compete under perfect competition, formula (3.17) yields the following optimal value of prices:

$$w_i = c_0 + \frac{A_{\max}}{2} P \alpha (\eta_i - \eta_0) + \frac{1}{2} (c_i - c_0) \quad \forall i \in \{1, \dots, N\} \quad (3.18)$$

Formula (3.18) is a key element in stating the Proposition 2

Proposition 2 *Equilibrium prices for varieties optimally supplied by a multi-product monopolist are unaffected by an incremental invention.*

Proof 2 *The result follows on from the fact that, according to 3.18, the equilibrium price for a variety only depends on its unit cost and technical characteristics and on that of the landrace variety.*

Conversely, Proposition 3 yields a necessary and sufficient condition for a monopolist breeder to supply only the highest quality.

Proposition 3 *A monopolist breeder optimally supplies the sole highest quality variety $i = N$ if and only if the sequence $\{c_i, \eta_i\}$ of unit costs and quality indexes forms a concave curve in space $\{c, \eta\}$.*

Proof 3 *According to equation 3.16 and to the demand system 3.7, a positive demand is addressed to variety $i = N$ whereas no positive demand is addressed to varieties $i \in \{1, \dots, N - 1\}$ if and only if $\frac{c_i - c_{i-1}}{\eta_i - \eta_{i-1}}$ decreases with i , which is equivalent to the stated concavity property.*

Under the condition stated in Proposition 3, the formula (3.15) with η_0 in place of η_{N-1} and c_0 in place of c_{N-1} directly yields the optimal price w_N . We then deduce the following Proposition.

Proposition 4 *The optimal price w_N of the highest quality variety of seeds for a mono-product monopolist is identical to the optimal price of the same variety chosen by a multiproduct monopolist breeder that would optimally supply all varieties $i \in \{1, \dots, N - 1\}$.*

Proof 4 *Replacing η_{N-1} by η_0 and c_{N-1} by c_0 in formula (3.15) and rearranging yields the same optimal price for variety N than the one obtained with equation (3.18).*

3.B Effect of a change of the commercialisation rule in a patent regime

Figure 3.B.1: Impact of a switch from minimum standards to the catalogue

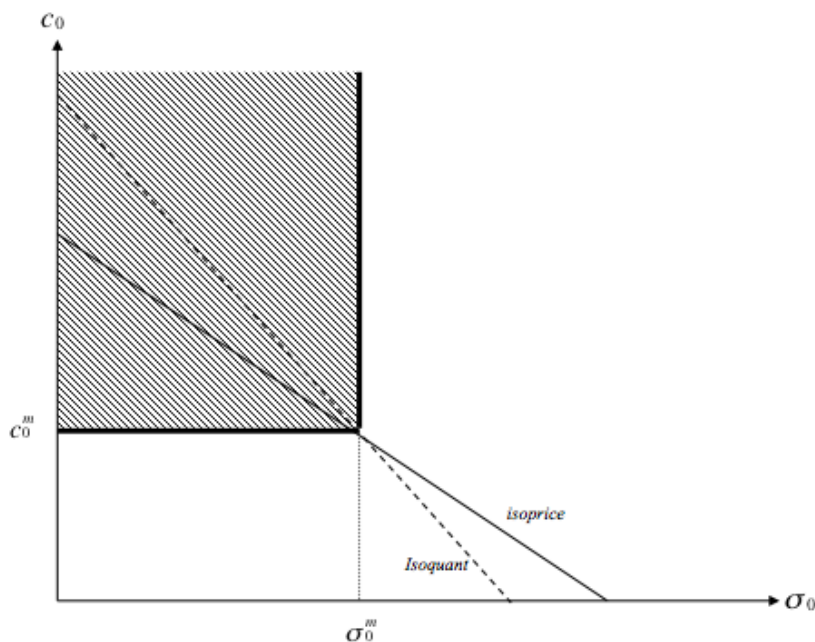

In order to determine the impact of choosing either minimum standards or a catalogue as commercial rules, we draw the isoprice and isoquant curves for a given variety i in space $\{\sigma_0, c_0\}$. Indeed, the key difference between minimum standards and a catalogue is that, in the event of a catalogue, seeds of the landrace variety have to pass the same DUS test than seeds created by breeders. Therefore, the standard deviation σ_0 characterising the random component affecting the profit of farmers that use the landrace has to be lowered to the same level than that of farmers that use breeders' varieties. This implies a higher unit cost c_0 for seeds of the landrace variety. Whether the breeder is a monoproduit monopolist or a multiproduit monopolist does not matter for isoprice curves because the optimal price is formally given by the same equation (3.18) whatever the variety i considered. Moreover, one easily checks that these curves are linear and decreasing in space $\{\sigma_0, c_0\}$ and move upwards when they are associated

to a higher price. Starting from $\sigma_0 = \sigma_0^m$ and $c_0 = c_0^m$ with minimum standards, the adoption of a catalogue induces a move somewhere inside the hatched area in Figure 3.B.1. If a small decrease of σ_0 is enough to pass the DUS test as required for registration in a catalogue and this decrease results in a sufficiently high additional unit cost for the landrace variety $i = 0$, then the combination $\{\sigma_0^c, c_0^c\}$ associated with a catalogue will be above the initial isoprice curve and the prices of varieties $i \in \{1, \dots, N\}$ supplied by the monopolist breeder will increase. An opposite result is obtained if σ_0^c is small compared to σ_0^m whereas c_0^c is close to c_0^m . If the breeder is a monoprodukt monopolist, the quantity q_N of variety N optimally supplied is

$$q_N = \bar{q} \left(\frac{A_{\max}}{2} - \frac{1}{2P} \frac{c_N - c_0}{\alpha(\mu_N - \mu_0) - \theta(\sigma_N - \sigma_0)} \right) \quad (3.19)$$

Then, the isoquant is also linear and decreasing in space $\{\sigma_0, c_0\}$ and move upwards when associated to a higher quantity. Thus, the consequence for the optimal supply of variety N of a switch from minimum standards to a catalogue are similar to those already obtained for the price of variety N . Whether the isoquant is higher than the isoprice (as represented in Figure 3.B.1) or not is unclear. Nevertheless, combining variations of the price and of the quantity, we conclude that the profit generated by variety N will increase (respectively decrease) if σ_0^c is close to (respectively far from) σ_0^m and c_0^c is far from (respectively close to) c_0^m . If the breeder is a multiprodukt monopolist, then the analysis for the quantity q_N of the highest quality variety is formally identical to that for the monoprodukt monopolist. The analysis for lower quality varieties is simpler because the corresponding optimal quantities q_i $i \in \{1, \dots, N - 1\}$ are invariant with respect to σ_0 and c_0 . The sign of the variation of the associated profits is thus identical to the sign of the variation for the corresponding optimal prices. All these results are summarised in Proposition 5.

Proposition 5 *Under a patent regime, if the switch from minimum standards to a catalogue results in a small drop of σ_0 but a sharp increase of c_0 , then prices, and the markup, of all the varieties that a monopolist breeder will find optimal to supply and the associated profits will increase. The optimal quantity of the highest quality variety*

will also increase whereas the quantities of lower quality optimally supplied, if any, will remain unchanged.

Proof 5 *See Figure 3.B.1 and the comments above.*

According to Proposition 5, it is thus expected that, under a patent regime, breeders will argue in favour of the catalogue rule rather than in favour of minimum standards only if they think that the additional unit cost incurred by suppliers of seeds for landraces to meet the DUS criteria is high enough compared to the resulting reduction of productivity uncertainty that affects farmers. We now turn to the case of a PBRs regime.

3.C Variety choice under a PBR regime and in the absence of a feedback effect of biodiversity

Assuming there is no feedback effect of biodiversity on crops yields, the first order conditions for $i \in \{i, \dots, N - 1\}$ associated with program (3.11) may be written as

$$w_i = \frac{c_i}{2} + \frac{w_{i+1}}{2} \frac{\eta_i - \eta_{i-1}}{\eta_{i+1} - \eta_{i-1}} + \frac{w_{i-1}}{2} \frac{\eta_{i+1} - \eta_i}{\eta_{i+1} - \eta_{i-1}} \tag{3.20}$$

and

$$w_N = P \alpha \frac{\eta_N - \eta_{N-1}}{2} A_{\max} + \frac{c_N}{2} + \frac{w_{N-1}}{2} \tag{3.21}$$

for $i = N$. (3.20) and (3.21) define the reaction functions characterising the game in prices. The linearity of these reaction functions guarantees that if a solution exists it is unique. Nevertheless, it seems that it is not possible to rearrange this set of reaction functions in terms of the sole thresholds A_{i-1}^i . It is thus expected that, contrary to what happens in the monopolistic context, both prices and the values of thresholds vary when the total number of varieties increases. Note also that, according to (3.20) and (3.21) and the fact that $\eta_i > \eta_{i-1} \forall i \in \{1, \dots, N\}$, reaction functions have a positive slope. We thus obtain the following characteristic of the game in prices:

Proposition 6 *There is strategic complementarity between prices.*

Proof 6 *Reaction functions are increasing with respect to strategic decisions of other players which defines strategic complementarity.*

Proposition 6 is a key element for the graphical comparison of monopolistic and oligopolistic pricing when $N = 2$.

As in the case of a patent regime, isoprice and isoquant curves are useful to highlight the consequences of adopting either minimum standards or a catalogue for commercialisation rules. Nevertheless, we focus here on the case where $N = 2$ because we are not able to find a simple analytical expression of optimal prices for a generic value of N . Proposition summarises the results as regards the consequences of a change in commercialisation rules.

Proposition 7 *If the corresponding change in the unit cost c_0 and the standard deviation σ_0 of productivity are of limited magnitude and the variation of σ_0 is small enough compared to the variation of c_0 , then the strengthening of commercial rules resulting from a switch from minimum standards to a catalogue induces an increase of the price of breeders' varieties and an increase of the quantities of seeds sold to farmers for these varieties.*

Proof 7 *See Appendix E.*

In spite of the similitude between Propositions 5 and 7, these two Propositions neither mean that the change in prices and quantities under a PBR regime and under a patent regime will have the same magnitude, nor that it will have the same sign. This is expected to happen only in the polar cases where the variation of σ_0 is small compared to that of c_0 (prices and quantities of breeders' varieties then increase) or where the variation of σ_0 is high compared to that of c_0 (prices and quantities of breeders' varieties then decrease).

3.D Comparative analysis of pricing

Although a standard result in economics states that, for a single product, the markup of a monopolist is higher than that for any other market structure, it is not that obvious to extend it to a multiproduct context. Indeed, it is not intuitively unconceivable that in order to maximise its total profit a multiproduct monopolist optimally chooses to charge a higher price for the high quality good but a lower price for low quality goods, for instance. Moreover, when the monopolist optimally decides to supply the sole highest quality good, the demand system is substantially affected and the comparison of prices is complicated. Therefore, it is worth providing some analytical results as regards the comparison of optimal prices with an oligopolistic versus monopolistic market structure. The focus is on the case of two breeder varieties. The reason for this is that in the dynamic framework that is analysed latter in the paper, R&D investments have to be analysed backwards and the model is limited to two periods for computational tractability so that $N = 2$ at the best.

Figure 3.D.1 illustrates the Bertrand-Nash equilibrium of the price game in the second period when two different firms have an exclusivity right on each variety of the "breeder" type. Such a market structure may arise only under a PBR regime. The dark line ($\underline{A\bar{A}}$) represents the reaction function $w_1^*(w_2)$ of the firm providing variety 1. The expression of this reaction function solves the first order condition (3.20) for $i = 1$. One easily checks that, due to the assumption $\eta_i > \eta_{i-1} \forall i \in \{1, \dots, N\}$, the slope of the reaction function $w_1^*(w_2)$ in space $\{w_1, w_2\}$ exceeds unity. By construction, isoprofit curves for firm 1 admit their minimum in space $\{w_1, w_2\}$ at the crossing point with the reaction function $w_1^*(w_2)$. They decrease (respectively increase) with w_1 for all values of w_1 lower (respectively higher) than this minimum. They all admit $w_1 = c_1$ as an asymptote when w_2 tends to infinity. Similarly, the dark line ($\underline{B\bar{B}}$) represents the reaction function $w_2^*(w_1)$ of the firm providing variety 2 and its expression solves the first order condition (3.21) for $N = 2$. The slope of the reaction function $w_2^*(w_1)$ in space $\{w_1, w_2\}$ amounts to $\frac{1}{2}$. By construction, isoprofit curves for firm 2 admit their

Figure 3.D.1: Bertrand-Nash equilibrium with N=2

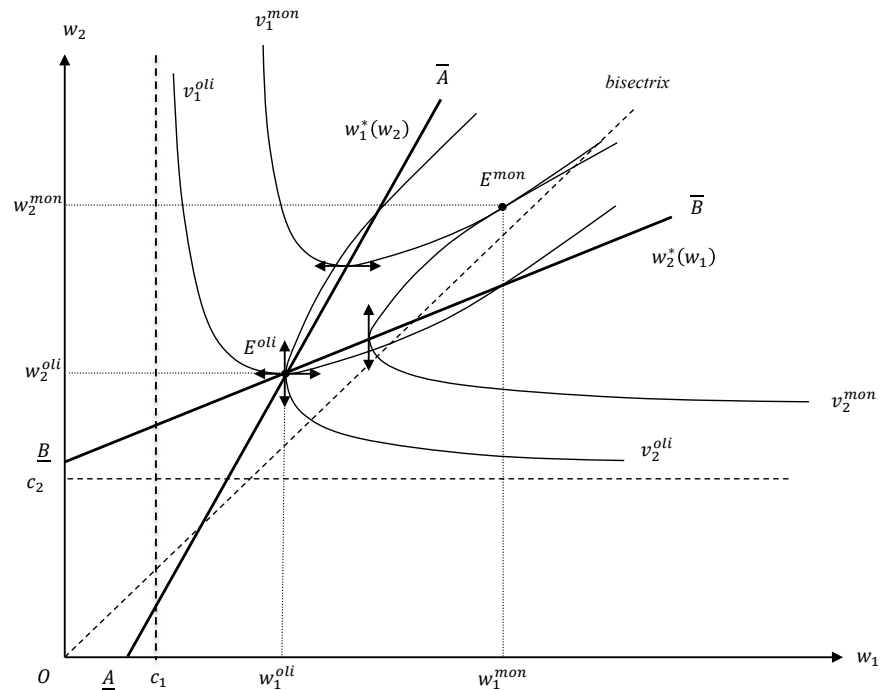

minimum in space $\{w_2, w_1\}$ at the crossing point with the reaction function $w_2^*(w_1)$. They decrease (respectively increase) with w_2 for all values of w_2 lower (respectively higher) than this minimum and admit $w_2 = c_2$ as a horizontal asymptote in space $\{w_1, w_2\}$. Finally, isoprofit curves for both firms are associated with higher profit levels as they shift further from the origin. The oligopolistic equilibrium for the prices of varieties $i = 1$ and $i = 2$ is characterised by the coordinates $w_1 = w_1^{oli}$ and $w_2 = w_2^{oli}$ of the intersection E^{oli} of the two reaction functions if and only if the intersection lies above the bisectrix in space $\{w_1, w_2\}$. Otherwise the demand for variety $i = 1$ as defined in (3.7) would generate a negative value, thus indicating that variety $i = 1$ would actually be abandoned. Profit levels at point E^{oli} for firm 1 and firm 2 are respectively denoted v_1^{oli} and v_2^{oli} .

Some indications on the relative position in Figure 3.D.1 of optimal prices for a multiproduct monopolist when $N = 2$, compared to the oligopolistic price equilibrium, may also be obtained. Indeed, a standard result of the maximisation program (3.10) of

the sum of profits for $N = 2$ is that the unique interior solution to first order conditions (3.20) and (3.21) is a point of tangency between isoprofit curves of varieties 1 and 2. Such a tangency may be obtained only on subsets of Figure 3.D.1 where isoprofit curves for both firms are either decreasing or increasing in space $\{w_1, w_2\}$. According to the previous discussion about the general shape of isocurves, we know that isoprofit curves for variety 1 are decreasing in space $\{w_1, w_2\}$ above the line associated to the reaction function $w_1^*(w_2)$ and are increasing behind the same line whereas isoprofit curves for variety 2 are decreasing in space $\{w_1, w_2\}$ behind the line associated to the reaction function $w_2^*(w_1)$ and are increasing above this line. Thus a point of tangency between isoprofit curves may be found only inside the area $O\underline{A}E^{oli}\underline{B}$ or inside the cone $\overline{B}E^{oli}\overline{A}$. Inside the area $O\underline{A}E^{oli}\underline{B}$ isoprofit curves are associated with a lower profit level than at point E^{oli} for both varieties of crops. A monopolist would then be better off choosing E^{oli} rather than such a tangency point. The solution for monopolistic pricing can thus only belong to the cone $\overline{B}E^{oli}\overline{A}$ where isoprofit curves are associated with higher profit levels for both varieties. Moreover, for a monopolist to supply variety 1 it is required that w_2 exceeds w_1 so that the equilibrium point E^{mon} (with coordinates $w_1 = w_1^{mon}$ and $w_2 = w_2^{mon}$ and profit levels v_1^{mon} and v_2^{mon}) lies above the bisectrix. Note that according to (3.17) this condition is fulfilled if the technical condition $\eta_i \geq \eta_{i-1} \forall i \in \{1, \dots, N\}$ and the cost condition $c_i \geq c_{i-1} \forall i \in \{1, \dots, N\}$ are satisfied (one of the two inequalities being strict for each i). We can then write the following Proposition:

Proposition 8 *The optimal price charged by a monopolist for a variety, whether it optimally chooses to be monoproducer or it rather opts for multiproduction, is always higher than the price of the variety when each variety is supplied by a different breeder.*

Proof 8 *The result directly follows from the analysis of Figure 3.D.1 and Proposition 4.*

The point in Proposition 8 is that the result does not only apply to the case of a multiproduct monopolist but also to the case of a monoproducer monopolist.

3.E Comparative statics of oligopoly prices with respect to c_0 and σ_0 when $N = 2$

Substituting c_0 for w_0 , the reaction functions for the Bertrand-Nash game in prices are given by:

$$w_1 = \frac{c_1}{2} + \frac{w_2}{2} \frac{(\mu_1 - \theta\sigma_1) - (\mu_0 - \theta\sigma_0)}{(\mu_2 - \theta\sigma_2) - (\mu_0 - \theta\sigma_0)} + \frac{c_0}{2} \frac{(\mu_2 - \theta\sigma_2) - (\mu_1 - \theta\sigma_1)}{(\mu_2 - \theta\sigma_2)(\mu_0 - \theta\sigma_0)} \quad (3.22)$$

$$w_2 = P \alpha \frac{(\mu_2 - \theta\sigma_2)(\mu_1 - \theta\sigma_1)}{2} A_{\max} + \frac{c_2}{2} + \frac{w_1}{2} \quad (3.23)$$

We differentiate the two reaction functions with respect to c_0 and w_0 in the neighborhood of the equilibrium:

$$dw_1 = \frac{\partial w_1}{\partial c_0} dc_0 + \frac{\partial w_1}{\partial \sigma_0} d\sigma_0 + \frac{\partial w_1}{\partial w_2} dw_2 \quad (3.24)$$

$$dw_2 = 0dc_0 + 0d\sigma_0 + \frac{1}{2}dw_1 \quad (3.25)$$

The second relation just states that variations of w_2 are half those of w_1 . Moreover, given that μ_i increases with i whereas σ_i decreases with i , one easily checks that in the above equations we have

$$\frac{\partial w_1}{\partial w_2} = \frac{1}{2} \frac{(\mu_1 - \theta\sigma_1) - (\mu_0 - \theta\sigma_0)}{(\mu_2 - \theta\sigma_2) - (\mu_0 - \theta\sigma_0)} \in \left[0, \frac{1}{2}\right] \quad (3.26)$$

$$\frac{\partial w_1}{\partial c_0} = \frac{(\mu_2 - \theta\sigma_2) - (\mu_1 - \theta\sigma_1)}{2(\mu_2 - \theta\sigma_2) - (\mu_0 - \theta\sigma_0)} \in \left[0, \frac{1}{2}\right] \quad (3.27)$$

$$\frac{\partial w_1}{\partial \sigma_0} = \theta \left(\frac{w_2 + c_0}{2} \right) \frac{(\mu_2 - \theta\sigma_2) - (\mu_1 - \theta\sigma_1)}{((\mu_2 - \theta\sigma_2) - (\mu_0 - \theta\sigma_0))^2} > 0 \quad (3.28)$$

We conclude that $\frac{dw_1}{dc_0} > 0$ and $\frac{dw_1}{d\sigma_0} > 0$ so that, in the neighborhood of $\{\sigma_0, c_0\}$

we have the same type of isoprice curves than under a patent regime. As the demand system is the same under a PBRs system and a patent regime, we also conclude that in the neighborhood of $\{\sigma_0, c_0\}$ the isoquant curves are of the same type than under a patent regime..

3.F Isoprofit equation for the first breeder variety

We examine the isoprofit of the first breeder variety to check its convexity as it is built in the Figure 3.D.1 in Annex D. The profit function of the first breeder variety is

$$v_1 = (w_1^* - c_1)q_1 \tag{3.29}$$

where $q_1 = \left(\frac{w_2 - w_1}{P\alpha(\eta_2 - \eta_1)} - \frac{w_1 - w_0}{P\alpha(\eta_1 - \eta_0)} \right) * \frac{M * L * \frac{1}{\alpha}}{A_{max} - A_{min}}$

To construct the Figure 3.D.1 in Annex D we rearrange the profit equation and we obtain the isoprofit equation

$$w_2 = w_1 + w_1 \frac{\eta_2 - \eta_1}{\eta_1 - \eta_0} - w_0 \frac{\eta_2 - \eta_1}{\eta_1 - \eta_0} + v_1 \frac{P\alpha(\eta_2 - \eta_1)}{w_1 - c_1} \frac{A_{max} - A_{min}}{M * L * \frac{1}{\alpha}} \tag{3.30}$$

The first and the second degree of partial derivatives of the isoprofit is analysed to determine the isoprofit curve shape

$$\frac{\partial w_2}{\partial w_1} = 1 + \frac{\eta_2 - \eta_1}{\eta_1 - \eta_0} - v_1 \frac{P\alpha(\eta_2 - \eta_1)}{(w_1 - c_1)^2} \frac{A_{max} - A_{min}}{M * L * \frac{1}{\alpha}} \tag{3.31}$$

$$\frac{\partial^2 w_2}{\partial w_1^2} = +2v_1 \frac{P\alpha(\eta_2 - \eta_1)}{(w_1 - c_1)^3} \frac{A_{max} - A_{min}}{M * L * \frac{1}{\alpha}} \tag{3.32}$$

The first-degree is negative and the second-degree is positive, thus the isoprofit curve is convex when the monopoly is multi-product (as figure 3.D.1 in Annex D).

Chapter 4

Plant Breeders' Rights, Patents and Incentives to Innovate

Plant Breeders' Rights, Patents and Incentives to Innovate

Hervouet Adrien* Langinier Corinne†

Abstract

Innovations on plant varieties can be protected by patents or Plant Breeder Rights (PBRs). Although these methods of protection have similarities, they also have major differences. With the PBR regime, the “farmers’ exemption” allows farmers to save part of their harvest to replant during the next period. In some countries, farmers who self-produce must pay a tax to the seed producer for the loss incurred due to this exemption. We analyze the impact of this exemption and its associated tax on the seed prices and the incentive to innovate in a monopoly setting. We find that with only a PBR regime, a relatively high tax level is necessary to eliminate self-production. If both regimes coexist, farmers might still self-produce if the seed innovation is protected with a PBR. Our findings suggest that the coexistence of the two regimes does not fully prevent self-production. Nevertheless, it boosts the research investment which is a non-monotonic function of the tax. The seed producer might over or under invest compared to what is socially optimal. Moreover, the incentives to innovate are the highest either with a patent regime or with a PBR regime for which a high tax prevents seed saving. In terms of welfare, having both systems has ambiguous effects.

Keywords: Intellectual Property Rights, Plant Breeders’ Rights, Seed Saving

JEL classifications: D23, K11, L12, Q12

*. Institut d’Économie et de Management de Nantes-IAE, LEMNA ,Chemin de la Censive de Tertre, BP 52231, 44322 Nantes, France, Tel.: +33 2 40 14 17 19, adrien.hervouet@univ-nantes.fr

†. University of Alberta, Edmonton, langinie@ualberta.ca

4.1 Introduction

Before the nineteenth century, varietal creations were obtained by conventional plant breeding: farmers would save part of their harvest (usually the best looking seeds) to plant for the next year. Nowadays, private companies (breeders or seed producers such as Monsanto or Pioneer) invest in Research and Development (R&D) to develop new varieties of crops that provide higher yields for farmers or lower environmental threats (e.g., reduce pest or vegetable diseases).

Because of the self-reproduction nature of crops, the output of crop research is non-excludable. If it is not explicitly prevented,¹ farmers can save part of their harvest to self-produce during the next period as seed traits remain unchanged after several harvesting periods. Therefore, seed saving has an impact on pricing strategies and incentives to innovate of seed producers.

As farmers can save seed for the next period, seed varieties can be seen as durable goods (Coase, 1972; Bulow, 1982; Waldman, 2003). A seed producer can make the seed durable by choosing appropriate prices such that farmers buy the seed once and then self-produce in the next periods. On the other hand, the seed producer can also choose prices such that farmers buy during each period (Ambec et al., 2008). Thus, depending on the pricing strategy adopted by the seed producer, seed can be seen as durable goods or not.

As seed saving decreases the seed producer's innovation appropriation, his incentive to invest in R&D can be altered. In order to address this "public" good issue, a certain level of appropriation is needed for private firms to innovate. Without Intellectual Property Rights (IPRs) that allow to establish the necessary appropriation for the private creation (Scotchmer, 2004), there would be no incentives to innovate for the private sector. IPRs provide a temporary monopoly power to innovators which leads to a possible static welfare loss necessary from a dynamic perspective (*ex ante* incentive).²

Once a seed producer has developed a new crop variety, he can protect his innova-

1. Through a contract or because the crop is sterile due, for instance, to genetic modification.

2. For issues related to the introduction of IPRs see, for instance, Menell and Scotchmer, 2007.

tion³ with a patent or a Plant Breeders' Right (PBR).⁴ In some countries, only PBRs are allowed (e.g., European Union⁵) while both systems are offered in other countries (e.g., U.S.). These two types of property rights have similarities but also major differences.

The main criteria for an innovation to be granted a patent are novelty and non-obviousness. A patent involves exclusive rights to make, use, sell, and distribute the invention. In the U.S., some plants (asexual species) are patentable since 1930 under the Plant Patent Act (PPA), while for other plants, an inventor can obtain a PBR under the Plant Variety Protection Act (PVPA) since 1970. Moreover, two decisions of the supreme court in 1980⁶ and 2001⁷ enable seed producers to patent a new variety (asexual or sexual) with a utility patent.

The PBR system was established by the International Union for the Protection of New Varieties of Plants (UPOV). In 2014, 72 countries are UPOV members and they use a PBR regime for their seed variety innovations. Some non-UPOV member countries such as India have created a regime similar to the PBR regime. The main requirements for PBRs are novelty and Distinction, Uniformity and Stability (DUS) test. Even though a PBR involves exclusive rights similar to those of a patent, there are two notable exemptions: private research with commercial purposes and seed saving.

The first exemption, called "research exemption" allows another seed producer to use proprietary seeds to create and commercialize a new variety without any agreement or licence on the first varieties. This is unlike the patent system, in which a patentholder can prevent a competitor to enter the market or monopolize part of the new seed market

3. The agreement on Trade-Related aspect of Intellectual Property Rights (TRIPS) allows to protect innovation on living organisms for members of World Trade Organization (WTO).

4. The PBR system is also called Plant Variety Rights (PVRs) system which is a *sui-generis* system, which means that it is a unique system for living organisms.

5. In the European Union, seeds and plants are not patentable; they can only be protected with PBRs. Directives 2100/94 and 98/44 that can be found, respectively, at <http://eur-lex.europa.eu/LexUriServ/LexUriServ.do?uri=CELEX:31994R2100:EN:HTML> and http://eur-lex.europa.eu/smartapi/cgi/sga_doc?smartapi!celexapi!prod!CELEXnumdoc&numdoc=31998L0044&model=guichett&lg=en, last accessed March 2014.

6. Chakrabarty case on patenting micro-organisms. See, for instance, <http://caselaw.lp.findlaw.com/cgi-bin/getcase.pl?court=us&vol=447&invol=303>, last accessed March 2014.

7. Pioneer versus JEM Ag Supply case <http://caselaw.lp.findlaw.com/scripts/getcase.pl?court=US&vol=000&invol=99-1996>, last accessed March 2014).

with a licence. This exemption has an important impact on seed innovation because of the cumulative nature of innovations in the seed breeding sector (Scotchmer, 1991).

The second exemption called “farmers’ exemption,” allows a farmer to save part of his harvest to sow for the next period, even if the variety is the property of a seed producer. One way for seed producers to limit self-production is to produce hybrid seeds. Indeed, the development of hybrid seeds reduces the attractiveness of self-production as seed saving involves a very high yield loss. However, hybrid seeds are not yet well-developed for some species such as wheat. As a result, between 40 to 50% of wheat seeds come from seed saving in France, while it is 80% in Canada (Curtiss and Nilsson, 2012).

Similarly to U.S. patents that enable seed producers to prevent farmers from using their saved seed, in several countries with PBR regimes, self-producing farmers have to compensate the seed producer for the incurred loss. In France, for instance, an inter-professional agreement has been established in 2001 between farmers and seed companies to correct the seed producers’ loss for wheat seed.⁸ This agreement has led to the creation of a tax paid by a farmer when he sells his output. If he buys the seed from the seed producer (and thus does not self-produce), he gets refunded of the amount of the tax.

Taxes or royalties are used in several other countries as well (Curtis and Nilsson, 2012). In Table 4.1, we summarize the different methods of compensation depending on countries as well as the reported percentage of self-production mostly for wheat.

Because of these major exemptions, the PBR system can be seen as a weaker system than the patent system. It is also cheaper to obtain a PBR than a patent (Wright et al., 2007).

Many countries (Argentina, Canada, Germany, UK, France) do not allow seed innovators to patent their innovations and only PBRs can be used to protect seed innovations. In other countries (U.S., Japan, New Zealand and Australia),⁹ both systems coexist and firms do protect their plant innovations with both patents and PBRs. For

8. Directive 2100/94.

9. They are called ‘utility patents’ in the U.S. and Japan and ‘standard patents’ in Australia.

Table 4.1: IPRs and methods of compensation for different countries

	PBR/Patent	Self-Production	Royalty or tax
Australia	both	90% (small grain)	Royalty
U.S.	both	66% (wheat)	–
Argentina	PBR	40% (wheat)	Royalty
Canada	PBR	80% (wheat)	–
Germany	PBR	57% (cereals)	Royalty
U.K.	PBR	42%	Royalty
France	PBR	49% (wheat)	Tax

Curtis and Nilsson (2012)

instance, in 2013, Monsanto owned 427 U.S. patents and 69 Plant Variety Protection Act Certificates.¹⁰

We therefore wonder what will be the impact of the introduction of the patent regime in a system where only PBRs are allowed? In other words, how will the European system be affected by allowing seed producers to patent their innovations? How will the introduction of the patent system affect the protection choice and the incentive to innovate of seed producers? What will be the impact on the social welfare? This gives rise to policy questions that are of interest for policy makers: should European countries allow seed producers to patent their seed innovations?

We also wonder what are the reasons for a seed producer to use both patent and PBR in a system similar to the U.S.? In other words, why does Monsanto have a mix of patents and PBRs?

PBRs have been extensively studied in the economic literature. Recent contributions find a small positive impact of PBRs on the agriculture productivity growth (Naseem et al., 2005; Carew et al. 2009) while others find that only a few PBRs are valuable (Srinivasan, 2012). This later finding is consistent with results about the value of patents in the patent literature (Schankerman and Pakes, 1986).

It is also not clear who benefits the most from PBRs. According to Moschini et al.

10. Data are from the USPTO and USDA websites.

(2000), innovators are those who benefit the most, while others contributions find that farmers might actually benefit from these innovations (Falck-Sepeda et al., 2000; Qaim and Traxler, 2005).

The impact of the two major exemptions of the PBR system have also been studied. In a sequential setting, Moschini and Yerokhin (2008) show that a PBR with the research exemption can be preferred to a patent, in particular if research costs are low. However, the research exemption will tend to decrease the incentive to innovate of the first innovators (Nagaoka and Aoki, 2009). The problems due to the research exemption are closely related to the problems of protection of cumulative innovations (Scotchmer, 1991).

Because of the farmers' exemption, seed varieties can be seen as durable goods. Conclusions similar to the Coase conjecture are reached by Perrin and Fulginiti (2008): the seed producer will exhaust his rent as prices decline over time. Due to the durable good nature of seeds, seed producers might prefer to introduce hybrid seed (which are similar to non-durable goods) even if it is less efficient (Ambec and al., 2008). To prevent farmers to use seed saving, contracts such as Technology Use Agreements (TUAs) can also been used instead of "terminator" varieties (Yiannaka, 2014). In these contribution, the innovation stage is not considered. Galushko (2008) introduces it and finds that a patent system can be preferable to a PBR system if the marginal cost of the seed producer exceeds the farmers reproduction cost. In the later model royalties on Farm-Saved Seed (FFS) are not considered. Our paper is a contribution to this later stream of literature.

Our goal is to investigate the impact of the farmers' exemption on the equilibrium seed prices and the seed producer's innovation decision in a monopoly setting. In order to compensate the seed producer for the loss incurred due to the farmers' exemption, we consider that a tax levied on self-producing farmers is partly paid to the seed producer. We analyze a model in which farmers can either buy seeds or use their own saved seed if allowed.

We consider that the seed producer is a monopolist who first decides to invest in a

seed innovation. Once a (large or small) innovation has been discovered, he chooses to protect it with a PBR or a patent (if available) and determines the seed prices for two periods. With a PBR regime, the seed producer can use two types of pricing strategies, as in Ambec et al. (2008): a durable good strategy or a non-durable good strategy. If protected by a costly patent, the seed innovation cannot be replanted by farmers as self-production is prohibited. This is the main difference between the two types of protection: a patent is costlier but prevents self-production.

We find that in a system where only PBRs are allowed, depending on the tax level and the productivity of self-producing farmers, the seed producer adopts different pricing strategies. He either adopts a 'durable good' strategy in which farmers self-produce in the second period or a 'non-durable good' strategy which makes self-producing not attractive to the farmers. In the former case, the seed producer sets a high second-period price, such that farmers self-produce, and captures the farmers' surplus with an appropriate first-period price. In the latter case, the seed producer sets the second-period price such that farmers prefer to buy rather than self-produce in the second period.

If both PBR and patent regimes are available, the seed producer will adopt the patenting strategy to prevent some self-producing but, because patenting is costly, he still adopts a durable good strategy with a PBR. Thus, allowing the seed producer to patent does not completely eliminate self-production.

Under a PBR regime, the research investment is a U-shape function of the tax. Initially, the seed producer reduces his investment as the tax increases. The rationale for this behavior is that as there is no gain in having a large innovation, the seed producer has no incentive to invest to obtain a large innovation. Then, when his protection decisions become different for different innovation sizes, the investment is first independent of the tax, and then it increases to reach a maximum for a high tax level. Compared to what would be socially optimal, the seed producer under or over invests for some values of the tax.

When the seed producer can protect his innovation with either IPR, his investment

becomes a non-monotonic function of the tax, even though he intensifies his investment compared to the case where only a PBR is available. The total welfare is also a non-monotonic function of the tax. Patenting can enhance or reduce the total welfare compared to a situation where only PBRs are allowed.

Our findings suggest that, even though allowing seed producers to patent their seed innovations will boost innovation, its impact on the social welfare is ambiguous. An inappropriate level of tax might result in a decrease in welfare. Furthermore, large innovations are more likely to be protected with a patent whereas small innovation will be protected with a PBR.

The paper is organized as follows. In Section 2, we present the model, the hypotheses and the timing of the game. Section 3 is devoted to the analysis of the price equilibria, and the decision of the seed producer to protect his innovation with a PBR or a patent. In Section 4, we analyze the research investment decisions depending on the innovation size and the protection choice. We also compare them to the socially investment decisions. In Section 5, we analyze the incentive to innovate and the impact of the seed producer decisions on the total welfare. Extensions of the models and robustness issues are raised in Section 6. Section 7 concludes.

4.2 The model

We consider a three-period model ($t = 0, 1, 2$) with two types of agents: a seed producer and farmers. In period zero, the seed producer chooses a level of R&D investment I in order to discover a seed innovation that will increase the farmers' productivity. The innovation is either a large innovation $\bar{\theta}$ with probability $\mu(I)$ or a small innovation $\underline{\theta}$ with probability $(1 - \mu(I))$, where $\mu'(I) > 0$, $\mu''(I) < 0$ and $\mu(0) = 0$.

Once the innovation has been discovered, the seed producer decides whether to patent it or to protect it with a PBR, depending on which protection is available. In the presence of a patent, farmers are prohibited from self-producing whereas if the invention is protected with a PBR, farmers are allowed to re-use the seed as they see it

fit. Thus, depending on the method of protection used by the seed producer, farmers will be able to self-produce or not. Furthermore, patenting and PBR costs differ: the cost to patent is $c_P > 0$ whereas it is normalized to zero for the PBR.¹¹

Once the seed producer introduces his protected innovation on the market he produces it at marginal cost 0 and faces a continuum of farmers of mass 1. Each farmer buys zero or one units of seed during the first and second period. In the first period, each farmer chooses to buy either an old seed that generates a payoff π_0 or the new seed that generates a payoff $\theta\pi$, where $\theta \in \{\underline{\theta}, \bar{\theta}\}$ is the increase in productivity due to the investment I with $1 < \underline{\theta} < \bar{\theta}$ and $\pi > \pi_0$.

In the second period, each farmer chooses to buy either the old seed or the new one if the new seed is patented. However, if the new seed is protected by a PBR, each farmer has a third option: to self-produce by saving part of his first-period harvest and replanting it in the second period, which will generate a payoff $\phi\theta\pi$ with $\phi < 1$. Self-producing farmers will incur a loss in productivity, which includes the cost of saving part of the harvest as well as the cost of the yield loss. To simplify, we consider that farmers are homogenous and ϕ represents the productivity of self-producing farmers with $\phi \in (0, 1)$.¹²

If a farmer decides to self-produce by saving part of his harvest and replanting it next year, he has to pay a tax τ to the government. A fraction λ of the tax is paid back to the seed producer.¹³ The remaining $(1 - \lambda)\tau$ corresponds to the cost of collecting the tax by the government.

To simplify we consider that the old seed has been on the market for some time, and is sold at a perfectly competitive price normalized to 0. Therefore, even in the absence of a tax, none of the farmers have an incentive to self-produce the old seed as

11. In 2004, Wright et al., (2007) estimated that patenting costs were around \$9400 whereas the estimated costs of PBR in Europe were about \$3600 per variety.

12. The assumption of farmers homogeneity can be justified when farmers form a cooperative as it is the case in Canada, for instance. In an extension of the model we consider the case of heterogeneous farmers.

13. In general, only 85% of the remaining tax (after repayment to buyers of certified seeds) is transferred to the seed producer. See, for instance, <http://www.gnis.fr/index/action/page/id/106/search/CV0>, last accessed March 2014.

$\pi_0 > \phi\pi_0$. Given the tax level and the investment decision, the seed producer chooses the new seed prices p_1 and p_2 for the two periods.¹⁴ We normalize the discount factor to 1.

To be precise, the timing of decisions is as follows. At period zero, the seed producer chooses his investment level I and the method of protection of his innovation (patent or PBR depending on whether it is available) once he has discovered a seed innovation.

In the first period, he chooses the seed prices for the first and second period, $\{p_1, p_2\}$. The farmers observe these prices. If the innovation is protected with a PBR, each farmer decides whether to buy the old seed at price 0 or the new seed at price p_1 , and then decides whether to save some seed to self-produce during the next period.

In the second period, those who did not save part of their first-period harvest decide whether to buy the old or the new seed at price p_2 and those who self-produce pay the tax τ . If the innovation is protected with a patent, each farmer decides to buy the old seed or the new seed during the first and second periods.

4.3 Price Equilibrium, Plant Breeder Right and Patent

By using a backward induction argument, we first determine the equilibrium prices set by the seed producer. We then move to the choice of the appropriate protection (PBR or patent) once the seed producer has discovered his innovation. Lastly, we analyze the optimal level of investment I .

The equilibrium prices will be different depending on the method of protection (PBR or patent) adopted by the seed producer. We consider in turn the price equilibrium when the seed producer chooses a PBR and when he chooses a patent.

14. We assume that the seed producer commits to these prices. In fact, if the period between saving and planting is relatively short, it seems likely that the second-period price is determined before the replanting decision. However, if the period is rather long, it seems more realistic that the seed producer will not commit to a second-period price and will set its price in the second period. See Ambec *et al.* (2008) for a discussion of both commitment and non-commitment cases.

4.3.1 Plant Breeder Right Regime

If the seed innovation is protected with a PBR, the seed producer cannot prevent farmers from self-producing during the second period. However, he can adopt either a 'durable good' strategy in which he sells seeds only during the first period (and let farmers self-produce in the second period), or a 'non-durable' good strategy in which he sells seeds during the two periods.

We first analyze whether the 'durable good' strategy can be an equilibrium. At the beginning of the first period, the present value of the payoff of a farmer who decides to buy the seed in the first period at price p_1 and self-produce during the next period and pays the tax τ is

$$\theta\pi - p_1 + \phi\theta\pi - \tau.$$

This payoff must be compared with the payoffs the farmer could obtain by choosing alternative buying strategies. He could decide to buy the old (respectively, new) seeds during both periods and would get $2\pi_0$ (respectively, $\theta\pi - p_1 + \theta\pi - p_2$); or to buy the old (respectively, new) seed during the first period and the new (resp., old) seed during the second period, and would obtain $\pi_0 + \theta\pi - p_2$ (resp., $\theta\pi - p_1 + \pi_0$).

The present value of the seed producer's payoff if he adopts this 'durable good' strategy is $p_1 + \lambda\tau$, as he sells the seed to all of the farmers in the first period and, then, gets a fraction λ of the tax paid by self-producing farmers in the second period. This 'durable good' strategy is an equilibrium in which the seed producer chooses the prices $\{p_1^D, p_2^D\}$ such that

$$\begin{aligned} p_1^D &= \theta\pi + \phi\theta\pi - \tau - 2\pi_0, \\ p_2^D &> \theta\pi - \pi_0, \end{aligned} \tag{4.1}$$

for $\phi \geq \phi_1$ with

$$\phi_1 \equiv \frac{\pi_0 + \tau}{\theta\pi}. \tag{4.2}$$

This later condition guarantees that replanting in the second period is more profitable

than buying the old seed. It is satisfied for high values of ϕ , which means for a high self-producing productivity (or a low loss in productivity). For given π_0 and π the cutoff value ϕ_1 is an increasing function of the tax τ , and a decreasing function of θ .

By choosing these prices, the seed producer insures that none of the farmers find it worthwhile to buy during the second period as p_2^D is too high. Thus, all of them self-produce and pay the tax τ during the second period, whereas they all buy the new seed during the first period.

The seed producer sells his new seed at price p_1^D to all of the farmers in the first period, and to none of them in the second period, but he still gets a fraction λ of the tax τ paid by the self-producing farmers, and thus, the present value of his payoff is

$$\Pi^D = \theta\pi(1 + \phi) - 2\pi_0 - \tau(1 - \lambda). \quad (4.3)$$

The farmers get

$$\theta\pi - p_1^D + \phi\theta\pi - \tau = 2\pi_0,$$

and the social welfare (which is the sum of the present value of both payoffs) is thus

$$W^D = \theta\pi(1 + \phi) - \tau(1 - \lambda). \quad (4.4)$$

The seed producer can however choose a 'non-durable good' strategy, in which he sells during both periods and obtains the present value $p_1 + p_2$. This 'non-durable good' strategy can also be an equilibrium where the seed producer chooses the prices $\{p_1^{ND}, p_2^{ND_1}\}$ or $\{p_1^{ND}, p_2^{ND_2}\}$ such that

$$\begin{aligned} p_1^{ND} &= \theta\pi - \pi_0, \\ p_2^{ND_1} &= \theta\pi - \pi_0 \text{ for } \phi < \phi_1, \\ p_2^{ND_2} &= \theta\pi(1 - \phi) + \tau \text{ for } \phi \geq \phi_1. \end{aligned} \quad (4.5)$$

The seed producer sets a second-period price such that all farmers buy the new seed

instead of self-producing. By setting both prices at $\theta\pi - \pi_0$ as it is the case for $\phi < \phi_1$, he guarantees that farmers will not buy the old seed instead of the new one. At the same time, the seed producer must insure that farmers will not self-produce, which occurs only for $\phi < \phi_1$ if $p_2^{ND_1} = \theta\pi - \pi_0$. For higher values of ϕ ($\phi \geq \phi_1$), the latter price $p_2^{ND_1}$ will be too high and, thus, the seed producer must set a lower price $p_2^{ND_2} = \theta\pi(1 - \phi) + \tau$.

Therefore, for $\phi < \phi_1$, the seed producer adopts non-durable good strategy 1 with prices $\{p_1^{ND}, p_2^{ND_1}\}$, and his payoff is

$$\Pi^{ND_1} = 2(\theta\pi - \pi_0), \quad (4.6)$$

the farmers get $2\pi_0$, and the social welfare is

$$W^{ND_1} = 2\theta\pi.$$

For $\phi \geq \phi_1$, the seed producer adopts non-durable good strategy 2 with prices $\{p_1^{ND}, p_2^{ND_2}\}$, and his payoff is

$$\Pi^{ND_2} = \theta\pi(2 - \phi) - \pi_0 + \tau, \quad (4.7)$$

the farmers get

$$\pi_0 + \phi\theta\pi - \tau,$$

and the social welfare is also

$$W^{ND_2} = 2\theta\pi = W^{ND_1} \equiv W^{ND}. \quad (4.8)$$

Given these equilibrium strategies, the seed producer chooses non-durable good strategy 1 with prices $\{p_1^{ND}, p_2^{ND_1}\}$ for $\phi < \phi_1$ (which is the only equilibrium candidate), non-durable good strategy 2 with prices $\{p_1^{ND}, p_2^{ND_2}\}$ for $\phi_1 \leq \phi < \phi_2$, and the durable

good strategy with prices $\{p_1^D, p_2^D\}$ for $\phi \geq \phi_2$ where

$$\phi_2 = \frac{\theta\pi + \pi_0 + \tau(2 - \lambda)}{2\theta\pi}. \quad (4.9)$$

When self-producing farmers have a high loss in productivity ($\phi < \phi_1$), the seed producer adopts a non-durable good strategy in which he sells the new seed at the same price during both periods, and all of the farmers buy the new seed. As self-producing farmers become more productive ($\phi > \phi_1$), the seed producer must reduce his second-period price in order to insure that farmers do not self-produce.

However, when self-producing farmers are very productive ($\phi > \phi_2$), the seed producer adopts a durable good strategy in which he does not have to insure that farmers do not self-produce anymore. In fact, he raises his second-period price to make sure that farmers will self-produce, and also increases his first-period price in order to capture the entire farmers' surplus. We summarize these findings in the following Lemma.

Lemma 1 *Under a PBR regime, two different pricing strategies can be adopted in equilibrium by the seed producer:*

- when $\phi \geq \phi_2$, a durable good strategy is adopted with prices $\{p_1^D, p_2^D\}$ as defined by (4.1);
- when $\phi < \phi_2$, a non-durable good strategy is adopted with prices $\{p_1^{ND}, p_2^{ND_2}\}$ for $\phi_1 \leq \phi < \phi_2$ and $\{p_1^{ND}, p_2^{ND_1}\}$ for $\phi < \phi_1$ as defined by (4.5).

We represent these findings in Figure 4.3.1 where the axes are (τ, ϕ) for a given investment level I .

Figure 4.3.1: Seed producer strategies under a PBR regime

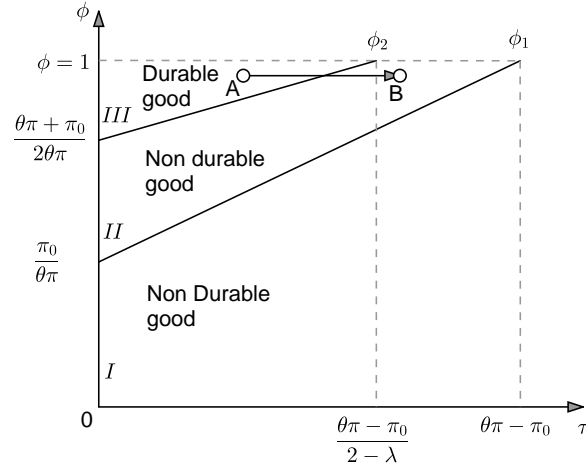

There are three different areas in Figure 4.3.1. In area (I), which corresponds to low values of the productivity of the self-producing farmers, the seed producer adopts non-durable good strategy 1 with prices $\{p_1^{ND}, p_2^{ND_1}\}$. In area (II), for higher values of the productivity ϕ and a level of the tax that is not too high, he adopts non-durable good strategy 2 with prices $\{p_1^{ND}, p_2^{ND_2}\}$, where the second-period price is smaller than $p_2^{ND_1}$. In area (III), for high values of ϕ and relatively low levels of the tax, the seed producer adopts a durable good strategy $\{p_1^D, p_2^D\}$.

For a given level of self-producing farmer's productivity ϕ , we analyze the effect of a change in the tax level τ . For a relatively high level of ϕ , as the tax τ increases (from A to B in Figure 4.3.1) the welfare W^D as defined by (4.4) first decreases, and then jumps to W^{ND} as defined by (4.8) where it is constant. Initially, as a durable good strategy is adopted, the seed producer's benefit Π^D as defined by (4.3) decreases as τ increases, whereas the farmers' benefit, $2\pi_0$, is not affected by a change in τ . The total welfare is reduced due to the reduction in the seed producer's benefit.

At some point, the durable good strategy is no longer profitable and the seed producer switches to a non-durable good strategy in which both benefits are affected by an increase in τ (the farmers' benefit is reduced whereas the seed producer's benefit increases). Yet, these effects cancel out and the tax has no impact on the total welfare.

Therefore as τ increases, if we start from relatively small values of τ , welfare will not be initially enhanced. As we change of regime, welfare increases.

Overall, the welfare is a non-monotonic function of the tax τ . If the tax is set at a relatively low level and the public authority is considering increasing it to benefit the seed producer, the effect might not be the one expected as the seed producer will initially be hurt by this increase.

4.3.2 Patent Regime

Under a patent regime, the durable good strategy is ruled out as farmers cannot self-produce in the second period. The available pricing strategy is thus a non-durable strategy $\{p_1^P, p_2^P\}$ in which the seed producer sets the prices such that

$$p_1^P = p_2^P = \theta\pi - \pi_0. \quad (4.10)$$

The seed producer's gross payoff is

$$\Pi_g^P = 2(\theta\pi - \pi_0),$$

the farmers get $2\pi_0$, and the gross social welfare is thus

$$W_g^P = 2\theta\pi.$$

The social welfare in case of patenting includes the patenting cost as well, such that the net social welfare is

$$W^P = 2\theta\pi - c_P. \quad (4.11)$$

This case is similar to non-durable good strategy 1. We summarize the pricing strategy under a patent regime in the following Lemma.

Lemma 2 *Under a patent regime, an unique pricing strategy $\{p_1^P, p_2^P\}$ as defined by (4.10) is adopted in equilibrium by the seed producer.*

4.3.3 Choice between PBRs and Patents

If both methods of protection are available, once the seed innovation has been discovered and the value θ has been realized (i.e., either a small innovation, $\underline{\theta}$, or a large one, $\bar{\theta}$), the seed producer must decide whether to patent it or to protect it with a PBR. In the former case, he must pay a patenting cost c_P , and thus, his patenting payoff is

$$\Pi^P = 2(\theta\pi - \pi_0) - c_P, \quad (4.12)$$

that must be compared with the payoff he would get from getting a PBR instead of a patent: Π^D as defined by (4.3) if a durable good strategy is adopted or Π^{ND_1} or Π^{ND_2} as defined by (4.6) and (4.7) if a non-durable good strategy is adopted.

Not surprisingly, our findings depend on the patenting cost. For a relatively high patenting cost, $c_P \geq (\theta\pi - \pi_0)/2$, the seed producer never patents as a patent is too costly. However, for lower values of the patenting cost, $c_P < (\theta\pi - \pi_0)/2$, the seed producer will sometimes decide to patent. When self-producing farmers are not very productive, i.e., $\phi < \phi_1$ (area (I) in Figure 4.3.1), the seed producer will never patent as patenting and using a PBR generate the same gross payoff. Indeed, the seed producer sells his seed as a non-durable good even in the case of a PBR as farmers have a high loss in productivity if they self-produce.

When self-producing farmers are more productive, for $\phi_1 < \phi < \phi_2$ (area (II) in Figure 4.3.1), the seed producer prefers to patent if $\Pi^P > \Pi^{ND_2}$ or, equivalently, for $\phi > \phi_1^P$, where

$$\phi_1^P \equiv \frac{\pi_0 + c_P + \tau}{\theta\pi}. \quad (4.13)$$

In this case, the seed producer who adopts a non-durable good strategy with a PBR must reduce his second-period price to make sure farmers do not self-produce, which makes this strategy less attractive than patenting. However, because patenting is costly, there is an area in which the seed producer is better off by using a PBR, for $\phi_1 < \phi < \phi_1^P$.

Finally, when self-producing farmers are very efficient, for $\phi_2 < \phi < \phi_1$, (area (III) in

Figure 1), the seed producer prefers to patent if $\Pi^P > \Pi^D$ or, equivalently, for $\phi < \phi_2^P$, where

$$\phi_2^P \equiv \frac{\theta\pi - c_P + \tau(1 - \lambda)}{\theta\pi}. \quad (4.14)$$

In this case, the durable good strategy adopted by the seed producer when he chooses a PBR is more profitable than patenting if self producing farmers have a high productivity. This allows the seed producer to increase his first-period price.

Figures 4.3.2(a) and 4.3.2(b) below illustrate these findings for different values of c_P . Figure 4.3.2(a) represents the case where the patenting cost is not too high, i.e., $c_P < (1 - \lambda)(\theta\pi - \pi_0)/(2 - \lambda)$, whereas Figure 4.3.2(b) represent the case where $(1 - \lambda)(\theta\pi - \pi_0)/(2 - \lambda) < c_P < (\theta\pi - \pi_0)/2$. If patenting is too costly, the area where the seed producer patents will shrink, as it becomes less attractive to patent.

Figure 4.3.2: Seed producer strategies under both PBR and patent regimes

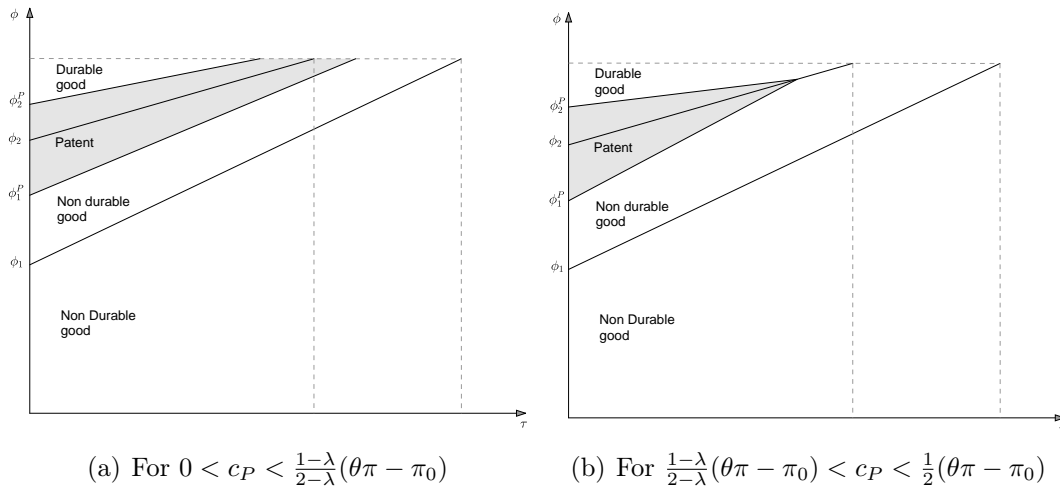

In what follows we assume that, for any level of θ , the patenting cost is such that

$$0 < c_P < \frac{1 - \lambda}{2 - \lambda}(\theta\pi - \pi_0), \quad (4.15)$$

and, therefore, we only consider the situation represented by Figure 4.3.2(a)¹⁵

15. The findings in the case of Figure 4.3.2(b) are qualitatively similar to those of Figure 4.3.2(a)

We summarize these findings in the following Proposition.

Proposition 1 *When both patent and PBR regimes are available, and if the patenting cost satisfies (4.15), the seed producer prefers a patent over a PBR*

- *when $\phi > \phi_1^P$ if a non-durable good strategy is preferred under the PBR regime,*
- *when $\phi < \phi_2^P$ if a durable good strategy is preferred under the PBR regime.*

Even for a relatively low patenting cost, the seed producer might prefer to let farmers self-produce. From these findings we can directly derive the following Corollary.

Corollary 1 *When both patent and PBR regimes are available, self-production is not completely eliminated.*

If we consider initially a regime with only PBRs as it is the case in Europe, the introduction of a patent regime will not completely eliminate self-production as, for some values of the parameters, the seed producer will still prefer to protect his invention with a PBR rather than a more expensive patent.

In our model, the option of patenting the seed innovation reduces the likelihood of adopting a durable good strategy even though the patent system does not fully prevent self-production by farmers.

Furthermore, for a relatively high level of ϕ (relatively low loss in productivity from self-producing), as τ increases, the welfare W^D as defined by (4.4) first decreases, then it is constant at W^P as defined by (4.11) before it jumps to W^{ND} as defined by (4.8) when finally a non-durable good strategy is adopted.

If the public authority sets initially a too low level of τ , the welfare will be far from being maximized. Then, by increasing the tax, the welfare will first go down before it gets to its maximum level.

4.4 Research Investment Decision

At the outset of the game, the seed producer makes an investment decision that occurs before the realization of the increase in productivity is known. Therefore, based on the findings of the previous section, for each potential increase in productivity $\underline{\theta}$ and $\bar{\theta}$ we define the equilibrium payoffs. We first consider the case where only PBRs are allowed, and then the case where both patent and PBR regimes are available.

4.4.1 Plant Breeder Right Regime

For a given size of the seed innovation $\theta \in \{\underline{\theta}, \bar{\theta}\}$ we have determined the pricing strategies of the seed producer when he protects his innovation with a PBR in the previous section. In order to calculate the optimal investment of the seed producer, we identify his pricing strategies for $\underline{\theta}$ and $\bar{\theta}$ and the corresponding payoffs for any possible ϕ and τ . It also implies that the cut-off values ϕ_1 and ϕ_2 as defined by (4.2) and (4.9) depend also on $\underline{\theta}$ and $\bar{\theta}$ such that there are now four cut-off values, $\bar{\phi}_1$, $\bar{\phi}_2$, $\underline{\phi}_1$ and $\underline{\phi}_2$.

The findings in the case of a PBR regime are illustrated in Figure 4.4.1

Figure 4.4.1: Seed producer strategies under a PBR regime with $\theta \in [\underline{\theta}, \bar{\theta}]$

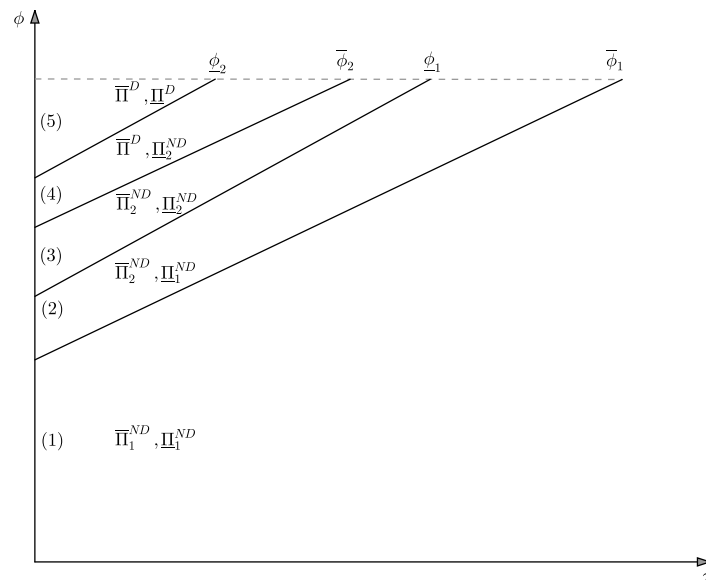

Figure 4.4.1 is similar to Figure 4.3.1, except that we have to consider the four cut-off values $\bar{\phi}_1$, $\bar{\phi}_2$, $\underline{\phi}_1$ and $\underline{\phi}_2$. As $\underline{\theta} < \bar{\theta}$, $\underline{\phi}_1 > \bar{\phi}_1$ and $\underline{\phi}_2 > \bar{\phi}_2$. Notice that in Figure 4.4.1 we assume that $\bar{\phi}_2 > \underline{\phi}_1$ which is equivalent to assume that

$$\bar{\theta} < (2 - \lambda)\underline{\theta} - (1 - \lambda)\frac{\pi_0}{\pi}. \quad (4.16)$$

Condition (4.16) is obtained by insuring that the value of τ such that $\bar{\phi}_2 = 1$ is smaller than the value of τ such that $\underline{\phi}_1 = 1$. If the condition is satisfied, then for any values of $\phi < 1$, $\bar{\phi}_2 > \underline{\phi}_1$. This assumption states that the large innovation is not too large compared to the small one. Relaxing this assumption does not change the qualitative nature of our findings, while it does add many cases.

We now determine the benefit functions for the five different areas defined in Figure 4.4.1

In area (1), for each value of θ , the seed producer will adopt the same non-durable good strategy 1 with associated prices $\{\bar{p}_1^{ND}, \bar{p}_2^{ND1}\}$ and $\{p_1^{ND}, p_2^{ND1}\}$. If a small innovation $\underline{\theta}$ has been discovered, the seed producer obtains a benefit

$$\underline{\Pi}^{ND1} = 2(\underline{\theta}\pi - \pi_0),$$

whereas he gets

$$\bar{\Pi}^{ND1} = 2(\bar{\theta}\pi - \pi_0)$$

if a large innovation $\bar{\theta}$ has been discovered.

In area (2), the seed producer who has discovered a small innovation adopts the same non-durable good strategy 1 as before with associated prices $\{p_1^{ND}, p_2^{ND1}\}$ that generates a payoff $\underline{\Pi}^{ND1}$, while if he has discovered a large innovation he adopts the other non-durable good strategy 2 with prices $\{\bar{p}_1^{ND}, \bar{p}_2^{ND2}\}$ and obtains

$$\bar{\Pi}^{ND2} = \bar{\theta}\pi(2 - \phi) - \pi_0 + \tau.$$

In area (3), the strategies adopted by the seed producer are the same: the non-

durable good strategy 2 with prices $\{\bar{p}_1^{ND}, \bar{p}_2^{ND_2}\}$ and $\{\underline{p}_1^{ND}, \underline{p}_2^{ND_2}\}$ and the benefits are $\bar{\Pi}^{ND_2}$ and

$$\underline{\Pi}^{ND_2} = \underline{\theta}\pi(2 - \phi) - \pi_0 + \tau.$$

In area (4), a seed producer who has discovered a large innovation adopts a durable good strategy with prices $\{\bar{p}_1^D, \bar{p}_2^D\}$ and obtains

$$\bar{\Pi}^D = \bar{\theta}\pi(1 + \phi) - \tau(1 - \lambda) - 2\pi_0.$$

In the case of a small innovation, the seed producer adopts the previous non-durable good strategy with prices $\{\underline{p}_1^{ND}, \underline{p}_2^{ND_2}\}$ and gets $\underline{\Pi}^{ND_2}$.

In the last area (5), the seed producer adopts a durable good strategy for any size of the innovation and, thus, the benefits are $\bar{\Pi}^D$ for a large innovation and

$$\underline{\Pi}^D = \underline{\theta}\pi(1 + \phi) - \tau(1 - \lambda) - 2\pi_0$$

for a small innovation.

We set τ at a given relatively small value. For low values of the self-productivity parameter of the farmers, both small and large seed innovations generate the same non-durable good strategy 1. As ϕ increases, both types of innovator still adopt a non-durable good strategy, except that now the seed producer who has discovered a large innovation must reduce his second-period price in order to prevent self-production. Indeed, as the innovation is larger, it will generate a higher benefit to farmers who have more incentive to self-produce.

As some point, as ϕ keeps increasing, the seed producer with the large innovation switches to a durable good strategy as it is not worth trying to prevent self-production, while a small innovation still generates a non-durable good strategy. Eventually, when ϕ is very high, only a durable good strategy is adopted.

As different strategies are adopted depending on the size of the innovation, the investment decisions will be different in each of the areas defined in Figure 4.4.1. For

instance, in area (1), the seed producer chooses I that solves

$$\max_I \{\mu(I)\bar{\Pi}^{ND_1} + (1 - \mu(I))\underline{\Pi}^{ND_1} - I\},$$

which gives the following first order condition

$$\mu'(I)2(\bar{\theta} - \underline{\theta})\pi - 1 = 0.$$

We denote $I^{\overline{ND}_1, \underline{ND}_1}$ the optimal level of investment when the non-durable strategy 1 is adopted.

In area (2), the seed producer still adopts non-durable good strategy 1 when he has discovered a small innovation, but he now adopts non-durable good strategy 2 when he has discovered a large innovation. Therefore, *ex ante*, he chooses I that solves

$$\max_I \{\mu(I)\bar{\Pi}^{ND_2} + (1 - \mu(I))\underline{\Pi}^{ND_1} - I\},$$

which gives the first order condition

$$\mu'(I)[2(\bar{\theta} - \underline{\theta})\pi + \pi_0 + \tau - \bar{\theta}\phi\pi] - 1 = 0.$$

We denote $I^{\overline{ND}_2, \underline{ND}_1}$ the optimal level of investment solution of this program.

For each of the five areas defined in Figure 4.4.1 we determine the optimal level of investment I (see appendix A for calculations). Even without more specification on the function $\mu(I)$, we can compare all the investments derived in each of the five different cases. We represent these investments as a function of τ in Figure 4.4.2 for relatively high value of ϕ , i.e., $\phi > (\underline{\theta}\pi + \pi_0)/2\underline{\theta}\pi$.

Figure 4.4.2: Optimal Investment under a PBR regime

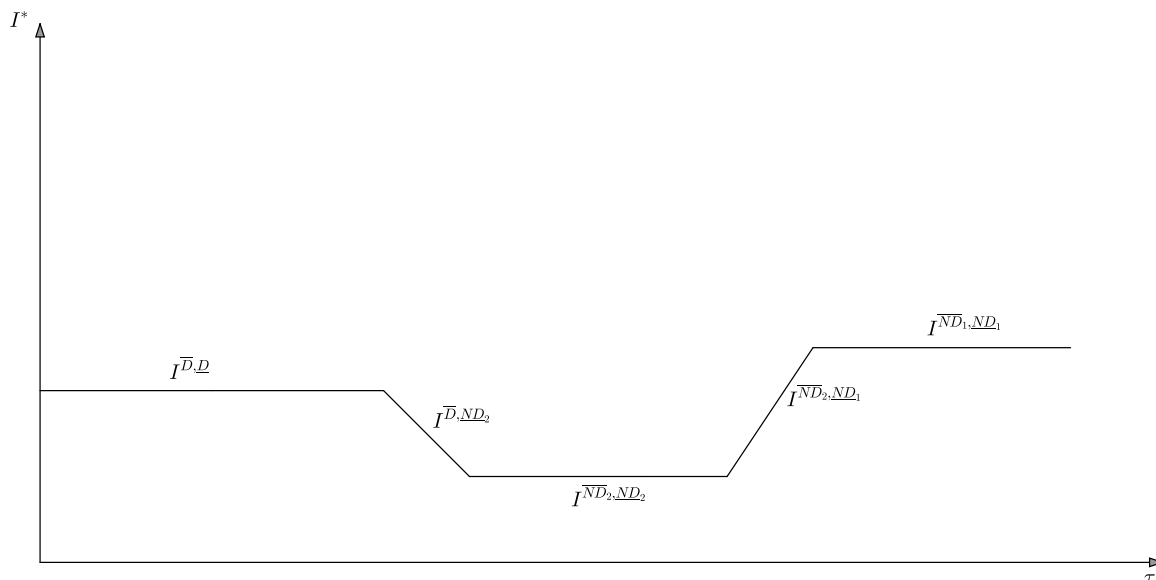

The optimal investment function has some kind of U-shape. For low values of τ , as the durable good strategy is adopted no matter what the innovation size is, there is no extra gain in having a large innovation as $d(\bar{\Pi}^D - \underline{\Pi}^D)/d\tau = 0$. The optimal investment is independent of τ as there is no extra benefit from having a large innovation, so the seed producer does not have to change his investment as τ increases. Thus, the seed producer does not intensify his R&D investment.

As τ increases, non-durable good strategy 2 becomes more attractive to the seed producer who has discovered a small innovation, while the durable good strategy is still adopted by a seed producer who has discovered a large innovation. In this area, the extra gain from having a large innovation decreases with τ as $d(\bar{\Pi}^D - \underline{\Pi}^{ND_2})/d\tau < 0$ and, therefore, the seed producer reduces his R&D investment.

Then, we reach an area where the seed producer who has discovered either a large or a small innovation decides to adopt non-durable good strategy 2 and, in this case, there is no gain from having a large innovation. The optimal investment becomes again independent of τ .

As non-durable good strategy 1 becomes more attractive to the seed producer with

Figure 4.4.3: Private and social optimal Investment under a PBR regime

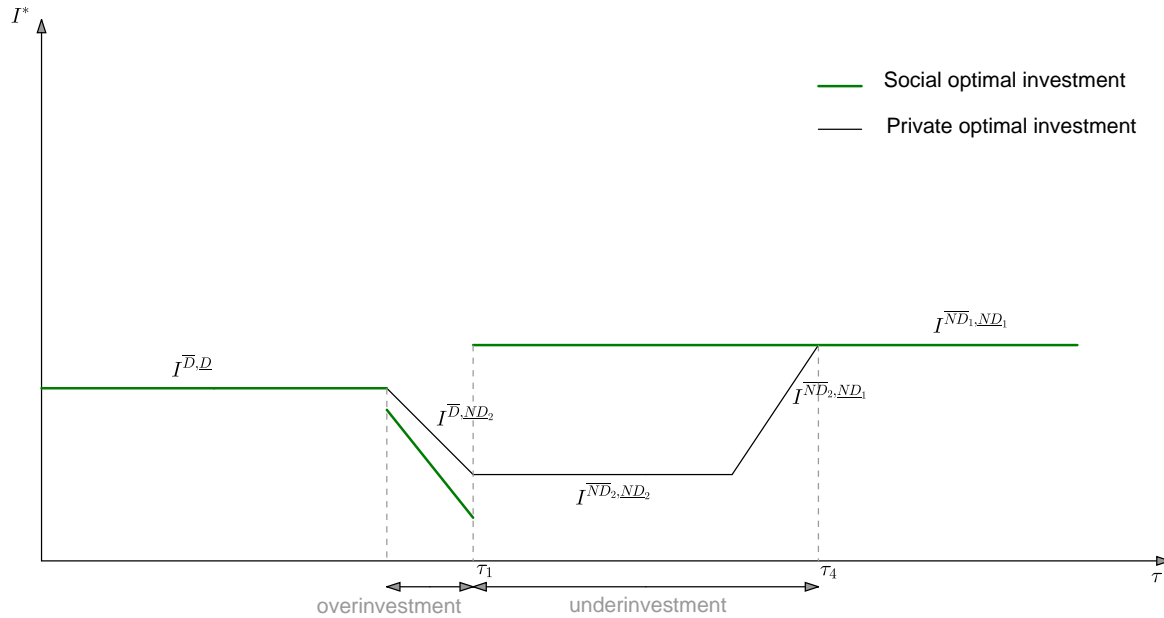

a small innovation, the extra gain from having a large innovation increases with τ as $d(\bar{\Pi}^{ND_2} - \underline{\Pi}^{ND_1})/d\tau > 0$. Then, for relatively large values of τ , non-durable good strategy 1 is adopted for large and small innovations and the investment is constant at its maximum level.

We summarize these findings in the following Lemma.

Lemma 3 *Under a PBR regime, the optimal research investment level is first constant, then decreases, increases and reaches its maximum level as τ increases.*

These optimal levels of research investment can be compared to the socially optimal levels of investment that maximize the total welfare. For each area of Figure 4.4.1 we determine the total welfare depending on the size of the innovation and then we calculate the socially optimal investments (see appendix for the calculations). The findings are reported in Figure 4.4.3

When τ is small (which corresponds to area (5) in Figure 4.4.1) or very big (area (1) in Figure 4.4.1), both levels of privately and socially optimal investment are identical.

The maximum level of investment is reached for high values of τ .

For intermediate values of τ (areas (2) and (3) in Figure 4.4.1), the seed producer underinvests in research. In fact, when the seed producer adopts non-durable good strategy 2 for all innovation size, farmers benefit from a larger innovation. So, from a social viewpoint, it will be optimal to try to get a larger innovation. Overall, society will benefit from a larger innovation, which is why the seed producer underinvests.

In area (4) (in Figure 4.4.1) the seed producer overinvests compared to what is socially optimal. In this area, the seed producer uses a durable good strategy when he discovers a large innovation and non-durable good strategy 2 when he discovers a small innovation. The benefit of the farmers is lower under the durable good strategy than the non-durable good strategy as $2\pi_0 < \pi_0 + \phi\theta\pi - \tau$ is always satisfied.

Thus, the welfare gain from having a large innovation is smaller than the gain of the seed producer. In other words, there is less incentive from a social viewpoint in trying to obtain a larger innovation than from the private viewpoint. Therefore, the seed producer overinvests.

We summarize our findings in the following Proposition.

Proposition 2 *Under a PBR regime, the seed producer can underinvest or overinvest in research compared to what is socially optimal depending on the value of τ .*

To summarize, when farmers benefit from a large innovation, the seed producer underinvests, whereas when they do not benefit from having a large innovation, the seed producer overinvests.

4.4.2 Patent and Plant Breeder Right Regimes

If both patent and PBR systems are available, the seed producer might decide to patent his innovation instead of protecting it with a PBR. If he has discovered a small innovation, his payoff from patenting is

$$\underline{\Pi}^P = 2(\theta\pi - \pi_0) - c_P,$$

whereas it is

$$\bar{\Pi}^P = 2(\bar{\theta}\pi - \pi_0) - c_P,$$

if he has discovered a large innovation.

In each of the five areas defined in Figure 4.4.1, we compare the benefit of the seed producer if he protects his innovation with a patent or a PBR. In area (1), where non-durable good strategy 1 is always adopted under a PBR regime whatever the size of the innovation, the patenting strategy is never preferred to a PBR as, for any θ , the inequality $2(\theta\pi - \pi_0) - c_P > 2(\theta\pi - \pi_0)$ is always satisfied for $c_P > 0$. In other words, patenting or choosing a PBR lead to identical gross payoffs but patenting is costlier.

In area (2), when the innovation is small, a PBR is always preferred to a patent whereas a patent is preferred to a PBR when the innovation is large for $\phi > \phi_1^P(\bar{\theta})$. In area (3), patenting a large innovation can make the seed producer better off if $\phi > \phi_1^P(\bar{\theta})$, but also patenting a small innovation can be chosen for $\phi > \phi_1^P(\underline{\theta})$.

In area (4), the seed producer will patent his large innovation if $\phi < \phi_2^P(\bar{\theta})$, and his small innovation if $\phi > \phi_1^P(\underline{\theta})$. In area (5), patenting will occur if $\phi < \phi_2^P(\theta)$. We assume further that

$$(\bar{\theta} - \underline{\theta})\pi < c_P < \frac{1 - \lambda}{2 - \lambda}(\underline{\theta}\pi - \pi_0) - \frac{(\bar{\theta} - \underline{\theta})}{2 - \lambda}\pi \quad (4.17)$$

We represent these different areas in Figure 4.4.4

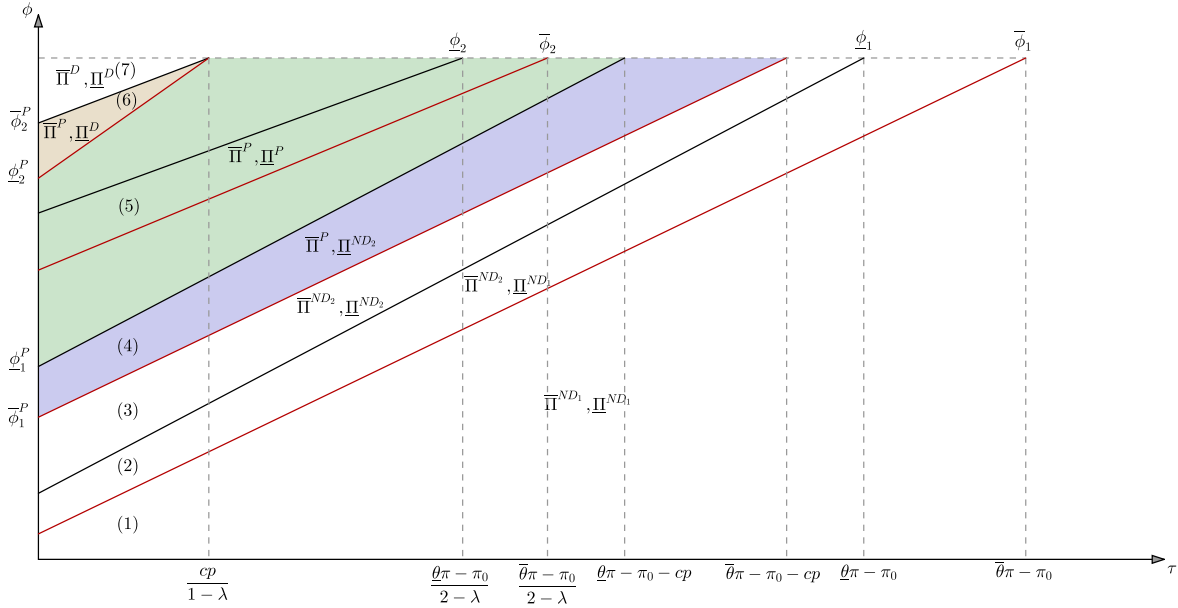
Figure 4.4.4: Seed producer strategies under both PBRs and patent regimes with $\theta \in \{\underline{\theta}, \bar{\theta}\}$ 

There are now seven different areas as, depending on the size of the innovation, the seed producer might choose different protection. Indeed, in areas (4) and (6), a large innovation will be protected with a patent whereas a small one will be protected with a PBR. The size of the innovation will impact the patenting decision.

In each area defined in Figure 4.4.4, we determine the investment decision of the seed producer (see the appendix for all the investment levels). For instance, in area (4), the seed producer chooses I that solves

$$\max_I \{ \mu(I) \bar{\Pi}^P + (1 - \mu(I)) \underline{\Pi}^{ND_2} - I \}.$$

We denote $I^{\bar{P}, ND_2}$ the optimal level of investment solution of this program.

To clarify the impact of the tax, we choose a high level of ϕ in order to have the seven cases, and we represent the evolution of the optimal investment as a function of τ in Figure 4.4.5 (similar to Figure 4.4.2).

Figure 4.4.5: Optimal investment under both PBRs and patent regimes

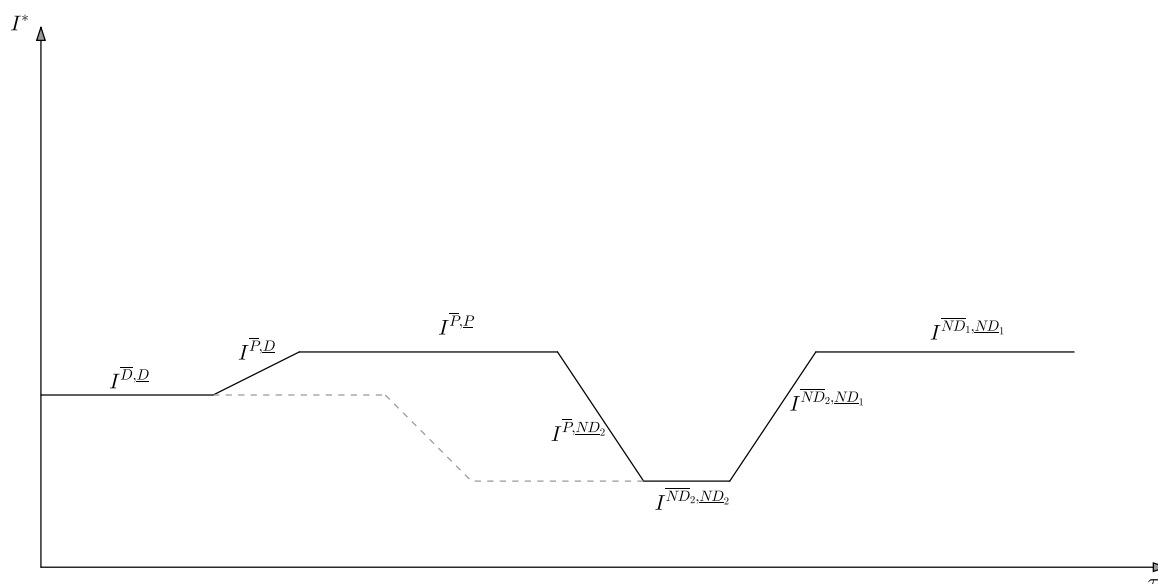

When the seed producer can choose between a patent and a PBR, the optimal investment is higher than under a strict PBR regime. When the seed producer finds it worthwhile to patent a large innovation but still to use a durable good strategy with a PBR for a small innovation, the investment is increasing with τ . When the seed producer patents both small and large innovations, the investment is at its highest level, the same as under a PBR regime with non-durable good strategy 1. However, when the seed producer patents his large innovation and uses a non-durable good strategy for his small innovation, his investment decision is decreasing function with τ . We summarize these findings in the following Lemma.

Lemma 4 *When both patent and PBR regimes are available, the optimal research investment is a non-monotonic function of τ . Overall, the investment level is higher than under a PBR regime alone.*

If the PBR regime is the only regime that is available (as it is the case in Europe), the optimal investment levels are lower than if both patent and PBR regimes are available. Thus, the introduction of the patent regime allows to intensify the research investment.

We now compare the optimal private investment levels with the socially optimal levels of investment. We find that the seed producer can over or under invest (see appendix for the calculations and comparisons) as illustrated in Figure 4.4.6

Figure 4.4.6: Private and social optimal investment under both PBRs and patent regimes

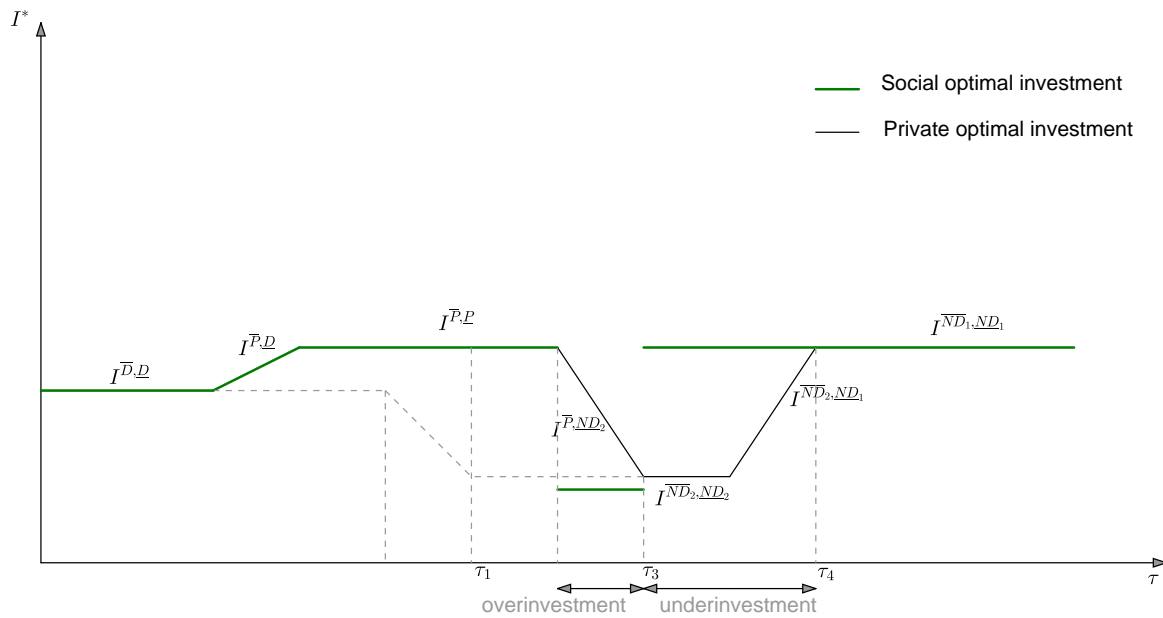

We summarize these findings in the following Proposition.

Proposition 3 *Under both PBR and patent regimes, the seed producer can overinvest or underinvest in research compared to what is socially optimal depending on the value of τ*

For low and high values of τ , the private and socially optimal levels of investment coincide.

For intermediate values of τ , the seed producer will overinvest or underinvest. In area (4) in Figure 4.4.4, the seed producer protects his innovation with a patent when

he has discovered a large innovation and uses non-durable good strategy 2 if it is a small innovation. From a society viewpoint, the seed producer should not invest too much. This is due to the fact that if he finds a small innovation, the seed producer must reduce his second-period price to prevent farmers to self-produce, which makes farmers better off. Thus, farmers gain less from a patented large innovation than a small innovation with non-durable good strategy 2. Overall, society does not benefit from a large innovation.

On the other hand, from the viewpoint of the seed producer, even though his investment is decreasing with τ , he still invests more than what would be socially optimal.

In areas (2) and (3) in Figure 3.2, the seed producer uses non-durable good strategies and will underinvest. In area (3), the seed producer has less to gain from a large innovation than does society. Farmers benefit from non-durable good strategy 2 more than the seed producer. In area (2), even though the seed producer uses non-durable good strategy 1 with a small innovation, society still gains more from a large innovation than does the seed producer.

Under both PBR and patent regimes, the seed producer will less likely underinvest compared to the case with only a PBR regime. We summarize this finding in the following corollary.

Corollary 2 *The seed producer underinvests for*

- $\tau \in [\tau_1, \tau_4]$ under a PBR regime
- $\tau \in [\tau_3, \tau_4]$ under both PBR and patent regimes with $\tau_3 > \tau_1$

The rationale for analyzing the investment decisions as a function of τ is to consider systems where a tax is paid by self-producing farmers to the seed producer. However, countries such as Canada and the U.S. do not have a royalty or tax system yet. Furthermore, in the U.S. both patent and PBR regimes coexist, and they are both used by seed companies.

To understand why a seed company will use both IPR systems, we assume that $\tau = 0$, and, in a graph (c_P, ϕ) we first analyze the patenting and PBR decisions with

the associated pricing decisions that we represent in Figure 4.4.7

Figure 4.4.7: Seed producer strategies under both PBR and patent regimes

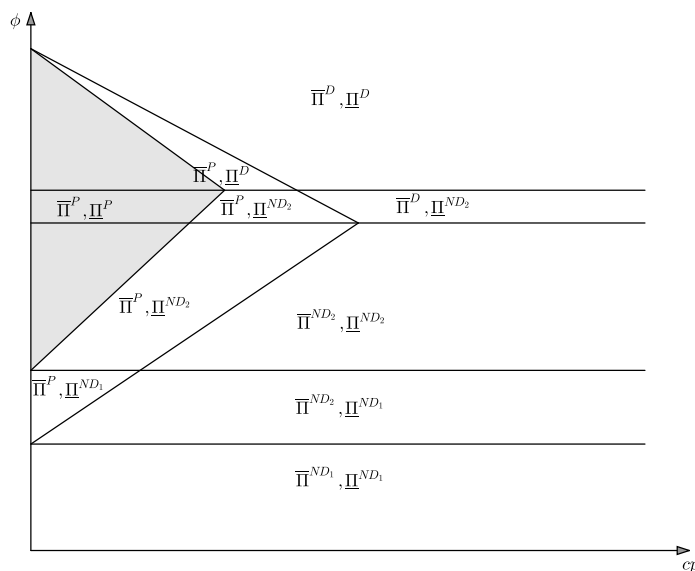

For a given patenting cost c_P that satisfies (4.15) with $\tau = 0$, the seed producer prefers a patent over a PBR for intermediate values of ϕ . When self-producing farmers are very productive (high ϕ), the seed producer adopts a durable strategy with a PBR for any size of his innovation. For very unproductive self-producing farmers (low ϕ), the seed producer always adopts non-durable good strategy 1.

For intermediate values of ϕ , he patents his large innovation, whereas he uses either a non-durable good strategy or a durable good strategy for his small innovation, depending on the value of ϕ .

Thus, overall, the seed producer has a tendency to patent large innovations whereas he will prefer to use a PBR for small innovations.

In terms of investment, patenting boosts the investment compared to the case with only a PBR regime. The investment as a function of ϕ has also a U-shape form with only a PBR regime, and it is a non-monotonic function when both patent and PBR regimes coexist (see Figure 4.4.8 and Appendix for the analysis of this case).

Figure 4.4.8: Private and social optimal investments under both PBR and patent regimes

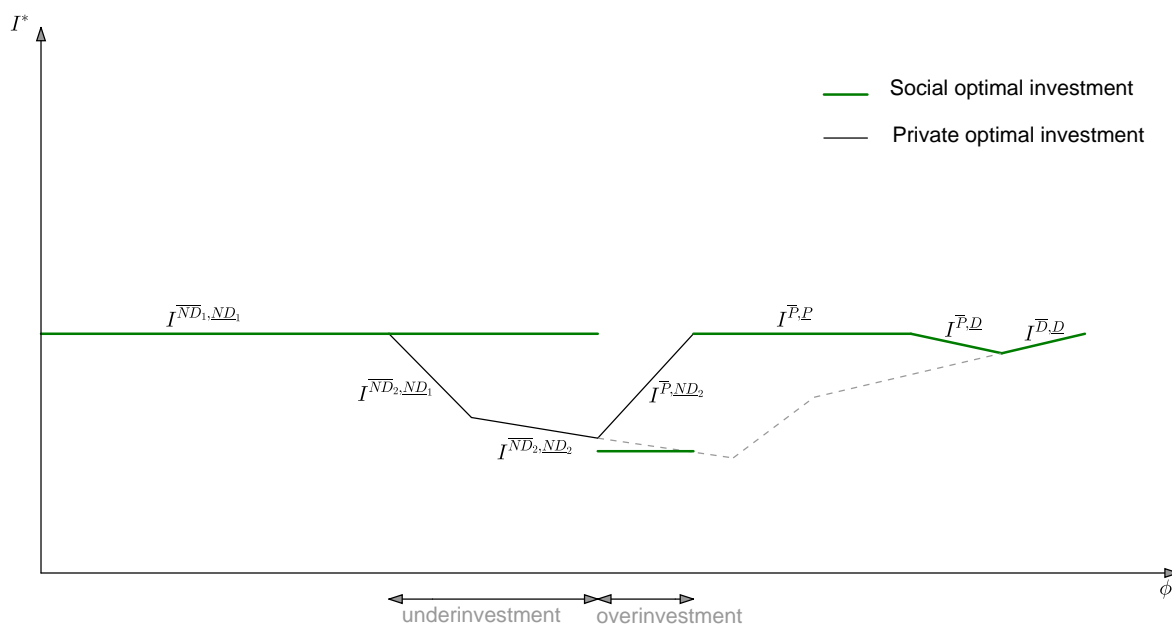

4.5 Incentive to Innovate and Welfare

In this section, we first characterize the incentive to innovate of the seed producer and, then, we analyze the impact of the optimal private investment on social welfare. In order to calculate both profit and welfare functions evaluated at each of the optimal levels of investment, we consider the following functional form¹⁶

$$\mu(I) = (1 - \exp^{-I}), \quad (4.18)$$

which satisfies the conditions $\mu'(I) > 0$, $\mu''(I) < 0$ and $\mu(0) = 0$.

4.5.1 Incentive to Innovate

We use the traditional definition of “pure” incentive to innovate (Arrow, 1962), which corresponds to the difference in profits that the seed producer can earn if he invests

16. As a robustness check, we also consider another function in the extension.

in R&D compared to what he would earn if he did not invest. In our setting, not investing in R&D corresponds to selling the old seed in a perfectly competitive market and obtaining a null payoff. Therefore, the incentive to innovate is represented by the *ex ante* expected profit of the seed producer which is

$$\mu(I)\bar{\Pi} + (1 - \mu(I))\underline{\Pi} - I,$$

evaluated at each optimal level of investment and corresponding profit $\bar{\Pi}$ and $\underline{\Pi}$.

Under a PBR regime, in area (1) in Figure 4.4.1, the *ex ante* expected profit of the seed producer is

$$\begin{aligned} \Pi^{\overline{ND}_1, \underline{ND}_1} &= \mu(I^{\overline{ND}_1, \underline{ND}_1})\bar{\Pi}^{ND_1} + (1 - \mu(I^{\overline{ND}_1, \underline{ND}_1}))\underline{\Pi}^{ND_1} - I^{\overline{ND}_1, \underline{ND}_1} \\ &= \mu(I^{\overline{ND}_1, \underline{ND}_1})2(\bar{\theta} - \underline{\theta})\pi + 2(\underline{\theta}\pi - \pi_0) - I^{\overline{ND}_1, \underline{ND}_1}, \end{aligned}$$

which is independent on τ , as $I^{\overline{ND}_1, \underline{ND}_1}$ is independent on τ . For each of the five different areas in Figure 4.4.1 we calculate the different levels of profits that we represent in a graph (τ, π) in Figure 4.5.1 We also consider a high level of ϕ

Figure 4.5.1: Incentive to innovate under a PBR regime

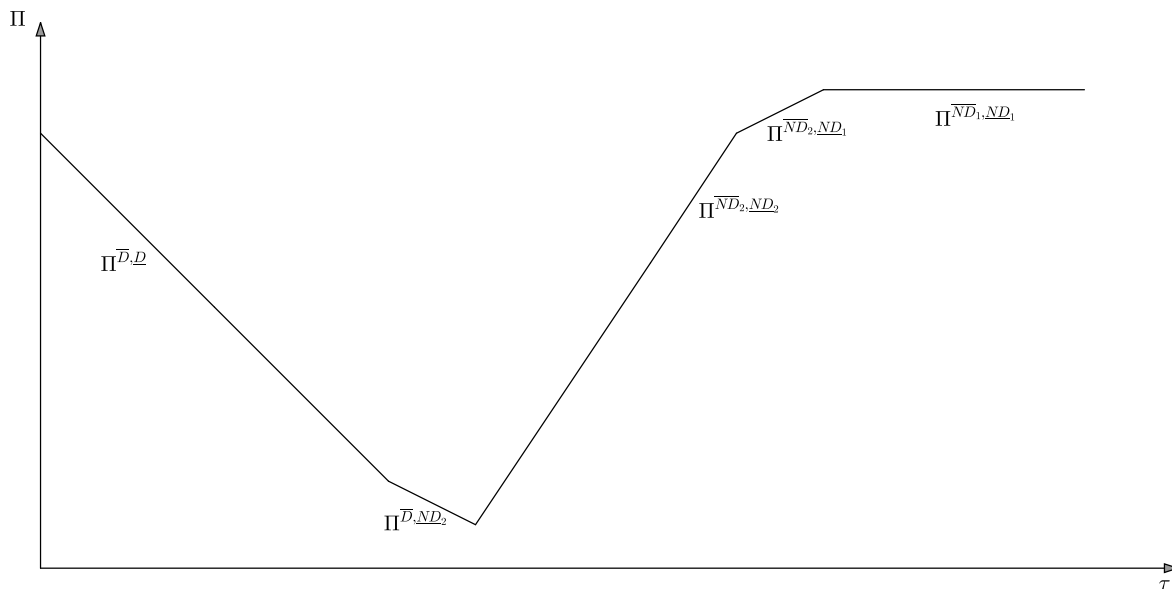

Under a PBR regime, as τ increases, the incentive to innovate first decreases, reaches a minimum level before it increases. The highest incentive to innovate is reached when the seed producer uses non-durable good strategy 1 for both innovation sizes.

Initially, as τ increases the *ex ante* expected benefit of the seed producer decreases through the profits from the small and the large innovation. As more taxes are collected from farmers, the price charged by the seed producer, p_1^D , decreases and so does his payoff. This is due to the fact that the tax collected does not entirely go back to the seed producer, but only a fraction λ .

As τ increases further, the seed producer uses non-durable good strategy 2 for his small innovation and still a durable good strategy for his large innovation. As the tax increases, the profit from a large innovation is reduced through a reduction of \underline{p}_1^D , but the profit from a small innovation increases. However, overall, the negative impact on the large innovation is bigger than the positive impact on the small one. In other words, the loss associated to the large innovation is larger than the gain associated to a small innovation.

As τ increases more, the seed producer uses non-durable good strategy 2 for both types of innovation. As the tax increases, both profits increase. An increase in the *ex ante* expected profit is due to an increase in the small innovation profit.

When it becomes more interesting to use non-durable good strategy 1 for his small innovation, the incentive to innovate still increases but at a smaller rate as only the profit from a large innovation increases with τ .

For larger values of τ , the seed producer always uses strategy non durable strategy 1 for both types of innovation and, thus, his *ex ante* expected profit is not affected by a change in τ anymore.

Due to the different pricing strategies adopted by the seed producer depending on the tax value, the incentive to innovate has a U-shape. Thus, a PBR regime does not necessarily boost research incentive. In fact with an inappropriate tax level, incentive can be reduced.

Under both PBR and patent regimes, we calculate the *ex ante* expected profit for

each of the seven areas in Figure 4.4.4 We graphically illustrate these incentives to innovate in Figure 4.5.2

Figure 4.5.2: Incentive to innovate under both PBR and patent regimes

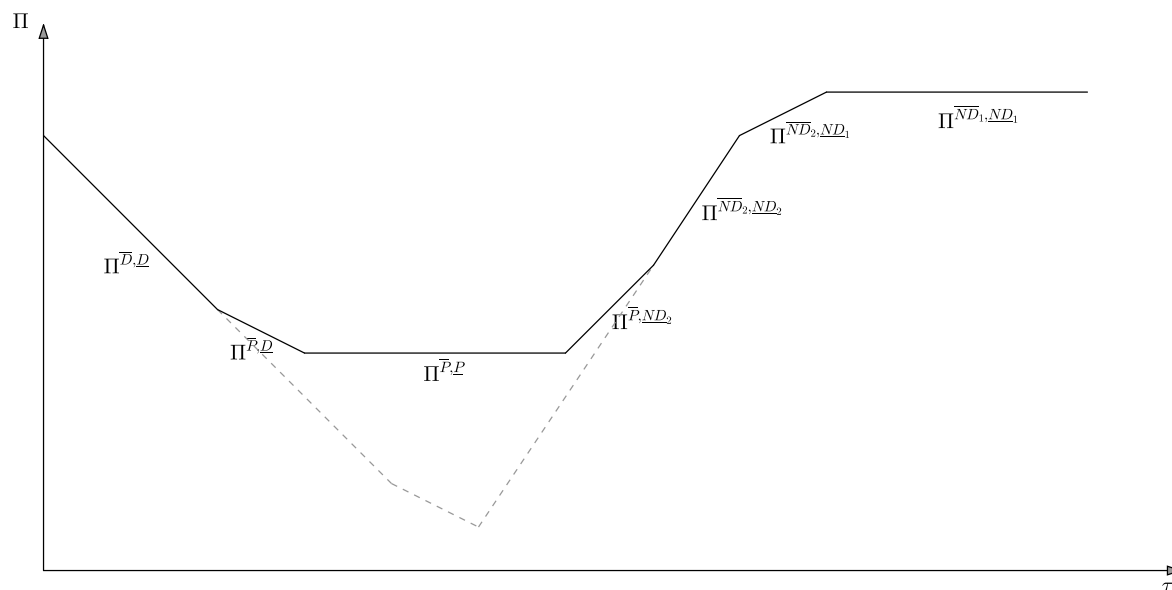

Under both PBR and patent regimes, the incentive to innovate has also a U-shape, but it is higher than in the case of a unique PBR regime. Compared to the previous case where only PBRs are offered, there are three areas for which the incentives differ. In the first one, the seed producer uses a durable good strategy with a PBR for his small innovation while he prefers to patent his large innovation. This still results in a decrease of the incentive but at a lower rate. In fact, the tax increase has only an impact in the small innovation profit, whereas in the case with only PBRs it would affect the profits for both types of innovation.

Then, in the second area where incentives diverge, the seed producer always patents both types of innovation, which makes the expected profit independent of the tax τ . However, because of the patenting cost, this is not the highest incentive level.

In the third area with different incentives, the seed producer uses non-durable good 2 with a small innovation, which increases his incentive to innovate as τ increases.

This increase is entirely due to the small innovation profit. However, this increase is smaller than when the seed producer uses non-durable good strategy 2 for both types of innovations.

Allowing the seed producer to choose between a patent and a PBR to protect his innovation boosts the incentive to innovate compared to the case where he can only use a PBR. Thus, the patent regime restores some of the lack of incentive to innovate. We summarize these results in the following Proposition.

Proposition 4 *The incentive to innovate is initially decreasing with the tax τ , and then it increases. The highest incentive to innovate is reached for high levels of the tax. When both PBR and patent regimes are available, the incentive to innovation is higher than when only a PBR regime is offered.*

An inappropriate level of tax τ will likely have to opposite effect of what it was initially levied for: reduce the incentive to innovate instead of boosting innovation. When setting up a tax level, the public authority should be carefully weighting the different impact of the tax on the seed producer's pricing strategies and protection strategies.

4.5.2 Welfare Analysis

In this section, we calculate the social welfare function evaluated at the privately optimal levels of investment. Based on the specific functional form (4.18), and by using the findings of the previous section in terms of the optimal values of the investment, we plot the welfare function in Figure 4.5.3 in the case of the PBR regime.

Figure 4.5.3: Welfare under a PBR regime

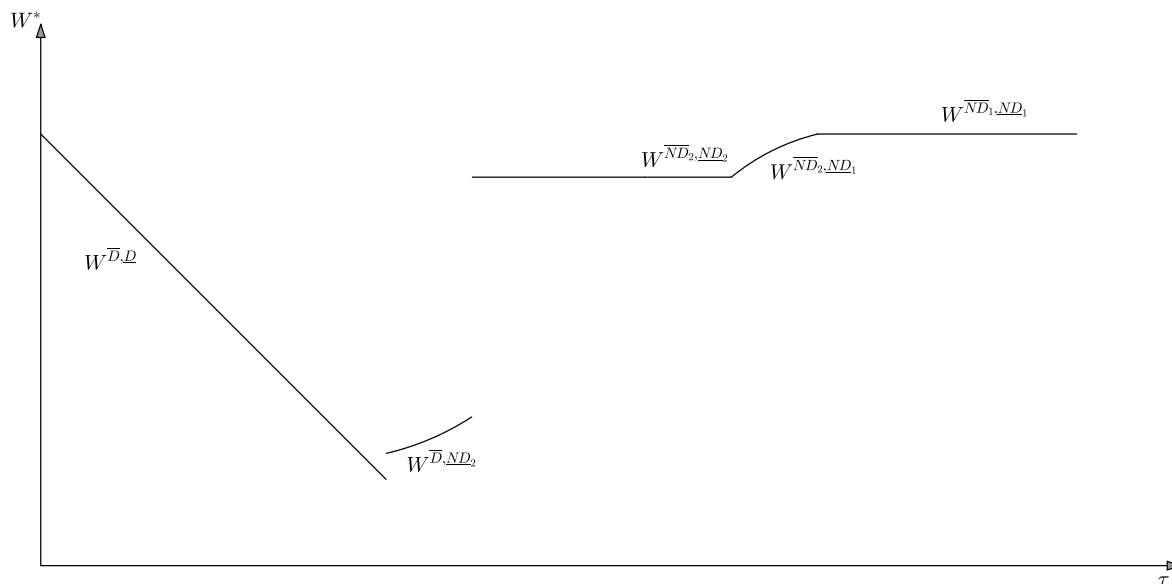

The durable good strategy adopted by the seed producer always reduces the welfare as τ increases. Then, as the seed producer decides to use a non-durable good strategy for a small innovation, the welfare increases in a non-monotonic way until it reaches its maximum when the seed producer uses the same non-durable good 1 for both large and small innovations. Under a PBR regime the welfare is maximum when the seed producer does not allow self-producing, for large values of τ .

When both PBR and patent regimes are available to the seed producer, we represent the welfare function in Figure 4.5.4

Figure 4.5.4: Welfare under both PBR and patent regimes

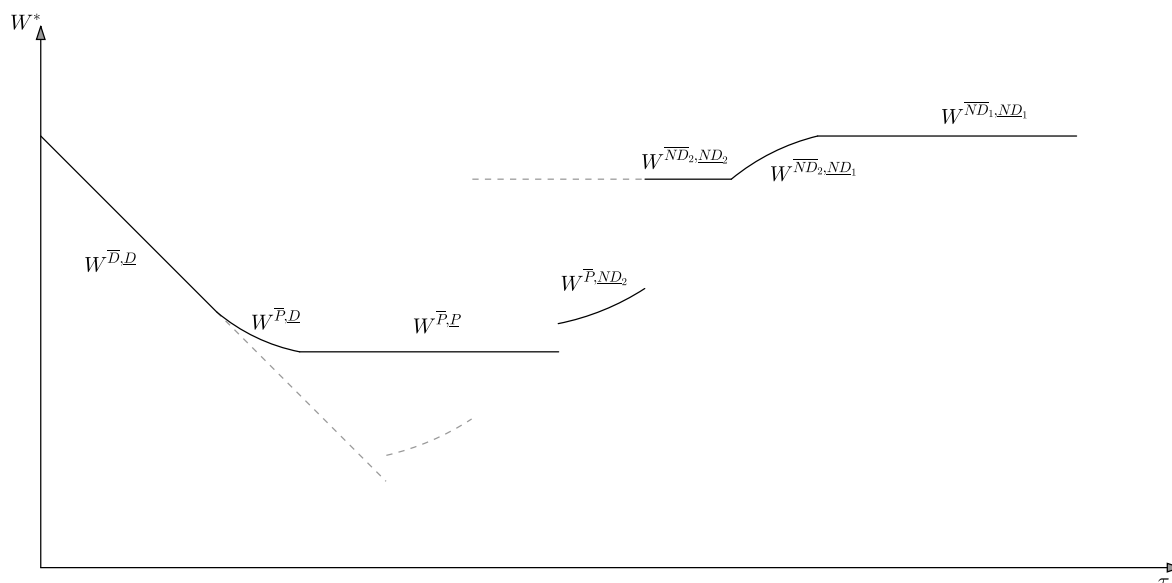

Allowing the seed producer to choose between the two types of IPR does not always enhance welfare. As long as the patenting strategy prevents self-production by farmers (this replaces a durable good strategy), then the welfare is enhanced. Farmers obtain the same surplus ($2\pi_0$) whereas the seed producer gains from patenting. Moreover, when the patenting strategy replaces non-durable good strategy 2, farmers are worse off and, overall, the welfare is reduced. This happens when the seed producer decides to patent a large innovation and uses a PBR with non-durable good strategy 2 for a small innovation. In this case, a rise of τ implies a decrease in both investment and welfare as the probability to obtain a small innovation increases.

We have seen that the maximum investment is obtained for two strategies, patent or PBR when the tax prevents seed saving, whereas the maximum welfare is only reached for a PBR strategy when the fee prevents seed saving.

We summarize these findings in the following Proposition.

Proposition 5 *The welfare is a non-monotonic function of the tax τ , and is not always enhanced when both PBR and patent regimes are offered.*

An efficient combination of PBRs and tax should be such that the tax is high enough so that farmers do not want to self produce, and the seed producer do not use a durable good strategy. In fact, choosing non-durable good strategy 1 with a PBR is equivalent to a patenting strategy, but it is less costly for the seed producer.

4.6 Extensions and Robustness

In this section, we first discuss one extension of the model when farmers are heterogeneous. Second, as a robustness check, we use another functional form for $\mu(I)$ and a different cost function to verify that our findings are similar.

4.6.1 Heterogeneous Farmers

In the analysis of the core of the paper we have assumed that farmers are homogeneous. We now consider that farmers are heterogeneous and, thus, they differ in their loss in productivity ϕ , where ϕ is uniformly distributed between $\underline{\phi}$ and $\bar{\phi}$. The density is $f(\phi)$ and the cumulative function is $F(\phi)$ on $[\underline{\phi}, \bar{\phi}]$ where $F(\bar{\phi}) = 1$. Thus, $F(\phi)$ represents the fraction of farmers with a productivity lower than ϕ . We assume that farmers are myopic, such that they will not anticipate the second-period price. As in the previous section, we first determine the equilibrium prices chosen by the seed producer when his innovation is protected by a PBR or by a patent. Then, we analyze his decision to patent or use a PBR.

Price equilibrium

When the seed innovation is protected with a PBR, two pricing strategies can be used by the seed producer: a non-durable good strategy or a durable good strategy.

With the durable good strategy, each farmer's behavior depends on his level of productivity ϕ . A farmer who has a very high productivity level ϕ (or a low level of productivity loss) might be willing to pay a high price in the first period and to self-produce in the second period, whereas a farmer with a low productivity might choose

to buy the old seed in the first period and the new seed in the second period. However, he will choose the new seed in the second period only if $\theta\pi - p_2 \geq \pi_0$ so that the second period equilibrium price must be

$$p_2^D = \theta\pi - \pi_0.$$

In the first period, the seed producer chooses his first-period price that will maximize his profit knowing that only farmers with high productivity will buy his seed. Farmers with high productivity are those who get a higher benefit if they use the new seed in the first period and self-produce in the second period than those who buy the old variety in the first period and the new one in the second period such that

$$\theta\pi - p_1 + \phi\theta\pi - \tau \geq 2\pi_0.$$

Thus, the threshold between farmers with high productivity and low productivity is

$$\phi^D \equiv \frac{2\pi_0 - \theta\pi + p_1 + \tau}{\theta\pi}.$$

The seed producer solves the following program

$$\text{Max}_{p_1} \left(\int_{\phi^D}^{\bar{\phi}} (p_1 + \lambda\tau) dF + \int_{\phi}^{\phi^D} (\theta\pi - \pi_0) dF \right).$$

The first term in the maximization program represents the gain of the seed producer during both periods thanks to farmers with high productivity, whereas the second term is the payoff that the seed producer gets from farmers with low productivity who buy in the second period. The first period equilibrium price at period one is thus

$$p_1^D = \frac{1}{2}(2\theta\pi - 3\pi_0 + \bar{\phi}\theta\pi - \tau(1 + \lambda)).$$

The higher $\bar{\phi}$, the higher the first period equilibrium price. On the other hand, an increase in the fee, τ , has a negative impact on the equilibrium price. Both a high tax

and a low upper bound involve a reduction of the farmers productivity.

The seed producer can also choose a non-durable strategy in which he sells the new seed during each period. In the first period, the farmers will choose the new seed if $\theta\pi - p_1 \geq \pi_0$ so that the equilibrium price is

$$p_1^{ND} = \theta\pi - \pi_0.$$

In the second period, farmers prefer to buy the new seed if¹⁷ $\theta\pi - p_1 \geq \phi\theta\pi - \tau$ so that a threshold between farmers with high productivity who self-produce and farmers with low productivity who buy the new seed in the second period is

$$\phi^{ND} \equiv \frac{\theta\pi - p_2 + \tau}{\theta\pi}.$$

In order to set the equilibrium price at the second period, the seed producer maximizes

$$Max_{p_2} \left(\int_{\underline{\phi}}^{\bar{\phi}} (\theta\pi - \pi_0) dF + \int_{\underline{\phi}}^{\phi^D} p_2 dF + \int_{\phi^D}^{\bar{\phi}} \lambda\tau dF \right).$$

The first part of the maximization represents the gain in the first period. The second part corresponds to the fraction of farmers who buy the new variety and the third part corresponds to farmers who self-produce during the second period. The equilibrium price is

$$p_2^{ND} = \frac{1}{2}(\theta\pi - \underline{\phi}\theta\pi + \tau(1 + \lambda)).$$

Contrary to the equilibrium price in the case of a durable good strategy, here, the tax τ and $\underline{\phi}$ have, respectively, a positive impact and a negative impact on the equilibrium price. Indeed, the higher $\underline{\phi}$, the larger the proportion of farmers using farm-saved seed and, then, the lower the profit. On the other hand, the tax pushes more farmers to buy the seed variety. Furthermore, this equilibrium price can reach a maximum where

17. With the assumption that there are farmers who are sufficiently productive to self-produce.

farmers prefer the old variety for

$$\tau^{ND} \equiv \frac{\theta\pi - 2\pi_0 + \underline{\phi}\theta\pi}{1 + \lambda}.$$

In this situation, the second period equilibrium price becomes $\theta\pi - \pi_0$ as in the first period. These three areas are represented in Figure 4.6.1 where we represent the decisions in a graph $(\tau, \bar{\phi})$. The corresponding payoffs are summarized in Table 4 in Annex F.

Figure 4.6.1: Seed producer strategies under a PBR regime with heterogeneous farmers

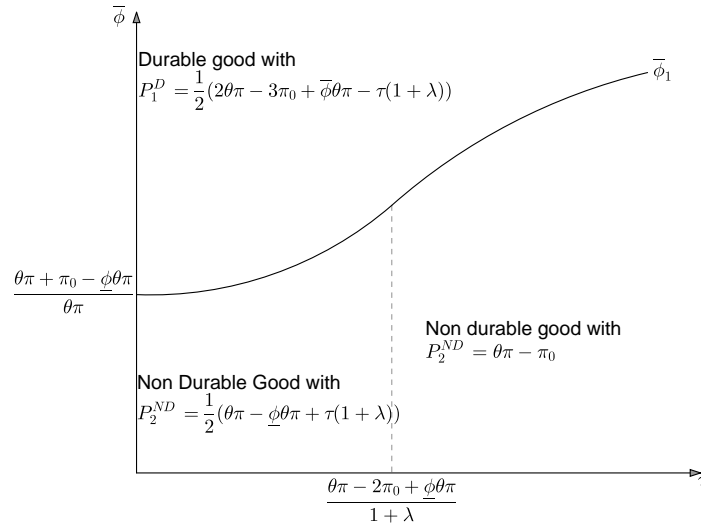

For values of $\tau < \tau^{ND}$, the seed producer chooses a non-durable good strategy if

$$\phi < \frac{\theta\pi + \pi_0 - \underline{\phi}\theta\pi}{\theta\pi},$$

and a durable good strategy otherwise. As long as the more productive self-producing farmer is not too productive, a non-durable good strategy is preferred.

The curve, function of τ , is divided into two parts: the first part, until the level τ^{ND} , represents the comparison between the non-durable good strategy when the price p_2 does not reach its maximum level and the durable good strategy; the second part is the comparison between the non-durable good with $p_2 = \theta\pi - \pi_0$ and the durable good

strategy.

As in the previous section, we find three different areas: a non-durable good strategy $\{p_1^{ND}, p_2^{ND} = \frac{1}{2}(\theta\pi - \underline{\phi}\theta\pi + \tau(1 + \lambda))\}$, a second non-durable good strategy $\{p_1^{ND}, p_2^{ND} = \theta\pi - \pi_0\}$ and a durable good strategy $\{p_1^D, p_2^D\}$.¹⁸

The case with a patent is similar to the one from the previous section.

Choice between PBR and Patent

Similarly to the case with homogeneous farmers, depending on whether the seed innovation is small or large, the seed producer chooses to protect it either with a patent or a PBR. We compare the payoffs of the seed producer from Table 4.F.1 (the three situations) to the payoff he will get if he patents his seed innovation (section 3.2). Results are showed in Figure 4.6.2.

Notice that it seems that only one curve exists for $\bar{\phi}_2$ between the patent strategy and the non-durable good strategy with a PBR even if the price p_2 is different. In fact, two different curves exist but they are very analogous. The colored area represents the case of a patent. This area shrinks when c_p or π_0 increases and expands with the level of innovation θ . For $\lambda = 1$, the curve that differentiates the patent and the durable good strategy with a PBR, $\bar{\phi}_3$, is horizontal.

18. The level of the intercept is very high (≥ 1) if the lower bound, $\underline{\phi}$, of the productivity equal zero, thus the durable good strategy seems to be rare for several set of parameters.

Figure 4.6.2: Seed producer strategies under both PBR and patent regimes with heterogeneous farmers

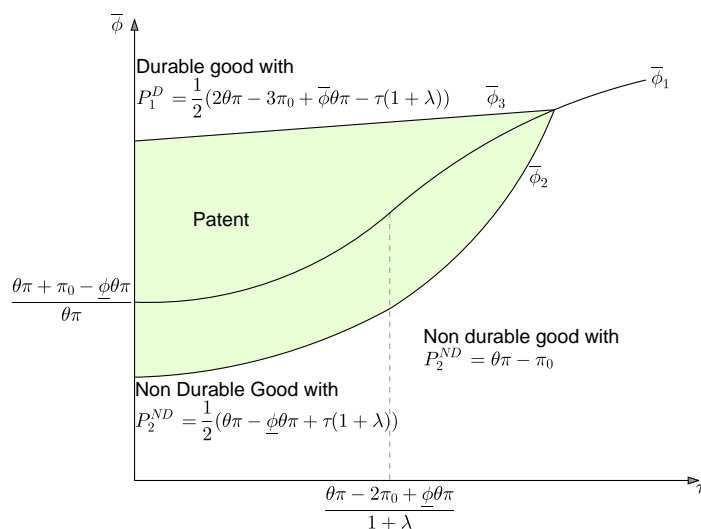

Investment Decision

When he makes his investment decision, the seed producer does not know whether he will obtain a small or a large innovation. He obtains a large innovation, $\bar{\theta}$, with probability $\mu(I)$ and a small innovation, $\underline{\theta}$, with probability $1 - \mu(I)$. As a consequence, the level of investment chosen by the seed producer depends on the price strategy, the method of protection and the size of the innovation. We obtain a figure similar to Figure 4.6.2 where six cutoff values and nine different optimal investments are determined for the seed producer in Figure 4.6.3.

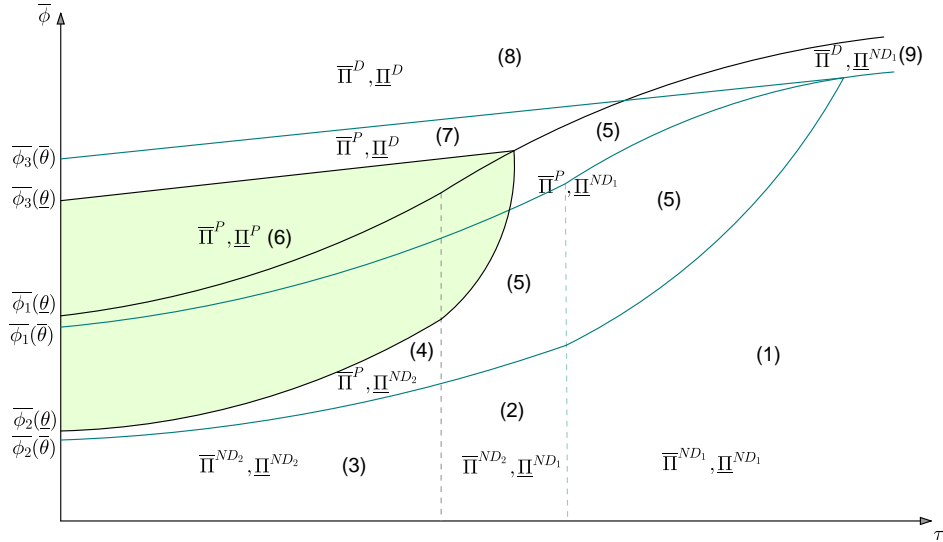
Figure 4.6.3: Seed producer strategies under both PBR and patent regimes with heterogeneous farmers and $\theta \in \{\underline{\theta}, \bar{\theta}\}$ 

Cutoffs are functions of the level of innovation so that $\bar{\phi}_1$ is now $\bar{\phi}_1(\bar{\theta})$ or $\bar{\phi}_1(\underline{\theta})$. For example, in area (1), the seed producer chooses to protect his innovation (whether it is a large or small one) with a PBR, and chooses a non-durable good strategy with a second-period price $p_2 = \theta\pi - \pi_0$. Thus, the optimal investment is obtained by the following maximization of his profit

$$\max_I \{ \mu(I) \bar{\Pi}^{ND_1} + (1 - \mu(I)) \underline{\Pi}^{ND_1} - I \},$$

which is similar to situation (1) with homogeneous farmers except that $\bar{\Pi}^{ND_1}$ and $\underline{\Pi}^{ND_1}$ have different values (see Table 4.F.1). In Figure 4.6.3, two other optimal investments exist

$$\max_I \{ \mu(I) \bar{\Pi}^P + (1 - \mu(I)) \underline{\Pi}^{ND_1} - I \},$$

and

$$\max_I \{ \mu(I) \bar{\Pi}^D + (1 - \mu(I)) \underline{\Pi}^{ND_1} - I \}.$$

Moreover, if the cost to patent an innovation is very high a last situation (not

presented in Figure 4.6.3) can appear with

$$\max_I \{ \mu(I) \bar{\Pi}^D + (1 - \mu(I)) \underline{\Pi}^{ND_2} - I \}.$$

Many cases are similar to the previous section, where farmers are homogeneous. However, due to the heterogeneity, very complicated payoffs are found in this section. Moreover, the results found with homogeneous farmers will be similar, but more complicated, to the situation where farmers are heterogeneous. For these reasons, we chose to highlight the case where farmers are homogeneous (e.g. section 2, 3, 4, 5).

4.6.2 Different Functional Forms for $\mu(I)$

The functional form of the probability of finding a large innovation used to evaluate the profit and the welfare functions is

$$\mu(I) = (1 - \exp^{-I}),$$

with $\mu'(I) > 0$, $\mu''(I) < 0$ and $\mu(0) = 0$. The maximization of the profit is

$$\max_I \{ (1 - \exp^{-I}) \bar{\Pi}^i + (1 - (1 - \exp^{-I})) \underline{\Pi}^j - I \},$$

where i is the strategy chosen by the breeder for a large innovation and j for a small innovation and the chosen investment cost is simply the amount of investment I . Then we obtain the optimal investment

$$I^{\bar{i},j} = \log(\bar{\Pi}^i - \underline{\Pi}^j).$$

Two robustness checks can be done: on the investment cost and on the probability of success. First, an investment cost $\frac{I^2}{2}$ is chosen instead of I , the maximization becomes

$$\max_I \{ (1 - \exp^{-I}) \bar{\Pi}^i + (1 - (1 - \exp^{-I})) \underline{\Pi}^j - \frac{I^2}{2} \},$$

and the optimal investment turn into a productlog function

$$I^{\bar{i},j} = \text{productlog}(\bar{\Pi}^i - \underline{\Pi}^j).$$

The second robustness regards the probability of success. The arctan function is adopted. To make sure that the probability of success will not be higher than 1 it is divided by 1.58

$$\mu(I) = (\arctan(I)/1.58),$$

as for the previous probability of success $\mu'(I) > 0$, $\mu''(I) < 0$ and $\mu(0) = 0$. The maximization of the profit changes into

$$\max_I \{(\arctan(I)/1.58)\bar{\Pi}^i + (1 - (\arctan(I)/1.58)) - \underline{\Pi}^j - I\},$$

and the optimal investment becomes a square root function

$$I^{\bar{i},j} = 0.11\sqrt{-79 + 100(\bar{\Pi}^i - \underline{\Pi}^j)}.$$

These two robustness checks change the amount of the optimal investment, and therefore, the amount of welfare. However, it will not alter the different areas found in the previous section nor the shape or the ranking of the different optimal investments and the welfare.

4.7 Conclusion

The aim of this paper is to highlight the problem of incentives to innovate when seed saving decreases the seed producer profit. Private firms innovate only if their payoffs exceed their costs, especially research and development. Therefore, the loss incurred due to seed saving may decrease private investment. To correct the incentive problem, in France, an inter-professional agreement has created a fee for the wheat seed market. We have constructed a theoretical model to analyze the consequences of the

introduction of a fee on the seed producer behavior.

We first analyze the equilibrium strategies for the seed producer depending on the seed saving productivity and the level of the fee chosen by public authority. For a high (respectively low) productivity and a low (respectively, high) fee the seed producer chooses a durable good strategy (respectively, non-durable good strategy). Moreover, we find that the introduction of the patent system does not necessarily prevent self-produce by farmers.

We then consider an endogenous innovation process where the seed producer can obtain either a small or a large invention, depending on his investment intensity. Our findings suggest that the incentive to innovation are maximum either in a patent system or in a PBR system for which the tax prevents seed saving. If the seed producer can choose between a PBR or a patent, his investment decision is a non-monotonic function of the fee. Moreover, the maximum welfare is reached only for a PBR system for which the tax prevents seed saving.

4.8 Bibliography

- Ambec, S., Langinier, C., and Lemarié, S. Incentives to reduce crop trait durability. *American Journal of Agricultural Economics*, 90(2):379, 2008. doi:10.1111/j.1467-8276.2007.01110.x.
- Bulow, J. I. Durable-goods monopolists. *The Journal of Political Economy*, 90(2):314–332, 1982. URL <http://www.jstor.org/stable/1830295>.
- Carew, R., Smith, E., Grant, C., et al. Factors influencing wheat yield and variability: Evidence from manitoba, canada. *Journal of Agricultural and Applied Economics*, 41(3):625–639, 2009. URL <http://purl.umn.edu/56649>.
- Coase, R. Durability and monopoly. *Journal of Law and Economics*, 15(1):143–149, 1972.
- Curtis, F. and Nilsson, M. Collection systems for royalties in soft wheat: An international study. Technical report, International Seed Federation, 2012.
- Falck-Zepeda, J. B., Traxler, G., and Nelson, R. G. Surplus distribution from the introduction of a biotechnology innovation. *American Journal of Agricultural Economics*, 82(2):360–369, 2000. doi:10.1111/0002-9092.00031.
- Galushko, V. *Intellectual Property Rights and the Future of Breeding in Canada*. PhD thesis, University of Saskatchewan, 2008.
- Menell, P. and Scotchmer, S. Intellectual property law. In Polinsky, A. and Shavell, S., editors, *Handbook of Law and Economics*, volume 2, chapter 19, pages 1473–1570. North Holland, 2005. doi:[http://dx.doi.org/10.1016/S1574-0730\(07\)02019-1](http://dx.doi.org/10.1016/S1574-0730(07)02019-1).
- Moschini, G. and Yerokhin, O. Patents, research exemption, and the incentive for sequential innovation. *Journal of Economics & Management Strategy*, 17(2):379–412, 2008. doi:10.1111/j.1530-9134.2008.00182.x.

- Moschini, G., Lapan, H. E., and Sobolevsky, A. Roundup readyÆ soybeans and welfare effects in the soybean complex. *Agribusiness*, 16(1):33–55, 2000. URL <http://EconPapers.repec.org/RePEc:wly:agribz:v:16:y:2000:i:1:p:33-55>.
- Nagaoka, S. and Aoki, R. An economic analysis of patent law exemption for research on a patented invention. Working Paper, 2009.
- Naseem, A., Oehmke, J. F., and Schimmelpfennig, D. E. Does plant variety intellectual property protection improve farm productivity? evidence from cotton varieties. *AgBioForum*, 8(2&3):100–107, 2005.
- Perrin, R. and Fulginiti, L. Pricing and welfare impacts of new crop traits: The role of iprs and coase conjecture revisited. *AgBioForum*, 11(2):134–144, 2008.
- Qaim, M. and Traxler, G. Roundup ready soybeans in argentina: farm level and aggregate welfare effects. *Agricultural Economics*, 32(1):73–86, 2005. doi:10.1111/j.0169-5150.2005.00006.x.
- Schankerman, M. and Pakes, A. Estimates of the value of patent rights in european countries during the post-1950 period. *The Economic Journal*, 96(384):1052–1076, 1986. URL <http://www.jstor.org/stable/2233173>.
- Scotchmer, S. Standing on the shoulders of giants: cumulative research and the patent law. *The Journal of Economic Perspectives*, 5(1):29–41, 1991. doi:10.1257/jep.5.1.29.
- Scotchmer, S. *Innovation and incentives*. The MIT Press, 2004.
- Srinivasan, C. S. Modelling economic returns to plant variety protection in the uk. *Bio-based and Applied Economics*, 1(2):151–174, 2012. doi:10.13128/BAE-10557.
- Waldman, M. Durable goods theory for real world markets. *Journal of Economic Perspectives*, 17(1):131–154, 2003. URL <http://www.jstor.org/stable/3216843>.
- Wright, B. D., Pardey, P. G., Nottenburg, C., and Koo, B. Agricultural innovation: Investments and incentives. In Evenson, R. and Pingali, P., editors, *Handbook of*

Agricultural Economics, volume 3, chapter 48, pages 2534–2557. Elsevier B.V., 2007.
doi:[http://dx.doi.org/10.1016/S1574-0072\(06\)03048-9](http://dx.doi.org/10.1016/S1574-0072(06)03048-9).

Yiannaka, A. Market acceptance and welfare impacts of genetic use restriction technologies. Working paper, 2014.

Appendix

4.A Price Equilibrium with a PBR

When $\phi \geq \phi_1$, the seed producer can choose between the non-durable good strategy with prices $\{p_1^{ND}, p_2^{ND_2}\}$ which yields a payoff Π^{ND_2} and the durable good strategy with prices $\{p_1^D, p_2^D\}$ which gives a payoff Π^D . As long as $\Pi^{ND_2} > \Pi^D$ (respectively, $\Pi^{ND_2} \leq \Pi^D$) a non-durable good strategy (resp., a durable good strategy) will be adopted, which happens for $\phi < \phi_2$ (resp., for $\phi \geq \phi_2$) with

$$\begin{aligned}\phi_1 &= \frac{(\pi_0 + \tau)}{\theta\pi}, \\ \phi_2 &= \frac{\theta\pi + \pi_0 + \tau(2 - \lambda)}{2\theta\pi}.\end{aligned}$$

In a graph (τ, ϕ) , represented in Figure 4.3.1 we find three distinct areas where $\phi_2 > \phi_1$ for any values of τ .

4.B Choice between a PBR and a Patent

For a given innovation size θ , the seed producer can decide whether to protect his innovation with a patent or a PBR. He will patent as long as $\Pi^P > \Pi^j$ with $j = D, ND_1, ND_2$.

Figure 4.3.2(a) represents a configuration in which $c_P < (1 - \lambda)(\theta\pi - \pi_0)/(2 - \lambda)$. To determine this condition, we calculate the value of τ for which $\phi_2 = 1$, which is $2(\theta\pi - \pi_0)/(2 - \lambda)$ and for which $\phi_1^P = 1$, which is $2(\theta\pi - \pi_0) - c_P$. Then, ϕ_2 evaluated

at 1 is smaller than ϕ_1^P evaluated at 1 if $2(\theta\pi - \pi_0)/(2 - \lambda) < 2(\theta\pi - \pi_0) - c_P$. This latter condition also insures that ϕ_2^P is smaller than ϕ_2 both evaluated at 1. It is also easy to check that for $\tau = 0$, $\phi_1 = \pi_0/\theta\pi < \phi_1^P = (\pi_0 + c_P)/\theta\pi < \phi_2 = (\theta\pi + \pi_0)/2\theta\pi < \phi_2^P = (\theta\pi - c_P)/\theta\pi < 1$.

Figure 4.3.2(b) corresponds to a situation where less patenting will occur as the patenting cost is higher, $c_P < (1 - \lambda)(\theta\pi - \pi_0)/(2 - \lambda)$ but with $c_P > (\theta\pi - \pi_0)/2$.

4.C Optimal levels of investment

Before calculating the optimal levels of investment, we need to define under what circumstances the seed producer will choose a pricing strategy for each innovation size $\underline{\theta}$ and $\bar{\theta}$.

If Figure 4.4.1 we represent the different areas where the seed producer chooses durable good and non-durable good strategy. In order to have $\phi_2(\bar{\theta}) > \phi_1(\underline{\theta})$, we show that

$$\frac{\bar{\theta}\pi + \pi_0}{2\bar{\theta}\pi} > \frac{\pi_0}{\underline{\theta}\pi},$$

and

$$\underline{\theta}\pi - \pi_0 > \frac{\bar{\theta}\pi - \pi_0}{2 - \lambda}.$$

The first inequality is equivalent to having

$$\underline{\theta}\pi > \frac{2\bar{\theta} - \underline{\theta}}{\bar{\theta}}\pi_0,$$

and the second one to having

$$\underline{\theta}\pi > \frac{1 - \lambda}{(1 - \lambda)\underline{\theta} - (\bar{\theta} - \underline{\theta})}\theta\pi_0,$$

with $(1 - \lambda)\underline{\theta} - (\bar{\theta} - \underline{\theta}) > 0$. Therefore, as $(2\bar{\theta} - \underline{\theta})/\bar{\theta} < (1 - \lambda)/((1 - \lambda)\underline{\theta} - (\bar{\theta} - \underline{\theta}))$,

the only conditions that are needed are

$$\bar{\theta} < (2 - \lambda)\underline{\theta}, \tag{4.19}$$

and

$$\underline{\theta}\pi > \frac{(1 - \lambda)\underline{\theta}}{(1 - \lambda)\underline{\theta} - (\bar{\theta} - \underline{\theta})}\pi_0. \tag{4.20}$$

We can combine these two assumptions to obtain that $\bar{\theta} < (2 - \lambda)\underline{\theta} - (1 - \lambda)\pi_0/\pi$. If this latter inequality is not satisfied, $\bar{\phi}_2 < \underline{\phi}_1$ as represented in Figure 4.C.1 This corresponds to the case where the large innovation is relatively much larger than the small one. In this case the areas are different as there is an area in which the seed producer who has discovered a large innovation prefers to use a durable good strategy while if he has discovered a small one he will prefer to use a non-durable good strategy.

Figure 4.C.1: Seed producer strategies under a PBR regime with $\theta \in \{\underline{\theta}, \bar{\theta}\}$

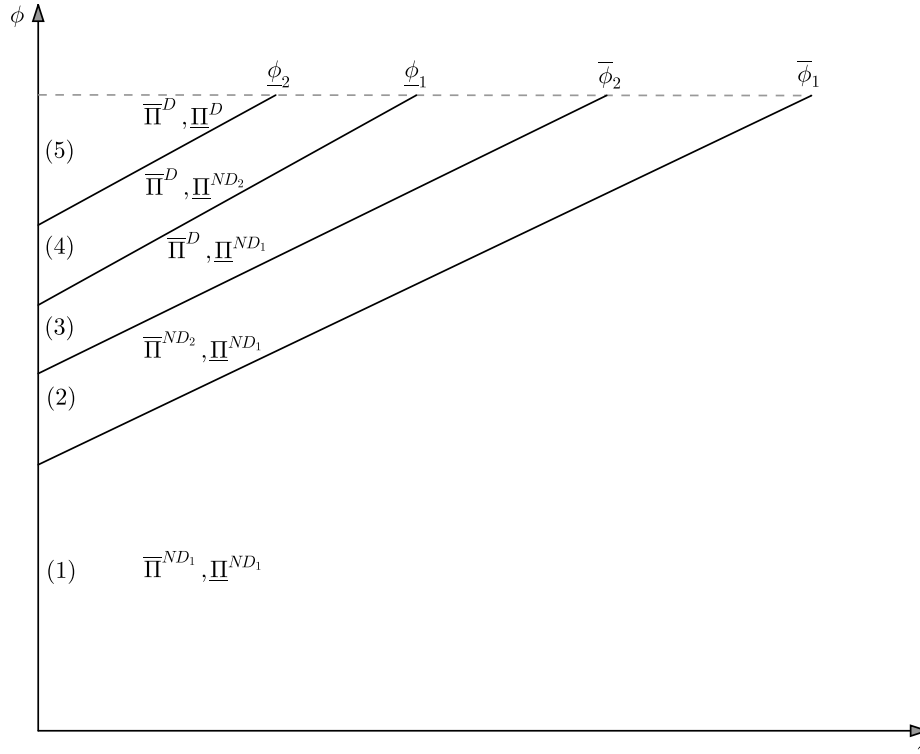

In each area defined in Figure 4.4.1, we now determine the investment decision. In area (1), the seed producer uses non-durable good strategy 1 for any size of the innovation, and thus he chooses I that solves

$$\max_I \{ \mu(I) \bar{\Pi}^{ND_1} + (1 - \mu(I)) \underline{\Pi}^{ND_1} - I \},$$

which gives the following first order condition

$$\mu'(I) [2(\bar{\theta} - \underline{\theta})\pi] - 1 = 0.$$

We denote $I^{\overline{ND}_1, ND_1}$ the optimal level of investment, which is independent of τ .

In area (2), the seed producer uses non-durable good strategy 1 for a small innovation and non-durable good strategy 2 for a large innovation and, then, chooses I that solves

$$\max_I \{ \mu(I) \bar{\Pi}^{ND_2} + (1 - \mu(I)) \underline{\Pi}^{ND_1} - I \},$$

which gives the first order condition

$$\mu'(I) [2(\bar{\theta} - \underline{\theta})\pi + \pi_0 + \tau - \bar{\theta}\phi\pi] - 1 = 0.$$

We denote $I^{\overline{ND}_2, ND_1}$ the optimal level of investment. This level of investment increases with τ . Indeed, if we totally differentiate the first order condition and we rearrange the terms, we find

$$\frac{dI}{d\tau} = -\mu''(I) > 0,$$

as $\mu''(I) < 0$.

At the threshold $\bar{\phi}_1$, $I^{\overline{ND}_1, ND_1}$ and $I^{\overline{ND}_2, ND_1}$ are equal for a tax $\tau = \bar{\theta}\phi\pi - \pi_0$. Below this tax level, the seed producer is in area (2) for an investment level ($I^{\overline{ND}_2, ND_1}$) lower than the investment level in area (1) ($I^{\overline{ND}_1, ND_1}$). However, the tax has a positive impact on the investment level.

In area (3), when the seed producer uses non-durable good strategy 2 for any size

of the innovation, he chooses I that solves

$$\max_I \{\mu(I)\bar{\Pi}^{ND_2} + (1 - \mu(I))\underline{\Pi}^{ND_2} - I\},$$

which gives the first order condition

$$\mu'(I)[(\bar{\theta} - \underline{\theta})\pi(2 - \phi)] - 1 = 0.$$

We denote $I^{\overline{ND_2}, ND_2}$ the optimal level of investment, which does not depend on τ .

At the threshold $\underline{\phi}_1$, $I^{\overline{ND_2}, ND_1}$ and $I^{\overline{ND_2}, ND_2}$ are equal. In area (2), the tax level is between $\underline{\theta}\phi\pi - \pi_0$ and $\bar{\theta}\phi\pi - \pi_0$, as a consequence, $I^{\overline{ND_2}, ND_1}$ is higher than $I^{\overline{ND_2}, ND_2}$.

In area (4), the seed producer uses a durable good strategy for a large innovation and non-durable good strategy 2 for a small innovation, and thus chooses I that solves

$$\max_I \{\mu(I)\bar{\Pi}^D + (1 - \mu(I))\underline{\Pi}^{ND_2} - I\},$$

which gives the first order condition

$$\mu'(I)[2(\bar{\theta} - \underline{\theta})\pi - \pi\bar{\theta}(1 - \phi) + \underline{\theta}\pi\phi - \pi_0 - \tau(2 - \lambda)] - 1 = 0.$$

We denote $I^{\overline{D}, ND_2}$ the optimal level of investment, which is decreasing in τ . If we totally differentiate the first order condition, we find

$$\frac{dI}{d\tau} = -\frac{\mu''(I)}{-(2-\lambda)} < 0.$$

In area (5), the seed producer uses the durable good strategy for any size of the innovation and chooses I that solves

$$\max_I \{\mu(I)\bar{\Pi}^D + (1 - \mu(I))\underline{\Pi}^D - I\},$$

which gives the first order condition

$$\mu'(I)[(1 + \phi)(\bar{\theta} - \underline{\theta})\pi] - 1 = 0.$$

We denote $I^{\bar{D}, \underline{D}}$ the optimal level of investment. This level of investment does not depend on τ .

We then calculate the socially optimal levels of investment that solve

$$\max_I \{\mu(I)\bar{W} + (1 - \mu(I))\underline{W} - I\},$$

where \bar{W} and \underline{W} are determined in function of the pricing strategies chosen by the seed producer for large and small innovations. For instance, in area (1) in Figure 4.4.1, the socially optimal level of investment is solution of

$$\max_I \{\mu(I)\bar{W}^{ND} + (1 - \mu(I))\underline{W}^{ND} - I\},$$

where $W^{ND} = 2\theta\pi$. We denote $I_W^{\bar{ND}, ND}$ the solution of this maximizing program. For each of the five areas in Figure 4.4.1, we calculate the different levels of socially optimal investments.

For each of the five areas in Figure 4.4.1 we summarize the profit and social welfare functions and the private and socially optimal levels of investment, as well as the comparison of the levels of investments in Table 4.C.1.

Table 4.C.1: Results under a PBR regime

	Profits	Optimal Investment	Welfare	Socially optimal investment
Area 1	$\overline{\Pi}^{ND_1}, \underline{\Pi}^{ND_1}$	$I^{\overline{ND}_1, \underline{ND}_1}$	$\overline{W}^{ND}, \underline{W}^{ND}$	$I_W^{ND, ND} = I^{\overline{ND}_1, \underline{ND}_1}$
Area 2	$\overline{\Pi}^{ND_2}, \underline{\Pi}^{ND_1}$	$I^{\overline{ND}_2, \underline{ND}_1}$	$\overline{W}^{ND}, \underline{W}^{ND}$	$I_W^{ND, ND} = I^{\overline{ND}_1, \underline{ND}_1}$
Area 3	$\overline{\Pi}^{ND_2}, \underline{\Pi}^{ND_2}$	$I^{\overline{ND}_2, \underline{ND}_2}$	$\overline{W}^{ND}, \underline{W}^{ND}$	$I_W^{ND, ND} = I^{\overline{ND}_1, \underline{ND}_1}$
Area 4	$\overline{\Pi}^D, \underline{\Pi}^{ND_2}$	$I^{\overline{D}, \underline{ND}_2}$	$\overline{W}^D, \underline{W}^{ND}$	$I_W^{D, ND_2} < I^{\overline{D}, \underline{ND}_2}$
Area 5	$\overline{\Pi}^D, \underline{\Pi}^D$	$I^{\overline{D}, \underline{D}}$	$\overline{W}^D, \underline{W}^D$	$I_W^{D, D} = I^{\overline{D}, \underline{D}}$

where W^D is defined by (4.4).

Patent and PBR

When the seed producer can choose between a patent and a PBR, we represent the different areas in Figure 4.4.4. In the seven different areas we now calculate the optimal level of investment chosen by the seed producer. In areas (1), (2) and (3), the results are similar to those we found before.

In area (4), the seed producer chooses a PBR for a small innovation and a patent for a large innovation. He then solves the following optimization program

$$\max_I \{ \mu(I) \overline{\Pi}^P + (1 - \mu(I)) \underline{\Pi}_2^{ND} - I \},$$

which gives the first order condition

$$\mu'(I) [2(\overline{\theta} - \underline{\theta})\pi - \pi_0 + \underline{\theta}\pi\phi - \tau - c_P] - 1 = 0.$$

We denote $I^{\overline{P}, \underline{ND}_2}$ the optimal level of investment. At the threshold $\overline{\phi}_1^P$, $I^{\overline{ND}_2, \underline{ND}_2}$ and $I^{\overline{P}, \underline{ND}_2}$ are equal. In area (4), the tax is included between $\underline{\theta}\pi\phi - \pi_0 - c_P$ and $\overline{\theta}\pi\phi - \pi_0 - c_P$, thus $I^{\overline{ND}_2, \underline{ND}_2}$ is higher than $I^{\overline{P}, \underline{ND}_2}$. However, the tax has a negative impact on investment.

If the seed producer decides to patent both types of innovation, in area (5), he solves

$$\max_I \{\mu(I)\bar{\Pi}^P + (1 - \mu(I))\underline{\Pi}^P - I\},$$

which gives the first order condition

$$\mu'(I)[2(\bar{\theta} - \underline{\theta})\pi] - 1 = 0.$$

We denote $I^{\bar{P},P}$ the optimal level of investment, which does not depend on τ .

At the threshold $\underline{\phi}_1^P$, $I^{\bar{P},ND_2}$ and $I^{\bar{P},P}$ are equal. Furthermore, $I^{\bar{P},P}$ is equal to $I^{\bar{ND}_1,ND_1}$ such that the incentive to innovate in area (5) are the greatest. Thus, $I^{\bar{P},P}$ is greater than $I^{\bar{ND}_2,ND_1}$, $I^{\bar{ND}_2,ND_2}$ and $I^{\bar{P},ND_2}$ except for the threshold value where $I^{\bar{P},P}$ is equal to $I^{\bar{P},ND_2}$.

In area (6), if the seed producer chooses a PBR for the small innovation and a patent for the large innovation, he chooses I that solves

$$\max_I \{\mu(I)\bar{\Pi}^P + (1 - \mu(I))\underline{\Pi}^D - I\},$$

which gives the first order condition

$$\mu'(I)[(2\bar{\theta} - \underline{\theta}(1 + \phi))\pi + \tau(1 - \lambda) - c_P] - 1 = 0.$$

We denote $I^{\bar{P},D}$ the optimal level of investment, which increases with τ . If we totally differentiate the first order condition, we find

$$\frac{dI}{d\tau} = -\frac{\mu''(I)}{1-\lambda} > 0.$$

At the threshold $\underline{\phi}_2^P$, $I^{\bar{P},P}$ and $I^{\bar{P},D}$ are equal. The tax has a positive impact on the investment but in area (6) the value of the tax involves that the incentive to innovate in area (5) is greater than in area (6).

In area (7), if the seed producer prefers a PBR with a durable good strategy, he

chooses I that solves

$$\max_I \{\mu(I)\bar{\Pi}^D + (1 - \mu(I))\underline{\Pi}^D - I\},$$

which gives the first order condition

$$\mu'(I)[(1 + \phi)(\bar{\theta} - \underline{\theta})\pi] - 1 = 0.$$

We denote $I^{\bar{D},D}$ the optimal level of investment, which does not depend on τ .

At the threshold ϕ_2^P , $I^{\bar{P},D}$ and $I^{\bar{D},D}$ are equal. For a ϕ lower (higher) than $1/2$, $I^{\bar{ND}_2,ND_2}$ is higher (lower) than $I^{\bar{D},D}$. For a $\phi < 1$, $I^{\bar{ND}_1,ND_1}$ and $I^{\bar{P},P}$ are higher than $I^{\bar{D},D}$.

We then calculate the socially optimal levels of investment that solves

$$\max_I \{\mu(I)\bar{W} + (1 - \mu(I))\underline{W} - I\},$$

as we have done before. We find the different levels of optimal investment, one for each of the seven areas in Figure 4.4.4

For each of the seven areas in Figure 4.4.4 we summarize the profit and social welfare functions and the optimal level of investments in Table 4.C.2.

Table 4.C.2: Results under a patent/PBR regime

	Profits	Optimal Investment	Welfare	Socially Optimal Investment
Area 1	$\bar{\Pi}^{ND_1}, \underline{\Pi}^{ND_1}$	$I^{\bar{ND}_1,ND_1}$	$\bar{W}^{ND}, \underline{W}^{ND}$	$I_W^{ND,ND} = I^{\bar{ND}_1,ND_1}$
Area 2	$\bar{\Pi}^{ND_2}, \underline{\Pi}^{ND_1}$	$I^{\bar{ND}_2,ND_1}$	$\bar{W}^{ND}, \underline{W}^{ND}$	$I_W^{ND,ND} = I^{\bar{ND}_1,ND_1} > I^{\bar{ND}_2,ND_1}$
Area 3	$\bar{\Pi}^{ND_2}, \underline{\Pi}^{ND_2}$	$I^{\bar{ND}_2,ND_2}$	$\bar{W}^{ND}, \underline{W}^{ND}$	$I_W^{ND,ND} = I^{\bar{ND}_1,ND_1} > I^{\bar{ND}_2,ND_2}$
Area 4	$\bar{\Pi}^P, \underline{\Pi}^{ND_2}$	$I^{\bar{P},ND_2}$	$\bar{W}^P, \underline{W}^{ND}$	$I_W^{P,ND_2} < I^{\bar{P},ND_2}$
Area 5	$\bar{\Pi}^P, \underline{\Pi}^P$	$I^{\bar{P},P}$	$\bar{W}^P, \underline{W}^P$	$I_W^{P,P} = I_W^{\bar{ND},ND}$
Area 6	$\bar{\Pi}^P, \underline{\Pi}^D$	$I^{\bar{P},D}$	$\bar{W}^P, \underline{W}^D$	$I_W^{P,D} = I^{\bar{P},D} < I_W^{\bar{ND},ND}$
Area 7	$\bar{\Pi}^D, \underline{\Pi}^D$	$I^{\bar{D},D}$	$\bar{\Pi}^P, \underline{\Pi}^P$	$I_W^{\bar{D},D} = I^{\bar{D},D} < I_W^{\bar{ND},ND}$

4.D Incentive to Innovate

We first consider the case in which the seed producer protects his innovation only with a PBR. We calculate the *ex ante* expected profit of the seed producer for each of the five areas of Figure 4.4.1

In area (1), given the optimal investment $I^{\overline{ND}_1, ND_1}$ that does not depend on τ , the *ex ante* expected payoff is

$$\begin{aligned}\Pi^{\overline{ND}_1, ND_1} &= \mu(I^{\overline{ND}_1, ND_1})\overline{\Pi}^{ND_1} + (1 - \mu(I^{\overline{ND}_1, ND_1}))\underline{\Pi}^{ND_1} - I^{\overline{ND}_1, ND_1} \\ &= \mu(I^{\overline{ND}_1, ND_1})2(\overline{\theta} - \underline{\theta})\pi + 2(\underline{\theta}\pi - \pi_0) - I^{\overline{ND}_1, ND_1}.\end{aligned}$$

This expected payoff does not depend on τ .

In area (2), given the optimal investment $I^{\overline{ND}_2, ND_1}$ that increases with τ , the *ex ante* expected payoff is

$$\begin{aligned}\Pi^{\overline{ND}_2, ND_1} &= \mu(I^{\overline{ND}_2, ND_1})\overline{\Pi}^{ND_2} + (1 - \mu(I^{\overline{ND}_2, ND_1}))\underline{\Pi}^{ND_1} - I^{\overline{ND}_2, ND_1} \\ &= \mu(I^{\overline{ND}_2, ND_1})[\overline{\theta}\pi(2 - \phi) - \pi_0 + \tau] + (1 - \mu(I^{\overline{ND}_2, ND_1}))2(\underline{\theta}\pi - \pi_0) - I^{\overline{ND}_2, ND_1} \\ &= \Pi^{\overline{ND}_2, ND_1}(I^{\overline{ND}_2, ND_1}(\tau), \tau).\end{aligned}$$

Thus, by differentiating the expected payoff function we obtain

$$\frac{d\Pi^{\overline{ND}_2, ND_1}}{d\tau} = \frac{\partial\Pi^{\overline{ND}_2, ND_1}}{\partial I} \frac{\partial I}{\partial \tau} + \frac{\partial\Pi^{\overline{ND}_2, ND_1}}{\partial \tau}.$$

By using the envelop theorem the first part is equal to zero and thus

$$\frac{\partial\Pi^{\overline{ND}_2, ND_1}}{\partial \tau} = \mu(I^{\overline{ND}_2, ND_1}) > 0.$$

In area (3), given the optimal investment $I^{\overline{ND}_2, ND_2}$ that does not depend on τ , the

ex ante expected payoff is

$$\begin{aligned}
\Pi^{\overline{ND}_2, ND_2} &= \mu(I^{\overline{ND}_2, ND_2})\overline{\Pi}^{ND_2} + (1 - \mu(I^{\overline{ND}_2, ND_2}))\underline{\Pi}^{ND_2} - I^{\overline{ND}_2, ND_2} \\
&= \mu(I^{\overline{ND}_2, ND_2})(\overline{\theta} - \underline{\theta})\pi(2 - \phi) + \underline{\theta}\pi(2 - \phi) - \pi_0 + \tau - I^{\overline{ND}_2, ND_2} \\
&= \Pi^{\overline{ND}_2, ND_2}(\tau).
\end{aligned}$$

Thus, by differentiating the expected payoff function we obtain

$$\frac{\partial \Pi^{\overline{ND}_2, ND_2}}{\partial \tau} = 1 > 0.$$

In area (4), given the optimal investment $I^{\overline{D}, ND_2}$ that decreases with τ , the *ex ante* expected payoff is

$$\begin{aligned}
\Pi^{\overline{D}, ND_2} &= \mu(I^{\overline{D}, ND_2})\overline{\Pi}^D + (1 - \mu(I^{\overline{D}, ND_2}))\underline{\Pi}^{ND_2} - I^{\overline{D}, ND_2} \\
&= \mu(\cdot)[\overline{\theta}\pi(1 + \phi) - 2\pi_0 - \tau(1 - \lambda)] + (1 - \mu(\cdot))[\underline{\theta}\pi(2 - \phi) - \pi_0 + \tau] - I^{\overline{D}, ND_2} \\
&= \Pi^{\overline{D}, ND_2}(I^{\overline{D}, ND_2}(\tau), \tau).
\end{aligned}$$

Thus, by differentiating the expected payoff function we obtain

$$\frac{d\Pi^{\overline{D}, ND_2}}{d\tau} = \frac{\partial \Pi^{\overline{D}, ND_2}}{\partial I} \frac{\partial I}{\partial \tau} + \frac{\partial \Pi^{\overline{D}, ND_2}}{\partial \tau}.$$

By using the envelop theorem the first part is equal to zero and thus

$$\begin{aligned}
\frac{\partial \Pi^{\overline{D}, ND_2}}{\partial \tau} &= -\mu(\cdot)(1 - \lambda) + (1 - \mu(\cdot)) \\
&= 1 - \mu(\cdot)(2 - \lambda).
\end{aligned}$$

The sign of this derivative depends on the value of $\mu(I^{\overline{D}, ND_2})$. Thus

$$\begin{aligned}
\frac{\partial \Pi^{\overline{D}, ND_2}}{\partial \tau} &< 0 \text{ if } \mu(I^{\overline{D}, ND_2}) < 1/(2 - \lambda) \\
\frac{\partial \Pi^{\overline{D}, ND_2}}{\partial \tau} &> 0 \text{ if } \mu(I^{\overline{D}, ND_2}) > 1/(2 - \lambda)
\end{aligned}$$

In area (5), given the optimal investment $I^{\bar{D},\underline{D}}$ that does not depend on τ , we calculate the *ex ante* expected profit

$$\begin{aligned}\Pi^{\bar{D},\underline{D}} &= \mu(I^{\bar{D},\underline{D}})\bar{\Pi}^D + (1 - \mu(I^{\bar{D},\underline{D}}))\underline{\Pi}^D - I^{\bar{D},\underline{D}} \\ &= \mu(I^{\bar{D},\underline{D}})(\bar{\theta} - \underline{\theta})\pi(1 + \phi) + \underline{\theta}\pi(1 + \phi) - 2\pi_0 - \tau(1 - \lambda) - I^{\bar{D},\underline{D}} \\ &= \Pi^{\bar{D},\underline{D}}(\tau)\end{aligned}$$

Thus, by differentiating the expected payoff function we obtain

$$\frac{\partial \Pi^{\bar{D},\underline{D}}}{\partial \tau} = -(1 - \lambda) < 0.$$

If we consider the following functional form

$$\mu(I) = (1 - \exp^{-I}),$$

in area (4), we find that $\partial \Pi^{\bar{D},\underline{ND}_2} / \partial \tau < 0$. In order to represent these functions in a graph (Π, τ) , we use this functional form. We represent these functions in Figure 4.5.1

We now consider the case where both patent and PBR systems coexist and calculate the *ex ante* expected profit of the seed producer for each of the seven areas of Figure 4.4.4 In areas (1), (2), (3) and (7), the expected payoffs have been calculated above and are respectively $\Pi^{\bar{ND}_1,\underline{ND}_1}$, $\Pi^{\bar{ND}_2,\underline{ND}_1}$, $\Pi^{\bar{ND}_2,\underline{ND}_2}$ and $\Pi^{\bar{D},\underline{D}}$.

In area (4), the expected payoff evaluated at $I^{\bar{P},\underline{ND}_2}$ is

$$\Pi^{\bar{P},\underline{ND}_2} = \mu(I^{\bar{P},\underline{ND}_2})\bar{\Pi}^P + (1 - \mu(I^{\bar{P},\underline{ND}_2}))\underline{\Pi}^{ND_2} - I^{\bar{P},\underline{ND}_2}.$$

By using the envelop theorem, we calculate the derivative of $\Pi^{\bar{P},\underline{ND}_2}$ with respect to τ

$$\frac{\partial \Pi^{\bar{P},\underline{ND}_2}}{\partial \tau} = (1 - \mu(I^{\bar{P},\underline{ND}_2})) > 0.$$

In area (5), the expected payoff evaluated at $I^{\bar{P},P}$ is

$$\Pi^{\bar{P},P} = \mu(I^{\bar{P},P})\bar{\Pi}^P + (1 - \mu(I^{\bar{P},P}))\underline{\Pi}^P - I^{\bar{P},P},$$

which does not depend on τ .

In area (6), the expected payoff evaluated at $I^{\bar{P},D}$ is

$$\Pi^{\bar{P},D} = \mu(I^{\bar{P},D})\bar{\Pi}^P + (1 - \mu(I^{\bar{P},D}))\underline{\Pi}^D - I^{\bar{P},D}.$$

By using the envelop theorem, we calculate the derivative of $\Pi^{\bar{P},D}$ with respect to τ

$$\frac{\partial \Pi^{\bar{P},D}}{\partial \tau} = -(1 - \mu(I^{\bar{P},D}))(1 - \lambda) < 0.$$

By using the same functional form for $\mu(I)$ we represent the different expected payoff functions in Figure 4.5.2

4.E Welfare

We calculate the total expected welfare evaluated at the private optimal levels of investment.

Under a PBR regime only, we again use the five different areas in Figure 4.4.1 and the corresponding private investment levels reported in table 4.C.1. For instance, in area (1), we calculate the total expected welfare as

$$\begin{aligned} W^{\bar{ND}_1, ND_1} &= \mu(I^{\bar{ND}_1, ND_1})\underline{W}^{ND_1} + (1 - \mu(I^{\bar{ND}_1, ND_1}))\underline{W}^{ND_1} - I^{\bar{ND}_1, ND_1} \\ &= \mu(I^{\bar{ND}_1, ND_1})2(\bar{\theta} - \underline{\theta})\pi + 2\underline{\theta}\pi - I^{\bar{ND}_1, ND_1}. \end{aligned}$$

As $I^{\bar{ND}_1, ND_1}$ does not depend on τ , $\bar{W}^{\bar{ND}_1, ND_1}$ is also not depending on τ .

In area (2), the total expected welfare is

$$\begin{aligned} W^{\overline{ND}_1, ND_1} &= \mu(I^{\overline{ND}_2, ND_1}) \underline{W}^{ND_1} + (1 - \mu(I^{\overline{ND}_2, ND_1})) \underline{W}^{ND_1} - I^{\overline{ND}_2, ND_1} \\ &= \mu(I^{\overline{ND}_2, ND_1}) 2(\bar{\theta} - \underline{\theta})\pi + 2\underline{\theta}\pi - I^{\overline{ND}_2, ND_1}. \end{aligned}$$

The optimal investment $I^{\overline{ND}_2, ND_1}$ increases with τ , and thus

$$\frac{\partial W^{\overline{ND}_1, ND_1}}{\partial \tau} = \frac{\partial I^{\overline{ND}_2, ND_1}}{\partial \tau} (\mu'(I^{\overline{ND}_2, ND_1}) 2(\bar{\theta} - \underline{\theta})\pi - 1) > 0,$$

as $\mu'(I^{\overline{ND}_2, ND_1}) 2(\bar{\theta} - \underline{\theta})\pi - 1 > 0$.

For each area we calculate the expected welfare evaluated at the optimal levels of investment. We use the functional form $\mu(I) = (1 - \exp^{-I})$ and Mathematica to represent Figure 4.5.3

4.F Payoffs with heterogeneous farmers

Table 4.F.1: Results with heterogeneous farmers

Strategies and payoff	Results
Non Durable Good Strategy	
Farmers surplus at $t = 2$ with breeder's variety	$-\frac{((\lambda-1)\tau+\theta(\bar{\phi}-1)\pi)(\theta(\bar{\phi}+1)\pi-(\lambda+1)\tau)}{4\theta\pi(\bar{\phi}-\underline{\phi})}$
Farmers surplus at $t = 2$ with farm-saved seeds	$\frac{((\lambda-1)\tau+\theta\pi(2\bar{\phi}-\underline{\phi}-1))(\theta\pi(2\bar{\phi}+\underline{\phi}+1)-(\lambda+3)\tau)}{8\theta\pi(\bar{\phi}-\underline{\phi})}$
Breeder's payoff $\equiv \Pi^{ND_2}$	$\frac{(\lambda-1)^2\tau^2-2\theta\pi\tau(\lambda-2\lambda\bar{\phi}+\lambda\underline{\phi}+\underline{\phi}-1)+\theta\pi(\theta\pi(4\bar{\phi}+(\underline{\phi}-6)\underline{\phi}+1)+4\pi\tau(\underline{\phi}-\bar{\phi}))}{4\theta\pi(\bar{\phi}-\underline{\phi})}$
Welfare	$\frac{3(\lambda-1)^2\tau^2+\theta^2\pi^2(4\bar{\phi}^2+8\bar{\phi}-\underline{\phi}^2-14\underline{\phi}+3)+2\theta(\lambda-1)\pi\tau(4\bar{\phi}-\underline{\phi}-3)}{8\theta\pi(\bar{\phi}-\underline{\phi})}$
Non Durable Good Strategy with the maximum price	
Farmers surplus at $t = 2$ with breeder's variety	$\frac{\pi_0\left(\frac{\pi_0+\tau}{\theta\pi}-\underline{\phi}\right)}{\bar{\phi}-\underline{\phi}}$
Farmers surplus at $t = 2$ with farm-saved seeds	$\frac{(\tau-\theta\bar{\phi}\pi)^2-\pi_0^2}{2\theta\pi(\bar{\phi}-\underline{\phi})}$
Breeder's payoff $\equiv \Pi^{ND_1}$	$\frac{-\lambda\tau^2+(-(\pi_0-\theta\pi))(\theta\pi(\bar{\phi}-2\underline{\phi})+\pi_0)+\tau(\theta\pi(\lambda\bar{\phi}+1)-(\lambda+1)\pi_0)}{\theta\pi(\bar{\phi}-\underline{\phi})}$
Welfare	$\frac{-2\lambda\tau^2+\theta^2\bar{\phi}^2\pi^2+2\theta\bar{\phi}\pi((\lambda-1)\tau+\theta\pi)-4\theta^2\bar{\phi}\pi^2+2\theta\pi\tau+2\pi_0(\theta\pi-\lambda\tau)-\pi_0^2+\tau^2}{2\theta\pi(\bar{\phi}-\underline{\phi})}$
Durable Good Strategy	
Farmers surplus with breeder's variety at $t = 2$	$-\frac{((\lambda-1)\tau+\theta\bar{\phi}\pi+7\pi_0)(-\lambda\tau-\theta\bar{\phi}\pi+\pi_0+\tau)}{8\theta\pi(\bar{\phi}-\underline{\phi})}$
Farmers surplus with farm-saved seeds at $t = 2$	$\frac{\pi_0(-\lambda\tau+\theta\pi(\bar{\phi}-2\underline{\phi})+\pi_0+\tau)}{\theta\pi(\bar{\phi}-\underline{\phi})}$
Breeder's payoff $\equiv \Pi^D$	$\frac{(\lambda-1)^2\tau^2+\theta^2\pi^2(\bar{\phi}(\bar{\phi}+4)-4\underline{\phi})+2\pi_0(-\lambda\tau-3\theta\bar{\phi}\pi+2\theta\underline{\phi}\pi+\tau)+2\theta(\lambda-1)\bar{\phi}\pi\tau+\pi_0^2}{4\theta\pi(\bar{\phi}-\underline{\phi})}$
Welfare	$\frac{3(\lambda-1)^2\tau^2+\theta^2\pi^2(\bar{\phi}(3\bar{\phi}+8)-8\underline{\phi})+2\theta\pi\pi_0(\bar{\phi}-4\underline{\phi})+6\theta(\lambda-1)\bar{\phi}\pi\tau+3\pi_0^2-6(\lambda-1)\pi_0\tau}{8\theta\pi(\bar{\phi}-\underline{\phi})}$

Chapter 5

Conclusion

L'innovation est cruciale pour la croissance et le développement économique à long terme. Pour soutenir et favoriser une économie innovante, les puissances publiques ont mis en place des Droits de Propriété Intellectuelle (DPI). Ceux-ci permettent d'inciter les entreprises à investir et prendre des risques pour créer de nouveaux produits ou de nouveaux procédés de production. Le secteur des semences, comme il a été discuté dans les différents chapitres, n'est pas une exception. Tout d'abord, les règles de commercialisation comme le catalogue, en Europe, ou l'obligation d'afficher certaines caractéristiques des semences vendues, aux États-Unis, ont permis d'apporter des informations crédibles nécessaires au développement du marché des semences. Ensuite, la mise en place de droit de propriété intellectuelle dans ce secteur avec les Certificats d'Obtention Végétale (COV) et les brevets d'invention a créé des incitations pour le secteur privé à investir dans la création variétale. Comme il a été vu dans l'introduction, les dépenses en R&D pour la création variétale dans les pays développés sont dorénavant plus importantes dans le secteur privé que dans le secteur public. L'évolution de la réglementation a donc donné les moyens nécessaires aux entreprises privées pour se développer dans ce secteur, même s'il est parfois difficile de trouver un lien direct entre l'augmentation des dépenses en R&D du secteur privé et la mise en place d'une réglementation qui leur est plus favorable.

Toutefois, des choix différents ont été réalisés pour permettre au secteur privé de se développer, que ce soit au niveau de la réglementation commerciale ou des droits de propriété intellectuelle. Ainsi, l'Europe a fait le choix d'une réglementation très stricte au niveau commercial et a établi des droits de propriété intellectuelle *sui generis*, avec d'importantes exemptions par rapport à un système de brevets. À l'inverse, les États-Unis ont préféré une réglementation commerciale plus souple et, au contraire de l'Europe, ils ont permis de breveter les variétés végétales tout en donnant également la possibilité de protéger les innovations avec un COV pour certaines espèces. Les trois chapitres de cette thèse ont analysé les conséquences de ces choix en termes de réglementations et ont tenté de les comparer afin d'identifier le meilleur système de réglementation permettant un niveau d'innovation optimale.

Le second chapitre présente une analyse empirique des COV. Plus précisément, il comble un vide sur la quantification de l'importance économique des COV. En effet, il fournit une estimation de la valeur des COV pour six grandes cultures en France en utilisant une méthode économétrique basée sur les décisions de renouvellement. Cette méthode a d'abord été introduite par Schankerman et Pakes (1986), puis approfondie par de nombreux auteurs (dont Barney, 2002 ; Bessen, 2008 ; Baudry et Dumont, 2012) pour analyser la valeur des brevets. Dans le but d'insérer des variables micro-économiques influençant la valeur des COV, la méthode utilisée dans le premier chapitre s'inspire essentiellement de celle proposée par Baudry et Dumont (2012). Comme pour les brevets, le maintien d'un COV passe par le paiement d'une annuité. Si l'obtenteur ne s'acquitte pas de cette annuité alors son COV tombe dans le domaine public. En faisant l'hypothèse que l'obtenteur est un agent rationnel il doit alors continuer de payer l'annuité tant que celle-ci n'excède pas les gains que lui apportera le maintien de son droit. Les informations tirées de ce comportement révèlent indirectement la valeur des COV.

Les résultats montrent que, conformément à la littérature sur les brevets et les études de Srinivasan (2003, 2012), la majorité des COV ont une valeur très faible tandis qu'un nombre restreint d'entre eux a une très forte valeur. Au-delà de la mise en évidence d'une forte asymétrie de la distribution de la valeur des COV, la méthode appliquée à l'originalité de permettre d'estimer l'effet de variables spécifiques non seulement à la cohorte mais aussi à chaque COV. Les renouvellements de COV ont été étudiés séparément pour les six espèces agricoles traitées dans le chapitre. L'étude montre ainsi que l'arrivée des COV européens ont eu un effet négatif sur la rente initiale, probablement du fait d'une auto-sélection induisant que les meilleures variétés parmi les nouvelles variétés créées sont dorénavant protégées directement au niveau européen plutôt qu'au niveau national (excepté pour le tournesol). De plus, les COV appartenant à des sociétés françaises s'avèrent avoir une valeur plus forte pour le maïs, le tournesol et les pommes de terre mais une valeur plus faible pour le blé et le colza (aucun effet pour le pois).

L'introduction de variables micro-économiques, permet surtout d'examiner l'effet de l'exemption de recherche et de l'exemption de l'agriculteur. En effet, il est supposé que si l'exemption de l'agriculteur était levée, alors la demande de semence augmenterait, *ceteris paribus*. L'augmentation de la demande passe par l'augmentation de la surface allouée aux cultures à prix inchangé, ce qui a un effet sur la rente initiale des COV. Afin de contrôler l'effet prix, les prix des cultures ont également été introduits comme déterminant de la rente initiale. Dans ce cadre, l'arrêt de l'exemption de l'agriculteur augmenterait la valeur des COV de 3 à 5% pour les pommes de terre, d'environ 10% pour les pois et de plus de 50% pour le colza. Concernant les autres variétés, l'effet n'a pas pu être analysé, soit parce que le coefficient de la variable de surface allouée n'avait pas le bon signe (cas du blé), soit parce que les semences hybrides représentent déjà l'essentiel du marché, (cas du maïs et du tournesol). L'effet de l'exemption de recherche est analysé à travers son influence sur le taux de dépréciation de la rente. Il faut rappeler que cette exemption permet aux concurrents de se servir de la variété protégée pour en créer une autre sans avoir besoin de l'autorisation de l'obteneur. Ainsi, l'impact de cette exemption est estimé en combinant l'effet de l'arrivée de nouvelles variétés concurrentes et de la sortie de variétés concurrentes sur le taux de dépréciation de la rente initiale. Pour que l'exemption de recherche ait un effet négatif et, par conséquent, augmente le taux de dépréciation, il faut que ces deux variables augmentent globalement le taux de dépréciation. Ce résultat est seulement obtenu pour le maïs où la concurrence semble être plus forte au vu du nombre de COV beaucoup plus important pour cette espèce que pour les cinq autres étudiées. Cette étude montre donc que l'exemption de l'agriculteur semble avoir un effet plus important sur la valeur des COV que l'exemption de recherche.

Le troisième chapitre développe une étude théorique de l'exemption de recherche avec une application empirique pour le cas du blé en France. La singularité de cette analyse est de prendre en compte l'effet de la réglementation commerciale conjointement à celle des DPI ainsi que l'effet des ces réglementations sur la biodiversité. La demande des agriculteurs est d'abord modélisée à l'aide d'un modèle de différenciation

verticale provenant de Prescott et Visscher (1977) qui permet de prendre en compte la différence en terme de réglementation commerciale entre l'Europe et les États-Unis. La biodiversité est introduite en ayant un effet endogène *via* la productivité des agriculteurs. Ensuite, l'offre des semenciers est modélisée différemment selon le type de DPI, brevets ou COV. Avec un COV, l'exemption de recherche permet à un concurrent d'entrer sur le marché à la seconde période, alors qu'avec un brevet et donc sans exemption de l'agriculteur, l'innovateur de la première période restera en monopole lors de la seconde période car l'innovation sur le marché des semences est particulièrement incrémentale. Le comportement stratégique des semenciers est analysé à l'étape amont de R&D en prenant en compte un coût fixe de R&D et un taux de réussite exogène de l'innovation. Le régulateur public peut choisir entre plusieurs couples de réglementations sur les DPI et les règles commerciales. Son choix se fait en intégrant le comportement stratégique des semenciers avec pour objectif de maximiser le bien-être.

Dans un cadre statique, en simulant les quatre couples possibles de réglementations, le chapitre montre que le couple COV/standards minimum apporte le bien-être le plus élevé grâce à des profits plus importants de la part des agriculteurs. Cela est dû à des prix plus faibles pratiqués par les semenciers. Cependant, l'indice de la biodiversité est le plus élevé dans le cadre brevet/standards minimum bien que, sous un système de brevets, il n'y a que deux variétés sur le marché tandis qu'avec un COV il y en a trois. Ce résultat provient du fait que les parts de marché sont plus également réparties avec un système de brevets qu'avec un système de COV. Ensuite, dans le cadre dynamique, un résultat proche de celui obtenu par Moshini et Yerokhin (2008) apparaît. Avec un coût fixe de R&D faible, il est préférable d'avoir un système de COV alors qu'avec un coût fixe de R&D élevé un système de brevet semble socialement préférable. Plus surprenant, la situation européenne avec le couple de réglementation COV/catalogue n'est quasiment jamais optimale. En réalité, les couples de réglementation les plus souvent optimaux pour la société sont le couple COV/standards minimum lorsque la probabilité de succès est élevée et le coût fixe de R&D faible et le couple brevet/standards lorsque la probabilité de succès et le coût fixe de R&D sont élevés. En analysant le choix op-

timal pour les semenciers et non pas pour la société dans son ensemble, on remarque également que les semenciers préfèrent un système de COV lorsque les coûts fixes de R&D sont faibles et la probabilité de succès n'est pas trop élevée. Il faut noter que ce choix de système de DPI est en adéquation avec le choix du régulateur. On conclut, que le système américain offrant plus de flexibilité dans le choix des DPI pour les semenciers semble comme être préférable pour la société au système européen. Ce résultat est d'autant plus marquant que le modèle a été calibré sur données françaises.

Le quatrième chapitre analyse la seconde exemption d'un système de COV, à savoir l'exemption de l'agriculteur autorisant les semences de ferme, même sur les variétés protégées par un COV. Les semences de ferme apportent une forme de durabilité au bien. Pour prendre en compte cet aspect, le chapitre 4 s'appuie donc sur une partie de la littérature utilisant une modélisation théorique des biens durables (e.g. Ambec et al., 2008). Deux points importants sont apportés à la modélisation. D'abord, il y a une étape de R&D. Ensuite, il y a un choix entre deux formes de droit de propriété intellectuelle, soit un système de COV autorisant les semences de ferme, soit un système de brevets interdisant les semences de ferme mais plus onéreux à obtenir pour le semencier qu'un COV. Dans le cadre où le semencier choisit le système de COV pour protéger son innovation il doit, ensuite, choisir entre deux stratégies différentes : soit une stratégie de bien durable où il incite les agriculteurs à n'acheter qu'en première période et, ensuite, à la seconde période les agriculteurs utilisent des semences de ferme ; soit une stratégie de bien non durable où le semencier doit choisir les prix pour la première et la seconde périodes qui incitent les agriculteurs à ne pas utiliser de semences de ferme. Enfin, à l'image de la CVO en France mais aussi d'autres systèmes de *royalty* sur les semences de ferme, une taxe sur les semences de ferme est introduite. Elle est supposée être redistribuée à l'innovateur, soustraction faite du coût administratif.

Dans ce cadre, lorsque le semencier a le choix entre un système de brevets ou un système de COV, il ne choisira pas toujours un système de brevets bien que celui-ci protège plus efficacement son innovation. Dans certain cas où l'agriculteur reste très

productif en utilisant des semences de ferme et où la taxe n'est pas très élevée, le semencier conservera une stratégie de bien durable et préférera donc que les agriculteurs utilisent des semences de ferme à la seconde période. L'introduction d'un système de brevets peut permettre d'augmenter les incitations à innover et diminue les situations d'investissement sous optimal d'un point de vue social, sans toutefois les faire complètement disparaître. L'introduction d'une taxe sur les semences de ferme peut faire augmenter les incitations à innover, notamment lorsque celle-ci fait passer le semencier d'une stratégie de bien durable à une stratégie de bien non durable. Cependant, certains niveaux de la taxe peuvent avoir un effet contreproductif. En effet, si la stratégie choisie par le semencier est celle des biens durables et si l'introduction de la taxe ou son augmentation n'implique pas de changement dans le comportement du semencier, alors cela diminuera les gains des agriculteurs. En conséquence, les semenciers devront diminuer leur tarification pour prendre en compte le manque à gagner des agriculteurs. Pour conclure, comme pour le chapitre précédent, le système américain offre donc une flexibilité plus importante dans le choix des DPI, ce qui permet d'augmenter les incitations à innover d'une façon plus importante que ne le fait l'introduction d'une taxe sur les semences de ferme.

Les trois chapitres de la thèse peuvent donner des indices pour améliorer le système actuel de réglementation sur le marché des semences. Il faut d'abord noter que la réglementation commerciale et les règles sur les DPI ont en parallèle à leur implication économique des implications éthiques qui doivent être prises en compte dans le choix des politiques économiques qui seront ensuite menées. Les trois chapitres de la thèse s'intéressent seulement aux conséquences économiques de la réglementation sur le marché des semences. C'est donc dans ce cadre, purement économique, que des suggestions sont réalisées pour perfectionner le système de réglementation actuel.

La théorie économique a montré la nécessité de créer un signal crédible pour rendre compte de la nature et de la qualité des produits commercialisés. Cependant, il n'est pas nécessaire de rendre ce signal obligatoire. Or, dans la législation européenne, l'en-

enregistrement dans le catalogue est obligatoire et les conditions à respecter pour y être inscrit sont très strictes. En conséquence, les variétés anciennes et/ou de population ne peuvent bien souvent plus être commercialisées en Europe, alors que ce sont celles-ci qui apportent la diversité génétique la plus importante. En effet, elles sont tout d'abord à l'origine des variétés modernes et ensuite elles sont intrinsèquement hétérogènes alors que les variétés modernes ont, compte tenu des règles de commercialisations, une nature beaucoup plus homogène qui n'est probablement pas compensée par la diversité inter-variété. Le chapitre 3 montre que la législation en vigueur en Europe n'est vraisemblablement pas celle qui apporte dans la majorité des cas, l'optimum social. L'Europe a, depuis peu et suite à la signature de la convention sur la diversité biologique et à son adhésion au traité international sur les ressources phytogénétiques pour l'alimentation et l'agriculture, créé un registre pour les variétés de « conservation » destiné à prendre en compte les spécificités des variétés de population anciennes et/ou locales. Toutefois, l'enregistrement dans ce registre a un coût alors que ce ne sont pas les industriels du secteur qui fournissent ces variétés de population mais plutôt des associations paysannes. Il serait donc plus simple de rendre l'enregistrement dans le catalogue volontaire, qui suffit à donner un gage crédible pour les industriels du secteur sans pour autant empêcher la commercialisation des variétés plus hétérogènes. De cette manière, la conservation de la biodiversité *in situ* serait renforcée. Concernant les DPI, les chapitres 3 et 4 ont montré que donner plus de flexibilité aux semenciers quant au choix de l'instrument à utiliser, brevet ou COV, permet d'atteindre un niveau de dépense en R&D et de bien-être socialement plus optimaux qu'une situation où seul un système de COV peut être utilisé. Un certain nombre de pays permettent déjà de breveter une variété végétale sans pour autant empêcher le recours aux COV. C'est notamment le cas des États-Unis, mais l'Europe s'est quant à elle jusqu'à présent montrée réticente à l'autorisation de breveter des variétés végétales. Cependant, les choses pourraient évoluer dans les prochaines années, comme en témoigne la décision très récente de l'EPO qui a autorisé la brevetabilité des produits d'une variété végétale, les semences en faisant

partie¹. La flexibilité de choisir le système de DPI qu'ils jugent le plus adéquat pour les variétés qu'ils ont créé génère une forme d'autosélection de la part des semenciers et il conviendrait donc d'étudier comment différencier les deux systèmes de DPI de sorte à utiliser de manière socialement optimal l'information révélé par les semenciers. Cela appellerait à introduire des notions d'asymétrie d'information quant à l'effort de R&D entre les semenciers et le régulateur en prolongement des chapitres 3 et 4.

Les analyses développées dans cette thèse se sont particulièrement attachées à l'analyse des implications de la réglementation commerciale et des DPI dans les pays développés. Ces questions sont également cruciales dans les pays en développement, suite notamment aux accords internationaux sur la protection des droits intellectuels dans le cadre de l'OMC qui imposent la création de DPI pour les variétés végétales. L'impact de la réglementation sur le secteur des semences n'est pas le même dans ces pays car le secteur agricole a encore un poids non négligeable dans l'activité de ces pays. Tester le modèle théorique du chapitre 3 en s'appuyant sur un calibrage sur un pays en développement et pour des variétés cohérentes à ce pays pourrait être révélateur de ces différences. Il serait également intéressant de développer plus amplement les effets de la biodiversité sur la productivité agricole. Il faudrait pour cela développer un modèle d'interaction spatiale où la biodiversité aurait des effets de *spillover*. Enfin, dans la thèse, le choix a été fait de séparer l'analyse théorique des deux exemptions du système de COV mais il serait également intéressant dans une future contribution d'inclure les deux exemptions dans le même modèle. Pour cela il faudrait différencier les agriculteurs quant à leur choix d'utiliser ou non des semences de ferme et introduire une course à l'innovation dans l'étape de recherche et développement.

1. La décision est accessible sur http://www.ip-watch.org/2015/04/01/epo-backs-patents-on-conventional-plants-broccoli-tomato-cases-decided/?utm_source=IP-Watch+Subscribers&utm_campaign=73816812f8-MONTHLY_SUMMARY&utm_medium=email&utm_term=0_b78685696b-73816812f8-352155405, dernier accès en mars 2015.

Thèse de Doctorat

Adrien HERVOUET

Les implications de la réglementation sur le marché des semences et l'innovation : Les Droits de Propriété Intellectuelle et les règles de commercialisation

The Implications of the regulation on the seed market and innovation: The Intellectual Property Rights and commercialization rules

Résumé

La thèse s'intéresse aux implications des réglementations sur le marché des semences. Deux types de réglementations sont analysés : la réglementation commerciale et les droits de propriété intellectuelle. Concernant la réglementation commerciale des différences sont à noter entre les règles européennes, très strictes, et les règles américaines qui sont plus souples. Des voies divergentes ont également été prises entre l'Europe et les États-Unis pour la mise en place de droits de propriété intellectuelle sur ce secteur. En effet, en Europe seul un droit *sui generis* est disponible pour protéger une variété végétale alors qu'aux États-Unis les brevets sont également disponibles. Le premier chapitre présente une estimation économétrique de la valeur des certificats d'obtention végétale en France. Le résultat principal de cette étude est que l'exemption de l'agriculteur semble avoir un effet plus important que l'exemption de recherche. Le second chapitre analyse l'ensemble des réglementations et s'intéresse plus spécifiquement à l'exemption de recherche. Il analyse également leurs impacts sur la biodiversité. Ce chapitre montre que le système américain offrant plus de souplesse en terme de choix de droits de propriété intellectuelle est plus optimal que le système européen. Le troisième chapitre utilise un modèle théorique différenciant des stratégies de bien durable et de bien non-durable adoptées par le semencier. Il permet de prendre en compte l'une des spécificités de ce marché : les semences de ferme. Ce chapitre montre également que le système américain permet d'obtenir un niveau de dépense en R&D plus optimal que le système européen.

Mots clés

Variété Végétale, Droit de Propriété Intellectuelle, Certificat d'Obtention Végétale, Innovation, Biodiversité, Exemption de recherche, Exemption de l'agriculteur, Catalogue

Abstract

This thesis focuses on the implications of regulations on the seed market. Two kinds of regulation are analyzed: commercialization rules and intellectual property rights. Regarding commercialization rules, differences exist between European rules, very strict, and U.S. rules, more flexible. Divergent paths have also been taken between Europe and the U.S. for the establishment of intellectual property rights in this sector. Indeed, in Europe only a *sui generis* right is available to protect a plant variety while in the U.S. patents are also available. The first chapter presents an econometric estimation of the value of plant breeders' rights in France. The main result of this study is that the farmers' exemption seems to have a higher effect than the research exemption. The second chapter analyzes all the regulations and focuses specifically on the research exemption. It also analyzes their impacts on biodiversity. This chapter shows that the U.S. system, which provides more flexibility in terms of choice of intellectual property rights, is more optimal than the European system. The third chapter uses a theoretical model that differentiates durable good strategies and non-durable goods strategies adopted by the innovator. It allows to take into account one of the specificity of this market: farm-saved seeds. This chapter also shows that the U.S. system provides a level of R&D expenditures more optimal than the European system.

Key Words

Plant Variety, Intellectual Property Right, Plant Breeders' Rights, Innovation, Biodiversity, Research Exemption, Farmers' Exemption, Catalogue