

UNIVERSITÉ PARIS-SORBONNE  
ÉCOLE DOCTORALE VI, HISTOIRE ET ARCHÉOLOGIE  
Laboratoire de recherche UMR 8167, Orient et Méditerranée

JOHANN WOLFGANG GOETHE UNIVERSITÄT-FRANKFURT AM MAIN  
Fachbereich Sprach- und Kulturwissenschaften  
Archäologie des vorderen Orients

## THÈSE

pour obtenir le grade de

DOCTEUR DE L'UNIVERSITÉ PARIS-SORBONNE

Discipline : Archéologie du Proche-Orient ancien

## INAUGURALDISSERTATION

zur Erlangung des Grades eines DOKTORS DER PHILOSOPHIE

IM SPRACH- UND KULTURWISSENSCHAFTEN DER GOETHE-UNIVERSITÄT ZU FRANKFURT AM MAIN

Présentée par / vorgelegt von :

**Taos BABOUR**

et soutenue le : 28 mars 2017

**Traditions céramiques en Jezira occidentale au III<sup>e</sup>  
mill. av. J.-C. : la poterie du secteur B de Tell Chuera**  
Vol. 3/3 : Catalogue

**Sous la cotutelle de :**

M. Jan-Waalke MEYER – Professeur, Goethe-Universität zu Frankfurt am Main

M. Jean-Yves MONCHAMBERT – Professeur, Université Paris-Sorbonne

**Membres du jury :**

Mme Christine KEPINSKI – Directrice de Recherche, CNRS

M. Alexander PRUß – Professeur, Gutenberg-Universität zu Mainz am Rhein

M. Philippe QUENET – Professeur, Université de Strasbourg



## Présentation du volume III - Catalogue

Ce troisième volume (vol.III) contient le catalogue du corpus étudié. Les données y sont présentées par niveau et par *Fundstelle*. Face à la première planche de chaque *Fundstelle*, une vignette permet de visualiser sa localisation, ainsi que le tableau récapitulatif du nombre de restes (NR), du nombre minimum de vases (NMI) et du nombre de tessons diagnostiques associés aux principaux groupes céramiques. Face à chacune des planches, un tableau de description précise, pour chaque item illustré : le numéro de tesson ou d'objet (ID poterie), le type morphologique (forme), le groupe céramique (céra.), le code des étapes de la chaîne opératoire auxquelles sont associées les macrotraces identifiées (MT) et, lorsqu'il a pu être déterminé, celui de la séquence de façonnage associée (S), le type de décor (décor), le groupe de cuisson (cui.), le type (gravé ou incisé) et la position des marques (de potier ou non) éventuellement présentes sur les vases.





## Table du catalogue

Planche 1 : Poteries de la FS TCH96B48 - Bauphase 5 .....	11
Planche 2 : Poteries de la FS TCH96B48 - Bauphase 5 (suite).....	13
Planche 3 : Poteries de la FS TCH98B11 - Bauphase 5 .....	15
Planche 4 : Poteries de la FS TCH98B11 - Bauphase 5 (suite).....	17
Planche 5 : Poteries de la FS TCH98B22 - Bauphase 5 .....	19
Planche 6 : Poteries de la FS TCH98B22 - Bauphase 5 (suite).....	21
Planche 7 : Poteries de la FS TCH98B24 - Bauphase 5 .....	23
Planche 8 : Poteries de la FS TCH98B24 - Bauphase 5 (suite).....	25
Planche 9 : Poteries de la FS TCH98B24 - Bauphase 5 (suite).....	27
Planche 10 : Poteries de la FS TCH9827 - Bauphase 5 .....	29
Planche 11 : Poteries de la FS TCH9827 - Bauphase 5 (suite).....	31
Planche 12 : Poteries de la FS TCH98B35 - Bauphase 5 .....	33
Planche 13 : Poteries de la FS TCH98B35 - Bauphase 5 (suite).....	35
Planche 14 : Poteries de la FS TCH99B18 - Bauphase 5 .....	37
Planche 15 : Poteries de la FS TCH99B18 - Bauphase 5 (suite).....	39
Planche 16 : Poteries de la FS TCH99B18 - Bauphase 5 (suite).....	41
Planche 17 : Poteries de la FS TCH99B29 - Bauphase 5 .....	43
Planche 18 : Poteries de la FS TCH99B42 - Bauphase 5 .....	45
Planche 19 : Poteries de la FS TCH96B42 - Bauphase 4b .....	47
Planche 20 : Poteries de la FS TCH96B42 - Bauphase 4b (suite).....	49
Planche 21 : Poteries de la FS TCH96B52 - Bauphase 4b .....	51
Planche 22 : Poteries de la FS TCH98B13 - Bauphase 4b .....	53
Planche 23 : Poteries de la FS TCH98B13 - Bauphase 4b (suite).....	55
Planche 24 : Poteries de la FS TCH98B13 - Bauphase 4b (suite).....	57
Planche 25 : Poteries de la FS TCH98B13 - Bauphase 4b (suite).....	59
Planche 26 : Poteries de la FS TCH98B15 - Bauphase 4b .....	61
Planche 27 : Poteries de la FS TCH98B15 - Bauphase 4b (suite).....	63
Planche 28 : Poteries de la FS TCH98B15 - Bauphase 4b (suite).....	65
Planche 29 : Poteries de la FS TCH98B16 - Bauphase 4b .....	67
Planche 30 : Poteries de la FS TCH98B17 - Bauphase 4b .....	69
Planche 31 : Poteries de la FS TCH98B17 - Bauphase 4b (suite).....	71
Planche 32 : Poteries de la FS TCH98B18 - Bauphase 4b .....	73
Planche 33 : Poteries de la FS TCH98B19 - Bauphase 4b .....	75

Planche 34 : Poteries de la FS TCH98B21 - Bauphase 4b .....	77
Planche 35 : Poteries de la FS TCH98B21 - Bauphase 4b (suite) .....	79
Planche 36 : Poteries de la FS TCH98B21 - Bauphase 4b (suite) .....	81
Planche 37 : Poteries de la FS TCH98B21 - Bauphase 4b (suite) .....	83
Planche 38 : Poteries de la FS TCH98B21 - Bauphase 4b (suite) .....	85
Planche 39 : Poteries de la FS TCH98B21 - Bauphase 4b (suite) .....	87
Planche 40 : Poteries de la FS TCH98B21 - Bauphase 4b (suite) .....	89
Planche 41 : Poteries de la FS TCH98BB23 - Bauphase 4b .....	91
Planche 42 : Poteries de la FS TCH98BB23 - Bauphase 4b (suite) .....	93
Planche 43 : Poteries de la FS TCH98BB23 - Bauphase 4b (suite) .....	95
Planche 44 : Poteries de la FS TCH98BB23 - Bauphase 4b (suite) .....	97
Planche 45 : Poteries de la FS TCH98BB23 - Bauphase 4b (suite) .....	99
Planche 46 : Poteries de la FS TCH98B25 - Bauphase 4b .....	101
Planche 47 : Poteries de la FS TCH98B26 - Bauphase 4b .....	103
Planche 48 : Poteries de la FS TCH98B26 - Bauphase 4b (suite) .....	105
Planche 49 : Poteries de la FS TCH98B26 - Bauphase 4b (suite) .....	107
Planche 50 : Poteries de la FS TCH98B26 - Bauphase 4b (suite) .....	109
Planche 51 : Poteries de la FS TCH98B33 - Bauphase 4b .....	111
Planche 52 : Poteries de la FS TCH98B33 - Bauphase 4b (suite) .....	113
Planche 53 : Poteries de la FS TCH98B40 - Bauphase 4b .....	115
Planche 54 : Poteries de la FS TCH98B40 - Bauphase 4b (suite) .....	117
Planche 55 : Poteries de la FS TCH98B40 - Bauphase 4b (suite) .....	119
Planche 56 : Poteries de la FS TCH98B40 - Bauphase 4b (suite) .....	121
Planche 57 : Poteries de la FS TCH98B40 - Bauphase 4b (suite) .....	123
Planche 58 : Poteries de la FS TCH98B45 - Bauphase 4b .....	125
Planche 59 : Poteries de la FS TCH99B26 - Bauphase 4b .....	127
Planche 60 : Poteries de la FS TCH99B30 - Bauphase 4b .....	129
Planche 61 : Poteries de la FS TCH99B30 - Bauphase 4b (suite) .....	131
Planche 62 : Poteries de la FS TCH99B30 - Bauphase 4b (suite) .....	133
Planche 63 : Poteries de la FS TCH99B30 - Bauphase 4b (suite) .....	135
Planche 64 : Poteries de la FS TCH99B30 - Bauphase 4b (suite) .....	137
Planche 65 : Poteries de la FS TCH99B38 - Bauphase 4b .....	139
Planche 66 : Poteries de la FS TCH96B14 - Bauphase 4b .....	141
Planche 67 : Poteries de la FS TCH96B15 - Bauphase 4b .....	143
Planche 68 : Poteries de la FS TCH96B15 - Bauphase 4b (suite) .....	145
Planche 69 : Poteries de la FS TCH96B22 - Bauphase 4b .....	147

Planche 70 : Poteries de la FS TCH96B22 - Bauphase 4b (suite) .....	149
Planche 71 : Poteries de la FS TCH96B30 - Bauphase 4b .....	151
Planche 72 : Poteries de la FS TCH96B30 - Bauphase 4b (suite) .....	153
Planche 73 : Poteries de la FS TCH96B39 - Bauphase 4b .....	155
Planche 74 : Poteries de la FS TCH96B39 - Bauphase 4b (suite) .....	157
Planche 75 : Poteries de la FS TCH96B39 - Bauphase 4b (suite) .....	159
Planche 76 : Poteries de la FS TCH96B39 - Bauphase 4b (suite) .....	161
Planche 77 : Poteries de la FS TCH96B40 - Bauphase 4b .....	163
Planche 78 : Poteries de la FS TCH96B40 - Bauphase 4b (suite) .....	165
Planche 79 : Poteries de la FS TCH96B40 - Bauphase 4b (suite) .....	167
Planche 80 : Poteries de la FS TCH96B40 - Bauphase 4b (suite) .....	169
Planche 81 : Poteries de la FS TCH96B40 - Bauphase 4b (suite) .....	171
Planche 82 : Poteries de la FS TCH96B43 - Bauphase 4b .....	173
Planche 83 : Poteries de la FS TCH96B46 - Bauphase 4b .....	175
Planche 84 : Poteries de la FS TCH96B46 - Bauphase 4b (suite) .....	177
Planche 85 : Poteries de la FS TCH96B46 - Bauphase 4b (suite) .....	179
Planche 86 : Poteries de la FS TCH96B46 - Bauphase 4b (suite) .....	181
Planche 87 : Poteries de la FS TCH96B46 - Bauphase 4b (suite) .....	183
Planche 88 : Poteries de la FS TCH96B47 - Bauphase 4b .....	185
Planche 89 : Poteries de la FS TCH96B53 - Bauphase 4b .....	187
Planche 90 : Poteries de la FS TCH98B30 - Bauphase 4b .....	189
Planche 91 : Poteries de la FS TCH98B30 - Bauphase 4b (suite) .....	191
Planche 92 : Poteries de la FS TCH98B30 - Bauphase 4b (suite) .....	193
Planche 93 : Poteries de la FS TCH99B33 - Bauphase 4b .....	195
Planche 94 : Poteries de la FS TCHB6039 - Bauphase 4b .....	197
Planche 95 : Poteries de la FS TCHB6039 - Bauphase 4b (suite) .....	199
Planche 96 : Poteries de la FS TCHB6045 - Bauphase 4b .....	201
Planche 97 : Poteries de la FS TCHB6045 - Bauphase 4b (suite) .....	203
Planche 98 : Poteries de la FS TCHB6045 - Bauphase 4b (suite) .....	205
Planche 99 : Poteries de la FS TCHB6045 - Bauphase 4b (suite) .....	207
Planche 100 : Poteries de la FS TCHB6045 - Bauphase 4b (suite) .....	209
Planche 101 : Poteries de la FS TCHB6045 - Bauphase 4b (suite) .....	211
Planche 102 : Poteries de la FS TCHB6069 - Bauphase 4b .....	213
Planche 103 : Poteries de la FS TCHB6069 - Bauphase 4b (suite) .....	215
Planche 104 : Poteries de la FS TCHB6069 - Bauphase 4b (suite) .....	217
Planche 105 : Poteries de la FS TCHB6074 - Bauphase 4b .....	219

Planche 106 : Poteries de la FS TCHB6074 - Bauphase 4b (suite) .....	221
Planche 107 : Poteries de la FS TCHB6077 - Bauphase 4b .....	223
Planche 108 : Poteries de la FS TCHB6077 - Bauphase 4b (suite) .....	225
Planche 109 : Poteries de la FS TCHB6077 - Bauphase 4b (suite) .....	227
Planche 110 : Poteries de la FS TCHB6077 - Bauphase 4b (suite) .....	229
Planche 111 : Poteries de la FS TCHB6077 - Bauphase 4b (suite) .....	231
Planche 112 : Poteries de la FS TCHB6077 - Bauphase 4b (suite) .....	233
Planche 113 : Poteries de la FS TCHB6077 - Bauphase 4b (suite) .....	235
Planche 114 : Poteries de la FS TCHB6077 - Bauphase 4b (suite) .....	237
Planche 115 : Poteries de la FS TCHB6077 - Bauphase 4b (suite) .....	239
Planche 116 : Poteries de la FS TCH96B27 - Bauphase 3 .....	241
Planche 117 : Poteries de la FS TCH96B27 - Bauphase 3 (suite) .....	243
Planche 118 : Poteries de la FS TCH96B38 - Bauphase 3 .....	245



# Catalogue 1

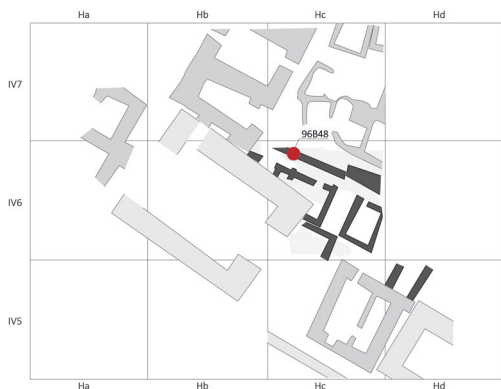

## TCH96B48

Couche de remblai  
R.96B9, R.96B10

		sw	gm	gv	mw	ew
NR	<b>155</b>	127	5	10	13	
NMI	<b>21</b>	17	2	1	1	
DIA	<b>29</b>	24	2	1	2	

n°	IDpoterie	locus	forme	céra.	façonnage		décor	cui.	« marque »	
					MT	S			type	position
1	TCH96B48.9	96B48	bol 01 B b	SW02				A5		
2	TCH96B48.10	96B48	bol 01 B c	SW02				A3		
3	TCH96B48.12	96B48	bol 02 A d	SW07				A5		
4	TCH96B48.7	96B48	bol 02 B b	SW01				A5		
5	TCH96B48.8	96B48	bol 02 B b	SW02				A5		
6	TCH96B48.14	96B48	bol 03 A i	nd				A5		
7	TCH96B48.6	96B48	bol 06 A n	SW01				A5		
8	TCH96B48.1	96B48	bol 03 q	SW07				A5		
9	TCH96B48.4	96B48	pot 03 q	SW07				A5		
10	TCH96B48.5	96B48	pot 03 w	SW10				A2		
11	TCH96B48.13	96B48	vase miniature 06 G	SW01			engobe	A5		
12	TCH96B48.16	96B48	petite jarre 03 A 03	SW13				A5		
13	TCH96B48.26	96B48	goulot	SW04			engobe	A5		
14	TCH96B48.25	96B48	goulot	SW04			engobe	A5		
15	TCH96B48.17+24	96B48	vase à goulot latéral 01 A	SW07			engobe	A5		
16	TCH96B48.19	96B48	jarre OE 03 A 25	SW07				A5		
17	TCH96B48.20	96B48	jarre OL 02 D 19	SW12			engobe	A5		
18	TCH96B48.30	96B48	base 1A	SW01				A5		
n.i.	TCH96B48.32	96B48	base 1A	SW02				A5		
19	TCH96B48.31	96B48	base 1A	SW07				A5		

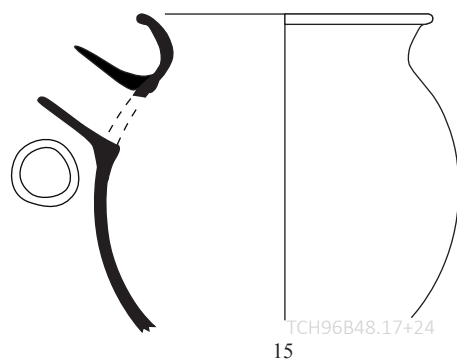
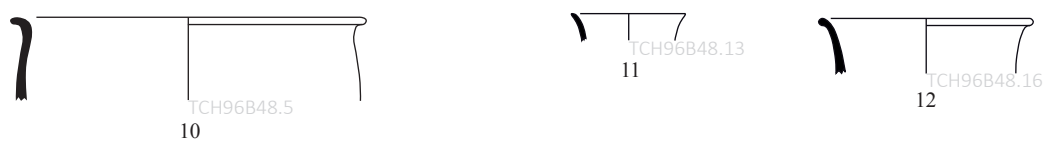
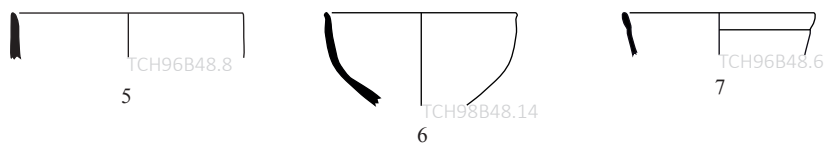
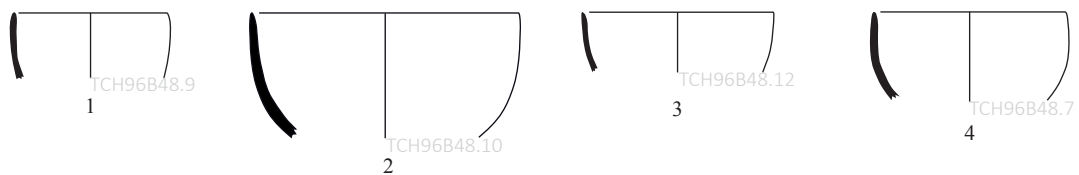

Céramiques communes



Catalogue 2

n°	IDpoterie	locus	forme	céra.	façonnage		décor	cui.	« marque »	
					MT	S			type	position
1	TCH96B48.21	96B48	panse	SW01			peinture sur engobe	A5		
2	TCH96B48.22	96B48	panse	SW13			peinture sur engobe	A5		
3	TCH96B48.33	96B48	panse	SW13			peinture sur engobe	A5		
4	TCH96B48.29	96B48	grande jarre 03 D 47	GV				A2		
5	TCH96B48.27	96B48	marmite 02 A	GM				A5		
6	TCH96B48.28	96B48	marmite 02 B	GM				A1		
7	TCH96B48.15	96B48	coupe (?) 01A i	MW 6			coloration par tournassage ?	A2		
8	TCH96B48.23	96B48	panse	MW 8				A5		





1



2



3

Céramiques communes (suite)

---



TCH96B48.29

4

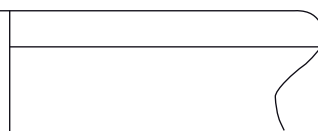

Céramiques à dégraissant végétal grossier (GV)

---



TCH96B48.27

5



TCH96B48.28

6

Céramiques à dégraissant minéral grossier (GM)

---

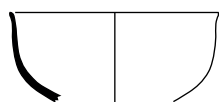

TCH96B48.15

7



8

Céramiques métalliques



### Catalogue 3

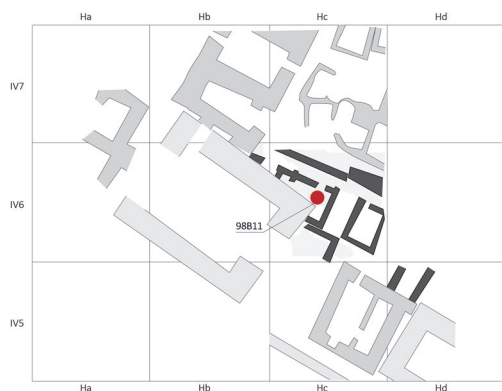

TCH98B11

Espace R96B8

		sw	gm	gv	mw	ew
NR	<b>193</b>	154	17	22	?	
NMI	<b>25</b>	17	5	2	1	
DIA	<b>30</b>	21	5	2	2	

n°	IDpoterie	locus	forme	céra.	façonnage		décor	cui.	« marque »	
					MT	S			type	position
1	TCH98B11.11	98B11	bol bas 01 A b	SW01				A5		
2	TCH98B11.2	98B11	bol bas 02 B e	SW01			engobe	A3		
3	TCH98B11.4	98B11	bol bas 02 A e	SW01				A5		
4	TCH98B11.3	98B11	bol bas 02 C e	SW01	IB-IIB-III125	4		A5		
5	TCH98B11.18	98B11	bol 02 C e	SW02	IB-IIB-III2			A5		
6	TCH98B11.15	98B11	bol bas 03 B i	SW02	III2		pseudo-engobe	A5		
7	TCH98B11.16	98B11	bol 03 A i	SW02	III2b			A5		
8	TCH98B11.40	98B11	bol 04 C q	SW13				A5		
9	TCH98B11.19	98B11	bol 05 A f	SW01	III2			A5		
10	TCH98B11.14	98B11	bol 05 A g	SW01				A5		
11	TCH98B11.20	98B11	bol 05 A g	SW01	IB-IIB-III2			A5		
12	TCH98B11.17	98B11	bol 05 B l	SW01	III2			A5		
13	TCH98B11.28	98B11	vase miniature 06 G	SW01				A5		
14	TCH98B11.29	98B11	vase miniature 06 G	SW01				A5		
15	TCH98B11.41	98B11	vase miniature 07 C	SW01				A5		
16	TCH98B11.38	98B11	vase miniature 09	SW02				A5		
17	TCH98B11.34	98B11	jarre OE 03 A 29	SW05				A1		
18	TCH98B11.36	98B11	nd	SW12				A5		
19	TCH98B11.26	98B11	support	SW07	IB-III12	4	engobe	A2		

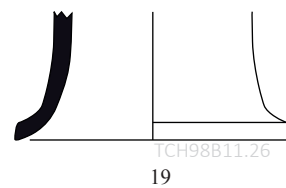
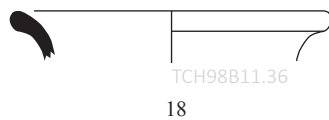
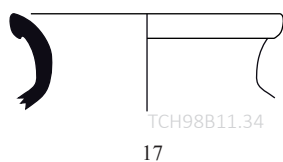
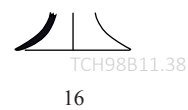
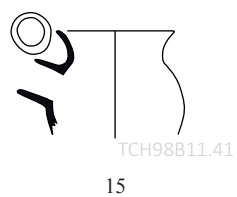
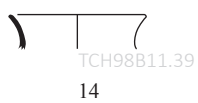
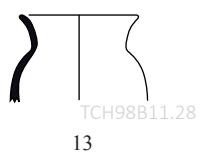
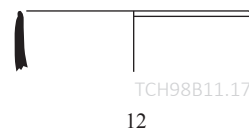
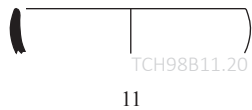
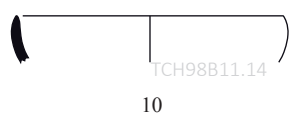
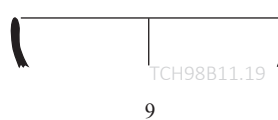
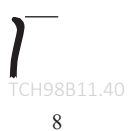
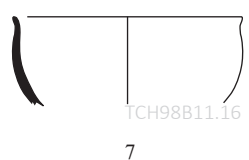
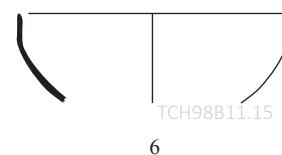
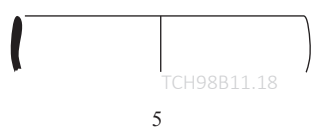
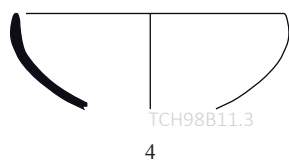
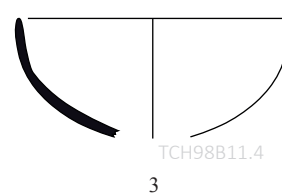
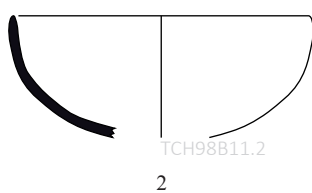
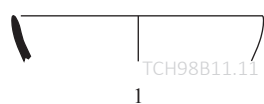

Céramiques communes



Catalogue 4

n°	IDpoterie	locus	forme	céra.	façonnage		décor	cui.	« marque »	
					MT	S			type	position
1	TCH98B11.31	98B11	support 05	SW07	IB-II B-III12	4	engobe	A2		
2	TCH98B11.1	98B11	base 1A	SW01	III12			A5		
3	TCH98B11.32	98B11	jarre OL 02 B 18	GV	IB-II A-III1	2		A5		
4	TCH98B11.33	98B11	grande jarre 01 52	GV	IB-II A-III1	2		A2		
5	TCH98B11.24	98B11	marmite 03	GM	IB-II A-III6b	3		A4		
6	TCH98B11.22	98B11	marmite 03	GM	IB-II A-III6b	3		B3-		
7	TCH98B11.30	98B11	marmite 03	GM				A5		
8	TCH98B11.35	98B11	marmite 03	GM				A2		
9	TCH98B11.25	98B11	marmite 03	GM	IB-II A-III6	3		A5		
10	TCH98B11.21	98B11	bol 06 A n	MW 5	IB-II B		bosselage	B		
11	TCH98B11.10	98B11	base 3A	MW 5	IB2-II B-III4	5		A2		

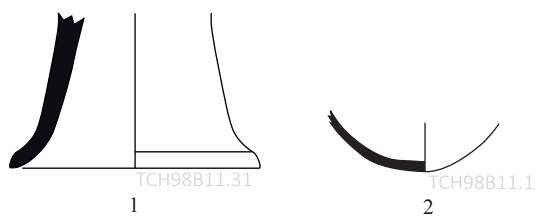

Céramiques communes (suite)

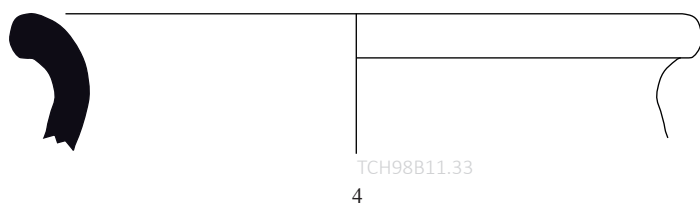
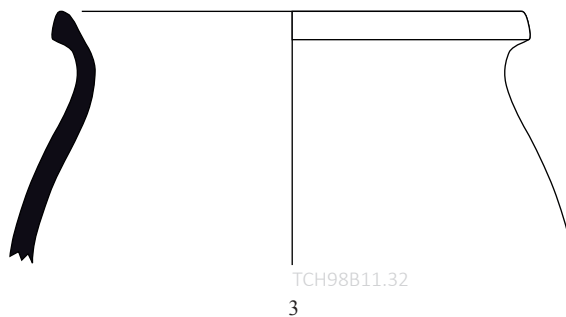

Céramiques à dégraissant végétal grossier (GV)

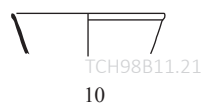
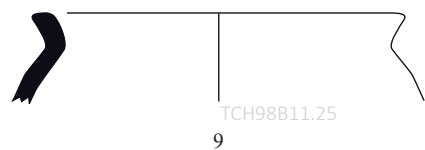
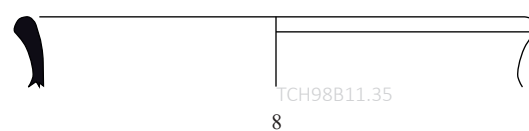
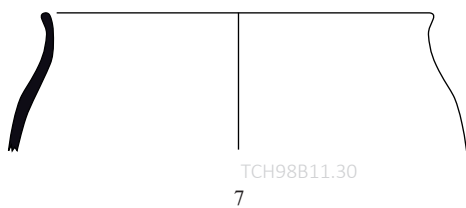
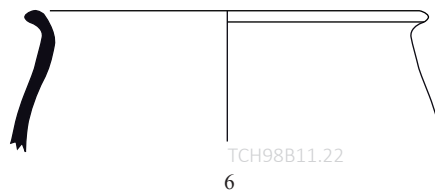
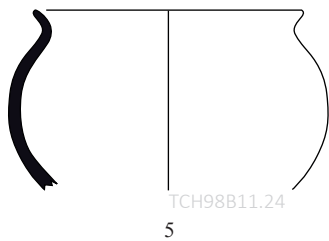

Céramiques à dégraissant minéral grossier (GM)

Céramiques métalliques



Catalogue 5

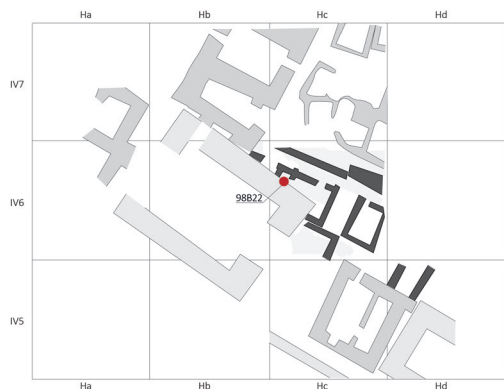

TCH98B22

Espace R96B11

		sw	gm	gv	mw	ew
NR	<b>50</b>	41	1	8	?	
NMI	<b>10</b>	6	0	3	1	
DIA	<b>14</b>	9	0	4	1	

n°	IDpoterie	locus	forme	céra.	façonnage		décor	cui.	« marque »	
					MT	S			type	position
1	TCH98B22.18	98B22	bol 01 C c	SW01				A5		
2	TCH98B22.1	98B22	bol 02 B b	SW01				A5		
3	TCH98B22.14	98B22	bol 02 B b	SW01				A5		
4	TCH98B22.13	98B22	bol 02 B b	SW01				A5		
5	TCH98B22.16	98B22	bol 05 A f	SW01				A5		
6	TCH98B22.15	98B22	bol 05 A g	SW01				A5		
7	TCH98B22.12	98B22	bol 05 A g	SW01				A5		
8	TCH98B70	98B22	bassin 02	SW12			engobe	A2		
9	TCH98B22.7	98B22	jarre OL 02 D 21	SW13				A5		

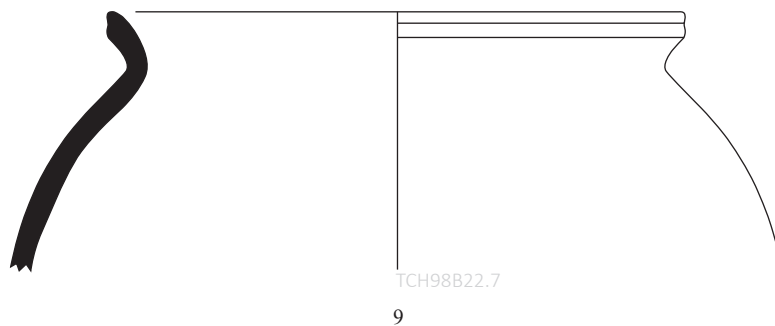
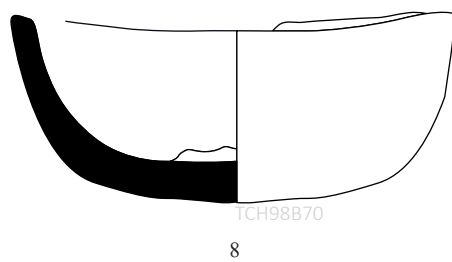
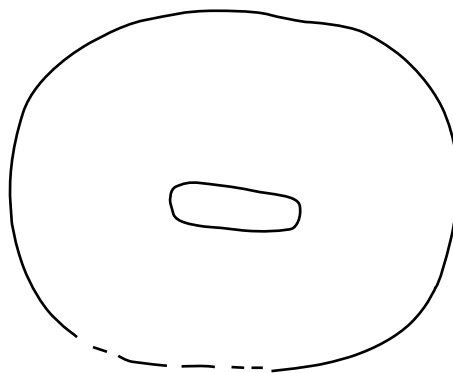
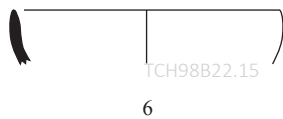
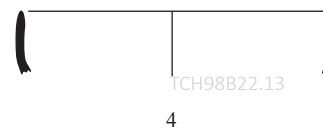
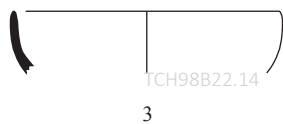
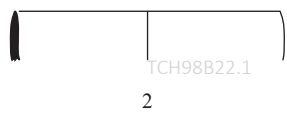
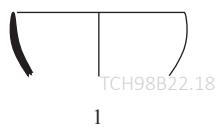

Céramiques communes



Catalogue 6

n°	IDpoterie	locus	forme	céra.	façonnage		décor	cui.	« marque »	
					MT	S			type	position
1	TCH98B22.11	98B22	jatte 01 t	GV			engobe	A5		
2	TCH98B22.3	98B22	jarre OL 02 B 18	GV	IB-IIA-III12	2		A5		
3	TCH98B22.2	98B22	grande jarre 03 B 48	GV				A3		
4	TCH98B22.5	98B22	grande jarre 01 52	GV				A2		
5	TCH98B22.17	98B22	bol 06 A n	MW			coloration par tournassage? Peinture?	A2		



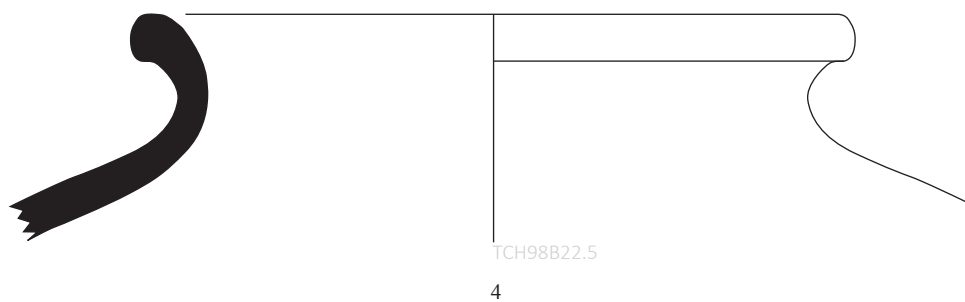
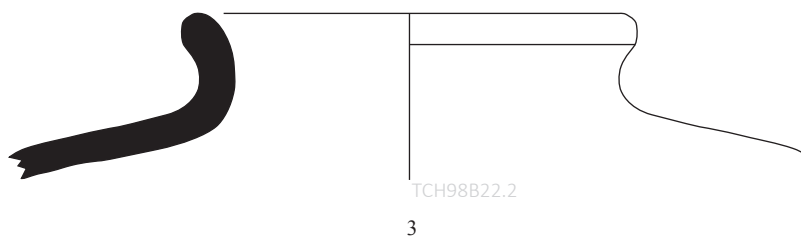
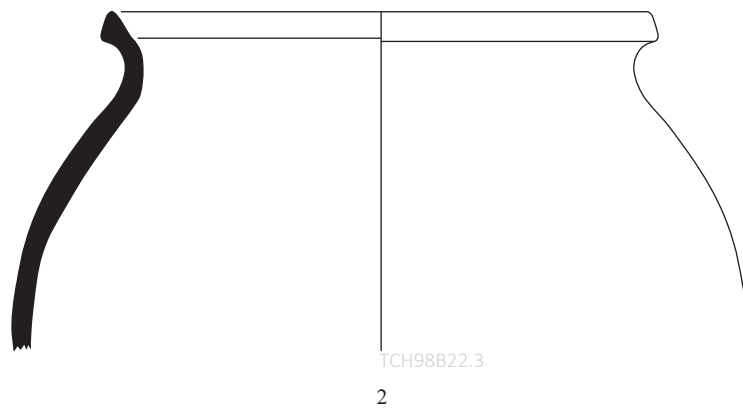
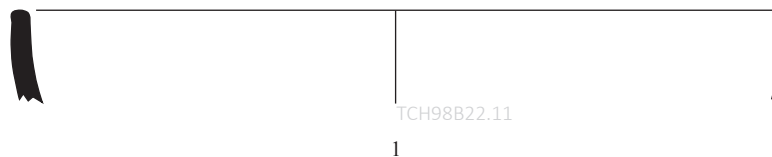

Céramiques à dégraissant végétal grossier (GV)

---

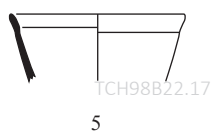

Céramiques métalliques



Catalogue 7

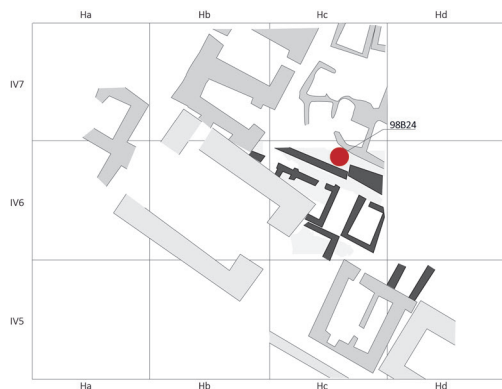

TCH98B24

Espace R96-10

		sw	gm	gv	mw	ew
NR	<b>318</b>	303	86	7	?	
NMI	<b>51</b>	44	1	2	4	
DIA	<b>54</b>	46	1	2	5	

n°	IDpoterie	locus	forme	céra.	façonnage		décor	cui.	« marque »	
					MT	S			type	position
1	TCH98B24.45	98B24	bol 01 A a	SW02	IB-IIIB-III2		pseudo-engobe	A5		
2	TCH98B24.61	98B24	bol 01 A b	SW01	IB-IIIB-III2		pseudo-engobe	A5		
3	TCH98B24.44	98B24	bol 01 A b	SW02	IB-IIIB-III2			A5		
4	TCH98B24.41	98B24	bol 01 A e	SW01			pseudo-engobe (VO)	A5		
5	TCH98B24.26	98B24	bol 01 A e	SW02	IB-IIIB-III2			A5		
6	TCH98B24.49	98B24	bol 01 B c	SW01	IB-IIIB-III12	4		nd		
7	TCH98B24.35	98B24	bol 01 B e	SW02	III2b			A5		
8	TCH98B24.31	98B24	bol 01 C c	SW01	IB-IIIB-III2			A5		
9	TCH98B24.42	98B24	bol 01 C c	SW02	IB-IIIB-III2		pseudo-engobe	A5		
10	TCH98B24.32	98B24	bol 01 C c	SW01	III125		pseudo-engobe	A5		
11	TCH98B24.37	98B24	bol 01 C c	SW02	IB-IIIB-III2			A5		
12	TCH98B24.47	98B24	bol 02 A a	SW01	IB-IIIB-III2			A1		
13	TCH98B24.38	98B24	bol 02 A b	SW02	IB-IIIB-III2			A5		
14	TCH98B24.46	98B24	bol 02 B b	SW01	IB-IIIB-III2			A1		
15	TCH98B24.55	98B24	bol 02 B e	SW02	III2			A5		
16	TCH98B24.34	98B24	bol 02 C a	SW02	IB-IIIB-III12	4	pseudo-engobe (VO)	A5		
17	TCH98B24.33	98B24	bol 03 A i	SW02				A5		
18	TCH98B24.40	98B24	bol 03 B i	SW01	III25	4	pseudo-engobe	A5		
19	TCH98B24.39	98B24	bol 03 B j	SW02	IB-IIIB-III125	4		A5		
20	TCH98B24.193	98B24	bol 03 B n	SW01	III2b			A5		
21	TCH98B24.62	98B24	bol 03 B n	SW07	IB-IIIB-III12	4	pseudo-engobe	A4		
22	TCH98B24.50	98B24	bol 03 C i	SW02	IB-IIIB-III2b			A5		

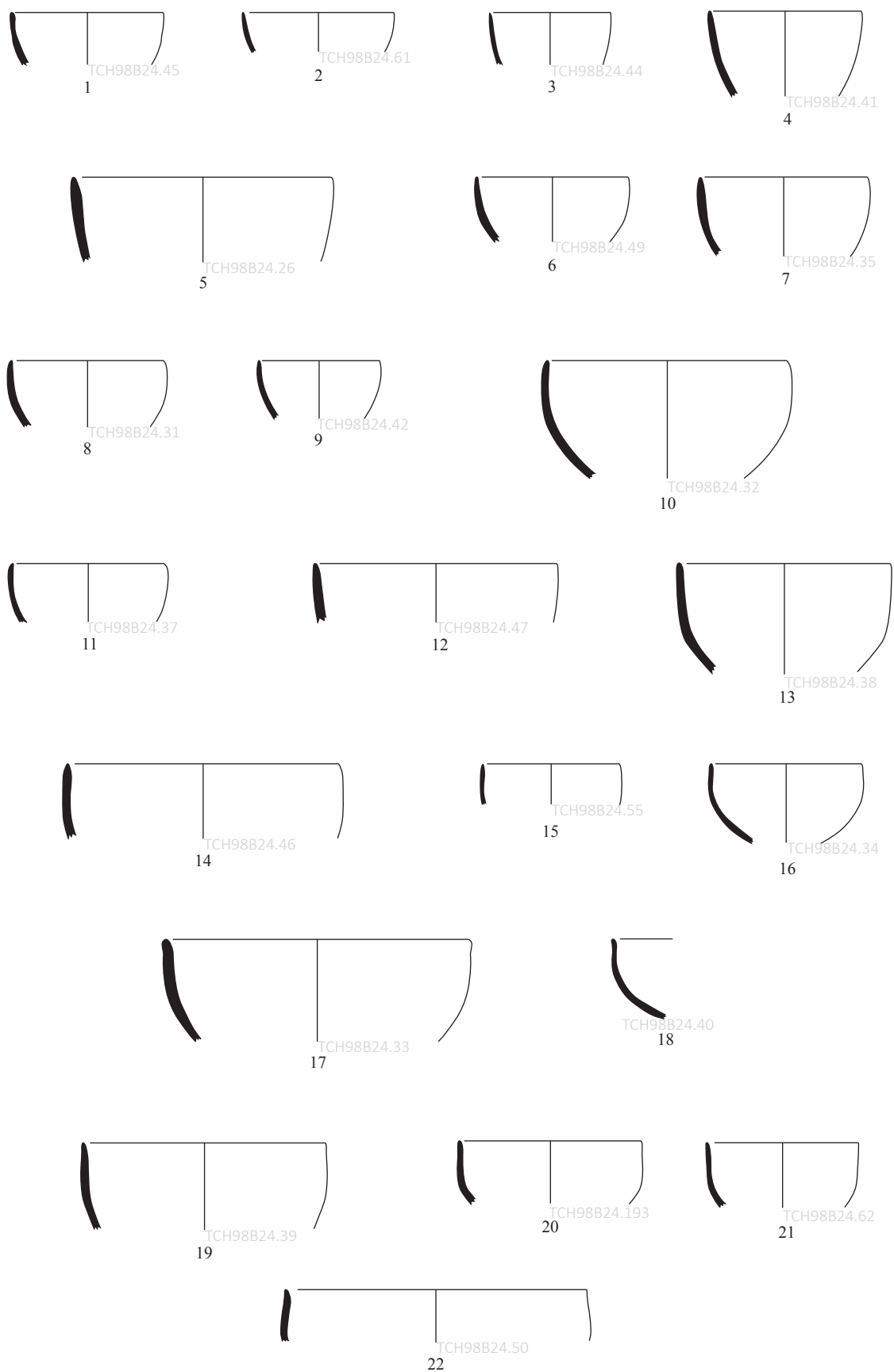

Céramiques communes



Catalogue 8

n°	IDpoterie	locus	forme	céra.	façonnage		décor	cui.	« marque »	
					MT	S			type	position
1	TCH98B24.20+21+22	98B24	bol 04 A q	SW05	IB-III1		engobe	A5		
2	TCH98B24.59	98B24	bol 05 B f	SW01	IB-II B-III2		pseudo-engobe	A5		
3	TCH98B24.51	98B24	bol 05 B f	SW02	III2b		pseudo-engobe	A5		
4	TCH98B24.36	98B24	bol 05 B g	SW01	IB-II B-III2			A5		
5	TCH98B24.43	98B24	bol 05 B j	SW02	IB-II B-III2			A1		
6	TCH98B24.57	98B24	bol 05 B l	SW02	IB-II B-III2		pseudo-engobe (VO)	A3		
7	TCH98B24.60	98B24	bol 06 A d	SW07	III2		engobe	A5		
8	TCH98B24.54	98B24	bol 06 A l	SW02	IB-II B-III2			A5		
9	TCH98B24.56	98B24	bol 06 A l	SW02	III2		pseudo-engobe	A3		
10	TCH98B24.58	98B24	bol 06 A l	SW02	III2		pseudo-engobe	A5		
11	TCH98B24.52	98B24	pot 03 n	SW01				A5		
12	TCH98B24.24	98B24	pot 03 v	SW07	III2		engobe	A5		
13	TCH98B24.6	98B24	pot 03 y	SW13	III12			A5		
14	TCH98B24.16	98B24	pot 03 z	SW04	III125			A5		
15	TCH98B24.12	98B24	petite jarre 03 A 03	SW01	III2			A5		
16	TCH98B24.13	98B24	jarre OE 02 B 25	SW07	IB-III2			A5		
17	TCH98B24.11	98B24	vase miniature 06 E	SW04				A5		
18	TCH98B24.25	98B24	base 6	SW01	IB-III2			A5		
19	TCH98B24.14	98B24	jarre OE 02 B 26	SW14	IB-III1			A5		
20	TCH98B24.8	98B24	jarre OL 02 B 16	SW14				A5		

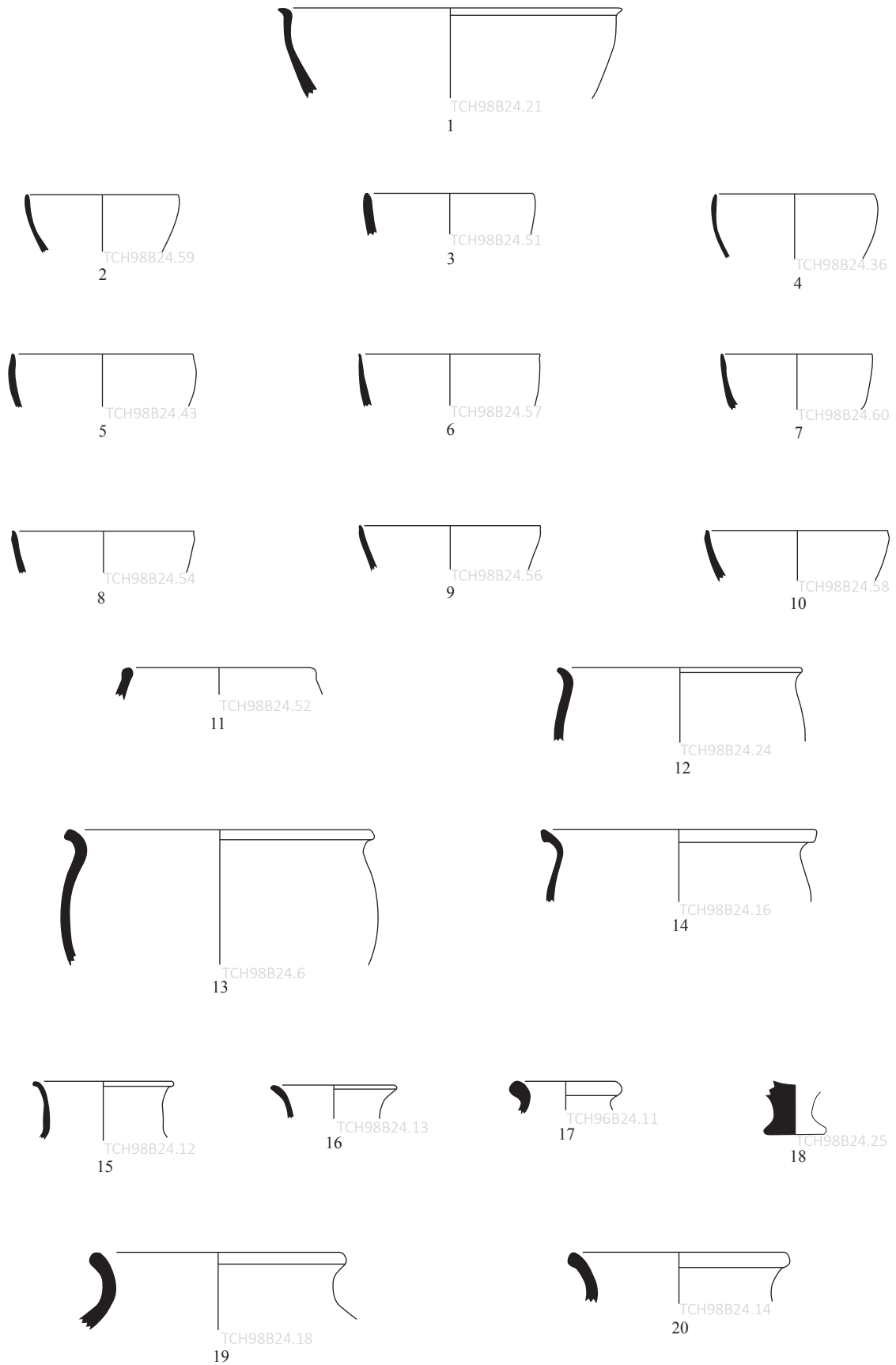

Céramiques communes (suite)



Catalogue 9

n°	IDpoterie	locus	forme	céra.	façonnage		décor	cui.	« marque »	
					MT	S			type	position
1	TCH98B24.18	98B24	jarre OL 02 B 23	SW04				A5		
2	TCH98B24.7	98B24	jarre OL 02 D 17	SW04	IB-III2b		engobe	A5		
3	TCH98B24.23	98B24	support ? ND	SW12	IB-IIA-III1	2	engobe	A5		
4	TCH98B24.3	98B24	grande jarre 02 53	GV				A3		
5	TCH98B24.2	98B24	grande jarre 02 54	GV				A2		
6	TCH98B24.19	98B24	marmite 03	GM	IB-IIA-III6a	3		A5		
7	TCH98B24.1	98B24	bol 01 C m	MW	IB-IIB-III4	5	coloration par tournassage	A5		
n.i.	TCH98B24.28	98B24	bol 01 C m	MW	IB1-IIB-III4	5	coloration par tournassage	A5		
8	TCH98B24.48	98B24	bol 01 C m	MW ?			coloration par tournassage ? peinture ?	A2		
9	TCH98B24.27	98B24	vase miniature 06	MW	IB-IIB-III4	5		B		
10	TCH98B24.63	98B24	base 1A	MW	IIB-III4	5		B		

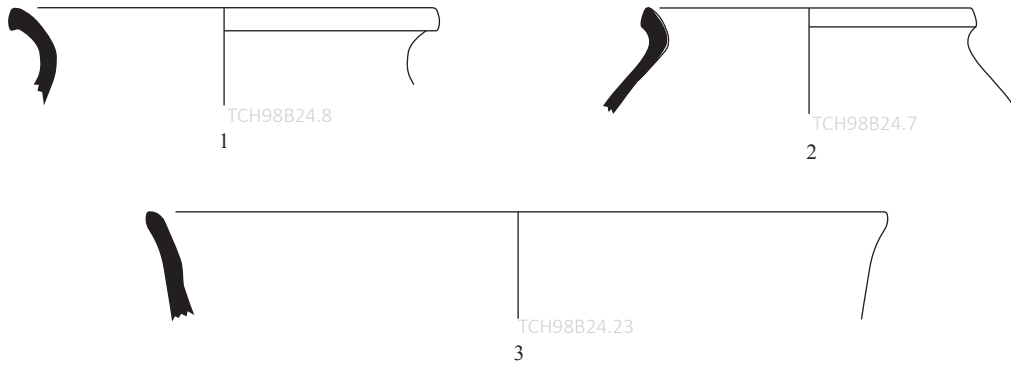

Céramiques communes (suite)

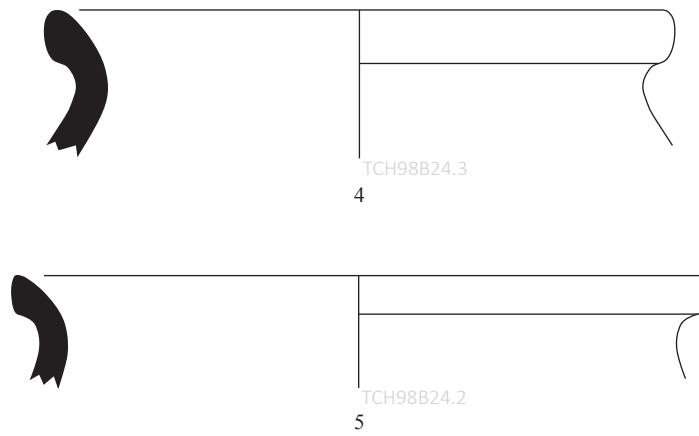

Céramiques à dégraissant végétal grossier (GV)

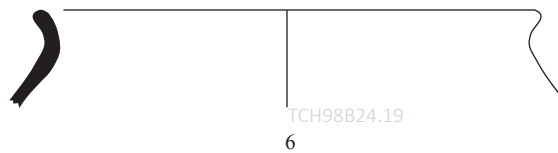

Céramiques à dégraissant minéral grossier (GM)

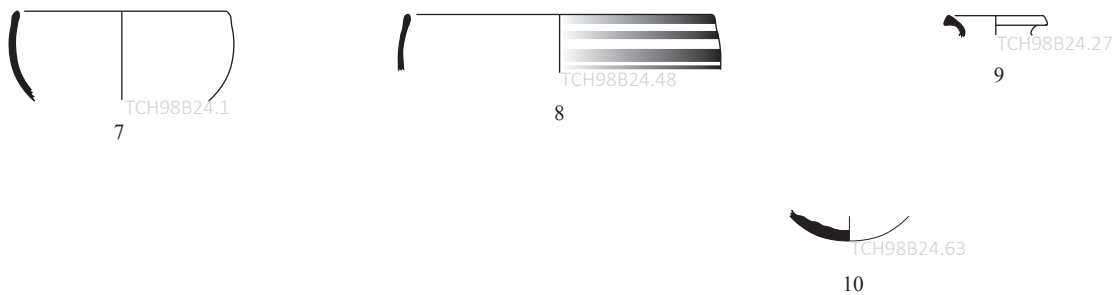

Céramiques métalliques



Catalogue 10

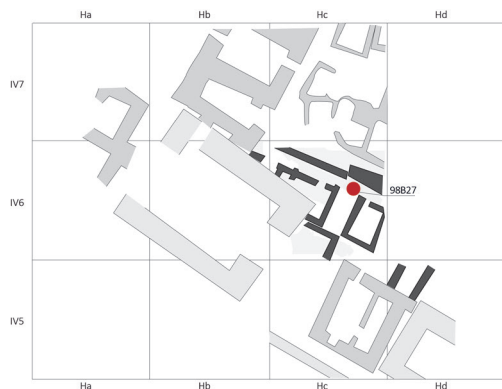

TCH98B27

Espace R96B12

		sw	gm	gv	mw	ew
NR	<b>273</b>	303	86	7	?	
NMI	<b>26</b>	20	0	4	2	
DIA	<b>29</b>	23	0	4	2	

n°	IDpoterie	locus	forme	céra.	façonnage		décor	cui.	« marque »	
					MT	S			type	position
1	TCH98B27.52	98B27	bol bas 02 A e	SW01				A5		
2	TCH98B27.28	98B27	bol bas 02 A e	SW01				A5		
3	TCH98B159	98B27	bol bas 02 C c	SW05 ?	IB-IIB			A5		
4	TCH98B27.27	98B27	bol 02 B a	SW01			engobe	A5		
5	TCH98B27.45	98B27	bol 02 C a	SW02	IB-IIB			A5		
6	TCH98B27.31	98B27	bol 03 A i	SW02				A5		
7	TCH98B27.29	98B27	bol 04 A q	SW01				A4		
8	TCH98B27.37	98B27	bol 04 B q	SW01				A5		
9	TCH98B27.42	98B27	bol 04 C q	SW01	III2			A5		
10	TCH98B27.23	98B27	bol 04 C q	SW01				A5		
11	TCH98B27.34	98B27	bol 04 C q	SW02				A5		
12	TCH98B27.25	98B27	bol 05 B l	SW07				A5		
13	TCH98B27.47	98B27	pot 03 q	SW01				A5		
14	TCH98B27.48+49	98B27	pot 03 q	SW01				A5		
15	TCH98B27.54	98B27	pot 01 a	SW12				A5		
16	TCH98B76	98B27	vase miniature 06 C	SW01	IB-IIAB-III12	4		nd		
17	TCH98B27.20	98B27	petite jarre 02 A 08	SW05				A5		
18	TCH98B27.19	98B27	petite jarre 02 D 12	SW05				A5		
19	TCH98B27.22	98B27	petite jarre 03 A 01	SW01			engobe	A5		
n.i.	TCH98B27.1	98B27	jarre (bord)	SW13			engobe	A4		
20	TCH98B27.18	98B27	support ? (bord)	SW14				A5		
21	TCH98B27.16	98B27	jarre OL 01 A 26	SW04				A5		
22	TCH98B27.10	98B27	jarre OL 02 B 16	SW07				A5		



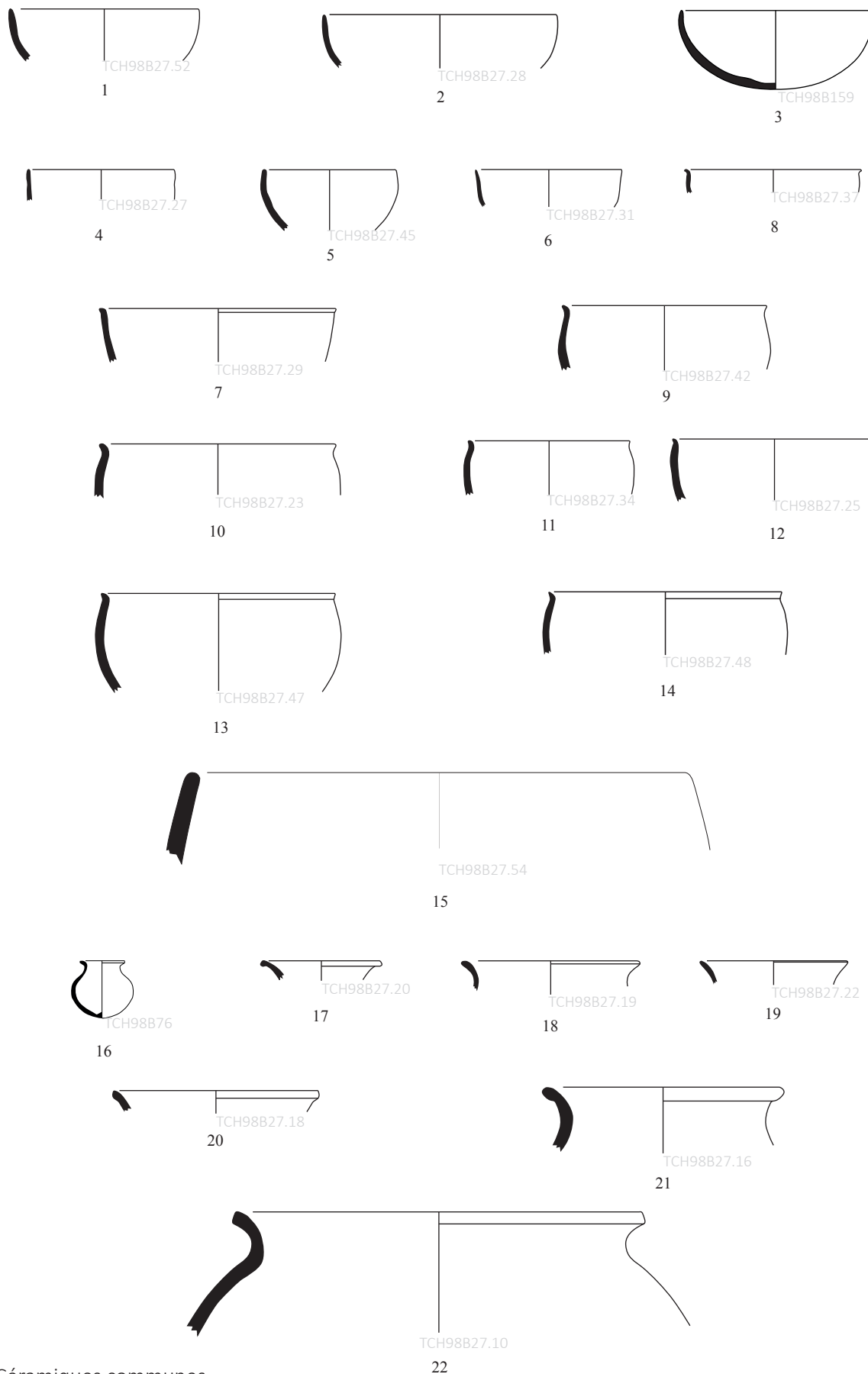

Céramiques communes



Catalogue 11

n°	IDpoterie	locus	forme	céra.	façonnage		décor	cui.	« marque »	
					MT	S			type	position
1	TCH98B27.5	98B27	grande jarre 02 50	GV				A5		
2	TCH98B27.2	98B27	grande jarre 01 52	GV				A2		
3	TCH98B27.7	98B27	grande jarre 02 50	GV				A5		
4	TCH98B27.4	98B27	grande jarre 04 54	GV				A5		
5	TCH98B27.33	98B27	bol bas 02 A f	MW 5	IB-II B-III 4	5	pseudo-engobe (fortuit?)	A2		
6	TCH98B27.32	98B27	bol 06 A n	MW 6	III 2		bosselage + engobe externe noire ?	A3		

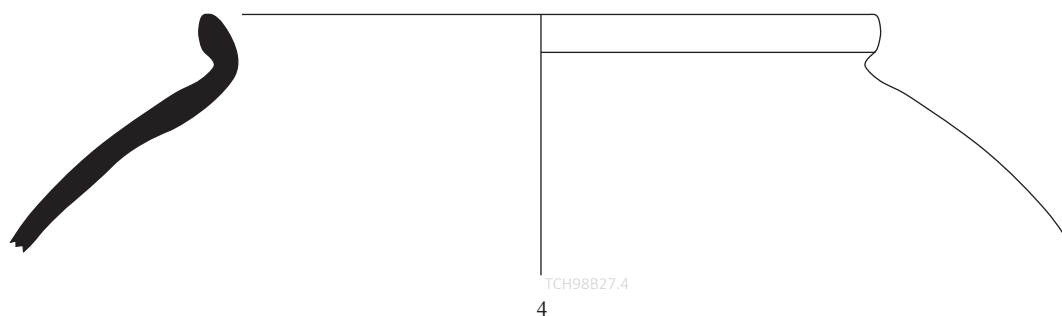
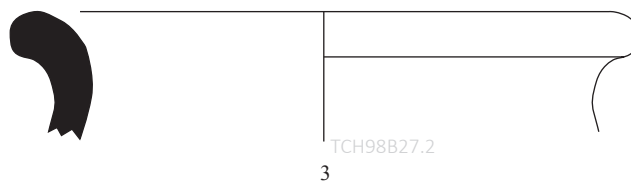
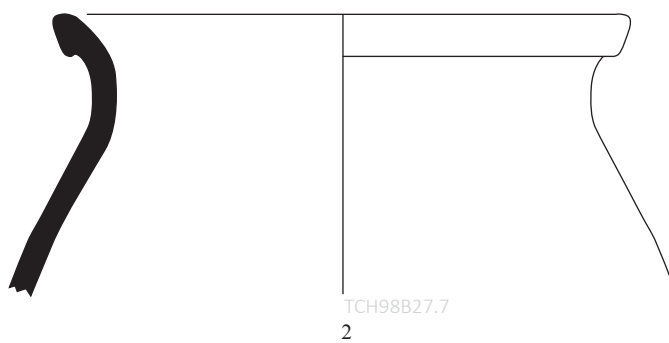
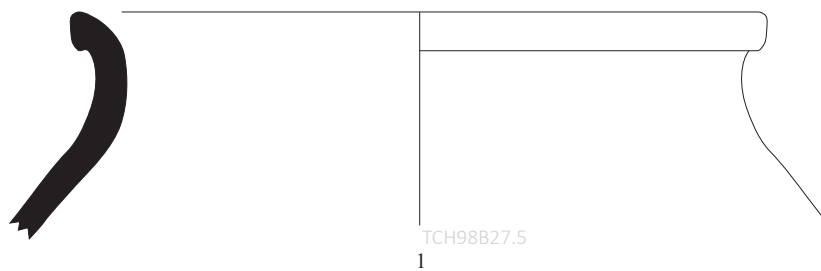

Céramiques à dégraissant végétal grossier (GV)

---

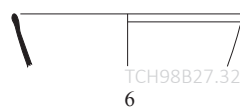

Céramiques métalliques



## Catalogue 12



### TCH98B35

Démontage dans l'angle NE du carré, au sud de l'espace R96B5.

		sw	gm	gv	mw	ew
NR	<b>134</b>	124	4	6	?	
NMI	<b>28</b>	25	1	1	1	
DIA	<b>29</b>	25	1	2	1	

n°	IDpoterie	locus	forme	céra.	façonnage		décor	cui.	« marque »	
					MT	S			type	position
n.i.	TCH98B35.6	98B35	bol 01 A a	SW02	IB-IIB-III2b		engobe	A5		
1	TCH98B35.13	98B35	bol 01 B c	SW02				A5		
2	TCH98B35.5	98B35	bol 01 B e	SW01	III2			A5		
3	TCH98B35.11	98B35	bol 05 B f	SW07				A5		
n.i.	TCH98B35.15	98B35	bol 01 C	SW02				A5		
4	TCH98B35.10	98B35	bol 01 C c	SW01				A5		
5	TCH98B35.8	98B35	bol 01 C c	SW02				A5		
6	TCH98B35.7	98B35	bol 02 A a	SW02	IB-IIB-III2b			A5		
7	TCH98B121	98B35	bol 02 B b	SW01	IB1-IIB-III12	4	pseudo-engobe (VO)	A1		
8	TCH98B35.16	98B35	bol 03 A i	SW13				A5		
9	TCH98B35.14	98B35	bol 03 C i	SW07	III25	4		A5		
10	TCH98B35.22	98B35	bol 04 A q	SW04				A5		
11	TCH98B35.31	98B35	bol 06 A b	SW01				A5		
12	TCH98B35.30	98B35	pot 03 v	SW13				A5		
13	TCH98B35.28	98B35	pot 03 z	SW13				A5		
14	TCH98B35.17	98B35	petite jarre 02 B 01	SW01			engobe	A5		
15	TCH98B35.29	98B35	petite jarre 02 B 08	SW01			engobe	A5		
16	TCH98B35.18	98B35	petite jarre 02 D 22	SW05				A5		
17	TCH98B35.26	98B35	petite jarre 03 A 06	SW02				A5		
18	TCH98B35.25	98B35	jarre OE 03 A 25	SW13				A5		
19	TCH98B35.27	98B35	jarre OE 02 B 31	SW26				A5		
20	TCH98B35.33	98B35	jarre OL 01 B 54	SW13				A5		
21	TCH98B151	98B35	nd	SW12	IB-III2		engobe, incision	A5		

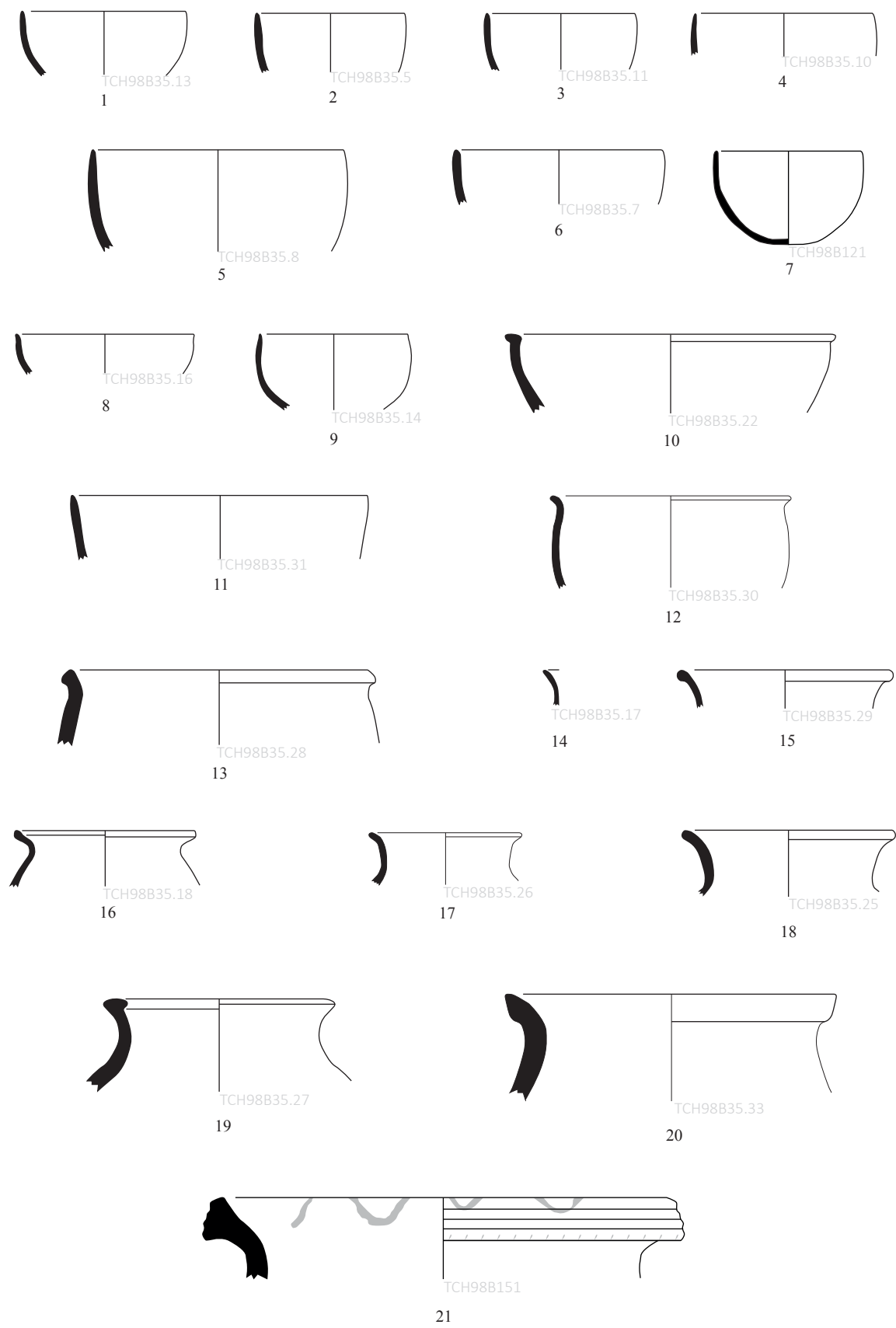

Céramiques communes



Catalogue 13

n°	IDpoterie	locus	forme	céra.	façonnage		décor	cui.	« marque »	
					MT	S			type	position
1	TCH98B35.23	98B35	support 01	SW13	IB-IIA	2		A5		
2	TCH98B35.32	98B35	base 1A	SW13	IB-IIB			A5		
n.i.	TCH98B35.34	98B35	jarre (bord)	GV				A2		
3	TCH98B35.20	98B35	support	GV				A2		
4	TCH98B35.19	98B35	marmite 03B	GM	III6	3		A5		
5	TCH98B35.1	98B35	base 1B	MW 5	IB-IIB-III4	5		B		

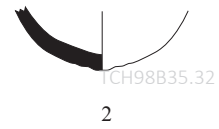
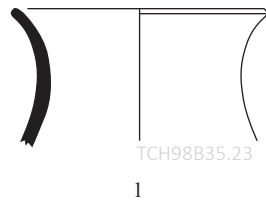

Céramiques communes (suite)

---



Céramiques à dégraissant végétal grossier (GV)

---

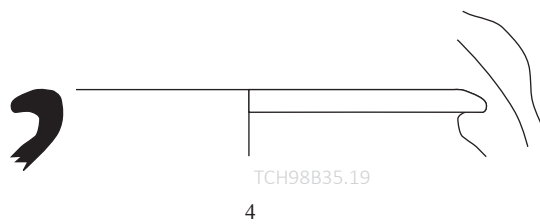

Céramiques à dégraissant minéral grossier (GM)

---

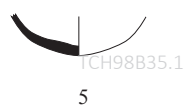

Céramiques métalliques



Catalogue 14



TCH99B18

Espace R98B3.

		sw	gm	gv	mw	ew
NR	<b>268</b>	167	3	98	?	1?
NMI	<b>50</b>	44	2	3	1	
DIA	<b>60</b>	52	2	5	1	

n°	IDpoterie	locus	forme	céra.	façonnage		décor	cui.	« marque »	
					MT	S			type	position
1	TCH99B12	99B18	bol bas 03 B i	SW01			pseudo-engobe (VO)	A5		
2	TCH99B18.10	99B18	bol 01 A d	SW01	IB-III2		pseudo-engobe	A5		
3	TCH99B18.31	99B18	bol 01 B b	SW01	IB1-IIB-III125	4		A5		
4	TCH99B18.7	99B18	bol 01 B b	SW02	IB-IIB-III25	4	pseudo-engobe	A5		
5	TCH99B18.44	99B18	bol 01 B b	SW02				A5		
6	TCH99B18.2	99B18	bol 01 B e	SW02	IB1-III25	4	pseudo-engobe (VO)	A5		
7	TCH99B18.11	99B18	bol 02 A e	SW02	III2			A5		
8	TCH99B18.41	99B18	bol 02 B a	SW02				A5		
9	TCH99B18.15	99B18	bol 02 B a	SW02	III2b			A5		
10	TCH99B18.8	99B18	bol 02 B b	SW01	IB-IIB-III2b			A5		
11	TCH99B18.14	99B18	bol 02 B d	SW02	IB-IIB-III2		engobe	A1		
12	TCH99B18.5	99B18	bol 02 B e	SW02	IB-IIB-III12	4	pseudo-engobe (VO)	A5		
13	TCH99B18.13	99B18	bol 02 B e	SW02	IB-IIB-III2b		pseudo-engobe	A5		
14	TCH99B18.32	99B18	bol 02 C b	SW01	IB-IIB			A5		
15	TCH99B18.37	99B18	bol 02 C c	SW01	IB-III2b		pseudo-engobe (VO)	A1		
16	TCH99B18.16	99B18	bol 02 C c	SW07	III12		engobe	A5		
17	TCH99B18.34	99B18	bol 02 C e	SW02	IB-IIB-III2b		pseudo-engobe	A5		
18	TCH99B18.29	99B18	bol 03 A i	SW01	IB-IIB-III12	4		A5		
19	TCH99B18.3	99B18	bol 03 A i	SW02	IB-IIB-III2			A5		
20	TCH99B18.1	99B18	bol 03 A i	SW07	IB-IIB-III12	4		A5		
21	TCH99B18.30	99B18	bol 03 B i	SW01	IB-IIB-III25	4	pseudo-engobe (VO)	A5		
22	TCH99B18.33	99B18	bol 03 B i	SW01	IB-IIB-III2b			A5		
23	TCH99B18.57	99B18	bol 03 B i	SW01	IB-IIB-III2b		pseudo-engobe	A5		
24	TCH99B18.36	99B18	bol 03 B i	SW01	III2b		pseudo-engobe (VO)	A2		
25	TCH99B18.48	99B18	bol 03 B i	SW01				A5		
26	TCH99B18.49	99B18	bol 03 B i	SW01				A5		
27	TCH99B18.4	99B18	bol 03 B i	SW13				A5		
28	TCH99B18.28	99B18	bol 03 C i	SW01	IB-IIB-III12	4		A5		
29	TCH99B18.6	99B18	bol 03 C i	SW01	IB-IIB-III12	4	pseudo-engobe (VO)	A5		
30	TCH99B18.38	99B18	bol 03 C i	SW01	IB-IIB-III2		engobe	A5		
31	TCH99B18.27	99B18	bol 03 C i	SW02	III2		pseudo-engobe	A5		
32	TCH99B18.9	99B18	bol 04 B q	SW13	IB-IIB-III2b		engobe	A2		



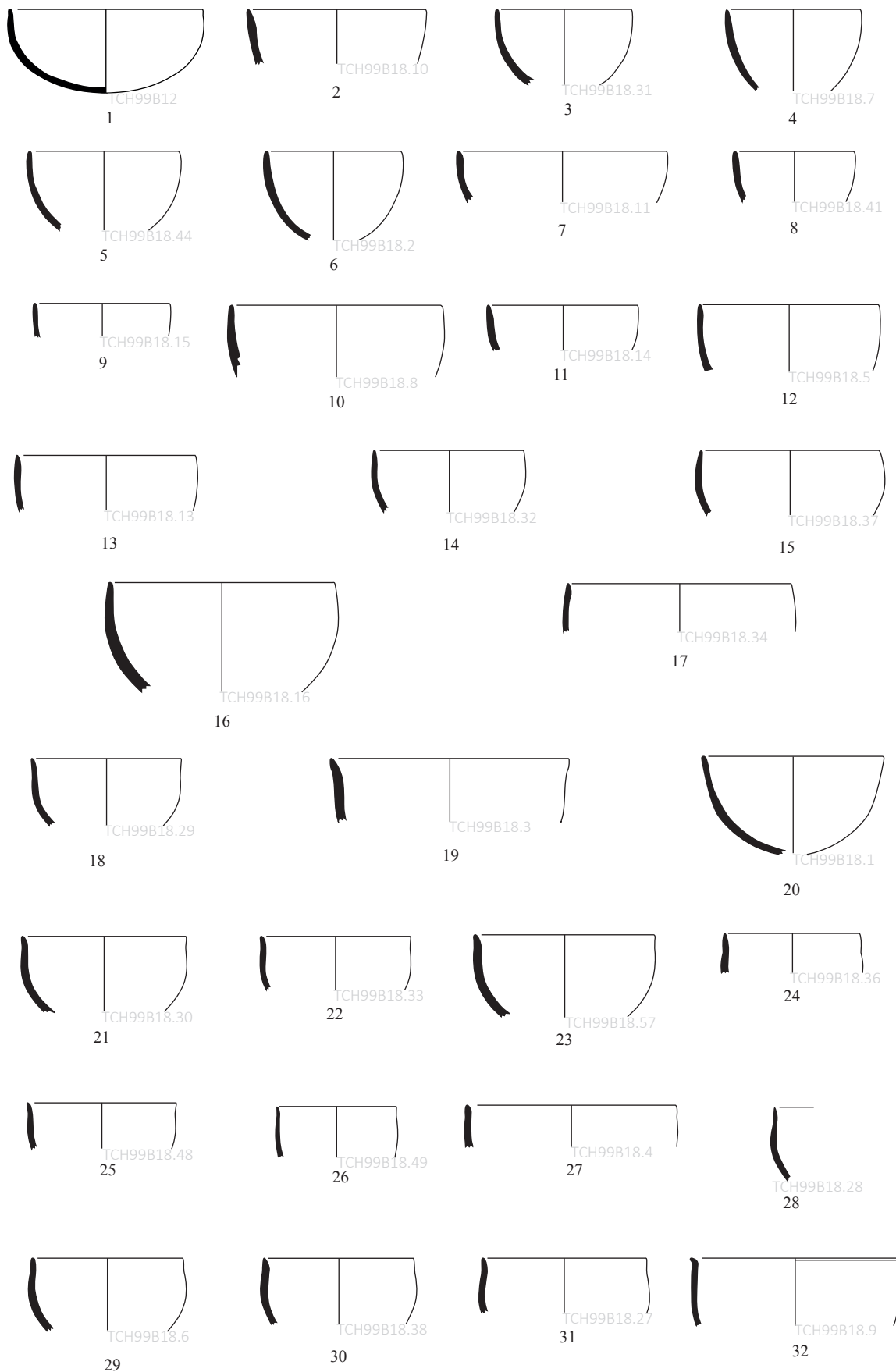

Céramiques communes



Catalogue 15

n°	IDpoterie	locus	forme	céra.	façonnage		décor	cui.	« marque »	
					MT	S			type	position
1	TCH99B18.18	99B18	bol 04 A	SW04	III2			A5		
2	TCH99B18.12	99B18	bol 06 A d	SW02	IB-III2			A5		
n.i.	TCH99B18.17	99B18	pot ? (bord)	SW10				A5		
3	TCH99B18.52	99B18	pot 03 v	SW14			engobe	A5		
4	TCH99B18.47	99B18	pot 03 A v	SW14				A5		
5	TCH99B18.19	99B18	pot 03 v	SW14			engobe	A5		
6	TCH99B18.35	99B18	pot 03 A u	SW14	III2b		pseudo-engobe	A5		
7	TCH99B18.45	99B18	pot 03 w	SW13				A5		
n.i.	TCH99B18.46	99B18	petite jarre 03 A 01	SW01				A5		
8	TCH99B18.39	99B18	petite jarre 03 D 02	SW01				A5		
9	TCH99B18.40	99B18	petite jarre 03 D 02	SW01	IB-III2			A5		
10	TCH99B18.21	99B18	jarre OE 03 B 23	SW07	III2			A5		
11	TCH99B18.53	99B18	jarre OL 01 A 26	SW13				A2		
12	TCH99B18.20	99B18	jarre OL 02 B 23	SW14	III2b		pseudo-engobe	A5		
13	TCH99B18.55	99B18	jarre OL 02 D 19	SW07?			engobe	A5		

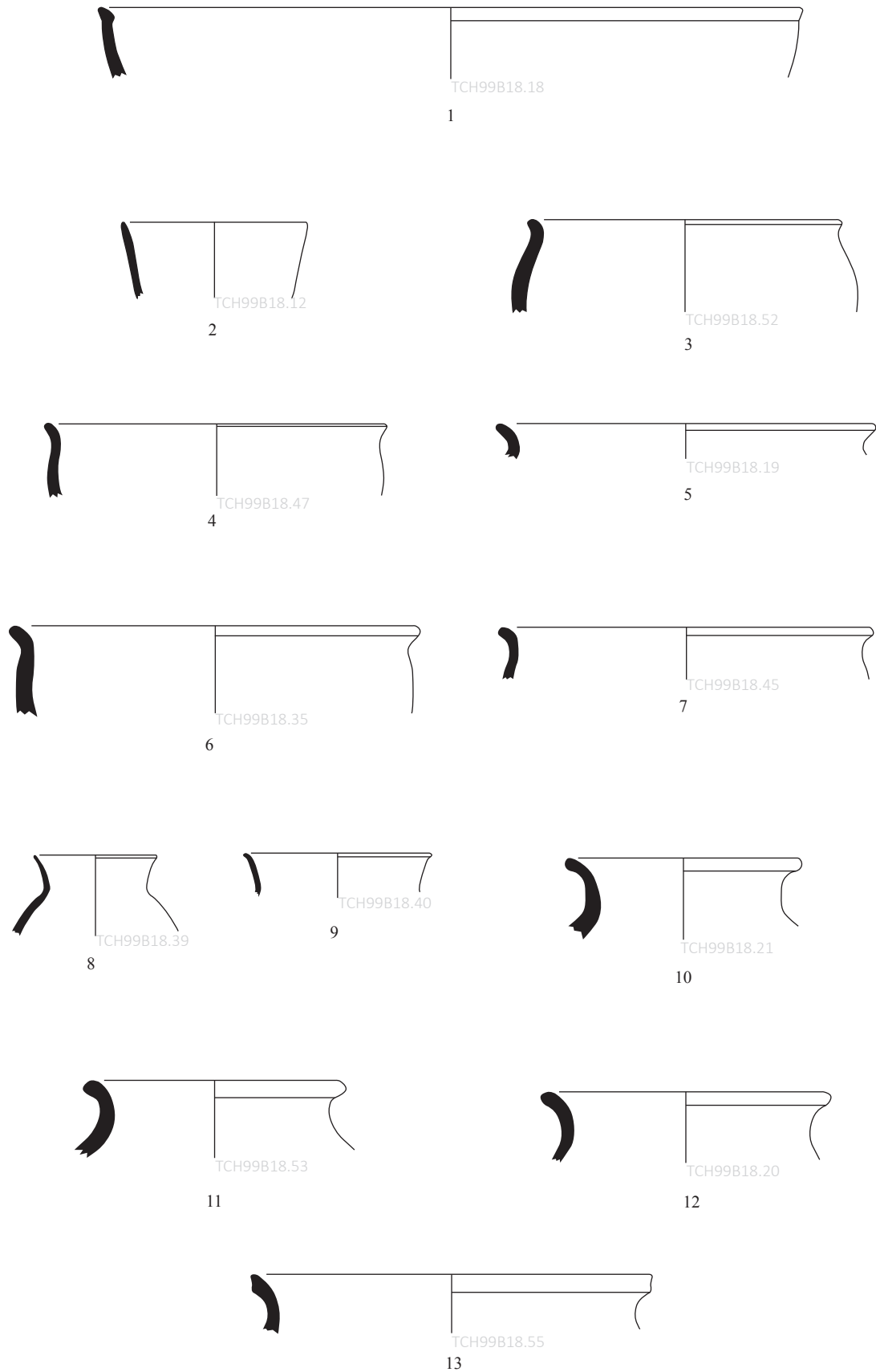

Céramiques communes (suite)



Catalogue 16

n°	IDpoterie	locus	forme	céra.	façonnage		décor	cui.	« marque »	
					MT	S			type	position
1	TCH99B18.26	99B18	base 1A	SW01	IB-II B-III12	4		A5		
2	TCH99B18.56	99B18	base 1A	SW14	IB-II B-III1	4		A5		
3	TCH99B18.24	99B18	base 3B	SW01	IB2-II B-III4	5		A5		
4	TCH99B18.25	99B18	base 3B	SW02	IB2-II B-III4	5		A5		
5	TCH99B18.22	99B18	support ?	SW05				A5		
6	TCH99B18.54	99B18	grande jarre (bord)	GV				A5		
7	TCH99B18.50	99B18	grande jarre 02 53	GV				A2		
8	TCH99B18.23	99B18	grande jarre 02 53	GV	IB-II A-III1	2		A2		
9	TCH99B18.58	99B18	base 4	GV	IB-II A-III1	2		A4		
10	TCH99B18.51	99B18	base 4	GV	IB-II A-III1	2		A4		
11	TCH99B18.60	99B18	tasse 01	GM	IB-II A-III6	3		A5		
12	TCH99B18.43	99B18	marmite 02 B	GM	III6a	3		A5		
13	TCH99B18.42	99B18	base 1A	MW 9	II B-III4	5	engobe	A5		

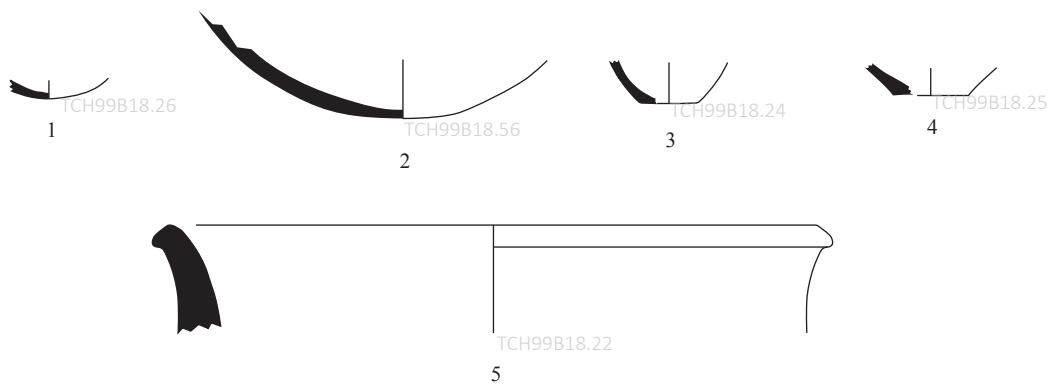

Céramiques communes (suite)

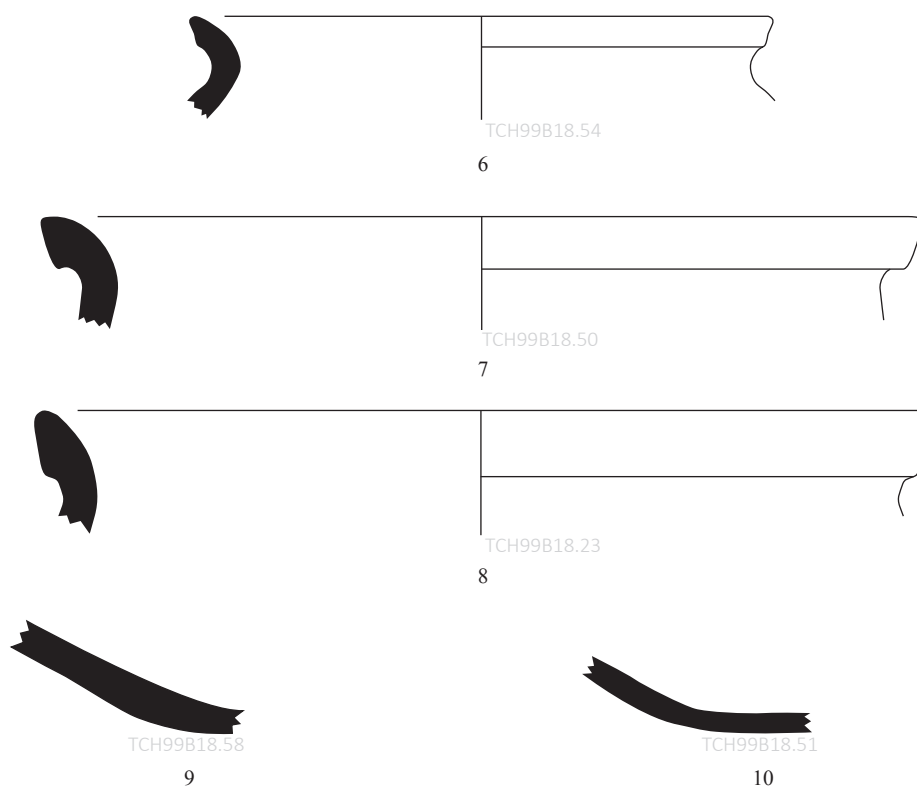

Céramiques à dégraissant végétal grossier (GV)



Céramiques à dégraissant minéral grossier (GM)

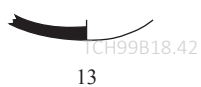

Céramiques métalliques



# Catalogue 17

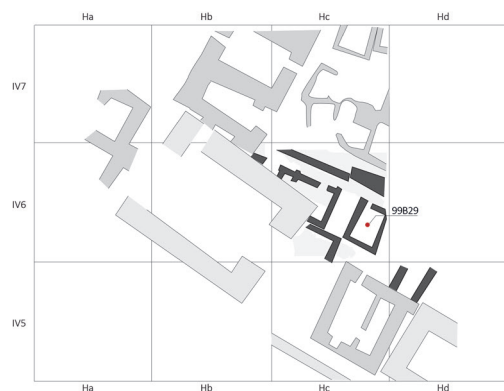

TCH99B29

Espace R98-1.

\_\_\_\_\_ sw gm gv mw ew

NR /

NMI 3 3

DIA 3 3

n°	IDpoterie	locus	forme	céra.	façonnage		décor	cui.	« marque »	
					MT	S			type	position
1	TCH99B40	99B29	bol 02 B b	SW02				A5		
2	TCH99B37	99B29	petite jarre 03 A 01	SW01				A5		
3	TCH99B38	99B29	petite jarre 03 A 03	SW01	IB-IIA-III12	2	pseudo-engobe	A2		

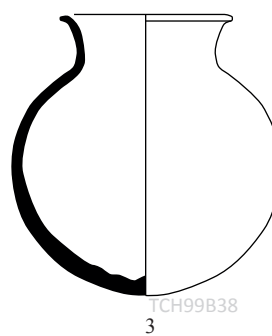
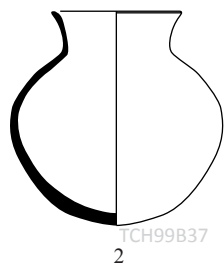
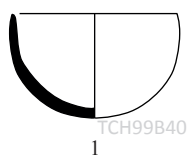

Céramiques communes



Catalogue 18

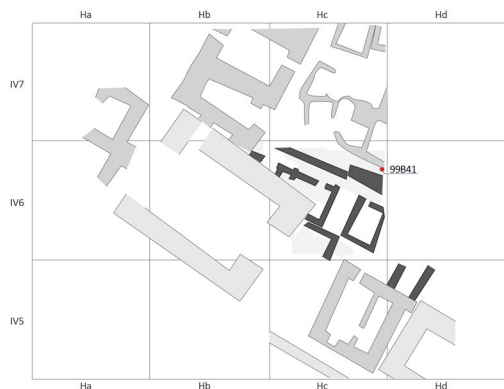

TCH99B41

Surface d'occupation.

		sw	gm	gv	mw	ew
NR	<b>22</b>	17		5	?	
NMI	<b>3</b>	0		0	3	
DIA	<b>3</b>	0		0	3	

n°	IDpoterie	locus	forme	céra.	façonnage		décor	cui.	« marque »	
					MT	S			type	position
4	TCH99B41.1	99B41	bol bas 02 B m	MW 9	IB-II B-III 4	5	coloration par tournassage	A5		
5	TCH99B41.2	99B41	bol bas 02 B m	MW 9	II B-III 2		coloration par tournassage	A5		
6	TCH99B41.3	99B41	gobelet 01 B	MW 7	IB-II B-III 4	5	coloration par tournassage? peinture?	A2		



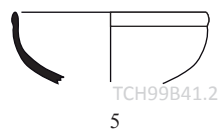
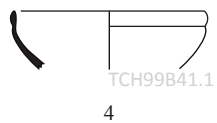

Céramiques métalliques



Catalogue 19



TCH96B42

Descente sous le sol de l'espace R96B3, entre les murs M95-204 und M96-002

		sw	gm	gv	mw	ew
NR	<b>116</b>	105		9	2	4
NMI	<b>28</b>	25	1		1	1
DIA	<b>32</b>	29	1		1	1

n°	IDpoterie	locus	forme	céra.	façonnage		décor	cui.	« marque »	
					MT	S			type	position
1	TCH96B42.32	96B42	bol ? (bord)	SW02				A5		
2	TCH96B42.1	96B42	bol 01 A d	SW01				A5		
3	TCH96B42.6	96B42	bol 01 B a	SW01				A5		
4	TCH96B42.14	96B42	bol 01 B a	SW01				A5		
5	TCH96B42.22	96B42	bol 01 B b	SW01				A5		
6	TCH96B42.11	96B42	bol 01 C c	SW01				A5		
7	TCH96B42.15	96B42	bol 02 A a	SW01				A5		
8	TCH96B42.30	96B42	bol 02 B a	SW02				A5		
9	TCH96B42.16	96B42	bol 02 B d	SW02				A5		
10	TCH96B42.27	96B42	bol 02 C b	SW02				A5		
11	TCH96B42.29	96B42	bol 03 A i	SW01				A5		
12	TCH96B42.31	96B42	bol 03 B i	SW02				A5		
13	TCH96B42.23	96B42	bol 03 B j	SW01				A5		
14	TCH96B42.17	96B42	bol 03 B j	SW07				A5		
15	TCH96B90	96B42	bol 03 C i	nd – SW				A5		
16	TCH96B42.2	96B42	bol 04 B q	SW01				A5		
17	TCH96B42.20	96B42	pot 03 o	SW13				A3		
18	TCH96B42.5	96B42	pot 03 v	SW14				A5		
19	TCH96B42.21+24	96B42	pot 03 v	SW14				A5		
20	TCH96B42.9	96B42	pot 03 w	SW14				A5		
21	TCH96B42.25	96B42	petite jarre 02 D 12	SW14				A5		
22	TCH96B42.28	96B42	petite jarre 03 A 06	SW07			engobe	A5		
n.i.	TCH96B42.33	96B42	jarre OE 02 B 25	nd – surcuit				A5		
23	TCH96B42.12	96B42	jarre OE 02 B 25	SW05				A5		
24	TCH96B42.26	96B42	jarre OE 02 B 25	SW07				A5		
n.i.	TCH96B42.18	96B42	panse	SW07				A5		
n.i.	TCH96B42.4	96B42	tenon perforé	SW04				A5		
25	TCH96B42.13	96B42	base 1A	SW01				A5		
26	TCH96B42.8	96B42	base 7A	SW04		1		A5		

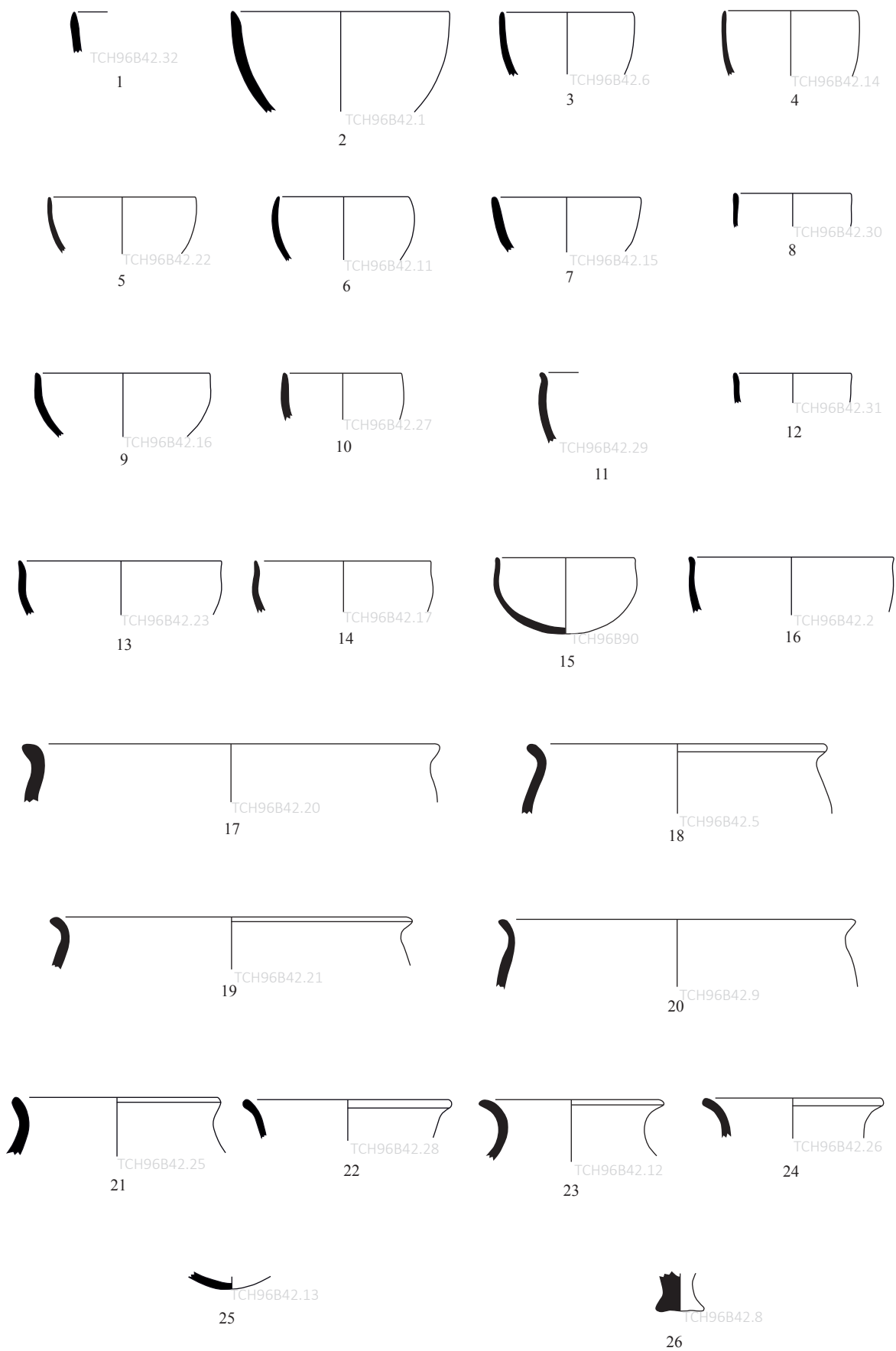

Céramiques communes



Catalogue 20

n°	IDpoterie	locus	forme	céra.	façonnage		décor	cui.	« marque »	
					MT	S			type	position
1	TCH96B42.19	96B42	marmite 02	GM				A5		
2	TCH96B42.3	96B42	petite jarre 03 E 05	MW 8			coloration par tournassage ?	A2		
3	TCH96B500	96B42	petite jarre 03 B 06	EW 1			peinture	A5		

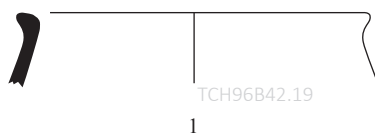

Céramiques à dégraissant minéral grossier (GM)

---

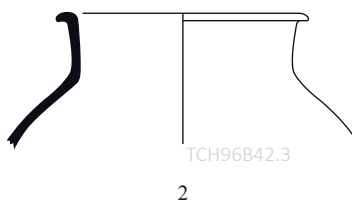

Céramiques métalliques

---

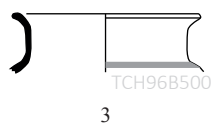

Céramiques de l'Euphrate



Catalogue 21

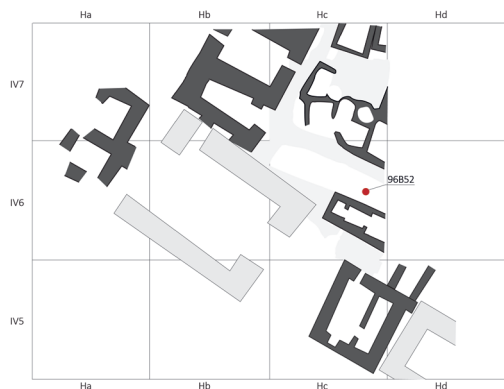

TCH96B52

Surface d'occupation au N du mur M95-218.

		sw	gm	gv	mw	ew
NR	<b>68</b>	55		13		
NMI	<b>9</b>	8		1		
DIA	<b>9</b>	7		2		

n°	IDpoterie	locus	forme	céra.	façonnage		décor	cui.	« marque »	
					MT	S			type	position
1	TCH96B135	96B52	bol bas 04 C m	nd -SW	IB-IIB-III24	5		A5		
2	TCH96B52.3	96B52	bol 01 A a	SW01				A5		
3	TCH96B52.2	96B52	bol 01 B a	SW07	IB-IIB-III2b			A5		
4	TCH96B52.1	96B52	bol 02 C b	SW01	IB-IIB-III2			A5		
5	TCH96B52.4	96B52	bol 03 B n	SW01	IB-IIB-III2			A5		
6	TCH96B52.5	96B52	pot 03 q	SW02	IB-IIB			A5		
7	TCH96B52.6	96B52	vase à tubulaire goulot	SW07	III1			A5		
8	TCH96B52.9	96B52	grande jarre 02 53	GV	IB-IIA-III1	2		A2		
9	TCH96B52.8	96B52	support ?	GV	IB-IIA-III1	2		A5		

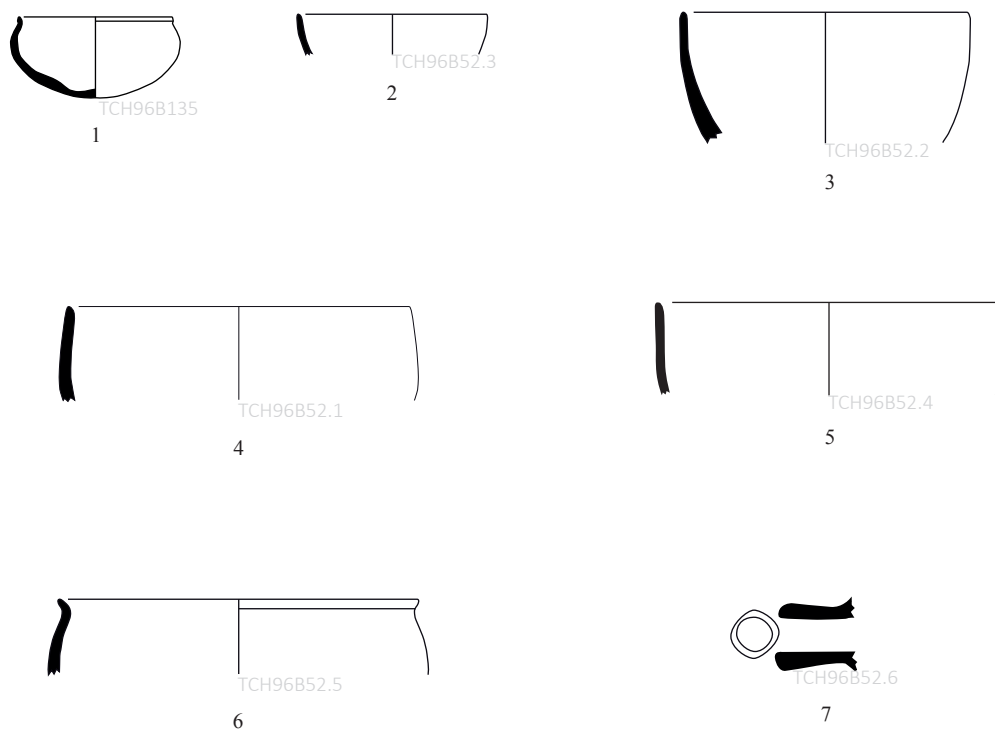

Céramiques communes

---

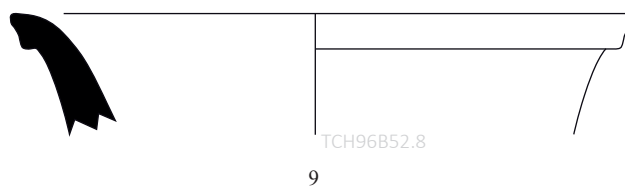
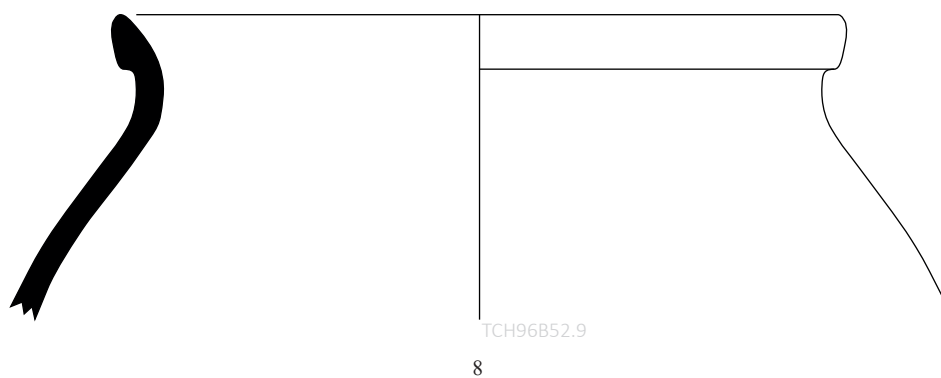

Céramiques à dégraissant végétal grossier (GV)



Catalogue 22



TCH98B13

Espace R95B5.

		sw	gm	gv	mw	ew
NR	<b>717</b>	480	116	121		
NMI	<b>43</b>	36	3	3	1	
DIA	<b>44</b>	37	3	3	1	

n°	IDpoterie	locus	forme	céra.	façonnage		décor	cui.	« marque »	
					MT	S			type	position
n.i.	TCH98B169	98B13	bol 01	nd -SW				A2		
1	TCH98B13.14	98B13	bol 01 A a	SW01				A1		
2	TCH98B13.5	98B13	bol 01 C a	SW07				A5		
3	TCH98B13.6	98B13	bol 01 C b	SW02				A5		
4	TCH98B13.11	98B13	bol 03 B i	nd - surcuit				A2		
5	TCH98B13.17	98B13	bol 03 B i	SW01				A5		
6	TCH98B13.20	98B13	bol 03 B i	SW01				A5		
7	TCH98B13.10	98B13	bol 03 B i	SW01				A5		
8	TCH98B13.18	98B13	bol 03 B i	SW01				A5		
9	TCH98B13.7	98B13	bol 03 B i	SW02				A5		
10	TCH98B13.19	98B13	bol 03 B i	SW01			engobe	A5		
11	TCH98B13.21	98B13	bol 05 B g	SW01			pseudo-engobe	A5		
12	TCH98B13.13	98B13	bol 05 A k	SW02			pseudo-engobe	A5		
13	TCH98B13.12	98B13	bol 05 A k	SW02				A5		
14	TCH98B13.54	98B13	pot 03 x	SW13				A5		
15	TCH98B13.77	98B13	tenon perforé	SW04			engobe	A5		
16	TCH98B56	98B13	vase miniature 06 B	SW05				A5		
17	TCH98B13.52	98B13	petite jarre 03 D 03	SW01			engobe	A5		
18	TCH98B13.60	98B13	petite jarre 03 D 03	SW01			engobe	A2		
19	TCH98B13.73	98B13	petite jarre 03 A 03	SW01				A5		
20	TCH98B13.65	98B13	petite jarre 03 A 01	SW01				A5		
21	TCH98B13.79	98B13	petite jarre 03 D 02	SW01			engobe	A5		
22	TCH98B13.48	98B13	jarre OE 02 B 25	SW13			peinture (sur engobe ?)	A5		
23	TCH98B54	98B13	petite jarre 03 D 03	SW07	III125		peinture sur engobe	A2		



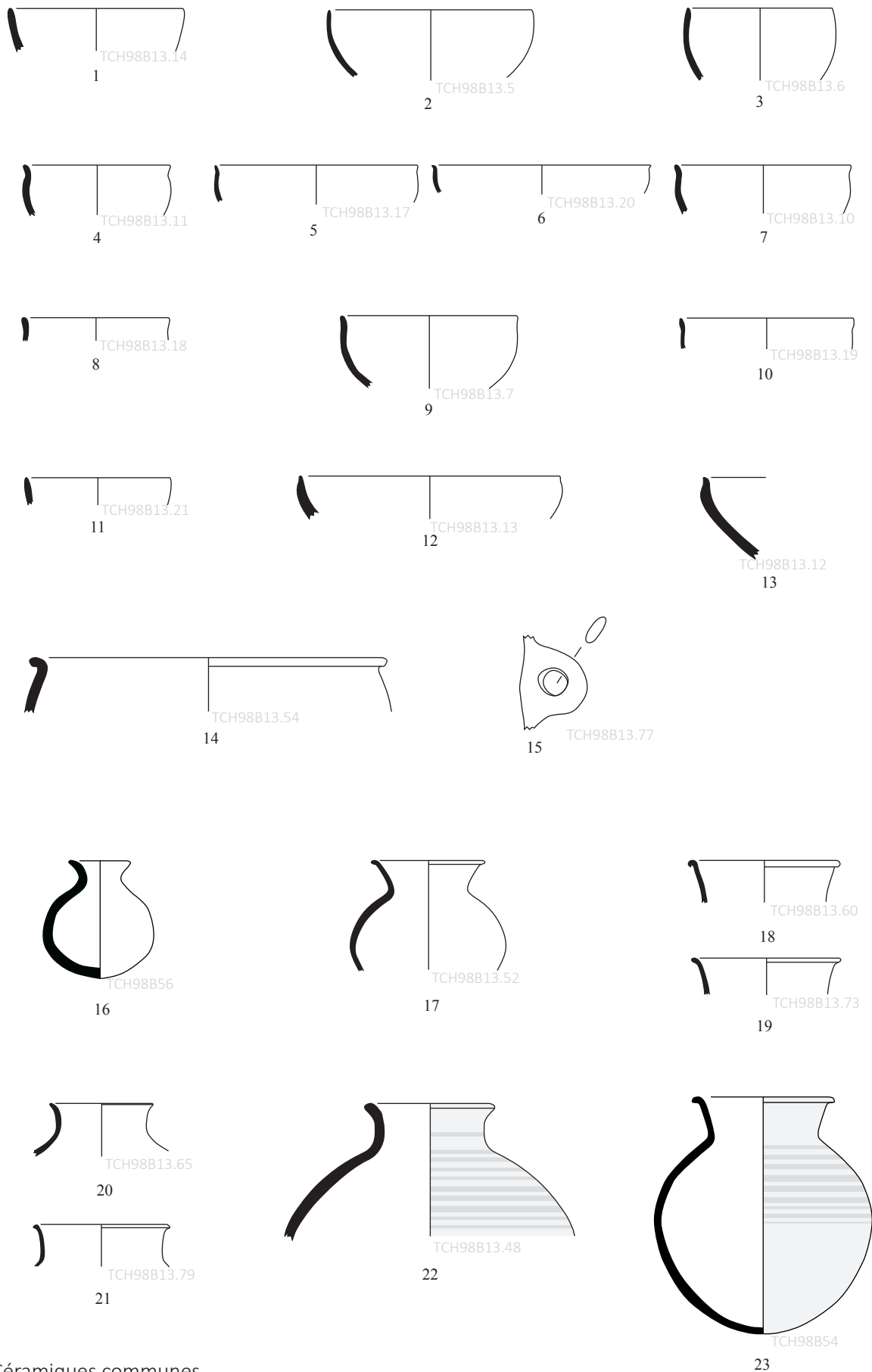

Céramiques communes



Catalogue 23

n°	IDpoterie	locus	forme	céra.	façonnage		décor	cui.	« marque »	
					MT	S			type	position
1	TCH98B13.56	98B13	jarre OE 02 A 26	SW07				A5		
2	TCH98B13.47	98B13	jarre OE 03 A 26	SW14				A5		
3	TCH98B13.42	98B13	jarre – nd	SW13				A5		
4	TCH98B13.63	98B13	jarre OL 02 B 37	SW05				A5		
5	TCH98B13.71	98B13	jarre OL 02 B 23	nd -SW				nd		
6	TCH98B13.53	98B13	petite jarre 02 D 14	SW13			peinture sur engobe	A5		
7	TCH98B13.67	98B13	jarre OL 02 B 23	SW01				A5		
8	TCH98B13.70	98B13	petite jarre 02 D 34	SW05				A5		
9	TCH98B59	98B13	jarre OL 02 D 17	SW05			engobe	A5		
10	TCH98B64	98B13	petite jarre 02 B 08	SW02			peinture	nd		
11	TCH98B13.46	98B13	jarre OL 02 B 16	SW13				A4		
12	TCH98B13.44	98B13	jarre OL 03 B 44	SW26b	IB-IIAB-III125	4		A1		
nd	TCH98B13.66	98B13	nd – bord	SW10				A2		
13	TCH98B13.76	98B13	panse	SW13			peinture	A5		

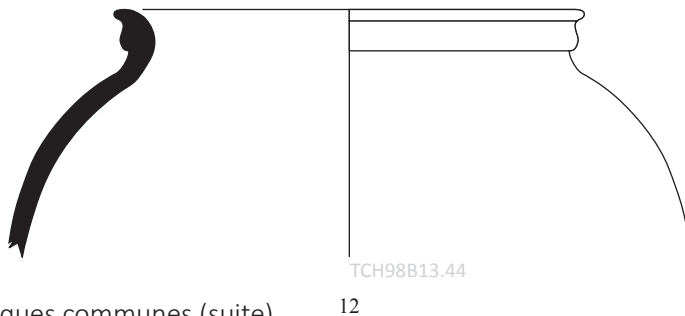
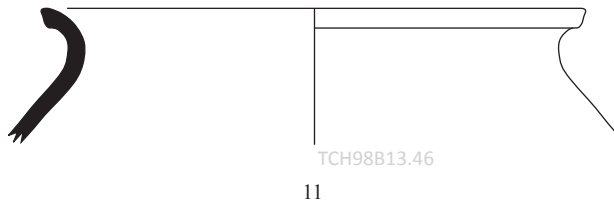
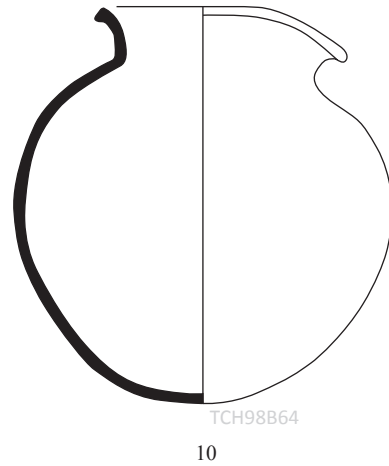
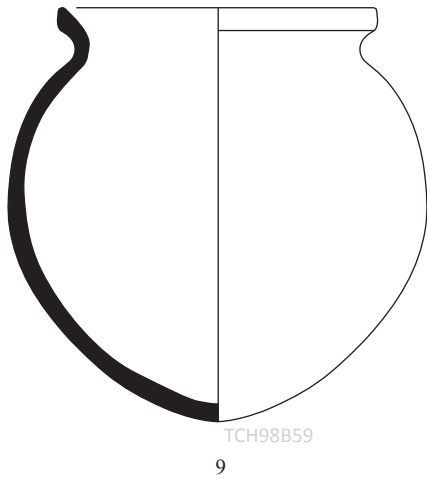
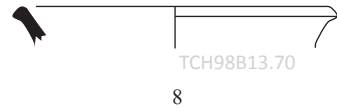
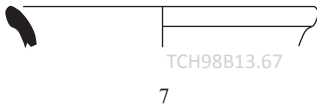
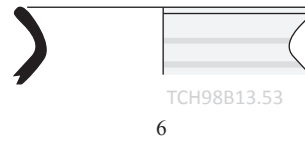
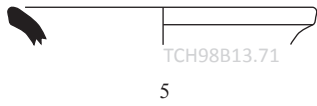
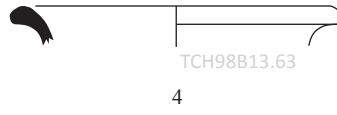
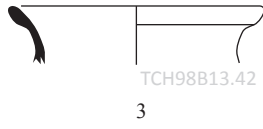
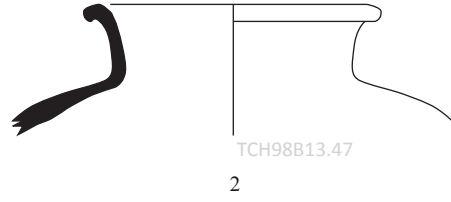
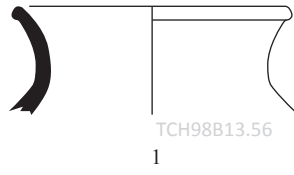

Céramiques communes (suite)



Catalogue 24

n°	IDpoterie	locus	forme	céra.	façonnage		décor	cui.	« marque »	
					MT	S			type	position
1	TCH98B13.75	98B13	bassin	GV				A5		
2	TCH98B13.22+24+25	98B13	grande jarre 02 54	GV				A2		
3	TCH98B13.23+26	98B13	grande jarre 01 52	GV				A1	incisée	lèvre, rebord

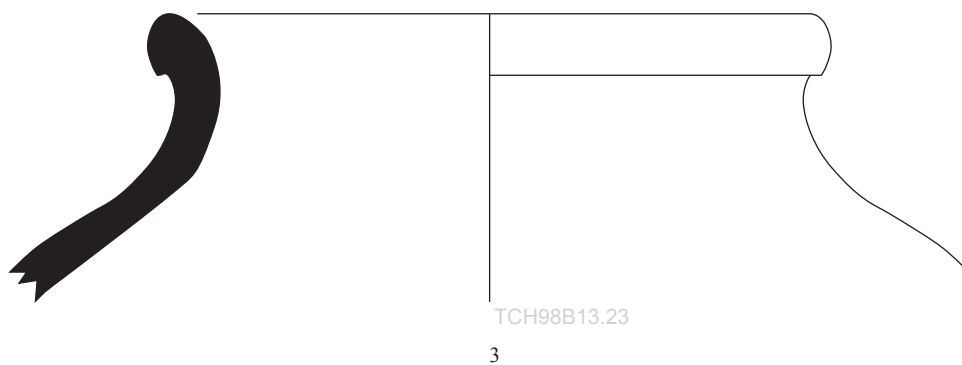
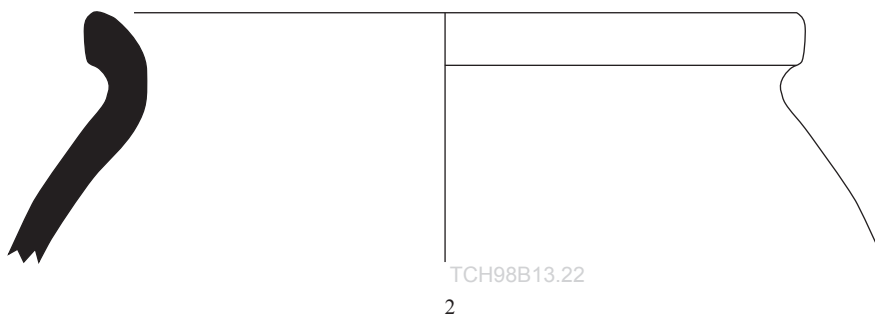
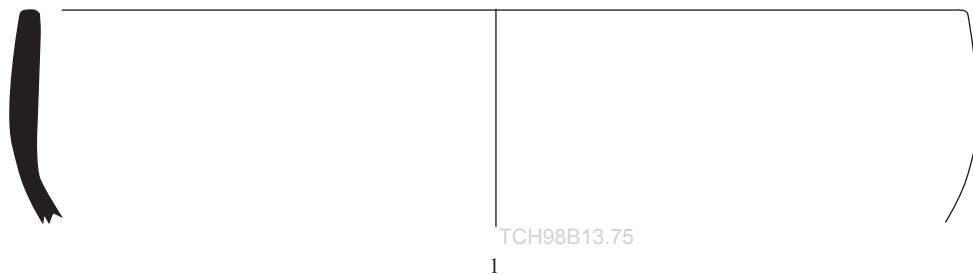

Céramiques à dégraissant végétal grossier (gv)



Catalogue 25

n°	IDpoterie	locus	forme	céra.	façonnage		décor	cui.	« marque »	
					MT	S			type	position
n.i.	TCH98B13.66	98B13	jarre ?	SW10				A2		
n.i.	TCH98B13.76	98B13	panse	SW13			peinture	A5		
1	TCH98B13.32	98B13	marmite 02 A	GM	III6a	3		A5		
2	TCH98B13.33	98B13	marmite 02 A	GM	III6a	3		A5		
n.i.	TCH98B13.37	98B13	marmite 02 A	GM				A4		
3	TCH98B65	98B13	petite jarre 03 E 05	MW 5			coloration par tournassage	A1		

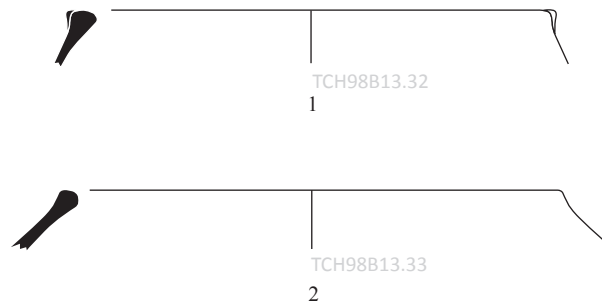

Céramiques à dégraissant minéral grossier (GM)

---

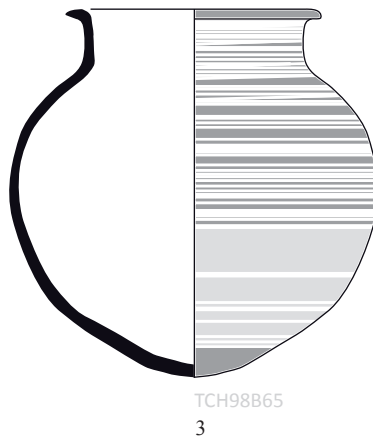

Céramiques métalliques





TCH98B15

Espace R13

		sw	gm	gv	mw	ew
NR	<b>317</b>	241	9	67		
NMI	<b>28</b>	26	1	1		
DIA	<b>28</b>	26	1	1		

n°	IDpoterie	locus	forme	céra.	façonnage		décor	cui.	« marque »	
					MT	S			type	position
1	TCH98B15.25	98B15	bol 01 B b	SW02	IB-IIB-III2			A5		
2	TCH98B15.26	98B15	bol 01 B d	SW01	IB-IIB-III2	4		A5		
3	TCH98B15.22	98B15	bol 01 B e	SW01	IB-IIB-III2	4		A5		
4	TCH98B15.29	98B15	bol 02 B a	SW02			pseudo-engobe (VO)	A5		
5	TCH98B15.15	98B15	bol 02 B b	SW02	IIB-III2b			A5		
6	TCH98B15.36	98B15	bol 03 B i	SW02	IB-IIB-III25	4		A5		
7	TCH98B15.33	98B15	bol 03 A i	nd	IB-IIB-III25	4	pseudo-engobe (VO)	A5		
8	TCH98B15.32	98B15	bol 05 A q	SW02	IIB-III2b			A5		
9	TCH98B15.28	98B15	bol 05 B j	SW01	IB-IIB-III25	4		A5		
10	TCH98B15.8	98B15	pot 03 v	SW10	IB-III25			A2		
11	TCH98B15.27	98B15	petite jarre 02 D 12	SW13	IB-IIA-III12	2		A4		
12	TCH98B15.2	98B15	base 1A	SW01				A5		
13	TCH98B15.10	98B15	jarre OE 02 A 26	SW13				A5		
14	TCH98B15.21	98B15	jarre OE 02 B 25	SW04	IB-IIB-III2			A5		
15	TCH98B15.17	98B15	jarre OE 02 B 25	SW13	III2b			A5		
16	TCH98B15.18	98B15	support ? bord	SW13	III2b			A5		



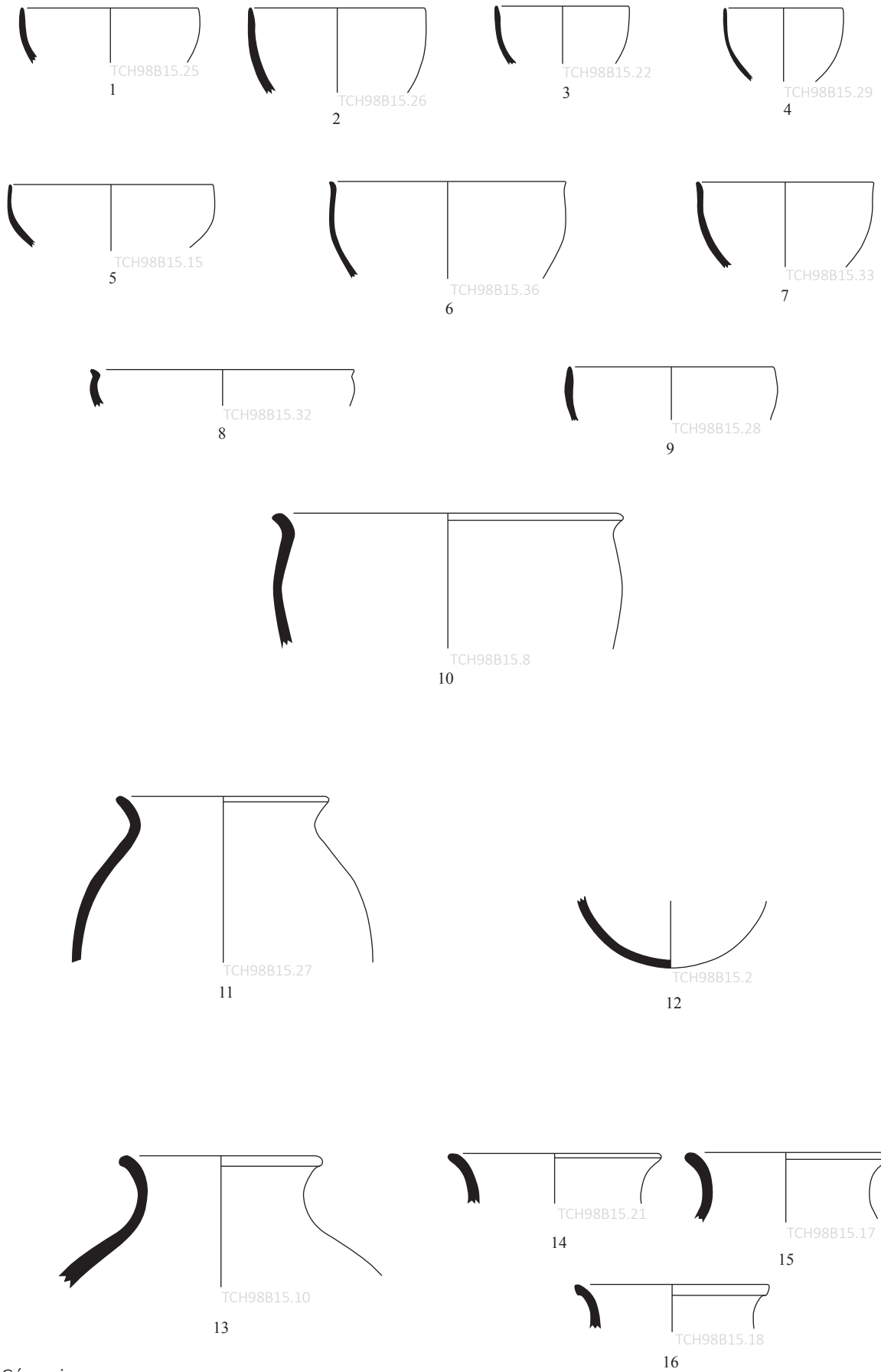

Céramiques communes



Catalogue 27

n°	IDpoterie	locus	forme	céra.	façonnage		décor	cui.	« marque »	
					MT	S			type	position
1	TCH98B15.9	98B15	jarre OL 02 D 21	SW13				A5		
2	TCH98B15.11+12	98B15	jarre OL 03 B 40	SW26	IB-IIB-III2			A5		
3	TCH98B15.31	98B15	jarre OL 03 B 44	SW26	IB-III12			A5		
4	TCH98B15.35	98B15	jarre OL 03 B 44	SW26	IB-IIB		engobe	A5		
5	TCH98B15.37	98B15	jarre OL 03 B 44	SW26	IB-IIB-III2			A5		
6	TCH98B15.3	98B15	jarre OL 03 B 43	SW26	III2			A5		

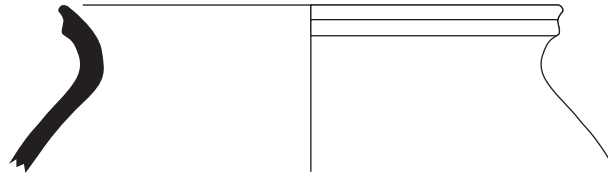

TCH98B15.9

1

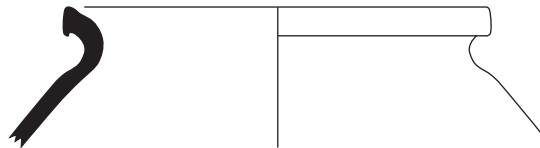

TCH98B15.11

2

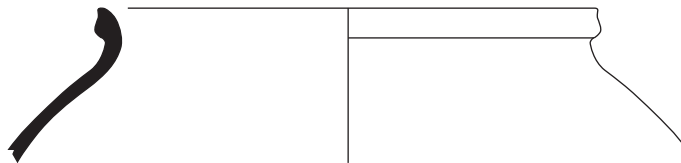

TCH98B15.31

3

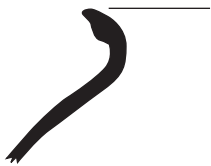

TCH98B15.35

4

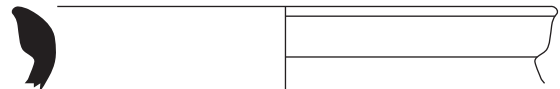

TCH98B15.37

5

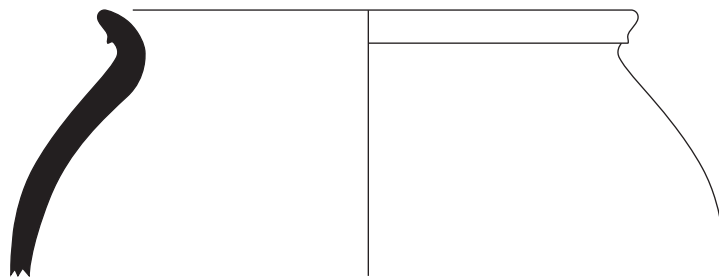

TCH98B15.3

6

Céramiques communes (suite)



Catalogue 28

n°	IDpoterie	locus	forme	céra.	façonnage		décor	cui.	« marque »	
					MT	S			type	position
1	TCH98B15.9	98B15	jarre OL 02 D 21	SW13				A5		
2	TCH98B15.11+12	98B15	jarre OL 03 B 40	SW26	IB-IIB-III2			A5		
3	TCH98B15.31	98B15	jarre OL 03 B 44	SW26	IB-III12			A5		
4	TCH98B15.35	98B15	jarre OL 03 B 44	SW26	IB-IIB		engobe	A5		
5	TCH98B15.37	98B15	jarre OL 03 B 44	SW26	IB-IIB-III2			A5		
6	TCH98B15.3	98B15	jarre OL 03 B 43	SW26	III2			A5		

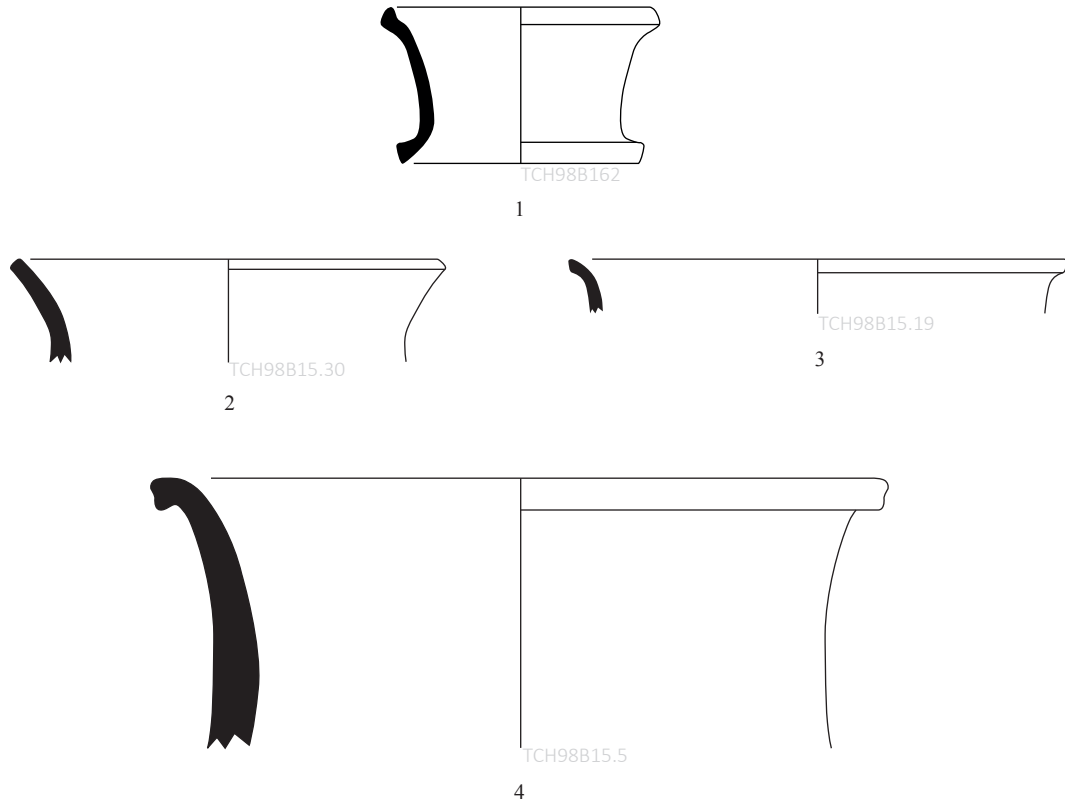

Céramiques communes (suite)

---

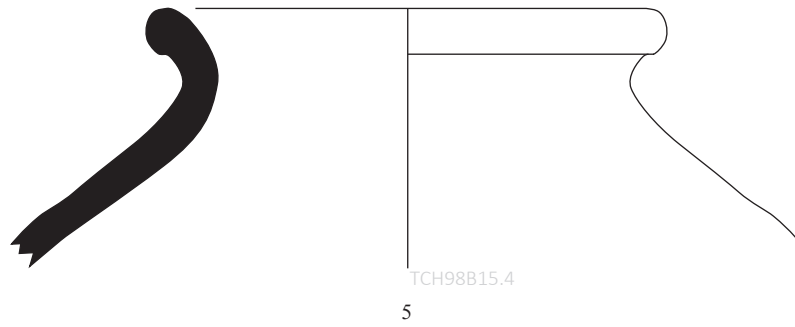

Céramiques à dégraissant végétal grossier (GV)

---

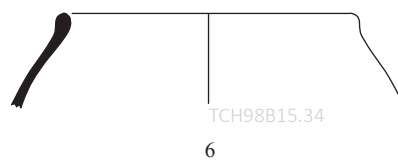

Céramiques à dégraissant minéral grossier (GM)



Catalogue 29



TCH98B16

Espace R8

		sw	gm	gv	mw	ew
NR	<b>45</b>	44		1		
NMI	<b>5</b>	4		1		
DIA	<b>4</b>	3		1		

n°	IDpoterie	locus	forme	céra.	façonnage		décor	cui.	« marque »	
					MT	S			type	position
2	TCH98B16.2	98B16	jarre OE 02 B 25	SW13	IB-III2			A5		
3	TCH98B16.4	98B16	jarre OL 02 B 37	SW05	IB-III2			A5		
1	TCH98B16.5	98B16	pot 03 A o	SW14?	IB-III125			A5		
4	TCH98B16.1	98B16	jarre de stockage 02 53	GV1	IB-IIA			A5		

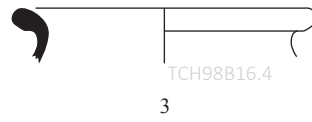
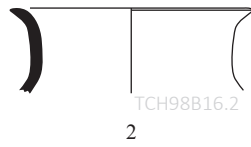
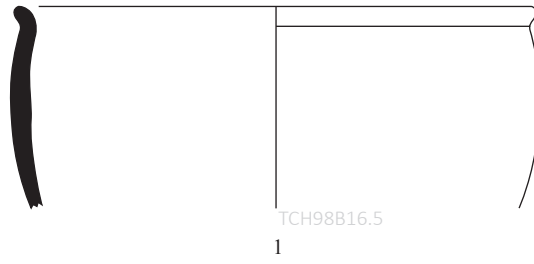

Céramiques communes

---

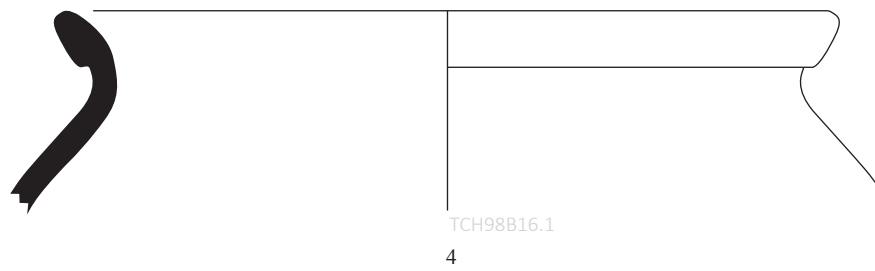

Céramiques à dégraissant végétal grossier (GV)



Catalogue 30

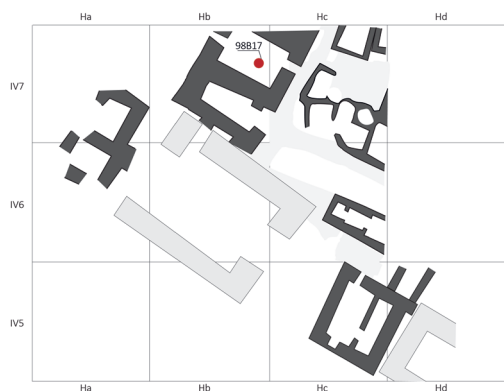

TCH98B17

Espace R7

		sw	gm	gv	mw	ew
NR	<b>55</b>	46	1	8		
NMI	<b>16</b>	13	1	2		
DIA	<b>17</b>	14	1	2		

n°	IDpoterie	locus	forme	céra.	façonnage		décor	cui.	« marque »	
					MT	S			type	position
1	TCH98B17.16	98B17	bol 02 B b	SW01 a	III2b		pseudo-engobe	A3		
2	TCH98B17.1	98B17	bol 05 B j	SW01	IB-IIB-III2		pseudo-engobe	A2		
3	TCH98B17.15	98B17	pot 03 x	SW07	IB-IIB-III2			A5		
4	TCH98B17.7	98B17	pot 03 A v	SW13				A5		
5	TCH98B17.18	98B17	petite jarre 03 A 06	SW01				A5		
6	TCH98B17.19	98B17	nd – support ?	SW14	IB-III2			A5		
7	TCH98B17.9	98B17	jarre OE 02 A 26	SW14	IB-III2			A5		
8	TCH98B17.11	98B17	petite jarre 02 D 12	SW05	III2b			A5		
9	TCH98B17.14	98B17	jarre OE 02 B 25	SW13	III2b			A5		
10	TCH98B17.13	98B17	jarre OE 02 B 25	SW13	IB-IIB-III2			A2		
11	TCH98B17.20	98B17	panse - encensoir ?	SW13	IB-IIB-III2	2	excision par découpage, incision	A5		
12	TCH98B17.8	98B17	jarre OL 02 B 16	SW07				A5		
13	TCH98B17.6	98B17	jarre OL 02 B 16	SW13	IB-IIA-III1	2	engobe	A5		
14	TCH98B17.10	98B17	jarre OL 02 D 20	GV1				A5		



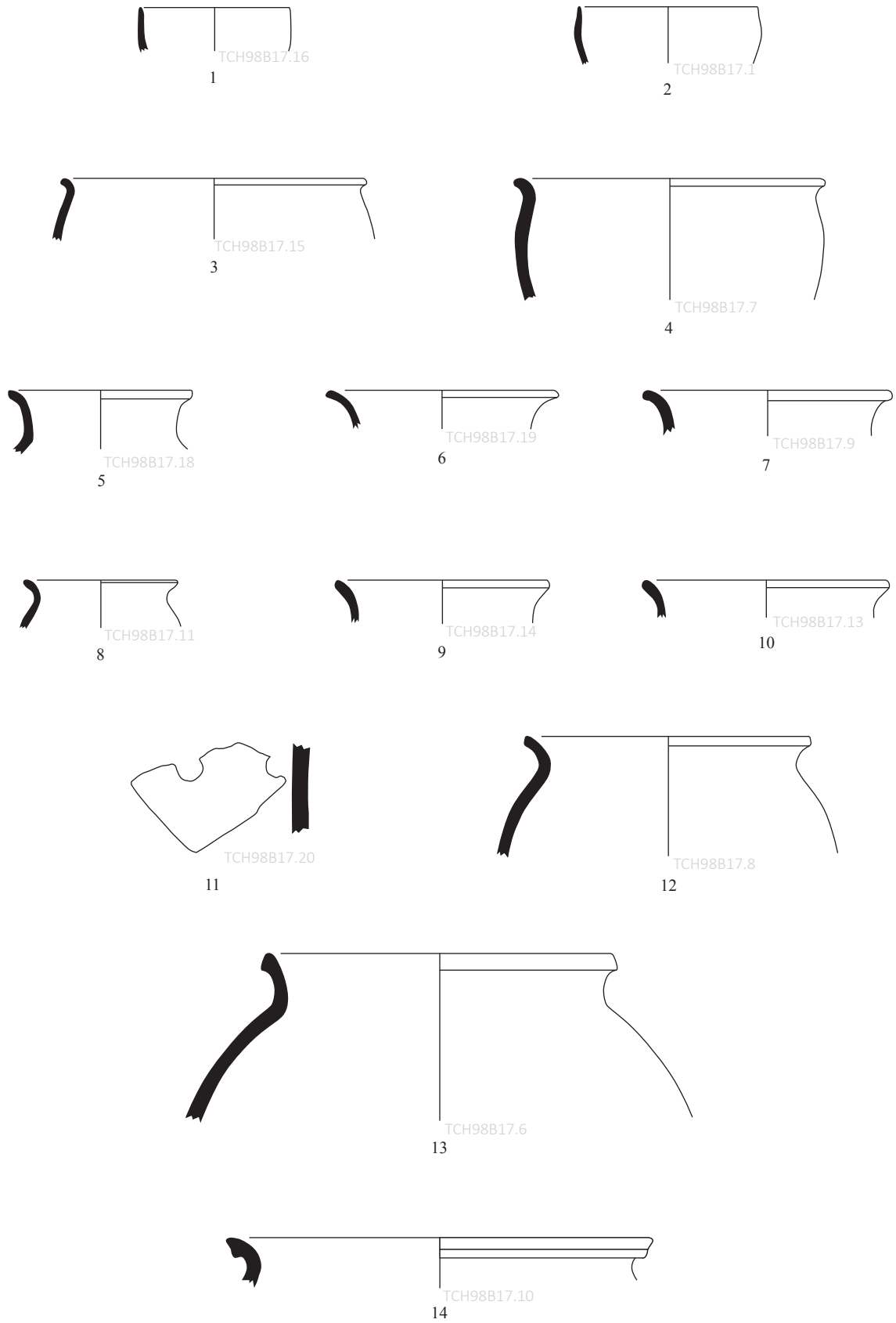

Céramiques communes



Catalogue 31

n°	IDpoterie	locus	forme	céra.	façonnage		décor	cui.	« marque »	
					MT	S			type	position
1	TCH98B17.2	98B17	marmite 03	GM	IB-IIA-III6a	3		B 3-		
2	TCH98B17.3	98B17	support 01	SW13	IB-III12			A5		
3	TCH98B17.4	98B17	jarre de stockage 02 54	GV	IB-III2b			A2		

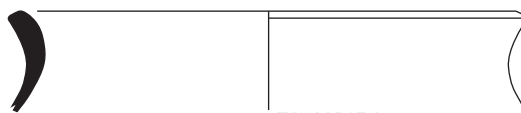

TCH98B17.2

1

Céramiques à dégraissant minéral grossier (GM)

---

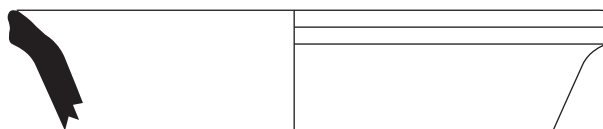

TCH98B17.3

2

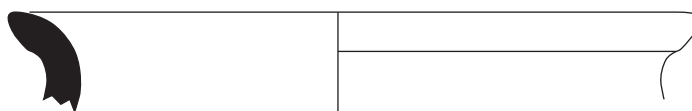

TCH98B17.4

3

Céramiques à dégraissant végétal grossier (GV)



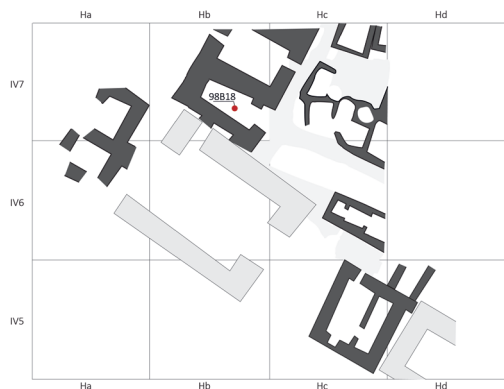

TCH98B18

Espace R5

		sw	gm	gv	mw	ew
NR	<b>48</b>	42	2	4		
NMI	<b>5</b>	3		2		
DIA	<b>6</b>	4		2		

n°	IDpoterie	locus	forme	céra.	façonnage		décor	cui.	« marque »	
					MT	S			type	position
n.i.	TCH98B18.30	98B18	bol 02 A d	SW01				A5		
4	TCH98B18.3	98B18	jarre OL 02 D 21	SW05				A5		
5	TCH98B18.2	98B18	jarre OL 03 B 36	SW05				A5		
6	TCH98B18.1	98B18	base 3B	SW05				A5		
7	TCH98B18.4	98B18	jarre de stockage 02 54	GV				A5		
8	TCH98B18.5	98B18	jarre de stockage	GV				A2		

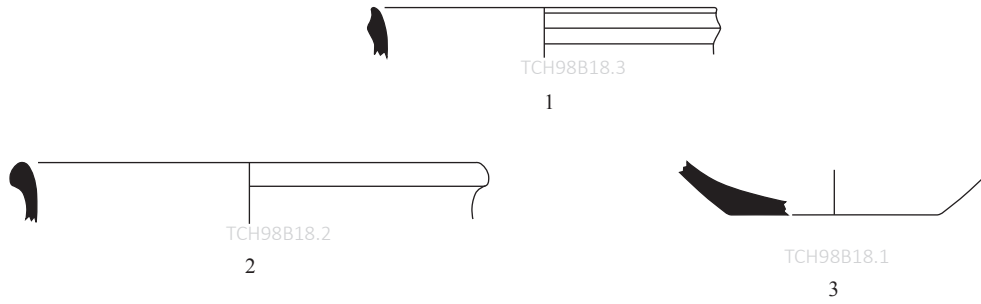

Céramiques communes

---

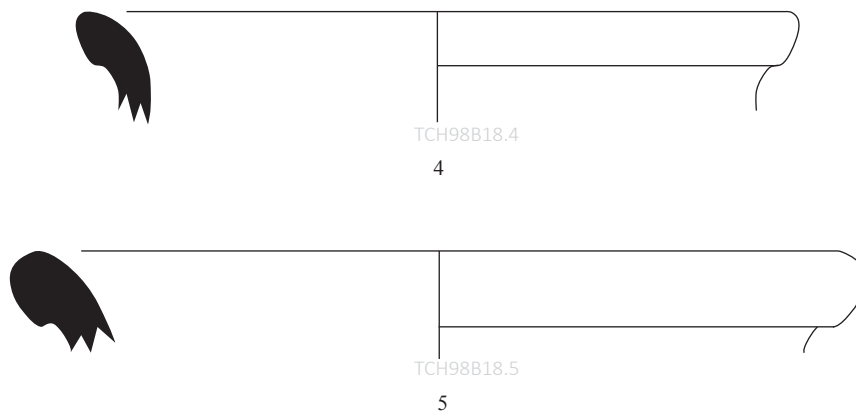

Céramiques à dégraissant végétal grossier (GV)



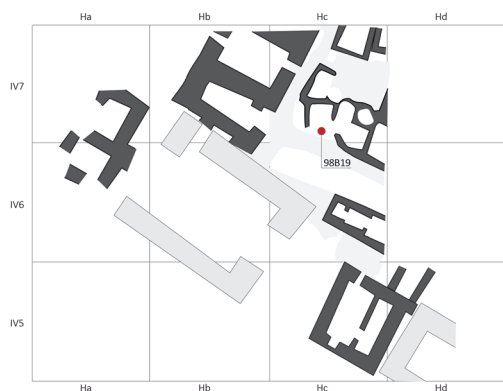

TCH98B19

Couche cendreuse dans l'espace R13  
(publication 1995)

		sw	gm	gv	mw	ew
NR	<b>35</b>	26		9		
NMI	<b>10</b>	8	1	1		
DIA	<b>11</b>	10	1	0		

n°	IDpoterie	locus	forme	céra.	façonnage		décor	cui.	« marque »	
					MT	S			type	position
1	TCH98B19.4	98B19	bol 01 B a	SW02	IB-IIB-III5	4	pseudo-engobe (VO)	A5		
3	TCH98B19.3	98B19	bol 02 C c	SW01	III2			A5		
2	TCH98B19.5	98B19	bol 02 A d	SW01	III25	4		A3		
6	TCH98B19.7	98B19	petite jarre 02 A 15	SW01	III2		engobe réservé	A5		
5	TCH98B19.8	98B19	jarre OE 02 A 25	SW13				A5		
4	TCH98B19.6	98B19	jarre OE 02 B 25	SW14	III2b			A5		
7	TCH98B19.9	98B19	support 04	SW13				A5		
8	TCH98B35	98B19	vase miniature 06 B	SW01	IB-III12			A5		
9	TCH98B19.1	98B19	base 1A	SW01	IB-IIB-III125	4		A5		
10	TCH98B19.2	98B19	base 2	SW01	IB-IIB-III4	5		A2		
11	TCH98B19.10	98B19	marmite 02 B	GM	III6a	3		A5		

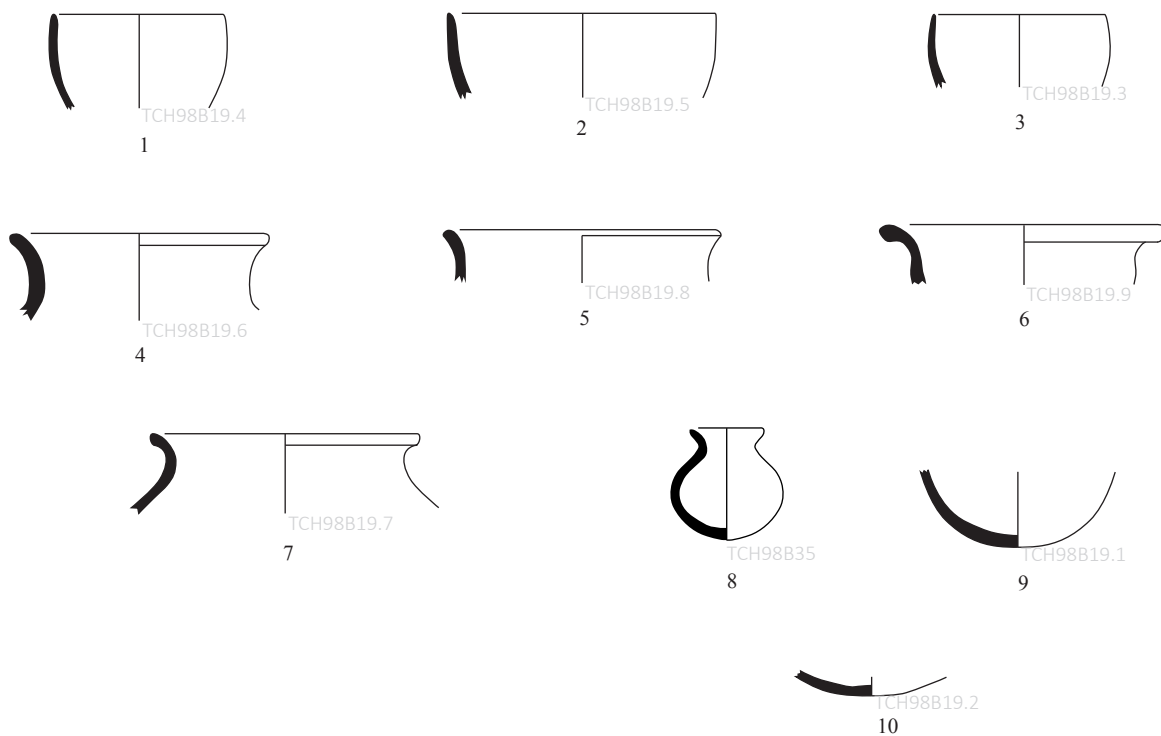

Céramiques communes

---

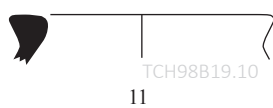

Céramiques à dégraissant minéral grossier (GM)



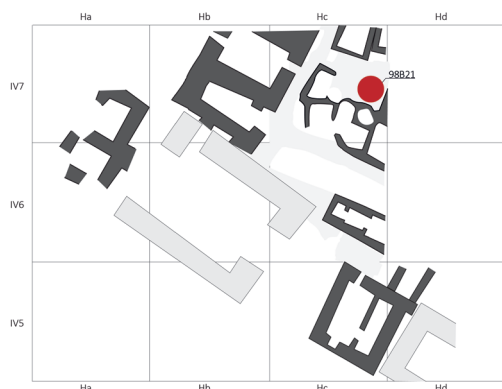

TCH98B21

Démontage Hof 10 (descente sous niveau de sol)

		sw	gm	gv	mw	ew
NR	<b>1279</b>	1118	33	128		
NMI	<b>115</b>	98	8	8		
DIA	<b>123</b>	106	8	8	1	

n°	IDpoterie	locus	forme	céra.	façonnage		décor	cui.	« marque »	
					MT	S			type	position
1	TCH98B21.98	98B21	bol bas 02 A e	SW01	IB-IIB-III12	4	pseudo-engobe	A5		
2	TCH98B21.123	98B21	bol bas 03 A i	SW02	IB-IIB-III2b		pseudo-engobe (VO)	A4		
3	TCH98B21.95	98B21	bol bas 03 B i	SW01	IB-IIB-III125	4	pseudo-engobe (VO)	A5		
4	TCH98B21.52	98B21	bol bas 03 B i	SW02	IB-IIB-III12	4		A4		
5	TCH98B21.85	98B21	bol bas 03 C i	SW01	IB1-IIB-III12	4	pseudo-engobe (VO)	A5		
n.i.	TCH98B21.124	98B21	bol	nd -SW				A5		
6	TCH98B21.186	98B21	bol 01 A e	SW02	IB-IIB-III2		engobe	A5		
7	TCH98B21.3	98B21	bol 01 B a	SW01	IB-IIB-III12	4	pseudo-engobe	A2		
8	TCH98B21.202	98B21	bol 01 B a	SW02	IB-IIB-III2b			A5		
9	TCH98B21.70	98B21	bol 01 B b	SW02	IB-IIB-III125	4		A5		
10	TCH98B21.99	98B21	bol 01 B e	SW02a	IB-IIB-III2			A2		
11	TCH98B21.87	98B21	bol 01 C a	SW01			pseudo-engobe (VO)	A5		
12	TCH98B21.73	98B21	bol 01 C a	SW02				A5		
13	TCH98B21.185	98B21	bol 01 C b	SW01	IB-IIB-III12	4	pseudo-engobe	A5		
14	TCH98B21.178	98B21	bol 02 A a	SW01	IB-IIB-III2			A5		
15	TCH98B21.194	98B21	bol 02 A a	SW02	IB-IIB-III12	4		A5		
16	TCH98B21.4	98B21	bol 02 A a	SW14	IB-IIA-III1	2		A2		
17	TCH98B21.98	98B21	bol 02 A b	SW01	IB-IIB-III125	4	pseudo-engobe (VO)	A5		
18	TCH98B21.102	98B21	bol 02 A b	SW02				A1		
19	TCH98B21.68	98B21	bol 02 A e	SW01	IB-IIB-III2b			A5		
20	TCH98B21.59	98B21	bol 02 B a	SW01	IB1-IIB-III12	4	pseudo-engobe (VO)	A5		
21	TCH98B21.60	98B21	bol 02 B a	SW02	IB1-IIB-III12	4		A5		
22	TCH98B21.190	98B21	bol 02 B d	SW01	IB-IIB-III25	4		A5		
23	TCH98B21.72	98B21	bol 02 B d	SW01				A5		
24	TCH98B21.9	98B21	bol 02 B d	SW01				A5		
25	TCH98B21.207	98B21	bol 02 B d	SW02				A5		
26	TCH98B21.64	98B21	bol 02 B e	SW01	III2b			A3		
27	TCH98B21.189	98B21	bol 02 C b	SW07				A5		
28	TCH98B21.96	98B21	bol 02 C c	SW01	IB-IIB-III25	4	pseudo-engobe (VO)	A5		
29	TCH98B21.192	98B21	bol 02 C c	SW01	IB-IIB-III2b		pseudo-engobe (VO)	A5		
30	TCH98B21.92	98B21	bol 02 C e	SW01	IB-IIB-III2		pseudo-engobe (VO)	A5		
31	TCH98B21.97	98B21	bol 02 C e	SW01	IB-IIB-III2b		pseudo-engobe	A5		
32	TCH98B21.100	98B21	bol 02 C e	SW01a	IB-IIB-III23	4	pseudo-engobe (VO)	A5		



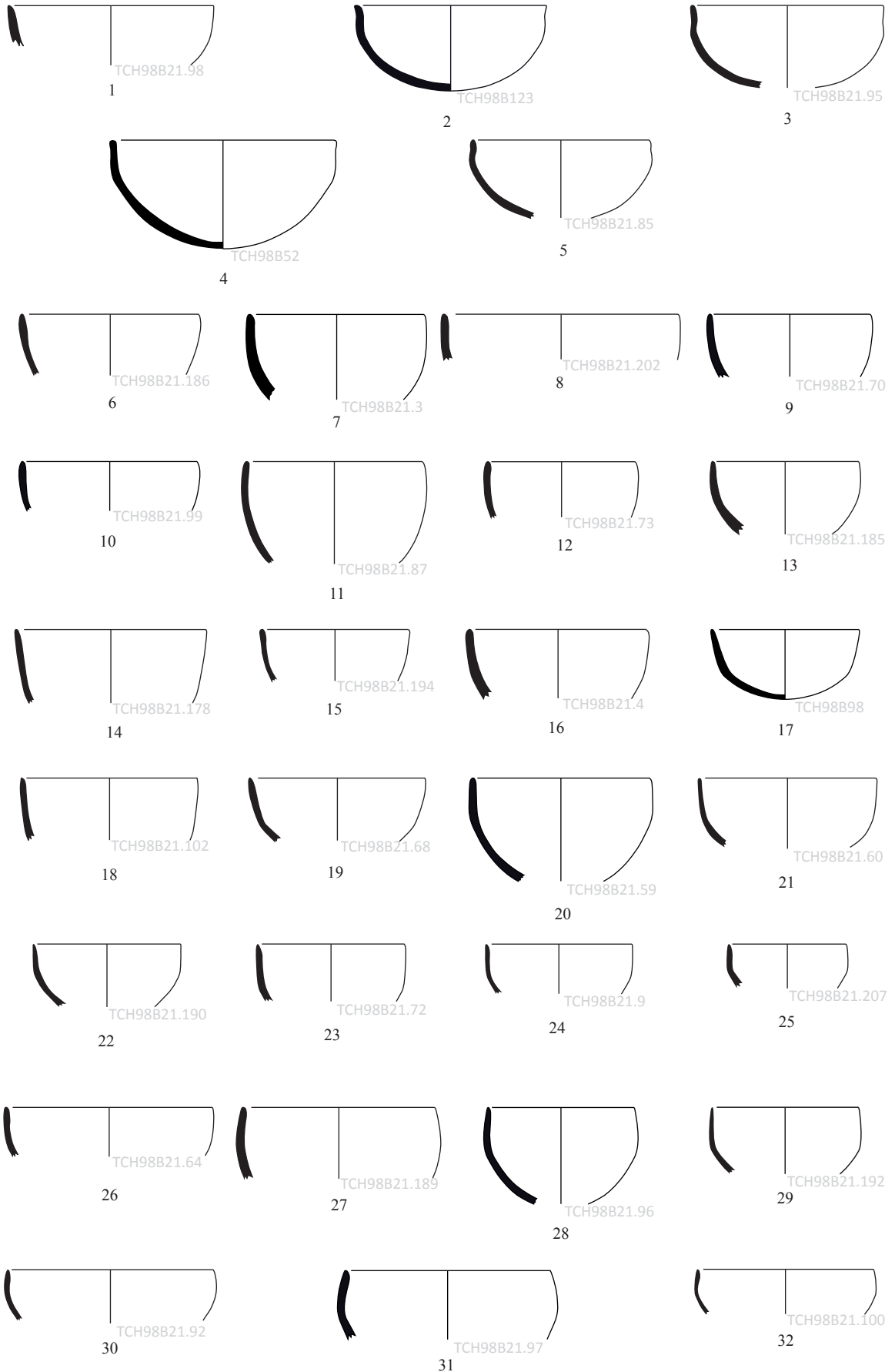

Céramiques communes



n°	IDpoterie	locus	forme	céra.	façonnage		décor	cui.	« marque »	
					MT	S			type	position
1	TCH98B21.63	98B21	bol 03 A i	SW02	III12		pseudo-engobe	A5		
2	TCH98B21.57	98B21	bol 03 B i	SW01	IB-IIB-III125	4	engobe	A5		
3	TCH98B21.191	98B21	bol 03 B i	SW01	IB-IIB-III15	4		A5		
4	TCH98B21.198	98B21	bol 03 B i	SW02				A5		
5	TCH98B21.183	98B21	bol 03 B i	SW02	IB-IIB-III12	4		A5		
6	TCH98B21.71	98B21	bol 03 B i	SW02				A5		
7	TCH98B21.61	98B21	bol 03 B i	SW07	IB-IIB-III12	4	pseudo-engobe	A5		
8	TCH98B21.74	98B21	bol 03 B j	SW02	IB-IIB-III2			A5		
9	TCH98B21.101	98B21	bol 03 B j	SW02	IB-IIB-III2b			A5		
10	TCH98B21.112	98B21	bol 03 B n	SW07	III2b			A5		
11	TCH98B21.184	98B21	bol 03 C i	SW02	IB-IIB-III2		pseudo-engobe	A2		
12	TCH98B21.182	98B21	bol 03 C n	nd - surcuit	III2			B		
13	TCH98B21.139	98B21	bol 05 A g	SW02	III2		pseudo-engobe	A2		
14	TCH98B21.66	98B21	bol 05 A k	SW02	IB-IIB-III2b			A5		
15	TCH98B21.180	98B21	bol 05 A k	SW02				A5		
16	TCH98B21.211	98B21	bol 05 A k	SW02				A5		
17	TCH98B21.188	98B21	bol 05 B k	SW02	IB-IIB-III12	4		A5		
18	TCH98B21.197	98B21	bol 05 B k	SW02	IB-IIB-III2			A5		
19	TCH98B21.203	98B21	bol 05 B k	SW02	III2		pseudo-engobe	A5		
20	TCH98B21.94	98B21	bol 05 B l	SW01	IB-IIB-III2			A5		
21	TCH98B21.144	98B21	jatte 01 t	SW10	IB-IIA-III12	2		A5		

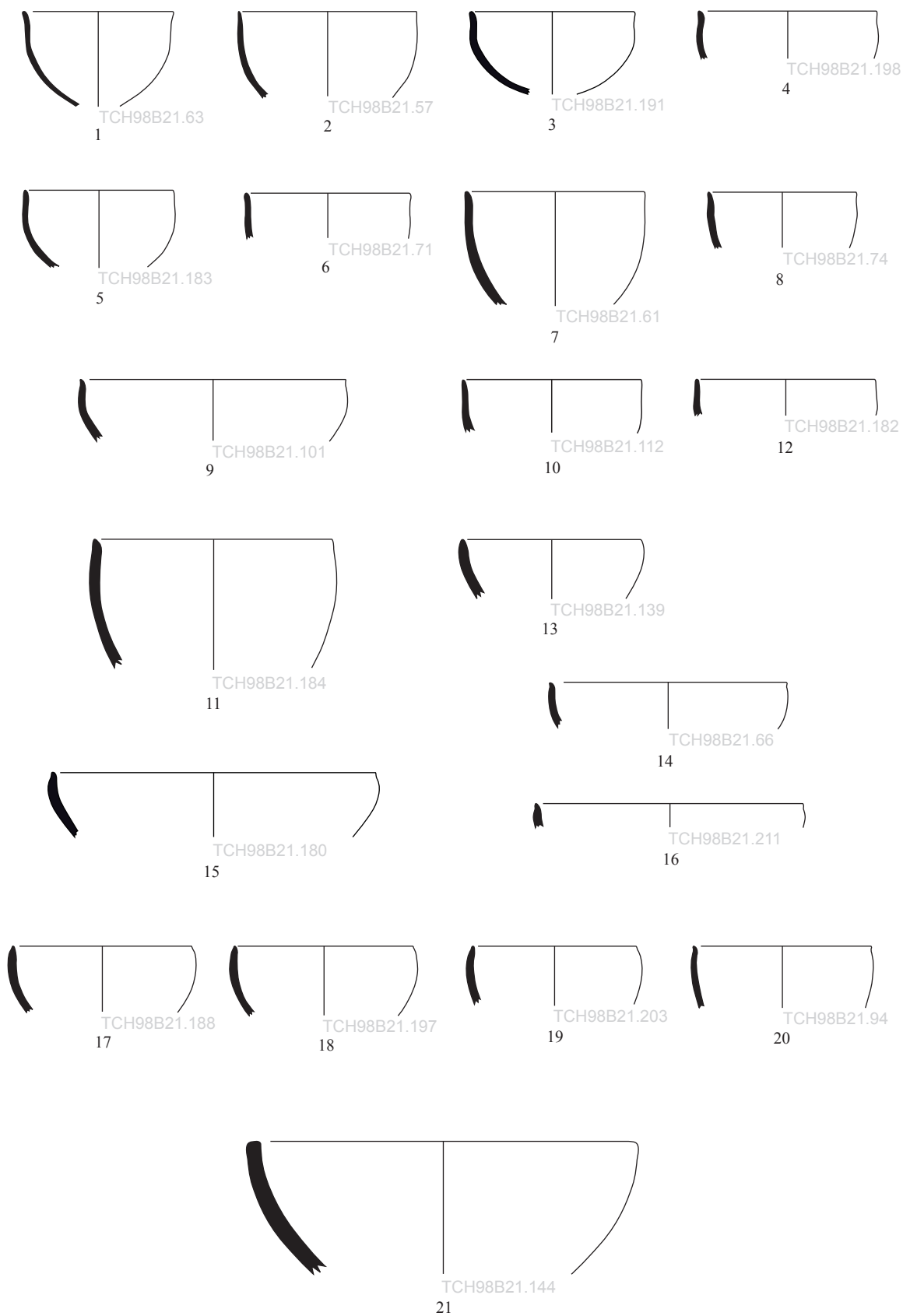

Céramiques communes (suite)



n°	IDpoterie	locus	forme	céra.	façonnage		décor	cui.	« marque »	
					MT	S			type	position
1	TCH98B21.164	98B21	pot 03 o	SW02				A5		
2	TCH98B21.165	98B21	pot 03 o	SW07	IB-II B-III2			A2		
3	TCH98B21.162	98B21	pot 03 o	SW13	IB-II B-III2			A5		
4	TCH98B21.83	98B21	pot 03 o	SW13	IB-II B-III2			A2		
5	TCH98B21.82	98B21	pot 03 u	SW13	IB-III123		pseudo-engobe	A5		
6	TCH98B21.158	98B21	pot 03 u	SW13	III2		pseudo-engobe	A5		
7	TCH98B50	98B21	pot 03 v	SW13	IB-III12			A5		
8	TCH98B21.159	98B21	pot 03 u	SW14	IB-III2			A2		
9	TCH98B21.128	98B21	pot 03 u	SW14				A5		
10	TCH98B21.137	98B21	pot 03 v	SW07	IB-II B-III2		pseudo-engobe	A5		
11	TCH98B21.161	98B21	pot 03 v	SW14	IB-III125			A3		
12	TCH98B21.130	98B21	pot 03 w	SW02				A5		
13	TCH98B21.160	98B21	pot 03 w	SW13	IB-II B-III2		pseudo-engobe	A5		
14	TCH98B21.124	98B21	pot 03 w	SW13				A5		
15	TCH98B21.157	98B21	pot 03 w	SW14				A5		
16	TCH98B21.163	98B21	pot 03 x	SW14				A5		

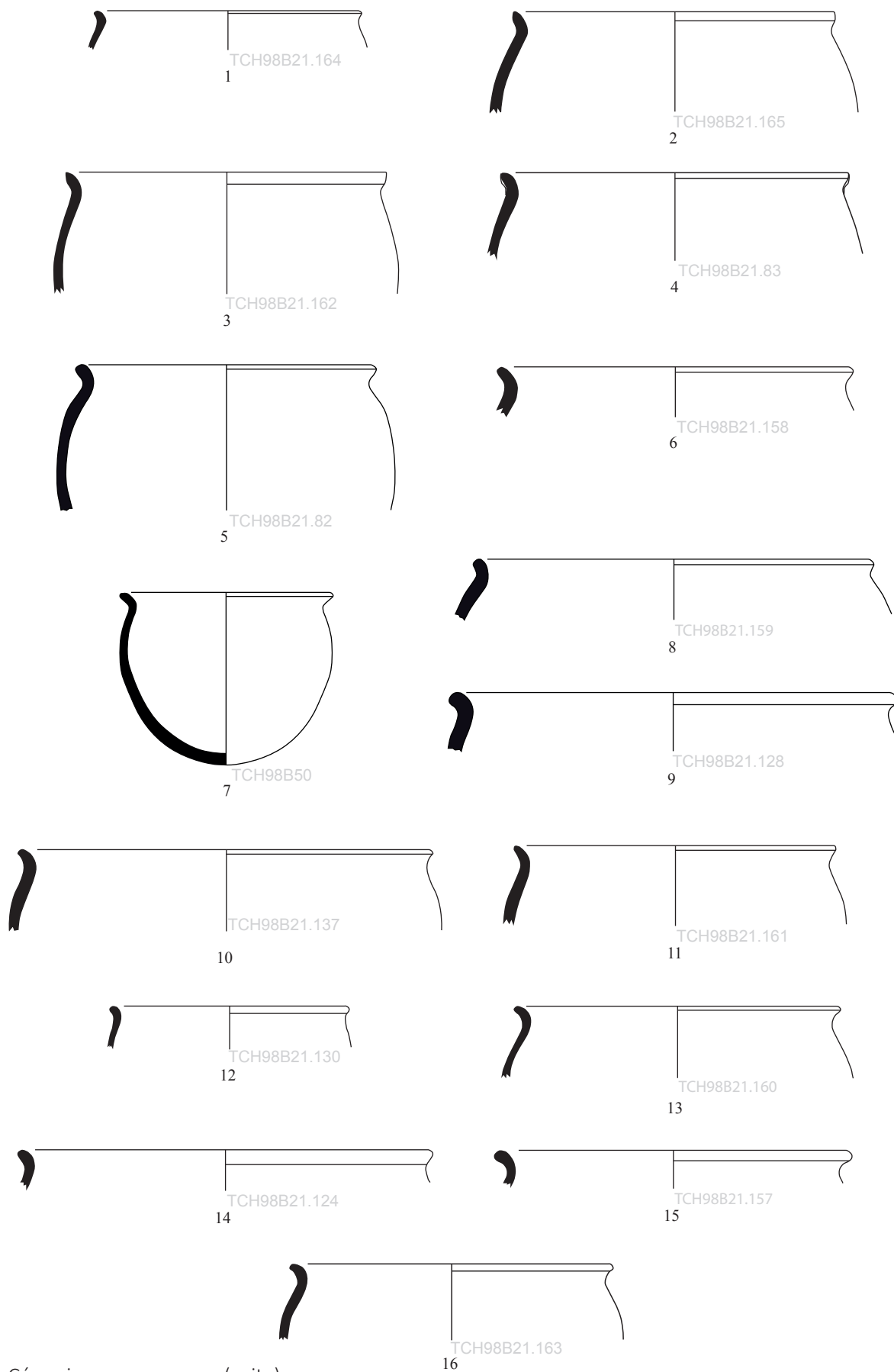

Céramiques communes (suite)



n°	IDpoterie	locus	forme	céra.	façonnage		décor	cui.	« marque »	
					MT	S			type	position
1	TCH98B21.221	98B21	vase à tubulaire goulot	SW01	IB		engobe	A5		
2	TCH98B21.177	98B21	petite jarre 03 D 02	SW01				A5		
3	TCH98B21.169	98B21	petite jarre 03 A 01	SW02	IB-III2			A5		
4	TCH98B21.168	98B21	petite jarre 03 D 02	SW01				A5		
5	TCH98B21.167	98B21	petite jarre 03 D 02	SW07				A2		
n.i.	TCH98B27	98B21	petite jarre 03 D 02	SW01	IB-III12			A2		
6	TCH98B21.55	98B21	petite jarre 03 D 03	SW01	III2		peinture sur engobe	A5		
7	TCH98B21.122	98B21	petite jarre 02 A 15	SW13				A5		
8	TCH98B21.173	98B21	petite jarre 02 B 06	SW13				A5		
9	TCH98B21.84	98B21	petite jarre 02 A 15	SW01	IB-III2			A5		
10	TCH98B21.51	98B21	petite jarre 02 D 34	SW05	IB-IIA-III12	2		A5		
n.i.	TCH98B21.174	98B21	jarre	SW14			engobe	A5		
11	TCH98B21.86	98B21	jarre OE 02 A 25	SW13	IB-III1			A5		
12	TCH98B21.129	98B21	jarre OE 02 B 25	SW14				A5		
13	TCH98B21.50	98B21	jarre OE 02 B 27	SW04	IB-IIB-III2			A5		
14	TCH98B21.126	98B21	jarre OE 03 A 25	SW14	IB			A5		
15	TCH98B21.121	98B21	jarre OE 03 B 23	SW01a	IB-III2			A5		
16	TCH98B21.75	98B21	jarre OE 03 B 23	SW14	IB-IIA-III12	2	engobe	A2		
n.i.	TCH98B21.175	98B21	jarre OL ?	SW01			engobe	A5		
17	TCH98B21.156	98B21	jarre OL 02 B 16	SW13	IB-IIA-III1	2	pseudo-engobe	A5		
18	TCH98B21.125	98B21	jarre OL 02 D 17	SW14?				A5		
19	TCH98B21.155	98B21	jarre OL 02 B 16	SW13	IB-III12			A5		
20	TCH98B21.154	98B21	jarre OL 02 D 21	SW26	IB-III12			A5		

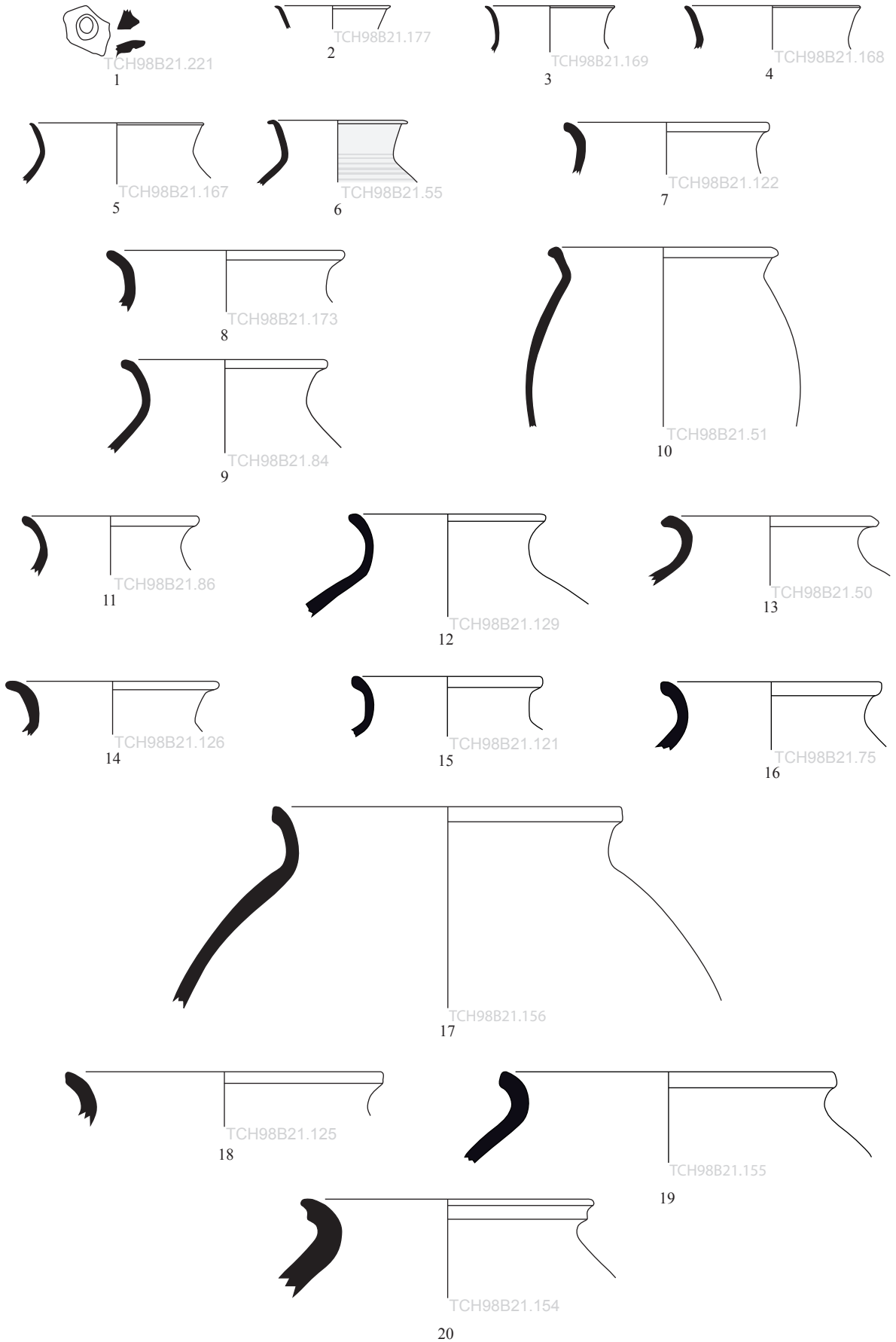

Céramiques communes (suite)



Catalogue 38

n°	IDpoterie	locus	forme	céra.	façonnage		décor	cui.	« marque »	
					MT	S			type	position
1	TCH98B21.152	98B21	jarre OL 03 B 44	SW26	IB-II B-III2			A5		
2	TCH98B21.45	98B21	jarre OL 03 B 44	SW26	IB-II B-III2		pseudo-engobe	A1		
3	TCH98B21.153	98B21	jarre OL 03 B 44	SW26				A5		
4	TCH98B21.145	98B21	jarre de stockage 03 B 46	SW26	IB-II B		engobe	A2		
5	TCH98B21.88	98B21	passoire	SW13	IB-III2		engobe	A5		
6	TCH98B21.89	98B21	support 01	SW13				A5		
7	TCH98B21.176	98B21	support 01	SW13	IB-II B-III2			A5		
8	TCH98B21.216	98B21	base 1A	SW01	IB-II B-III4	5		A5		
9	TCH98B21.141	98B21	base 1A	SW10	III1			A2		
10	TCH98B21.1	98B21	base 3B	nd – SW	IB-II B-III4	5		A5		
11	TCH98B21.218	98B21	base 3B	SW07				A5		
12	TCH98B21.143	98B21	base 7A	SW07	IB-III2			A5		



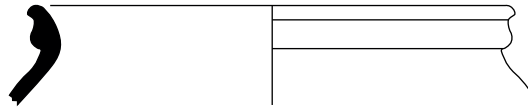

TCH98B21.152

1

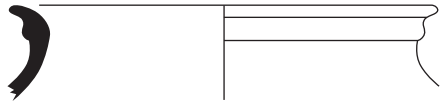

TCH98B21.45

2



TCH98B21.153

3

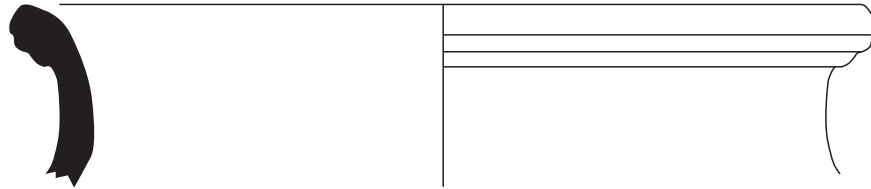

TCH98B21.145

4



TCH98B21.88

5



TCH98B21.89

6

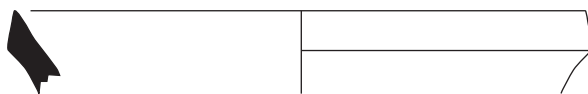

TCH98B21.176

7



TCH98B21.216

8



TCH98B21.141

9

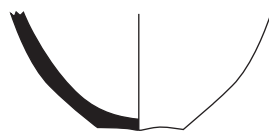

TCH98B21.1

10



TCH98B21.218

11



TCH98B21.143

12

Céramiques communes (suite)



n°	IDpoterie	locus	forme	céra.	façonnage		décor	cui.	« marque »	
					MT	S			type	position
1	TCH98B21.166	98B21	pot 02 a	GV				A5		
2	TCH98B21.148	98B21	jarre de stockage 02 54	GV	IB			A5		
3	TCH98B21.150	98B21	jarre de stockage 02 50	GV			engobe	A2		
4	TCH98B21.151	98B21	jarre de stockage 02 54	GV				A5		
5	TCH98B21.27	98B21	jarre de stockage 02 53	GV				A1		
6	TCH98B21.147	98B21	jarre de stockage 02 54	GV				A2		
7	TCH98B21.149	98B21	jarre de stockage 02 53	GV				A2		
8	TCH98B21.76	98B21	jarre de stockage 02 54	GV				A2		

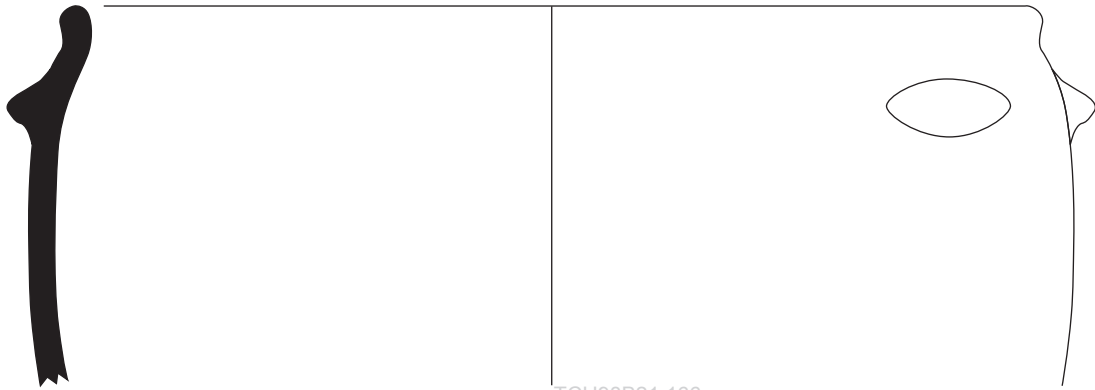

TCH98B21.166

1

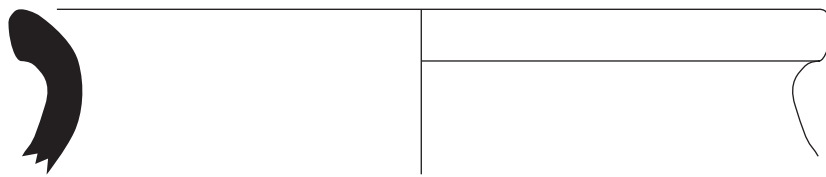

TCH98B21.148

2

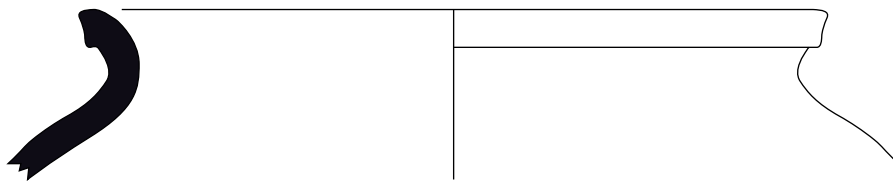

TCH98B21.150

3



TCH98B21.151

4

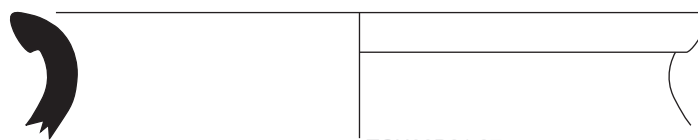

TCH98B21.27

5



TCH98B21.147

6



TCH98B21.149

7

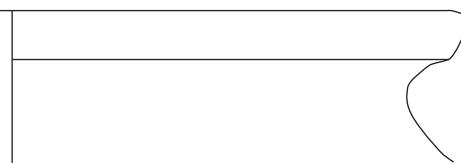

TCH98B21.76

8

Céramiques à dégraissant végétal grossier (GV)



Catalogue 40

n°	IDpoterie	locus	forme	céra.	façonnage		décor	cui.	« marque »	
					MT	S			type	position
1	TCH98B21.80	98B21	nd – support ?	nd				nd		
2	TCH98B21.31	98B21	marmite 02 A	GM	IB-IIA-III6	3		A5		
3	TCH98B21.35	98B21	marmite 02 A	GM	IIA-III6	3		A2		
4	TCH98B21.79	98B21	marmite 02 A	GM				A2		
5	TCH98B21.30	98B21	marmite 02 B	GM	IB-IIA-III6b	3		A5		
6	TCH98B21.36	98B21	marmite 02 B	GM	III6a	3		A5		
7	TCH98B21.219	98B21	marmite 02 C	GM	IB-IIA-III6	3		A2		
8	TCH98B21.81	98B21	marmite 03	GM	IB-IIA-III6b	3		A5		
9	TCH98B21.220	98B21	marmite 03	GM	IB-IIA-III6a	3		A5		
10	TCH98B21.217	98B21	base 1A	MW 9	IB-IIB-III24	5		A5		



TCH98B21.80

1

Céramiques à dégraissant végétal grossier (GV)

---



TCH98B21.31

2

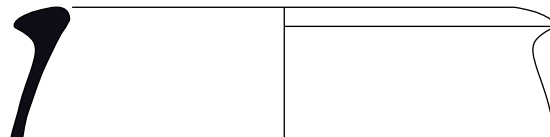

TCH98B21.35

3



TCH98B21.79

4

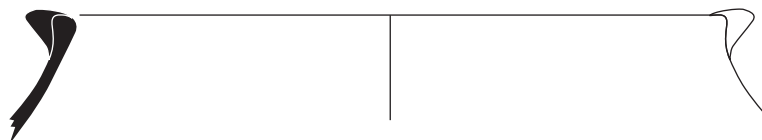

TCH98B21.30

5



TCH98B21.36

6

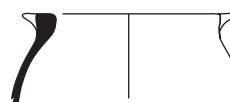

TCH98B21.219

7



TCH98B21.81

8

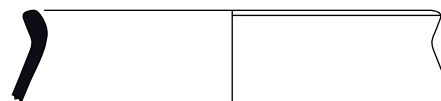

TCH98B21.220

9

Céramiques à dégraissant minéral grossier (GM)

---



TCH98B21.217

10

Céramiques métalliques



Catalogue 41



TCH98B23

Espace R9

		sw	gm	gv	mw	ew
NR	<b>241</b>	220	3	18		
NMI	<b>70</b>	63	1	4	2	
DIA	<b>78</b>	71	1	4	2	

n°	IDpoterie	locus	forme	céra.	façonnage		décor	cui.	« marque »	
					MT	S			type	position
1	TCH98B23.43	98B23	bol bas 02 A c	SW01	IB-IIB-III2		pseudo-engobe (VO)	A5		
2	TCH98B23.49	98B23	bol 01 C b	SW02				A5		
3	TCH98B23.53	98B23	bol bas 03 A i	SW01				A5		
4	TCH98B23.51	98B23	bol bas 03 C i	SW01	IB-IIB-III25	4	pseudo-engobe (VO)	A5		
5	TCH98B23.85	98B23	bol bas 03 C i	SW01	IB1-IIB-III12	4		A5		
6	TCH98B23.58	98B23	bol 02 C c	SW01				A5		
7	TCH98B23.50	98B23	bol 02 C d	SW02			pseudo-engobe (VO)	A5		
8	TCH98B23.59	98B23	bol 01 A a	SW02				A5		
9	TCH98B23.52	98B23	bol 01 A b	SW01				A5		
10	TCH98B23.75	98B23	bol 02 B e	SW01				A5		
11	TCH98B23.71	98B23	bol 01 B c	SW01				A5		
12	TCH98B23.44	98B23	bol 01 C b	SW01	IB-IIB-III125	4		A5		
13	TCH98B23.48	98B23	bol 01 C b	SW02	IB-IIB-III12	4	pseudo-engobe	A5		
14	TCH98B23.76	98B23	bol 01 A e	SW01				A5		
15	TCH98B23.68	98B23	bol 02 A a	SW02			engobe	A5		
16	TCH98B23.60	98B23	bol 02 A a	SW01				A5		
17	TCH98B23.55	98B23	bol 02 B a	SW01	IB-IIB-III2		pseudo-engobe	A5		
18	TCH98B23.45	98B23	bol 02 B a	SW01	IB-IIB-III25	4		A5		
19	TCH98B23.61	98B23	bol 02 B d	SW01	IB-IIB-III25	4		A5		
20	TCH98B23.41	98B23	bol 02 C b	SW01				A5		

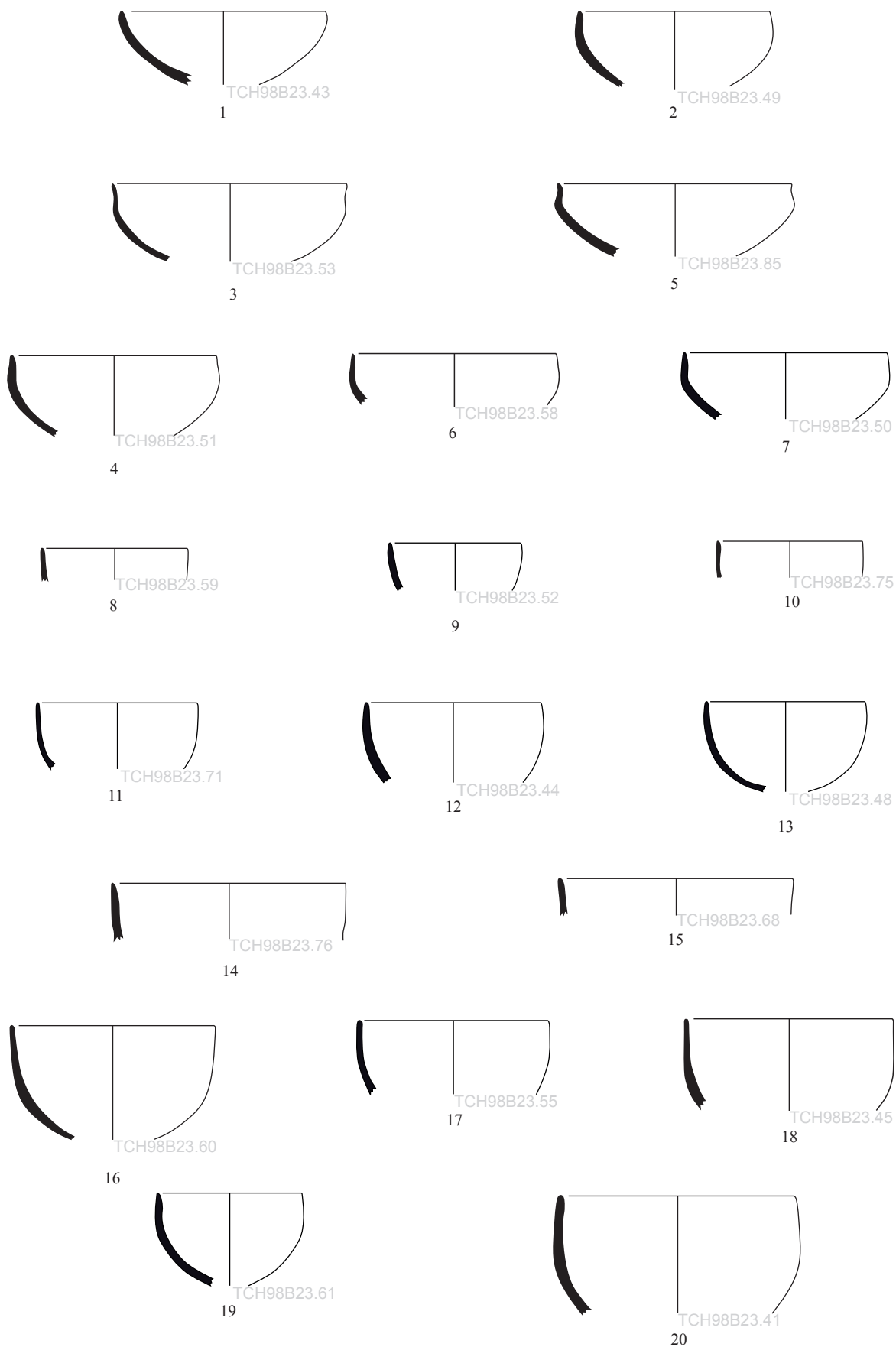

Céramiques communes



n°	IDpoterie	locus	forme	céra.	façonnage		décor	cui.	« marque »	
					MT	S			type	position
1	TCH98B23.40	98B23	bol 03 A i	SW01	IB-IIIB-III125	4	pseudo-engobe (VO)	(A5		
2	TCH98B23.57	98B23	bol 03 A i	SW01				A5		
3	TCH98B23.63	98B23	bol 03 A i	SW01a	IB-IIIB-III25	4		A3		
4	TCH98B23.74	98B23	bol 03 A i	SW02				A5		
5	TCH98B23.72	98B23	bol 03 A i	SW01				A5		
6	TCH98B23.46	98B23	bol 03 A i	SW01				A5		
n.i.	TCH98B23.64	98B23	bol 03 B i	SW01	IB-IIIB-III2		pseudo-engobe (VO)	A5		
7	TCH98B23.42	98B23	bol 03 B i	SW02				A5		
8	TCH98B23.54	98B23	bol 03 B j	SW02				A3		
9	TCH98B23.65	98B23	bol 03 B n	SW01				A5		
10	TCH98B23.73	98B23	bol 03 B n	SW01	IB-IIIB-III12	4	engobe	A5		
11	TCH98B23.62	98B23	bol 03 C i	SW01	IB1-IIIB-III12	4	engobe	A5		
12	TCH98B23.69	98B23	bol 03 C i	SW01				A5		
13	TCH98B23.56	98B23	bol 03 C n	SW01				A5		
14	TCH98B23.66	98B23	bol 05 A k	SW02				A4		
15	TCH98B23.77	98B23	bol 05 A k	SW02				A5		
16	TCH98B23.47	98B23	bol 05 B f	SW02				A5		
17	TCH98B23.24	98B23	pot 03 q	SW13	IB-III2		pseudo-engobe	A4		
18	TCH98B23.26	98B23	pot 03 p	SW13				A5		
19	TCH98B23.28	98B23	pot 03 u	SW01				A2		
20	TCH98B23.25	98B23	pot 03 v	SW01				A5		



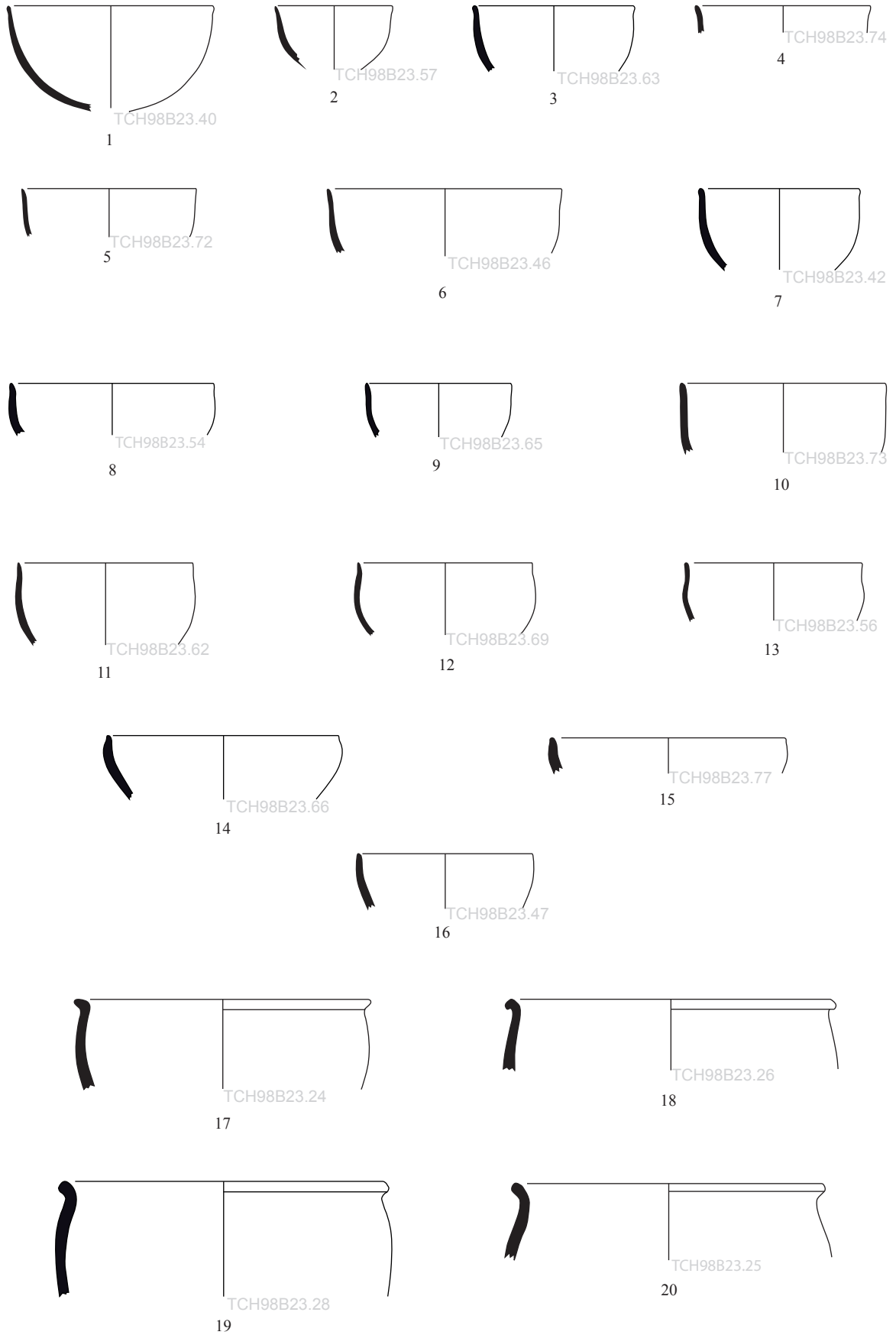

Céramiques communes (suite)



n°	IDpoterie	locus	forme	céra.	façonnage		décor	cui.	« marque »	
					MT	S			type	position
1	TCH98B23.30	98B23	pot 03 v	SW14				A5		
2	TCH98B23.22	98B23	pot 03 w	SW01			engobe	A2		
3	TCH98B23.23	98B23	pot 03 x	SW02				A5		
4	TCH98B23.21	98B23	pot 03 x	SW13				A4		
5	TCH98B23.29	98B23	petite jarre 03 A 03	SW01				A5		
6	TCH98B23.0	98B23	jarre OE 02 B 25	SW13	IB-II B-III2			A5		
7	TCH98B23.12	98B23	jarre OE 02 B 25	SW14				A5		
8	TCH98B23.10	98B23	jarre OE 03 B 25	SW14				A1		
9	TCH98B23.14	98B23	jarre OE 03 B 25	SW14				A5		
10	TCH98B23.34	98B23	jarre OE 03 D 01	SW14				A5		
11	TCH98B23.38	98B23	petite jarre 02 A 15	SW01			engobe	A5		
12	TCH98B23.17	98B23	petite jarre 02 A 15	SW01				A2		
13	TCH98B23.11	98B23	petite jarre 02 A 15	SW13				A5		
14	TCH98B23.8	98B23	petite jarre 02 B 16	SW01	IB-III2		peinture	A2		
15	TCH98B23.9	98B23	jarre OL 02 B 19	SW13				A5		
n.i.	TCH98B23.16	98B23	jarre	SW01				A5		
n.i.	TCH98B23.13	98B23	jarre	SW05				A5		
n.i.	TCH98B23.15	98B23	jarre	SW13			engobe	A5		
n.i.	TCH98B23.18	98B23	jarre	SW13				A5		
n.i.	TCH98B23.6	98B23	jarre	SW14				A5		

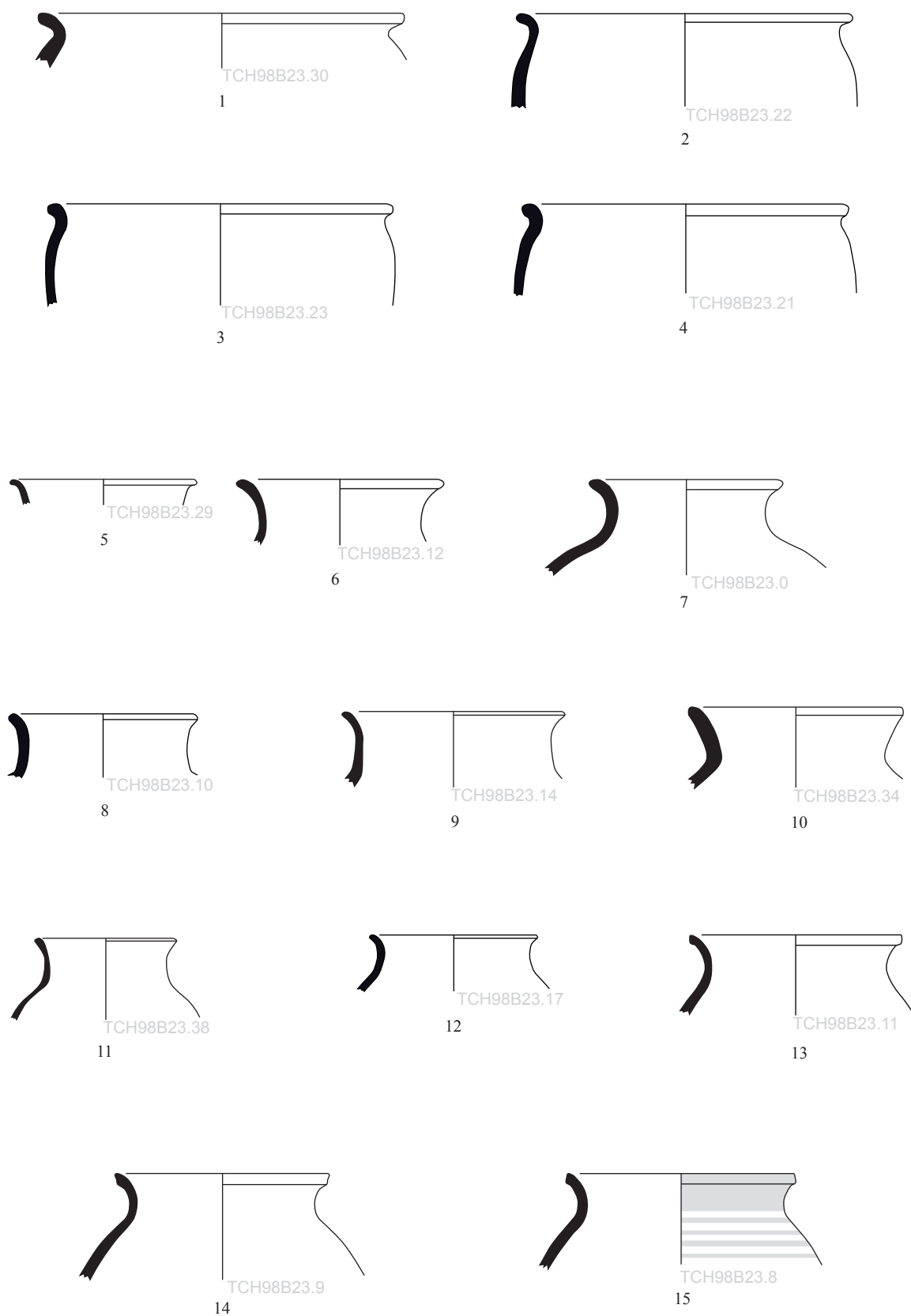

Céramiques communes (suite)



n°	IDpoterie	locus	forme	céra.	façonnage		décor	cui.	« marque »	
					MT	S			type	position
1	TCH98B158	98B23	racloir ?	SW01	IB-II B-III2			A5		
2	TCH98B23.19	98B23	support ? base 8	SW01	IB-II A-III12	2	engobe	A5		
3	TCH98B23.20	98B23	support 04	SW10				A5		
4	TCH98B23.78	98B23	base 1A	SW01	IB-II B-III12	4	engobe	A5		
5	TCH98B23.83	98B23	base 1A	SW02	IB-II B			A5		
6	TCH98B23.1	98B23	base 1A	SW02				A5		
7	TCH98B23.79	98B23	base 1B	nd – SW	IB-II B-III4	4	pseudo-engobe	A2		
8	TCH98B23.80	98B23	base 6	SW01	IB-II B-III2	4		A5		
9	TCH98B23.82	98B23	base 6	SW02	IB-II B		pseudo-engobe	A5		
10	TCH98B23.81	98B23	base 6	SW02	IB-II B-III2	4	pseudo-engobe	A5		
11	TCH98B23.2	98B23	grande jarre 03 B 48	GV				A2		
12	TCH98B23.4	98B23	grande jarre 03 B 49	GV				A5		
13	TCH98B23.3	98B23	jarre OL 02 D 21	GV				A2		
14	TCH98B23.5	98B23	grande jarre 01 51	GV				A2		



Céramiques communes (suite)

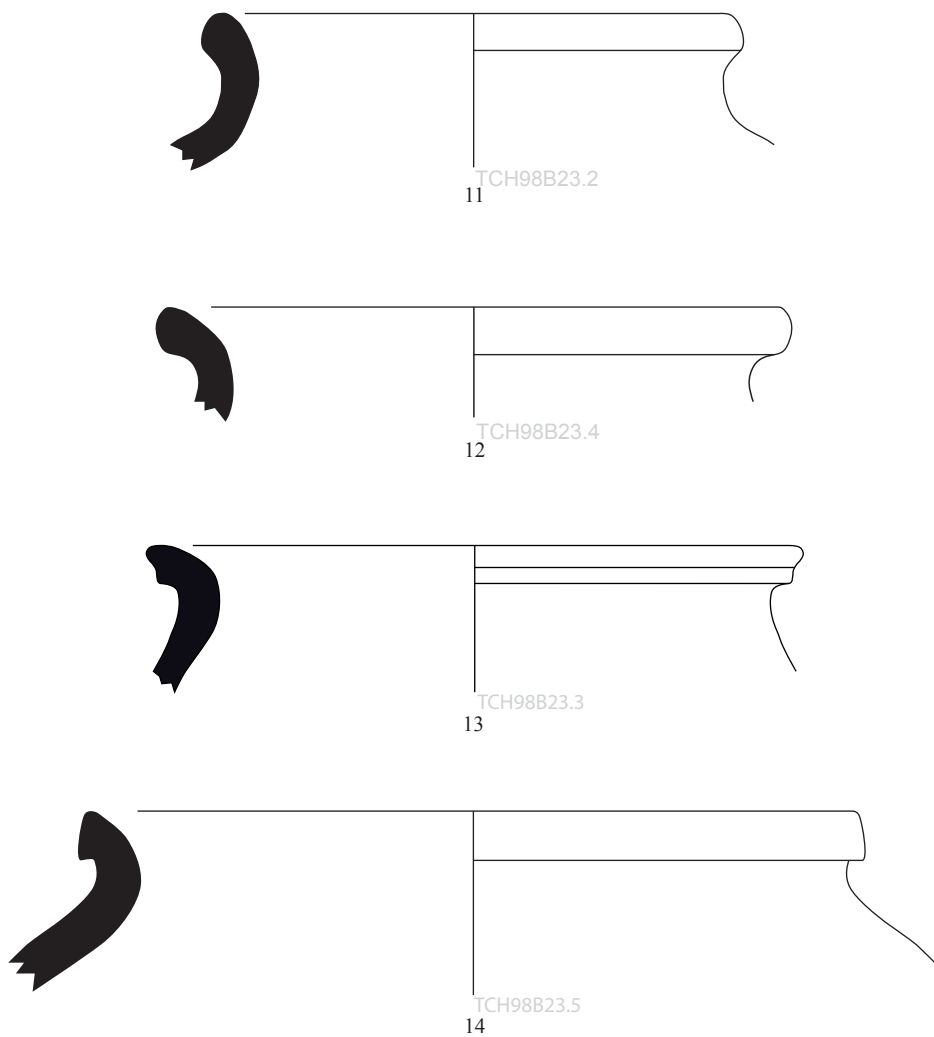

Céramiques à dégraissant végétal grossier (GV)



Catalogue 45

n°	IDpoterie	locus	forme	céra.	façonnage		décor	cui.	« marque »	
					MT	S			type	position
1	TCH98B23.33	98B23	marmite 02	GM2	III6	3		A5		
2	TCH98B23.70	98B23	bol bas 02 C m	MW 6	IIB-III4	5	coloration par tournassage ?	A1		
3	TCH98B23.67	98B23	bol 01 C n	MW 2	IB-IIB	0	bosselage	B		

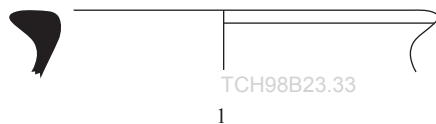

Céramiques à dégraissant minéral grossier (GM)

---

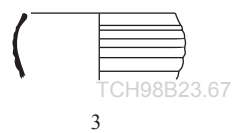
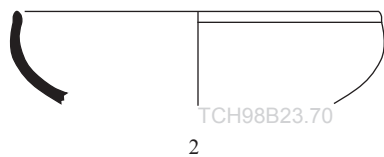

Céramiques métalliques



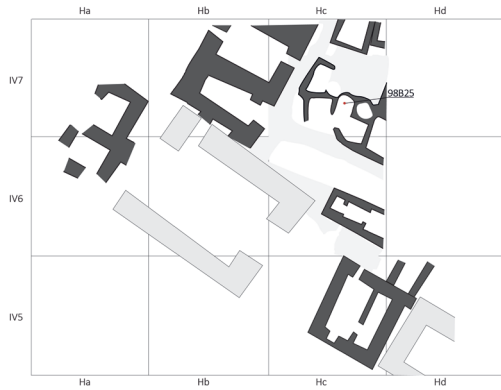

TCH98B25

Espace R11

\_\_\_\_\_ sw gm gv mw ew

NR /

NMI 1 1

DIA 1 1

n°	IDpoterie	locus	forme	céra.	façonnage		décor	cui.	« marque »	
					MT	S			type	position
4	TCH98B100	98B25	petite jarre 02 B 08	SW01	III12		peinture sur engobe	A5		



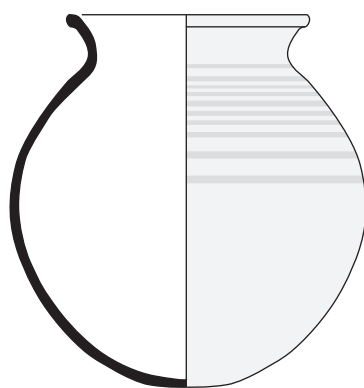

1

Céramiques communes





TCH98B26

Descente jusqu'au niveau de sol dans la rue, entre les pièces R8, R9, R7 et R5.

		sw	gm	gv	mw	ew
NR	<b>602</b>	542	2	58		
NMI	<b>50</b>	44	1	3	2	
DIA	<b>55</b>	47	1	3	4	

n°	IDpoterie	locus	forme	céra.	façonnage		décor	cui.	« marque »	
					MT	S			type	position
1	TCH98B26.35	98B26	bol bas 03 A i	SW01				A1		
n.i.	TCH98B26.19	98B26	bol bas 03 B i	SW01				A5		
2	TCH98B26.33	98B26	bol 01 A e	SW01				A5		
3	TCH98B26.50	98B26	bol 01 A d	SW01			pseudo-engobe (VO)	A5		
4	TCH98B26.32	98B26	bol 01 C a	SW02			pseudo-engobe (VO)	A5		
5	TCH98B26.44	98B26	bol 02 B a	SW02				A5		
6	TCH98B26.62	98B26	bol 03 A i	SW02				A5		
7	TCH98B26.47	98B26	bol 03 A i	SW01				A5		
8	TCH98B26.55	98B26	bol 03 A i	SW02				A5		
9	TCH98B26.13	98B26	bol 03 A i	SW02				A5		
10	TCH98B26.15	98B26	bol 03 B i	SW01				A5		
11	TCH98B26.46	98B26	bol 03 B i	SW01				A5		
12	TCH98B26.43	98B26	bol 03 B i	SW02				A5		
13	TCH98B26.38	98B26	bol 03 B i	SW02				A5		
14	TCH98B26.31	98B26	bol 03 B i	SW02				A5		
15	TCH98B26.18	98B26	bol 03 B n	SW01				A5		
16	TCH98B26.25	98B26	bol 03 C i	SW01				A5		
17	TCH98B26.80	98B26	bol 04 C q	SW01				A5		
18	TCH98B26.40	98B26	bol 05 B l	SW07				A5		

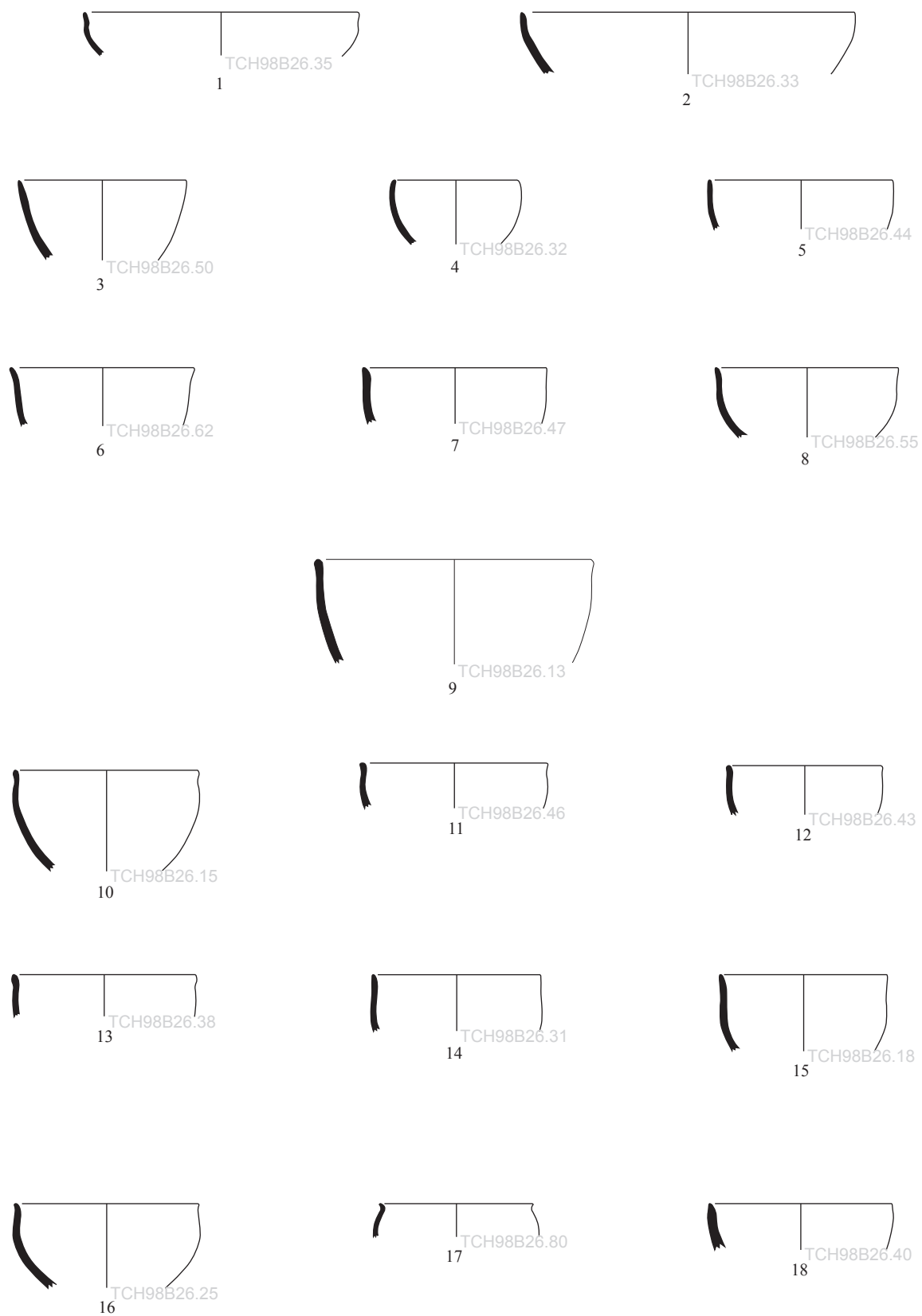

Céramiques communes



n°	IDpoterie	locus	forme	céra.	façonnage		décor	cui.	« marque »	
					MT	S			type	position
1	TCH98B26.24	98B26	pot 03 o	SW07				A1		
2	TCH98B26.58	98B26	pot 03 v	SW01				A5		
3	TCH98B26.23	98B26	pot 03 w	SW14				A5		
4	TCH98B26.54	98B26	pot 03 x	SW14				A5		
5	TCH98B26.68	98B26	pot 03 w	SW14				A5		
6	TCH98B26.22	98B26	pot 03 y	SW02				A5		
7	TCH98B26.21	98B26	support ?	SW07				A5		
n.i.	TCH98B26.17	98B26	base 1A	nd				A5		
8	TCH98B26.45	98B26	base 1A	SW02				A5		
9	TCH98B26.9	98B26	jarre OE 02 A 25	SW13				A5		
10	TCH98B26.6	98B26	jarre OE 02 A 25	SW14			engobe	A5		
11	TCH98B26.10	98B26	jarre OE 02 A 26	SW13				A2		
12	TCH98B26.12	98B26	jarre OE 02 A 26	SW14				A5		
13	TCH98B26.49	98B26	jarre OE 03 A 27	SW13				A5		
14	TCH98B26.27	98B26	jarre OE 03 B 23	SW14				A5		
15	TCH98B26.7	98B26	jarre OE 03 B 25	SW14			engobe	A5		
16	TCH98B26.53	98B26	support ?	SW13			engobe	A5		

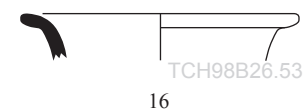
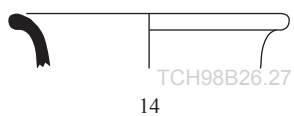
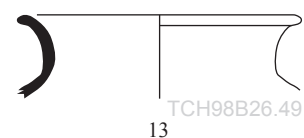
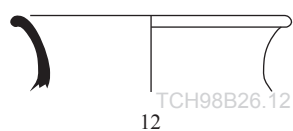
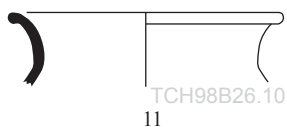
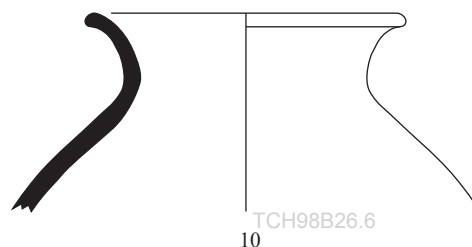
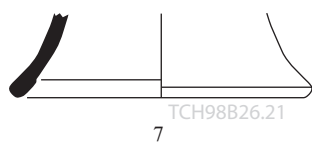
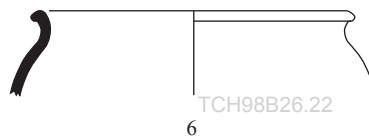
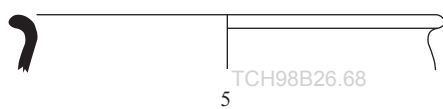
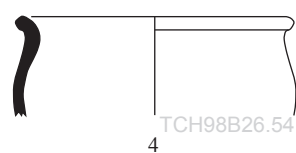
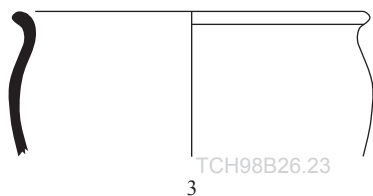
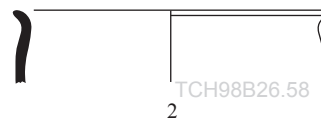
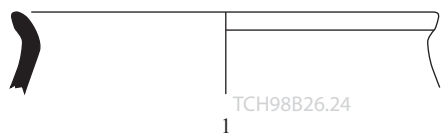

Céramiques communes (suite)



Catalogue 49

n°	IDpoterie	locus	forme	céra.	façonnage		décor	cui.	« marque »	
					MT	S			type	position
1	TCH98B26.28	98B26	jarre OL 02 B 37	SW05				A5		
2	TCH98B26.52	98B26	jarre OL 02 B 37	SW05				A5		
3	TCH98B26.56	98B26	jarre OL 02 B 37	SW05				A5		
4	TCH98B26.20	98B26	jarre OL 02 B 37	SW05			engobe	A1		
5	TCH98B26.11	98B26	jarre OL 02 B 37	SW14				A5		
6	TCH98B26.8	98B26	jarre OL 02 B 37	SW05				A2		
7	TCH98B26.59	98B26	support ?	SW05				A5		
8	TCH98B26.29	98B26	jarre OL 02 D 19	SW13				A5		
9	TCH98B26.30	98B26	jarre OL 03 B 44	SW05				A5		
10	TCH98B26.70	98B26	jarre OL 03 B 44	GV1				A5		
11	TCH98B26.3	98B26	jarre OL 03 B 44	SW26			engobe réservé	A5		
12	TCH98B26.2	98B26	jarre OL 03 B 44	SW26	IB-II B-III2		engobe réservé	A5		

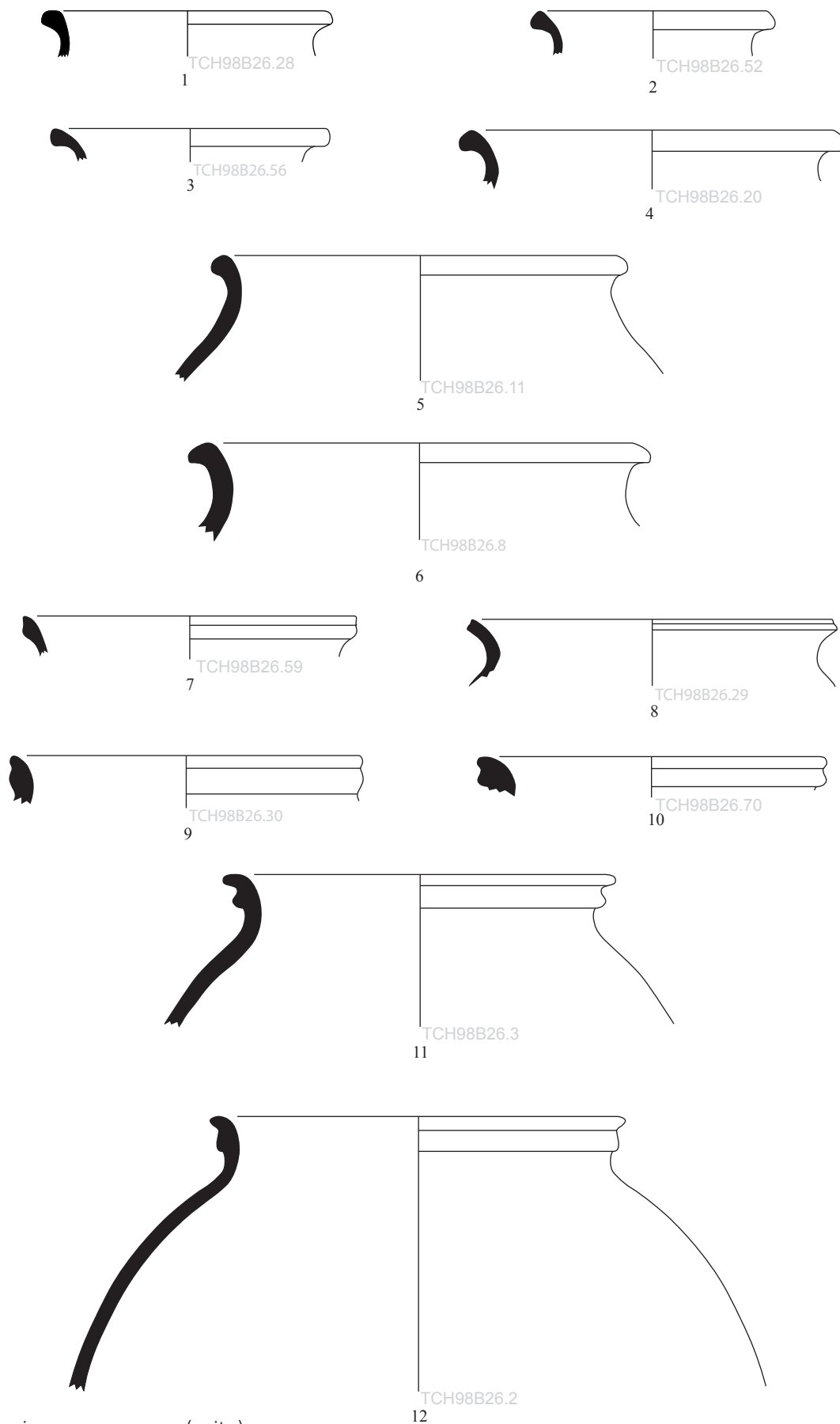

Céramiques communes (suite)



Catalogue 50

n°	IDpoterie	locus	forme	céra.	façonnage		décor	cui.	« marque »	
					MT	S			type	position
1	TCH98B26.5	98B26	grande jarre 03 D 47	GV				A5		
2	TCH98B26.4	98B26	grande jarre 02 53	GV				A2		
3	TCH98B26.57	98B26	marmite 02	GM	III6a	3		A5		
4	TCH98B26.34	98B26	bol 01 C n	MW 3			bosselage	B		
5	TCH98B26.65	98B26	petite jarre 03 E 05	MW 9			coloration par tournassage ?	A2		
6	TCH98B26.36	98B26	base 1A	MW ?	III4	5		A1		
7	TCH98B26.14	98B26	base 1A	MW ?				A1		



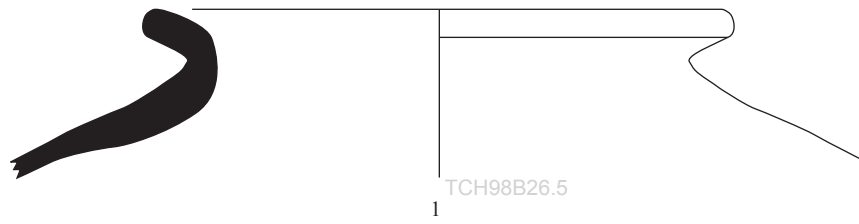

Céramiques à dégraissant végétal grossier (GV)

---

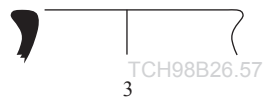

Céramiques à dégraissant minéral grossier (GM)

---

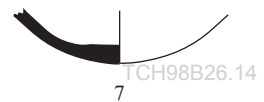
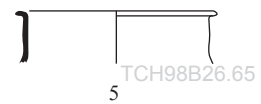
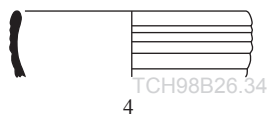

Céramiques métalliques





TCH98B33

Descente sous R96-3.

		sw	gm	gv	mw	ew
NR	<b>102</b>	82	5	15		
NMI	<b>25</b>	19	3	3		
DIA	<b>25</b>	19	3	3		

n°	IDpoterie	locus	forme	céra.	façonnage		décor	cui.	« marque »	
					MT	S			type	position
1	TCH98B33.18	98B33	bol bas 04 C q	SW02				A5		
n.i.	TCH98B97	98B33	bol 01 A b	SW01		5	pseudo-engobe (VO)	A4		
2	TCH98B33.21	98B33	bol 01 A b	SW01				A5		
3	TCH98B154	98B33	bol 01 A d	SW07			pseudo-engobe (VO)	A5		
5	TCH98B33.22	98B33	bol 01 A e	SW01				A5		
4	TCH98B75	98B33	bol 01 C b	SW02				A5		
6	TCH98B33.16	98B33	bol 02 A a	SW02	IB-IIB-III2		pseudo-engobe (VO)	A5		
7	TCH98B33.17	98B33	bol 03 C j	SW02				A2		
8	TCH98B33.19	98B33	bol 05 A g	SW02				A5		
9	TCH98B33.20	98B33	bol 05 A k	SW02				A5		
10	TCH98B33.15	98B33	bol 05 B g	SW01			pseudo-engobe (VO)	A5		
11	TCH98B33.14	98B33	pot 03 A z	SW04				A5		
12	TCH98B33.8	98B33	jarre OE 01 B 36	SW05				A2		
13	TCH98B33.11	98B33	jarre OE 01 B 36	SW05				A5		
14	TCH98B33.10	98B33	jarre OE 02 A 27	SW14				A5		
n.i.	TCH98B33.12	98B33	jarre OE 02 B 25	SW14				A5		
15	TCH98B33.9	98B33	jarre OL 03 B 38	SW05				A5		
16	TCH98B33.4	98B33	jarre OL 03 B 40	SW05				A5		

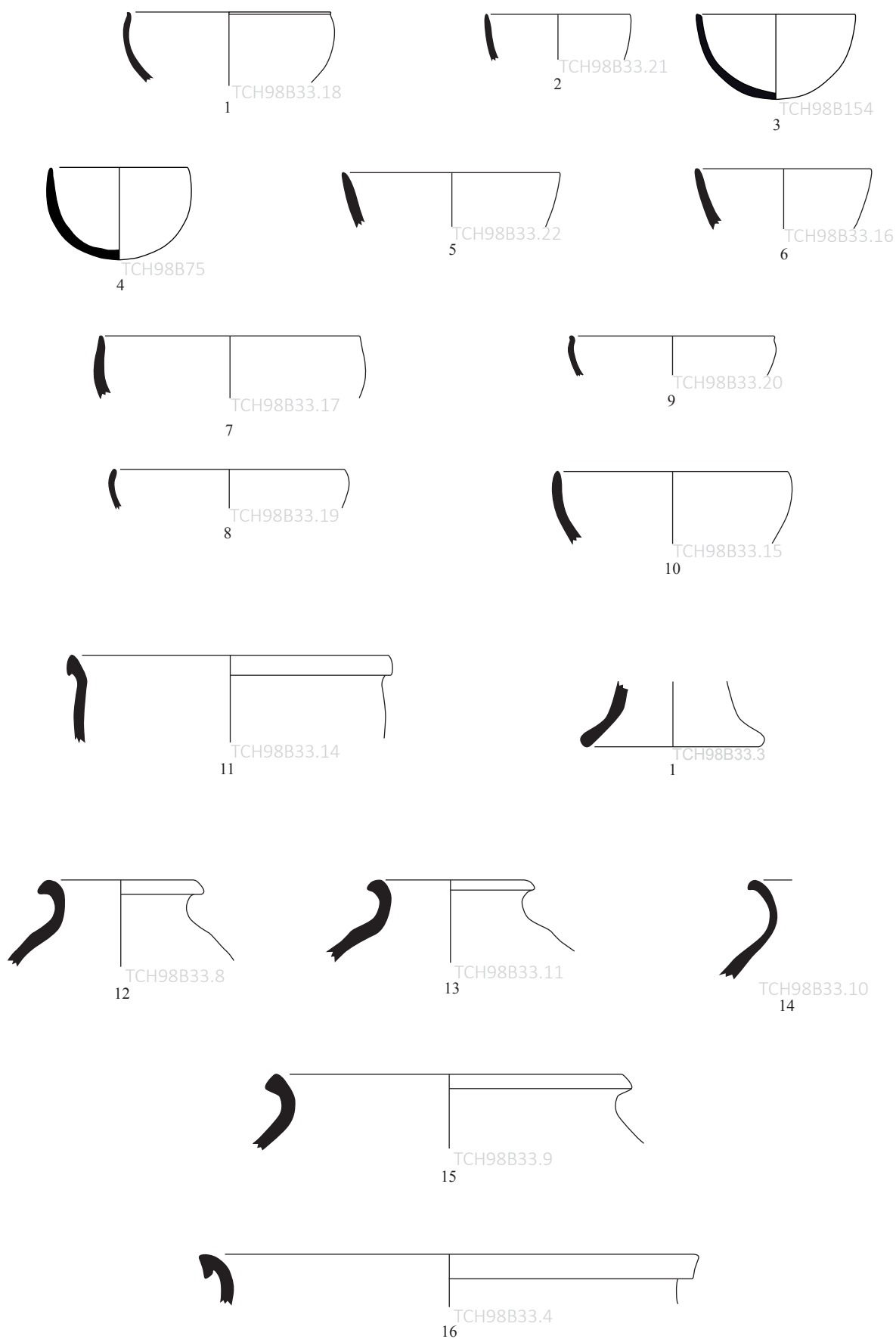

Céramiques communes



Catalogue 52

n°	IDpoterie	locus	forme	céra.	façonnage		décor	cui.	« marque »	
					MT	S			type	position
1	TCH98B33.3	98B33	support 05	SW01 b				A5		
2	TCH98B33.2	98B33	grande jarre 01 52	GV				A5		
3	TCH98B33.5	98B33	grande jarre 02 53	GV				A5		
4	TCH98B33.1	98B33	grande jarre 02 54	GV				A2		
5	TCH98B33.13	98B33	marmite 02 A	GM	III6	3		B		
6	TCH98B33.7	98B33	marmite 02 A	GM	III6	3		A5		
7	TCH98B33.6	98B33	marmite 02 A	GM	III6a	3		A5		

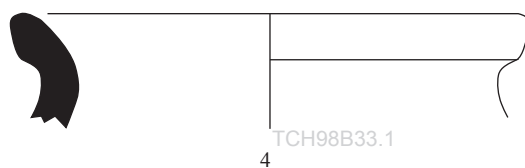
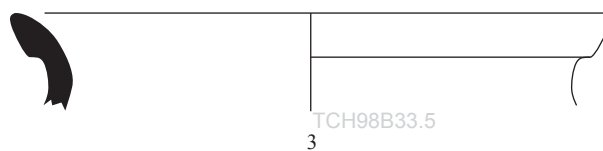
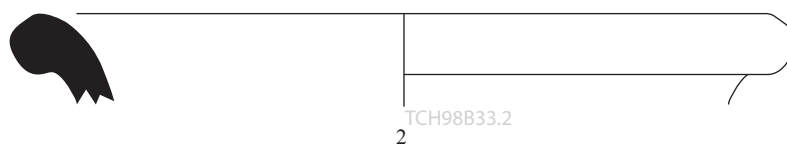

Céramiques à dégraissant végétal grossier (GV)

---

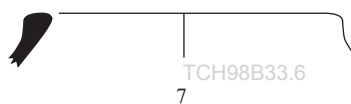

Céramiques à dégraissant minéral grossier (GM)





TCH98B40

Démontage de la pièce R96-1

		sw	gm	gv	mw	ew
NR	<b>617</b>	536	63	16	2	
NMI	<b>53</b>	44	1	4	4	
DIA	<b>54</b>	44	1	5	4	

n°	IDpoterie	locus	forme	céra.	façonnage		décor	cui.	« marque »	
					MT	S			type	position
1	TCH98B40.103	98B40	bol bas 04 C q	SW02				A5		
2	TCH98B40.86	98B40	bol 01 A e	SW01				A5		
3	TCH98B135	98B40	bol 01 A e	SW01			pseudo-engobe (VO)	A3		
4	TCH98B40.80	98B40	bol 01 B a	SW01				A3		
5	TCH98B166	98B40	bol 01 B a	SW07			pseudo-engobe (VO)	A2		
6	TCH98B125	98B40	bol 01 B b	SW01			pseudo-engobe (VO)	A5		
n.i.	TCH98B40.4	98B40	bol 01 C	SW02				A5		
n.i.	TCH98B40.3	98B40	bol 01 C	SW07				A5		
7	TCH98B40.79	98B40	bol 01 C a	SW02				A5		
8	TCH98B40.83	98B40	bol 01 C a	SW07				A5		
9	TCH98B40.82	98B40	bol 01 C b	SW01				A3		
10	TCH98B40.94	98B40	bol 01 C b	SW07				A5		
11	TCH98B40.30	98B40	bol 01 C b	SW07				A5		
12	TCH98B40.84	98B40	bol 01 C c	SW01				A5		
13	TCH98B130	98B40	bol 01 C c	SW01			pseudo-engobe (VO)	A5		
14	TCH98B136	98B40	bol 02 A b	SW01				A5		
15	TCH98B165	98B40	bol 03 C i	SW07				A5		
16	TCH98B40.87	98B40	bol 05 B l	SW02				A5		
17	TCH98B40.85	98B40	bol 05 B l	SW02a				A1		
18	TCH98B40.50	98B40	pot 03 m	SW12				A5		
19	TCH98B40.76	98B40	pot 03 A w	SW14				A5		

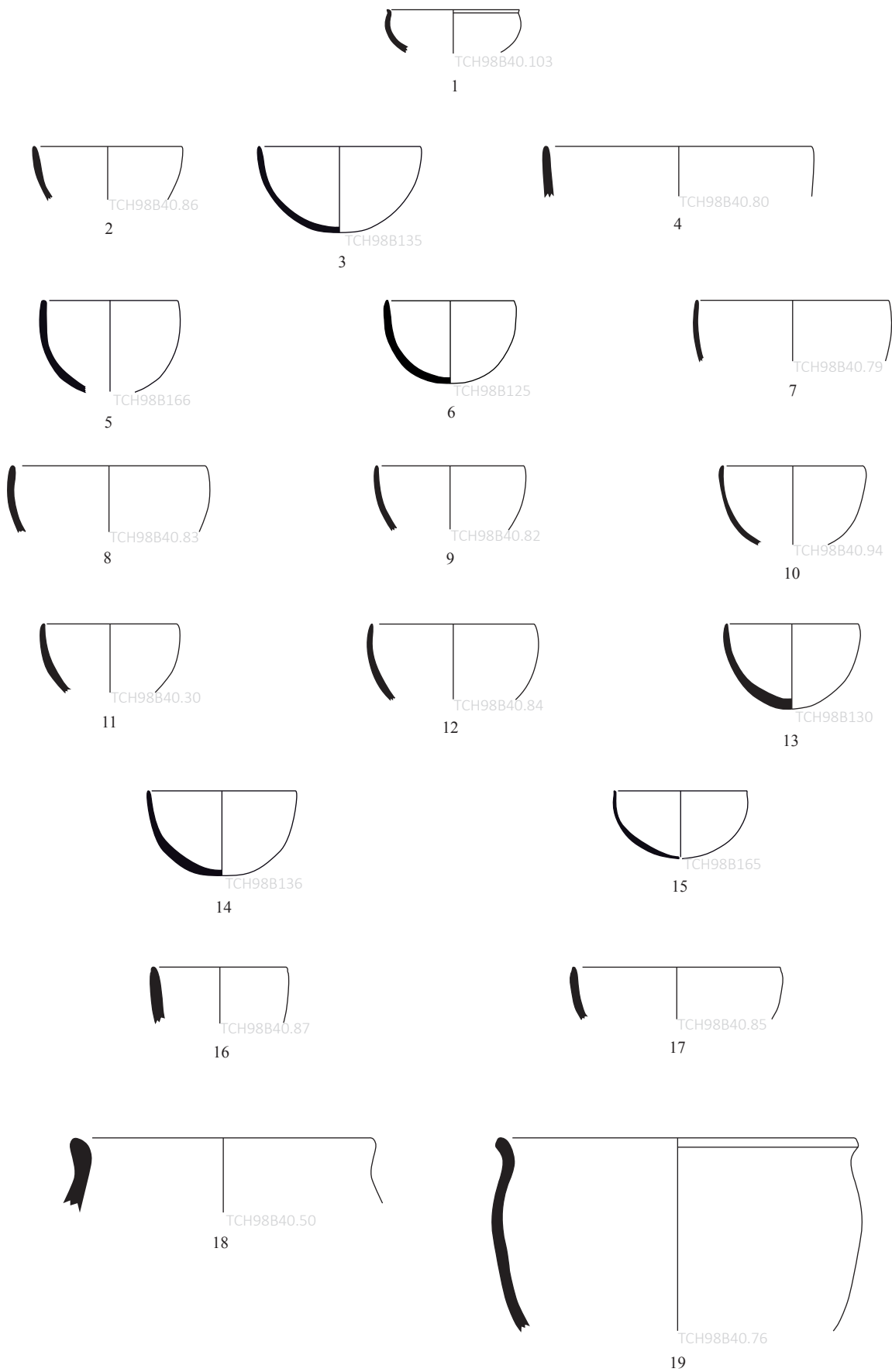

Céramiques communes



n°	IDpoterie	locus	forme	céra.	façonnage		décor	cui.	« marque »	
					MT	S			type	position
1	TCH98B40.97	98B40	vase à tubulaire goulot	SW07			engobe	A5		
2	TCH98B116	98B40	vase miniature 07 B	nd				A2		
3	TCH98B117	98B40	vase à tubulaire 1 B	SW07				A5		
4	TCH98B127	98B40	vase à tubulaire 1 A	SW13		4		A2		
5	TCH98B40.71	98B40	petite jarre 03 A 01	SW01c				A5		
6	TCH98B40.70	98B40	petite jarre 03 A 03	nd				A5		
7	TCH98B129	98B40	petite jarre 03 A 03	SW01	IB-IIAB-12		pseudo-engobe, peinture ?	A3		
8	TCH98B40.74	98B40	petite jarre 02 D 14	SW07		2		A2		
9	TCH98B40.75	98B40	jarre OE 01 A 09	SW10			pseudo-engobe	A2		
10	TCH98B40.93	98B40	petite jarre 02 B 06	SW07			engobe	A4		
11	TCH98B40.59+61	98B40	jarre OE 02 B 25	SW14				A5		
12	TCH98B40.58	98B40	jarre OE 02 A 26	SW13			pseudo-engobe	A5		
13	TCH98B40.52	98B40	jarre OE 03 A 25	SW14				A1		



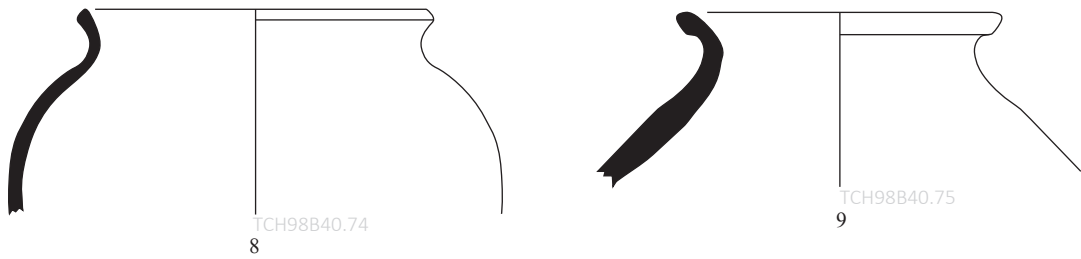
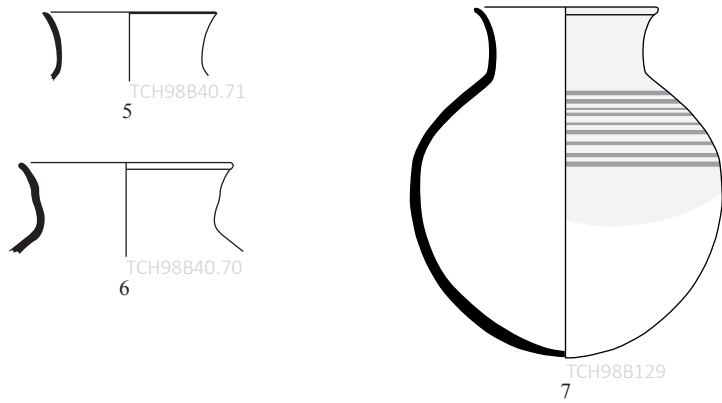
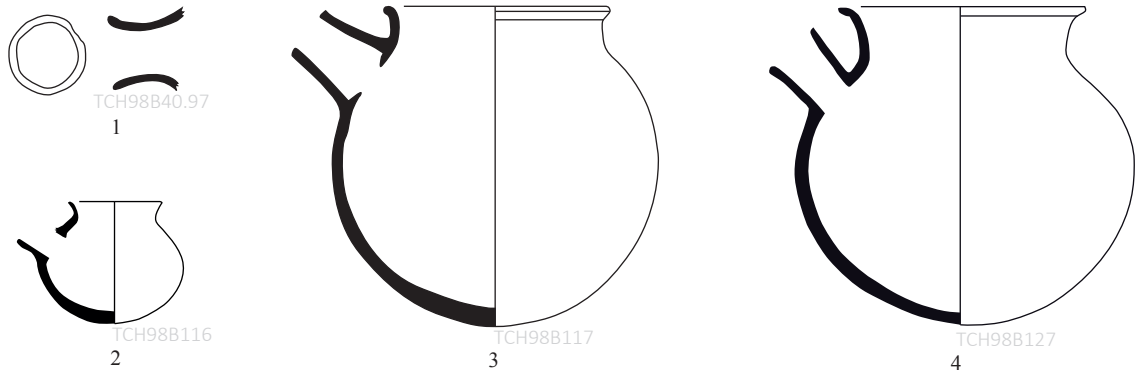

Céramiques communes (suite)



n°	IDpoterie	locus	forme	céra.	façonnage		décor	cui.	« marque »	
					MT	S			type	position
1	TCH98B40.60	98B40	jarre OL 01 B 54	nd – surcuit				A5		
2	TCH98B40.107	98B40	jarre OL 02 B 16	SW26				A5		
3	TCH98B40.53	98B40	jarre OL 02 B 19	SW13				A5		
4	TCH98B131	98B40	jarre OL 02 D 17	SW13				A1		
5	TCH98B40.62	98B40	jarre OL 02 D 19	nd – surcuit				A5		
6	TCH98B40.73	98B40	jarre OL 02 D 17	SW13			engobe	A5		
7	TCH98B40.17	98B40	jarre OL 02 B 23	SW04			pseudo-engobe	A2		
8	TCH98B40.1	98B40	jarre OL 03 B 44	SW26				A5		
9	TCH98B40.117	98B40	support 01	SW14				A5		

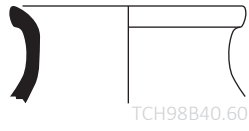

1



2

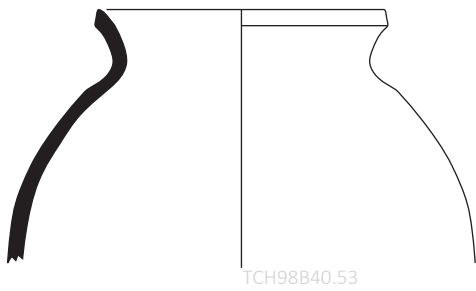

3

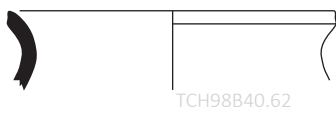

4

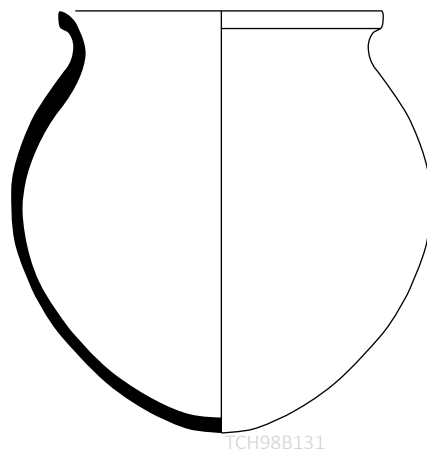

5

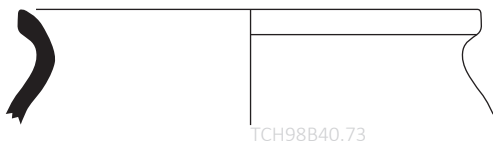

6

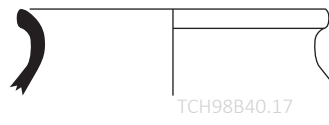

7

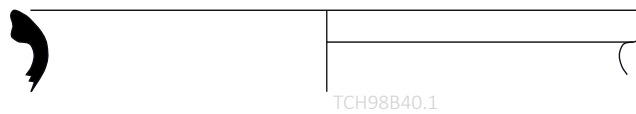

8

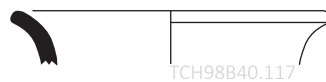

9

céramiques communes (suite)



n°	IDpoterie	locus	forme	céra.	façonnage		décor	cui.	« marque »	
					MT	S			type	position
1	TCH98B40.54	98B40	jarre OL 02 D 17	GV			engobe	A5		
2	TCH98B40.51	98B40	grande jarre 02 53	GV				A2		
3	TCH98B40.46	98B40	grande jarre 02 53	GV				A5		
4	TCH98B40.44	98B40	grande jarre 02 53	GV				A5		
5	TCH98B119b	98B40	grande jarre 03 B 52	nd				A3	incisée	panse sup
6	TCH98B40.2	98B40	panse	GV				A2	incisée	nd (panse)

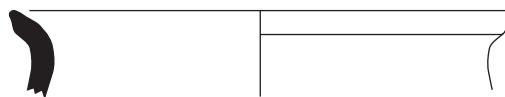

TCH98B40.54

1

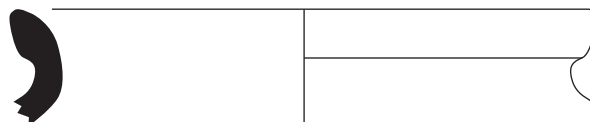

TCH98B40.51

2

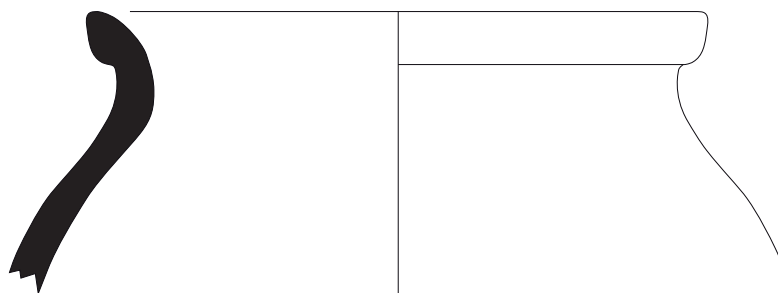

TCH98B40.46

3

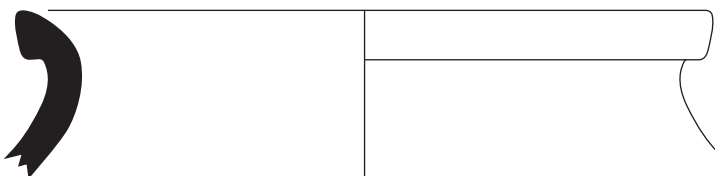

TCH98B40.44

4

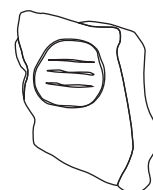

TCH98B40.2

6

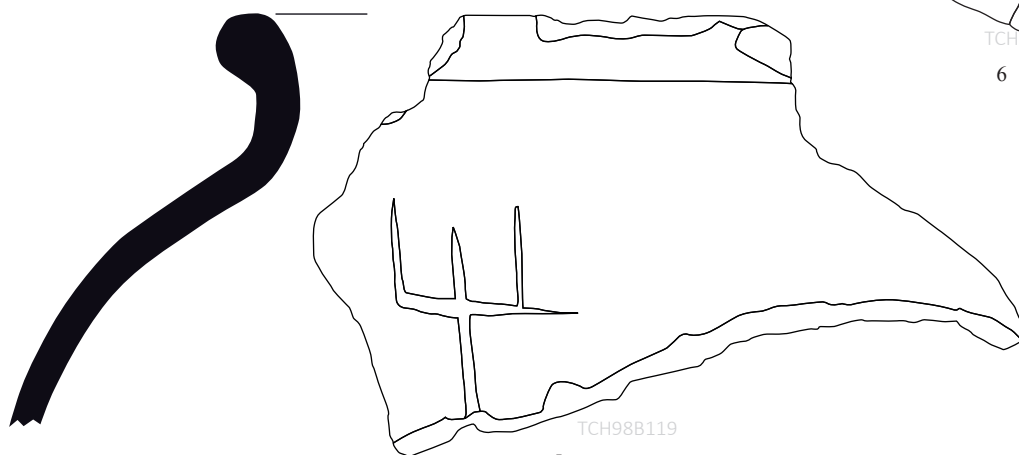

TCH98B119

5

céramiques à dégraissant végétal grossier (GV)



Catalogue 57

n°	IDpoterie	locus	forme	céra.	façonnage		décor	cui.	« marque »	
					MT	S			type	position
1	TCH98B40.47	98B40	marmite 03	GM	III6a	3		A5		
2	TCH98B40.90	98B40	bol bas 02 C m	MW 5			coloration par tournassage ? peinture ?	A2		
3	TCH98B164	98B40	vase miniature 02	MW 5			coloration par tournassage	B		
4	TCH98B40.89	98B40	bol 01 C n	MW 7			bosselage, coloration par tournassage	A1		
5	TCH98B40.63	98B40	petite jarre 03 E 05	MW 9			coloration par tournassage	A2		



Céramiques à dégraissant minéral grossier (GM)

---

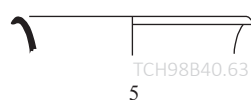
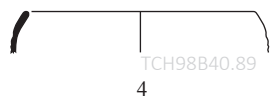
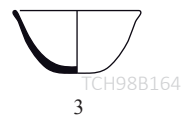
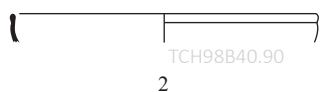

Céramiques métalliques



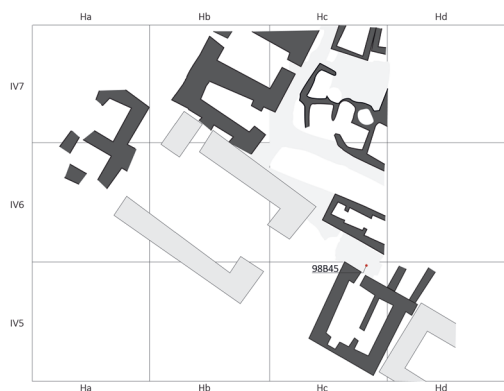

TCH98B45

Démontage de la pièce R96-3

\_\_\_\_\_ sw gm gv mw ew

NR /

NMI 1 1

DIA 1 1

n°	IDpoterie	locus	forme	céra.	façonnage		décor	cui.	« marque »	
					MT	S			type	position
6	TCH98B114	98B45	bol 01 B b	SW01	IB1-II B-III4	5	pseudo-engobe (VO)	nd		



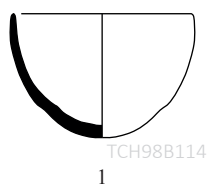

Céramiques communes



Catalogue 59



TCH99B26

Espace R8

		sw	gm	gv	mw	ew
NR	<b>5</b>	5				
NMI	<b>1</b>	1				
DIA	<b>2</b>	2				

n°	IDpoterie	locus	forme	céra.	façonnage		décor	cui.	« marque »	
					MT	S			type	position
7	TCH99B26.1	99B26	petite jarre 03 A 06	SW13	III2		peinture	A5		
8	TCH99B26.2	99B26	panse	SW13	IB-IIB-III2		engobe réservé ?	A5		

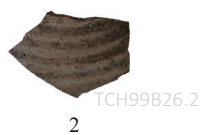
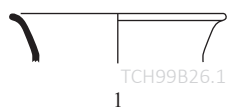

Céramiques communes



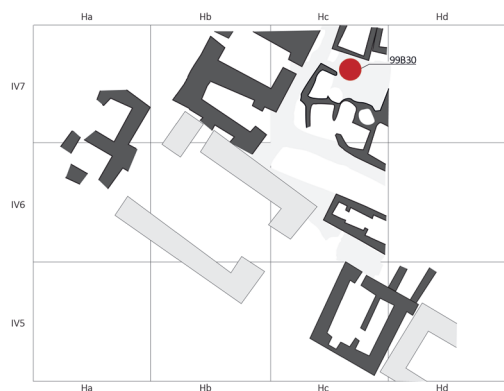

TCH99B30

Revêtement de sol en tessons

		sw	gm	gv	mw	ew
NR	<b>321</b>	121	30	169		1
NMI	<b>82</b>	69	4	5	3	(1)
DIA	<b>85</b>	71	4	5	5	

n°	IDpoterie	locus	forme	céra.	façonnage		décor	cui.	« marque »	
					MT	S			type	position
1	TCH99B30.48	99B30	bol bas 01 q	SW13		2		A2		
n.i.	TCH99B64	99B30	bol bas 02 B e	SW01	IB-III2b		pseudo-engobe (VO)	A5		
2	TCH99B30.53	99B30	bol bas 02 C e	SW01a	IB-IIB-III2b		pseudo-engobe (VO)	A5		
3	TCH99B30.13	99B30	bol bas 04 C q	SW01	IB-IIB-III2			A2		
n.i.	TCH99B30.17	99B30	bol 01 B	nd				A2		
4	TCH99B30.3	99B30	bol 01 B b	SW01	IB-IIB			A5		
5	TCH99B55	99B30	bol 01 B b	SW07	IB-III12		pseudo-engobe (VO)	A5		
6	TCH99B30.54	99B30	bol 01 B b	SW07	III2		pseudo-engobe (VO)	A5		
7	TCH99B30.22	99B30	bol 01 C a	SW02	IB-IIB-III12	4		A5		
8	TCH99B30.9	99B30	bol 01 C b	SW01b	IB-IIB-III2b		pseudo-engobe	A2		
9	TCH99B30.6	99B30	bol 01 C b	SW02	IB-IIB-III2b			A5		
10	TCH99B30.2	99B30	bol 01 C c	SW01			pseudo-engobe (VO)	A5		
11	TCH99B30.16	99B30	bol 02 B a	SW02	III2b			A5		
12	TCH99B30.57	99B30	bol 02 B a	SW07	III2b		pseudo-engobe (VO)	A5		
13	TCH99B30.7	99B30	bol 02 B b	SW02	IB-IIB-III2b			A5		
14	TCH99B30.12	99B30	bol 02 C a	SW02	IB-IIB-III2			A5		
15	TCH99B30.52	99B30	bol 02 C d	SW01	IB-IIB-III2		pseudo-engobe (VO)	A5		
16	TCH99B30.4	99B30	bol 02 C b	SW07	IB-IIB			A3		
17	TCH99B30.50	99B30	bol 02 C d	SW01	III2			A5		
18	TCH99B30.23	99B30	bol 02 C d	SW07	III2b		pseudo-engobe (VO)	A5		
19	TCH99B30.51	99B30	bol 03 B i	SW02	III2b		pseudo-engobe (VO)	A5		
20	TCH99B30.8	99B30	bol 03 A i	SW02	IB-IIB-III2			A5		
21	TCH99B30.10	99B30	bol 03 B n	SW02	IB-IIB-III2b			A5		
22	TCH99B30.5	99B30	bol 03 C i	SW01	IB-IIB-III12	4		A3		
23	TCH99B30.14	99B30	bol 05 B g	SW01	IB-IIB-III12	4	engobe	A5		
24	TCH99B30.18	99B30	bol 05 B g	SW01	IB-IIB-III2			A5		
n.i.	TCH99B30.49	99B30	bol 05 B g	SW07	IB-IIB-III2		pseudo-engobe (VO)	A4		
25	TCH99B30.1	99B30	bol 05 B j	SW01	IB-IIB-III2b		pseudo-engobe (VO)	A5		
26	TCH99B30.15	99B30	bol 05 B l	SW01	IB-IIB-III2			A5		
27	TCH99B30.66	99B30	jatte 01 t	SW10	IB-IIA-III1	2	rabotage post-cuisson	A1		

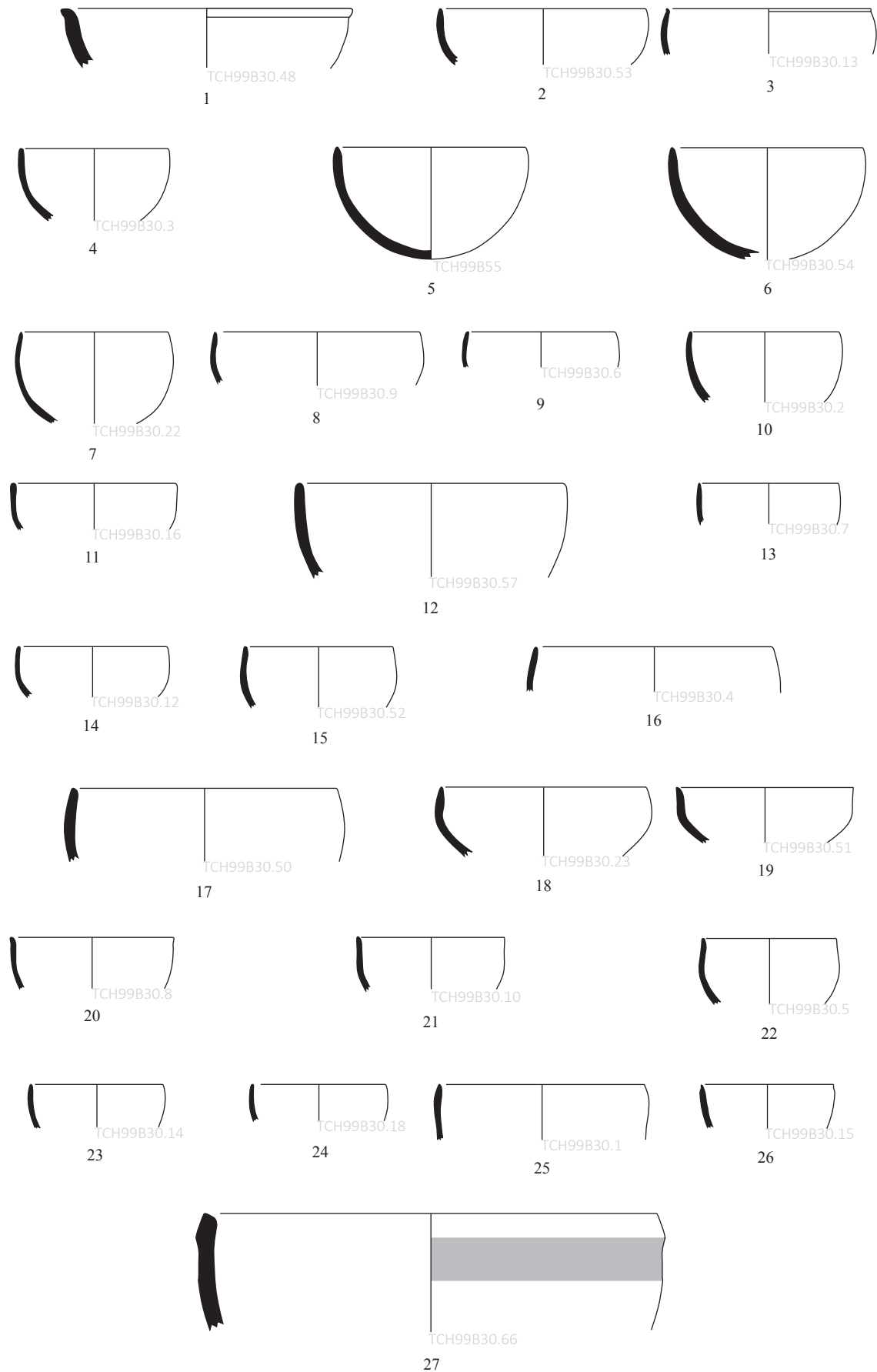

Céramiques communes



Catalogue 61

n°	IDpoterie	locus	forme	céra.	façonnage		décor	cui.	« marque »	
					MT	S			type	position
1	TCH99B30.41	99B30	pot 03 o	SW14	IB-IIB-III2		pseudo-engobe	A5		
2	TCH99B30.68	99B30	pot 03 v	SW10	IB-IIA-III12	2	engobe	A2		
3	TCH99B30.59	99B30	pot 03 x	SW02	III2			A5		
4	TCH99B30.25	99B30	petite jarre 03 A 01	SW01b	IB-III2			A3		
5	TCH99B30.26	99B30	petite jarre 03 A 06	SW13				A5		
6	TCH99B30.27	99B30	petite jarre 03 A 03	SW13			peinture	A5		
7	TCH99B30.24	99B30	petite jarre 03 D 02	SW01	III2			A5		
8	TCH99B30.43	99B30	petite jarre 03 A 03	SW01	III2			A5		
9	TCH99B30.82	99B30	couvercle ?	SW01				A5		
10	TCH99B30.42	99B30	petite jarre 02 D 01	nd – SW	III2			A2		
11	TCH99B30.70	99B30	petite jarre 02 A 15	SW13			peinture sur engobe	A5		
12	TCH99B30.29	99B30	petite jarre 02 B 11	SW13			peinture	A5		
13	TCH99B30.67	99B30	petite jarre 02 D 12	SW10	IB-III1			A2		
14	TCH99B30.28	99B30	panse	SW13			engobe réservé	A5		
15	TCH99B30.80	99B30	panse	SW07			engobe, incision	A5		
16	TCH99B30.60	99B30	anse	SW04	IA-IIA	2	pseudo-engobe	A5		
n.i.	TCH99B30.55	99B30	base 1A	SW07				A5		
17	TCH99B30.84	99B30	base 3B	SW13	IB-IIB-III4	5	pseudo-engobe	A5		
18	TCH99B30.56	99B30	vase miniature 03 B	SW07	IB-IIA-III12	2	engobe	A5		
19	TCH99B30.58	99B30	vase miniature 03 C x	SW02	IB-IIB-III2	4	engobe	A3		
20	TCH99B30.36	99B30	Support ?	SW01b	IB-IIB-III2b		engobe	A2		
21	TCH99B30.76	99B30	Support ?	SW26	IB			A5		

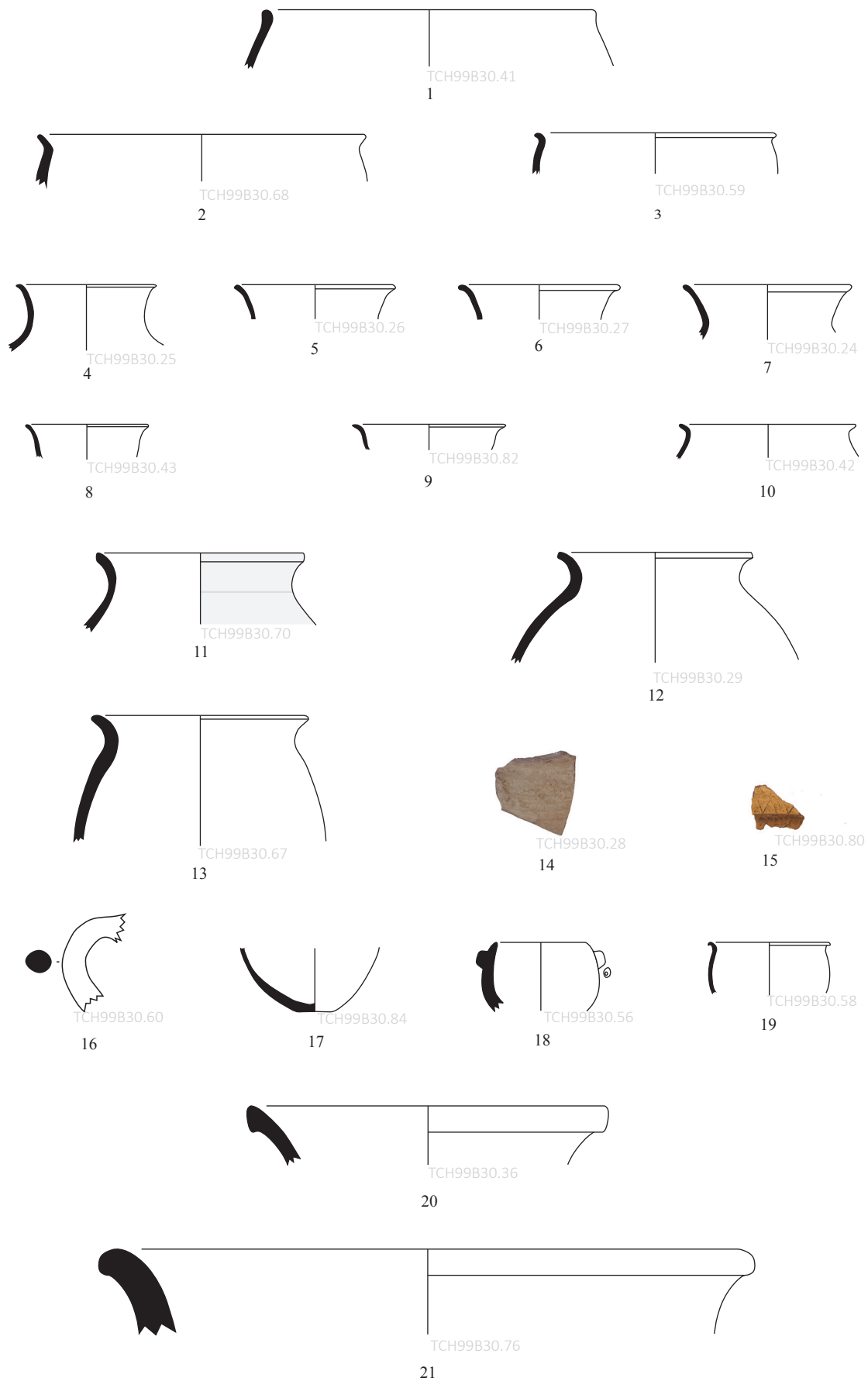

Céramiques communes (suite)



n°	IDpoterie	locus	forme	céra.	façonnage		décor	cui.	« marque »	
					MT	S			type	position
n.i.	TCH99B30.73	99B30	jarre nd	SW12	III6	3		A5		
1	TCH99B30.39	99B30	jarre OE 02 A 25	SW13	IB-III2			A5		
2	TCH99B30.38	99B30	jarre OE 02 B 25	SW07	IB-III2b		engobe	A4		
3	TCH99B30.69	99B30	jarre OE 02 B 25	SW13	III2		engobe	A5		
4	TCH99B30.30	99B30	jarre OE 02 B 25	SW14	IB-III2		engobe	A5		
5	TCH99B30.40	99B30	jarre OE 02 A 25	SW13	IB-III2			A5		
6	TCH99B30.63	99B30	jarre OE 02 B 25	SW14	IB-III2			A5		
7	TCH99B30.62	99B30	jarre OE 02 B 25	SW14	IB-III2			A5		
8	TCH99B30.61	99B30	jarre OE 03 B 23	SW13	IB-III2		engobe	A5		
9	TCH99B30.64	99B30	jarre OE 03 B 23	SW13	IB-III2			A5		
10	TCH99B30.35	99B30	jarre OE 03 B 23	SW14	IB-III2			A5		
11	TCH99B30.45	99B30	jarre OL 02 D 17	SW12	IB-III2			A5		
12	TCH99B30.65	99B30	jarre OL 02 D 17	SW07	IB-IIA-III1	2		A5		
13	TCH99B30.37	99B30	jarre OL 02 D 21	SW13	IB-III2			A2		
14	TCH99B30.34	99B30	jarre OL 03 B 38	SW05	IB-III2			A5		
15	TCH99B30.32	99B30	jarre OL 03 B 39	SW05	IB-IIIB			A5		
16	TCH99B30.33	99B30	jarre OL 03 B 39	SW26	IB-III25		engobe	A2		



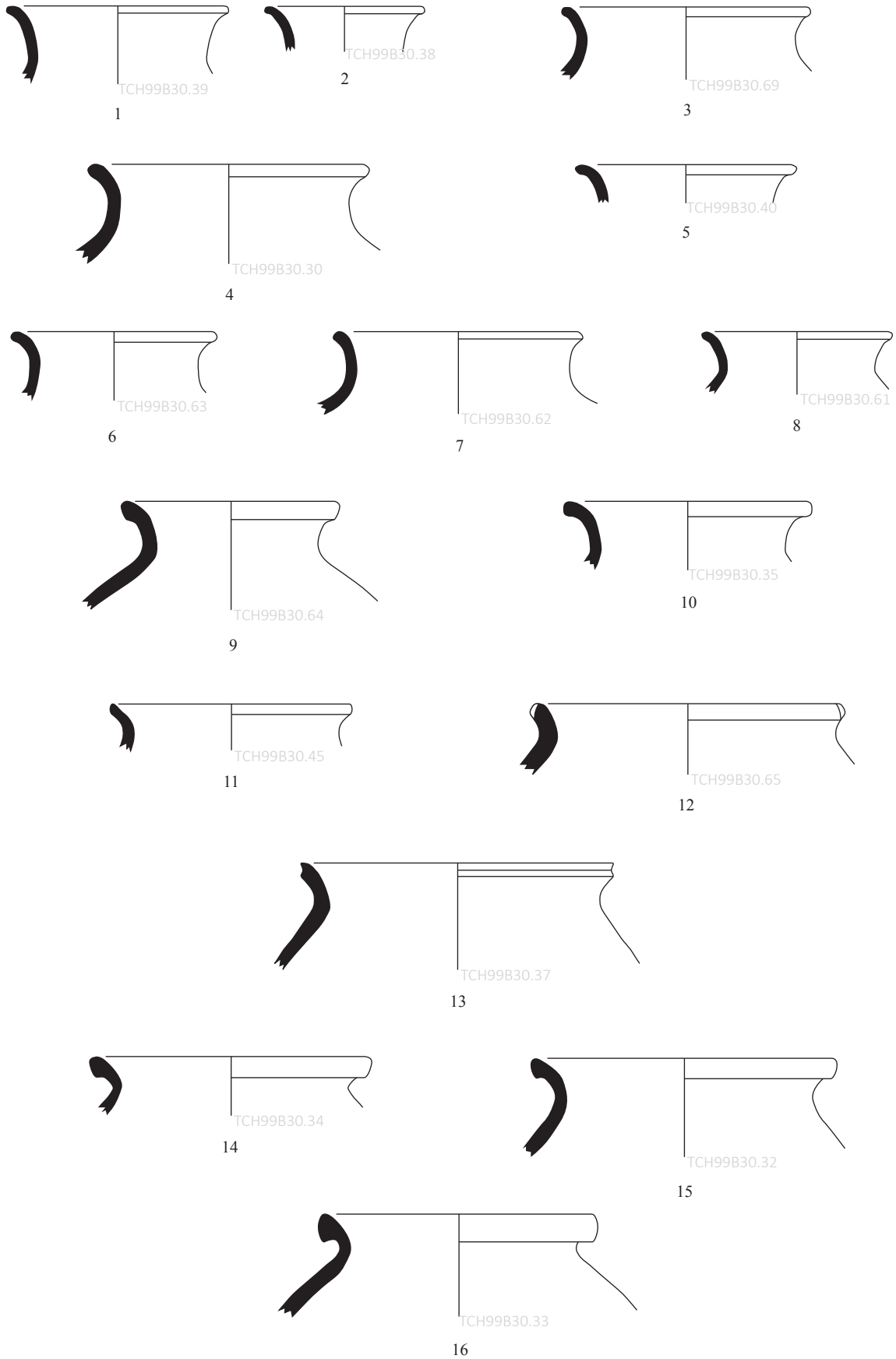

Céramiques communes (suite)



Catalogue 63

n°	IDpoterie	locus	forme	céra.	façonnage		décor	cui.	« marque »	
					MT	S			type	position
1	TCH99B30.31	99B30	jarre OL 03 B 44	SW26	IB-IIIB-III2			A1		
2	TCH99B30.77	99B30	jarre OL 03 B 44	SW13	IB-IIIB-III2		engobe réservé	A4		
3	TCH99B30.74	99B30	jarre OL 02 B 16	GV			engobe	A5		
4	TCH99B30.47	99B30	grande jarre 01 51	GV	IB-III2b			A2		
5	TCH99B30.79	99B30	grande jarre 01 51	GV				A2		

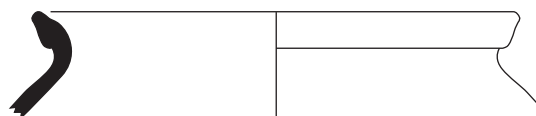

TCH99B30.31

1

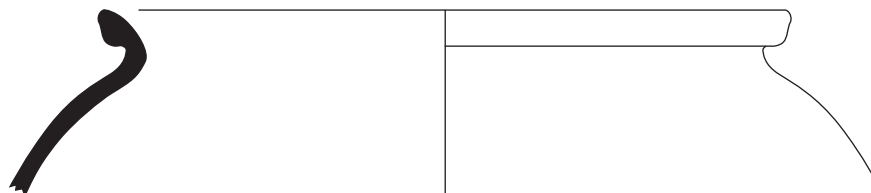

TCH99B30.77

2

Céramiques communes (suite)

---

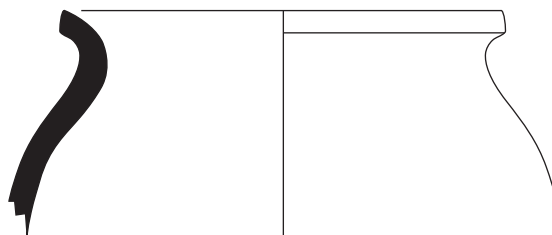

TCH99B30.74

3

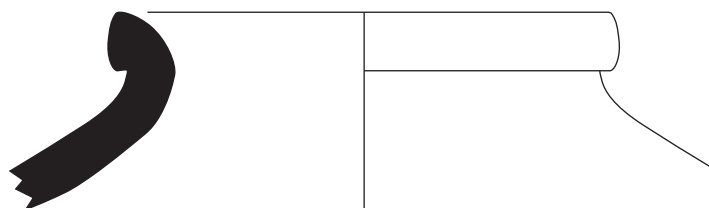

TCH99B30.47

4

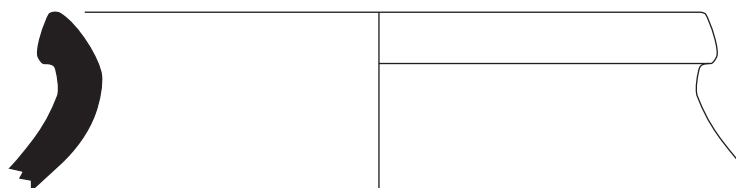

TCH99B30.79

5

Céramiques à dégraissant végétal grossier (GV)



Catalogue 64

n°	IDpoterie	locus	forme	céra.	façonnage		décor	cui.	« marque »	
					MT	S			type	position
1	TCH99B30.46	99B30	grande jarre 01 52	GV	IB-III2b			A2		
2	TCH99B30.78	99B30	grande jarre 02 B 53	GV				A2		
3	TCH99B30.75	99B30	marmite 03	GM	IB-III12			A5		
4	TCH99B30.71	99B30	marmite 02 A	GM	III6	3		A5		
5	TCH99B30.44	99B30	marmite 03	GM	IB-IIA-III6a	3		A2		
6	TCH99B30.72	99B30	marmite 03	GM	III6a	3		A5		
7	TCH99B30.21	99B30	base 1A	MW	IB-IIB-III24	5	engobe ?, coloration par tournassage	A2		
8	TCH99B30.20	99B30	bol 06 A n	MW	IB-IIB-III4	5	coloration par tournassage	A5		
9	TCH99B30.19	99B30	bol 06 A n	MW 4	III4	5	coloration par tournassage ? peinture ?	A5		
10	TCH99B30.81	99B30	bol 03 A n	MW 5				B		
11	TCH99B30.83	99B30	base 5B	MW 9	IB-IIB-III4	5	engobe, coloration par tournassage	A2		

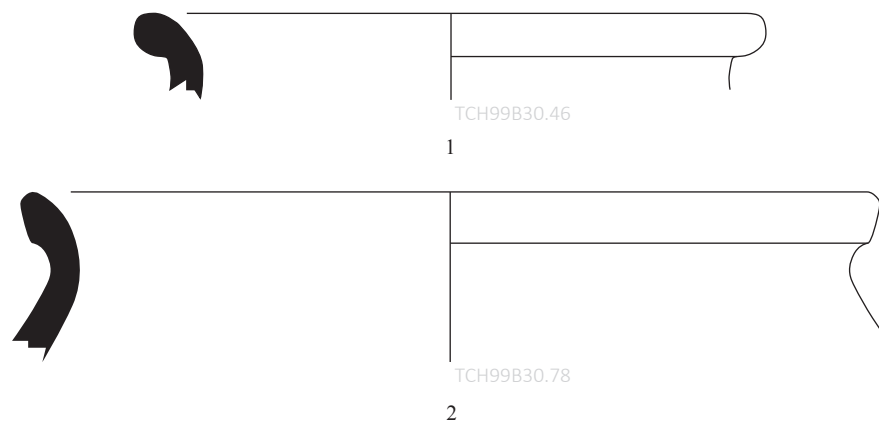

Céramiques à dégraissant végétal grossier (GV)

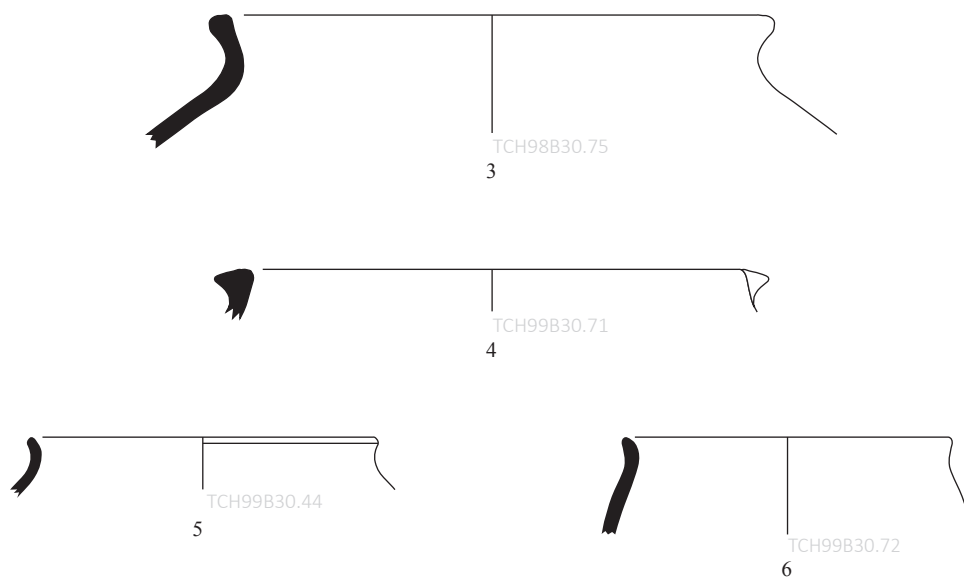

Céramiques à dégraissant minéral grossier (GM)

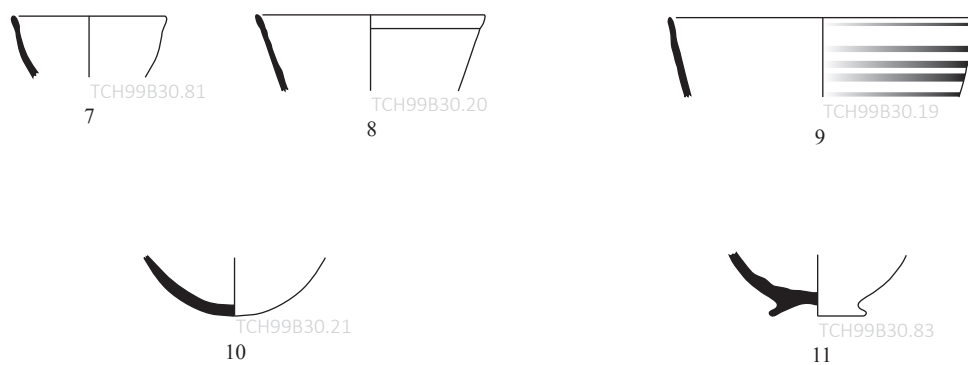

Céramiques métalliques





TCH99B38

Espace R12

		sw	gm	gv	mw	ew
NR	<b>169</b>	119		50		
NMI	<b>17</b>	16		(1)		
DIA	<b>19</b>	19				

n°	IDpoterie	locus	forme	céra.	façonnage		décor	cui.	« marque »	
					MT	S			type	position
1	TCH99B38.3	99B38	bol bas 04 C q	SW02	IB-IIIB-III2b		engobe	A5		
2	TCH99B70	99B38	bol 01 B d	SW01	IB1-IIIB-III12	4	pseudo-engobe (VO)	A5		
n.i.	TCH99B76	99B38	bol 02 B b	SW01	IB1-IIIB-III12	4	pseudo-engobe (VO)	A1		
3	TCH99B38.2	99B38	bol 02 B d	SW01	IB-IIIB-III125	4	pseudo-engobe	A5		
4	TCH99B38.1	99B38	bol 03 B i	SW01	III12		engobe	A5		
5	TCH99B38.11	99B38	pot 03 A q	nd - surcuit	III25			A5		
6	TCH99B38.10	99B38	pot 03 w	SW07	IB-III12			A5		
7	TCH99B38.9	99B38	pot 03 y	SW14	III12			A5		
8	TCH99B38.8	99B38	vase à tubulaire goulot	SW01				A5		
9	TCH99B38.7	99B38	vase à tubulaire 1 A	SW13	IB-IIAB-III12			A5		
n.i.	TCH99B38.4	99B38	petite jarre 02 B 01	SW13				A5		
10	TCH99B104	99B38	petite jarre 03 D 02	SW07				A5		
11	TCH99B105	99B38	petite jarre 03 A 03	SW07	IB1-III12		engobe, peinture	A2		
12	TCH99B38.12	99B38	jarre OE 03 B 23	SW14	IB-III2			A1		
13	TCH99B38.6	99B38	jarre OE 02 A 25	SW14	IB-III2			A5		
14	TCH99B38.14	99B38	jarre OE 02 A 25	SW13			engobe	A5		
15	TCH99B38.5	99B38	jarre OE 02 A 25	SW13	IB-IIIB-III2			A4		
16	TCH99B38.13	99B38	jarre OE 02 A 26	SW14	IB-III12			A5		
n.i.	TCH99B38.15	99B38	panse	SW01	IB-IIIB-III2		engobe	A5		

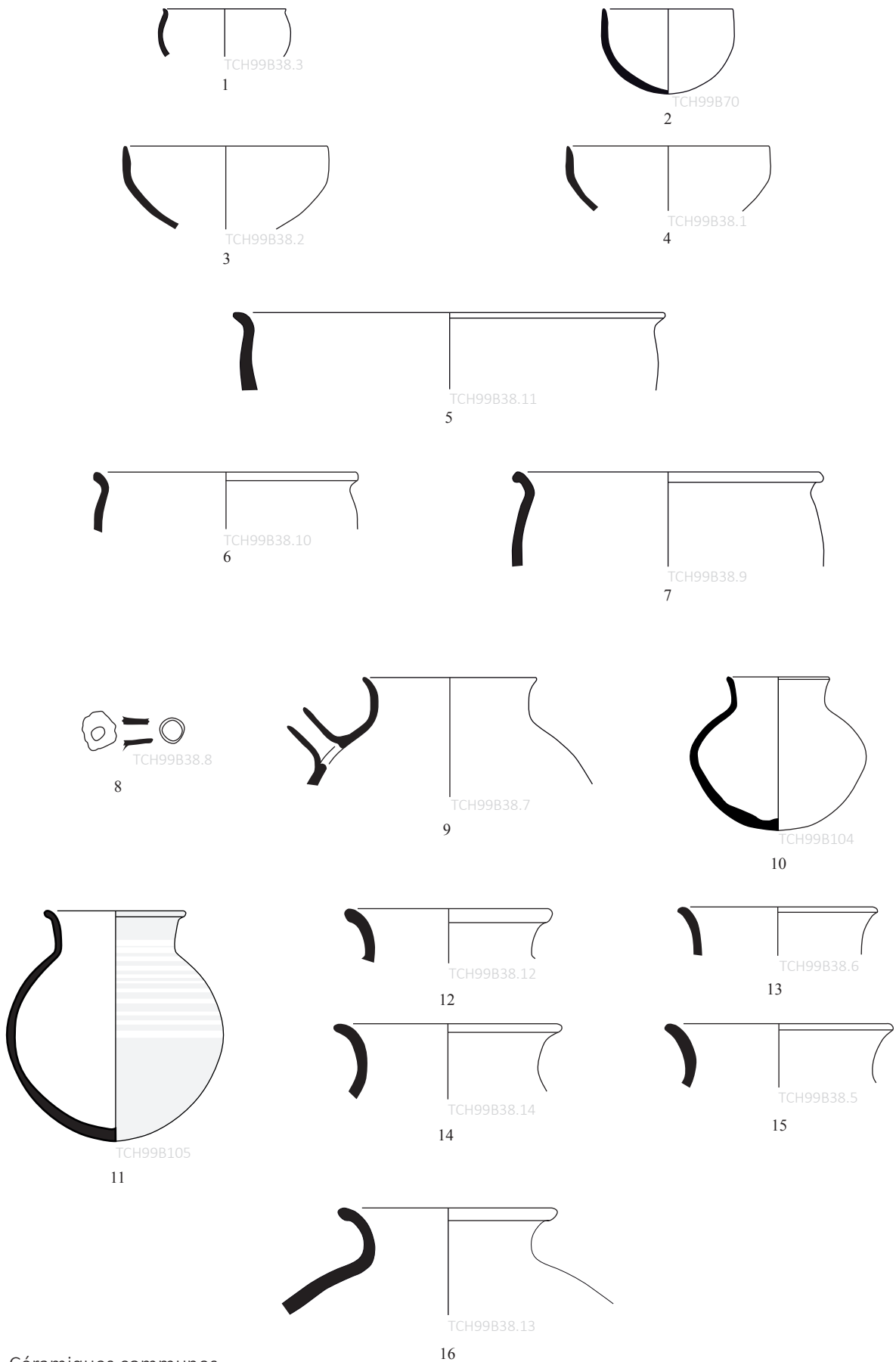

Céramiques communes





TCH96B14

Espace R96-2

		sw	gm	gv	mw	ew
NR	<b>51</b>	47	1	3		
NMI	<b>14</b>	12	(1)	(1)		
DIA	<b>12</b>	12				

n°	IDpoterie	locus	forme	céra.	façonnage		décor	cui.	« marque »	
					MT	S			type	position
1	TCH96B14.1	96B14	bol bas 02 C h	SW01				A5		
2	TCH96B14.10	96B14	bol 01 A e	SW13				A5		
3	TCH96B14.6	96B14	bol 01 B b	SW01				A5		
4	TCH96B14.8	96B14	bol 01 B c	SW01				A5		
5	TCH96B14.4	96B14	bol 02 A a	SW02				A5		
6	TCH96B14.2	96B14	bol 02 B a	SW02				A5		
7	TCH96B14.3	96B14	bol 03 A i	SW01				A5		
8	TCH96B14.9	96B14	pot 03 v	SW14				A5		
9	TCH96B14.12	96B14	jarre OE 03 B 23	SW13				A5		
10	TCH96B14.11	96B14	jarre OL 02 B 37	SW04				A5		
11	TCH96B14.7	96B14	support ?	SW14				A5		
12	TCH96B14.5	96B14	jarre OL 03 B 39	SW26				A2		



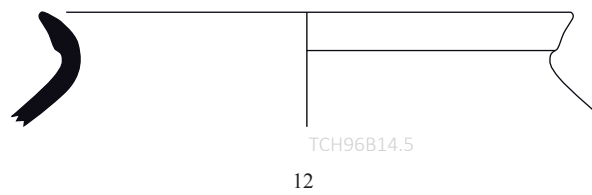
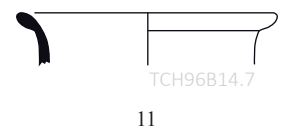
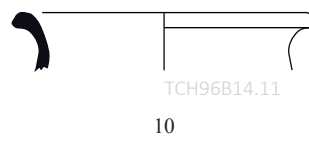
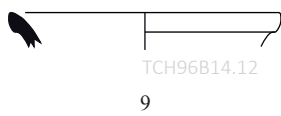
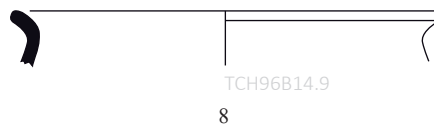
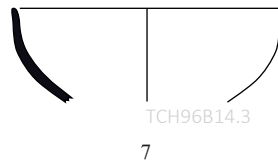
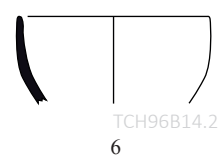
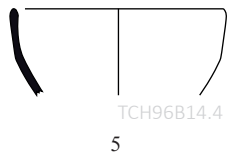
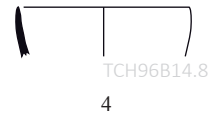
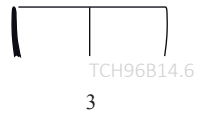
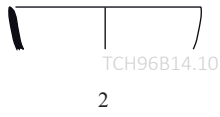
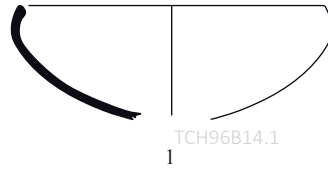

Céramiques communes



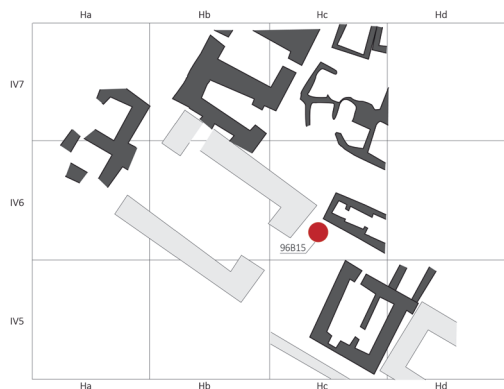

TCH96B15

Surface de cailloutis au sud de R205

		sw	gm	gv	mw	ew
NR	<b>248</b>	214	4	29	1	
NMI	<b>47</b>	42	3	1	(1)	
DIA	<b>51</b>	47	3	1		

n°	IDpoterie	locus	forme	céra.	façonnage		décor	cui.	« marque »	
					MT	S			type	position
1	TCH96B15.34	96B15	bol 01 A c	SW01	IB-IIB-III24	5	pseudo-engobe (VO)	A5		
2	TCH96B15.36	96B15	bol 01 A d	SW02	IB-IIB-III12	4		A5		
3	TCH96B15.9	96B15	bol 01 A d	SW07	III12			A5		
4	TCH96B15.3	96B15	bol 01 B a	SW02	IB-III12			A5		
5	TCH96B15.1	96B15	bol 01 B d	SW02	IB-IIB-III2			A5		
6	TCH96B15.2	96B15	bol 01 C c	SW01	III12			A5		
7	TCH96B15.35	96B15	bol 02 A a	SW01	III2b			A5		
8	TCH96B15.11	96B15	bol 02 A a	SW02	IB-IIB-III2b			A5		
9	TCH96B15.18	96B15	bol 02 A c	SW01	IB-IIB-III2b			A5		
10	TCH96B15.15	96B15	bol 02 A d	SW02	III2b			A5		
11	TCH96B15.14	96B15	bol 02 B a	SW02	IB-IIB-III2b			A5		
n.i.	TCH96B15.19	96B15	bol 02 B b	SW01	III2b			A5		
12	TCH96B15.46	96B15	bol 02 B b	SW14				A5		
13	TCH96B15.12	96B15	bol 02 B b	SW01	IB-IIB-III12	4	pseudo-engobe (VO)	A5		
14	TCH96B15.10	96B15	bol 02 B c	SW01	IB-IIB-III125	4		A5		
15	TCH96B15.40	96B15	bol 02 B c	SW07	IB-IIB-III125	4		A5		
16	TCH96B15.32	96B15	bol 02 B c	SW07	III2			A5		
17	TCH96B15.20	96B15	bol 02 B d	SW01	IB			A5		
n.i.	TCH96B15.5	96B15	bol 02 B d	SW02	III12			A5		
18	TCH96B15.6	96B15	bol 02 C c	SW01	IB-IIB-III2			A5		
19	TCH96B15.8	96B15	bol 03 A i	SW01	III2			A5		
20	TCH96B15.37	96B15	bol 03 B i	SW02	IB-IIB-III12	4		A5		
21	TCH96B15.48	96B15	bol 03 B i	SW07			pseudo-engobe (VO)	A3		
22	TCH96B15.39	96B15	bol 03 B j	SW02	IB-IIB-III125	4		A5		
23	TCH96B15.16	96B15	bol 03 B n	SW01	IB-IIB-III25	4		A1		
24	TCH96B15.17	96B15	bol 03 C i	SW02	IB-IIB			A5		
25	TCH96B15.24	96B15	bol 04 C q	SW02	IB-IIB-III2			A5		
26	TCH96B15.49	96B15	bol 06 A a	SW04				A5		
27	TCH96B15.28	96B15	pot 03 v	SW10	III125			A2		
28	TCH96B15.23	96B15	pot 03 A x	SW13	IB-IIB-III2		engobe	A5		
29	TCH96B15.22	96B15	pot 03 v	SW14	III2			A5		

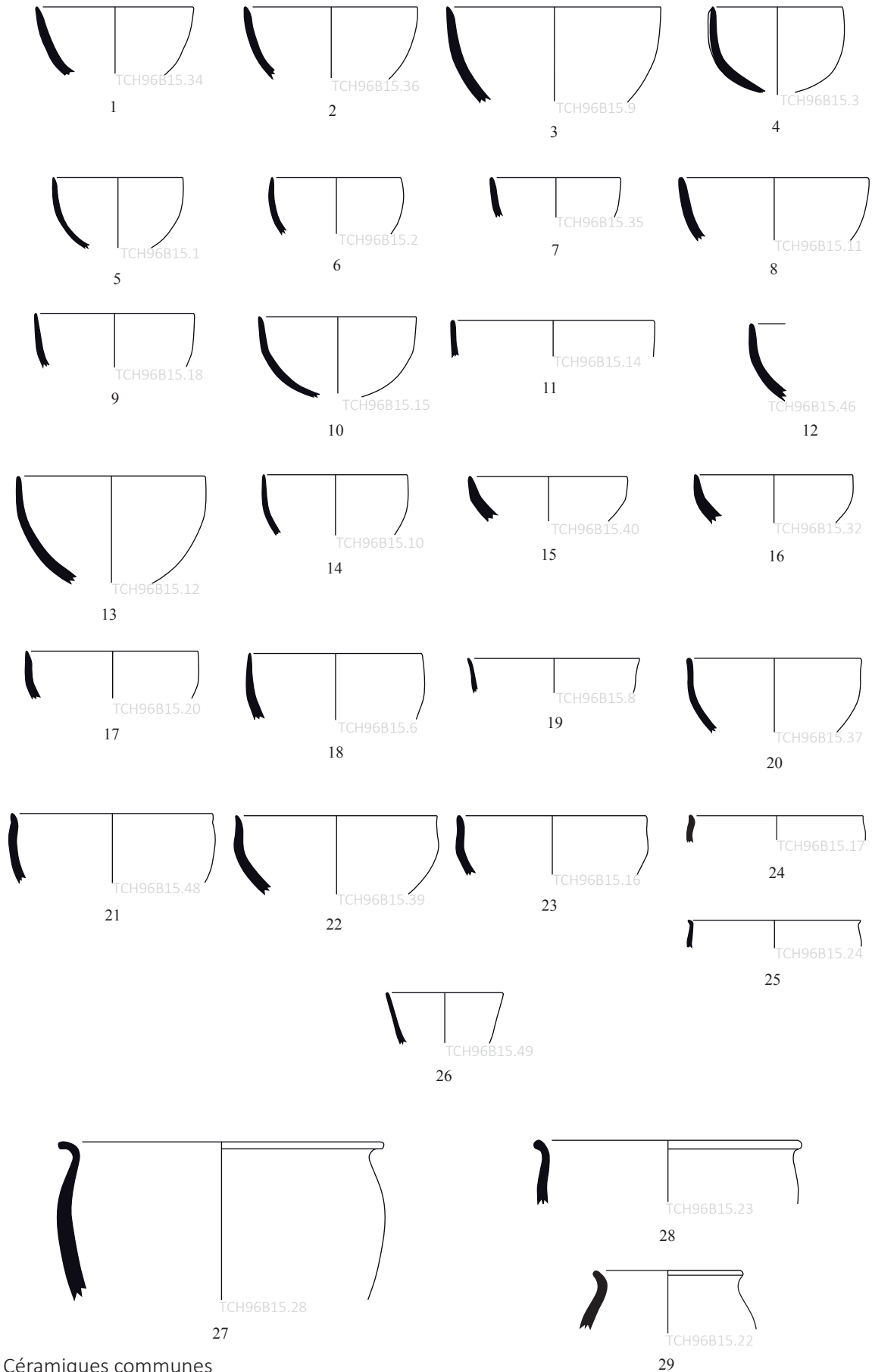

Céramiques communes



n°	IDpoterie	locus	forme	céra.	façonnage		décor	cui.	« marque »	
					MT	S			type	position
1	TCH96B15.27	96B15	petite jarre 03 B 10	SW01	IB-IIB		peinture sur engobe	A5		
2	TCH96B15.43	96B15	petite jarre 03 D 02	SW02				A5		
3	TCH96B15.30	96B15	vase miniature 07 C	SW02	IB-IIB-III12	4		A5		
4	TCH96B15.26	96B15	jarre OE 01 B 36	SW04	III12			A5		
5	TCH96B15.41	96B15	jarre OE 02 B 25	SW14				A5		
6	TCH96B15.45	96B15	support ?	SW05b				A5		
7	TCH96B15.42	96B15	support ?	SW07				A2		
8	TCH96B15.44	96B15	support ?	SW04				A5		
9	TCH96B15.50	96B15	support 04	SW04b			engobe	A2		
10	TCH96B15.29	96B15	bord	nd				A5		
11	TCH96B15.4	96B15	passoire panse	SW07	IB-IIA-III15	2		A2		
12	TCH96B15.7	96B15	encensoir bord	SW13	IB-III2		excision par découpage	A5		
13	TCH96B15.31	96B15	nd	SW04	IA	1		A1		
14	TCH96B15.13	96B15	base 1A	SW02	IB-IIB-III12	4		A5		
15	TCH96B15.53	96B15	base 1A	SW02	III1			A5		
16	TCH96B15.21	96B15	base 1A	SW05	IB-IIB-III1	4		A5		
17	TCH96B15.52	96B15	base 4	GV	IB-IIA			A2		
18	TCH96B15.54	96B15	marmite 02 C	GM	III6b	3		A5		
19	TCH96B15.25	96B15	marmite 02	GM	III6	3		A5		
20	TCH96B15.51	96B15	marmite?	GM	III6a	3		B 4-		



Céramiques communes (suite)

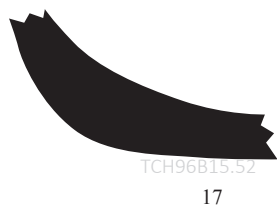

Céramiques à dégraissant végétal grossier (GV)



Céramiques à dégraissant minéral grossier (GM)

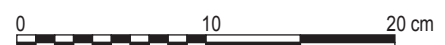



TCH96B22

Couche cendreuse, espace R96-2

		sw	gm	gv	mw	ew
NR	<b>97</b>	65	10	22		
NMI	<b>19</b>	14	3	2		
DIA	<b>19</b>	14	3	2		

n°	IDpoterie	locus	forme	céra.	façonnage		décor	cui.	« marque »	
					MT	S			type	position
1	TCH96B119	96B22	bol 01 B c	SW01				A5		
2	TCH96B22.4	96B22	bol 02 B e	SW02				A5		
3	TCH96B22.1	96B22	bol 02 C a	SW01				A5		
4	TCH96B22.3	96B22	bol 03 C i	SW01				A5		
5	TCH96B22.6	96B22	pot 03 v	SW01				A5		
6	TCH96B22.8	96B22	pot 03 v	SW13				A5		
7	TCH96B22.11	96B22	pot 03 w	SW13				A5		
8	TCH96B22.17	96B22	pot 03 x	SW10				A5		
9	TCH96B118	96B22	vase à tubulaire 1 D	SW05				A3		
10	TCH96B22.9	96B22	jarre OE 02 B 16	SW14				A5		
11	TCH96B22.5	96B22	jarre OE 03 B 23	SW14				A5		
12	TCH96B22.13	96B22	jarre OL 02 B 16	SW13			engobe	A2		
13	TCH96B22.16	96B22	support ?	SW13			engobe	A1		

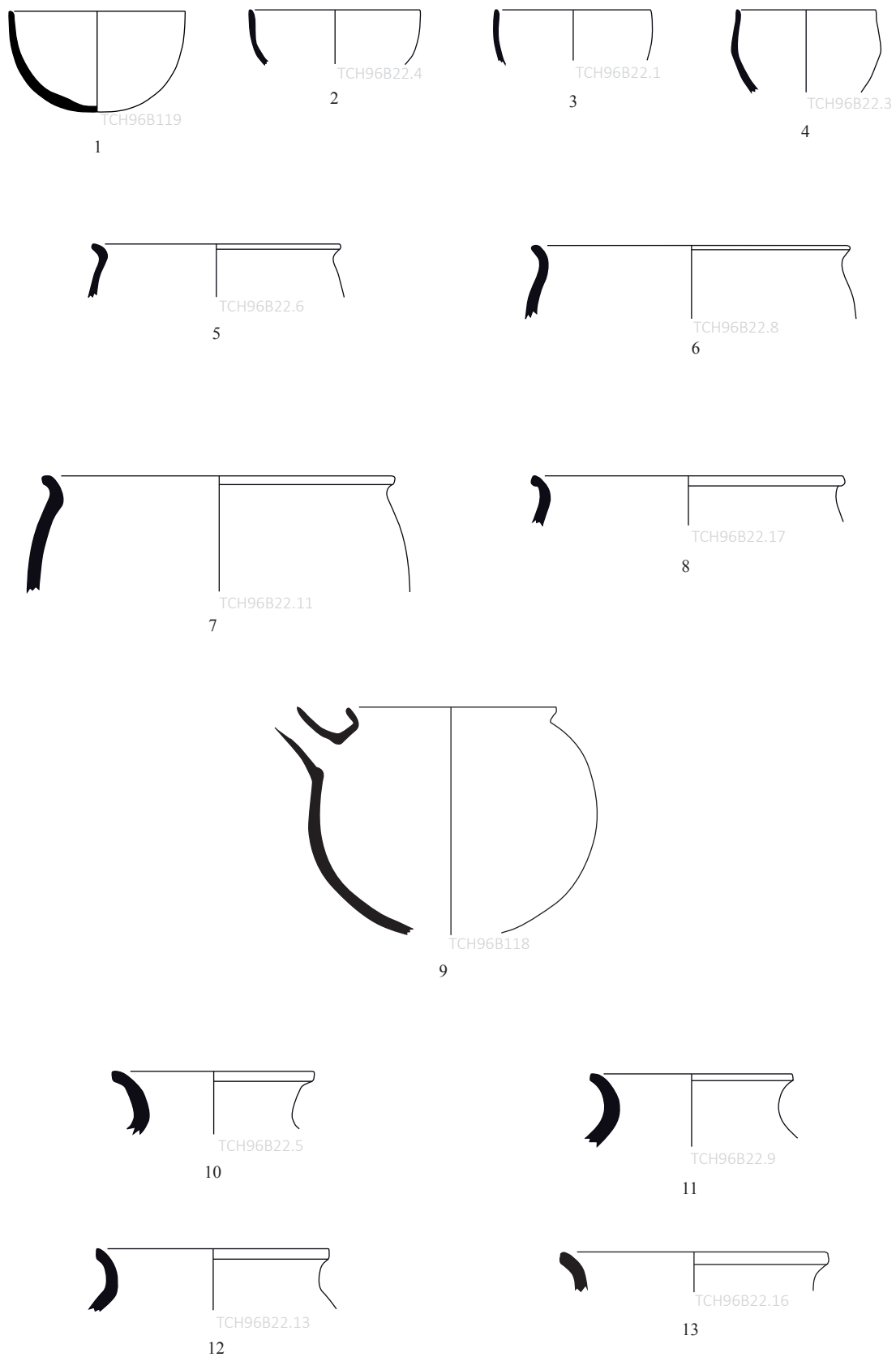

Céramiques communes



n°	IDpoterie	locus	forme	céra.	façonnage		décor	cui.	« marque »	
					MT	S			type	position
1	TCH96B22.2	96B22	grande jarre 03 B 32	SW04				A5		
2	TCH96B22.12	96B22	grande jarre 02 53	GV				A2		
3	TCH96B22.10	96B22	grande jarre 02 53	GV				A5		
4	TCH96B22.14	96B22	marmite 02 C	GM	III6a	3		A5		
ε	TCH96B22.7	96B22	marmite 02 A	GM	III6a	3		A2		



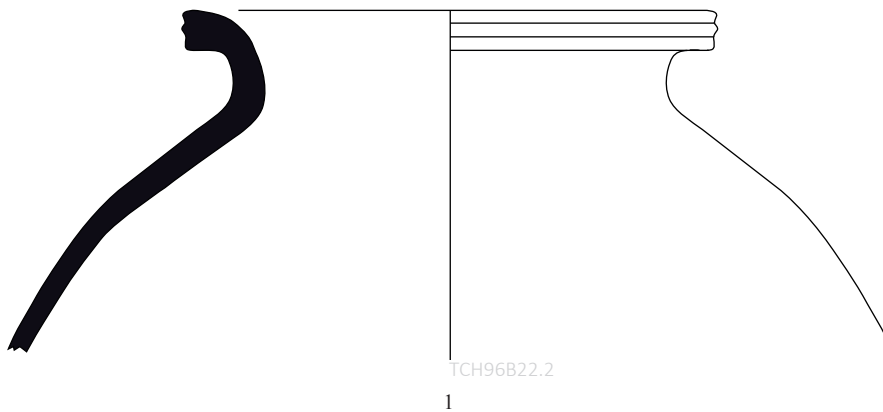

Céramiques communes (suite)

---

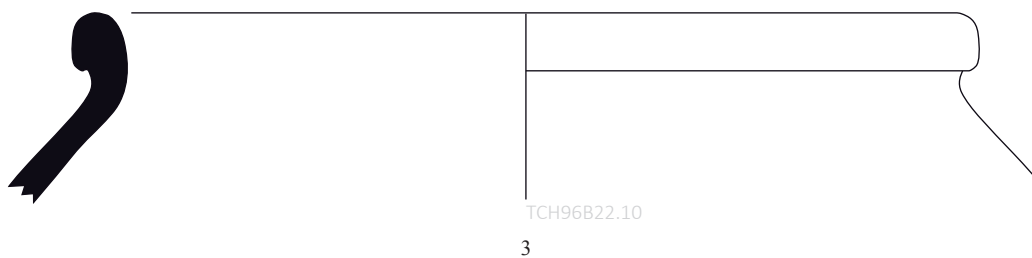
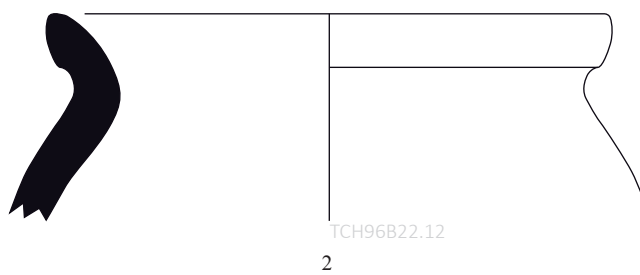

Céramiques à dégraissant végétal grossier (GV)

---



Céramiques à dégraissant minéral grossier (GM)



Catalogue 71



TCH96B30

Espace R14

		sw	gm	gv	mw	ew
NR	<b>267</b>	180	14	73		
NMI	<b>32</b>	27	4	1		
DIA	<b>36</b>	31	4	1		

n°	IDpoterie	locus	forme	céra.	façonnage		décor	cui.	« marque »	
					MT	S			type	position
1	TCH96B30.13	96B30	bol 01 A d	SW02				A5		
2	TCH96B30.7	96B30	bol 02 A a	SW05				A5		
3	TCH96B30.11	96B30	bol 02 B e	SW02			pseudo-engobe (VO)	A5		
4	TCH96B30.6	96B30	bol 02 C a	SW02				A5		
5	TCH96B30.9	96B30	bol 03 A i	SW01				A5		
6	TCH96B30.10	96B30	bol 03 B i	SW01				A5		
7	TCH96B30.8	96B30	bol 03 B i	SW01				A5		
8	TCH96B30.5	96B30	bol 03 B i	SW02				A5		
9	TCH96B30.12	96B30	bol 03 B j	SW01				A2		
10	TCH96B30.17	96B30	bol 03 B o	SW02				A5		
11	TCH96B30.15	96B30	bol 03 B o	SW02				A5		
12	TCH96B30.14	96B30	bol 05 A l	SW05			engobe	A5		
13	TCH96B30.31	96B30	pot 03 o	SW13			engobe	A5		
14	TCH96B30.32	96B30	pot 03 o	SW14				A1		
15	TCH96B30.30	96B30	pot 03 y	SW14				A2		
16	TCH96B30.29	96B30	pot 03 w	SW14			pseudo-engobe	A5		
17	TCH96B30.21	96B30	petite jarre 03 A 01	SW01			engobe	A5		
18	TCH96B30.19	96B30	petite jarre 03 D 03	SW01			engobe	A5		
19	TCH96B30.20	96B30	jarre OE 03 A 26	SW01				A5		
20	TCH96B30.22	96B30	jarre OE 03 A 26	SW04			engobe	A5		
21	TCH96B30.33	96B30	support ?	SW13				A5		
22	TCH96B30.24	96B30	support ?	SW13			engobe	A2		
23	TCH96B30.26	96B30	jarre OL 01 C 26	nd			engobe	A2		
24	TCH96B30.23	96B30	jarre OL 02 B 08	SW13			engobe	A2		
25	TCH96B30.16	96B30	nd -bord	SW07			engobe	A5		
26	TCH96B30.18	96B30	nd -panse	SW02			peinture ?	A5		
27	TCH96B30.2	96B30	base 2	SW02				A5		
28	TCH96B30.1	96B30	base 3A	SW01				A5		
29	TCH96B30.3	96B30	base 3A	SW02				A5		
30	TCH96B30.4	96B30	base 5A	SW04				A5		

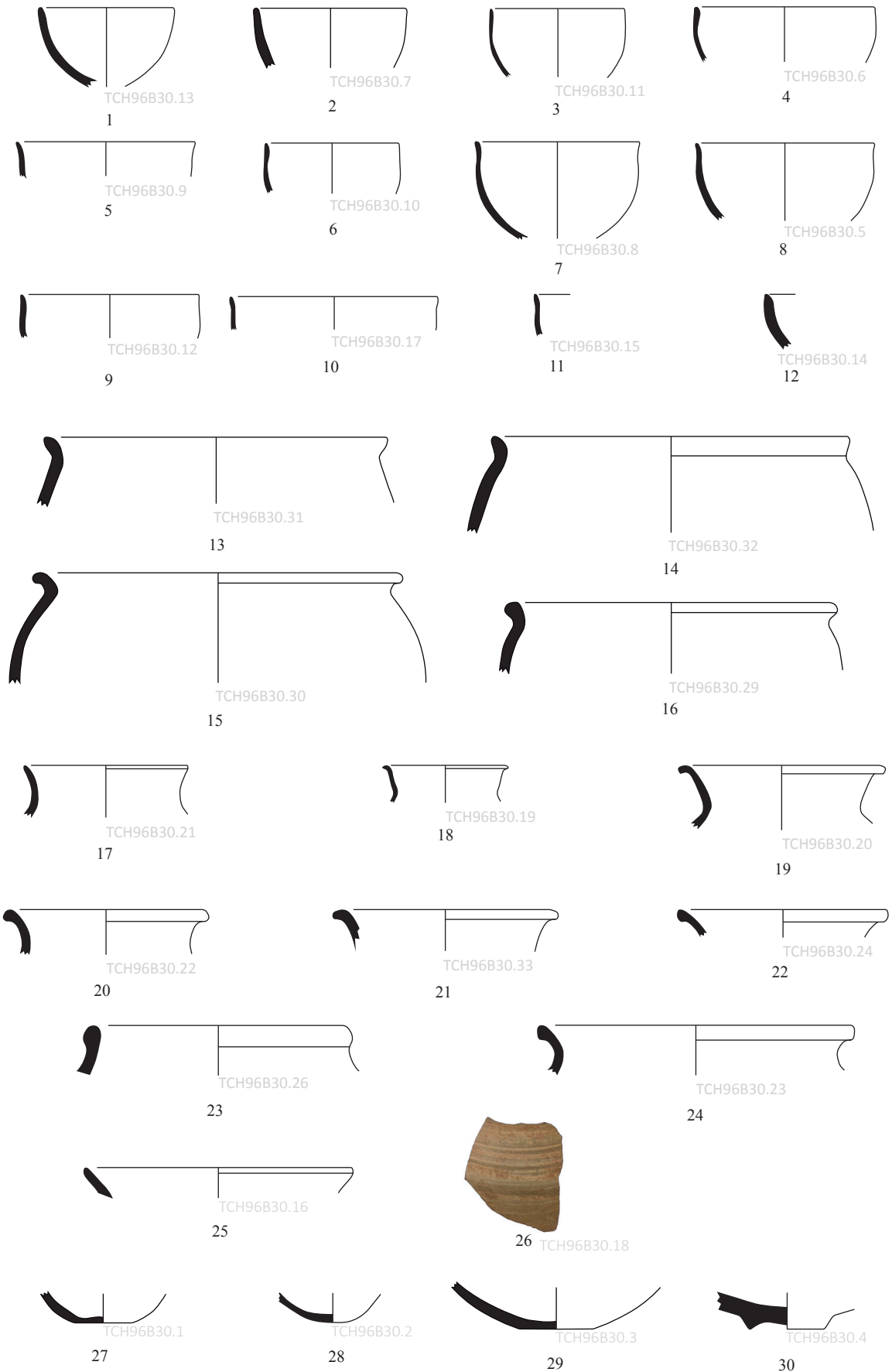

Céramiques communes



n°	IDpoterie	locus	forme	céra.	façonnage		décor	cui.	« marque »	
					MT	S			type	position
1	TCH96B30.37	96B30	grande jarre 04 52	nd				A5		
2	TCH96B30.36	96B30	base 4	GV				A5		
3	TCH96B30.28	96B30	marmite 02 A	GM	III6	3		A2		
4	TCH96B30.38	96B30	marmite 02 A	GM				A5		
5	TCH96B30.25	96B30	marmite 02 C	GM	III6	3		A5		
6	TCH96B30.27	96B30	marmite 02 C	GM	III6a	3		A5		

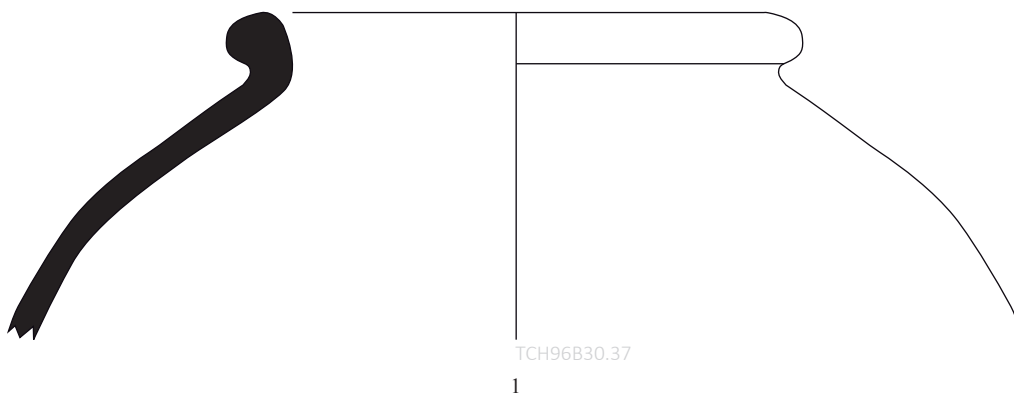

Céramiques à dégraissant végétal grossier (GV)

---

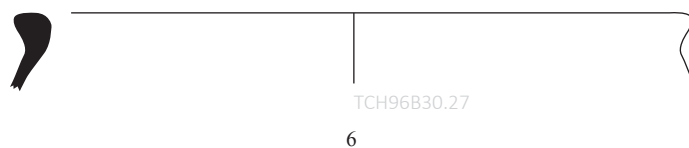
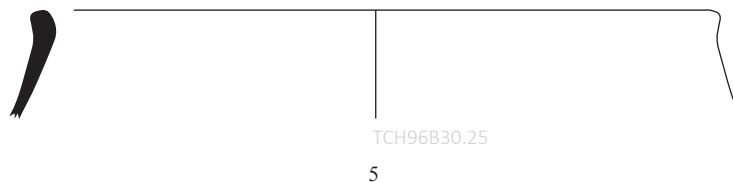
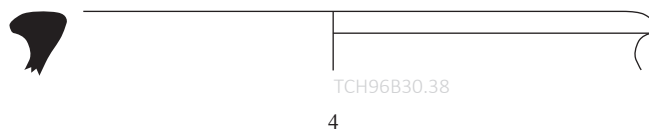
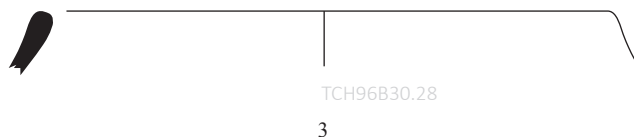

Céramiques à dégraissant minéral grossier (GM)





TCH96B39

Couche cendreuse, immédiatement sous la surface en cailloutis du niveau 3, au N du SBII.

		sw	gm	gv	mw	ew
NR	<b>573</b>	549	16		8	
NMI	<b>98</b>	85	6	5	2	
DIA	<b>102</b>	89	6	5	2	

n°	IDpoterie	locus	forme	céra.	façonnage		décor	cui.	« marque »	
					MT	S			type	position
1	TCH96B39.47	96B39	bol bas 03 A i	SW02			pseudo-engobe (VO)	A5		
n.i.	TCH96B39.32	96B39	bol 01	SW01				A5		
2	TCH96B39.48	96B39	bol 01 B c	SW07				A5		
3	TCH96B39.22	96B39	bol 01 C a	SW01			pseudo-engobe (VO)	A5		
4	TCH96B39.29	96B39	bol 01 C b	SW07			engobe	A5		
n.i.	TCH96B39.40	96B39	bord 004	SW13			engobe	A5		
5	TCH96B39.26	96B39	bol 02 A a	SW01				A5		
6	TCH96B39.33	96B39	bol 02 A c	SW02				A5		
7	TCH96B39.8	96B39	bol 02 A d	SW02			pseudo-engobe (VO)	A5		
8	TCH96B39.119	96B39	bol 02 B a	SW01				A5		
n.i.	TCH96B39.24	96B39	bol 02 B a	SW01			pseudo-engobe	A5		
9	TCH96B39.90	96B39	bol 02 B a	SW02				A5		
10	TCH96B77	96B39	bol 02 B a	SW07			pseudo-engobe (VO)	A5		
11	TCH96B39.82	96B39	bol 02 B b	SW02			engobe	A5		
12	TCH96B39.39	96B39	bol 02 B d	SW02				A5		
n.i.	TCH96B39.34	96B39	bol 02 C a	SW01				A5		
13	TCH96B39.21	96B39	bol 02 C b	SW01				A5		
14	TCH96B39.5	96B39	bol 02 C d	SW07				A5		
15	TCH96B39.49	96B39	bol 03 A i	SW02				A5		
16	TCH96B39.50	96B39	bol 03 A i	SW02				A5		
17	TCH96B39.38	96B39	bol 03 A i	SW02				A5		
18	TCH96B39.46	96B39	bol 03 A i	SW02				A5		
19	TCH96B39.9	96B39	bol 03 A i	SW02				A5		
20	TCH96B39.118	96B39	bol 03 B i	SW01				A5		
n.i.	TCH96B39.41	96B39	bol 03 B i	SW02			engobe	A5		
21	TCH96B39.12	96B39	bol 03 B i	SW02				A5		
22	TCH96B39.43	96B39	bol 03 B j	SW01				A5		
23	TCH96B39.10	96B39	bol 03 B n	SW02			pseudo-engobe (VO)	A5		
24	TCH96B39.1	96B39	bol 03 B p	SW01				A5		
25	TCH96B39.16	96B39	bol 03 C i	SW02				A5		
26	TCH96B39.20	96B39	bol 03 C j	SW02				A5		
27	TCH96B39.27	96B39	bol 03 C n	SW02				A5		
28	TCH96B39.14	96B39	bol 05 A g	nd -SW				A5		
29	TCH96B39.86	96B39	bol 05 A k	SW05				A5		

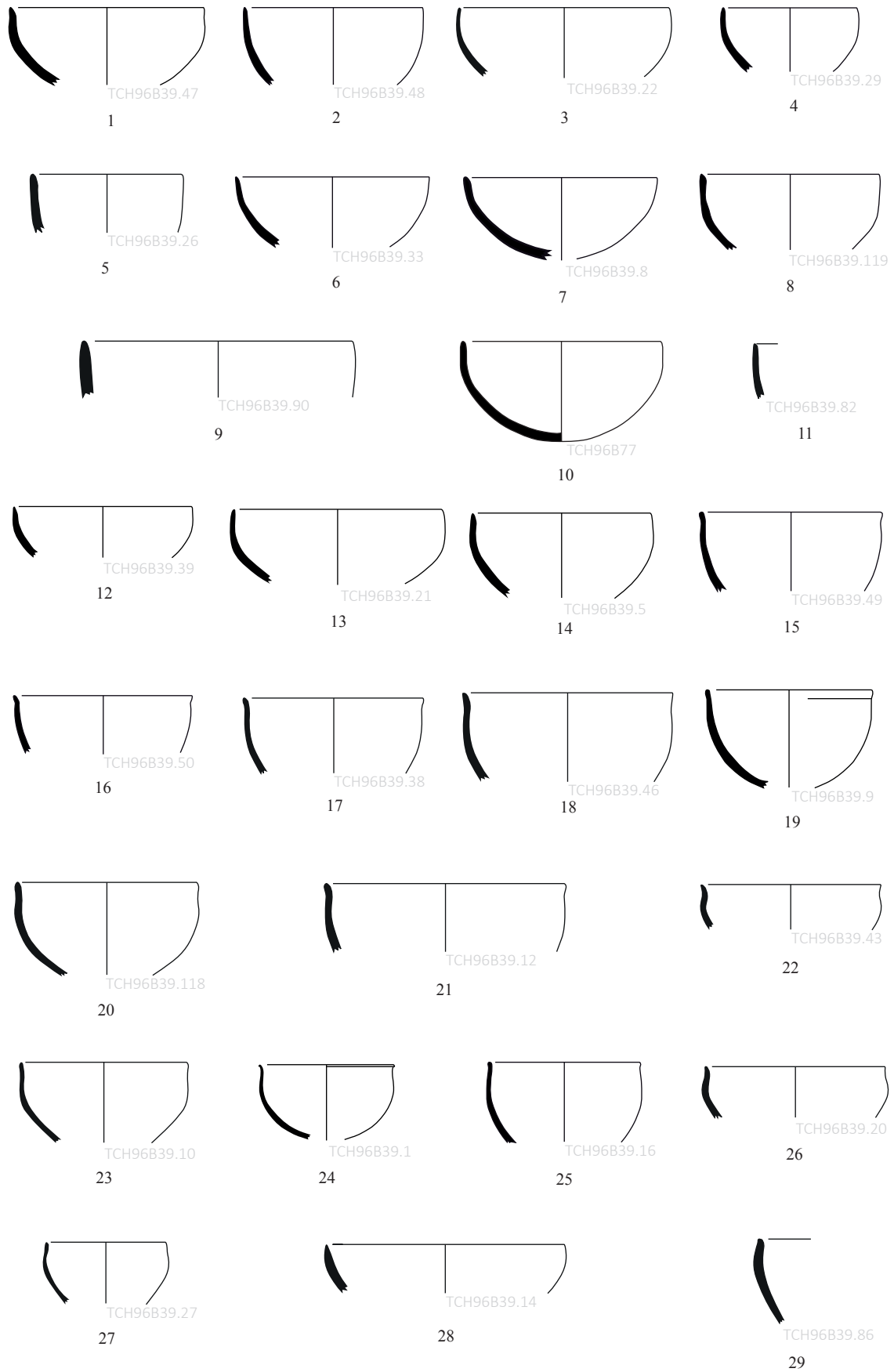

Céramiques communes



n°	IDpoterie	locus	forme	céra.	façonnage		décor	cui.	« marque »	
					MT	S			type	position
1	TCH96B39.71	96B39	pot 03 o	SW01b				A2		
2	TCH96B39.98	96B39	pot 03 u	SW07				A5		
3	TCH96B39.114	96B39	pot 03 u	SW13				A5		
4	TCH96B39.81	96B39	pot 03 v	SW13			engobe	A5		
5	TCH96B39.30	96B39	pot 03 v	SW04			pseudo-engobe	A5		
6	TCH96B39.54	96B39	pot 03 x	SW13			engobe	A5		
7	TCH96B39.97	96B39	pot 03 x	SW07			engobe	A5		
8	TCH96B39.44	96B39	petite jarre 03 A 03	SW12				A5		
9	TCH96B39.59	96B39	petite jarre 03 D 03	SW01b				A5		
10	TCH96B39.100	96B39	petite jarre 02 A 15	SW13			engobe	A5		
11	TCH96B39.55	96B39	petite jarre 02 B 08	SW04	III2			A5		
12	TCH96B39.74	96B39	petite jarre 02 B 08	SW01b				A5		
13	TCH96B39.99	96B39	support ?	SW13			engobe	A5		
14	TCH96B39.69	96B39	petite jarre 02 B 11	SW07			engobe	A5		
15	TCH96B39.60	96B39	petite jarre 02 B 16	SW07				A5		
n.i.	TCH96B39.116	96B39	jarre nd	SW07			engobe	A5		
16	TCH96B39.77	96B39	support ?	SW07			engobe	A5		
17	TCH96B39.83	96B39	jarre OE 02 A 26	SW13			engobe	A5		
18	TCH96B39.112	96B39	jarre OE 02 B 25	SW04				A5		
19	TCH96B39.108	96B39	jarre OE 02 B 25	SW07			engobe	A5		
20	TCH96B39.102	96B39	jarre OE 02 B 25	SW12				A5		
21	TCH96B39.17	96B39	jarre OE 02 B 25	SW14			engobe	A5		
22	TCH96B39.107	96B39	support ?	SW14				A5		
23	TCH96B39.28	96B39	jarre OE 03 A 26	SW13				A5		
24	TCH96B39.91	96B39	support ?	SW13			engobe	A5		
25	TCH96B39.106	96B39	support ?	SW14				A5		
26	TCH96B39.45	96B39	jarre OE 03 A 27	nd				A5		



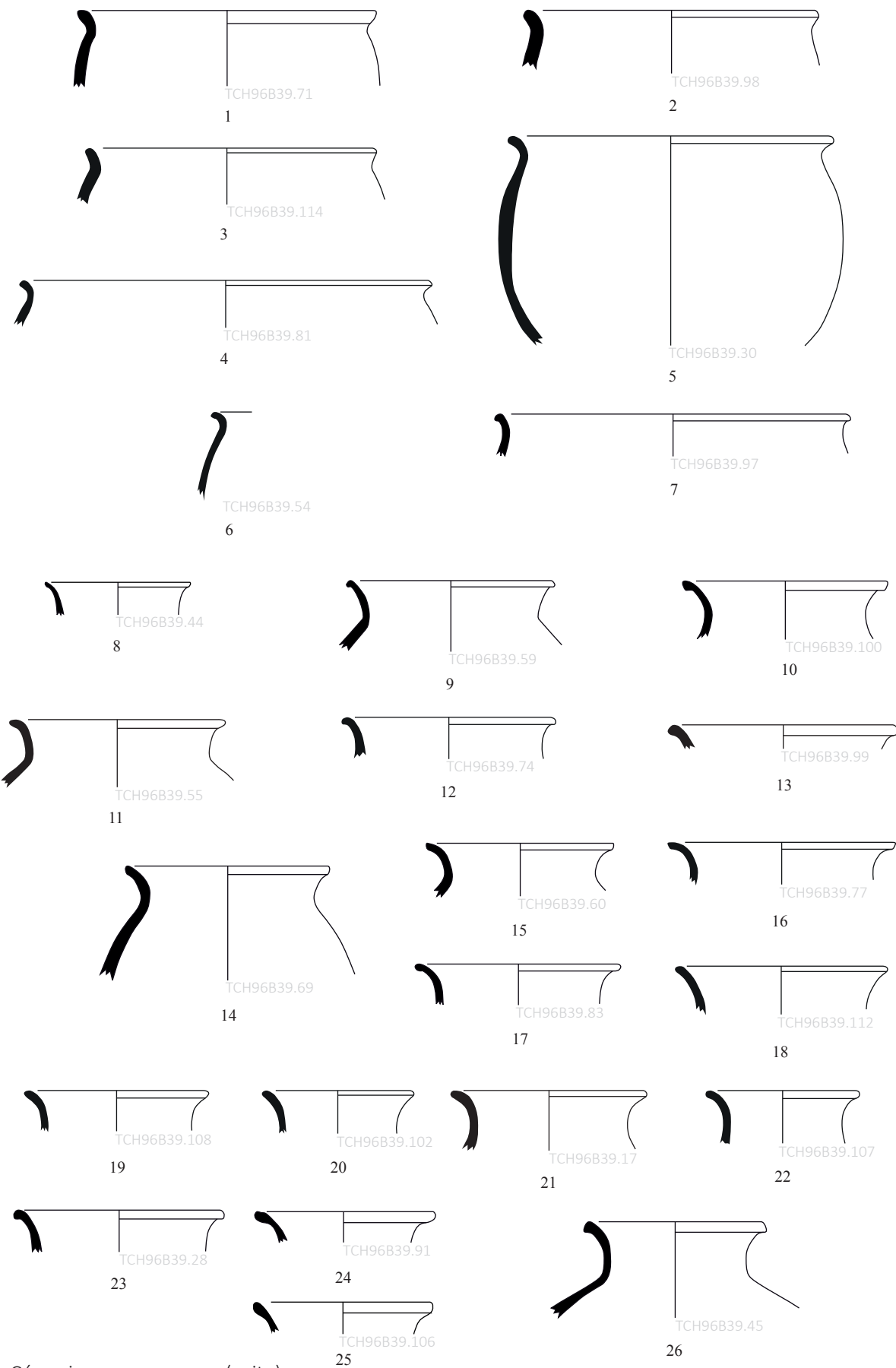

Céramiques communes (suite)



n°	IDpoterie	locus	forme	céra.	façonnage		décor	cui.	« marque »	
					MT	S			type	position
1	TCH96B39.37	96B39	jarre OE 03 B 23	SW04				A5		
2	TCH96B39.18	96B39	jarre OE 03 B 23	nd – surcuit				A5		
3	TCH96B39.58	96B39	jarre OE 03 B 23	SW13				A3		
4	TCH96B39.73	96B39	jarre OE 03 B 23	SW14				A5		
5	TCH96B39.56	96B39	support ?	SW13			engobe	A5		
6	TCH96B39.25	96B39	jarre OE 03 B 23	SW14				A5		
7	TCH96B39.15	96B39	jarre OE 03 B 23	SW14			engobe	A2		
8	TCH96B39.89	96B39	support ?	SW14				A2		
9	TCH96B39.115	96B39	support ?	SW13				A5		
10	TCH96B39.88	96B39	support ?	SW13				A5		
11	TCH96B39.93	96B39	jarre OL 02 B 16	SW13			engobe	A5		
12	TCH96B39.113	96B39	jarre OL 02 B 16	SW13			engobe	A5		
13	TCH96B39.76	96B39	jarre OL 02 B 19	SW04				A5		
14	TCH96B39.62	96B39	jarre OL 02 B 23	SW14				A5		
15	TCH96B39.67	96B39	jarre OL 02 B 37	SW14				A5		
16	TCH96B39.11	96B39	jarre OL 02 B 37	SW14	IB-III12			A5		
17	TCH96B39.13	96B39	jarre OL 02 D 21	SW26				A2		
18	TCH96B39.87	96B39	jarre OL 02 D 21	SW26			engobe	A2		
19	TCH96B39.61	96B39	jarre OL 02 D 21	SW26			engobe	A2		
20	TCH96B39.57	96B39	jarre OL 03 B 44	SW26				A5		

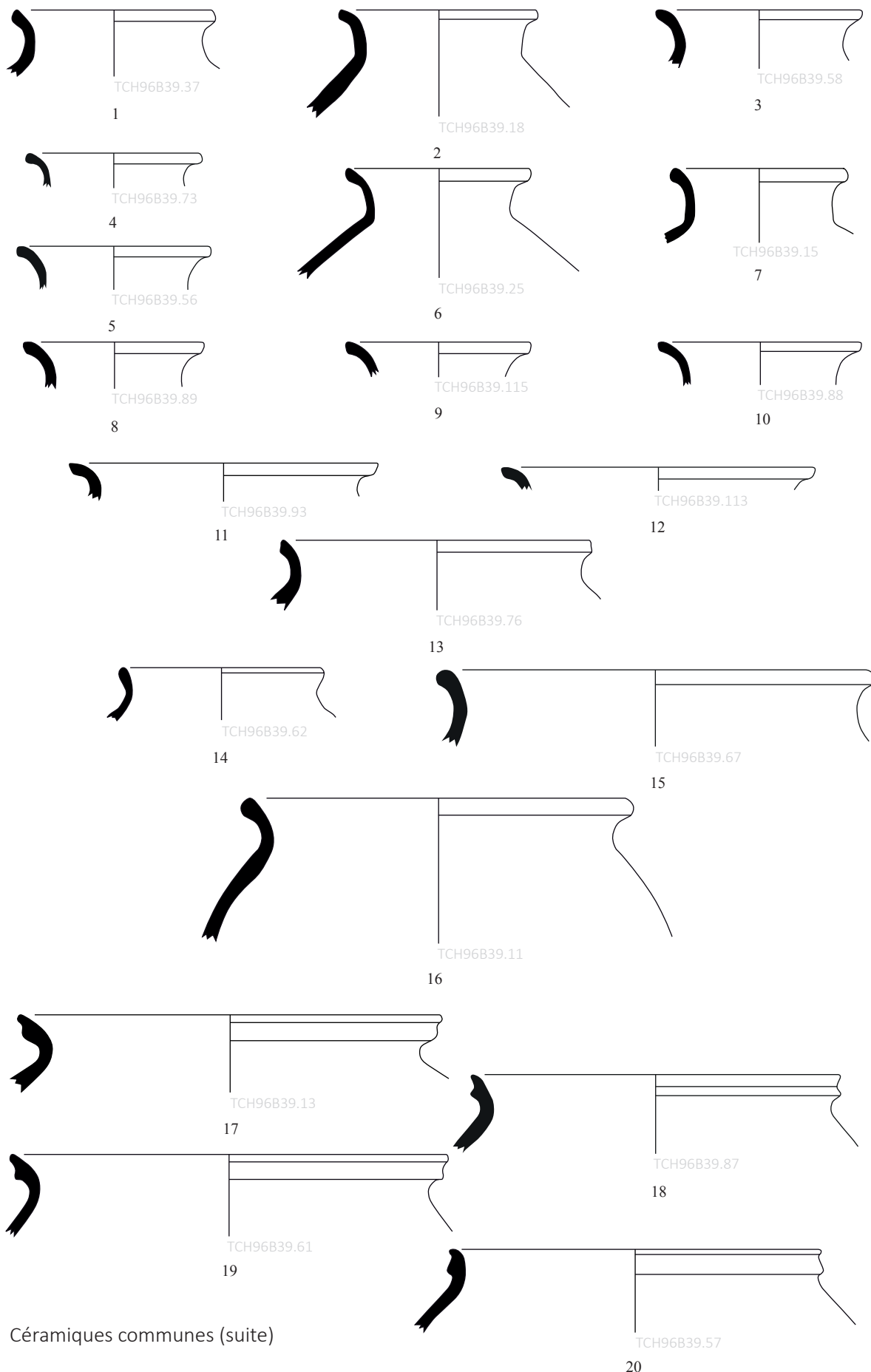

Céramiques communes (suite)



n°	IDpoterie	locus	forme	céra.	façonnage		décor	cui.	« marque »	
					MT	S			type	position
1	TCH96B39.6	96B39	base 1A	SW02				A5		
2	TCH96B39.84	96B39	base 2	SW02				A5		
3	TCH96B39.78	96B39	base 6	SW01		4	engobe	A5		
4	TCH96B505	96B39	base 7A	SW12				A5		
5	TCH96B39.70	96B39	support ?	SW04				A5		
6	TCH96B39.65	96B39	support ?	SW13				A5		
7	TCH96B39.19	96B39	support ?	SW13			engobe	A5		
n.i.	TCH96B39.103	96B39	support ?	SW13			engobe	A2		
8	TCH96B39.2	96B39	jarre de stockage 02 53	GV				A5		
9	TCH96B39.4	96B39	jarre de stockage 02 54	GV				A5		
10	TCH96B39.7	96B39	support 01	GV				A2		
n.i.	TCH96B39.23	96B39	grande jarre	GV				A2		
11	TCH96B39.3	96B39	support ?	GV				A2		
12	TCH96B39.110	96B39	marmite 02 A	GM				A5		
13	TCH96B39.117	96B39	marmite 02 C	GM				A5		
14	TCH96B39.96	96B39	marmite 02 C	GM				B		
n.i.	TCH96B39.109	96B39	marmite 02 C	GM				A5		
15	TCH96B39.31	96B39	marmite 03	GM				A5		
n.i.	TCH96B39.63	96B39	marmite 03	GM?				A5		
16	TCH96B39.53	96B39	petite jarre 03 E 05	MW				B		
17	TCH96B39.85	96B39	petite jarre 03 B 05	MW	III4	5		A2		

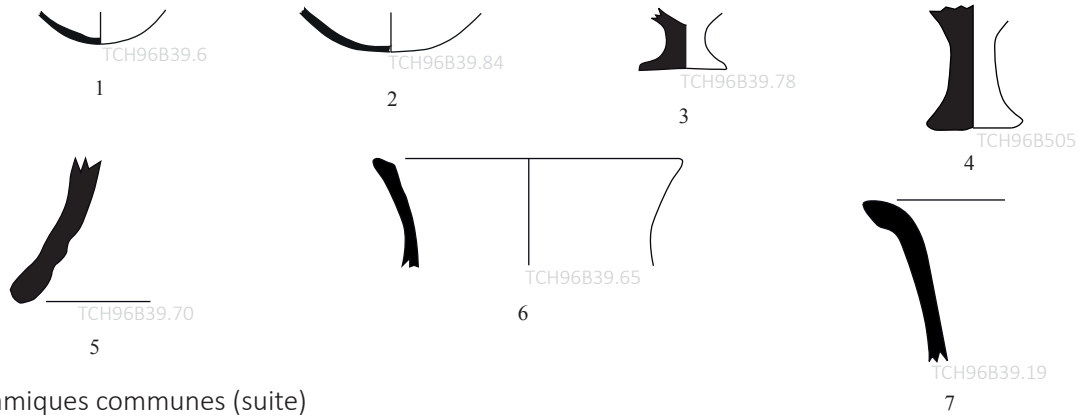

Céramiques communes (suite)

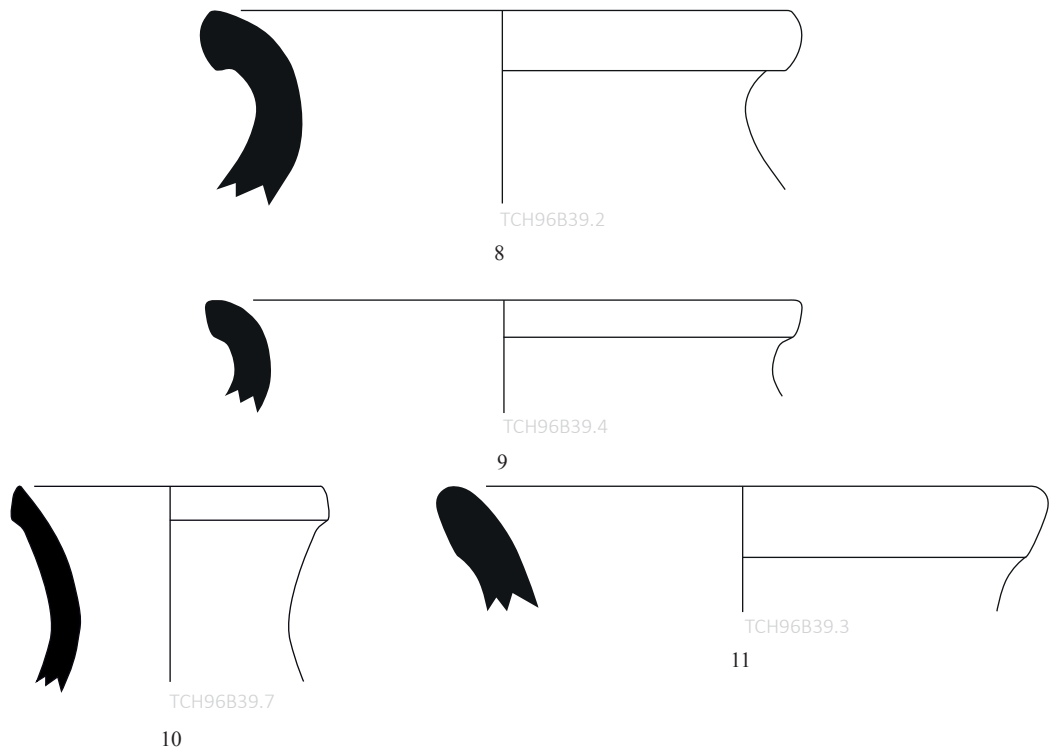

Céramiques à dégraissant végétal grossier (GV)

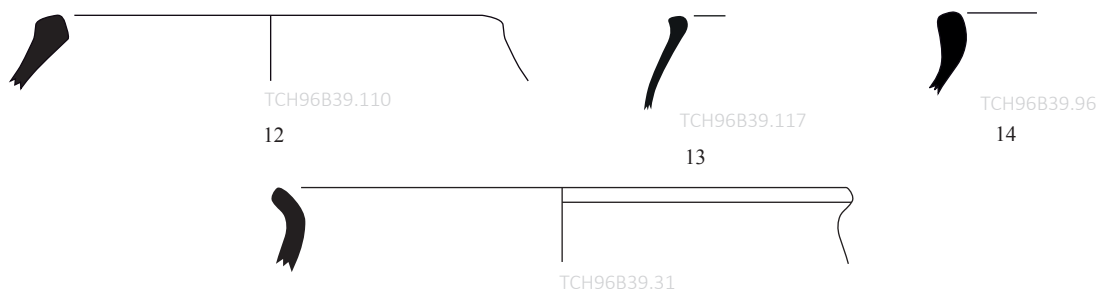

Céramiques à dégraissant minéral grossier (GM) <sup>15</sup>



Céramiques métalliques





TCH96B40

Couche cendreuse

		sw	gm	gv	mw	ew
NR	<b>494</b>	444	4	44	2	
NMI	<b>93</b>	82	5	5	1	
DIA	<b>96</b>	85	5	5	1	

n°	IDpoterie	locus	forme	céra.	façonnage		décor	cui.	« marque »	
					MT	S			type	position
1	TCH96B40.13	96B40	bol 01 A a	SW01			pseudo-engobe (VO)	A5		
2	TCH96B40.81	96B40	bol 01 A b	SW01				A5		
3	TCH96B40.69	96B40	bol 01 A e	nd – SW				A5		
4	TCH96B501	96B40	bol 01 A e	SW01			pseudo-engobe (VO)	A5		
5	TCH96B40.20	96B40	bol 01 B a	SW07				A2		
6	TCH96B40.4	96B40	bol 01 B b	nd – SW				A2		
7	TCH96B40.71	96B40	bol 01 C b	SW02				A5		
8	TCH96B40.83	96B40	bol 01 C b	nd – SW				A1		
9	TCH96B40.61	96B40	bol 01 C c	SW01				A5		
10	TCH96B40.26	96B40	bol 01 C c	SW01			pseudo-engobe (VO)	A5		
11	TCH96B40.93	96B40	bol 01 C c	SW02			pseudo-engobe (VO)	A5		
12	TCH96B40.2	96B40	bol 02 A a	SW07				A2		
n.i.	TCH96B40.85	96B40	bol 02 B a	nd – SW			engobe	A3		
13	TCH96B40.90	96B40	bol 02 B a	SW01				B		
14	TCH96B40.18	96B40	bol 02 A d	SW02				A5		
15	TCH96B40.9	96B40	bol 02 B c	SW01				A5		
16	TCH96B130	96B40	bol 02 B b	SW07			pseudo-engobe (VO)	A5		
17	TCH96B40.58	96B40	bol 02 C d	SW07				A5		
18	TCH96B40.23	96B40	bol 03 A i	SW01a				A5		
19	TCH96B40.19	96B40	bol 03 A i	SW01				A5		
20	TCH96B40.25	96B40	bol 03 A n	SW01				A1		
21	TCH96B40.32	96B40	bol 03 A n	SW07				A5		
22	TCH96B40.60	96B40	bol 03 B i	nd - Surcuit				A5		
23	TCH96B40.46	96B40	bol 03 B i	SW01				A4		
24	TCH96B40.55	96B40	bol 03 B i	SW01				A5		
25	TCH96B40.48	96B40	bol 03 B i	SW01			pseudo-engobe (VO)	A5		
26	TCH96B40.1	96B40	bol 03 B i	SW01b				B		
27	TCH96B40.47	96B40	bol 03 B i	SW02				A5		
28	TCH96B40.42	96B40	bol 03 B i	SW02				A5		
n.i.	TCH96B40.95	96B40	bol 03 B n	SW04				A3		
29	TCH96B40.67	96B40	bol 03 B n	SW14				A5		
30	TCH96B40.63	96B40	bol 03 C i	nd – SW			pseudo-engobe (VO)	A2		
31	TCH96B40.91	96B40	bol 03 C i	SW01				A3		
32	TCH96B40.66	96B40	bol 03 C i	SW01				A5		
33	TCH96B40.27	96B40	bol 03 C i	SW02			pseudo-engobe (VO)	A5		
34	TCH96B40.62	96B40	bol 04 C q	SW04				A3		

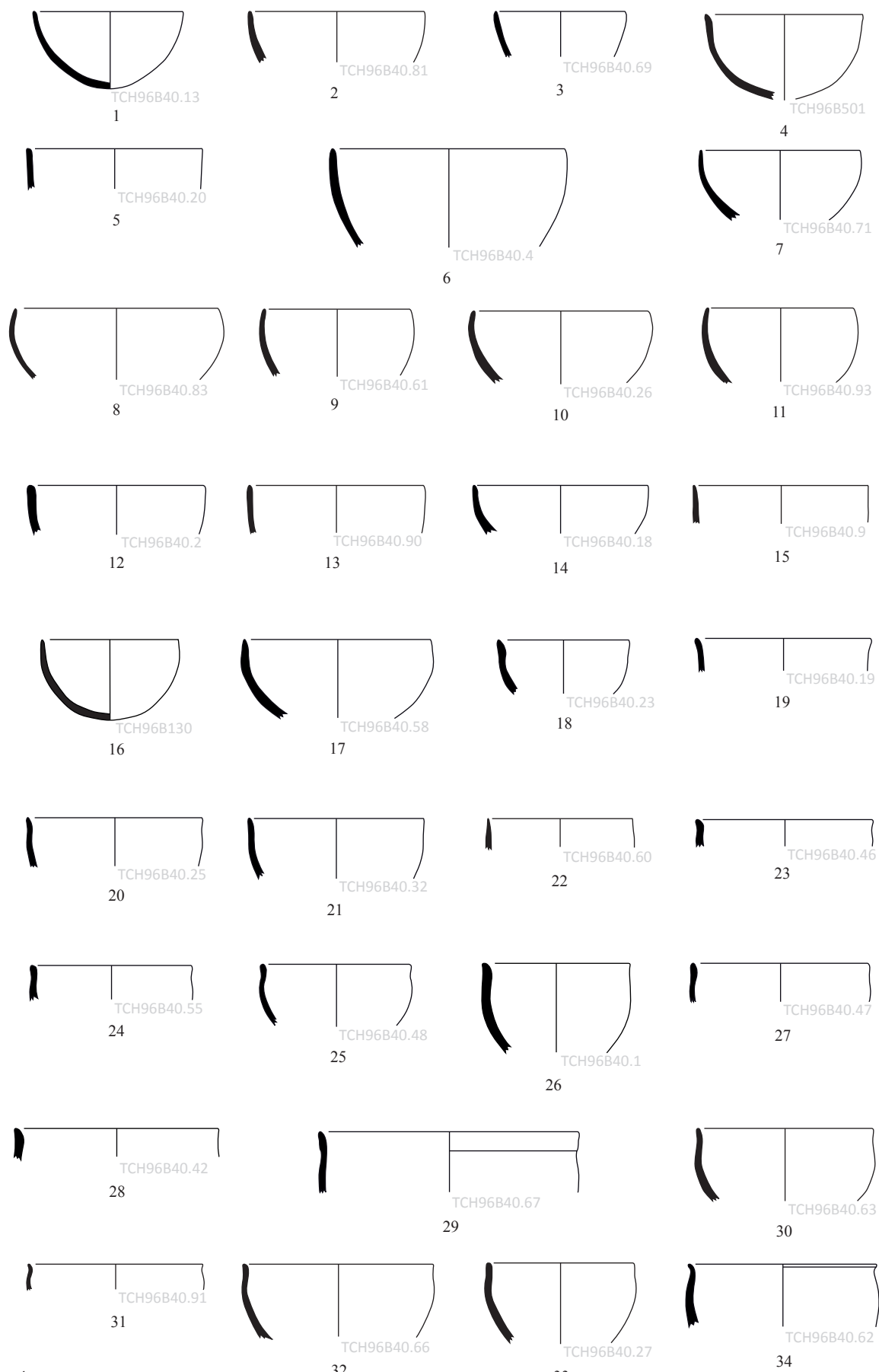

Céramiques communes



n°	IDpoterie	locus	forme	céra.	façonnage		décor	cui.	« marque »	
					MT	S			type	position
1	TCH96B40.89	96B40	bol 05 B g	SW01				A5		
2	TCH96B40.17	96B40	bol 05 B g	SW07				A1		
3	TCH96B40.64	96B40	bol 05 B j	SW01				A5		
4	TCH96B40.79	96B40	bol 05 B l	SW02				A4		
5	TCH96B40.54	96B40	bol 05 B l	SW07			engobe	A2		
6	TCH96B40.15	96B40	bol 06 A l	SW02				A4		
7	TCH96B40.21	96B40	pot 03 o	SW04b				A2		
8	TCH96B40.30	96B40	pot 03 o	SW13				A5		
9	TCH96B40.50	96B40	pot 03 o	SW13				A5		
10	TCH96B40.73	96B40	pot 03 v	SW01				A3		
11	TCH96B40.72	96B40	pot 03 v	SW07				A5		
12	TCH96B40.75	96B40	pot 03 v	SW07b				A2		
13	TCH96B40.59	96B40	pot 03 v	SW10				A1		
14	TCH96B40.65	96B40	pot 03 v	SW13				A2		
n.i.	TCH96B40.43	96B40	pot 03 v	SW13				A5		
15	TCH96B40.53	96B40	pot 03 v	SW13			engobe	A2		



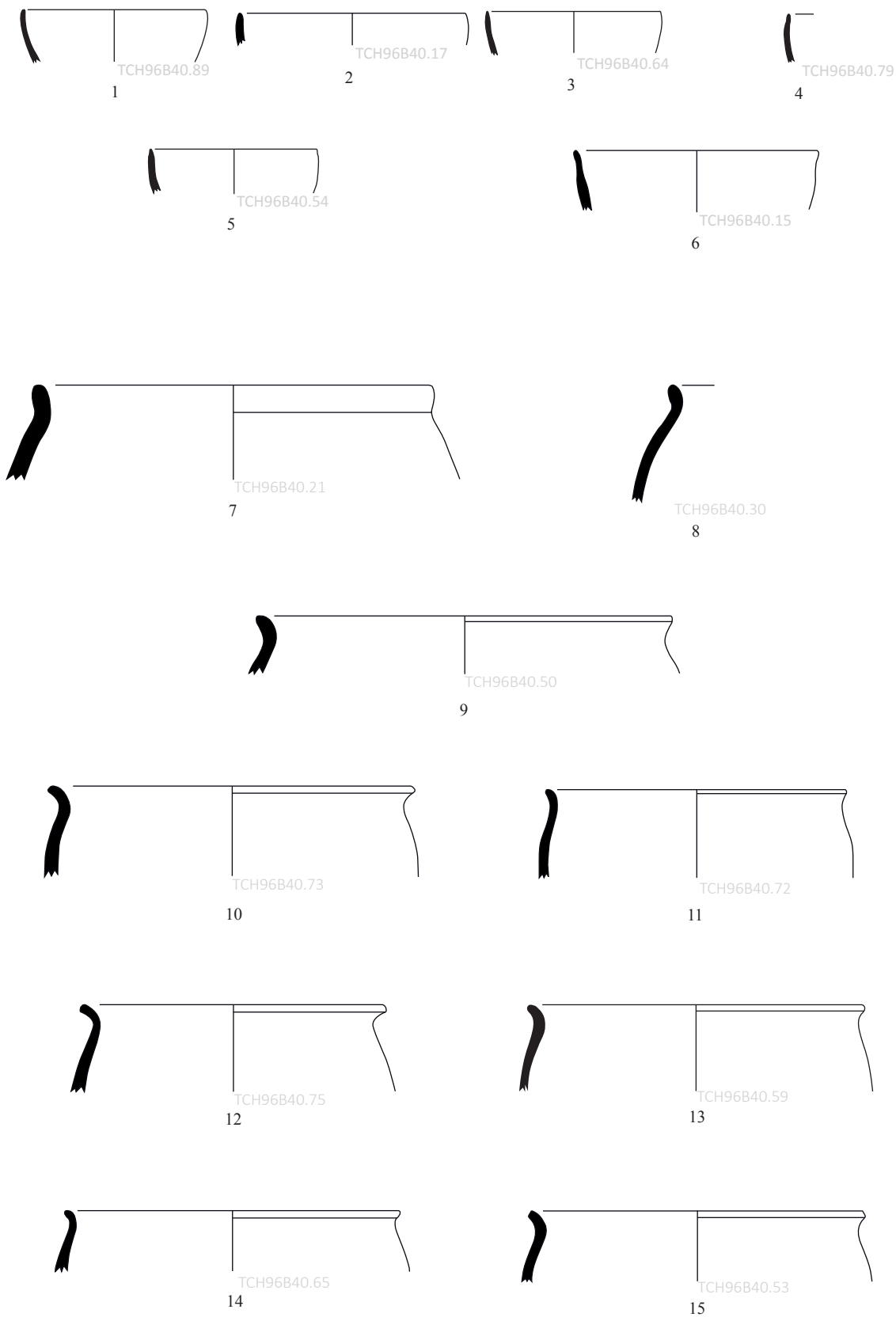

Céramiques communes (suite)



n°	IDpoterie	locus	forme	céra.	façonnage		décor	cui.	« marque »	
					MT	S			type	position
1	TCH96B40.78	96B40	pot 03 v	SW14				A5		
2	TCH96B40.77	96B40	pot 03 v	SW14				A5		
3	TCH96B40.45	96B40	pot 03 x	SW01				A5		
4	TCH96B40.70	96B40	pot 03 x	SW10			engobe	A2		
5	TCH96B40.74	96B40	pot 03 x	SW10			engobe	A2		
6	TCH96B40.51	96B40	pot 03 x	SW14				A5		
7	TCH96B40.0	96B40	base 1A	SW01				A5		
8	TCH96B40.24	96B40	base 1A	SW04				A2		
9	TCH96B40.10	96B40	base 6	SW13				A5		
10	TCH96B40.56	96B40	support ?	SW01			peinture sur engobe	A5		
11	TCH96B40.33	96B40	support ?	SW14				A5		
12	TCH96B40.12	96B40	Support ?	SW07				A5		
13	TCH96B40.57	96B40	support ?	SW13				A4		
14	TCH96B40.52	96B40	Support ?	SW13				A2		
15	TCH96B40.37	96B40	Support ?	SW04			pseudo-engobe	A1		
16	TCH96B40.22	96B40	Support ?	SW14				A3		
17	TCH96B40.11	96B40	support ?	SW13			engobe	A5		

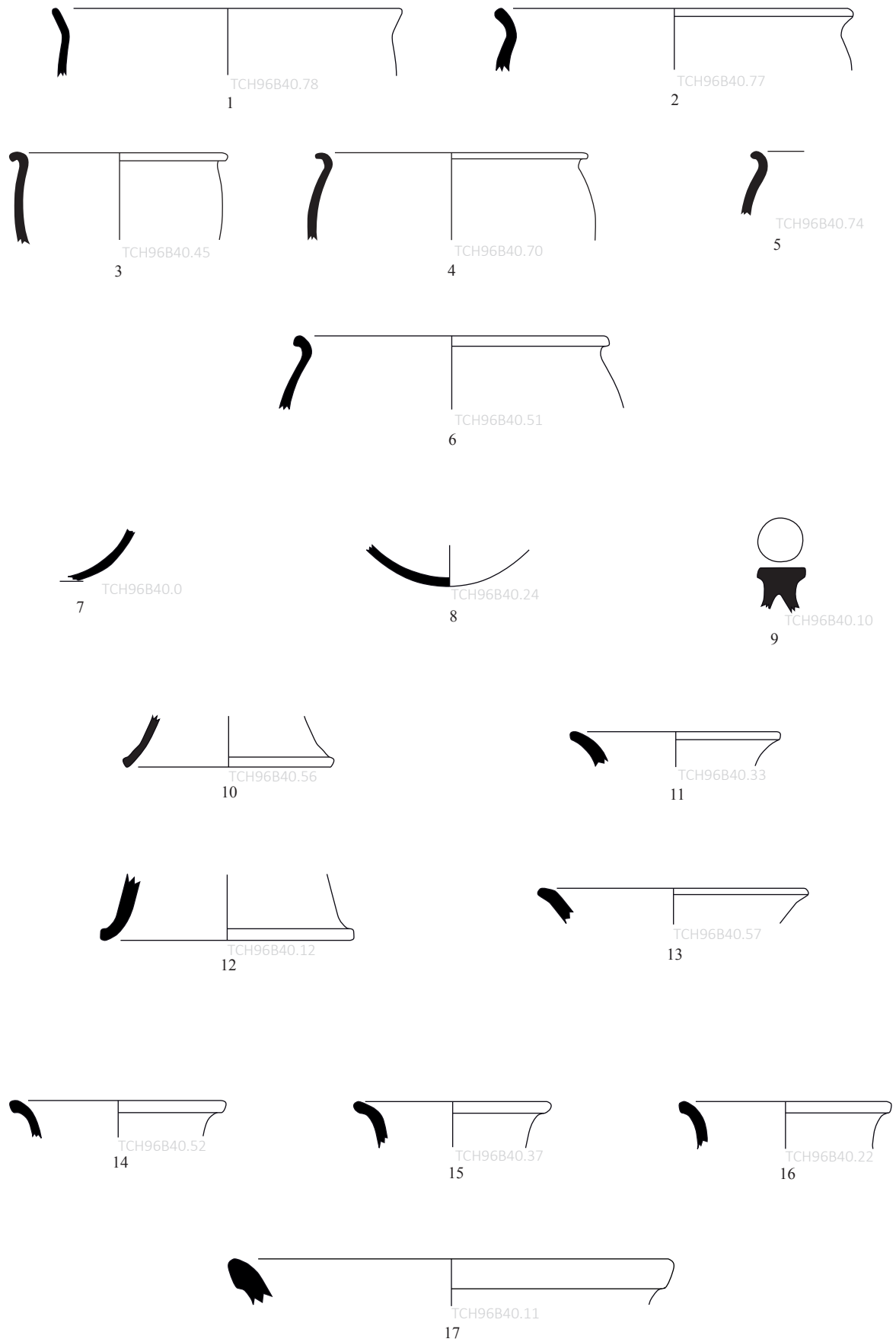

Céramiques communes (suite)



n°	IDpoterie	locus	forme	céra.	façonnage		décor	cui.	« marque »	
					MT	S			type	position
1	TCH96B40.28	96B40	petite jarre 02 B 06	SW07			engobe	A3		
2	TCH96B40.16	96B40	petite jarre 02 B 06	SW13			engobe	A5		
3	TCH96B40.35	96B40	petite jarre 02 B 06	SW07				A1		
4	TCH96B40.40	96B40	petite jarre 02 B 08	SW07			engobe	A2		
5	TCH96B40.38	96B40	jarre OE 02 A 26	SW13			engobe	A5		
6	TCH96B40.3	96B40	jarre OE 03 A 26	SW13				A5		
7	TCH96B40.86	96B40	jarre OE 02 B 25	SW13				A5		
8	TCH96B40.36	96B40	jarre OE 03 B 25	SW14				A5		
9	TCH96B40.84	96B40	jarre OE 03 B 23	SW13				A5		
10	TCH96B40.5	96B40	jarre OE 02 A 26	SW04			engobe	A5		
11	TCH96B40.29	96B40	jarre OL 02 B 08	nd – surcuit				A5		
12	TCH96B40.68	96B40	jarre OL 02 B 08	SW05				A5		
13	TCH96B40.31	96B40	jarre OL 02 B 16	SW07			pseudo-engobe	A2		
14	TCH96B40.39	96B40	jarre OL 02 B 16	SW13				A5		
15	TCH96B40.14	96B40	jarre OL 02 B 37	SW05				A1		
16	TCH96B40.44	96B40	jarre OL 02 D 20	SW13				A5		

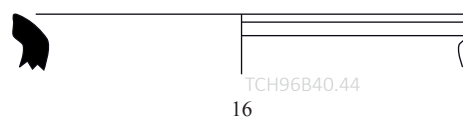
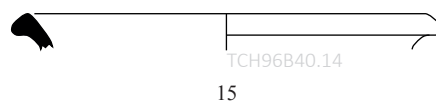
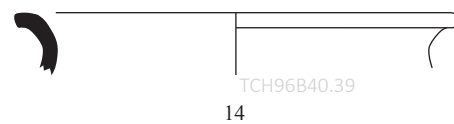
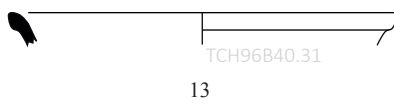
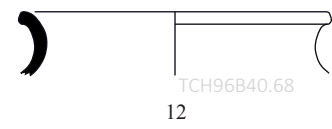
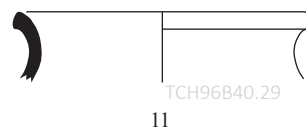
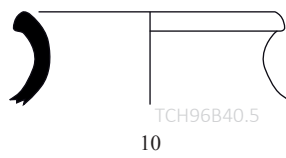
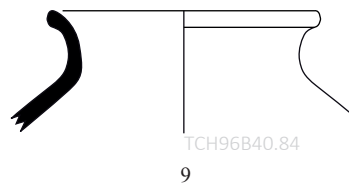
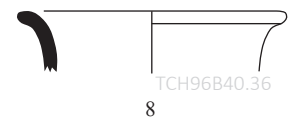
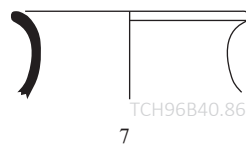
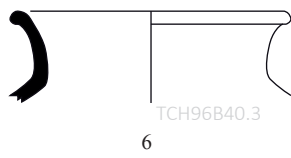
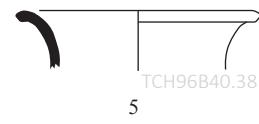
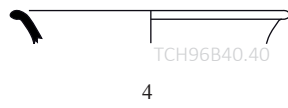
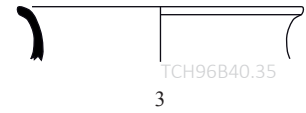
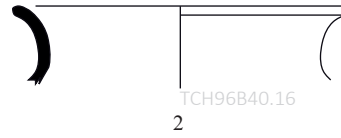
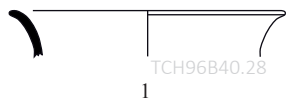

Céramiques communes (suite)



Catalogue 81

n°	IDpoterie	locus	forme	céra.	façonnage		décor	cui.	« marque »	
					MT	S			type	position
1	TCH96B40.76	96B40	jarre OL 02 D 17	GV				A5		
2	TCH96B40.94	96B40	jarre de stockage 02 54	GV				A5		
3	TCH96B40.8	96B40	jarre de stockage 02 54	GV				A2		
4	TCH96B40.97	96B40	jarre de stockage 02 53	GV				A2		
5	TCH96B40.92	96B40	jarre de stockage 02 53	GV				A2		
6	TCH96B40.7	96B40	marmite 02 A	GM				A5		
7	TCH96B40.41	96B40	marmite 02 B	GM				A2		
8	TCH96B40.6	96B40	marmite 02 B	GM				A5		
n.i.	TCH96B40.96	96B40	marmite 02 B	GM				A5		
9	TCH96B40.49	96B40	marmite 02 C	GM				A5		
10	TCH96B40.82	96B40	petite jarre 02 C 05	MW 8				A5		

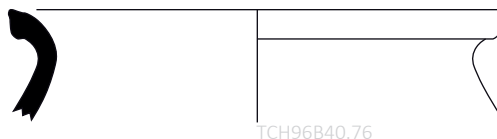

TCH96B40.76

1

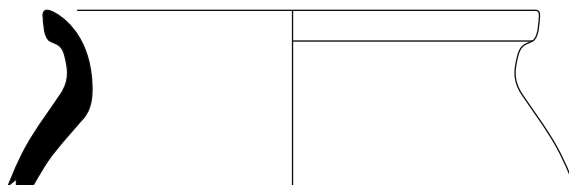

TCH96B40.94

2

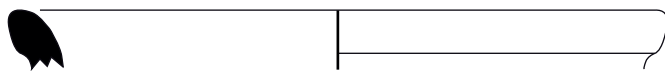

TCH96B40.8

3



TCH96B40.97

4



TCH96B40.92

5

Céramiques à dégraissant végétal grossier (GV)

---

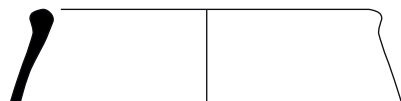

TCH96B40.7

6



TCH96B40.41

7



TCH96B40.6

8



TCH96B40.49

9

Céramiques à dégraissant minéral grossier (GM)

---

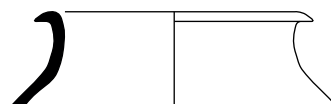

TCH96B40.82

10

Céramiques métalliques





TCH96B43

Démontage du mur et du comblement de l'espace R96B6

		sw	gm	gv	mw	ew
NR	<b>23</b>	17	1	5		
NMI	<b>7</b>	5	1	(1)		
DIA	<b>6</b>	5	1			

n°	IDpoterie	locus	forme	céra.	façonnage		décor	cui.	« marque »	
					MT	S			type	position
1	TCH96B43.4	96B43	bol 01 B d	nd – surcuit				A2		
2	TCH96B125	96B43	bol 01 C a	SW05			pseudo-engobe	A2		
3	TCH96B43.5	96B43	bol 06 A b	SW07				A5		
4	TCH96B43.2	96B43	pot 03 w	SW13				A5		
5	TCH96B43.1	96B43	support 04	SW07				A5		
6	TCH96B43.3	96B43	marmite 02 C	GM				A5		



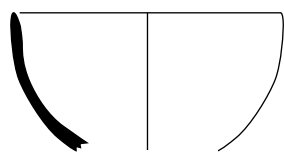

TCH96B43.4

1

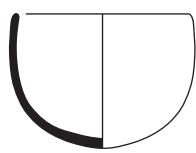

TCH96B125

2



TCH96B43.5

3

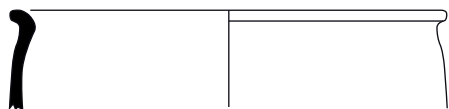

TCH96B43.2

4



TCH96B43.1

5

Céramiques communes

---



TCH96B43.3

6

Céramiques à dégraissant minéral grossier (GM)



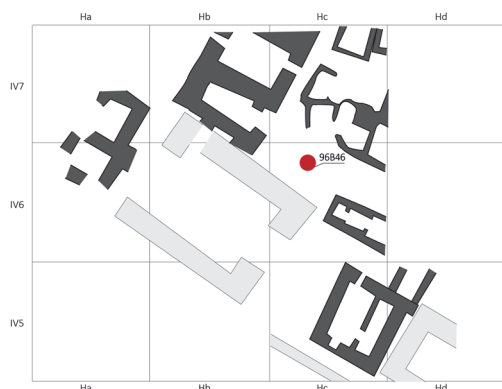

TCH96B46=TCH96B53

		sw	gm	gv	mw	ew
NR	<b>333</b>	283	13	21	16	
NMI	<b>90</b>	87	1	1	1	
DIA	<b>90</b>	87	1	1	1	

n°	IDpoterie	locus	forme	céra.	façonnage		décor	cui.	« marque »	
					MT	S			type	position
1	TCH96B102	96B46	bol bas 03 A i	SW07			pseudo-engobe (VO)	A2		
2	TCH96B46.70	96B46	bol bas 03 B i	SW02				A5		
n.i.	TCH96B101	96B46	bol ?	SW07				A5		
3	TCH96B518	96B46	bol 01 A a	SW05		5	pseudo-engobe (VO)	A5		
4	TCH96B46.69	96B46	bol 01 A b	SW07				A5		
5	TCH96B46.5	96B46	bol 01 A c	SW02		4		A5		
6	TCH96B46.76	96B46	bol 01 A e	SW01				A5		
7	TCH96B46.43	96B46	bol 01 A e	SW07				A5		
8	TCH96B104	96B46	bol 01 B b	SW07				A5		
9	TCH96B116	96B46	bol 01 B c	SW02				A5		
10	TCH96B46.62	96B46	bol 01 B e	SW01				A5		
11	TCH96B46.2	96B46	bol 01 B e	SW01				A5		
12	TCH96B99	96B46	bol 01 B e	SW01			pseudo-engobe	A5		
13	TCH96B97	96B46	bol 01 B e	SW02			pseudo-engobe (VO)	nd		
14	TCH96B46.11	96B46	bol 01 C b	SW01				A2		
15	TCH96B46.60	96B46	bol 01 C b	SW01				A5		
16	TCH96B46.71	96B46	bol 01 C b	SW07				A5		
17	TCH96B46.3	96B46	bol 01 C b	SW07				A5		
18	TCH96B46.45	96B46	bol 01 C c	SW01			pseudo-engobe (VO)	A5		
19	TCH96B96	96B46	bol 01 C c	SW07				A5		
20	TCH96B46.7	96B46	bol 01 C c	SW07				A5		
21	TCH96B46.16	96B46	bol 01 C c	SW07				A5		
22	TCH96B103a	96B46	bol 01 C s	nd – SW				A2		
23	TCH96B46.67	96B46	bol 02 A b	SW02				A5		
24	TCH96B46.22	96B46	bol 02 A b	SW07				A5		
25	TCH96B46.24	96B46	bol 02 A d	SW02				A5		
26	TCH96B46.75	96B46	bol 02 A e	SW01				A2		
27	TCH96B46.12	96B46	bol 02 B b	nd – SW			engobe	A5		
28	TCH96B46.78	96B46	bol 02 B b	SW01				A5		
n.i.	TCH96B504	96B46	bol 02 B b	SW05				A5		
29	TCH96B46.8	96B46	bol 02 B d	nd – SW				A5		
30	TCH96B115	96B46	bol 02 C c	SW07				A5		

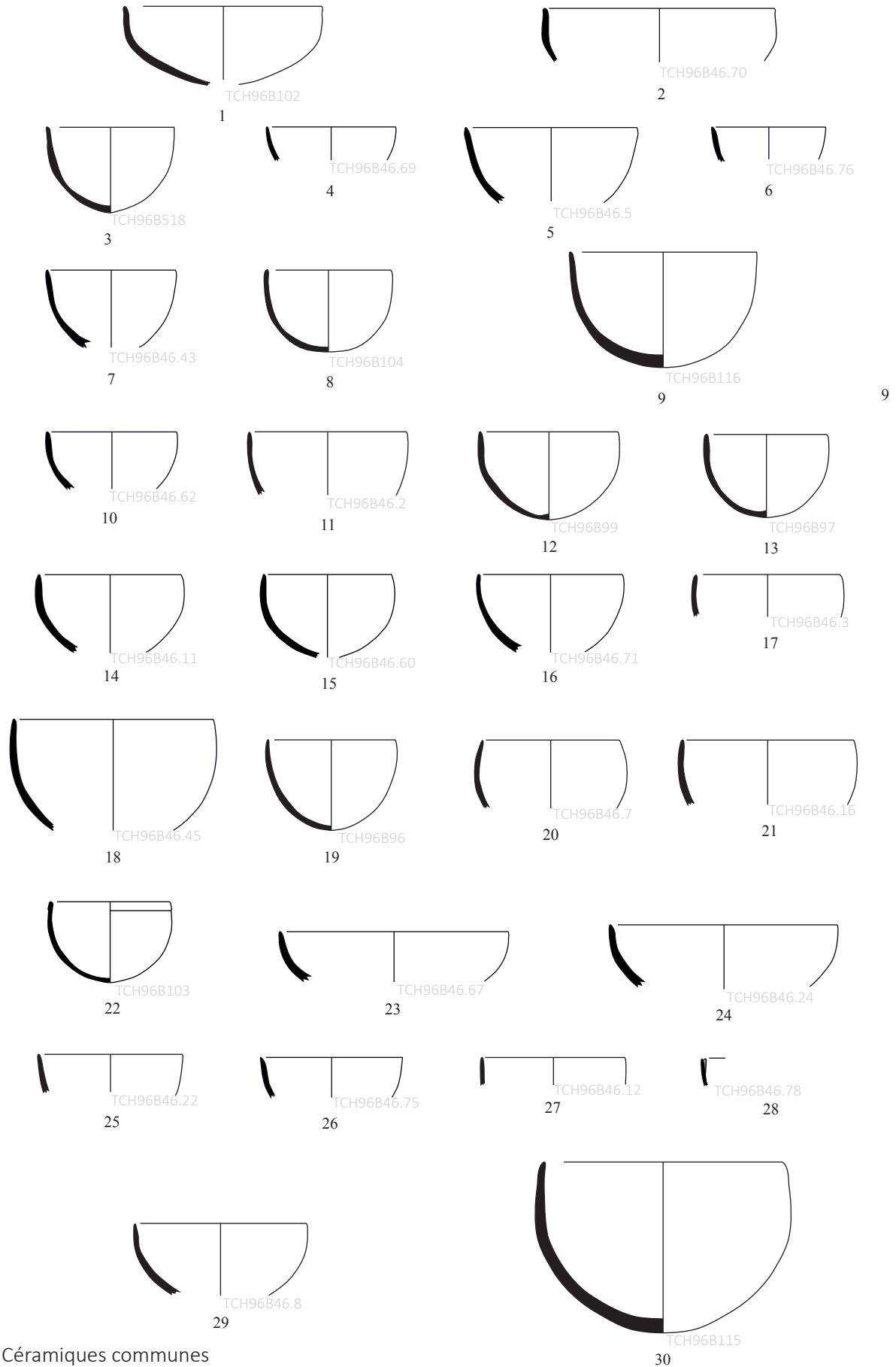

Céramiques communes



n°	IDpoterie	locus	forme	céra.	façonnage		décor	cui.	« marque »	
					MT	S			type	position
1	TCH96B46.32	96B46	bol 03 A i	SW01				A2		
2	TCH96B46.66	96B46	bol 03 B j	SW02				A5		
3	TCH96B46.10	96B46	bol 03 B j	SW02				A5		
4	TCH96B46.68	96B46	bol 03 C i	SW01			pseudo-engobe (VO)	A5		
5	TCH96B100a	96B46	bol 03 C n	SW02				A2		
6	TCH96B46.53	96B46	bol 04 C q	SW04				A4		
7	TCH96B46.23	96B46	bol 05 A g	SW02				A5		
8	TCH96B46.64	96B46	bol 05 A k	SW01				A5		
9	TCH96B46.1	96B46	bol 05 A k	SW01				A5		
10	TCH96B46.65	96B46	bol 05 B f	SW01				A5		
11	TCH96B46.18	96B46	bol 05 B g	SW01				A5		
12	TCH96B46.4	96B46	bol 05 B g	SW01				A5		
13	TCH96B46.15	96B46	bol 05 B g	SW01				A5		
14	TCH96B46.14	96B46	bol 05 B g	SW01			pseudo-engobe (VO)	A5		
15	TCH96B46.79	96B46	bol 05 B j	SW07				A1		
16	TCH96B46.63	96B46	bol 05 B l	SW07				A5		
17	TCH96B46.74	96B46	bol 06 A c	SW02				A5		
18	TCH96B46.13	96B46	bol 06 A g	SW02				A5		
19	TCH96B46.34	96B46	pot 03 A p	SW07				A5		
20	TCH96B46.19	96B46	pot 03 p	SW07				A5		
21	TCH96B46.58	96B46	pot 03 q	SW07				A5		
22	TCH96B46.21	96B46	pot 03 q	SW07				A5		
23	TCH96B46.57	96B46	pot 03 q	SW13				A3		
24	TCH96B46.56	96B46	pot 03 A v	SW04				A5		

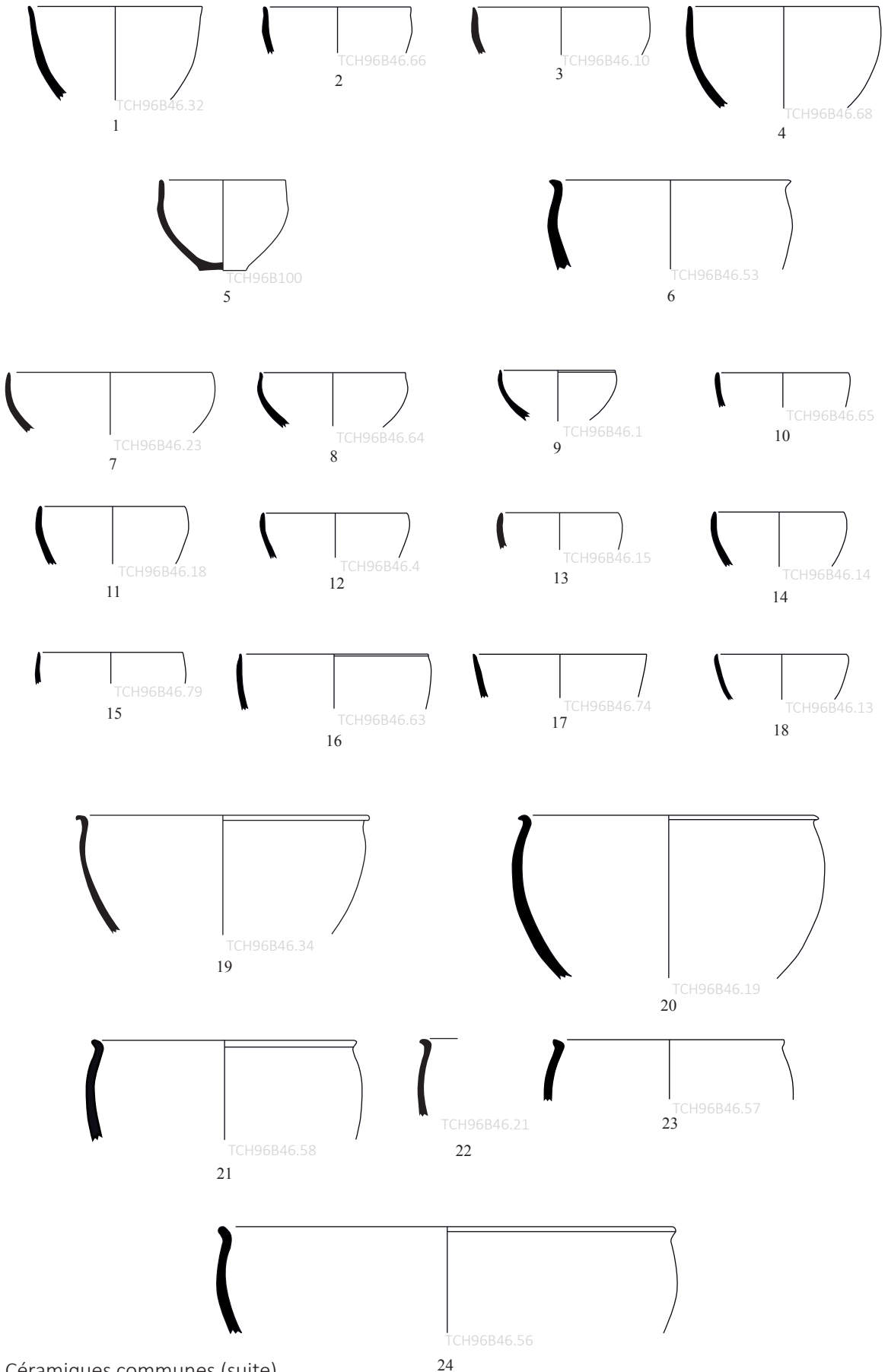

Céramiques communes (suite)



n°	IDpoterie	locus	forme	céra.	façonnage		décor	cui.	« marque »	
					MT	S			type	position
1	TCH96B112	96B46	pot 03 q	SW07	IB-III12			A5		
2	TCH96B46.59	96B46	pot 03 u	SW13				A5		
3	TCH96B136	96B46	pot 03 A w	SW10				A2		
4	TCH96B46.55	96B46	pot 03 w	SW13				A5		
5	TCH96B46.36	96B46	pot 03 x	SW13				A5		
6	TCH96B113	96B46	petite jarre 02 B 01	SW01				A5		
7	TCH96B46.46	96B46	petite jarre 02 B 01	SW07				A5		
8	TCH96B46.27	96B46	petite jarre 02 B 01	SW07				A5		
9	TCH96B46.31	96B46	petite jarre 02 B 11	SW07				A1		
10	TCH96B46.50	96B46	petite jarre 02 B 13	SW07				A5		
11	TCH96B46.6	96B46	petite jarre 02 B 13	SW07				A5		
12	TCH96B46.37	96B46	petite jarre 02 D 01	SW01				A5		

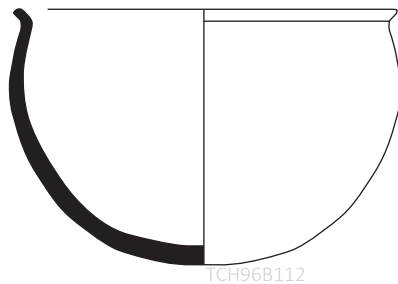

1

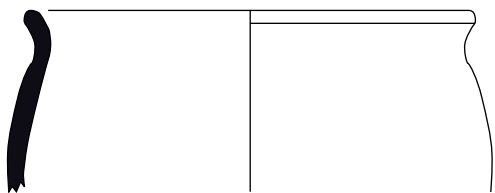

2

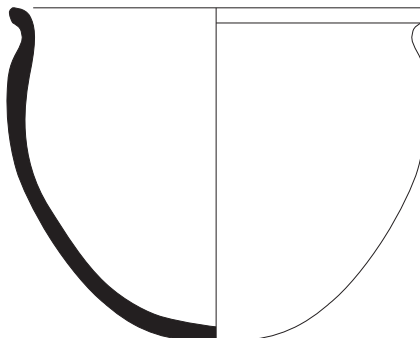

3

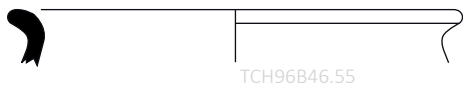

4

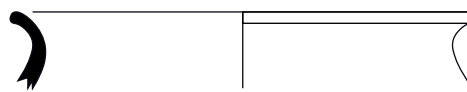

5

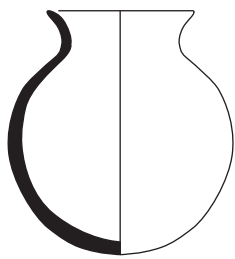

6



7



8

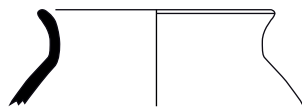

9



10

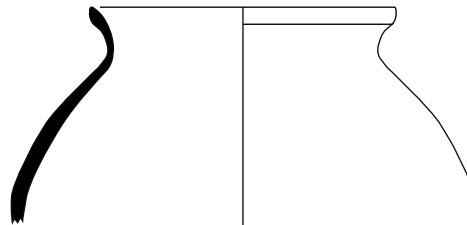

11

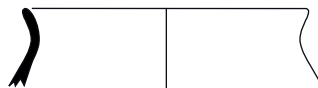

12

Céramiques communes (suite)



n°	IDpoterie	locus	forme	céra.	façonnage		décor	cui.	« marque »	
					MT	S			type	position
1	TCH96B46.77	96B46	petite jarre 03 A 01	SW02				A5		
2	TCH96B46.41	96B46	petite jarre 03 D 02	SW01				A2		
3	TCH96B46.42	96B46	petite jarre 03 D 02	SW01				A2		
4	TCH96B46.20	96B46	vase miniature 06 G	SW01				A5		
5	TCH96B46.40	96B46	petite jarre 03 A 03	SW01				A5		
6	TCH96B46.48	96B46	petite jarre 03 B 05	SW01				A1		
7	TCH96B46.49	96B46	petite jarre 03 B 28	SW04				A5		
8	TCH96B46.39	96B46	jarre OE 02 A 26	SW05				A3		
9	TCH96B46.44	96B46	jarre OE 03 B 25	SW04				A1		
10	TCH96B46.38	96B46	jarre OL 02 B 19	nd – surcuit				A5		
11	TCH96B46.30	96B46	jarre OL 02 B 16	SW07			engobe	A5		
12	TCH96B46.54	96B46	jarre OL 02 B 16	SW13				A5		
13	TCH96B46.52	96B46	jarre OL 02 B 16	SW13				A5		
14	TCH96B46.47	96B46	jarre OL 02 B 16	SW14				A5		



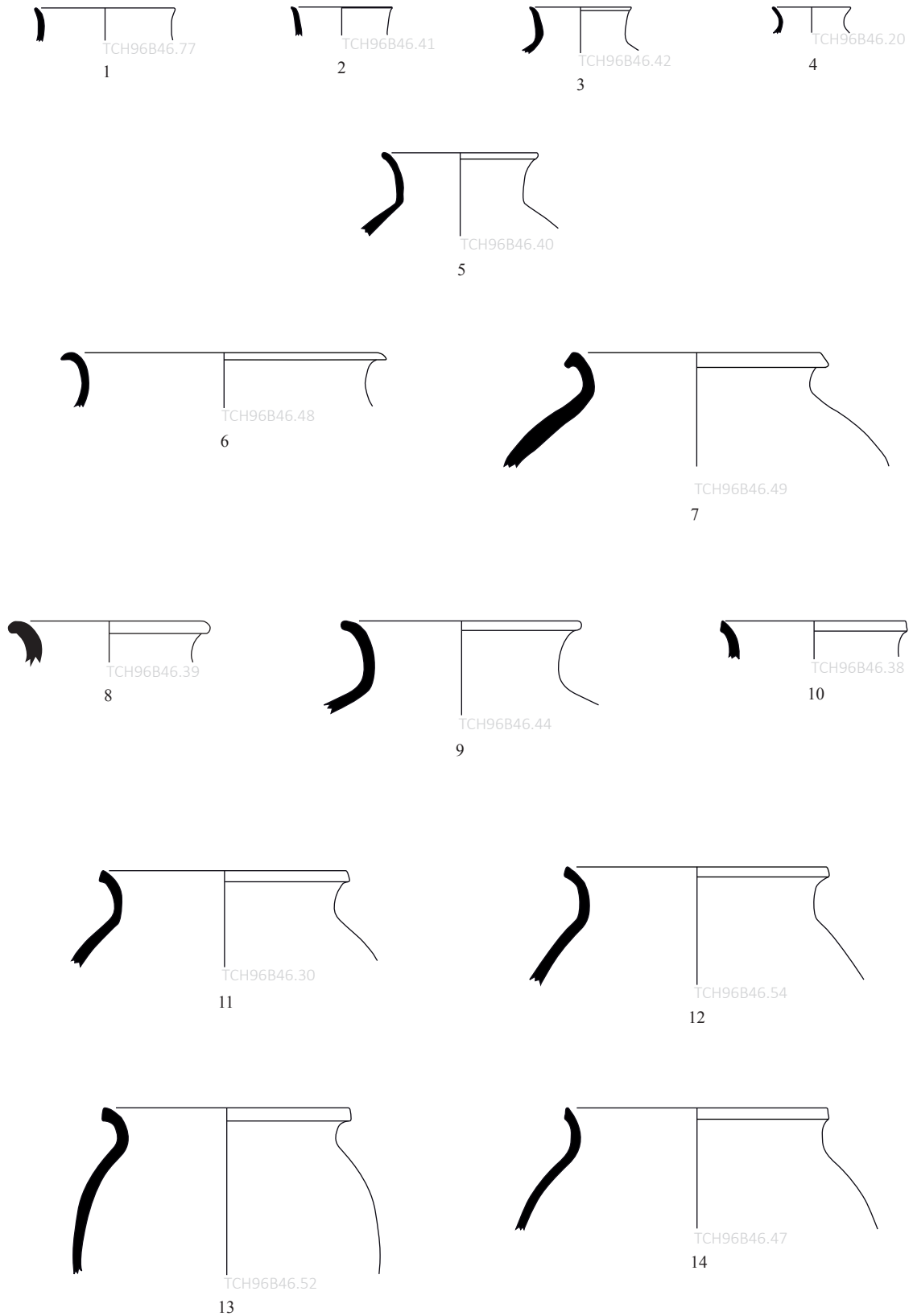

Céramiques communes (suite)



Catalogue 87

n°	IDpoterie	locus	forme	céra.	façonnage		décor	cui.	« marque »	
					MT	S			type	position
1	TCH96B46.51	96B46	jarre OL 03 B 42	SW05				A4		
2	TCH96B46.9	96B46	jarre OL 03 B 42	SW05				A3		
3	TCH96B46.29	96B46	panse	SW01			peinture	A5		
4	TCH96B46.33	96B46	panse	SW13			peinture	A5		
5	TCH96B114	96B46	base 1A	SW14			peinture sur engobe	A5		
6	TCH96B46.28	96B46	base 2	SW07				A5		
7	TCH96B46.61	96B46	pot 03 m	GV				A5		
8	TCH96B46.17	96B46	petite jarre 04 07	MW ?				A5		

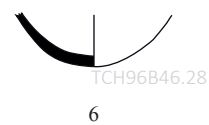
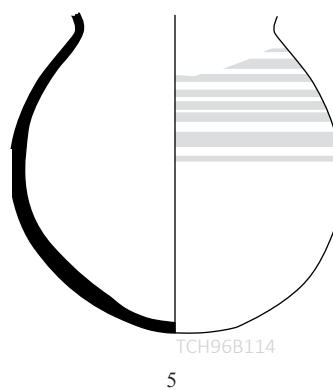
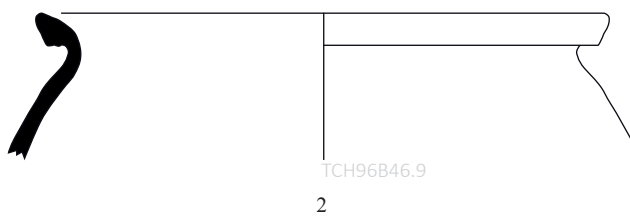
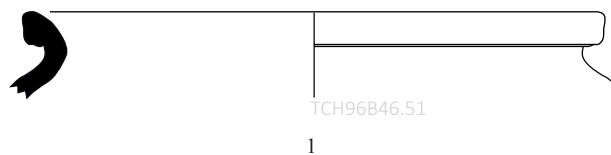

Céramiques communes

---

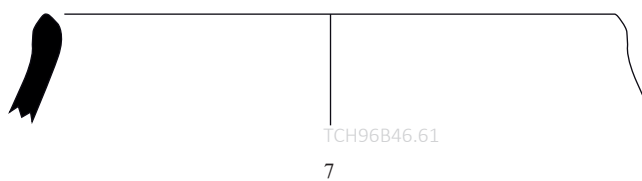

Céramiques à dégraissant végétal grossier

---

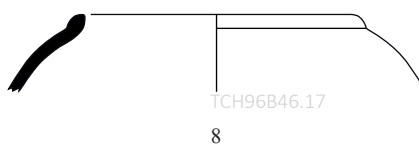

Céramiques métalliques





TCH96B47

		sw	gm	gv	mw	ew
NR	<b>226</b>	198	24	4		2
NMI	<b>16</b>	10	3	1	1	(1)
DIA	<b>15</b>	10	3	1	1	

n°	IDpoterie	locus	forme	céra.	façonnage		décor	cui.	« marque »	
					MT	S			type	position
1	TCH96B47.6	96B47	bol 01 B a	SW01			pseudo-engobe (VO)	A1		
2	TCH96B94	96B47	bol 03 B i	SW02				A1		
3	TCH96B111	96B47	vase miniature 04	SW04			pseudo-engobe (VO)	A5		
4	TCH96B47.11	96B47	pot 03 v	SW07				A5		
5	TCH96B47.10	96B47	pot 03 v	SW14				A3		
6	TCH96B47.12	96B47	pot 03 y	SW07				A5		
7	TCH96B110	96B47	petite jarre 02 D 14	SW13			peinture	A2		
8	TCH96B47.3	96B47	jarre OE 02 A 26	SW13				A5		
9	TCH96B47.7	96B47	jarre OL 02 B 37	SW05				A3		
10	TCH96B47.1	96B47	jarre OL 02 B 19	GV				A5		
11	TCH96B47.8	96B47	jarre OL 02 D 19	nd				A5		
12	TCH96B47.5	96B47	marmite 02 A	GM				A5		
13	TCH96B47.4	96B47	marmite 02 A	GM				A5		
14	TCH96B47.2	96B47	marmite 02 A	GM				A4		
15	TCH96B93	96B47	petite jarre 02 F 05	MW 8				A2		

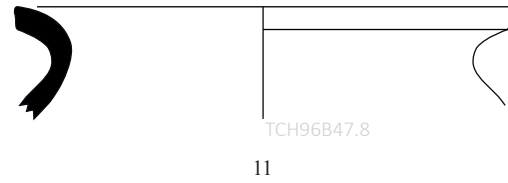
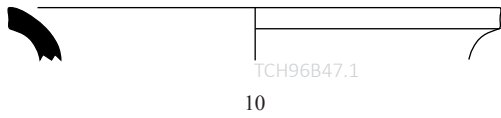
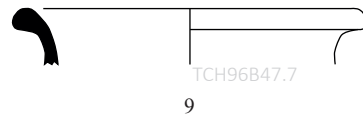
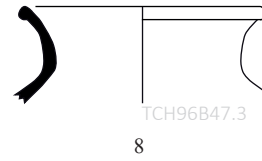
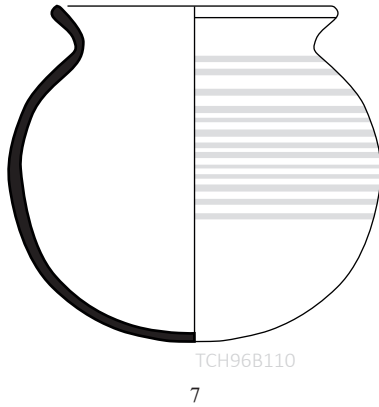
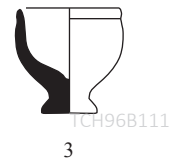
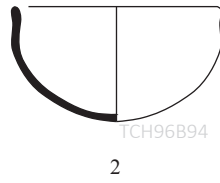
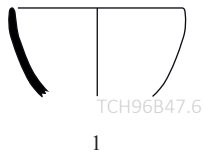

Céramiques communes

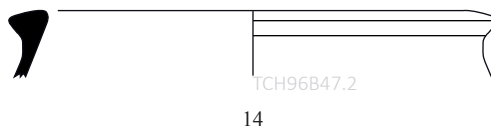
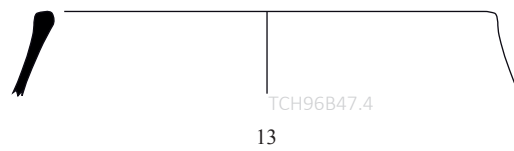

Céramiques à dégraissant minéral grossier (GM)

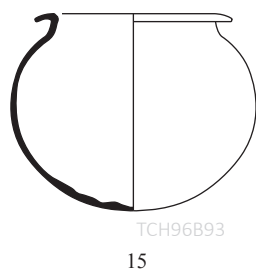

Céramiques métalliques





TCH96B53=TCH96B46

\_\_\_\_\_ sw gm gv mw ew  
 NR /  
 NMI 1 1  
 DIA 1 1

n°	IDpoterie	locus	forme	céra.	façonnage		décor	cui.	« marque »	
					MT	S			type	position
1	TCH96B127	96B53	bol 02 A c	SW02				A5		

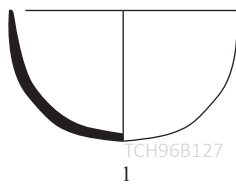

Céramiques communes





TCH98B30

Couche cendreuse

		sw	gm	gv	mw	ew
NR	<b>127</b>	121	2	4		
NMI	<b>39</b>	36	1	2		
DIA	<b>44</b>	41	1	2		

n°	IDpoterie	locus	forme	céra.	façonnage		décor	cui.	« marque »	
					MT	S			type	position
1	TCH98B30.28	98B30	bol 01 B b	SW02	IB-IIB-III25			A2		
2	TCH98B30.26	98B30	bol 01 B c	SW02	III25	4	pseudo-engobe (VO)	A5		
3	TCH98B30.29	98B30	bol 01 C b	SW01	IB-III2			A2		
4	TCH98B30.27	98B30	bol 01 C b	SW01	III12		pseudo-engobe (VO)	A5		
5	TCH98B30.30	98B30	bol 01 C c	SW01	IB-IIB-III25	4		A5		
6	TCH98B30.33	98B30	bol 02 B a	SW01	IB-IIB-III2			A5		
7	TCH98B30.45	98B30	bol 03 A i	SW02	IB-IIB-III2			A5		
8	TCH98B30.38	98B30	bol 03 B i	SW02	IB-IIB-III12	4	pseudo-engobe	A5		
9	TCH98B30.32	98B30	bol 04 C q	SW01	IIB-III2			A5		
10	TCH98B30.50	98B30	bol 04 C q	SW01				A5		
11	TCH98B30.41	98B30	bol 05 B g	SW02	IB-IIB-III2		pseudo-engobe	A5		
12	TCH98B30.22	98B30	pot 03 v	SW04	IB-IIB-III2			A2		
13	TCH98B30.12	98B30	support 04	SW04	IB-III2b			A5		
14	TCH98B30.36	98B30	support ?	SW13				A5		
15	TCH98B30.17	98B30	petite jarre 02 B 13	SW01	III2b			A3		
16	TCH98B30.20	98B30	petite jarre 02 D 12	SW04				A5		
17	TCH98B30.35	98B30	petite jarre 02 D 14	SW01				A5		
18	TCH98B30.11	98B30	petite jarre 02 D 14	SW01	IB-III2			A5		
19	TCH98B30.55	98B30	vase à tubulaire goulot	SW02	IB			A5		
n.i.	TCH98B30.39	98B30	jarre	SW26				A5		
20	TCH98B30.21	98B30	jarre 03 B	nd – surcuit				A5		
21	TCH98B30.40	98B30	jarre OE 02 A 25	SW13	IB-III2		engobe	A5		
22	TCH98B30.23	98B30	jarre OE 02 A 26	SW04				A5		
23	TCH98B30.19	98B30	jarre OE 02 B 25	SW13	IB-IIB-III2			A5		
24	TCH98B30.13	98B30	jarre OE 02 B 25	SW14	IB-IIB-III2			A5		
25	TCH98B30.24	98B30	jarre OE 02 B 26	SW14				A5		



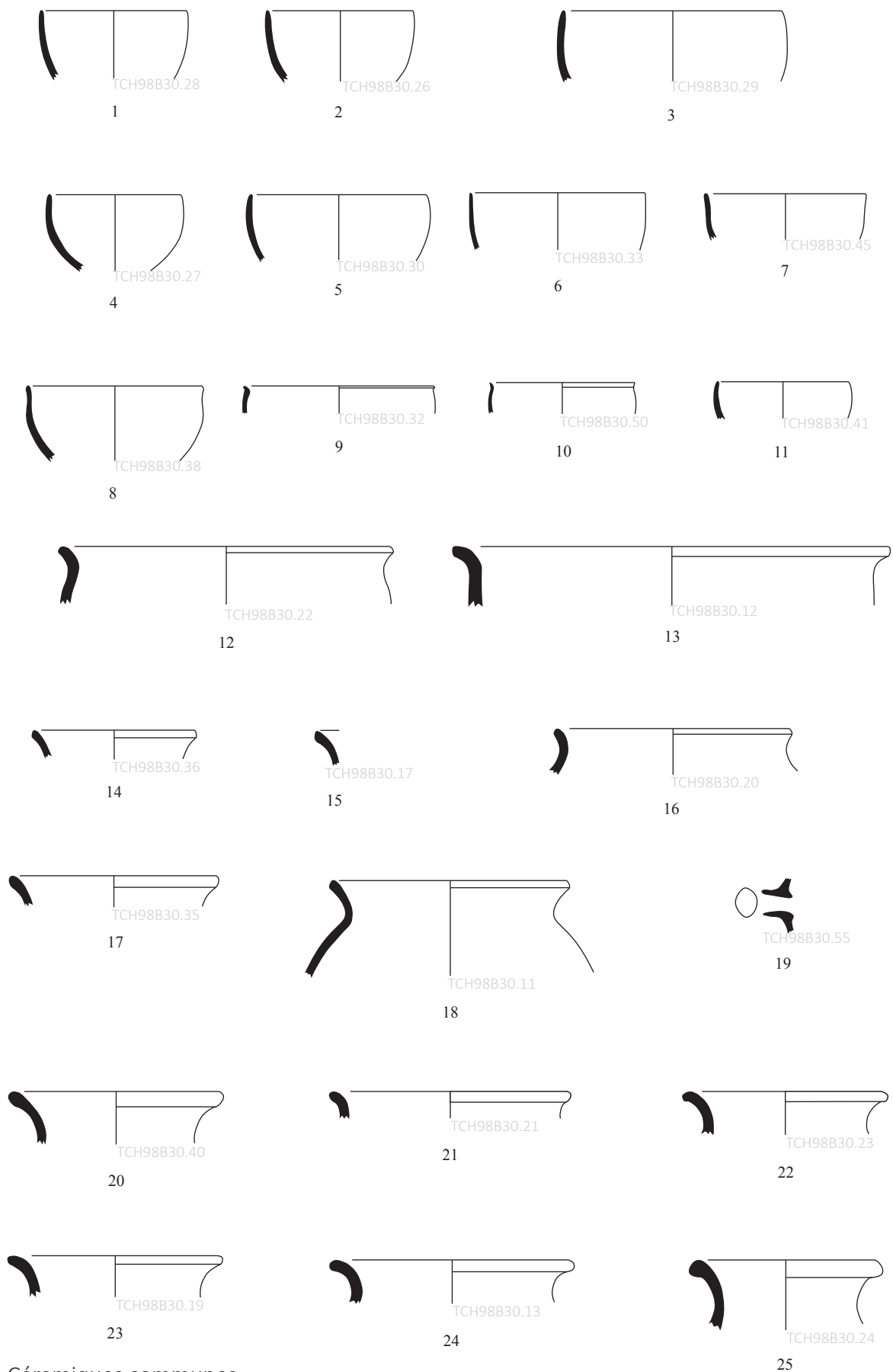

Céramiques communes



n°	IDpoterie	locus	forme	céra.	façonnage		décor	cui.	« marque »	
					MT	S			type	position
1	TCH98B30.10	98B30	jarre OL 02 D 21	nd	IB			A1		
2	TCH98B30.15	98B30	jarre OL 02 D 21	SW13	III2			A5		
3	TCH98B30.14	98B30	jarre OL 02 D 21	SW13	III2		engobe	A5		
4	TCH98B30.18	98B30	jarre OL 02 D 21	SW13	III2b			A5		
5	TCH98B30.7	98B30	jarre OL 02 D 21	SW13	III2b			A5		
6	TCH98B30.6	98B30	jarre OL 02 D 21	SW14	III2			A5		
7	TCH98B30.8	98B30	jarre OL 03 B 37	SW05	IB-IIIB			A5		
8	TCH98B30.4	98B30	jarre OL 03 B 43	SW26	IB-III2b			A5		
9	TCH98B30.5	98B30	jarre OL 03 B 44	SW26	III2			A5		
10	TCH98B30.37	98B30	base 3A	SW02	IB2-IIIB-III4b	5		A5		
11	TCH98B30.1	98B30	base 3B	SW02	IB2-IIIB-III4	5		A5		
12	TCH98B30.34	98B30	base 3B	SW07	IB-IIIB		engobe	A5		
13	TCH98B30.25	98B30	support 05	nd – surcuit			engobe	A5		
14	TCH98B30.16	98B30	support 05	SW01	III2			A5		
15	TCH98B30.31	98B30	vase miniature 06 E	SW01	III2			A5		

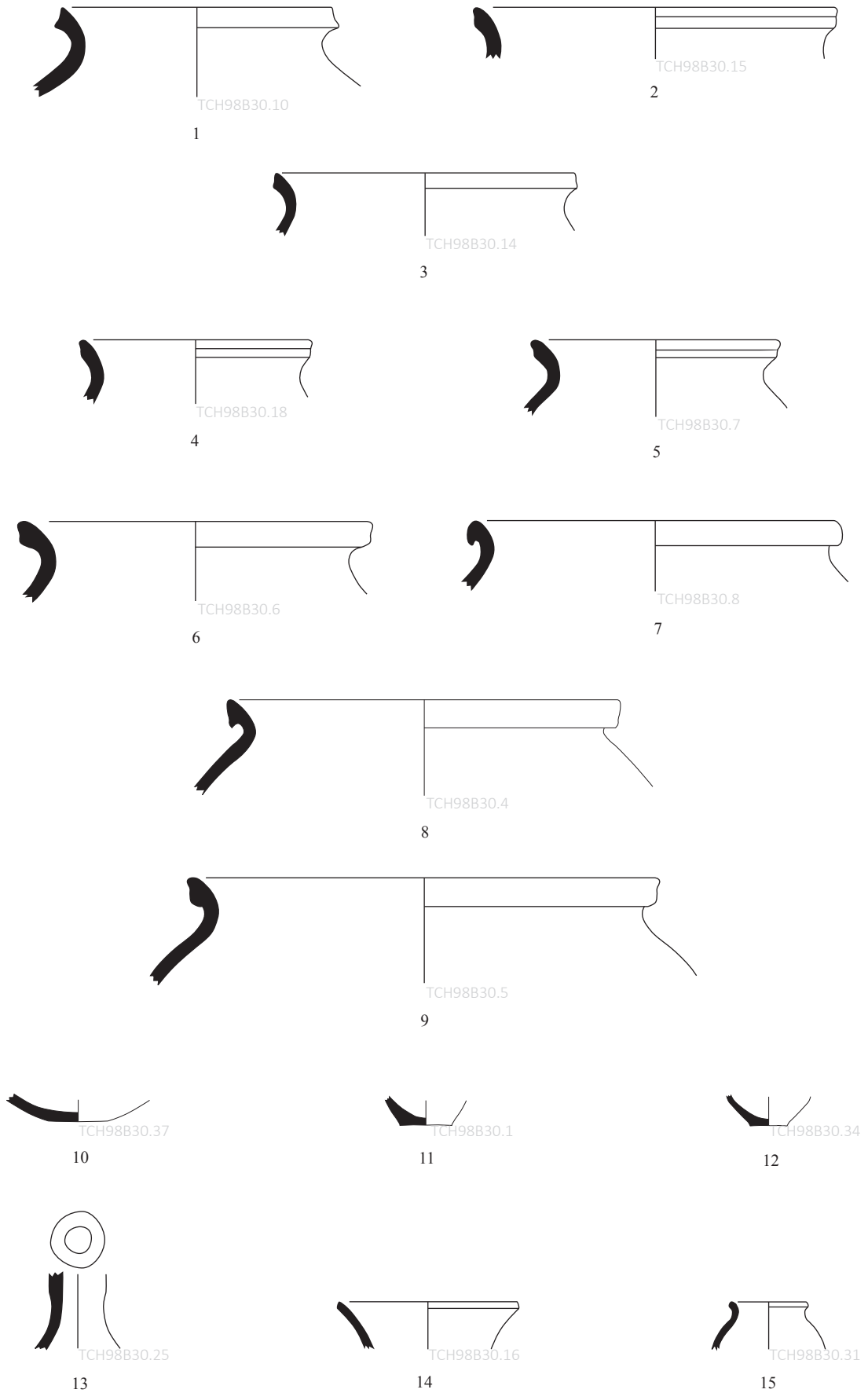

Céramiques communes (suite)



Catalogue 92

n°	IDpoterie	locus	forme	céra.	façonnage		décor	cui.	« marque »	
					MT	S			type	position
1	TCH98B30.3	98B30	pot 01 a	GV	IB-IIA-III1	2		A2		
2	TCH98B30.2	98B30	grande jarre	GV	IB			A2		
3	TCH98B30.9	98B30	marmite 02 B	GM	IB-IIA-III6b	3		B 2-		

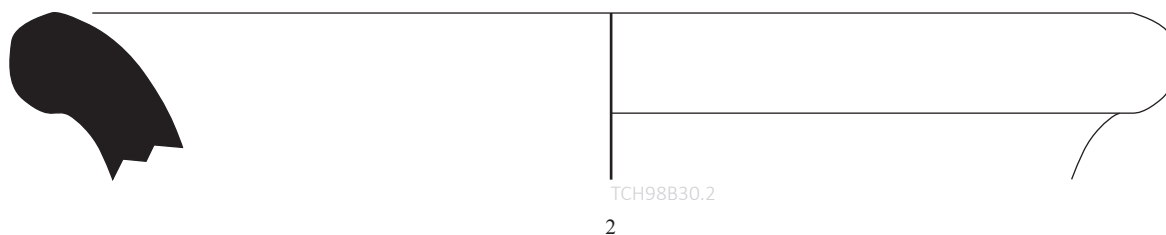

Céramiques à dégraissant végétal grossier (GV)

---

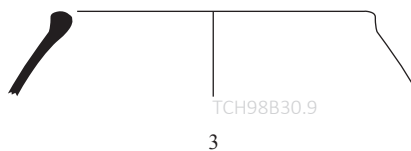

Céramiques à dégraissant minéral grossier (GM)





TCH99B33

Cailloutis à l'entrée de l'espace R5

		sw	gm	gv	mw	ew
NR	<b>13</b>	4		9		
NMI	<b>4</b>	3		1		
DIA	<b>4</b>	3		1		

n°	IDpoterie	locus	forme	céra.	façonnage		décor	cui.	« marque »	
					MT	S			type	position
1	TCH99B33.1	99B33	bol 05 A g	SW01	III2b		pseudo-engobe (VO)	A5		
2	TCH99B33.4	99B33	base 6	SW01	III2	4		A5		
3	TCH99B33.2	99B33	jarre OL 02 D 20	SW14	IB-III2			A5		
4	TCH99B33.3	99B33	jarre OL 02 D 17	GV	IB-III2b			A5		

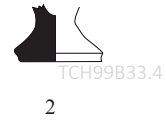
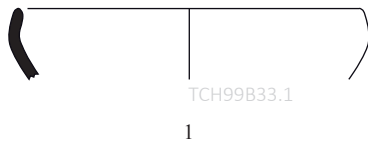

Céramiques communes

---

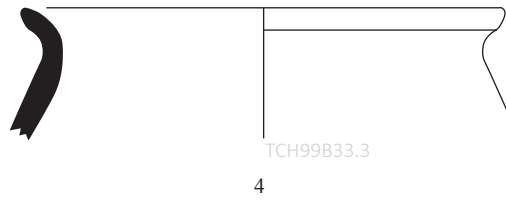

Céramiques à dégraissant végétal grossier (GV)





TCH.B6039

Cendre, brique fondue et morceaux de briques. Traces de l'incendie au nord du M204, remblai R206.

		sw	gm	gv	mw	ew
NR	<b>200</b>	117	69	14		
NMI	<b>30</b>	25	3	2		
DIA	<b>40</b>	35	3	2		

n°	IDpoterie	locus	forme	céra.	façonnage		décor	cui.	« marque »	
					MT	S			type	position
1	TCH95B6039.18	B6039	bol 06 A c	SW02				A5		
2	TCH95B6039.23	B6039	bol 01 A d	SW01				A5		
3	TCH95B6039.17	B6039	bol 01 A d	SW02				A5		
4	TCH95B6039.12	B6039	bol 01 A d	SW02				A5		
5	TCH95B6039.13	B6039	bol 01 A e	SW01			pseudo-engobe (VO)	A5		
6	TCH95B6039.28	B6039	bol 01 A e	SW01			pseudo-engobe (VO)	A5		
7	TCH95B6039.27	B6039	bol 01 A e	SW01				A5		
8	TCH95B6039.15	B6039	bol 01 A e	SW02				A5		
9	TCH95B6039.22	B6039	bol 01 A e	SW02				A5		
10	TCH95B6039.21	B6039	bol 01 C c	SW02				A5		
11	TCH95B6039.16	B6039	bol 02 B a	SW02				A5		
12	TCH95B6039.24	B6039	bol 03 A i	SW02				A5		
13	TCH95B6039.8	B6039	bol 03 A i	SW05				A5		
n.i.	TCH95B6039.11	B6039	bol 03 B i	SW01				A5		
14	TCH95B6039.26	B6039	bol nd	SW02				A5		
15	TCH95B6039.29	B6039	bol 03 B i	SW01				A5		
16	TCH95B6039.9	B6039	bol 03 C n	SW01				A5		
17	TCH95B6039.10	B6039	bol 05 A g	SW14				A5		
18	TCH95B6039.32	B6039	bol 05 A g	SW14				A5		
n.i.	TCH95B6039.25	B6039	bol nd	SW05				A5		
19	TCH95B6039.41	B6039	petite jarre 03 D 03	SW01				A5		
20	TCH95B6039.42	B6039	encensoir panse	SW01			engobe, modelage, excision, incision	A2		
21	TCH95B6039.31	B6039	anse	SW01				A5		
22	TCH95B6039.39	B6039	anse	SW07				A5		
23	TCH95B6039.37	B6039	jarre OL 01 C 40	SW05				A5		
24	TCH95B6039.36	B6039	jarre OL 02 B 37	SW05				A5		
25	TCH95B6039.38	B6039	jarre OL 04 33	SW04				A2		
26	TCH95B6039.40	B6039	grande jarre 01 B 53	SW14				A5		



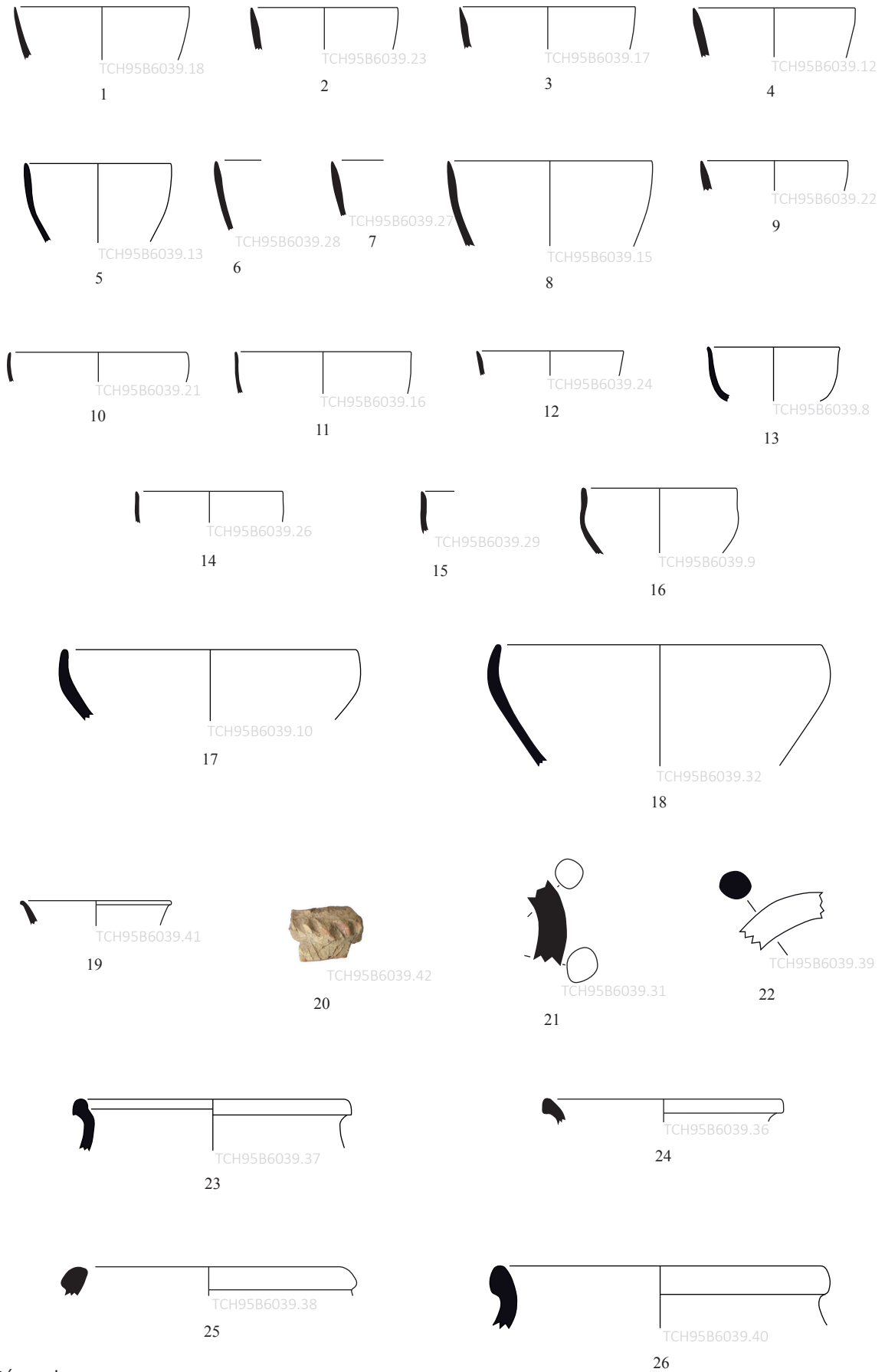

Céramiques communes



n°	IDpoterie	locus	forme	céra.	façonnage		décor	cui.	« marque »	
					MT	S			type	position
1	TCH95B6039.1	B6039	base 1A	SW01				A5		
2	TCH95B6039.30	B6039	base 1A	SW14				A5		
3	TCH95B6039.5	B6039	base 2	SW02				A5		
4	TCH95B6039.4	B6039	base 3B	SW01				A5		
5	TCH95B6039.2	B6039	base 3B	SW02				A5		
6	TCH95B6039.3	B6039	base 3B	SW02				A5		
7	TCH95B6039.6	B6039	base 3B	SW02				A5		
8	TCH95B6039.34	B6039	grande jarre 02 54	GV				A5		
9	TCH95B6039.33	B6039	grande jarre 01 52	GV				A2		
10	TCH95B6039.50	B6039	marmite 02 A	GM				A5		
11	TCH95B6039.49	B6039	marmite 02 A	GM				A5		
12	TCH95B6039.43	B6039	marmite 02 B	GM				A5		

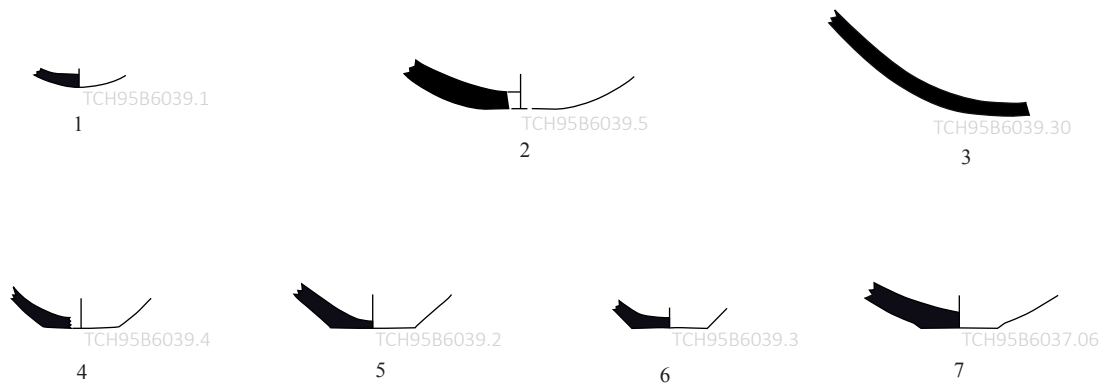

Céramiques communes (suite)

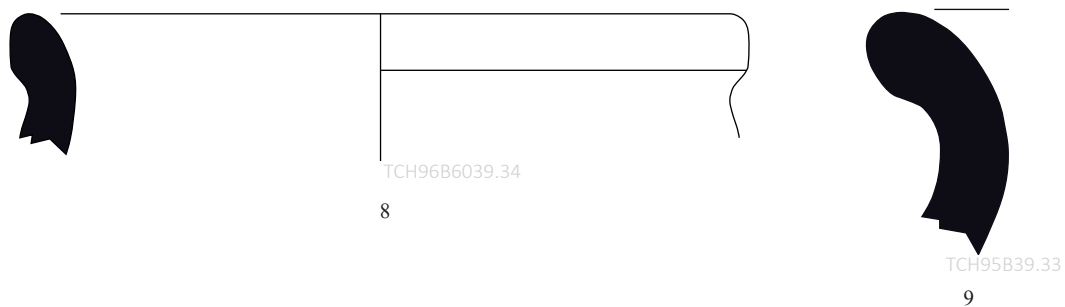

Céramiques à dégraissant végétal grossier (GV)

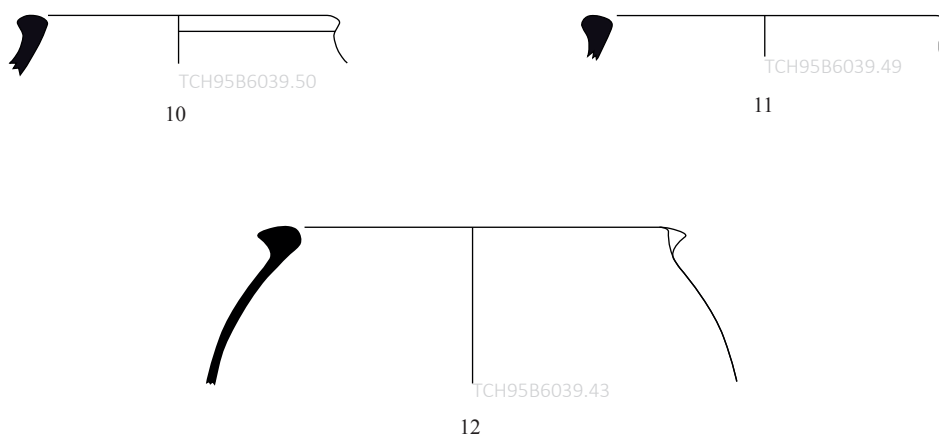

Céramiques à dégraissant minéral grossier (GM)





TCH.B6045

Couche cendreuse dans l'espace R202

		sw	gm	gv	mw	ew
NR	<b>422</b>	317	18	6	2	
NMI	<b>78</b>	66	3	6	2	1
DIA	<b>91</b>	76	4	7	3	1

n°	IDpoterie	locus	forme	céra.	façonnage		décor	cui.	« marque »	
					MT	S			type	position
1	TCH95B78	B6045	bol bas 02 C h	SW02	IB-IIB-III125	4	pseudo-engobe	A4		
2	TCH95B6045.42	B6045	bol bas 03 B i	SW02	IB-IIB			A5		
3	TCH95B6045.49	B6045	bol bas 03 C i	SW01	IB-IIB-III25	4		A3		
4	TCH95B6045.56	B6045	bol bas 03 C i	SW02	IB1-IIB-III12	4	pseudo-engobe (VO)	A5		
5	TCH95B69	B6045	bol 01 A a	nd				0		
6	TCH95B6045.21	B6045	bol 01 A e	SW07			pseudo-engobe (VO)	A5		
7	TCH95B106	B6045	bol 01 B d	nd				0		
8	TCH95B6045.18	B6045	bol 02 A a	SW02	IB-IIB-III2b	4		A5		
9	TCH95B6045.1	B6045	bol 02 A d	SW07	IB-IIB		pseudo-engobe	A5		
10	TCH95B6045.10	B6045	bol 02 B b	SW01			pseudo-engobe (VO)	A5		
11	TCH95B6045.12	B6045	bol 02 B b	SW02				A5		
12	TCH95B6045.23	B6045	bol 02 B b	SW02				A5		
13	TCH95B6045.22	B6045	bol 02 B b	SW02				A5		
14	TCH95B71	B6045	bol 03 A i	nd	IB-IIB			A5		
15	TCH95B6045.24	B6045	bol 03 A i	SW01	IB-IIB			A5		
16	TCH95B6045.13	B6045	bol 03 A i	SW01			pseudo-engobe (VO)	A5		
17	TCH95B6045.4	B6045	bol 03 A i	SW02	IB1-IIB-III25	4	pseudo-engobe (VO)	A5		
18	TCH95B6045.27	B6045	bol 03 A i	SW02				A1		
19	TCH95B82	B6045	bol 03 B i	nd				0		
20	TCH95B6045.53	B6045	bol 03 B i	SW01	III2b		pseudo-engobe	A5		
21	TCH95B6045.11	B6045	bol 03 B i	SW01				A5		
22	TCH95B80	B6045	bol 03 B i	SW02	IB1-IIB-III125	4		A5		
23	TCH95B6045.17	B6045	bol 03 B i	SW02				A5		
24	TCH95B6045.70	B6045	bol 03 B j	SW02	III2			A5		
25	TCH95B6045.3	B6045	bol 03 B n	SW02				A5		

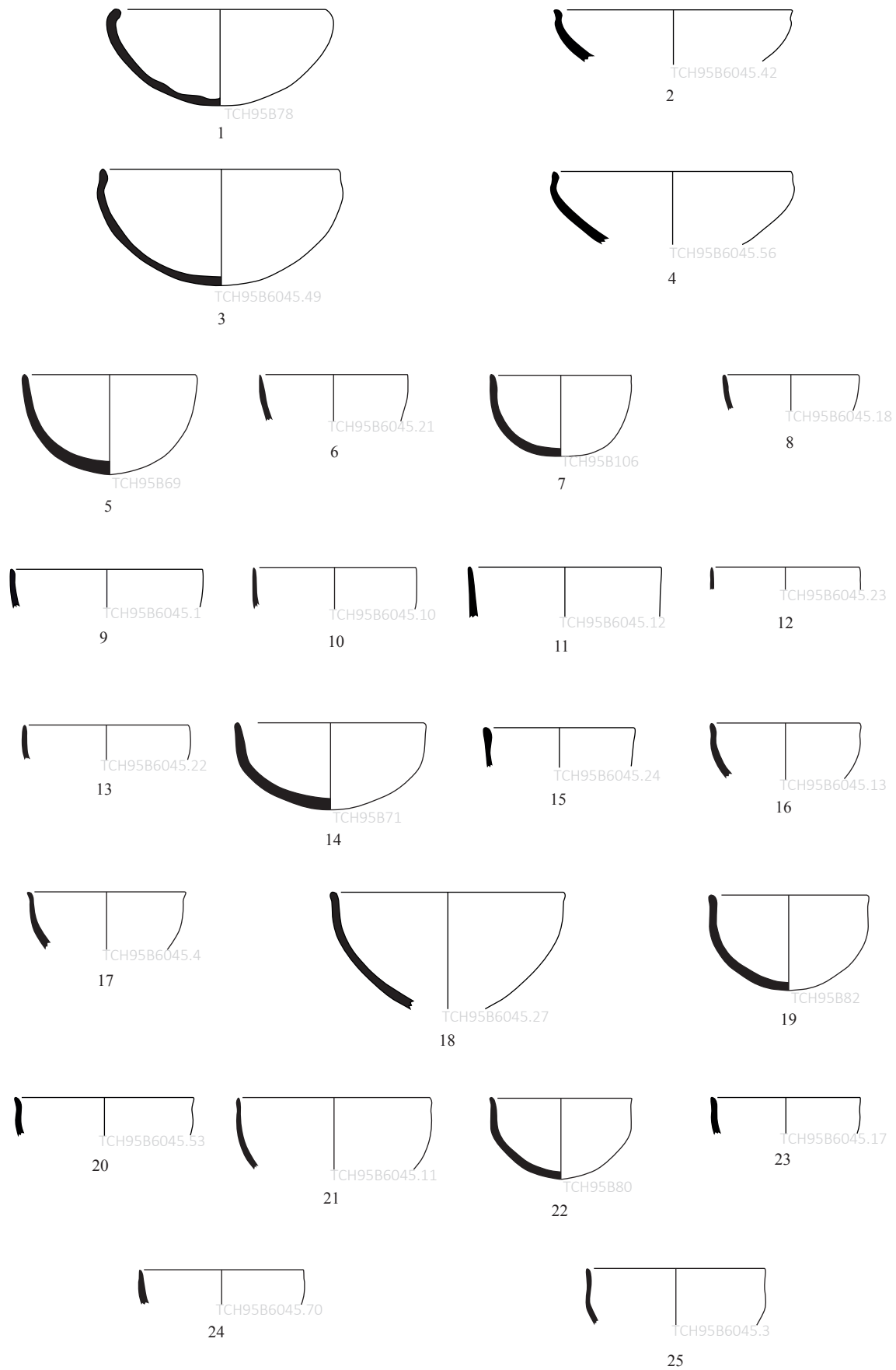

Céramiques communes



n°	IDpoterie	locus	forme	céra.	façonnage		décor	cui.	« marque »	
					MT	S			type	position
1	TCH95B60	B6045	bol 03 C i	nd				0		
2	TCH95B6045.2	B6045	bol 03 C i	SW02	IB-IIIB-III125	4	pseudo-engobe	A3		
3	TCH95B6045.6	B6045	bol 03 C i	SW02				A5		
4	TCH95B6045.5	B6045	bol 03 C i	SW02				A5		
5	TCH95B6045.50	B6045	bol 05 A f	SW01	IB-IIIB-III2b			A5		
6	TCH95B6045.51	B6045	bol 05 A g	SW01	IB-IIIB-III2b			A5		
7	TCH95B6045.15	B6045	bol 05 A j	SW02				A5		
8	TCH95B6045.16	B6045	bol 05 A j	SW02				A5		
9	TCH95B6045.14	B6045	bol 05 B g	SW01				A3		
10	TCH95B6045.9	B6045	bol 05 B g	SW01				A5		
11	TCH95B6045.8	B6045	bol 05 B k	SW01			pseudo-engobe (VO)	A5		
12	TCH95B6045.20	B6045	bol 06 A c	SW01				A5		
13	TCH95B6045.19	B6045	bol 06 A m	SW02				A5		
14	TCH95B6045.52	B6045	bol 06 A l	SW05	IB-IIIB-III2			A1		
n.i.	TCH95B6045.54	B6045	bol	SW01				A5		
15	TCH95B6045.7	B6045	vase miniature 03 A i	SW01				A5		
16	TCH95B6045.41	B6045	pot	nd				A5		
17	TCH95B6045.39	B6045	pot 03 p	SW13				A2		
18	TCH95B6045.29	B6045	pot 03 u	SW01			pseudo-engobe	A5		
19	TCH95B6045.30	B6045	pot 03 y	SW14				A4		
20	TCH95B6045.35	B6045	pot 03 u	SW10				A2		

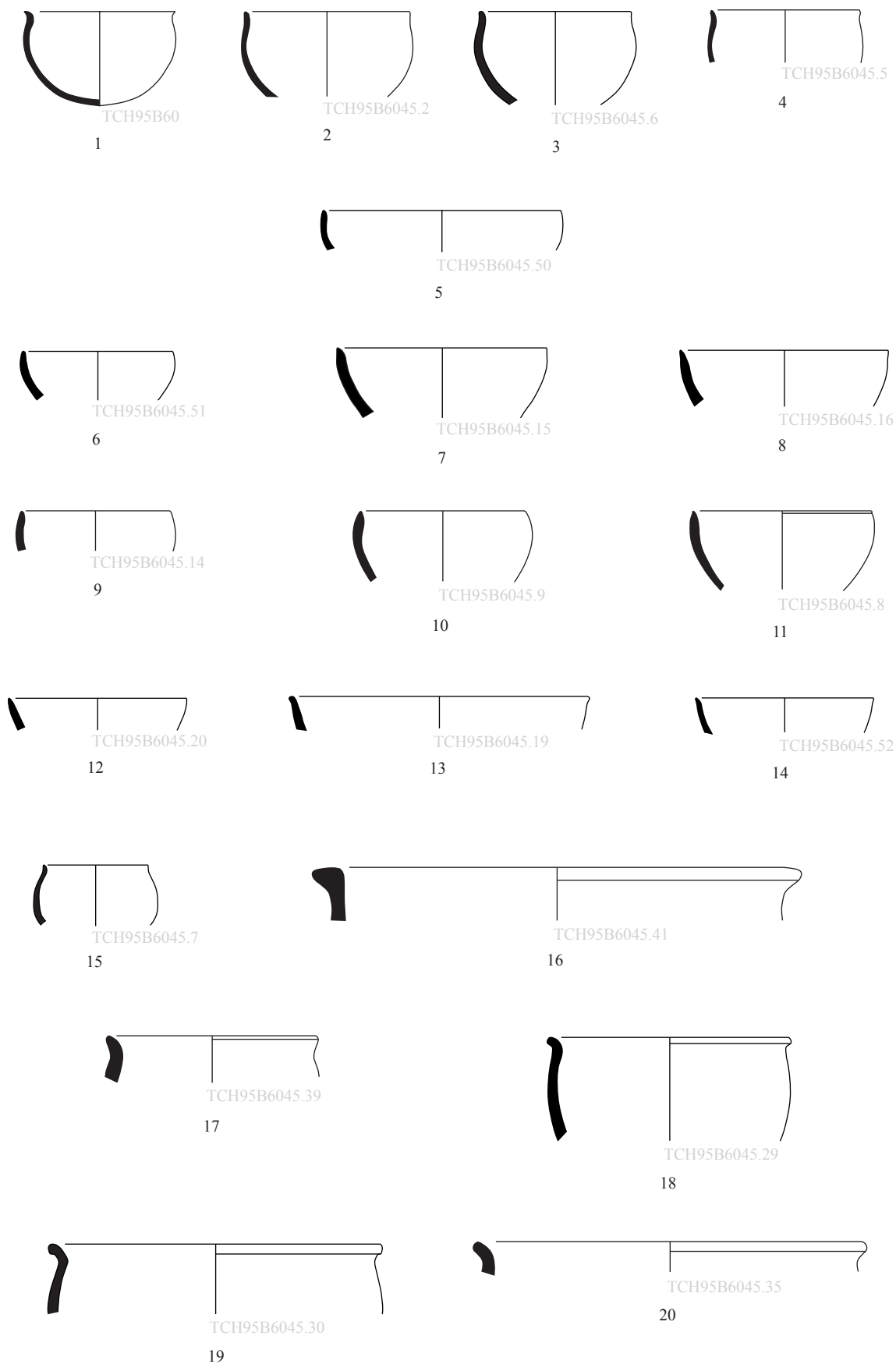

Céramiques communes (suite)



n°	IDpoterie	locus	forme	céra.	façonnage		décor	cui.	« marque »	
					MT	S			type	position
1	TCH95B6045.32	B6045	petite jarre 01 53	SW04		4	pseudo-engobe	A5		
2	TCH95B6045.38	B6045	petite jarre 02 B 06	SW02				A5		
3	TCH95B6045.28	B6045	petite jarre 02 B 06	nd				A5		
n.i.	TCH95B6045.48a	B6045	petite jarre 02 B 06	SW01			pseudo-engobe	A5		
4	TCH95B59	B6045	petite jarre 02 B 16	SW13	IB-III12		peinture	nd		
5	TCH95B6045.61	B6045	petite jarre 02 B 08	SW04				A5		
6	TCH95B6045.60	B6045	petite jarre 03 D 02	SW02			peinture	A5		
7	TCH95B72	B6045	petite jarre 03 D	SW13			peinture	A2		
8	TCH95B6045.36	B6045	petite jarre 03 A 01	SW13			engobe	A5		
9	TCH95B6045.45	B6045	col	SW14				A5		
10	TCH95B70	B6045	petite jarre 03 D 04	nd				0		
11	TCH95B77	B6045	petite jarre 03 D 03	SW01	IB-III125			A2		
12	TCH95B6045.44	B6045	vase miniature 06	SW04				A2		



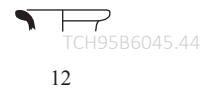
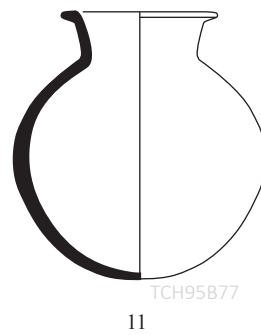
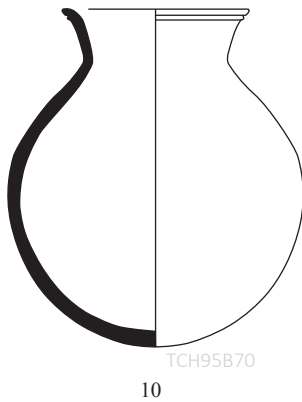
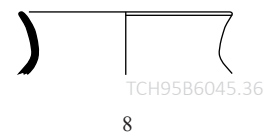
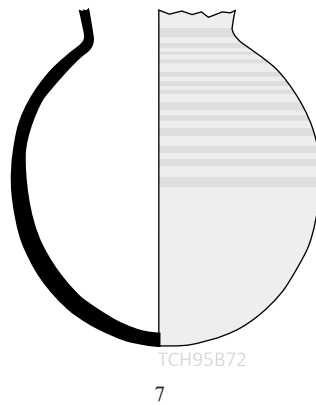
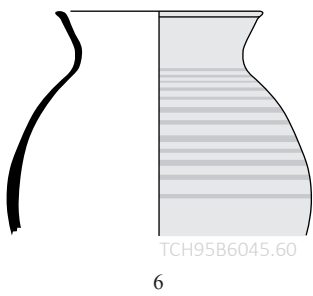
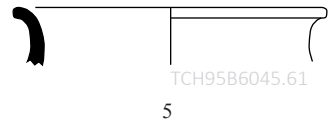
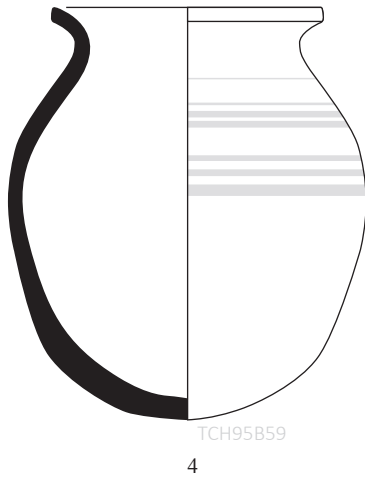
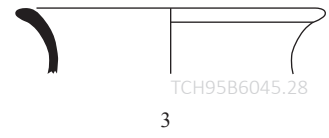
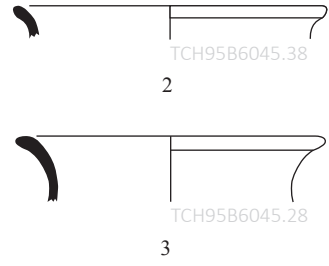
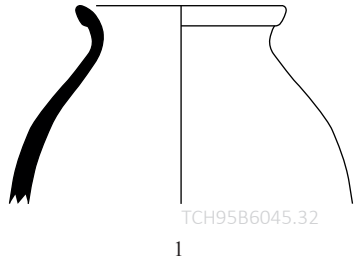

Céramiques communes (suite)



n°	IDpoterie	locus	forme	céra.	façonnage		décor	cui.	« marque »	
					MT	S			type	position
1	TCH95B6045.40	B6045	jarre OE 02 A 25	SW05				A2		
2	TCH95B6045.31	B6045	jarre OE 02 A 25	SW07			engobe	A5		
3	TCH95B73	B6045	jarre OE 03 A 25	nd				0		
4	TCH95B6045.34	B6045	support 04	SW07			engobe	A2		
5	TCH95B6045.33	B6045	jarre OE 03 B 24	SW13			engobe	A2		
6	TCH95B6045.37	B6045	jarre OL 02 B 16	SW14				A5		
7	TCH95B6045.46	B6045	jarre OL 02 D 45	SW12	IB-III12			A5		
8	TCH95B6045.48b	B6045	base 1A	SW13				A5		
9	TCH95B6045.25	B6045	base 2	SW01	IB2-IIIB-III4	5	pseudo-engobe	A5		
10	TCH95B6045.26	B6045	base 3B	SW02	IB2-IIIB	5		A5		
11	TCH95B6045.71	B6045	panse	SW04			peinture	A5		
12	TCH95B6045.55	B6045	panse	SW13	IB-IIA-III2b	2	engobe, application d'élément modelé, incision	A5		
13	TCH95B6045.43	B6045	passoire panse	SW07	IB-IIA-III1	2		A5		
14	TCH95B64	B6045	bouchon	nd				0		
15	TCH95B81	B6045	Support 01	nd				0		
16	TCH95B80b	B6045	Support 01	nd				A5		
17	TCH95B84	B6045	support 05	SW01	IB-IIA-III1	2		A5		

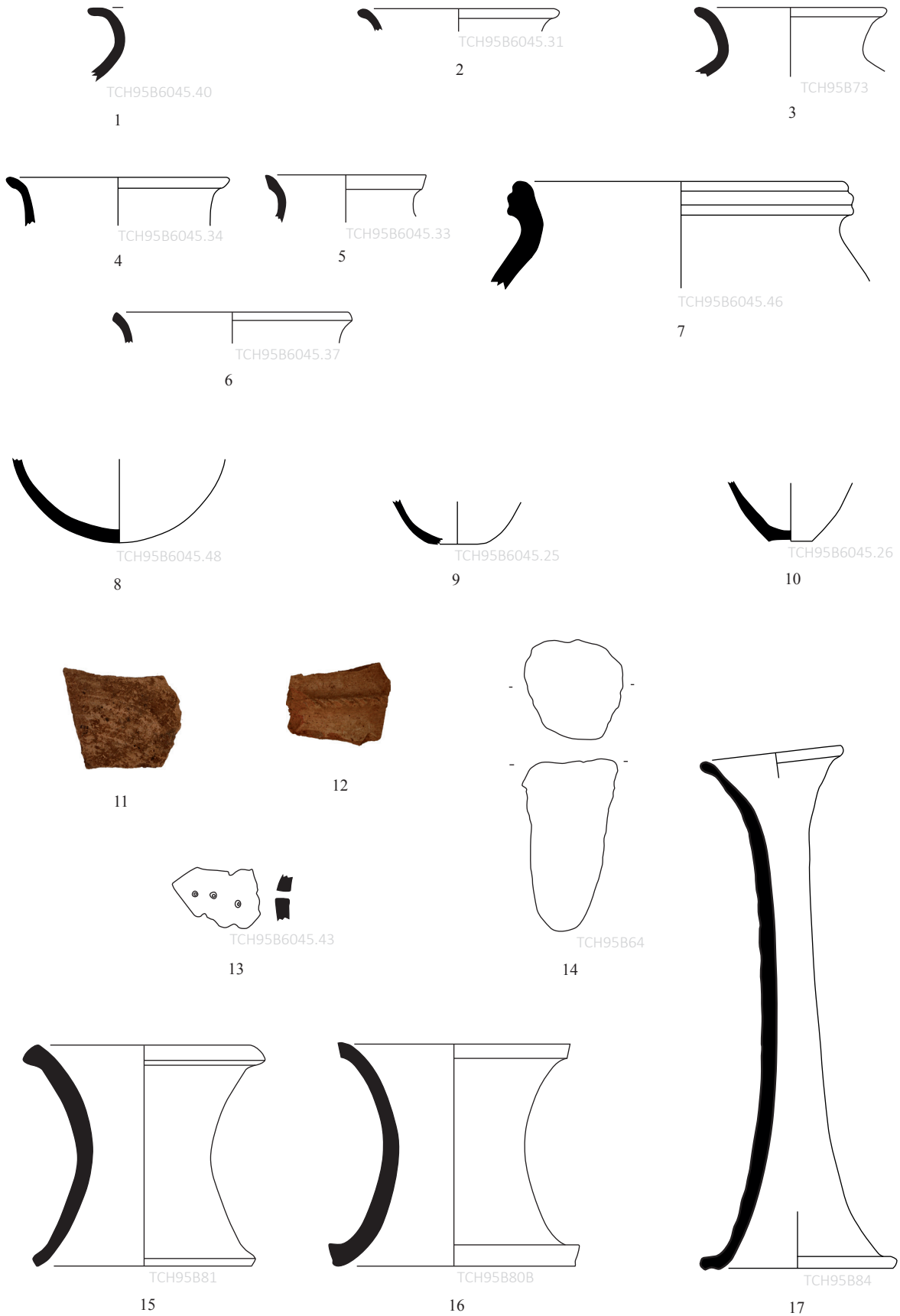

Céramiques communes (suite)



Catalogue 100

n°	IDpoterie	locus	forme	céra.	façonnage		décor	cui.	« marque »	
					MT	S			type	position
1	TCH95B6045.67	B6045	pot 01 a	GV	IB-IIA-III1	2		A4		
2	TCH95B6045.68	B6045	panse	GV	IB-IIA-III1	2		A2	gravée	nsp
3	TCH95B6045.66	B6045	grande jarre 02 54	GV				A5		
4	TCH95B6045.65	B6045	grande jarre 01 52	GV				A2		
5	TCH95B6045.64	B6045	grande jarre 02 53	GV				A5		
6	TCH95B6045.0	B6045	Support 01	GV				A5		
7	TCH95B6045.47	B6045	Support	GV	IB-III2			A5		

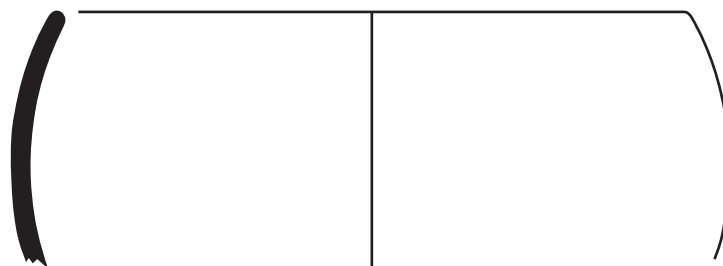

TCH95B6045.67

1

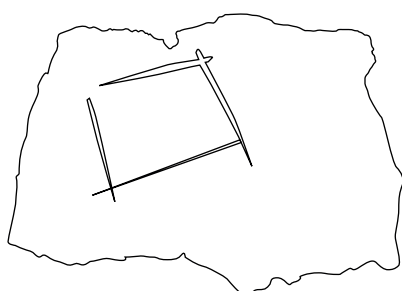

TCH95B6045.68

2

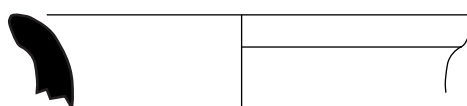

TCH95B6045.66

3

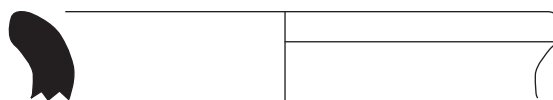

TCH95B6045.65

4

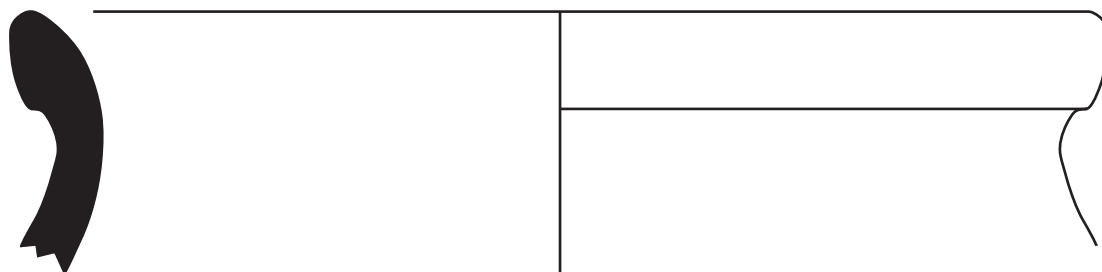

TCH95B6045.64

5

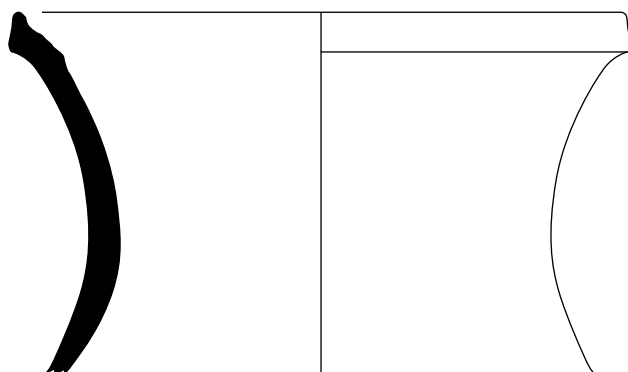

TCH95B6045.0

6



TCH95B6045.47

7

Céramiques à dégraissant végétal grossier (GV)



Catalogue 101

n°	IDpoterie	locus	forme	céra.	façonnage		décor	cui.	« marque »	
					MT	S			type	position
1	TCH95B6045.73	B6045	marmite ?	GM	IB-IIA-III6	3		A5		
2	TCH95B6045.62	B6045	marmite 02 B	GM	IB-IIA-III6a	3		A5		
3	TCH95B6045.72	B6045	marmite 02 B	GM	IB-IIA-III6a	3		A4		
n.i.	TCH95B6045.69	B6045	panse	GM				A5		
4	TCH95B89	B6045	petite jarre 03 B 05	MW 4				A5		
n.i.	TCH95B6045.58	B6045	panse	MW 7				A5		
5	TCH95B75	B6045	petite jarre 03 E 05	MW 9	III4	5	pseudo-engobe (fortuit)	nd		
6	TCH95B6045.59	B6045	base 5A	EW	III4		peinture	A5		

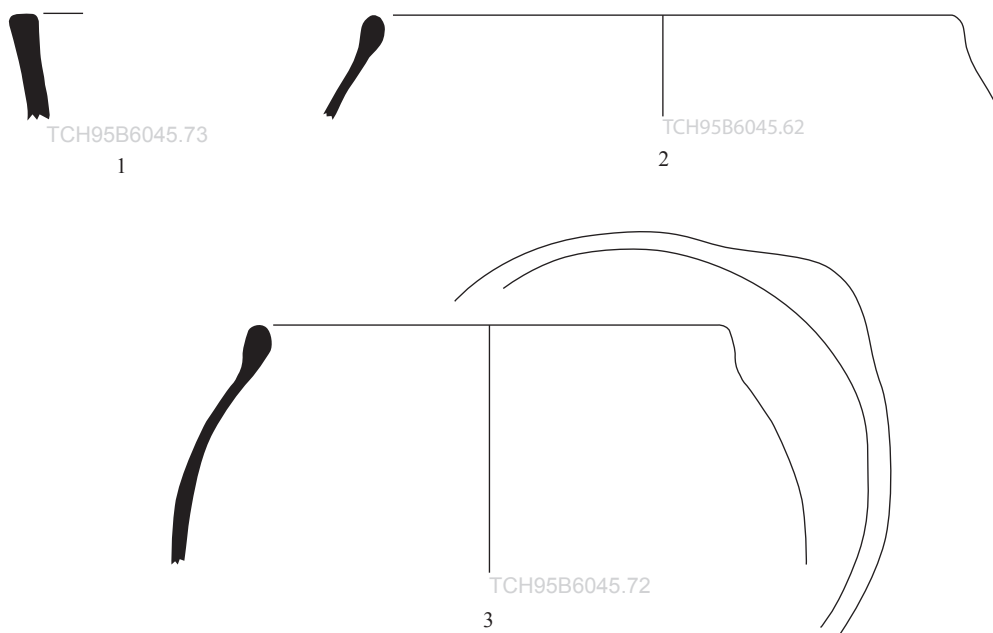

Céramiques à dégraissant végétal grossier (GM)

---

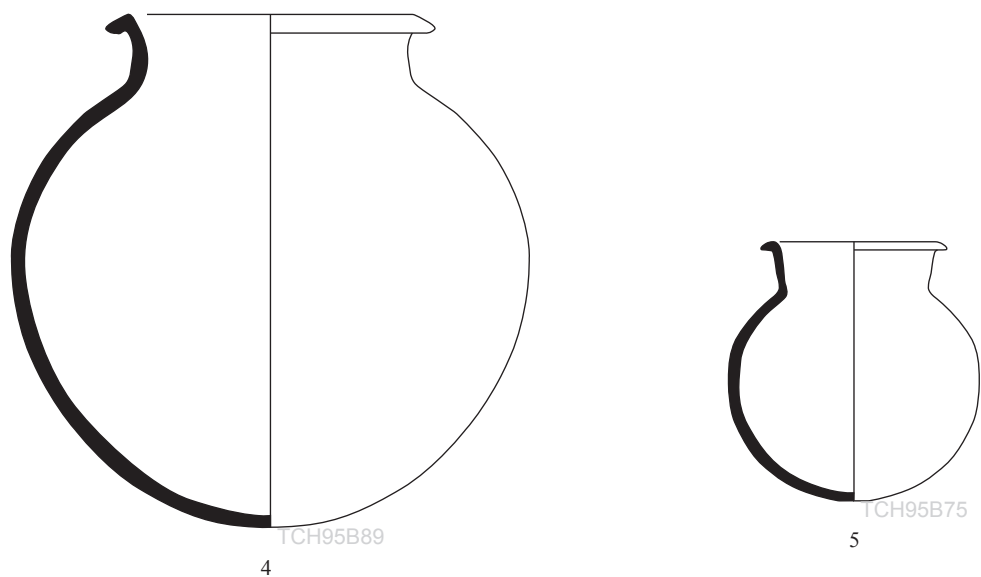

Céramiques métalliques

---

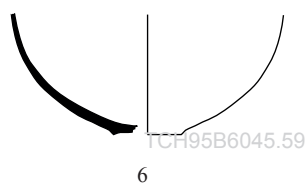

Céramiques de l'Euphrate

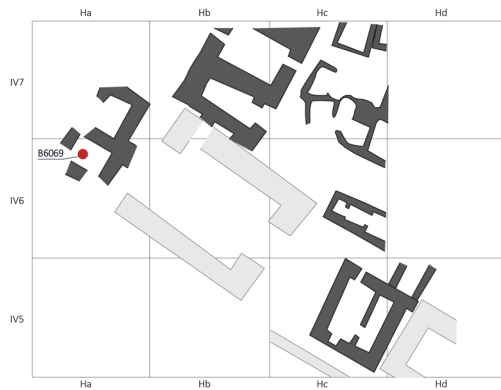

TCH.B6069

Espace R204

		sw	gm	gv	mw	ew
NR	<b>935</b>	723	5	206	1	
NMI	<b>34</b>	27	(1)	5	(1)	
DIA	<b>38</b>	33		5		

n°	IDpoterie	locus	forme	céra.	façonnage		décor	cui.	« marque »	
					MT	S			type	position
1	TCH95B6069.3	B6069	bol 01 B d	SW02				A5		
2	TCH95B6069.12	B6069	bol 01 C n	SW01			pseudo-engobe	A3		
3	TCH95B6069.4	B6069	bol 03 A i	SW01				A5		
4	TCH95B6069.8	B6069	bol 03 B i	SW01				A5		
5	TCH95B6069.10	B6069	bol 03 B i	SW01			pseudo-engobe (VO)	B		
6	TCH95B6069.5	B6069	bol 03 B i	SW07				A5		
7	TCH95B6069.2	B6069	bol 03 C i	SW01			engobe	A5		
8	TCH95B6069.11	B6069	bol 05 A g	SW04			pseudo-engobe (VO)	A2		
9	TCH95B6069.13	B6069	bol 01 A c	SW01				A2		
10	TCH95B6069.9	B6069	bol 06 A c	SW01			pseudo-engobe (VO)	A5		
11	TCH95B6069.6	B6069	bol 06 A c	SW02				A5		
12	TCH95B6069.7	B6069	bol 06 A l	SW02				A5		
n.i.	TCH95B6069.	B6069	bol	SW01				A3		
13	TCH95B6069.14	B6069	jatte 02 t	SW12				A5		
14	TCH95B108	B6069	petite jarre 02 B 08	SW01				A5		
n.i.	TCH95B6069.15	B6069	petite jarre 03 D 02	SW02			engobe	A5		



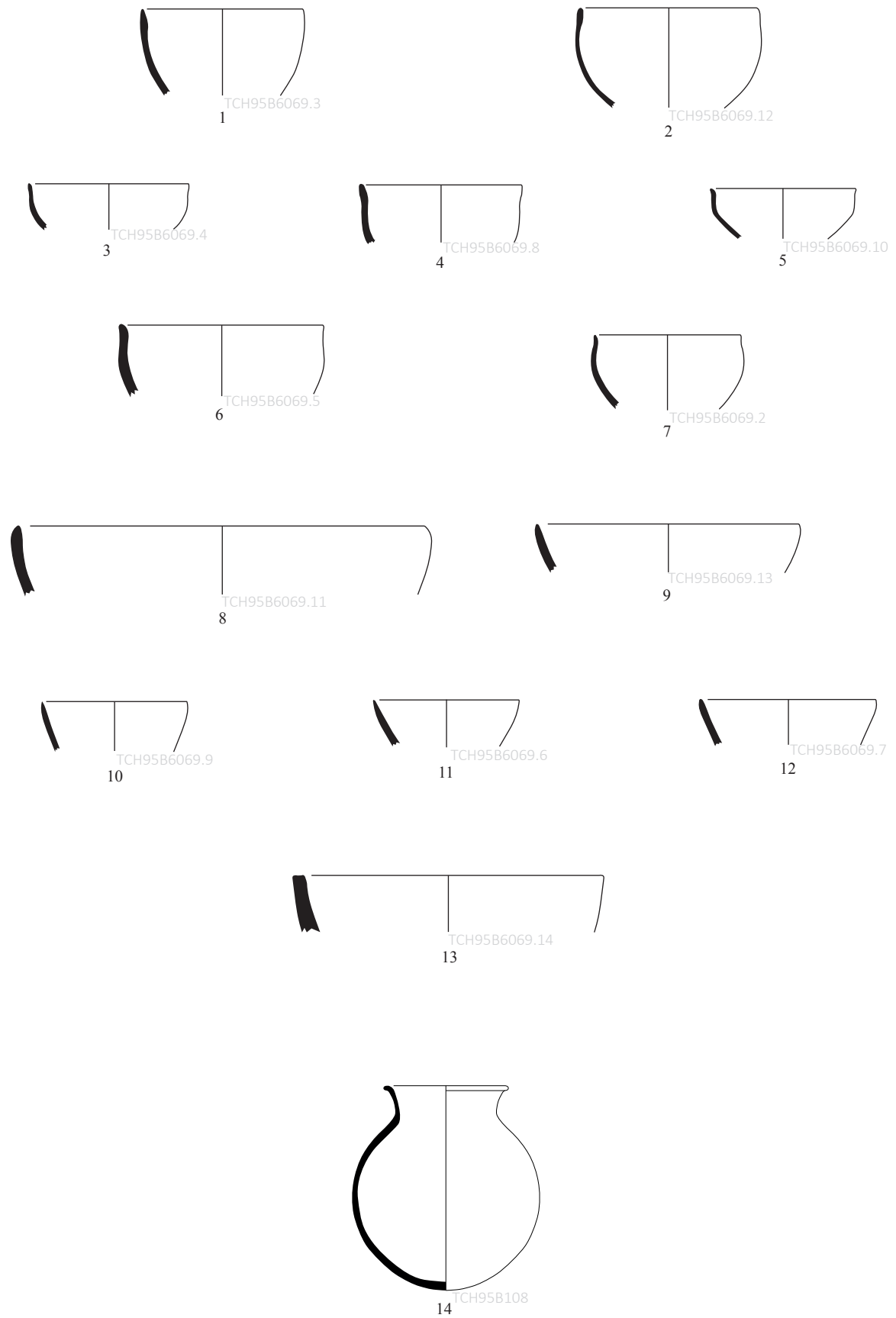

Céramiques communes



n°	IDpoterie	locus	forme	céra.	façonnage		décor	cui.	« marque »	
					MT	S			type	position
1	TCH95B6069.25	B6069	jarre OE 02 A 26	SW04			pseudo-engobe	A5		
2	TCH95B6069.24	B6069	jarre OE 02 A 26	SW13			engobe	A4		
3	TCH95B6069.21	B6069	jarre OE 02 A 26	SW14				A5		
4	TCH95B6069.23	B6069	jarre OE 02 A 26	SW14				A5		
5	TCH95B6069.20	B6069	jarre OE 02 B 26	SW05				A3		
6	TCH95B6069.22	B6069	jarre OE 02 B 27	SW13			engobe	A5		
7	TCH95B6069.18	B6069	jarre OE 03 A 26	SW02				A5		
8	TCH95B6069.16	B6069	jarre OE 03 A 26	SW14				A5		
9	TCH95B6069.19	B6069	support 05	SW14				A5		
10	TCH95B6069.27	B6069	jarre OL 03 B 36	SW14				A5		
11	TCH95B6069.26	B6069	jarre OL 02 D 17	SW13				A3		
12	TCH95B6069.1	B6069	grande jarre 02 C 52	SW05				A5		
13	TCH95B6069.34	B6069	base 1A	SW01				A5		
14	TCH95B6069.35	B6069	base 3A	SW02				A5		
15	TCH95B6069.33	B6069	base 3A	SW05				A5		
16	TCH95B6069.36	B6069	base 3B	SW01				A5		
17	TCH95B6069.32	B6069	anse	SW04			engobe	A5		

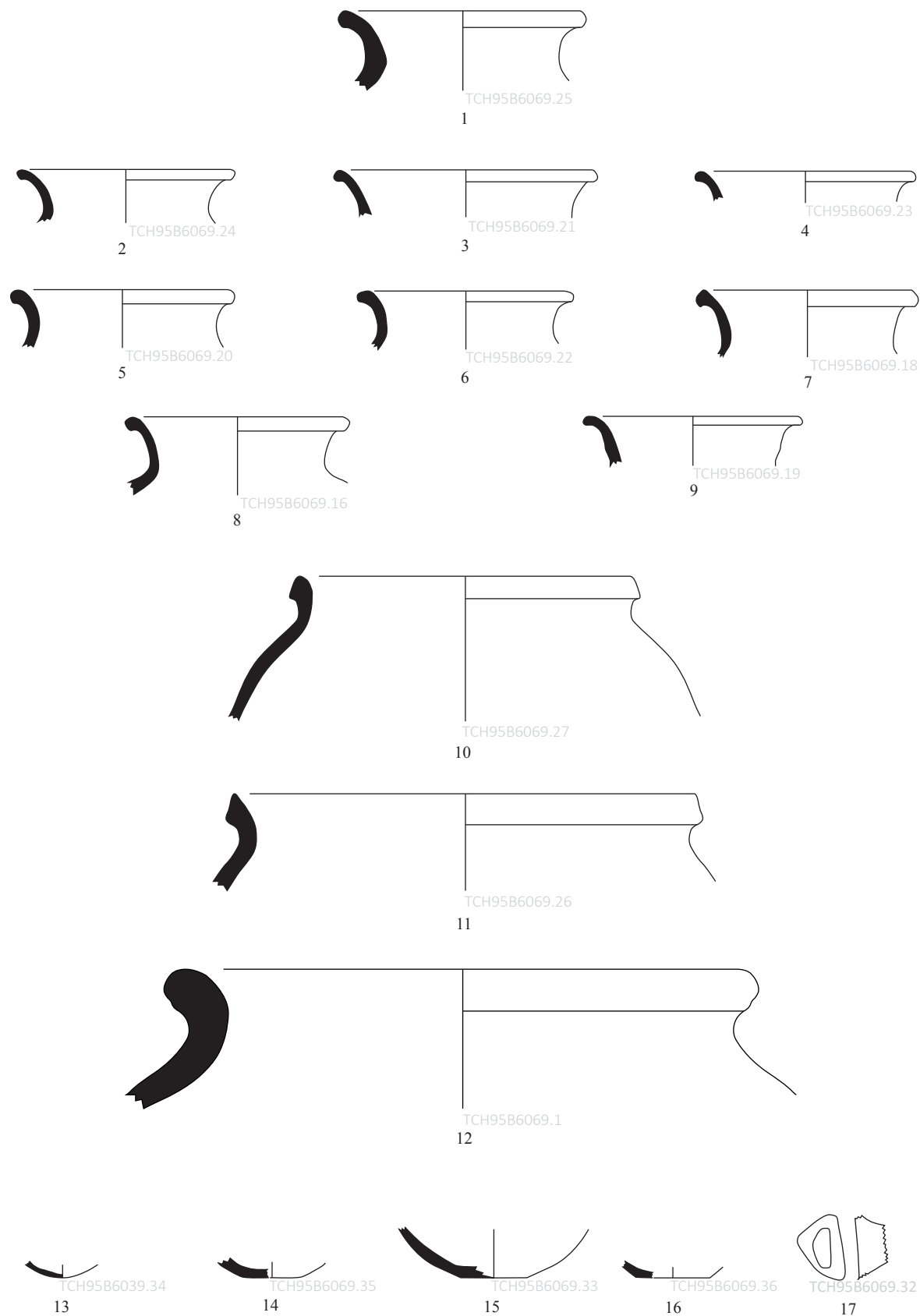

Céramiques communes (suite)



Catalogue 104

n°	IDpoterie	locus	forme	céra.	façonnage		décor	cui.	« marque »	
					MT	S			type	position
1	TCH95B6069.28	B6069	grande jarre 02 54	GV				A2		
2	TCH95B6069.30	B6069	grande jarre 02 54	GV				A2		
3	TCH95B6069.29	B6069	grande jarre 02 54	GV				A5		
4	TCH95B6069.37	B6069	grande jarre 02 54	GV				A2		
5	TCH95B6069.31	B6069	grande jarre nd	GV				A2		

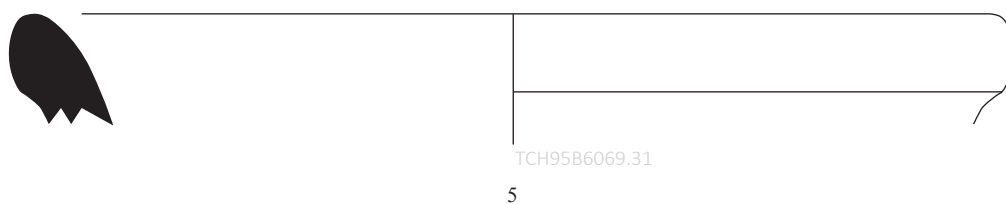
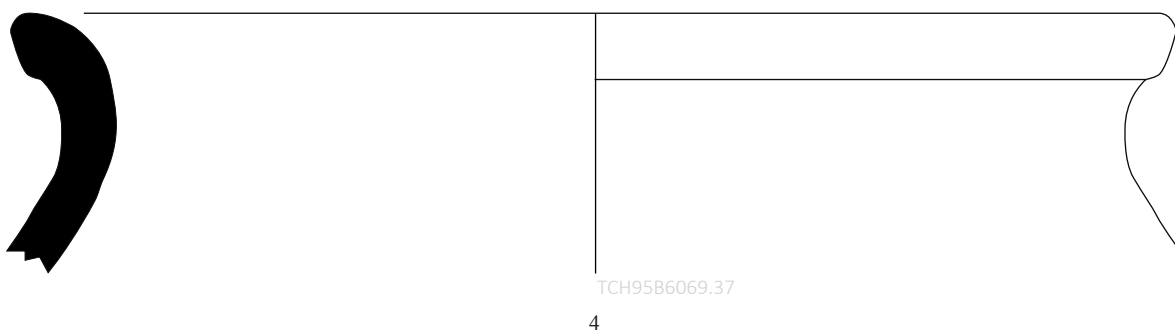
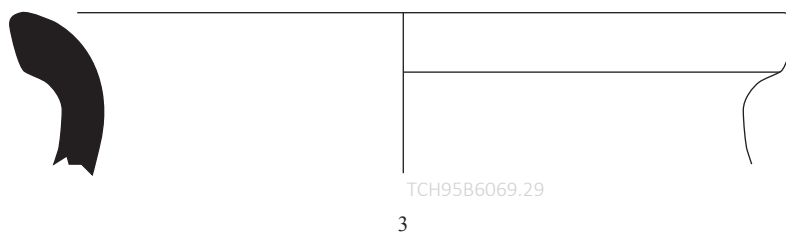
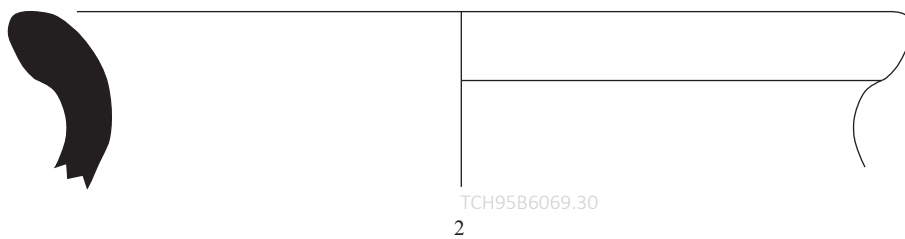
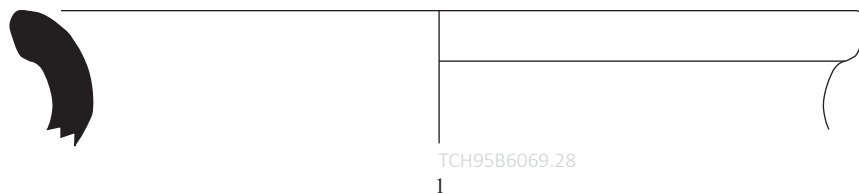

Céramiques à dégraissant végétal grossier (GV)





TCH.B6074

Couche de destruction, espace R204

		sw	gm	gv	mw	ew
NR	<b>22</b>	3		19		
NMI	<b>36</b>	32	1	4		
DIA	<b>41</b>	36	1	4		

n°	IDpoterie	locus	forme	céra.	façonnage		décor	cui.	« marque »	
					MT	S			type	position
1	TCH95B54	B6074	bol bas 02 C h	SW01			pseudo-engobe (VO)	A4		
n.i.	TCH95B60a	B6074	bol bas 03 B i	nd - SW				nd		
2	TCH95B163	B6074	bol bas 03 C i	SW01			pseudo-engobe (VO)	A5		
3	TCH95B6074.6	B6074	bol 01 A b	SW01				A5		
n.i.	TCH95B507	B6074	bol 01 C	nd				0		
4	TCH95B6074.2	B6074	bol 03 A i	SW02				A5		
5	TCH95B511	B6074	bol 03 A o	nd				0		
6	TCH95B509	B6074	bol 03 B i	nd				0		
n.i.	TCH95B6074.8	B6074	bol 03 B i	SW01				A5		
7	TCH95B6074.7	B6074	bol 03 B i	SW02			engobe	A5		
8	TCH95B6074.1	B6074	bol 03 B n	SW01				A5		
9	TCH95B6074.5	B6074	bol 03 B n	SW02				A5		
10	TCH95B510	B6074	bol 03 B o	nd				0		
11	TCH95B508	B6074	bol 03 C i	nd				0		
12	TCH95B6074.3	B6074	bol 03 C i	SW02				A5		
13	TCH95B6074.4	B6074	bol 06 A c	SW01			pseudo-engobe (VO)	A5		
14	TCH95B6074.16	B6074	pot 03 v	SW07				A5		
15	TCH95B6074.10	B6074	pot 03 A x	SW01				A5		
16	TCH95B6074.11	B6074	petite jarre 02 A 08	SW05				A5		
17	TCH95B6074.17	B6074	petite jarre 02 A 08	SW05				A5		
18	TCH95B6074.19	B6074	petite jarre 02 B 08	SW13			engobe	A5		
19	TCH95B6074.12	B6074	petite jarre 02 B 08	SW01				A5		
20	TCH95B6074.18	B6074	petite jarre 03 B 28	SW04				A3		
21	TCH95B6074.14	B6074	petite jarre 03 B 28	SW04				A5		
n.i.	TCH95B6074.20	B6074	jarre OE 02 A 25	SW13				A5		
22	TCH95B6074.15	B6074	jarre OE 02 A 26	SW13			engobe	A5		
23	TCH95B6074.21	B6074	jarre OE 03 A 25	SW13			engobe	A5		

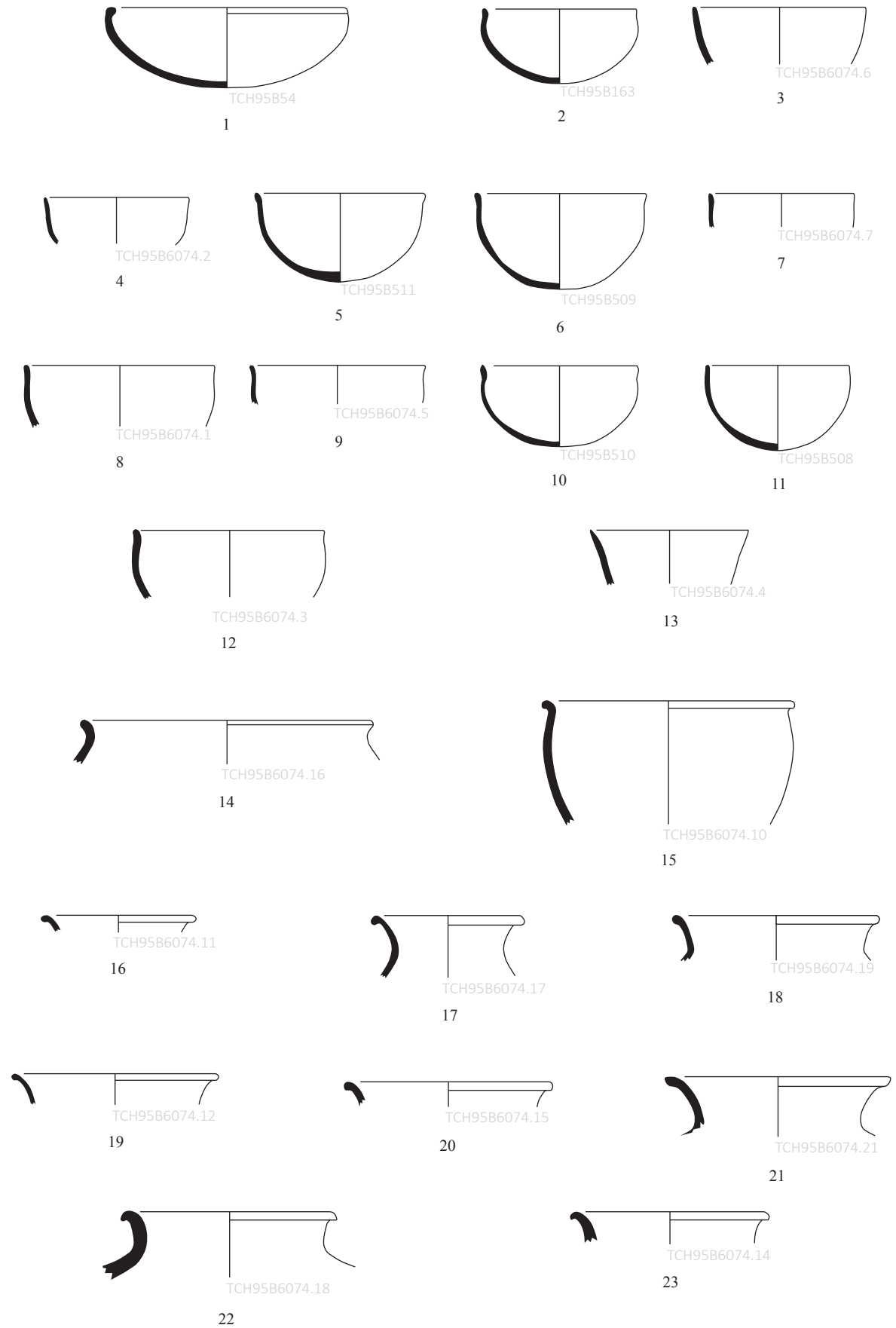

Céramiques communes



n°	IDpoterie	locus	forme	céra.	façonnage		décor	cui.	« marque »	
					MT	S			type	position
1	TCH95B6074.24	B6074	jarre OL 03 B 41	nd – SW				A5		
n.i.	TCH95B168	B6074	support ?	SW07				A4		
2	TCH95B6074.13	B6074	support ?	SW01				A5		
3	TCH95B165	B6074	vase miniature 06 E	SW01				A2		
4	TCH95B162	B6074	vase miniature 08	SW01				A5		
5	TCH95B6074.26	B6074	base 2	SW01				A5		
6	TCH95B6074.27	B6074	base 3A	nd – SW				A5		
7	TCH95B6074.25	B6074	base 3A	SW02	IB2-IIIB-III4	5		A5		
8	TCH95B6074.28	B6074	base 3A	SW05				A5		
9	TCH95B6074.9	B6074	bord	GV				A2		
10	TCH95B6074.23	B6074	jarre OL 03 B 43	GV				A2		
11	TCH95B6074.22	B6074	jarre OL 03 B 43	GV				A5		
n.i.	TCH95B224	B6074	grande jarre	GV				A2		
12	TCH95B6074.68	B6074	marmite 02 A	GM				A1		



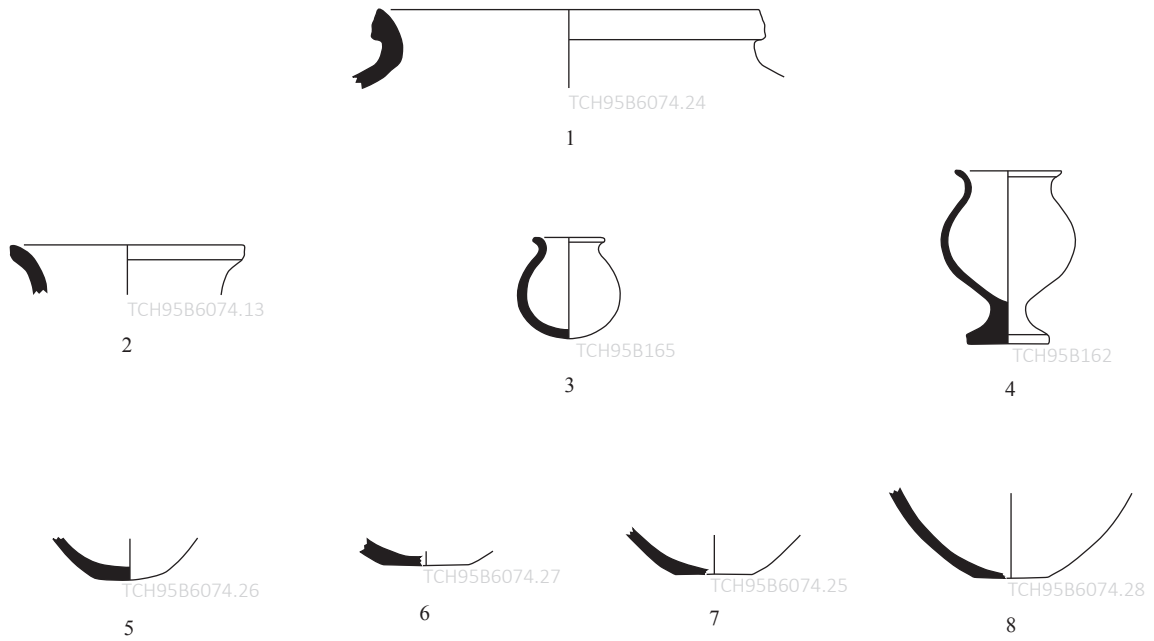

Céramiques communes

---

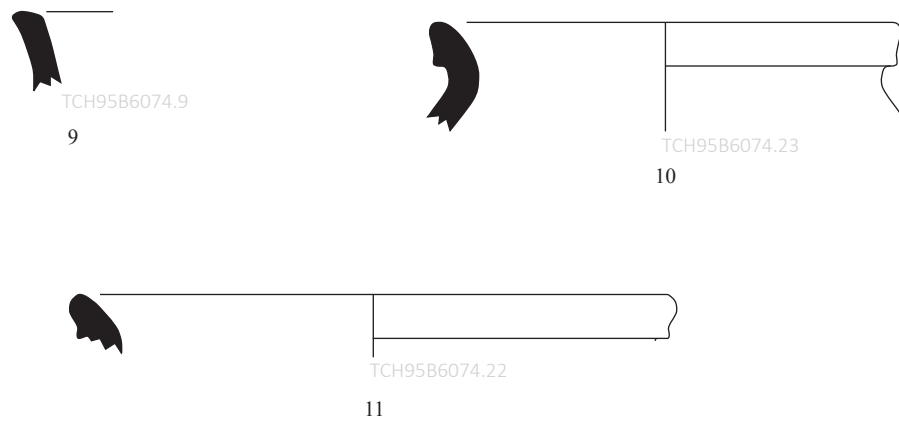

Céramiques à dégraissant végétal grossier (GV)

---

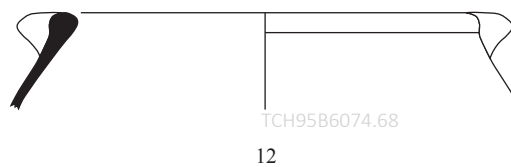

Céramiques à dégraissant minéral grossier (GM)



Catalogue 107



TCH.B6077

Espace R203

		sw	gm	gv	mw	ew
NR	<b>456</b>	274	182			
NMI	<b>111</b>	85	14	8	3	1
DIA	<b>132</b>	103	15	8	5	1

n°	IDpoterie	locus	forme	céra.	façonnage		décor	cui.	« marque »	
					MT	S			type	position
n.i.	TCH95B211	B6077	bol bas 02 C h	SW02	IB1-IIB-III12	4		A5		
1	TCH95B6077.74	B6077	bol bas 02 C h	SW02				A5		
2	TCH95B216	B6077	bol bas 03 B i	SW04				A5		
3	TCH95B189	B6077	bol bas 03 C i	SW02	IB-IIB-III2		pseudo-engobe (VO)	A5		
4	TCH95B184	B6077	bol 01 A d	SW01	IB-IIB-III25	4	pseudo-engobe	A5		
5	TCH95B6077.42	B6077	bol 01 A e	SW02	IB-IIB-III2			A5		
6	TCH95B177	B6077	bol 01 A e	nd	IB-III12		pseudo-engobe	A5		
7	TCH95B6077.59	B6077	bol 01 C c	SW02	IB2-IIB-III4b	5		A1		
8	TCH95B6077.8	B6077	bol 02 A a	SW01	III12			A5		
9	TCH95B6077.75	B6077	bol 02 A a	SW02	III12		engobe	A5		
10	TCH95B6077.38	B6077	bol 02 B a	SW02	IB-IIB-III25	4		A5		
11	TCH95B6077.33	B6077	bol 02 B a	SW02				A5		
12	TCH95B6077.70	B6077	bol 02 C a	SW04	III12		pseudo-engobe (VO)	A5		
13	TCH95B6077.69	B6077	bol 02 C b	SW04	IB-IIB-III25	4	engobe	A5		
14	TCH95B6077.35	B6077	bol 02 D c	SW04	IB-III2		engobe	A5		
15	TCH95B6077.45	B6077	bol 03 A i	SW01	IB-IIB-III2b			A5		
16	TCH95B6077.76	B6077	bol 03 A i	SW01				A2		
17	TCH95B6077.57	B6077	bol 03 A i	SW01			pseudo-engobe (VO)	A1		
18	TCH95B6077.3	B6077	bol 03 A i	SW02	IB-III12			A5		
19	TCH95B129	B6077	bol 03 A i	SW02	IB1-IIB-III12	4	pseudo-engobe (VO)	A5		
20	TCH95B217a	B6077	bol 03 A i	SW02				A5		
21	TCH95B6077.1	B6077	bol 03 A i	SW02	IB-IIB-III2			A5		
n.i.	TCH95B217b	B6077	bol 03 A i	SW05				A5		
22	TCH95B6077.58	B6077	bol 03 B i	nd	IB-IIB		pseudo-engobe	A2		
23	TCH95B136	B6077	bol 03 B i	SW01	IB-IIB-III125	4	pseudo-engobe (VO)	A5		
24	TCH95B6077.41	B6077	bol 03 B i	SW01	IB-IIB-III2b		pseudo-engobe (VO)	A5		

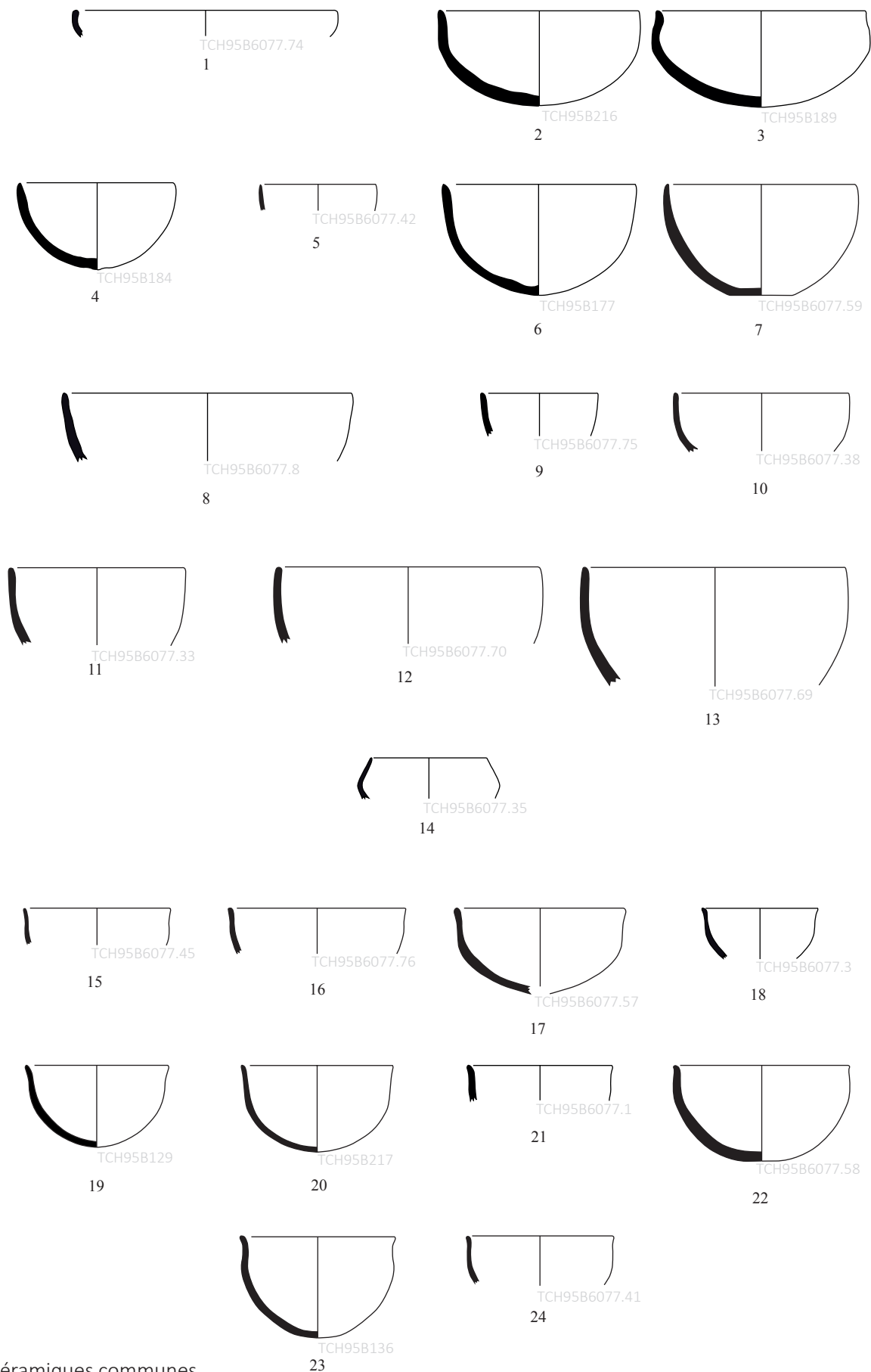

Céramiques communes

n°	IDpoterie	locus	forme	céra.	façonnage		décor	cui.	« marque »	
					MT	S			type	position
1	TCH95B215	B6077	bol 03 B i	SW01				A5		
2	TCH95B142	B6077	bol 03 B i	SW01			pseudo-engobe (VO)	A5		
3	TCH95B6077.73	B6077	bol 03 B i	SW02	IB-IIIB-III12	4		A5		
4	TCH95B141	B6077	bol 03 B i	SW02	IB-IIIB-III125	4	pseudo-engobe (VO)	A4		
5	TCH95B192	B6077	bol 03 B i	SW02	IB-IIIB-III2b		pseudo-engobe	nd		
6	TCH95B127	B6077	bol 03 B i	SW02				nd		
7	TCH95B213	B6077	bol 03 B i	SW02			pseudo-engobe (VO)	A5		
n.i.	TCH95B187	B6077	bol 03 B i	SW04			pseudo-engobe (VO)	A1		
8	TCH95B6077.37	B6077	bol 03 B n	SW02				A5		
9	TCH95B133	B6077	bol 03 B o	SW01				A2		
10	TCH95B6077.28	B6077	bol 03 B o	SW01			pseudo-engobe (VO)	A5		
n.i.	TCH95B6077.40	B6077	bol 03 C i	SW01	IB-IIIB-III12	4		A5		
n.i.	TCH95B186	B6077	bol 03 C i	SW02			pseudo-engobe (VO)	A5		
11	TCH95B6077.31	B6077	bol 05 A g	SW14	IB-IIIB-III2			A5		
n.i.	TCH95B217c	B6077	bol 06 A a	SW01				A5		
12	TCH95B6077.79	B6077	bol 06 A l	SW02	IB-IIIB-III2			A5		
13	TCH95B6077.2	B6077	bol 06 A m	SW01	IB-IIIB			A5		
n.i.	TCH95B210	B6077	bouteille	nd				0		
14	TCH95B126A	B6077	gobelet 01 A	nd				0		
15	TCH95B214	B6077	gobelet 01 B	SW04	IB2-IIIB-III24	5	bosselage	B		
16	TCH95B6077.34	B6077	pot 03 q	nd - surcuit				A2		
17	TCH95B6077.66	B6077	pot 03 u	SW12			engobe	A5		
18	TCH95B6077.67	B6077	pot 03 v	SW14			engobe	A2		
19	TCH95B6077.21	B6077	pot 03 w	SW14	IB-IIA-III12	2	pseudo-engobe	A5		
20	TCH95B6077.60	B6077	pot 03 A w	SW14	IB-IIA-III12	2	pseudo-engobe	A2		

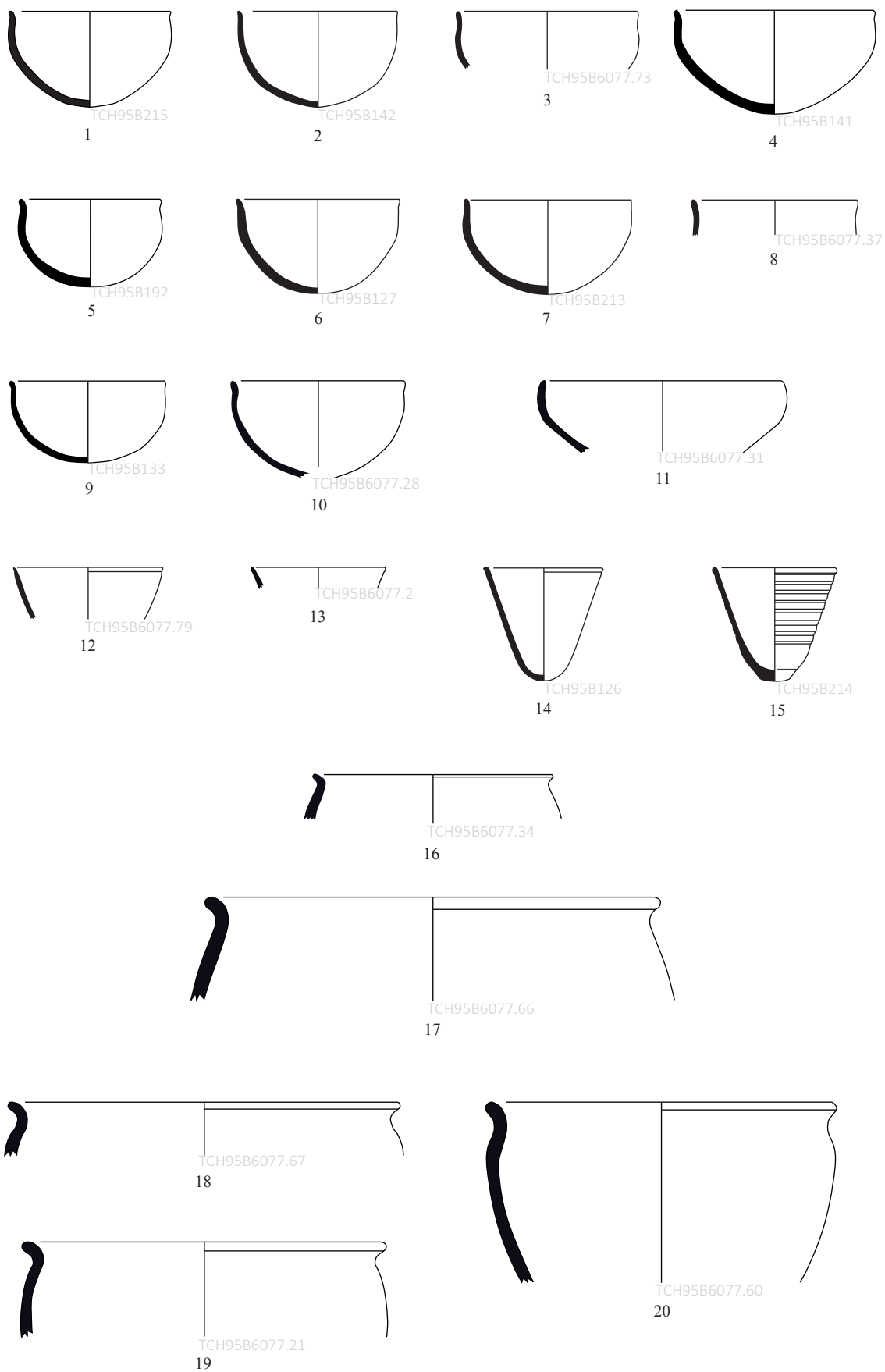

Céramiques communes (suite)



n°	IDpoterie	locus	forme	céra.	façonnage		décor	cui.	« marque »	
					MT	S			type	position
n.i.	TCH95B6077.90	B6077	panse	SW02	III25	4	peinture	B		
n.i.	TCH95B6077.54	B6077	panse	SW04	IB-IIA-III15	4		A2		
1	TCH95B6077.4	B6077	petite jarre 02 A 05	SW01	IB-III12		peinture sur engobe	A3		
2	TCH95B6077.13	B6077	petite jarre 02 B 08	SW01			engobe	A5		
3	TCH95B6077.14	B6077	petite jarre 02 B 08	SW01			engobe	A5		
4	TCH95B181	B6077	petite jarre 02 B 08	SW01	IB-III1235			nd		
5	TCH95B6077.39	B6077	petite jarre 02 B 08	SW01	III2b			A5		
6	TCH95B6077.12	B6077	petite jarre 02 B 08	SW14			peinture	A5		
7	TCH95B202	B6077	petite jarre 02 B 06	nd			peinture	A5		
8	TCH95B6077.46	B6077	jarre OE 02 A 25	SW12	III12			A5		
9	TCH95B6077.80	B6077	petite jarre 02 D 12	SW05				nd		
10	TCH95B6077.72	B6077	petite jarre 03 D 03	SW02				A5		
11	TCH95B209	B6077	petite jarre 02 D 14	nd			peinture	A5		
12	TCH95B130	B6077	petite jarre 02 D 14	SW05	IB-III125		peinture sur engobe ?	A5		
13	TCH95B6077.77	B6077	jarre OE 02 A 26	SW14				A5		
14	TCH95B6077.43	B6077	jarre OL 02 B 16	SW05	III2			A2		
15	TCH95B6077.78	B6077	jarre OL 02 B 16	SW05				A5		
16	TCH95B6077.10	B6077	jarre OL 02 D 19	SW04	III2			A5		
17	TCH95B138	B6077	jarre OL 02 D 20	SW14		2		nd		

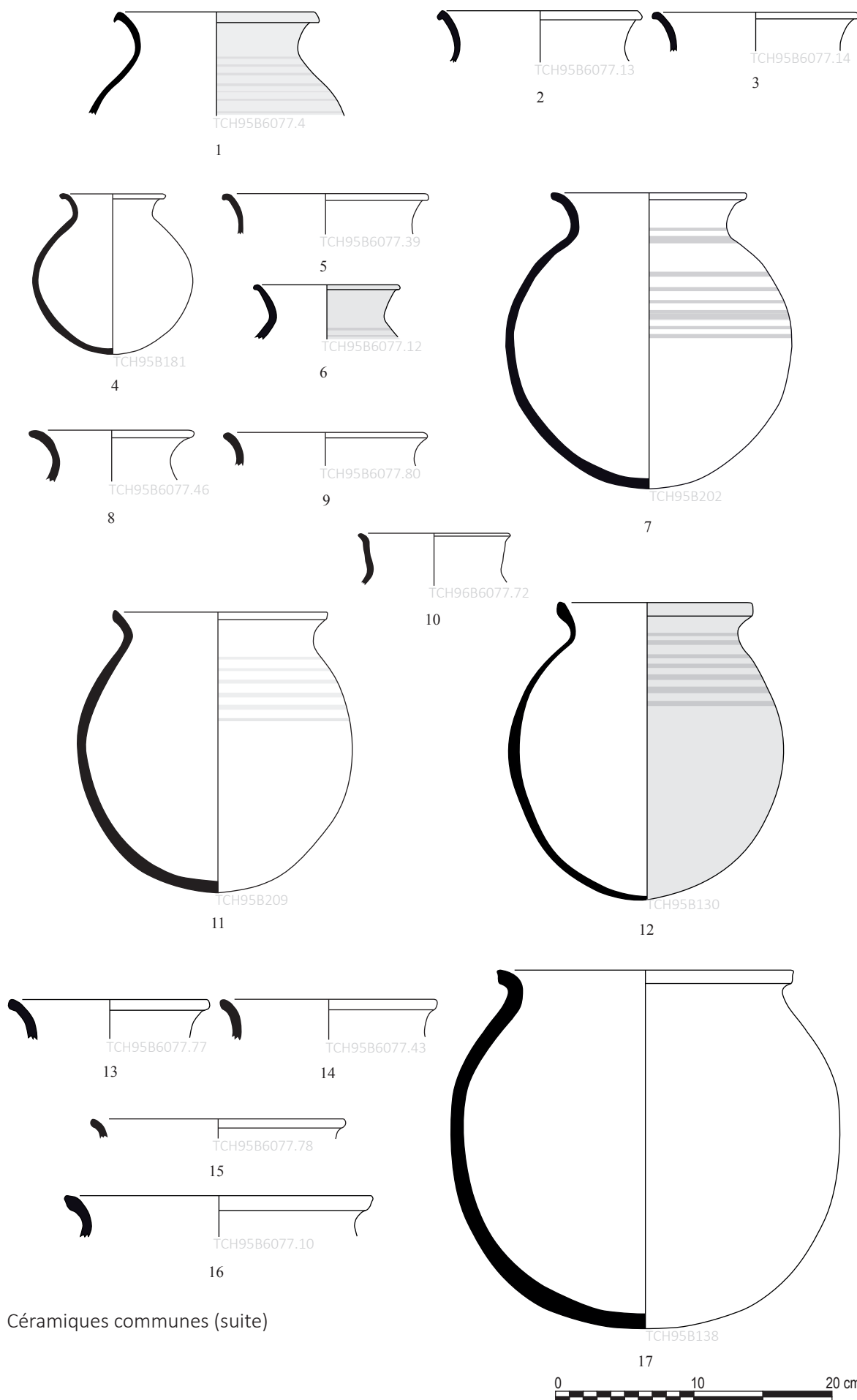

Céramiques communes (suite)

n°	IDpoterie	locus	forme	céra.	façonnage		décor	cui.	« marque »	
					MT	S			type	position
n.i.	TCH95B6077.94	B6077	panse	SW01	IB-IIA			A5		
1	TCH95B6077.56	B6077	panse	SW01	IB-IIB-III2b		peinture sur engobe	A3		
2	TCH95B6077.49	B6077	panse	SW01			peinture sur engobe ?	A5		
3	TCH95B6077.91	B6077	panse	SW02			peinture	A5		
4	TCH95B6077.52	B6077	panse	SW04			engobe réservé	A2		
5	TCH95B6077.95	B6077	panse	SW04			engobe réservé	A5		
6	TCH95B6077.96	B6077	panse	SW07	IB-II-III2		peinture sur engobe	A5		
7	TCH95B6077.11	B6077	grande jarre 03 B 46	SW26	IB-IIB-III2		engobe réservé	A3	incisée	bord, col
8	TCH95B6077.68	B6077	grande jarre 03 B 49	nd – SW				A5		
9	TCH95B6077.23	B6077	grande jarre 03 B 49	nd – SW	IB-IIA-III1	2		A1		





TCH95B6077.56

1



TCH95B6077.49

2



TCH95B6077.91

3



TCH95B6077.52

4



TCH95B6077.95

5

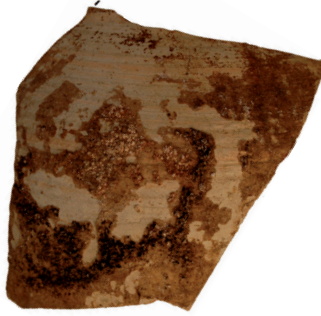

TCH95B6077.96

6

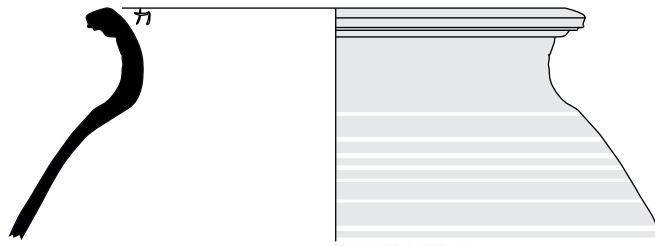

TCH95B6077.11

7

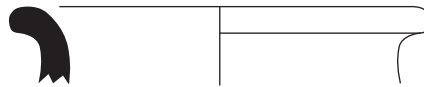

TCH95B6077.68

8

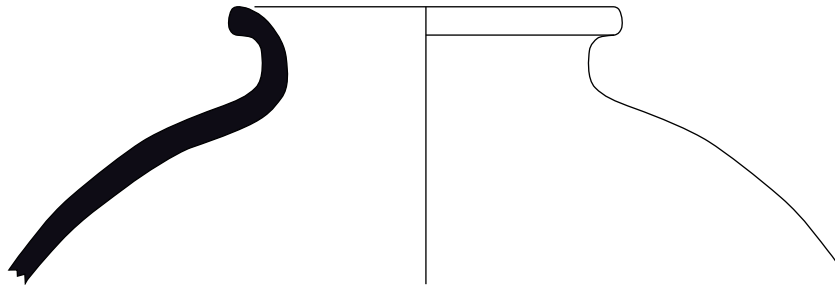

TCH95B6077.23

9

Céramiques communes (suite)



n°	IDpoterie	locus	forme	céra.	façonnage		décor	cui.	« marque »	
					MT	S			type	position
1	TCH95B6077.27	B6077	support 01	SW12	III2b			A5		
2	TCH95B6077.29	B6077	support 01	SW12				A5		
3	TCH95B185	B6077	support 02	nd				0		
4	TCH95B194	B6077	support 03	SW13	IB-IIIB-III2		engobe	A5		
5	TCH95B6077.5	B6077	support 04	SW01	IB-III2		engobe	A5		
6	TCH95B6077.9	B6077	support 05	SW12	IB-IIIB-III2			A5		
7	TCH95B137	B6077	support 05	SW04	IB-IIA-III1	2		A5		
8	TCH95B131	B6077	vase miniature 01	nd	IA	1		A5		
9	TCH95B121	B6077	vase miniature 03 A	SW01	IB-IIIB-III125	4	engobe	A4		
10	TCH95B200	B6077	vase miniature 05	SW04	IA-IIA	1		A2		
11	TCH95B6077.61	B6077	vase miniature 06 B	nd	IB-IIIB			A5		
12	TCH95B122	B6077	vase miniature 06 D	SW04	IIA-III1		pseudo-engobe	A2		
13	TCH95B171	B6077	vase miniature 06 F	SW13	IIA			A5		
14	TCH95B225	B6077	vase miniature 07 B	nd	IB-IIAB-III1235	4	pseudo-engobe	A5		
15	TCH95B208	B6077	vase miniature 07 B	SW01	IB-IIAB-III1235	4	pseudo-engobe	A1		
16	TCH95B6077.93	B6077	base 1A	SW01				A5		
17	TCH95B6077.71	B6077	base 1A	SW02				A5		
18	TCH95B6077.92	B6077	base 1A	SW02				A5		
19	TCH95B6077.15	B6077	base 1A	SW02	IIB-III5	4		A5		
20	TCH95B6077.47	B6077	base 1A	SW02				A5		
n.i.	TCH95B6077.53	B6077	base 1A	SW04	IB-IIIB-III1	4	engobe réservé	A1		
21	TCH95B6077.50	B6077	base 1A	SW05			engobe réservé	A3		
22	TCH95B6077.48	B6077	base 2	SW02				A5		

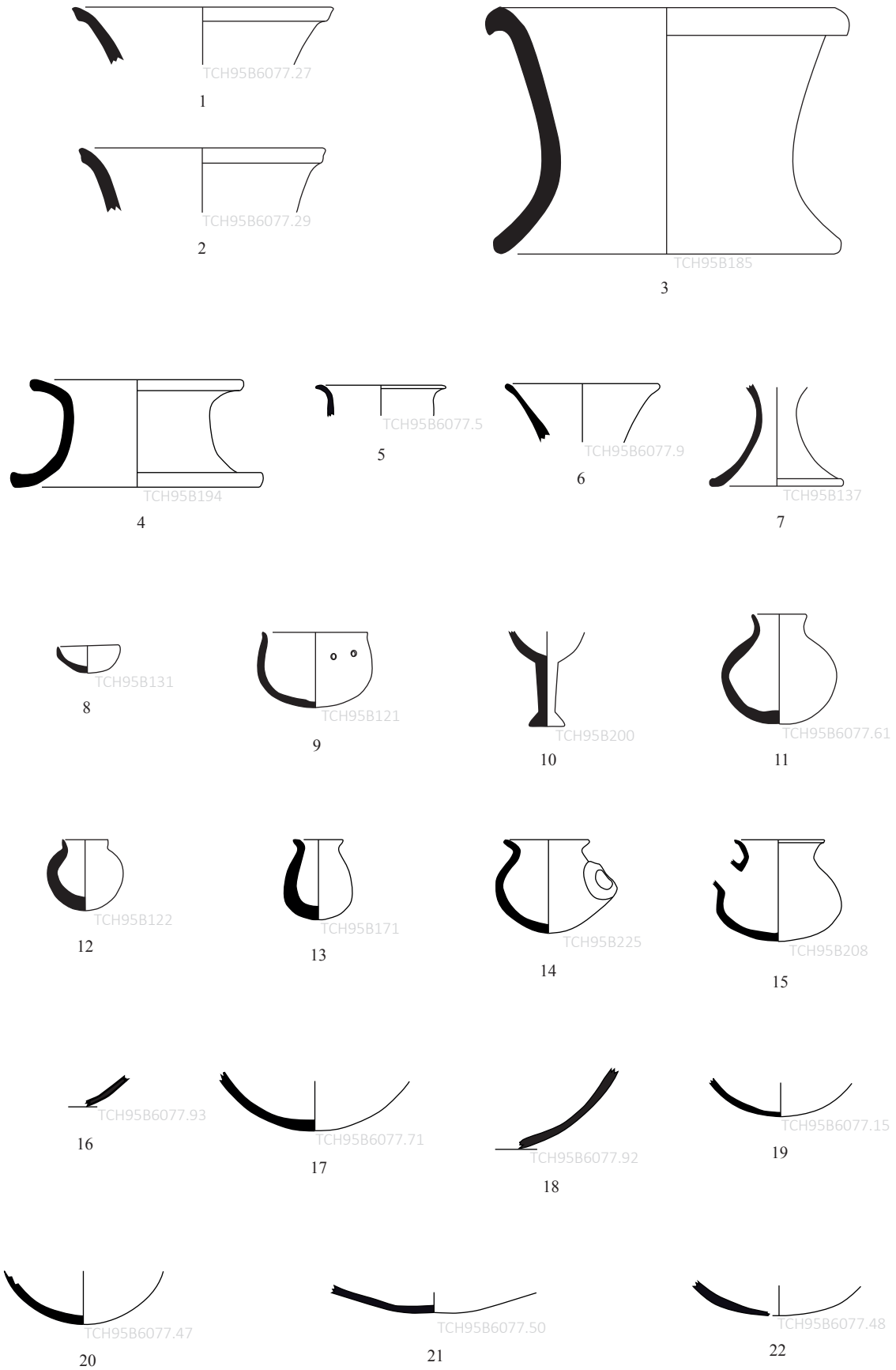

Céramiques communes (suite)



Catalogue 112

n°	IDpoterie	locus	forme	céra.	façonnage		décor	cui.	« marque »	
					MT	S			type	position
1	TCH95B206	B6077	couvercle ?	GM				B		
2	TCH95B6077.89	B6077	jatte 02 t	GM	IB-IIA-III6	3		B		
3	TCH95B6077.19	B6077	marmite 01	GM		3		A5		
4	TCH95B6077.88	B6077	marmite 02 A	GM				B		
5	TCH95B6077.20	B6077	marmite 02 A	GM	IB-IIA-III6	3		A5		
6	TCH95B6077.17	B6077	marmite 02 A	GM	IB-IIA-III6a	3		A2		
7	TCH95B6077.84	B6077	marmite 02 A	GM				A2		
8	TCH95B6077.85	B6077	marmite 02 B	GM				B		
n.i.	TCH95B6077.86	B6077	marmite 02 B	GM			lissage	A5		
9	TCH95B6077.83	B6077	marmite 02 B	GM	IB-IIA-III6	3		A5		
10	TCH95B6077.82	B6077	marmite 02 B	GM				A5		
11	TCH95B6077.87	B6077	marmite 02 C	GM				B		
12	TCH95B6077.18	B6077	marmite 02 C	GM	IB-IIA-III6a	3		A4		
13	TCH95B6077.81	B6077	marmite 02 C	GM			polissage	A1		
n.i.	TCH95B6077.30	B6077	panse	GM	IIA-III6a	3		A5		

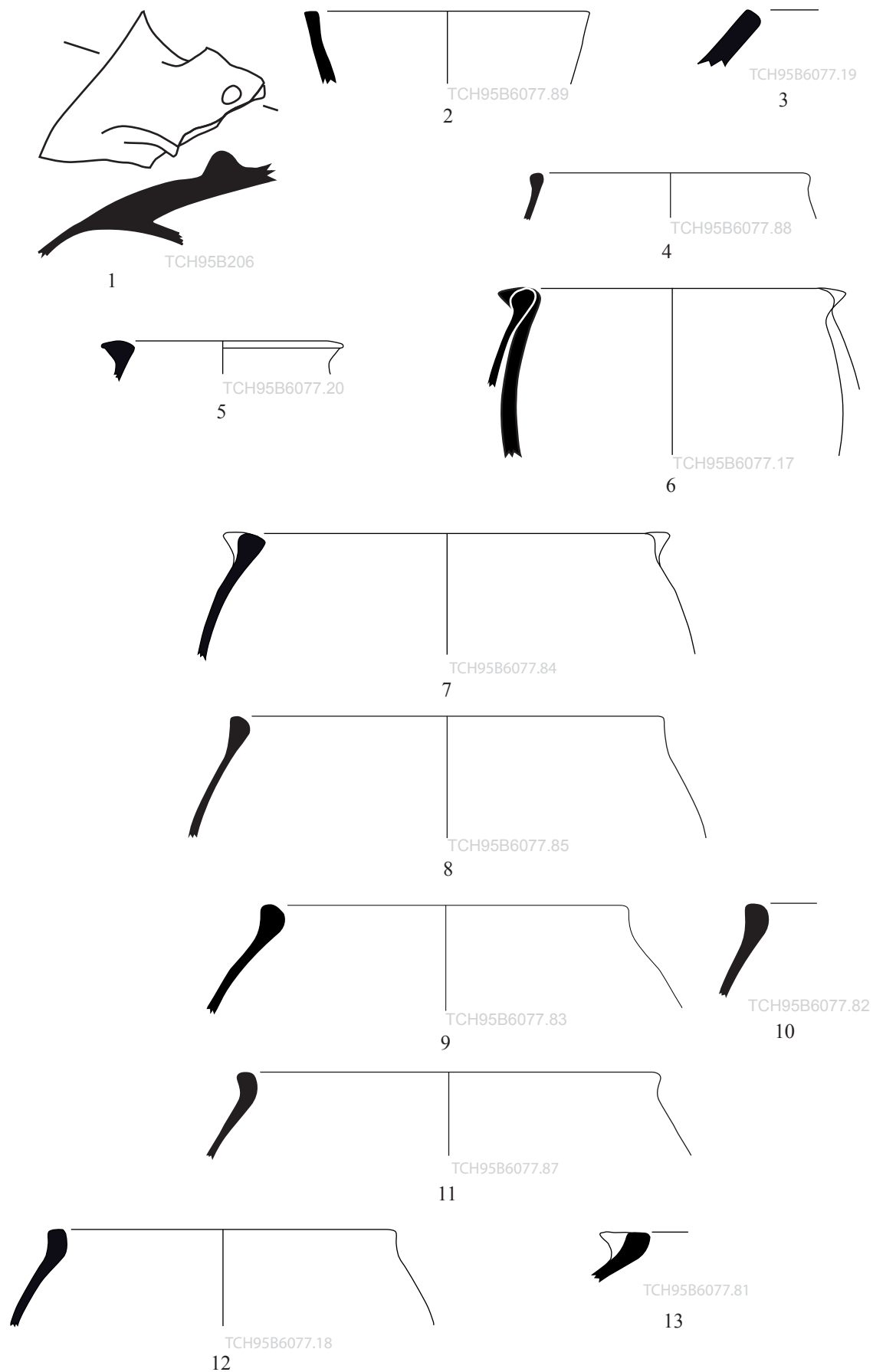

Céramiques à dgraisant minéral grossier (GM)



Catalogue 113

n°	IDpoterie	locus	forme	céra.	façonnage		décor	cui.	« marque »	
					MT	S			type	position
1	TCH95B6077.65	B6077	pot 01 a	nd				A5		
2	TCH95B6077.22	B6077	grande jarre 02 50	GV	IB-III2b			A4		
3	TCH95B6077.24	B6077	grande jarre 02 50	GV	IB-IIA-III12	2		A5		
4	TCH95B6077.64	B6077	grande jarre 02 50	GV	IB-IIA-III12	2		A5		

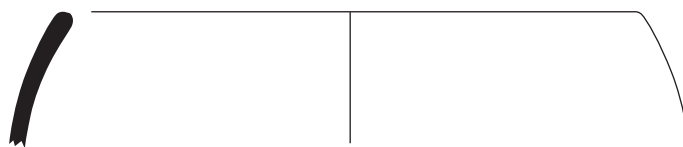

TCH95B6077.65

1

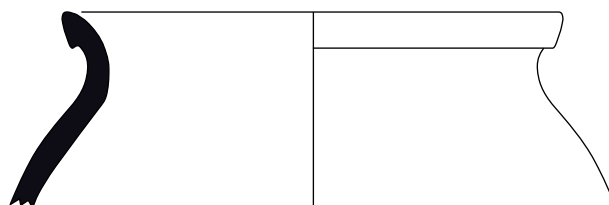

TCH95B6077.22

2

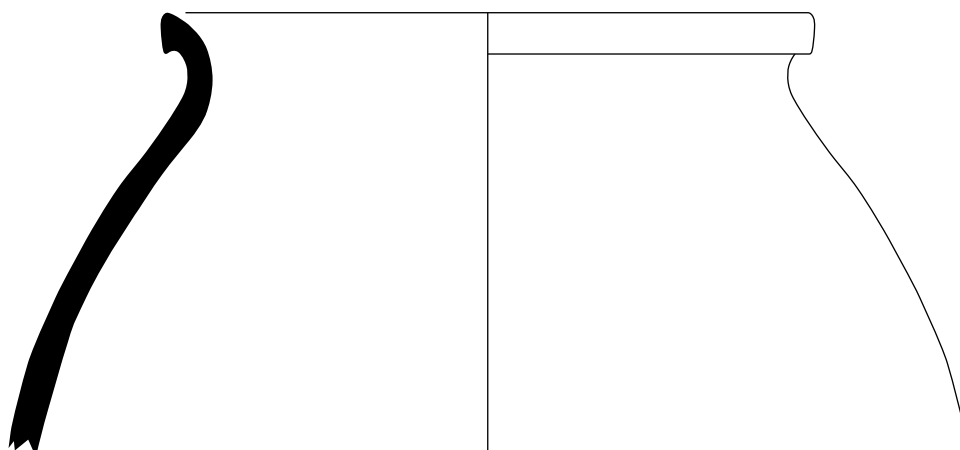

TCH95B6077.24

3

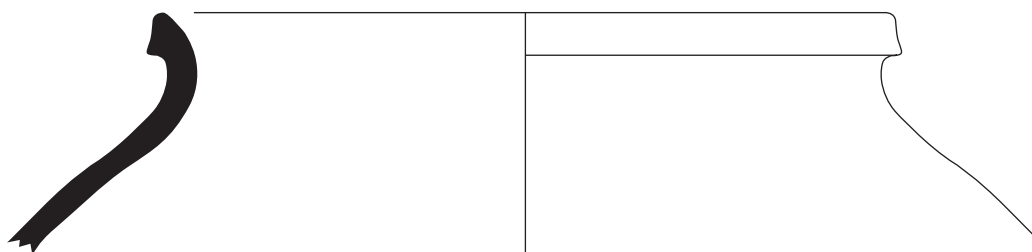

TCH95B6077.64

4

Céramiques à dégraissant végétal grossier (GV)



Catalogue 114

n°	IDpoterie	locus	forme	céra.	façonnage		décor	cui.	« marque »	
					MT	S			type	position
1	TCH95B6077.25	B6077	grande jarre 02 53	GV	IB-IIA-III1	2		A1		
2	TCH95B6077.63	B6077	grande jarre 02 53	GV				A2		
3	TCH95B6077.62	B6077	grande jarre 01 52	GV				A4		
4	TCH95B6077.32	B6077	support	GV	IB-IIA-III12	2		A2		



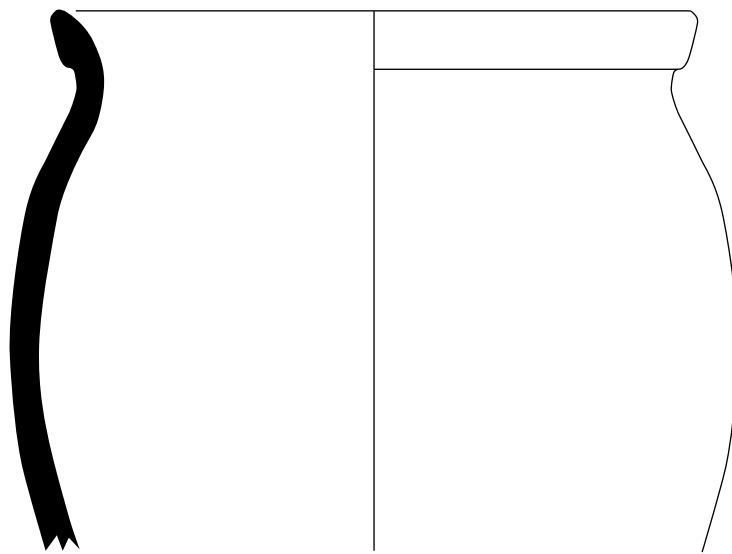

TCH95B6077.25

1

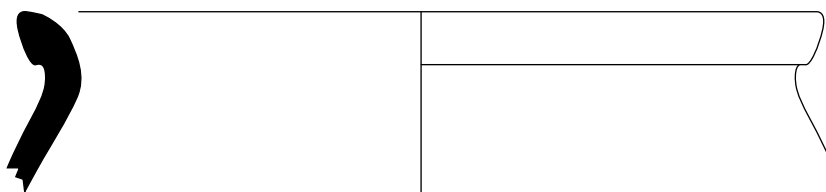

TCH95B6077.63

2

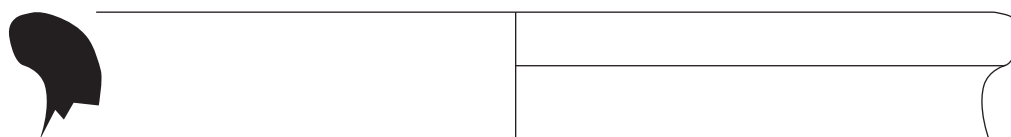

TCH95B6077.62

3

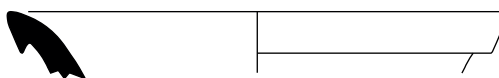

TCH95B6077.32

4

Céramiques de stockage (gv)



Catalogue 115

n°	IDpoterie	locus	forme	céra.	façonnage		décor	cui.	« marque »	
					MT	S			type	position
1	TCH95B135	B6077	petite jarre 03 E 05	MW 2	IB-III4a	5	pseudo-engobe (fortuit)	B		
2	TCH95B6077.6	B6077	petite jarre 03 E 05	MW 8	III2		pseudo-engobe (fortuit?)	A4		
3	TCH95B6077.44	B6077	petite jarre 03 E 05	MW 9				A5		
4	TCH95B6077.55	B6077	panse	MW 6	III2		coloration par tournassage	A5		
5	TCH95B6077.16	B6077	base 1A	MW 9	IIB-III4	5	pseudo-engobe (fortuit)	A3		
6	TCH95B6077.36	B6077	vase miniature 06 A	SEW				B		

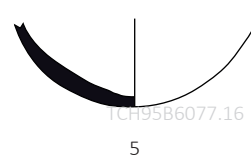
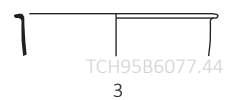
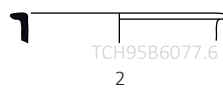
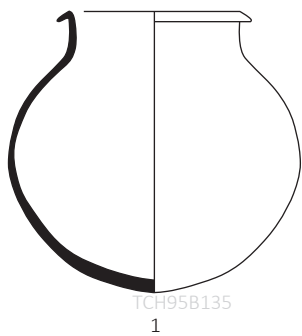

Céramiques métalliques

---

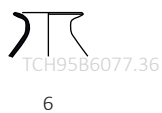

Céramiques noires de l'euphrate



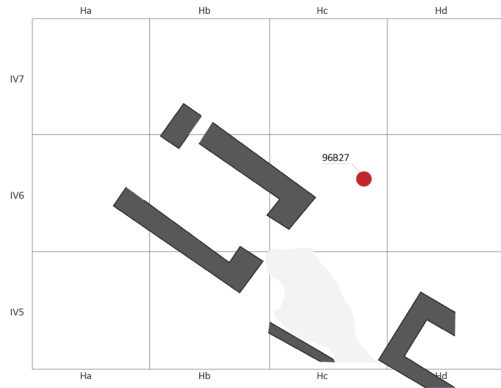

TCH96B27

Canalisation

		sw	gm	gv	mw	ew
NR	<b>154</b>	115	5	34		
NMI	<b>29</b>	26	(1)	1	1	
DIA	<b>31</b>	29		1	1	

n°	IDpoterie	locus	forme	céra.	façonnage		décor	cui.	« marque »	
					MT	S			type	position
1	TCH96B27.27	96B27	plaque l	SW04b	IB-IIA	2		A2		
2	TCH96B27.15	96B27	bol bas 03 C i	SW01				A3		
3	TCH96B27.4	96B27	bol bas 03 C i	SW01			pseudo-engobe (VO)	A5		
4	TCH96B27.8	96B27	bol 01 A a	SW02	IB-IIB-III2			A5		
5	TCH96B27.12	96B27	bol 01 A d	SW01			pseudo-engobe (VO)	A5		
6	TCH96B27.1	96B27	bol 01 A d	SW02				A5		
7	TCH96B27.6	96B27	bol 01 A e	SW02	IB-IIB-III2			A5		
8	TCH96B53	96B27	bol 01 C c	nd – SW	IB2-IIB-III24	5	pseudo-engobe (VO)	A5		
9	TCH96B27.13	96B27	bol 02 A d	SW02				A5		
10	TCH96B27.9	96B27	bol 03 B i	SW02				A5		
11	TCH96B27.11	96B27	bol 05 A k	SW01			pseudo-engobe (VO)	A2		
12	TCH96B27.3	96B27	bol 05 B j	SW01			pseudo-engobe (VO)	A5		
13	TCH96B27.2	96B27	bol 05 B l	SW01	IB-IIB-III2		pseudo-engobe (VO)	A2		
14	TCH96B27.7	96B27	bol 06 A c	SW01				A2		
15	TCH96B27.21	96B27	bol 06 A c	SW01				A1		
16	TCH96B55	96B27	bol 06 A d	SW02	IB			A5		
17	TCH96B27.25	96B27	gobelet 02 c	SW01	IB-IIB-III2			A5		
18	TCH96B27.18	96B27	pot 03 A u	SW12				A2		

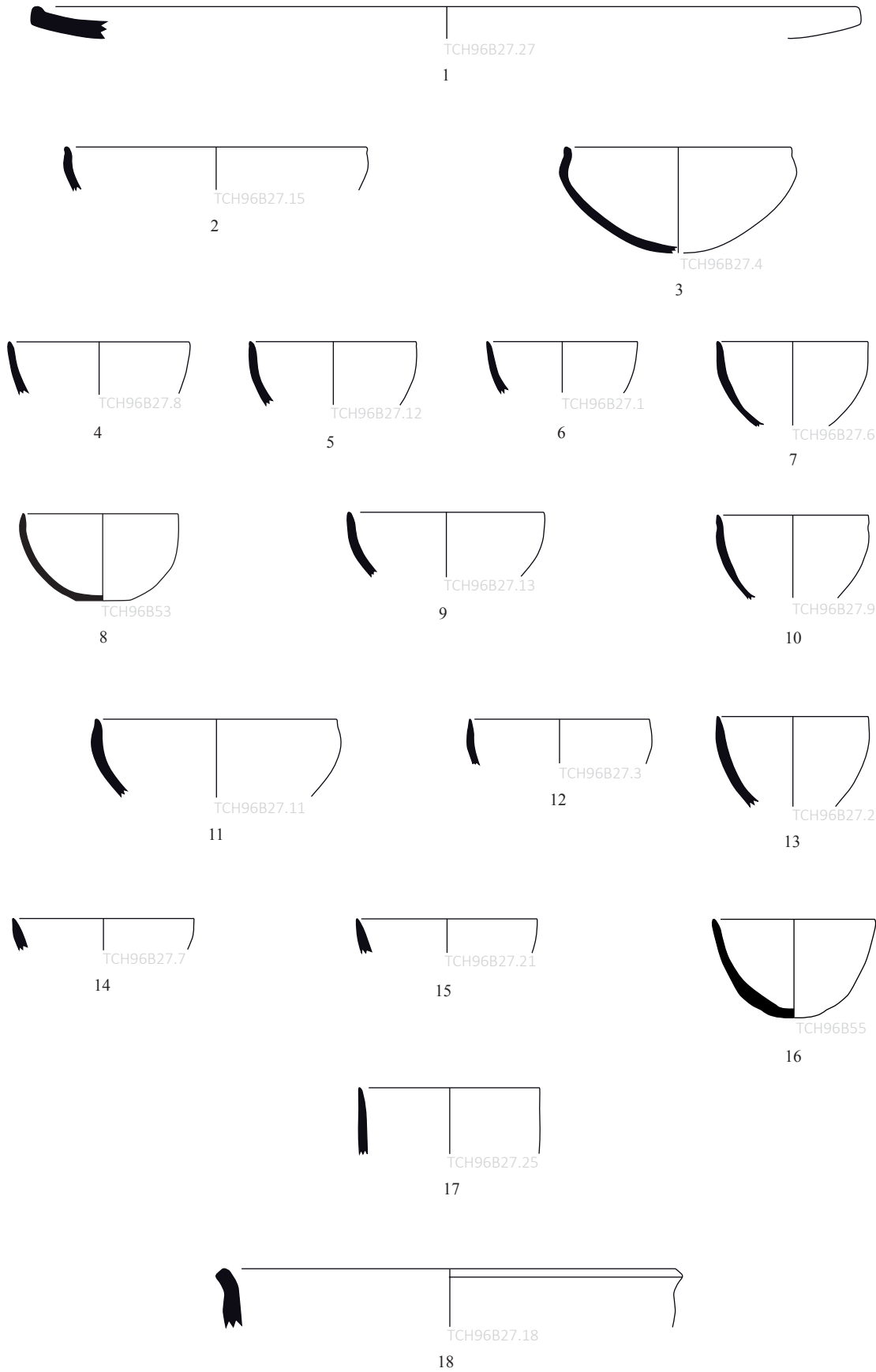

Céramiques communes



n°	IDpoterie	locus	forme	céra.	façonnage		décor	cui.	« marque »	
					MT	S			type	position
1	TCH96B27.23	96B27	jarre OE 02 B 25	SW07	IB-III2		engobe	A2		
2	TCH96B27.22	96B27	jarre OE 02 B 25	SW13			engobe	A5		
3	TCH96B27.5	96B27	jarre OE 03 B 30	SW04	IB-III2			A5		
4	TCH96B27.24	96B27	jarre OL 02 B 37	SW04				A2		
5	TCH96B27.16	96B27	jarre OL 02 B 37	SW04				A5		
6	TCH96B27.14	96B27	vase miniature 07 A	SW01			engobe	A5		
7	TCH96B54	96B27	vase miniature 09 E	SW07	IIA			A2		
8	TCH96B27.20	96B27	support ?	SW05				A5		
9	TCH96B27.17	96B27	base 2	SW02	IB2-IIIB-III4	5		A5		
n.i.	TCH96B27.28	96B27	base 2	nd - SW	IB-IIIB-III24	5		ND		
10	TCH96B27.19	96B27	base 2	SW01	IB2-IIIB	5	pseudo-engobe	A5		
11	TCH96B27.26	96B27	grande jarre 02 54	GV				A1		
12	TCH96B27.10	96B27	vase miniature 06 H	MW 2	III4	5		B		

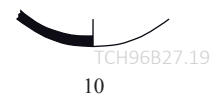
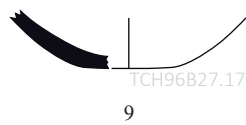
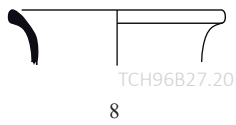
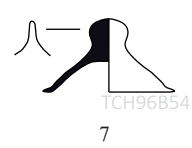
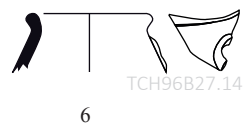
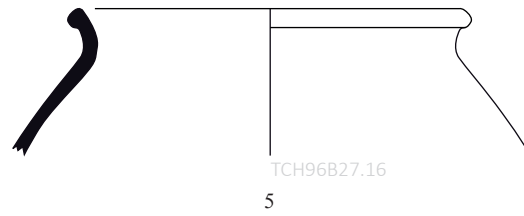
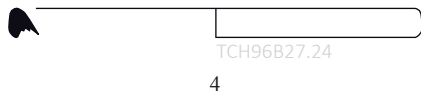
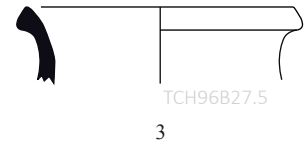
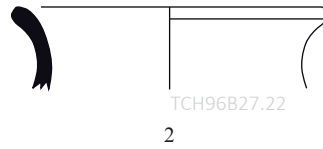
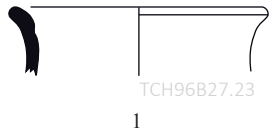

Céramiques communes (suite)

---

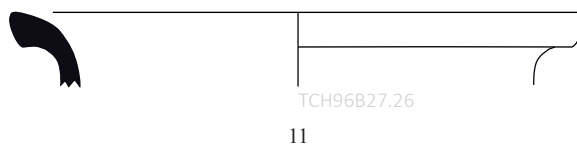

Céramiques de stockage (gv)

---

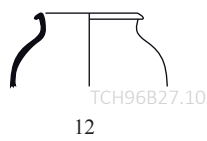

Céramiques métalliques



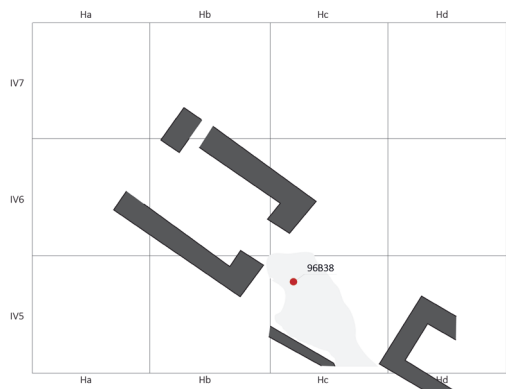

TCH96B38

Cailloutis

		sw	gm	gv	mw	ew
NR	<b>29</b>	23		6		
NMI	<b>6</b>	4		(1)	1	
DIA	<b>7</b>	6			1	

n°	IDpoterie	locus	forme	céra.	façonnage		décor	cui.	« marque »	
					MT	S			type	position
1	TCH96B38.3	96B38	gobelet 02 c	SW02	IB-IIIB-III24	5	pseudo-engobe (VO)	A5		
2	TCH96B38.6	96B38	jatte 01 r	nd			engobe	A2		
3	TCH96B38.7	96B38	support ?	SW04			engobe	A2		
4	TCH96B38.2	96B38	panse	nd	IB-III2		incision	A5		
5	TCH96B38.5	96B38	panse	SW04			incision	A5		
6	TCH96B38.4	96B38	base 3B	SW01				A5		
7	TCH96B38.1	96B38	petite jarre 03 B 05	MW 6	III4	5		A4		



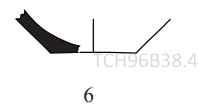
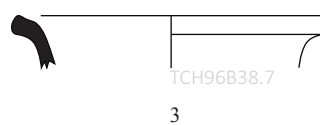
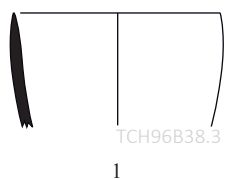

Céramiques communes

---

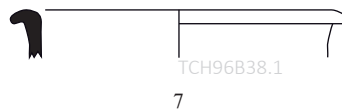

Céramiques métalliques







## Traditions céramiques en Jezira occidentale au III<sup>e</sup> mill. av. J.-C. : la poterie du secteur B de Tell Chuera

### Résumé

*L'étude des poteries mises au jour dans un secteur de production (secteur B) associé aux activités économiques de l'un des principaux temples du site de Tell Chuera (Syrie du Nord) permet d'appréhender les modes de production, de diffusion et d'utilisation des céramiques de ce centre urbain, vers 2500 av. J.-C. Après une présentation des cadres géographique, historique et historiographique de cette étude, une synthèse des données disponibles rappelle les caractéristiques techniques et morphologiques propres aux assemblages de Jezira occidentale et des régions voisines pendant la période EJZ 3, de façon à confronter la composition de ces assemblages aux données existantes sur la production, la diffusion et la fonction des poteries dans ces diverses régions. L'analyse technologique, archéométrique et morphologique du corpus montre le caractère spécialisé des productions pendant cette période. Toutefois, les potiers de Tell Chuera ne maîtrisaient que partiellement l'utilisation du tour. Outre les choix effectués en raison des contraintes techniques liées au façonnage de certaines formes, l'analyse met en évidence le caractère techno- et morpho-fonctionnel de certaines poteries, en particulier celles destinées au stockage et à la cuisson. La morphométrie des récipients ne permet cependant qu'une approche fonctionnelle limitée et souligne la nature multifonctionnelle des vases. À l'exception de rares espaces dans lesquels la présence d'installations et de mobilier permet de restituer les activités auxquelles ils étaient dédiés, le contenu des vases retrouvés in situ reste inconnu. Finalement, l'étude comparative permet de situer le corpus dans le contexte régional et interrégional de la fin de la période EJZ 3a/ EME 3. Outre l'existence de réseaux de distribution régionaux dans le wadi Hamar, peut-être jusqu'à la vallée du Balikh, les parallèles témoignent d'échanges à l'échelle interrégionale et attestent en particulier l'importation de denrées depuis le bassin de Karababa.*

**Mots-clés :** Syrie ; Jezira ; Tell Chuera ; EME 3/4 ; EJZ 3 ; poterie ; production ; diffusion ; échanges ; fonction.

## Töpfertraditionen in der westlichen Jezira im 3. Jt. v. Chr. : Die Keramik aus Bereich B von Tell Chuera.

### Zusammenfassung

*Anhand der Untersuchung der Keramik aus einem Produktionsbereich (Bereich B), der sich in einer sakralen Anlage der Oberstadt Tell Chueras (Nordostsyrien) befindet, befasst sich diese Studie mit der Produktion, der Distribution und der Funktion von Töpferwaren in dieser Stadt um 2500 v. Chr. Ein Überblick über den geographischen, historischen und historiographischen Rahmen befindet sich am Anfang der Studie. Eine Synthese der veröffentlichten Daten befasst sich mit den technischen und morphologischen Merkmalen der Töpferwaren in der westlichen Jezira und den angrenzenden Regionen während der EJZ 3 Periode, um die Assemblagen und die Daten über die Organisation der Produktion, der Distribution und der Funktion von Keramik in diesen unterschiedlichen Regionen in Beziehung zu setzen. Im zweiten Teil der Arbeit bestätigt die technologische, archäometrische und morphologische Untersuchung der Keramik aus Bereich B die Spezialisierung der Produktion in dieser Zeit. Jedoch, beherrschten die Töpfer aus Tell Chuera nur teilweise die Benutzung der Drehscheibe und passten den Produktionsprozess an technische Zwänge an. Ausserdem sind die technischen und morphologischen Merkmale einiger Töpferwaren in Zusammenhang mit ihrer Funktion zu sehen. Im dritten Teil wird gezeigt, dass Morphologie und Dimensionen begrenzte Indizien für Funktionbestimmung der Gefässe sind und eher ihre multifunktionalen Eigenschaften zeigen. Mit Ausnahme einiger Räume, in denen Installationen und Funde die Bestimmung einer Funktion ermöglichen, bleibt der Inhalt der in situ gefundenen Gefässe unbekannt. Zum Schluss wird die Keramik aus Bereich B in den regionalen und interregionalen Kontext am Ende der EJZ 3a/ EME 3 Periode gestellt. Anhand der Vergleiche wird die Hypothese der Distribution einiger Keramikproduktionen innerhalb der Wadi Hamar Region und bis zum Balikhthal aufgestellt. Einige Parallelen beweisen den interregionalen Austausch und im Speziellen den Import von Esswaren aus der Karababa Region.*

**Keywords :** Syrien ; Jezira ; Tell Chuera ; EME 3/4 ; EJZ 3 ; Keramik ; Produktion ; Distribution ; Warenaustausch ; Funktion.

UNIVERSITÉ PARIS-SORBONNE / ÉCOLE DOCTORALE 6 : Histoire de l'Art et Archéologie  
Ecole Doctorale 0124 - Université Paris-Sorbonne, Bureau 233, Galerie Colbert-INHA, 2 rue Vivienne, 75002 Paris.  
**DISCIPLINE :** Archéologie du Proche-Orient

GOETHE UNIVERSITÄT - FRANKFURT AM MAIN / FACHBEREICH 09 : Sprach- und Kulturwissenschaften  
Dekanat des FB 09 - Goethe Universität, Postfach 11 19 32, 60054 Frankfurt am Main.