



HAL
open science

Quantifying the Laffer Curve on the Continued Activity Tax in a Dynastic Framework

Jean-Olivier Hairault, François Langot, Thepthida Sopraseuth

► **To cite this version:**

Jean-Olivier Hairault, François Langot, Thepthida Sopraseuth. Quantifying the Laffer Curve on the Continued Activity Tax in a Dynastic Framework. *International Economic Review*, 2008, 49 (3), pp.755-797. <10.1111/j.1468-2354.2008.00497.x>. <halshs-00178465>

HAL Id: halshs-00178465

<https://shs.hal.science/halshs-00178465v1>

Submitted on 11 Oct 2007

HAL is a multi-disciplinary open access archive for the deposit and dissemination of scientific research documents, whether they are published or not. The documents may come from teaching and research institutions in France or abroad, or from public or private research centers.

L'archive ouverte pluridisciplinaire HAL, est destinée au dépôt et à la diffusion de documents scientifiques de niveau recherche, publiés ou non, émanant des établissements d'enseignement et de recherche français ou étrangers, des laboratoires publics ou privés.



HAL Authorization

Quantifying the Laffer Curve on the Continued Activity Tax in a Dynastic Framework ^{*†}

By JEAN-OLIVIER HAIRAUT, FRANÇOIS LANGOT AND THEPHTIDA SOPRASEUTH ¹

*Paris School of Economics (PSE), IZA and University of Paris 1 Panthéon-Sorbonne, France,
University of Maine, GAINS, PSE, France, University of Evry, EPEE, PSE, France*

It is argued that the tax on continued activity should be removed by implementing actuarially-fair schemes. However, these schemes cannot fund the expected Social Security deficit. This paper proposes to give individuals a *fraction* of the actuarially-fair incentives in the case of postponed retirement. Social Security faces a trade-off between giving enough incentives to make individuals delay retirement and giving little increase in pensions in order to help finance its expected deficit. This trade-off is captured by a Laffer curve. Finally, when the Social Security system aims to maximize welfare, the optimal tax on postponed retirement is still strictly positive.

JEL Classification: H31, H55, J26

*Manuscript received December 2004; revised May 2007

†Email: joh@univ-paris1.fr; flangot@univ-lemans.fr; tsoprased@univ-evry.fr

¹The authors acknowledge financial support from the Commissariat Général au Plan. We benefited from fruitful discussions with L. Caussat, P. Y. Hénin, T. Japelli, M. Juillard, M. Pagano, P. Pestieau, B. Sédillot, E. Walraet and T. Weitzenblum. We thank anonymous referees for helpful comments as well as seminar participants at the EEA Congress (Stockholm, 2003), ESEM (Madrid, 2004) the Society for Computational Economics meeting (Seattle, 2003), the CSEF (Naples, 2003), the SED meeting (Paris, 2003), the workshop on intergenerational transfers (Paris, 2003), the Association Française des Sciences Economiques (Paris, 2003), the Scientific Workshop of the Caisse des Dépôts et Consignations (Bordeaux, 2003), T2M (Orléans, 2004), Fourgeaud seminar (Paris, 2003) and Society of Labor Economics - European Association of Labor Economics (San Francisco, 2005). Errors and omissions are ours.

Keywords: retirement behavior and wealth, actuarially-fair benefits.

1 Introduction

Ageing jeopardizes the sustainability of Pay-As-You-Go (PAYG) systems. Social Security (SS) provisions exacerbate this financial fragility by providing huge incentives to leave the labor force early. Gruber and Wise (1998, 2004) have extensively documented the existence of a substantial tax on continued activity, especially in Europe. Faced with the changing demographic trend of an ageing population, most developed countries have accordingly chosen to encourage the elderly to delay retirement by rewarding a longer working life with an increased pension. It is often argued that Social Security provisions should be actuarially neutral at the margin (see for instance Lindbeck and Persson, 2003): contributions collected during additional working years and the foregone pensions due to this delayed retirement should be exactly matched by an increase in the value of the pension received over a shorter retirement period. However, by definition, an actuarially-fair scheme cannot help finance the expected Social Security deficit inherent in economies containing an ageing population. Drastic Social Security reforms such as those in Sweden and Italy could be viewed as an attempt to implement a pension system with an actuarially-fair flavor, while the recent French reform has introduced pension adjustments which are far from being neutral. What is the suitable fraction of the actuarially-fair scheme that individuals should be given? Actually, it is fairly intuitive that Social Security systems face a trade-off between giving enough incentives to make individuals actually postpone retirement and giving little increase in Social Security provisions in order to generate a financial surplus. In this paper, we aim first at quantifying the size of this trade-off, which will be captured by a Laffer curve.

If this view can receive some support on public finance grounds, it may be highly questionable from a welfare point of view. Why should the tax imposed by the SS system not be fully removed? The complete elimination of the tax distortion is beyond doubt welfare-improving, even if it does not help ensure the sustainability of the PAYG system. However, it is not necessarily welfare-optimizing in a second best world ². In this paper, we show that it could be efficient, even when

²Cremer et al. (2004) raise the same question. They show that the tax on postponed retirement can be used for redistributive purposes when non-distortionary tools are not available.

adopting a welfare view, to maintain a strictly positive tax on continued activity. Transferring the financial surplus generated by older workers who delay retirement to younger workers could be welfare-increasing if the latter are liquidity constrained and face uninsurable risks during the working life. This transfer could typically take the form of a decrease in the payroll tax. This is not to say that this policy is necessarily the optimal way to deal with expected deficits but that it may be welfare-improving relative to the status quo.

We propose in this paper to cope with the issue of retirement decisions in relation with SS provision reforms. This question is at the heart of recent SS reforms in Europe, beyond the question of the relative efficiency of funded versus PAYG systems, which has been extensively analyzed in recent papers (see Imrohorglu et al., 1999; Conesa and Krueger, 1999; Storesletten et al., 1999; Fuster et al., 2003). These works develop overlapping generation models with borrowing constraints and altruism along with several sources of uncertainty. Heterogenous agent models can replicate the salient features of the wealth distribution and measure the consequences of various retirement systems on the capital stock. However, these studies take retirement behavior to be fixed. Conversely, studies of retirement (Rust, 1989; Stock and Wise, 1990; Berkovec and Stern, 1991; Rust and Phelan, 1997) assume that capital markets are perfect, so that saving and consumption decisions are made in the background and do not affect retirement decisions. Our paper tries to merge both literatures by taking into account the interaction between wealth and retirement decisions³. Incentive schemes could lead to boosting the role of wealth and thereby to much more heterogeneity in the retirement age. Moreover, the originality of our approach lies in the analysis of how altruism and earning risks across generations affect retirement behavior when borrowing constraints exist. Along these lines, we extend Fuster (1999) and Fuster et al. (2003)'s analysis of the role of altruism on Social Security reform to encompass retirement decisions. We think that a dynastic framework is well-suited to quantify the Laffer curve on the continued activity. Altruism running from parent to child is a necessary feature to generate empirically realistic wealth heterogeneity (see Fuster, 1999; De Nardi, 2004). This heterogeneity is likely to be linked with the distribution of retirement ages. Altruism may also affect more directly the retirement decisions as the precautionary saving motive against the

³Recent papers have also tackled this issue (see Diamond and Hausman, 1984; Kahn, 1988; Coile et al., 2002; der Klaauw and Wolpin, 2002; Gustman and Steinmeir, 2002).

earning risks at birth could make agents willing to work longer⁴.

Our quantitative exercise relies on French data. Indeed, France is an extreme case of defined pension plans: little freedom is left to individuals as far as retirement decisions are concerned. It was only in 2003 that the SS reform has introduced a 3% pension adjustment for any additional working years beyond the normal number of contributive years. This paper is an attempt to assess the rationality of such a reform, which seems far from the actuarially-fair adjustment. Before quantifying the Laffer curve on the continued activity tax, we show that the impact of actuarially-fair adjustments on retirement decisions is significant. In addition, starting from the current homogenous retirement behavior, introducing incentives leads to more heterogeneity in the retirement age.

We show in a stationary regime that the implicit tax on continued work inherent in the current Social Security scheme led the French economy to be located on the right-hand side of the Laffer curve before 2003: from a public finance point of view, it may be efficient to reduce this tax by allowing agents to delay retirement in order to receive additional pensions, but only a fraction (45%) of the actuarially-fair scheme must be given to these agents in order to maximize the budget surplus of the PAYG system. This result gives some support for the 3% pension adjustments put in place very recently by the 2003 French SS reform, which appears very close to the maximum of the Laffer curve.

However, maintaining a tax on continued activity may be also justified on welfare grounds. Combining decreases in the marginal tax on continued activity and in the average payroll tax is welfare-improving in terms of new-born generation expected utility. This policy yields a better consumption smoothing over the life cycle for liquidity-constrained younger workers who then benefit from a payroll tax decrease due to the surpluses generated by the delaying of retirement. Beyond this intertemporal transfer, incentive schemes also lead to transfers across abilities. High-skilled workers delay retirement more than low-skilled agents, thereby generating SS surplus. This allows a decrease in the SS contribution rate that is particularly beneficial to low-skilled workers. Indeed, these agents are the most liquidity-constrained in the economy. From a welfare point of view, it is optimal to give individuals 85% of the actuarially-fair incentive versus 45% for the maximum of the Laffer curve.

⁴Low (2005) proposes a comprehensive analysis of the role of self-insurance in a life-cycle model of labor supply and savings, but in partial equilibrium and for the intensive margin of labor.

Finally, the sensitivity analysis reveals the importance of taking into account intergenerational linkages. It appears that altruism is crucial to the understanding of the elasticity of retirement age to incentives. As altruistic older workers desire to insure their offspring against earning risks at birth, they choose to postpone retirement in as far as they are eager to accumulate large bequests. A precautionary saving motive at the end of the working life strongly influences the retirement age. For instance, shutting off the effect of intergenerational linkages leads to increase the dependency ratio by more than 3 percentage points when actuarially-fair pensions adjustments are given. In this case, the trade-off inherent in the Laffer curve worsens. More incentives must be given, and the SS budget surplus decreases by a third.

The paper is organized as follows. We present our benchmark model (Section 2), its calibration and its consistency with actual data (Section 3). We then assess the impact of incentive schemes on retirement behavior (Section 4), thereby stressing the strong interaction between wealth and retirement decisions. In Section 5, we quantify the Laffer curve on the continued work tax and perform the welfare analysis before gauging the robustness of our results by changing key parameters (Section 6). Section 7 concludes.

2 The model economy

The model analyzed in this section is a modified version of the stochastic neoclassical growth model with uninsured idiosyncratic risk and no aggregate uncertainty. We consider a large number of individuals with identical preferences. They go through the life cycle stages of working age and retirement. One of the key features of our model is that the retirement age derives from an endogenous decision as in Rust and Phelan (1997). Following Castañeda et al. (2003) here, agents age stochastically. Upon death, individuals are replaced by other individuals of the same dynasty and are imperfectly altruistic towards them.

In addition, individuals face two sources of capital market inefficiency. The first stems from market incompleteness that prevents them from insuring against idiosyncratic risks: they can only hold a risk-free asset in order to smooth consumption over time. The second relies on a liquidity constraint: individuals are not allowed to run into debt. Agents cannot borrow against the present value of the Social Security claims (in contrast to Fuster, 1999).

2.1 The French pension system

The French pension system consists of a wide range of pension schemes. Farmers, civil servants, wage earners and self-employed people subscribe to different retirement plans. In this paper, we focus on the pension plans of wage earners in private firms. Approximately 70% of the labor force falls under this so-called “General Regime” (GR) which constitutes the first pillar of the French SS system. This regime is based on defined pension plans and managed by a State agency (CNAV). Its US counterpart is the Old Age and Survivors Insurance (OASI).

The French SS system also relies on a second pillar, which consists of mandatory complementary schemes, organized and managed on an occupational basis. Both retirement plans are pay-as-you-go systems, but they are characterized by separate budgets. Depending on the occupational group, 30 to 50% of the retirement pension is paid by complementary schemes. These latter cannot be discarded when analyzing retirement decisions. However, policy debates focus on how the computation of GR benefits could be modified in order to encourage people to postpone retirement. Besides, the General Regime is directly managed by the government, so it constitutes a policy tool, while complementary schemes are managed by trade unions and representatives of employers. Moreover, these latter are already close to actuarially-fair adjustments as they are more contributive, whereas the former is further away from such adjustments. In this paper, we restrict ourselves to the study of the GR pillar and its reform, even if we take into consideration both pillars in the benchmark economy calibration⁵. Hereafter, we refer improperly to the SS system when presenting the GR pillar.

The pension in the French SS system can be claimed from the early retirement age (*ERA*, 60 years old) onwards and cannot be combined with a working activity. It depends on three elements according to a complex non-linear formula: the reference wage w^{ref} , the pension rate ρ and the number of contributing quarters d . The pension is based on the following formula:

$$\omega^{GR} = \min\left(1, \frac{d}{150}\right) \times w^{ref} \times \rho \quad (1)$$

The pension rate ρ equals at most 50%. An individual is eligible to receive this “full rate” ($\rho = 0.5$) once he has contributed a minimum number of quarters to the General Regime (d^n) or at the mandatory retirement age (*MRA*, 65 years old), whatever the number of quarters of contribution. In this sense, and this is certainly the main difference from the US system,

⁵Appendix A summarizes the French complementary pension system.

there is no normal retirement age in France. Rather there is a normal number d^n of contributing quarters. If retirement occurs before one of these conditions is met, the individual faces a reduced pension rate, equal to 50% minus 1.25% per quarter necessary to reach either the mandatory retirement age or d^n contributing quarters. No pension adjustments ⁶ are proposed for any additional contributing quarters beyond d^n . ρ can be written as, for people eligible for the SS system:

$$\rho = 0.5 - 0.0125 \times \max \{0, \min [(MRA - z) \times 4, d^n - d]\}$$

with z the agent's retirement age in years. If the normal retirement age is often considered in France as being equal to the early retirement age, it is only because the normal number of contributing years is such that most workers have reached their full rate at this age. In 1993, the Balladur reform increased the normal number of contributing quarters from 150 quarters to 160 quarters without affecting the "proratization" term $\frac{d}{150}$. The mandatory retirement age is still 65.

The reference wage w^{ref} is defined as the average annual gross wage of the best N years of one's career. In the US, the Primary Insurance Amount is a fraction of average past wages (AIME), as is the French SS pension. However, while AIME is computed over the quasi-totality of one's career (35 years), the French equivalent is based on the best 25 years. Wages are truncated to the Social Security cap that prevailed each year such that the reference wage is

$$w^{ref} = \frac{1}{N} \sum_{n=1}^N \text{Min}(w_n, \text{Cap}^{SS})$$

where w_n and Cap^{SS} denote the wage of the best N years and the Social Security cap respectively.

The SS system provides a strong incentive to wait until the individual reaches the full rate before claiming his benefits. Indeed, retiring before d^n quarters of contribution implies not only a reduced pension rate ρ but also a lower share of the reference wage included in the pension (through the "proratization" term $\frac{d}{150}$ in equation (1)). After the full rate, no pension adjustments are proposed. As mentioned by Blanchet and Pelé (1997), retirement in France is heavily taxed until the age at which the full rate is attained, and heavily subsidized after this

⁶We calibrate our model before the introduction in 2003 of the 3% pension adjustment for any additional years of contributions.

age. In contrast, the US system corresponds to quasi-actuarial neutrality on both sides of the normal retirement age.

The General Regime is financed through a payroll tax on the worker's wage, θ , that is determined to balance the SS budget and is paid by workers and firms ($\theta = \theta_w + \theta_f$) according to a given sharing rule.

2.2 Individual uncertainty

In this Section, we define the exogenous stochastic variables of the model, namely the intergenerational ability, the aging of individuals and their employment opportunities.

2.2.1 Labor ability

We assume the existence at birth of an idiosyncratic shock γ that permanently affects the lifetime labor productivity of individuals. The labor ability process is a three-state, first-order Markov chain. The labor ability γ can be High, Medium or Low: $\gamma \in \Gamma = \{H, M, L\}$. Labor abilities are assumed to be correlated across generations as the result of the transmission of human capital from parent to child (Becker and Tomes, 1979, 1986). It is assumed that, once born with a labor ability, individuals keep the same ability during their working life.

The individual's life expectancy, the wage level and the wage profile over the working life as the return from seniority depend on the labor ability. Note that the unemployment risk at the end of working life will also differ across labor abilities.

2.2.2 Life cycle

Each period, some individuals are born and some individuals die⁷. More precisely, when an individual dies, he gives birth to a single child. Individuals belonging to the same dynasty do not overlap. Unlike Fuster (1999), and Fuster et al. (2003), there are only dynasties and no households in the model economy. We also assume that there is uncertainty about the ability of the children. The bequest motive is driven by the distribution of the ability shocks, and not by their realization⁸.

⁷For empirical reasons, we assume that there is no demographic growth (Aglietta et al., 2002).

⁸This might overstate the bequest motive for some parents and understate it for others. It is then not clear how different the retirement distribution would have been if we had allowed parents to know the child ability.

Figure 1: Life cycle model

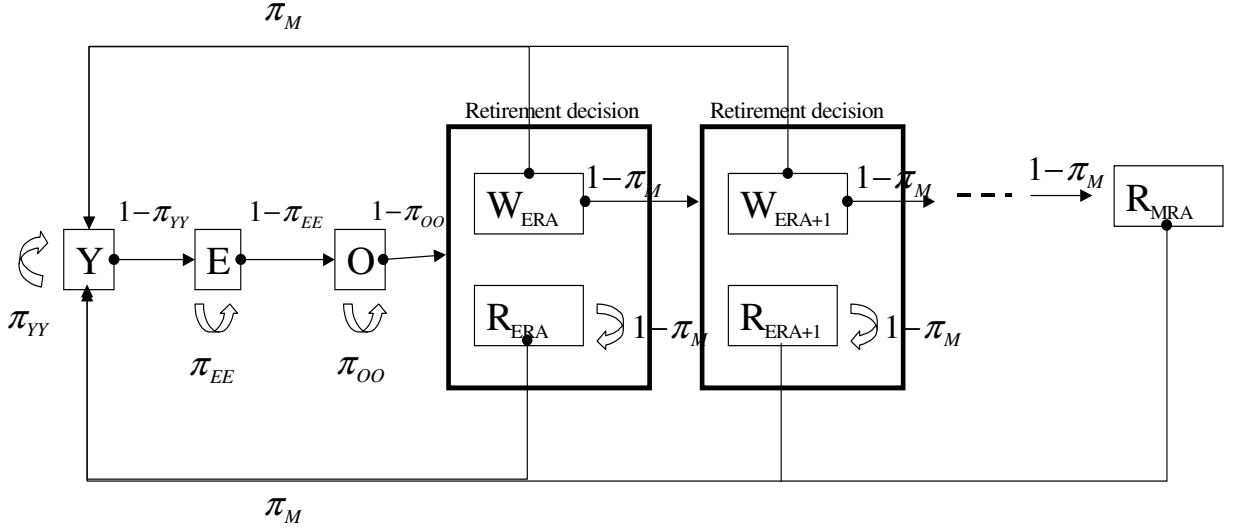

Figure 1 summarizes the age structure. Following Castañeda et al. (2003) and Ljungqvist and Sargent (2005), agents age stochastically and sequentially until the early retirement age (ERA). Between this age and the mandatory retirement age (MRA), age and time evolve in parallel in order to determine the retirement age very accurately: workers grow older of one year each period⁹.

Before the early retirement age, we consider three classes of working age: the young, the experienced and the old workers, respectively denoted Y , E and O . All agents are "born" as young workers (Y) at a given age which corresponds to end of education. Rather than assuming deterministic aging, as in a traditional overlapping generation model, individuals face a given probability to move to the next age group. The probability of remaining a young (experienced) worker in the next period is π_{YY} (π_{EE}) and, as aging occurs sequentially, the probability of becoming an experienced (old) worker is $1 - \pi_{YY}$ ($1 - \pi_{EE}$). As workers differ in terms of age at end of education according to their ability, they do not experience the same number of years before ERA . This translates into different probabilities π 's across ability. Until ERA , the probability of dying is taken to be zero.

The existence of these three aging classes permits to take into account a typical wage life cycle profile: as a worker accumulates experience during his life cycle, we assume that the efficiency of

⁹This is the meaning of subscript "+1" in Figure 1.

the labor input grows with the agent's age. Thus, when a young worker becomes an experienced worker, his efficiency is multiplied by $1 + x_Y$. An old worker's efficiency is $(1 + x_E)$ times that of a young agent, with $x_Y < x_E$.

With a probability equal to $1 - \pi_{OO}$, older workers reach the retirement eligibility age (ERA). In this second life cycle stage, from the ERA onwards, individuals face a probability of dying which is specific to their labor ability. For people still in activity and alive, until the mandatory retirement age (MRA), workers grow older of one year each period. At the beginning of each period (ERA for instance), conditional on being alive, they choose to retire (R_{ERA}) or not (W_{ERA}). If they decide to postpone retirement, they remain in the labor force one additional year with the same efficiency as the older workers. If they survive, they will face the same choice at the beginning of the next period. Conditional on being alive and in activity, workers must retire at the beginning of the mandatory retirement age (MRA).

We will denote by ξ the stochastic age variable which is assumed to follow a finite state Markov process. ξ takes values in the set $\Xi = \{Y, E, O, ERA, ERA + 1, \dots, MRA - 1, MRA\}$.

Retirees must be defined by their retirement age z as their pension depends on z . Using age-specific mortality rates would also have required to keep track of the age of retired workers. For computational reasons, we consider a constant probability π_M of dying. Retirees, conditional on surviving, remain in the same age group ($\xi' = \xi$). A retiree is then characterized by a given ξ which actually corresponds to its retirement age z . This allows us to have only one state variable for retirees (retirement age) instead of two (retirement age and current age)¹⁰. In addition, consistency requires that individuals who are still in the labor force also face a constant probability of dying π_M .

Our assumptions on the demographics are driven by the choice to make the retirement age endogenous. Our model combines a detailed modelling in ages when retirement is possible with a parsimonious life cycle prior to the ERA and posterior to the retirement age. All individuals pass through the age stages Y , E and O . Their life-cycle differs after the early retirement age depending on the retirement age. Some may retire early, at ERA . The set of stages describing their life cycle is then $\{Y, E, O, ERA\}$. Others may retire later, at age $ERA + i$. Their life cycle is then $\{Y, E, O, ERA, \dots, ERA + i\}$. The last element corresponds to the retirement age and

¹⁰Even if it would have been more satisfying to consider age-specific mortality rates, constant ones significantly reduce the scale of the dynamic programming, and then the computational burden.

they remain in this state until they die.

2.2.3 Unemployment shocks

We introduce an unemployment risk only for older workers ($\xi = O$). We discard unemployment risks during the medium stages of working life ($\xi = E$): the exit rate from employment is very low at medium ages, much less than in the US for instance (Aubert et al., 2005). Ignoring unemployment risk for the younger workers ($\xi = Y$) is more questionable as their unemployment rate is high in France. However, unemployment risk at young ages do not alter retirement decision at older ages. This is not the case for the observed decline in the employment rate of workers aged 55-59. Introducing this idiosyncratic risk of being unemployed at these ages is then essential to the understanding of retirement decisions and the implications of any policy aiming at delaying retirement age. In France, based on the French Labor Survey (1990-2003), it appears that the employment rate for the 55-59 years old decreased by more than 20%, relative to the 50-54 age group. The exit rate from employment is around 12% for the 55-59 years old workers, fourfold the rate for these aged 30-49. Secondly, it is important to notice that the exit rate from unemployment at these ages is very close to zero¹¹. These workers have access to specific arrangements of unemployment insurance¹² (including an exemption from seeking employment). However, it must be emphasized that only workers age 55-59 who have been laid-off are eligible to these specific unemployment programs. Unemployed old workers exit employment as a result of involuntary quits and have access to inactivity benefits until retirement¹³ (see Aubert et al., 2005).

We then assume that old individuals face an (un)employment shock $\phi \in \Phi = \{e, u\}$ which is assumed to follow a two-state Markov process. The individual labor input is set to $l(\phi)$. When unemployed ($\phi = u$), the time endowment is devoted to leisure ($l(u) = 0$) and workers receive an unemployment benefit until the age of full pension rate. When employed ($\phi = e$), they inelastically supply \bar{l} units of labor input ($l(e) = \bar{l}$) at a wage rate w . Consistently with

¹¹Only 2% of the 55-59 years old non-employed people find a new job annually, while this proportion is around 30% for the 39-49 age group.

¹²The development of generous unemployment insurance for older workers has been viewed as an answer to the propensity of firms to get rid of their older staff during downsizing.

¹³Making actuarially-fair (early retirement) schemes available to individuals before 60 could be welfare-improving. However, we will discard this question by maintaining the early retirement age at 60.

empirical evidence, we will consider that the unemployment state is an absorbing state until retirement. Workers become retired as employed or unemployed. As their pension depends on their work history, through the reference wage w^{ref} , ϕ is still a state variable for retirees.

2.3 Preferences

Individuals derive utility from their own consumption and leisure as well as from the well-being of all their descendants (they belong to the same dynasty), but not of their predecessors.

We assume that the instantaneous utility function u is of a CRRA type:

$$u(C, 1 - l) = \frac{(C^{1-\nu}(1-l)^\nu)^{1-\tilde{\sigma}}}{1-\tilde{\sigma}}$$

with C_t consumption, $\tilde{\sigma} \in [0, 1[\cup]1, \infty[$ the risk aversion and $\nu \in [0, 1]$ the share of leisure in the instantaneous utility. Time endowment is normalized to one. The utility function is Cobb-Douglas in consumption and leisure. The reasons for this choice are that this function is compatible with a balanced growth path and the parameters needed for the calibration have been extensively studied in the literature relying on calibration (Cooley and Prescott, 1995; Hansen and Imrogoglu, 1992; Rios Rull, 1996; Huggett and Ventura, 1999).

2.4 Firms and technology

Firms use capital and labor to produce a single good according to the following production function: $Y = K^\alpha(XL)^{1-\alpha}$, with $\alpha \in [0, 1]$ the output share of capital, K the aggregate capital which depreciates at a constant rate δ and L the labor input obtained by aggregating the efficiency labor units. X is a deterministic exogenous productivity trend growing at a rate of g .

Firms produce in a perfectly competitive environment and maximize profits by hiring labor from workers and renting capital from individuals so that marginal products equal factor prices.

$$w(\gamma, \xi)(1 + \Theta_f(w(\gamma, \xi))) = \mu(\gamma, \xi)(1 - \alpha)\frac{Y}{L} \quad (2)$$

$$r + \delta = \alpha\frac{Y}{K} \quad (3)$$

with r the interest rate and Θ_f is the contribution rate paid by the firm to finance the pay-as-you-go pension system¹⁴. $\mu(\gamma, \xi)$ a global efficiency indicator combining labor ability and

¹⁴ Θ_f splits in two components: θ_f the contribution rate of the General Regime and c_f^{MCS} the one of the

seniority.

2.5 The stationary dynamic program

In order to define a stationary equilibrium, we divide all variables by the gross rate of technological progress $(1 + g)$. We denote stationary consumption and wealth by:

$$c = C_t/(1 + g)^t \quad \text{and} \quad a = A_t/(1 + g)^t$$

whereas the labor income $y(\phi, \gamma, \xi)$ and the pension $\omega(\phi, \gamma, \xi)$ are denoted in stationary terms

$$y(\phi, \gamma, \xi) = y_t(\phi, \gamma, \xi)/(1 + g)^t, \quad \omega(\phi, \gamma, \xi) = \omega_t(\phi, \gamma, \xi)/(1 + g)^t,$$

$y(\phi, \gamma, \xi)$ is equal to either the stationary wage or the unemployment benefits, according to the realization of the employment risk ϕ . Given the specification of the utility function, the discount factor $\beta \in]0, 1[$ becomes $\tilde{\beta} = \beta/(1 + g)^{(1-\nu)(1-\bar{\sigma})}$.

Retirement decisions are endogenous and all agents determine their optimal saving and consumption profile taking into account financial market incompleteness and the borrowing constraint. For retirees and workers, the individual's state variable is (a, ϕ, γ, ξ) which includes the beginning-of-period capital stock a , and the realization of the individual-specific shocks. $P(\cdot|\cdot)$ will denote hereafter the conditional probability operator. Since the individuals' decision problem is a finite-state discounted dynamic program, an optimal stationary Markov solution to this problem exists.

Until the early retirement age, workers only determine their optimal consumption path that solves the following program:

$$\left. \begin{aligned} V_w(a, \phi, \gamma, \xi) &= \max_{c \geq 0} \left\{ u(c, 1 - l(\phi)) + \tilde{\beta} \sum_{\phi'} \sum_{\xi'} P(\phi'|\phi, \gamma, \xi) P(\xi'|\gamma, \xi) V_w(a', \phi', \gamma, \xi') \right\} \\ \text{subject to } &\left\{ \begin{aligned} (1 + g)a' &= (1 + r)a + y(\phi, \gamma, \xi) [1 - \Theta_w(y(\phi, \gamma, \xi))] - c - I_e T_u \\ a' &\geq 0 \end{aligned} \right. \end{aligned} \right\} \quad (4)$$

where V_w denotes the value function of workers. $P(\phi'|\phi, \gamma, \xi)$ is the probability that a worker of labor market status ϕ , ability γ and age ξ becomes type ϕ' the next period¹⁵. $P(\xi'|\gamma, \xi)$ is the mandatory complementary schemes. Θ_f depends nonlinearly on the wage because of complementary schemes. See Appendix A.

¹⁵Note that $P(e|e, \gamma, \xi) = 1$ when $\xi \in \{Y, E\}$ and $P(u|u, \gamma, \xi) = 1$.

probability that a worker of ability¹⁶ γ and age ξ becomes age ξ' the next period.

$\Theta_w(y(\phi, \gamma, \xi))$ embodies the contribution rate paid by the worker (employed or unemployed) to finance the pay-as-you-go pension system¹⁷. Unemployment benefits are financed through a lump-sum tax T_u by workers when employed. I_e is the indicator function for $\phi = e$. It is equal to one if $\phi = e$ and zero otherwise.

From the early retirement age to the mandatory retirement age, individuals choose whether to retire or not, depending on the maximum value of being retired or of still being active. This choice is marked by the presence of the max operand in the expected value of an active worker. The value function of an individual who is in the labor force (employed or unemployed) is given by:

$$V_w(a, \phi, \gamma, \xi) = \max_{c \geq 0} \left\{ \begin{array}{l} u(c, 1 - l(\phi)) \\ + \tilde{\beta} \left(\begin{array}{l} (1 - \pi_M(\gamma)) \max [V_w(a', \phi, \gamma, \xi + 1), V_r(a', \phi, \gamma, \xi + 1)] \\ + \pi_M(\gamma) \eta \sum_{\gamma'} P(\gamma'|\gamma) V_w(a', e, \gamma', Y) \end{array} \right) \end{array} \right\} \left. \vphantom{\max_{c \geq 0}} \right\} \\ \text{subject to } \left\{ \begin{array}{l} (1 + g)a' = (1 + r)a + y(\phi, \gamma, \xi) [1 - \Theta_w(y(\phi, \gamma, \xi))] - c - I_e T_u \\ a' \geq 0 \end{array} \right. \quad (5)$$

Conditional on being alive (with probability $1 - \pi_M(\gamma)$), workers become one year older $\xi' = \xi + 1$. $V_r(a', \phi, \gamma, \xi + 1)$ is the expected utility to be retired at the age $\xi + 1$, whereas $V_w(a', e, \gamma', Y)$ denotes the expected utility of a new-born child who begins his life as a young ($\xi = Y$) employed worker ($\phi = e$) according to a stochastic labor ability γ' linked to that of his father γ by the probability $P(\gamma'|\gamma)$. Following Castañeda et al. (2003), at the beginning of the first period of life, the individual inherits the estate of his deceased father. $\eta \in [0, 1]$ measures the father's concern for his offspring's well being. With $\eta = 1$, the father cares about the utility of his descendant as much as he cares about his own utility.

The retirement decision rule is summarized by the indicator function $\Psi(a, \phi, \gamma, \xi)$:

$$\Psi(a, \phi, \gamma, \xi) = \begin{cases} 1 & \text{if } V_w(a, \phi, \gamma, \xi) \geq V_r(a, \phi, \gamma, \xi) \\ 0 & \text{otherwise} \end{cases}$$

The value function of a retiree, who retired at age $z = \xi$, is given by:

$$V_r(a, \phi, \gamma, \xi) = \max_{c \geq 0} \left\{ \begin{array}{l} u(c, 1) + \tilde{\beta} \left(\begin{array}{l} (1 - \pi_M(\gamma)) V_r(a', \phi, \gamma, \xi) \\ + \pi_M(\gamma) \eta \sum_{\gamma'} P(\gamma'|\gamma) V_w(a', e, \gamma', Y) \end{array} \right) \end{array} \right\} \left. \vphantom{\max_{c \geq 0}} \right\} \\ \text{subject to } \left\{ \begin{array}{l} (1 + g)a' = (1 + r)a + \omega(\phi, \gamma, \xi) - c \\ a' \geq 0 \end{array} \right. \quad (6)$$

¹⁶As workers differ in terms of age at end of education, aging is not independent of the ability class.

¹⁷ θ_w is the contribution rate of the General Regime and c_w^{MCS} of the mandatory complementary schemes. The contributions Θ_w depend nonlinearly on the wage because of complementary schemes. See Appendix A.

Retirees receive a pension $\omega(\phi, \gamma, \xi)$ that is the sum of the public Social Security pension and benefits paid by mandatory complementary schemes. The only choice faced by a retiree is his consumption profile and the optimal amount of financial assets he wants to give to his child, according to the stochastic intergenerational expected changes in ability.

2.6 Definition of the equilibrium

Following Castañeda et al. (2003), we define the variable $s \in S$ which denotes jointly the employment shock, the random labor ability and the random age of individuals:

$$\begin{aligned} s : \Phi \times \Gamma \times \Xi &\rightarrow S \\ (\phi, \gamma, \xi) &\rightarrow s(\phi, \gamma, \xi) \end{aligned}$$

Its process is independent and identically distributed across individuals and follows a finite state Markov chain. The conditional transition probability is defined as follows:

$$P(s'|s) = Pr\{s_{t+1} = s' | s_t = s\}$$

The steady state equilibrium is characterized by worker and retiree choices for consumption and savings $\{c_w(a, s), c_r(a, s), a'_w(a, s), a'_r(a, s)\}$ and for retirement $\Psi(a, s)$, value functions $V_w(a, s)$ and $V_r(a, s)$, a vector of prices $(r, w(s))$, a SS policy $(\theta, \omega^{GR}(s))$, a stationary distribution of individuals $\Lambda(a, s)$ and a set of aggregate variables (\tilde{K}, L) which respectively denotes the stationary capital stock and the efficient labor input. The stationary equilibrium is such that:

- (i) Individuals' decision rules are solutions to the lifetime maximization programs (4), (5) and (6)
- (ii) Factor prices are competitive, conditions (2) and (3) hold.
- (iii) The endogenous probability distribution $\Lambda(a, s)$ is the stationary distribution associated with $(A(a, s), P(s'|s))$ such that:

$$\Lambda(a', s') = \sum_s \sum_{\{a: a' = A(a, s)\}} \Lambda(a, s) P(s'|s)$$

with $a' \equiv A(a, s)$ the individuals' policy that encompasses retirement choices and saving decisions. $A(a, s)$ is such that:

$$\mathcal{A}(a, s) = \Psi(a, s) a'_w(a, s) + [1 - \Psi(a, s)] a'_r(a, s)$$

(iv) Factor inputs are aggregated over individuals.

$$\begin{aligned} L &= \sum_s \sum_a \Psi(a, s) \bar{l} \mu(s) \\ \tilde{K} &= \sum_s \sum_a \Lambda(a, s) \mathcal{A}(a, s) \end{aligned}$$

(v) The payroll tax rate θ adjusts to balance the SS budget: ¹⁸

$$\sum_s \sum_a \Psi(a, s) \theta y(s) = \sum_s \sum_a (1 - \Psi(a, s)) \omega^{GR}(s) \quad (7)$$

Given the specification of preferences and the various constraints, it is not possible to solve this equilibrium analytically. We implement numerical techniques based on a discretization of state variables (see Ljungqvist and Sargent 2000 for a presentation of the methodology).

3 Calibration and quantitative evaluation

3.1 Calibration on French data

This section presents the calibration of the demographic structure, idiosyncratic risks, life cycle profile of labor earnings, Social Security arrangements, preferences and technology parameters. We choose to calibrate the pension system after the French 1993 Balladur reform.

3.1.1 Labor ability and employment risks

Labor abilities are calibrated on the basis of ability categories for which information on lifetime wage profiles, intergenerational links, employment rates and death probabilities is available. The high ability labor class (H) will correspond to executives, the medium one (M) to white-collars, and the low one (L) to clerks and blue-collars.

There exists some degree of intergenerational transmission of human capital. The correlation between the parent's human capital and that of his offspring is given by the intergenerational ability matrix computed from INSEE (1995) (Table 1). The risk for a H type agent to have a child who belongs to a lower ability class is superior to 50%. This will provide a strong bequest motive to insure his descendant against this risk.

¹⁸The budgets of complementary schemes and unemployment insurance are balanced. We do not explicitly present these budgets as they are not the primary focus of our paper.

Table 1: Intergenerational change in ability

		Son's Ability ($t + 1$)		
		H	M	L
Father's Ability (t)	H	0.4077 ^a	0.3187	0.2736
	M	0.2191	0.3507	0.4302
	L	0.0929	0.1952	0.7119

a: A H-ability worker faces a 40.77% probability of giving birth to a H-ability son

Table 2: Unemployment replacement rate (ρ_u) and employment risk (π_u)

	ρ_u	π_u
H	0.60 ^a	0.063 ^b
M	0.61	0.083
L	0.65	0.086

a: An unemployed H-ability agent receives 0.60 of his last annual net wage

b: Each year, an H-ability worker faces a 6.3% probability of becoming unemployed

As argued in Section 2.2.3, the employment risk occurs at the end of working life. It differs across labor ability groups. We assume that the transition rate from non-employment to employment is null. The annual transition rate from employment to non-employment π_u is set such that the model replicates the employment rate of male individuals aged 55 - 59 for each ability class (computed from the French Employment Survey). In particular, blue-collars and clerks (L) face a higher risk of non-employment than white-collars (M) (Table 2). Non-employed workers are either unemployed or entitled to programs specific to older workers named as pre-retirement programs. As the replacement rates are not the same, we consider that workers in the non-employed state receive an average benefit (ρ_u), weighted by the relative population entitled to these two non-employed statuses.

3.1.2 Demographics and lifetime wage

We assume that individuals are born when they enter the labor market. As shown by Colin et al. (2000), the age at end of education differs across labor abilities (Table 3). This age affects retirement choices which are conditional on a minimum duration of contributions.

As workers differ in terms of age at birth, their expected length of working life until the common early retirement age differs too. As they also experience a common decrease in the em-

Table 3: Age of end of school education

Ability	H	M	L
Age of end of education	22.2	19.5	17.4

Table 4: Mortality risk at 60

	H	M	L
π_M	0.0410 ^a	0.0483	0.0538

a: Each year, an H-ability agent faces a 4.10% probability of dying

ployment rate from 55 to 59, the length of working life might differ for young and/or experienced workers. We choose to introduce this heterogeneity inside the experienced worker class. The expected length as a young worker (Y) is equal to 10 years, whereas, for experienced workers (E), it is set to 26.6 years for the L group, 24.5 years for the M group and 21.8 years for the H group. All of them are accordingly determined by the exogenous probabilities π_{YY} and π_{EE} . Individuals expect to be older workers (O) at 55. During a period of 5 years on average, before being eligible to SS benefits at 60, they are submitted to an unemployment risk. From the early retirement age to the mandatory retirement age, fixed at 65 in the benchmark economy, the individuals still in the labor force grow older of one year each period, in order to accurately determine the exact retirement age. Retirement can intervene in this age interval according to individual preferences and SS provision schemes. Individuals face an exogenous probability of dying only from the early retirement age on. This probability depends on the labor ability of the worker. Life expectancy at 60 years old equals 24.4, 20.7 and 18.6 years for H, M and L type individuals respectively (Charpin, 1999). Table 4 shows the corresponding mortality risk.

The levels and profiles of labor efficiency units are based on the lifetime wages for each ability category (Table 5). The data from INSEE (1999a) are aggregated in order to fit our age

Table 5: Lifetime wages

	Young	Experienced	Old
H	2.14 ^b	3.25	3.91
M	1.40	1.86	2.25
L	1 ^a	1.24	1.26

a: The wage of low-skilled young workers is normalized to one

b: A young H agent's wage is 2.14 higher than a young L agent's wage

Table 6: The French SS system in the benchmark calibration

d^n	N	ERA	MRA
160	25	60	65

structure. The gross wage of low-skilled young workers is normalized to one¹⁹. In the first two periods of life, the wage growth factor is 1.24 for low ability individuals, 1.33 for M type agents and 1.52 for H workers. Between the first and third periods of life, wage growth equals 1.26 for individuals in the L group, 1.6 for the M group and 1.83 for the H group. In contrast to L type workers, high and medium ability workers are characterized by a steeper wage profile when old.

3.1.3 Social Security

Rather than relying on calibrated replacement rates, the computation of pensions is based on real - life formulas. There are three key parameters in the SS system: the reference wage, the pension rate and the number of contributing quarters. Table 6 summarizes the values already presented in Section 2.1. Payroll taxes θ are determined at the general equilibrium to balance the SS budget. In the post - 1993 SS regulation, the share of contribution rate paid by employers is 60% and 40% by workers. This sharing rule is kept unchanged throughout the paper.

Figure 2 illustrates the replacement rates, as it is predicted by the model under the current retirement rules. Consistent with the data, L type workers are characterized by the highest replacement ratio. Indeed, the presence of the Social Security cap limits the replacement ratio for H type workers whose wages are higher than Cap^{SS} . In addition, High ability workers (Medium and Low ability respectively) reach the required number of contributive quarters at age 63 (60 and 58 respectively). However, the early retirement age (ERA) is fixed at 60 years old in France. This means that it constitutes a binding constraint for Low ability individuals who have to wait until 60 before retiring. As there are no pension adjustments after the full rate age, for Low, but also for Middle ability workers, the SS pension is completely flat after the ERA . There is no increase in pension in the case of delayed retirement beyond 60. High ability workers bear a steep decrease in pension if they retire before the full rate reached at age 63. In addition, should they want to postpone retirement beyond 63, they would get no increase in pension.

The French SS pension scheme is characterized by a flat replacement rate beyond the age of

¹⁹All variables in the following will be expressed in terms of this wage.

Figure 2: Replacement rates (SS Pension / Last net wage)

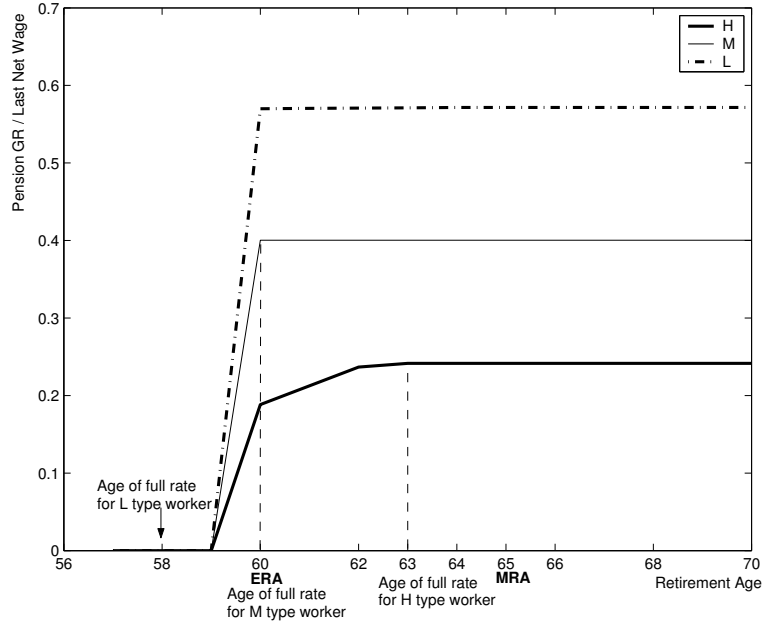

full pension. In contrast, the US OASI pension provides an increase in pension for each additional working year between the ages of 65 and 70. The French pension system imposes a marginal tax on continued work: if a worker decides to postpone retirement by one year, his pension level will not adjust so as to compensate for the additional payroll tax he pays (explicit tax) and for the fact that he will receive pension benefits for a shorter time (implicit tax). We compute in Section 4.1 the actuarially-fair pension adjustments allowing to eliminate this tax.

3.1.4 Technology and preferences

Following Charpin's (1999) report, the technological trend g is set to 2% a year. The income share of capital equals $\alpha = 0.36$. The depreciation rate is taken to be $\delta = 10\%$.

We can rewrite the utility function as:

$$\frac{c^{1-\sigma}}{1-\sigma} \vartheta(1-l) = \frac{(c^{1-\nu}(1-l)^\nu)^{1-\tilde{\sigma}}}{1-\tilde{\sigma}}$$

So, by comparing the two terms of this equation, we have $(1-\nu)(1-\tilde{\sigma}) = 1-\sigma$. The literature provides values for the risk aversion coefficient σ . In their survey of empirical studies, Auerbach and Kotlikoff (1987) suggest that σ lies between 1 and 10. Following Fuster et al. (2003), we

Table 7: Consumption units by ability and age

	Young	Experienced	Old	Retired
H	1.40	1.85	1.50	1.30
M	1.40	1.85	1.50	1.30
L	1.52	2.02	1.63	1.42

set $\sigma = 2$, which is consistent with microdata evidence (Attanasio et al., 1999). Like Castañeda et al. (2003), we impose $\bar{l} = 1/3$. Unemployed people as well as retirees enjoy full time leisure ($l = 0$).

As preferences measure the welfare of one individual, all revenues (wages and pensions) are deflated by “consumption units” (CU) in order to take into account the lifetime family structure. We use information about CUs by age and by ability status (INSEE, 1999b) to arrive at the figures presented in Table 7.

Whereas the previous parameters were calibrated on external information, the following parameters are chosen so that the model-generated data match a given set of targets. The annual real interest rate equals 5% and the discount factor 0.9637 in order to replicate the observed capital-output ratio 2.4 and to ensure the equilibrium of the financial market. The capital output ratio is 2.6 in Caballaro and Hammour (1999) and 2.2 in Villa (1995). A capital-output ratio of 2.4 appears as an average value of these references. Moreover, 2.4 corresponds to the ratio we found using Vikram and Dharieswar’s (1995) data on the French physical capital stock in the post 1955 period. The scale of technological progress X allows the factor-price frontier relationship to be verified.

In the benchmark calibration, the altruism parameter is set to $\eta = 0.9$ in order to replicate the ratio of annual flow of intergenerational transfers (defined as the sum of intended transfers and bequests) to aggregate wealth. This ratio amounts to 2.2% (Arrondel and Laferrère, 1991; Arrondel and Laferrere, 2001; INSEE, 1997, 1998). This percentage is larger than its US counterpart (1.7% in Gale and Scholz 1994 when intergenerational transfers include intended transfers, college expenses and bequests). With $\eta = 0$, the ratio of annual flow of intergenerational (unintended) transfers to aggregate financial wealth falls down to 1.1%, which is half its empirical counterpart. The ratio of bequests to aggregate wealth is sensitive enough to the altruism parameter to be confident in the calibrated value.

The share of leisure ν in the utility function, by affecting the willingness to work, is one of

the key parameters in the model. However, the current pension system imposes such a huge tax on continued activity after the full pension age that it hardly reveals leisure preferences at the end of working life. Blanchet and Pelé (1997) provide the most comprehensive survey on retirement decision in France. Based on data which do not include the 1993 Balladur reform, the salient fact they stress is that the majority of individuals retire at 60. This first result is quite ambiguous. Do people retire as soon as they can due to a strong preference for leisure or because they are heavily taxed after the full rate? It is difficult to answer this question as, before 1993, 60 was both the early retirement age and the full pension age for a vast majority of workers.²⁰ Another interesting feature provides a first answer. Blanchet and Pelé (1997) observe another peak in the retirement age distribution at 65. This smaller peak at age 65 stems from retirement by people with incomplete careers, especially women. This indicates that some people choose to work until they reach the full pension age.

These first empirical insights can be completed by more recent data including the 1993 reform. We verify that people actually retire at their full pension age. First, among male individuals retiring at age 60, 95% had indeed accumulated d^n contributive quarters (French ministry of Labor, Drees 2003). Secondly, since the Balladur reform, more individuals have reached the full rate between the ages of 60 and 65. The Balladur 1993 reform has lengthened the duration of contributions from 150 quarters to 160 quarters to reach the full pension age. The implementation has been phased in with one additional quarter per generation, from 1934 to 1943 ($d^n = 150$ for generations born before 1933, $d^n = 151$ for generations born in 1934, etc.). Figure 3 represents the peak of the distribution of contributive quarters at retirement for male individuals retiring between the ages of 60 and 65. The peak moves to 151 quarters for the 1934 generation, 152 for the 1935 generation, to 157 for the 1940 generation. Finally, the same pattern is present for every generation, following the way the reform is phased in²¹: the retirement age mainly coincides with the full pension age.

This emphasizes the importance of the tax on continued activity in retirement decisions. This stylized fact makes the calibration of parameter ν difficult, as the importance of the tax does not enable us to pin down precisely the relative preference for leisure. Conversely, preferences

²⁰Indeed, in the pre-1993 regime, $d^n = 150$. H type workers (M and L respectively) accumulated the required number of contributive quarters at age 60 (57 and 55 respectively).

²¹We thank Antoine Bozio for providing us with the French Social Security data. See also Bozio (2005).

Figure 3: Evolution of the number of contributive quarters at retirement (Source: Social Security data)

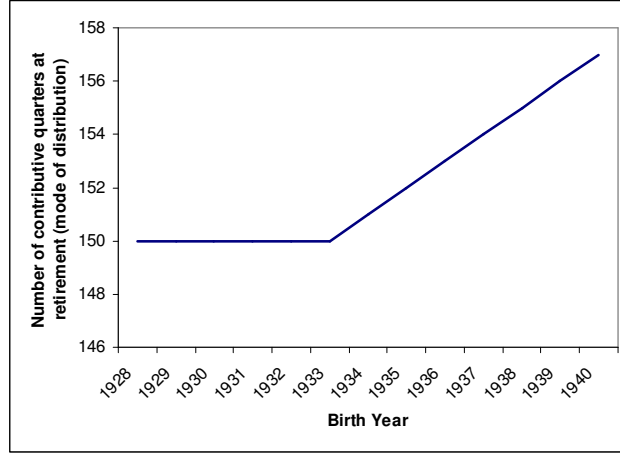

which would lead to anticipated or delayed retirement relative to the full pension age can be confidently rejected. We identify an interval of admissible values for this parameter: under a minimum value of preference for leisure, individuals would put off retirement beyond their full rate age, while above a maximal admissible value, they would exit before the full rate. We determine these interval bounds by simulations²². Admissible values for ν lie in the interval $[0.61; 0.65]$ and we consider 0.63 as the benchmark value²³. For these values, the model predicts that 100% of individuals will retire at their full rate age (Figure 4). Only High ability individuals work beyond the early retirement age since they reach 160 quarters of contribution at the age of 63. Medium and Low ability workers, who reach the required number of contributions to get a full pension at the age of 58 and 60 respectively, stop working at the early retirement age.

²²Note that the upper bound has been determined on the sole basis of the behavior of H type workers (we assume the same preference across labor abilities) since their full pension age (63) differs from the early retirement age (60).

²³It is worth emphasizing that the value of ν is such that, at the steady state, a unit of good without work is worth 1.99 times a unit of good gotten by working. The calibrated value is consistent with Stock and Wise's (1990) estimate. They found on US data that the ratio of a consumption unit with work to a consumption unit without work equals 1.66.

Figure 4: Distribution of retirement age (benchmark calibration)

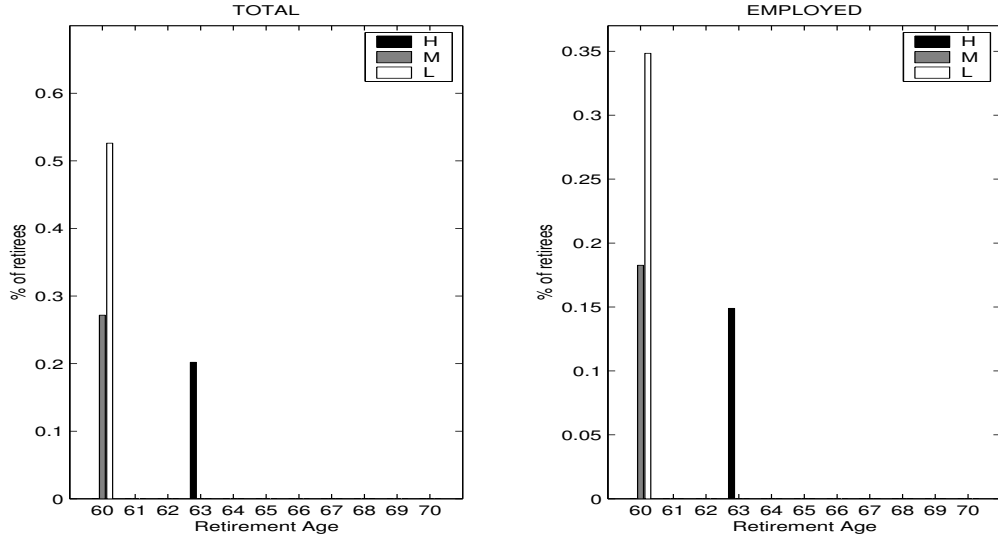

3.2 Evaluating the performance of the model

We choose to evaluate the empirical performance of our model on the basis of wealth accumulation and retirement decisions. The originality of this paper is to combine these two decisions.

3.2.1 Retirement decisions

In order to check the empirical relevance of our model, we present in this Section the deformation of retirement distribution following the 1993 reform, the dependency ratio and the contribution rates obtained with the benchmark calibration.

The dependency ratio²⁴ equals 44.85% in the model, which is close to 44% observed in France today (Belhaj, 2004; Bardaji et al., 2004). The model determines the payroll taxes that balance the Social Security budgets. The workers' equilibrium contribution rate to the General Regime equals 8.35% versus 6.55% in the data. For complementary schemes, the equilibrium rates paid by workers are respectively 3.32% and 8.30% in the model versus 3% and 8% in the data.

Since we discard heterogeneity in the length of contributing years at the same age within each labor ability class, health status, specific female participation and incomplete careers, the

²⁴The dependency ratio is defined as the number of retirees divided by the number of individuals in the labor force (employed and unemployed).

Figure 5: Impact of the 1993 Balladur reform on the distribution of retirement age (benchmark calibration)

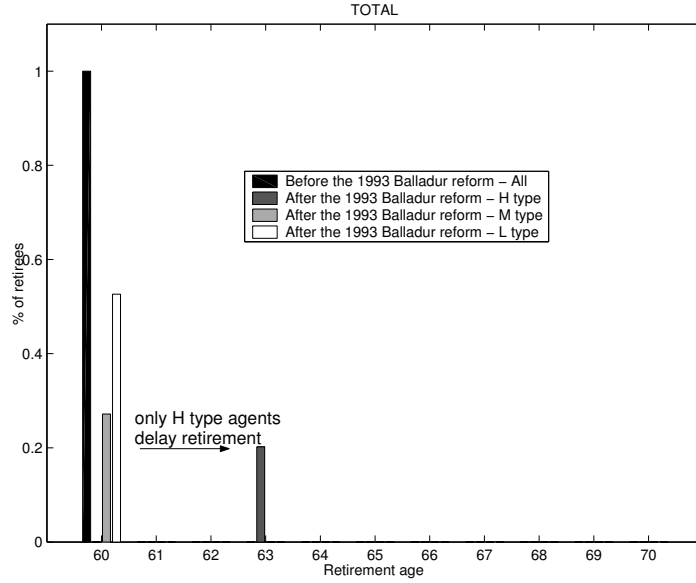

model cannot capture the complete distribution of retirement age²⁵. However, we replicate the stylized fact that agents mostly retire as soon as the full rate is available. As noted above, following the 1993 reform, the peak of the distribution of contributive quarters at retirement for male individuals retiring between the ages of 60 and 65 has moved consistently with the increase in the normal number of contributing years. We verify that our model can replicate this deformation of retirement distribution following the 1993 reform. Notice that the full pension age has increased for H type workers only, as the early retirement is still binding for the L and M types. Their retirement age should have increased, consistently with the observed rise in contributive quarters at retirement (Figure 3). We verify that High ability workers delay their retirement age by the number of additional contributing years necessary to reach the full rate (Figure 5). The elasticity of delayed retirement to the normal contribution years in the model seems consistent with the observed behaviors depicted in Figure 3.

3.2.2 Wealth accumulation

Table 8 presents statistics on the wealth distribution as predicted by the model versus its empirical counterpart based on the 1998 French Wealth Survey (Enquête Patrimoine). Table 8

²⁵Including additional sources of heterogeneity would have made the model hardly tractable.

displays percentiles based on all populations (column (1)) as well as percentiles at retirement age (60 - 64 years old, column (2) ²⁶). The fraction of liquidity-constrained agents in the French economy is taken from Arrondel (2002).

Wealth distribution in France is characterized by a high concentration (columns (1) and (2)). The richest 5% of people hold half the total wealth, while the poorest 60% of the population hold 8% of the total wealth. With a Gini of 0.73, the statistics summarizing the French wealth distribution are close to their US counterparts²⁷.

Table 8 (columns (1) and (3)) suggests that the model does succeed in capturing essential features of the wealth distribution such as the overall inequality captured by the Gini coefficient, the percentage of liquidity-constrained individuals as well as the bottom of the wealth distribution. The poorest 80% of individuals hold 22% of the wealth in France, which is consistent with the percentage predicted by the model (23%). These results clearly show that our model improves our understanding of the wealth distribution, relative to the simpler Aiyagari (1994)'s model²⁸. The reasons have been well-identified in the literature (De Nardi, 2004; Castañeda et al., 2003; Fuster, 1999) : the existence of ability risks at birth and voluntary bequests on the one hand and the generosity of the PAYG pension system on the other hand contribute to the replication of wealth inequalities. The reasons for the shortcomings relative to the top of the distribution are also well-known. The model predicts that the 1% (5%) richest people hold 10% (34%) of the total wealth versus 30% (51%) in the data. Even though the model does not generate enough wealth dispersion, the results are close to De Nardi's (2004). In a positive perspective, Quadrini (2000) and Cagetti and De Nardi (2005) show that models including only employment risks do not succeed in explaining the creation of large fortunes. Their model of occupational choice with entrepreneurship has succeeded in capturing large amounts of wealth concentration.

Table 8 indicates that the same conclusions hold when we consider the wealth distribution at retirement (columns (2) and (4)). It is indeed important to verify that our model is able

²⁶The French Wealth Survey does not provide age as a continuous variable. We thus look at individuals aged 60 to 64. We consider the wealth levels of individuals of the same age group in the model.

²⁷Let us recall that the US wealth distribution is characterized by the following statistics: Gini=0.78, Top 1%=29.6%, Top 5%=54% and Top 60%=98.3%. (Source : Castañeda, Diaz-Gimenez, and Rios-Rull, 2003).

²⁸Let us recall that results in Aiyagari (1994) are the following : Gini=0.38, Top 1%=3.2%, Top 5%=13.1% and Top 60%=85.1%

Table 8: Wealth distribution : model versus data

	Data France		Model	
	All	60-64	All	60-64
	(1)	(2)	(3)	(4)
Gini	0.73	0.86	0.74	0.89
Top 1 %	0.30	0.28	0.10	0.08
Top 5 %	0.51	0.49	0.34	0.27
Top 20 %	0.78	0.75	0.77	0.67
Top 40 %	0.92	0.90	0.96	0.90
Top 60 %	0.96	0.97	0.98	0.99
Liq. Constr.	0.22	—	0.23	—

to replicate the wealth distribution when people are deciding to retire or not, in interaction with the level of their financial assets. It must be noticed that the percentiles are very similar whether we consider individuals at retirement or at all ages. The model globally does a good job in the replication of the wealth distribution at age 60-64. The model does not fully capture the upper tail of the wealth distribution at retirement for the reasons which have been put forward above for the aggregate distribution. Finally, Table 8 indicates that our model replicates key features of the wealth distribution, even though it falls short of explaining the upper tail of the distribution. We therefore consider that our model can constitute a relevant tool when analyzing the interaction between retirement and savings.

4 Actuarially-fair scheme and retirement behavior

In this Section, we assess the impact of actuarially-fair pension adjustments on retirement decisions. The Social Security system is modified to induce the elderly to work longer. As in US OASI pension, we give individuals an increase in pension for each additional working year between the age of full rate until 70.

The effectiveness of such a reform is evaluated. Political debates on Social Security reforms in France have focused only on the defined benefit General Regime (GR), as the mandatory complementary schemes are managed by representatives of workers and employers. As a result, we measure in this section what would happen if pensions paid by the General Regime included incentives to work beyond the full rate. The rules regarding retirement pensions paid by complementary schemes are left unchanged. Following the French 2003 reform, unemployed individuals

are not entitled to the incentive plans.

4.1 Definition of the actuarially-fair scheme

Let $\lambda^*(\gamma, \xi)$ be the actuarially-fair adjustment given to an employed worker of age ξ and of ability γ who is willing to work beyond the required 40 years of contributions. An individual faces two choices: either he claims Social Security benefits now and receives his pension until his expected date of death or he works an additional year and retires at age $\xi + 1$. The actuarially-fair adjustment $\lambda^*(\gamma, \xi)$ is such that both options are equivalent:

$$\begin{aligned}
 & \underbrace{\sum_{i=0}^{\frac{1}{\pi_M(\gamma)}} \frac{(\lambda^*(\gamma, \xi) + 0.5)w^{ref}(\gamma, \xi)}{(1+r)^i}}_{\text{Pension paid by Social Security if the individual retires at age } \xi} \\
 = & \underbrace{(1 - \pi_M(\gamma)) \sum_{i=1}^{\frac{1}{\pi_M(\gamma)}} \frac{(\lambda^*(\gamma, \xi + 1) + 0.5)w^{ref}(\gamma, \xi + 1)}{(1+r)^i}}_{\text{Pension paid by Social Security if the individual retires at age } \xi+1} - \underbrace{\theta w(\gamma, \xi)}_{\text{taxes collected on wages during year } \xi} \quad (8)
 \end{aligned}$$

Equation (8) implies that, as the individual grows older, he has to be given an increasing actuarially-fair adjustment to make him work longer. We choose to implement ability-contingent actuarial schemes because considering ability-neutral adjustments could have introduced an additional distortion in the impact of these incentives on retirement decision beyond the tax on continued activity which we want to focus on²⁹. In Table 9, at full pension age, H ability workers should receive (slightly) higher incentives than Low and Medium ability workers. This result could appear counter-intuitive as the L and M workers has a lower life expectancy than H individuals. But, due the existence of a SS cap (Cap^{SS}), these latter have a particularly low reference wage w^{ref} relative to their current wage w . The pension adjustment (in percentage of the reference wage) must be high to compensate for the contributions they pay on the basis of their current wage.

²⁹In France, defining an ability-contingent scheme does not seem unrealistic. Mandatory Complementary Schemes (MCS) are already managed on an ability-contingent basis. As mentioned in Appendix A, MCS for Non Executives (MCSNE, ARRCO in French) manages complementary pensions of non executives (L and M type workers in our model) and MCS for Executives (MCSE, AGIRC in French) does the same for executives (H type workers). In addition, we have verified that the changes on the retirement distribution are very limited when ability-neutral adjustments are given to agents.

Table 9: Actuarially-fair scheme (in %)

Age $\xi + 1$	$\lambda^*(\gamma, \xi + 1) - \lambda^*(\gamma, \xi)$									
	61	62	63	64	65	66	67	68	69	70
H	0	0	0	5.99	6.53	7.11	7.76	8.46	9.22	10.05
M	5.87	6.45	7.08	7.78	8.55	9.39	10.32	11.34	12.46	13.69
L	5.90	6.52	7.2	7.95	8.83	9.76	10.78	11.92	13.17	14.55

Figure 6: Replacement rates with an actuarially-fair scheme

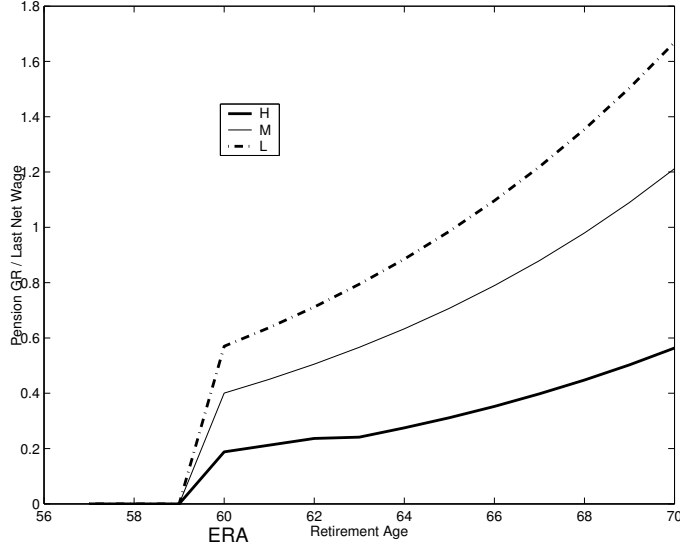

The expression defining the pension rate then becomes for an individual eligible to SS with at least 40 years of contributions:

$$\rho(\gamma, \xi) = 0.5 + \lambda^*(\gamma, \xi)$$

Figure 6 illustrates how the introduction of the actuarially-fair scheme would affect replacement rates of the SS system. In contrast to Figure 2, in the case of delayed retirement, workers would get a significant increase in replacement rates as they age, since the additional pension compensates them for the supplementary contribution tax they pay to the SS. The next section measures the impact of these modified retirement provisions on retirement behavior.

4.2 The impact of the actuarially-fair scheme on retirement behavior

For each ability group, due to the existence of both unemployed and employed workers, we now observe two peaks in the retirement age distribution (left panel, Figure 7). The first peak in

Figure 7: Distribution of retirement age when individuals are given the actuarially-fair scheme

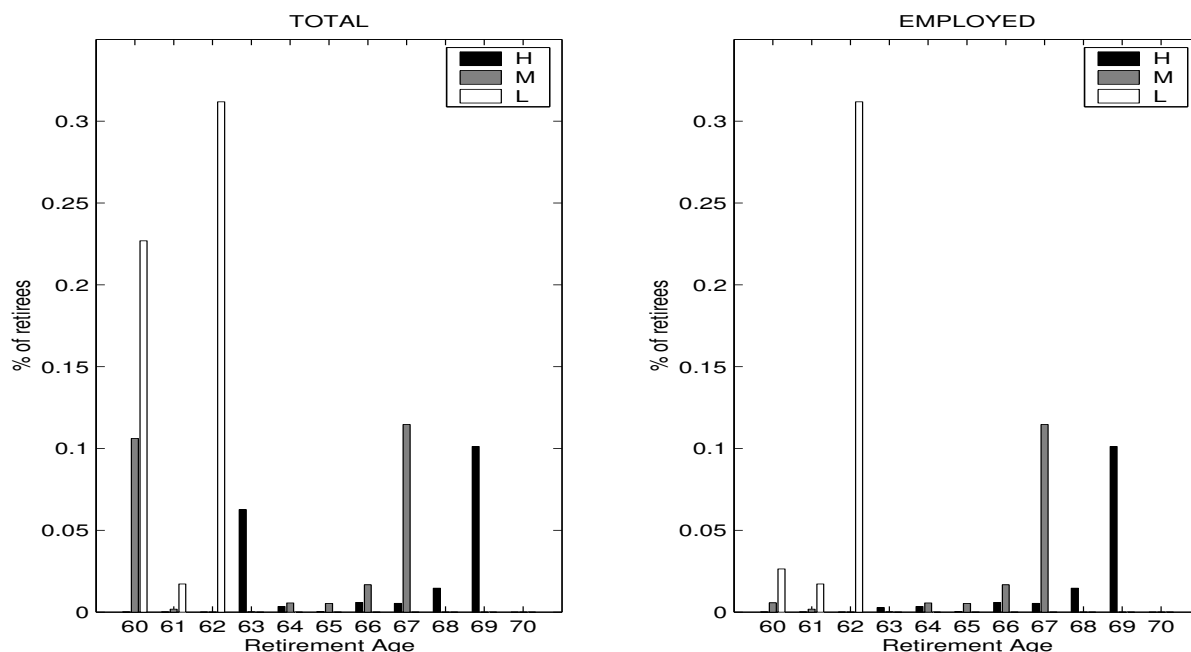

each ability group corresponds to retirement choices of unemployed individuals who still retire at the age of full rate, as they are not eligible to the incentive schemes. By contrast, employed workers take advantage of the actuarially fair scheme and delay retirement: the dependency ratio declines from 44.85% to 37.85%. This exogenous source of between-employment status variations now generates an important heterogeneity in retirement age.

It remains to present the retirement behavior of employed workers (right panel, Figure 7). The inspection of the individual decision rules reveals the interaction between wealth accumulation and retirement. Figure 8 illustrates the choice of a 64 year old H type agent. In order to take his decision, he compares the value of being retired at age 64 to that of remaining active at the same age. The value functions intersect when his financial holdings equals $A^* = 28.53$. If his current wealth is larger than A^* , the High ability agent would retire. If the High ability worker is not rich enough ($A < A^*$), he chooses to keep on working. The model actually yields an array of wealth thresholds above which individuals of each ability category decide to retire (Table 10). For instance, a Low ability worker who considers retiring at 60 years old must have current wealth greater than 9.27 in order to cease working. Given the normalization considered in our model, this threshold corresponds to 8.3 years of his current net wage. When actuarially-fair

pensions adjustments are given, the thresholds increase for any ability classes³⁰. Removing the tax on continued activity reveals the desire of the workers to delay their retirement. It must be emphasized that now individuals accumulate more financial assets. The equilibrium interest rate is equal to 4.57% and the capital-output ratio to 2.47. Altruism plays an important role in this behavior: the existence of earning risks at birth explains that altruistic older individuals want to work longer in order to have more income available to insure their descendants. The ratio of bequests to aggregate wealth jumps to 2.42. The sensitivity analysis in Section 6 will allow us to go more into details about the interaction between pension adjustments and altruism.

For all ability levels, given the average wealth in the economy, the majority of workers retire at the age at which the wealth thresholds become zero, 62 for L type, 67 for M and 69 for H. Some workers are rich enough to retire earlier. We indicate in Table 10 (columns (2), (4) and (6)) the percentage of employed workers within each ability group who decide to retire at a given age. For instance, 7.42% of L type employed workers are rich enough ($A > A^*$) to retire at age 60. Table 10 shows that 24% of H and 23% M type workers retire before their respective peaks versus 12% only for L type workers. These behaviors limit the impact of incentive schemes in each ability group. This heterogeneity within each ability group mirrors wealth distribution. The L type worker who retires before 62 has inherited substantial wealth from his father, who belonged to a higher ability category. They are thus rich enough to discard the incentive scheme. This feature is exacerbated in the case of M individuals whose retirement age spans 60 to 67. Similarly, some H type agents belonging to a dynasty of High ability workers are wealthy enough to completely disregard incentives and to retire before 69. Wealth heterogeneity matters for understanding the retirement distribution by inducing within-ability class variations.

It is also noticeable that the ability groups do not display an homogeneous behavior of delayed retirement. In particular, L type workers delay retirement by only 2 years with incentive schemes, which limits the impact of incentive schemes on retirement decisions since they represent half the labor force. The between-ability group variations is crucial to understand the retirement distribution. The threshold A^* is systematically the highest for individuals of type H and the weakest for Low ability workers. H individuals are then the most willing to work longer. They face the highest probability of surviving as retired and their wage is high relative to their pension

³⁰Without pension adjustments, the thresholds are equal to 0 as soon as 60 for M and L ability groups, and are equal to 65.6 at 60, 65.4 at 61, 65.1 at 62 and 0 from 63 on for the H group.

Figure 8: Value function of H type worker of 64 years old

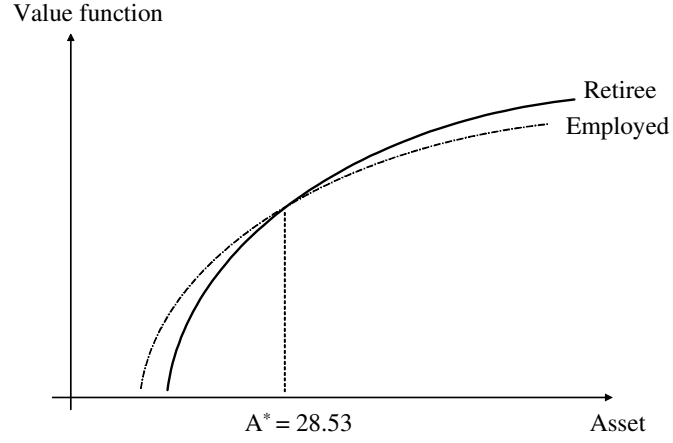

Table 10: Wealth thresholds A^* in retirement decision rules ($\eta = 0.9$, benchmark calibration)

Age	H		M		L	
	A^*	% ret.	A^*	% ret.	A^*	% ret.
	(1)	(2)	(3)	(4)	(5)	(6)
60	79.11	0	25.36	3.77	9.27	7.42
61	68.05	0	21.87	1.19	4.25	4.84
62	66.14	0	22.39	0	0	87.74
63	38.23	2.06	21.10	0.10	0	0
64	28.53 ^a	2.56 ^b	14.04	3.74	0	0
65	27.94	0.22	9.94	3.53	0	0
66	21.61	4.42	4.03	11.16	0	0
67	17.27	4.02	0	76.51	0	0
68	10.81	10.93	0	0	0	0
69	0	75.78	0	0	0	0
70	0	0	0	0	0	0

a: H employed agent's decision rule:

If his current wealth is greater than 28.53, he retires

Otherwise, he keeps on working

b: 2.56% of H type employed workers retire at age 64

(their replacement ratio is the lowest).

5 Maintaining a tax on continued activity

The PAYG system faces two challenges: ensuring the financial sustainability of the system while preserving the well-being of retirees and workers. We argue in this paper that more actuarially-fair schemes could help meet these two objectives.

First (Section 5.1), we explore the financial implications of giving only a fraction of the actuarially-fair scheme to agents willing to postpone retirement. This incentive program can actually encourage individuals to work longer, thereby allowing the SS to collect additional taxes. However, the SS has to carefully choose the fraction of the actuarially-fair scheme given to individuals. On the one hand, incentives have to be large enough to entice people to delay retirement. On the other hand, when incentives are high, pensions to be paid are increased. We show that this trade-off is captured by a Laffer Curve on the continued activity. We determine thereafter the fraction of the actuarially-fair scheme which should be given to individuals in order to maximize the SS financial surplus. In this analysis, all equilibrium conditions defined in Section 2.6 hold, except condition (v).

Secondly (Section 5.2), the actuarially-fair scheme could also be used as a tool to make individuals postpone retirement while increasing their welfare. We then determine the fraction of the actuarially-fair scheme which should be given to individuals in order to maximize the average measure of the expected lifetime utility of newborns. In this welfare analysis, all equilibrium conditions hold, including condition (v). The SS also faces a trade-off in terms of welfare. By lowering the tax on continued activity, the SS improves the expected welfare for the end of the life cycle when workers are free to choose their retirement age. However, the SS then collect fewer contribution taxes on continued activity, which results in higher contribution rates during the working life. This may decrease the expected welfare for these ages in case of binding liquidity constraints.

5.1 A public finance perspective

Individuals now receive a fraction $(1 - \tau)$ of the actuarially-fair scheme. This Section aims at assessing the incentive schemes that maximize the Social Security surplus. In order to measure the magnitude of these financial gains, we express them in terms of percentage points of reduction

Table 11: The Laffer curve

τ	0	0.1	0.2	0.30	0.4	0.5	0.55 ^a	0.6	0.7	0.8	0.9	1
$-\Delta\theta$	0	0.346	0.572	0.673	0.844	0.863	0.897 ^b	0.868	0.659	0.285	0.081	0
Dep. ratio	37.85	38.07	39.36	40.70	40.94	41.63	41.80 ^c	42.14	43.08	44.19	44.69	44.85

a: When individuals are given $1 - \tau = 45\%$ of the actuarially-fair scheme, the implied SS surplus is equivalent to a 0.897 percentage point fall in the contribution rate (b) and the dependency ratio equals 41.80% (c)

in the contribution rate ($-\Delta\theta$). Notice that we do not actually implement this reduction, as we only want to compute the Social Security surplus.

The first line in Table 11 displays the relationship between the payroll tax θ and the fraction τ of the actuarially-fair adjustments levied by the SS. With low values of τ , individuals have a strong incentive to delay retirement: the dependency ratio is increasing in τ . However, the incentives are close to the actuarially-fair value, which is, by definition, neutral for the SS deficit. As τ increases, individuals are given a smaller fraction of the actuarially-fair scheme which allows the SS to collect additional taxes. In Table 11, as τ increases, $-\Delta\theta$ indeed goes up.

Nevertheless, with high values of τ , employees are given only a small incentive to work beyond the full rate. With $\tau = 0.9$, all social groups retire as soon as they reach the full rate, except some High ability workers: the dependency ratio is close to the benchmark one. Most individuals do not respond to incentives. The change in Social Security provisions does not significantly improve the SS budget.

Figure 9 displays the Laffer Curve (bold line - scale on the right hand side) which summarizes the relationship between τ and $-\Delta\theta$. The SS surplus is maximum for τ_S . Table 11 shows that τ_S equals 0.55: the contribution rate then decreases by 0.897 of a percentage point. This result gives some support to the 2003 reform implemented in France. Indeed, when one multiplies the actuarially-fair schemes (displayed in Table 9) by $1 - \tau_S$, for ages below 65, percentage increases in pensions for additional working years hover around 3%.

The distribution of retirement age for $\tau = \tau_S$ is displayed in Figure 10. There are still 62% of employed workers who retire at the full pension age. Low-skilled workers do not respond to incentives. However, around 85% of Medium and High skilled workers put off retirement beyond

Figure 9: The Laffer curve and the welfare optimum

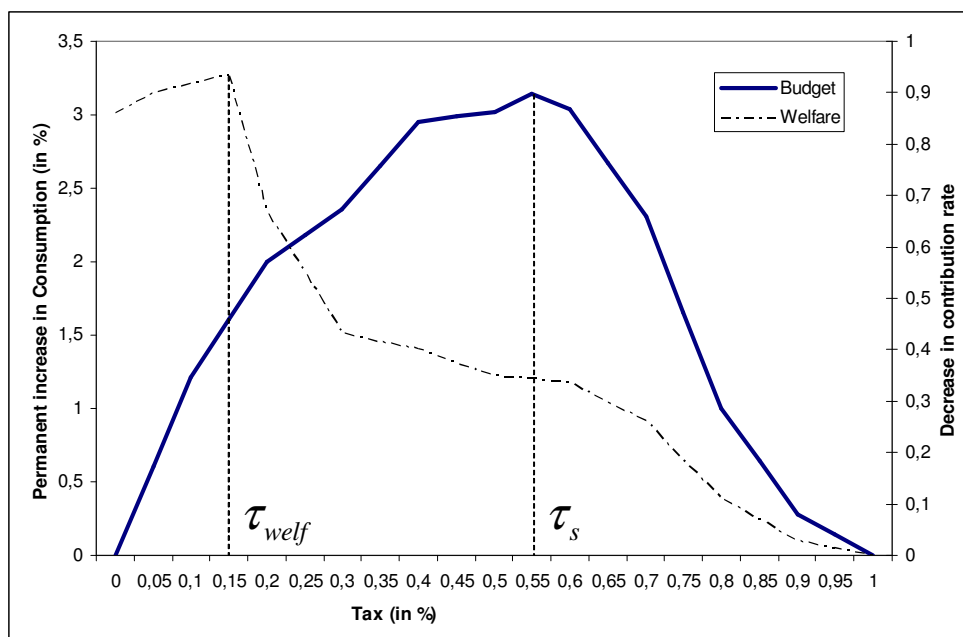

their full pension age. This retirement distribution yields a higher SS surplus than the case of a lower tax on continued activity. Indeed, if individuals are given more actuarially-fair schemes, low-skilled workers do delay retirement, but such a policy is costly for the SS budget.

Finally, it appears that a relevant strategy in terms of budgetary surpluses is to target the retirement age postponing of the most willing individuals, which then allows the SS to collect a large fraction of the continued work tax.

5.2 A welfare criterion

We consider the expected welfare of an individual at the beginning of his working life before drawing on his labor ability. The wealth distribution of new born workers is given by the endogenous stationary distribution of bequests. This expected welfare criterion takes into account the descendants' welfare. We determine the fraction of the actuarial adjustment which maximizes this welfare criterion. The SS budget is balanced by the contribution rate θ for any values of τ . Contrary to the preceding section, the decrease in the contribution rate generated by the retirement delaying policy is now implemented. It directly affects payroll taxes paid by workers and firms and, in addition, at the general equilibrium, it affects the market interest rate and

Figure 10: Distribution of retirement age at the maximum of the Laffer curve ($\tau = \tau_S$)

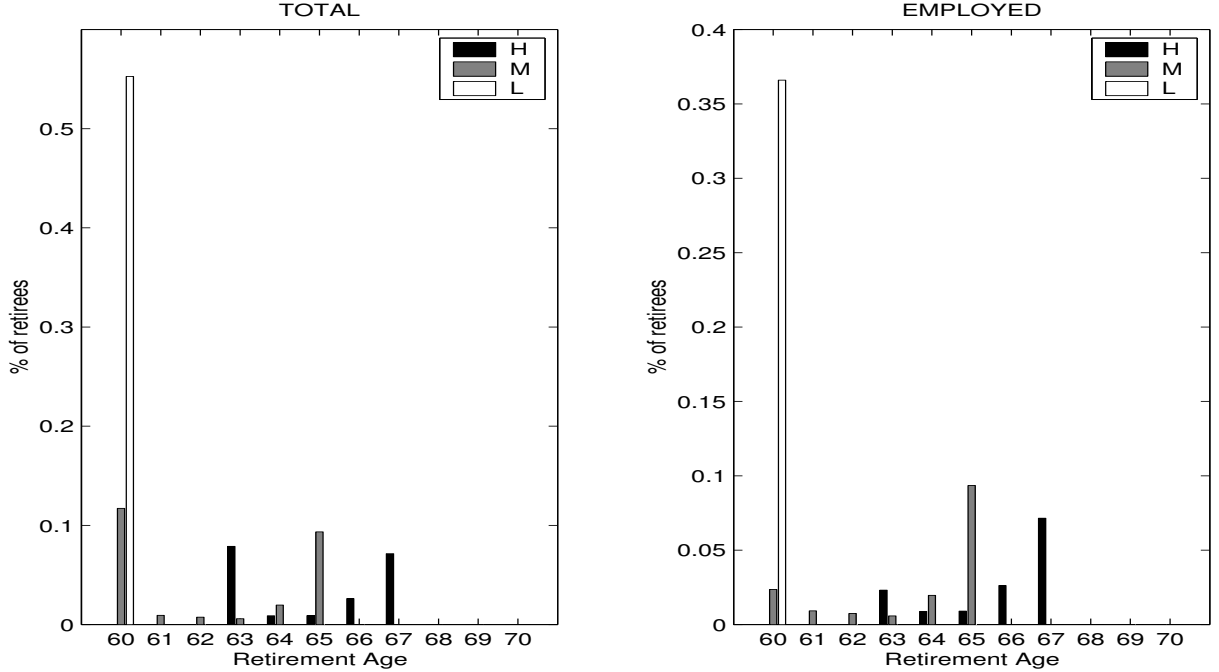

wages. It also modifies the retirement behavior, but only very slightly, as the pension adjustments compensate mostly for the decrease in the contribution rate. This is why the equilibrium contribution rate decrease (the first line of the Table 12) is very close to its value when the SS surplus is not redistributed (the first line of the Table 11). As the effective decrease in the contribution rate pushes (slightly) agents to delay their retirement, the decrease in the general equilibrium case is mostly higher, despite the increase in the wages (the contribution base) at the general equilibrium.³¹

We compare the expected welfare of new-born workers in the economy, with versus without incentives, and determine the optimal marginal tax τ_{Welf} by simulations (Table 12). In order to calculate the size of this difference, we compute the compensation variation in permanent consumption making an individual indifferent between these two economies. A 3.01% increase in permanent consumption is necessary to compensate individuals for living in an economy, without any adjustments compared to an economy with perfect actuarially-fair adjustments.

³¹Note however that, for $\tau < 0.15$, this wage effect dominates as the higher the pension adjustments, the larger the increase (decrease) in wages (the interest rate).

Table 12: The welfare optimality of the tax on continued activity

τ	0	0.05	0.10	0.15 ^a	0.2	0.30	0.4	0.5	0.55	0.6	0.7	0.8	0.9	1
$-\Delta\theta$	0	0.176	0.345	0.508 ^b	0.583	0.675	0.853	0.890	0.911	0.875	0.663	0.290	0.081	0
Welfare	3.01	3.14	3.21	3.27 ^c	2.34	1.51	1.40	1.22	1.20	1.17	0.91	0.38	0.10	0
Welfare $a = 0$	1.81	1.85	1.87	1.89 ^d	1.75	1.67	1.45	1.42	1.27	1.24	0.90	0.40	0.09	0

a: when individuals are given $1-\tau = 85\%$ of the actuarially-fair scheme,

b: the equilibrium contribution rate decrease is equal to 0.508 percentage point.

c: A 3.27% increase in permanent consumption is necessary to compensate individuals for living in a economy with $\tau = 1$ compared to an economy with $\tau = 0.15$

d: A 1.89% increase in permanent consumption is necessary to compensate liquidity-constrained young agents for living in a economy with $\tau = 1$ compared to an economy with $\tau = 0.15$

We first verify that, for τ between 1 and τ_S , it is welfare-improving to reduce τ . As long as the economy is on the right side of the Laffer curve (from $\tau = 1$ to $\tau = 0.55$), as was the French economy before the 2003 reform, decreasing the implicit tax on continued activity is necessarily welfare-improving. Starting from the case without pension adjustments ($\tau = 1$), workers, who freely choose to delay retirement when old, benefit from the reform as well as younger workers, since they bear less of the financial burden. In terms of permanent consumption, the gains go up from 0 to 1.20% at the maximum of the Laffer curve ($\tau = 0.55$).

From the maximum of the Laffer curve ($\tau = \tau_S$) to the perfect actuarially-fair adjustment ($\tau = 0$), there is potentially an intertemporal trade-off in terms of welfare between the expected gains as an old worker and the expected losses as a young worker. Indeed, in this interval, increasing the generosity of incentive schemes brings satisfaction at the end of working life when workers benefit from the reduction in the marginal tax on continued activity. However, this policy yields less revenue to the SS. The magnitude of the decrease in the contribution rate goes down, thereby harming the expected welfare during the working life in case of binding liquidity constraints. This intertemporal transfer ensured by the SS system does indeed allow the liquidity-constrained agents to get (as if they could borrow more) a given fraction of the pension adjustment that they would receive by delaying retirement. As we move down from $\tau = \tau_S$ to $\tau = 0$, the gains are at first larger than the losses. However, from $\tau = \tau_{Welf}$ to

$\tau = 0$, the losses during the liquidity-constrained periods of the working life dominates the expected gains when old. Relative to the Laffer curve in terms of public finance, the maximum is shifted leftward (Figure 9, broken line, left hand side) and reached when $1 - \tau_{Welf} = 85\%$ of the actuarially-fair pension adjustment is given to agents who delay retirement.

In the context of liquidity-constrained workers, the actuarially-fair adjustments are no longer optimal, even if more must be given to workers than in the financial surplus case. Indeed, a significant proportion of the population benefits from the decrease in the contribution rate. 34.7% of workers before the early retirement age are liquidity-constrained. It must be emphasized that focusing only on the welfare of new-born individuals who are liquidity-constrained (last line of Table 12) would have led to recommend the same pension adjustments³². The proportion of liquidity-constrained young workers in the labor force is then a key determinant of the optimal degree of fairness of the pension adjustments.

Beyond this intertemporal transfer, incentive schemes also lead to transfers across abilities. Indeed, 58.5% of the liquidity-constrained agents belong to the L group, 26% to the M type and 15.5% to the H class. L type individuals are then the primary winners of the lower contribution rate. With $\tau = \tau_{Welf}$, M and H type workers still benefit from incentive schemes. This can be seen in Figure 11 that displays the retirement distribution for the optimal welfare taxation. 95% of the H type workers delay retirement, 93% for the M-type and 86% for the L-type (figure 11). The number of delayed years is lower for L-type workers. H and M workers then contribute (freely) more to the financial surpluses of the SS. The redistribution of the financial surpluses through an even decrease in the payroll tax is particularly favorable to Low-skilled workers. Indeed, these agents are more liquidity-constrained and benefit from the transfers of some part of the surpluses generated by the other two ability groups. The incentive policy then redistributes income towards L type agents, thereby providing insurance against the ability risk at birth. This feature contributes to maintaining a tax on continued activity at the social optimum. It also explains why this policy could still be optimal in the cases where inter vivos transfers would be possible³³ (Fuster et al. (2003)).

³²The decrease in the contribution rate per se would lead to recommend smaller pension adjustments, but higher values of τ imply higher interest rates and then lower wages, harming the welfare of liquidity-constrained agents.

³³We have not verified this conjecture.

Figure 11: Distribution of retirement age for the welfare optimizing tax on continued activity ($\tau = \tau_{Welf}$)

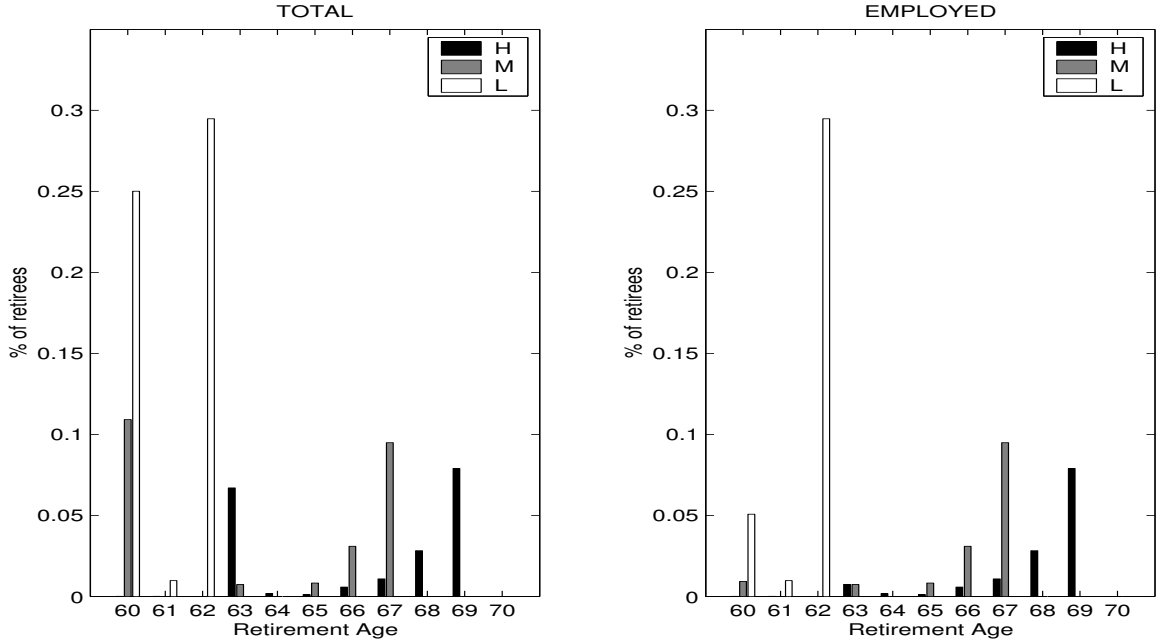

The redistribution to all workers of the surplus generated by people who delay retirement provides another source of risk-sharing. All workers are not in a position to benefit from pension adjustments. Some of them, roughly one quarter of older workers, are unemployed and actually out of the labor force before the early retirement age. The policy which consists in maintaining a tax on continued activity and in redistributing it to all workers enables a partial sharing of the risk of employment between lucky and unlucky older workers. This result illustrates the importance of taking into account status in the labor market (employed versus unemployed) when analyzing retirement decisions and SS reforms.

6 Sensitivity analysis

Several parameters can be candidates for sensitivity tests.³⁴ As we stressed in Section 4.2 the strong interaction between wealth and retirement decisions, we now propose in this Section a

³⁴We choose to leave unchanged the elasticity of substitution between consumption and leisure even if the extent to which the quantitative results would change if some other elasticity were assumed is unclear.

sensitivity analysis to altruism and risk aversion parameters³⁵. In order to make our sensitivity results comparable to the benchmark case³⁶, we give a comprehensive analysis of retirement decisions in the case of perfect actuarially-fair adjustments ($\tau = 0$). The distributions of retirement age displayed in this Section have to be contrasted with Figure 7. We then only focus on the degree of altruism when studying the sensitivity of the Laffer curve. The results are qualitatively similar for alternative calibrations of the risk aversion parameter.

6.1 The retirement decision and the actuarially-fair adjustments

6.1.1 The degree of altruism

We study in this section how altruism affects the response of retirement decisions to actuarially-fair pension adjustments. When altruism is shut off ($\eta = 0$), Table 13 shows that the older workers are less responsive to incentives to delay their retirement age. Relative to the benchmark case ($\eta = 0.9$), they indeed retire sooner, whatever the ability group considered. In Table 13, we show that the thresholds A^* are inferior to those obtained in the benchmark calibration of altruism (Table 10), whatever the age and the ability considered. The dependency ratio goes up from 37.85% with $\eta = 0.9$ to 41.22% with $\eta = 0$. Altruism appears to be an important motive to retire later for all ability groups, as they are all eager to leave bequests to their off-springs. The workers belonging to the Low ability group have the higher probability to die and to have a son in the L ability group (see Tables 1 and 4), whereas the High ability group would experience the largest decrease in wages in case of realization of this event. The M skilled workers face probabilities close to those of the L ability group, with a much higher earning risk.

Bequests mirrors this precautionary saving motive: for $\eta = 0.9$ relative to $\eta = 0$, bequests per capita are multiplied by 2.4, 3.4 and 2.2 for the H, M and L ability groups respectively. This explains the higher elasticity of the retirement age to the actuarially-fair adjustments for the benchmark calibration of altruism. Consistently with the behavior of the intensive margin of labor in presence of precautionary savings motive (Low (2005)), income uncertainty at birth causes older altruistic individuals to work longer in order to have more income available to insure

³⁵We have verified that individuals are more or less responsive to incentive schemes, according to the value of the leisure parameter ν . But the sensitivity is very weak for values lying in the admissible interval defined in the calibration.

³⁶In each sensitivity exercise, we choose to adjust accordingly the discount factor β and the leisure parameter ν to match respectively the capital/output ratio and the retirement distribution in the economy without incentives.

their descendants. The delay of the retirement age makes accumulating precautionary assets less costly in terms of utility.

When individuals have no intergenerational linkages ($\eta = 0$), their preference horizon coincides with that of their own life. It is noticeable that the Low ability group retire at the early retirement age despite the actuarially-fair pension adjustment scheme (lower panel of Figure 12). High death probability and generous pensions push them to retire as soon as possible. This is not the case for M and H ability groups who are still eager to delay their retirement. Moreover, the heterogeneity within each ability group decreases: in each ability group, retirement decisions are more concentrated at the peak. This comes from the less uneven wealth distribution across the older workers when $\eta = 0$. The Gini coefficient amounts to 0.58 with $\eta = 0$ versus 0.73 in the benchmark calibration. This is another evidence in favor of the influence of altruism on retirement decisions.

Altruism plays a key role in making individuals of all ability groups more willing to delay retirement. By generating more wealth heterogeneity, altruism also allows rich individuals to retire early. The latter effect is dominated by the former.

Figure 12 displays the distribution of retirement age obtained for intermediate values of η . We verify that decreasing the degree of altruism continuously shifts the retirement distribution to the left and so makes the dependency ratio higher: the latter increases from 37.85% for $\eta = 0.90$ to 38.45% and 39.77% for $\eta = 0.75$ and $\eta = 0.40$ respectively.

Altruistic intergenerational linkages thus appears as an important feature to take into account in order to identify the elasticity of the retirement age to incentives, and then to quantifying the Laffer curve on the continued activity. Section 6.2 illustrates the sensitivity of the Laffer Curve to altruism.

6.1.2 Risk aversion

The PAYG system insures the individuals against mortality risks. The degree of risk aversion could then interact with retirement decisions through the earning risk at birth. Workers may decrease their savings for bequest motives for low values of risk aversion ($\tilde{\sigma} = 1.5$). Individuals actually choose to delay retirement more as the intertemporal substitution elasticity of labor is higher (Figure 13). The dependency ratio declines and reaches 36.62%. Conversely, a higher value of $\tilde{\sigma}$ ($\tilde{\sigma} = 2.5$) lowers the efficiency of the actuarially-fair adjustments in terms of delayed

Figure 12: Retirement decisions of employed individuals for various degrees of altruism (benchmark calibration $\eta = 0.9$)

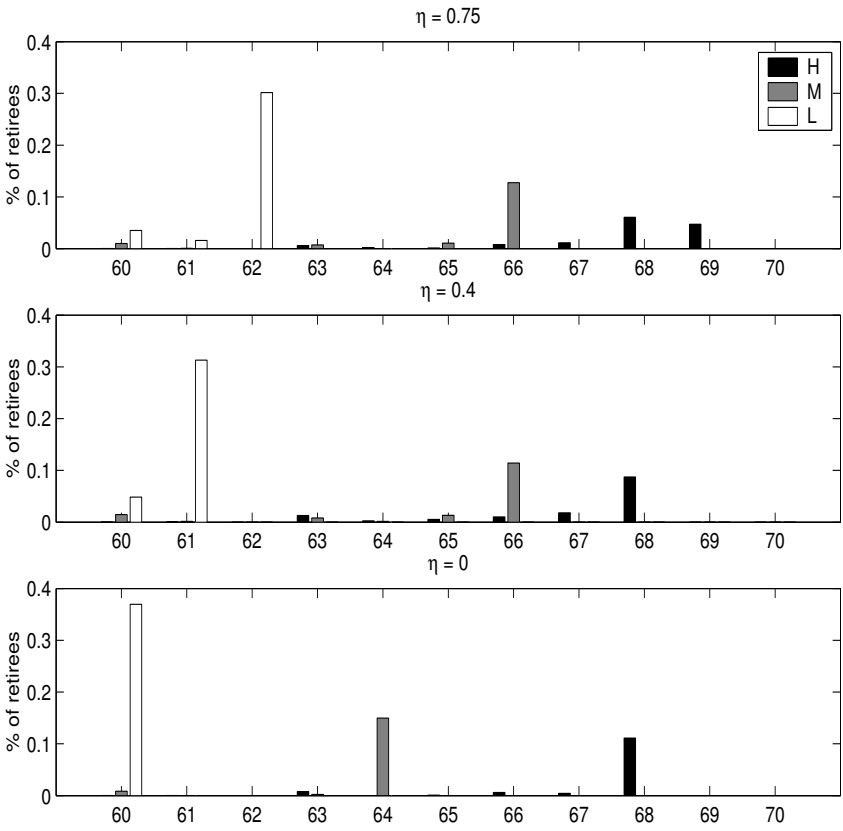

Table 13: Wealth thresholds A^* in retirement decision rules and retirement decisions ($\eta = 0$)

Age	H		M		L	
	A^*	% ret.	A^*	% ret.	A^*	% ret.
	(1)	(2)	(3)	(4)	(5)	(6)
60	57.1	0	18.6	5.3	0	100
61	52.78	0	18.6	0	0	0
62	53.2	0	16.8	0	0	0
63	19.6	6.0	13.6	1.3	0	0
64	19.3 ^a	0	0	93.3	0	0
65	16.8	5.8	0	0	0	0
66	11.3	4.7 ^b	0	0	0	0
67	8.1	3.3	0	0	0	0
68	0	85.3	0	0	0	0
69	0	0	0	0	0	0
70	0	0	0	0	0	0

a: H employed agent's decision rule:

If his current wealth is greater than 19.3, he retires

Otherwise, he keeps on working

b: 4.7% of H type workers retire at age 66

retirements.

6.2 The Laffer curve and the degree of altruism

Retirement decisions are sensitive to altruism and risk aversion. When individuals are less responsive to the incentive policy, the trade-off between the tax on continued activity and the SS surplus worsens. We illustrate this point for the degree of altruism.

A lower degree of altruism deteriorates the trade-off inherent in the Laffer curve³⁷. Relative to the benchmark calibration, the Laffer curve and its maximum are shifted to the left. As workers choose to retire sooner, it is optimal in terms of public finance to reduce the tax on continued activity more. Whereas 45% of the actuarially-fair adjustment must be given in the benchmark calibration, this proportion increases as long the degree of altruism decreases: 55% for $\eta = 0.75$, 60% for $\eta = .40$ and finally 70% for $\eta = 0$. As shown by Figure 14, lower altruism yields less significant increases in the total Social Security surplus. The benchmark case ($\eta = 0.9$) generates a decrease of 0.897 percentage point in the contribution rate. Only one third of this decrease is reached for $\eta = 0$. This last point indicates that the benchmark

³⁷It is also the case for a higher degree of risk aversion.

Figure 13: Distribution of retirement age of employed individuals for various degrees of risk aversion $\tilde{\sigma}$ (benchmark calibration $\tilde{\sigma} = 2$)

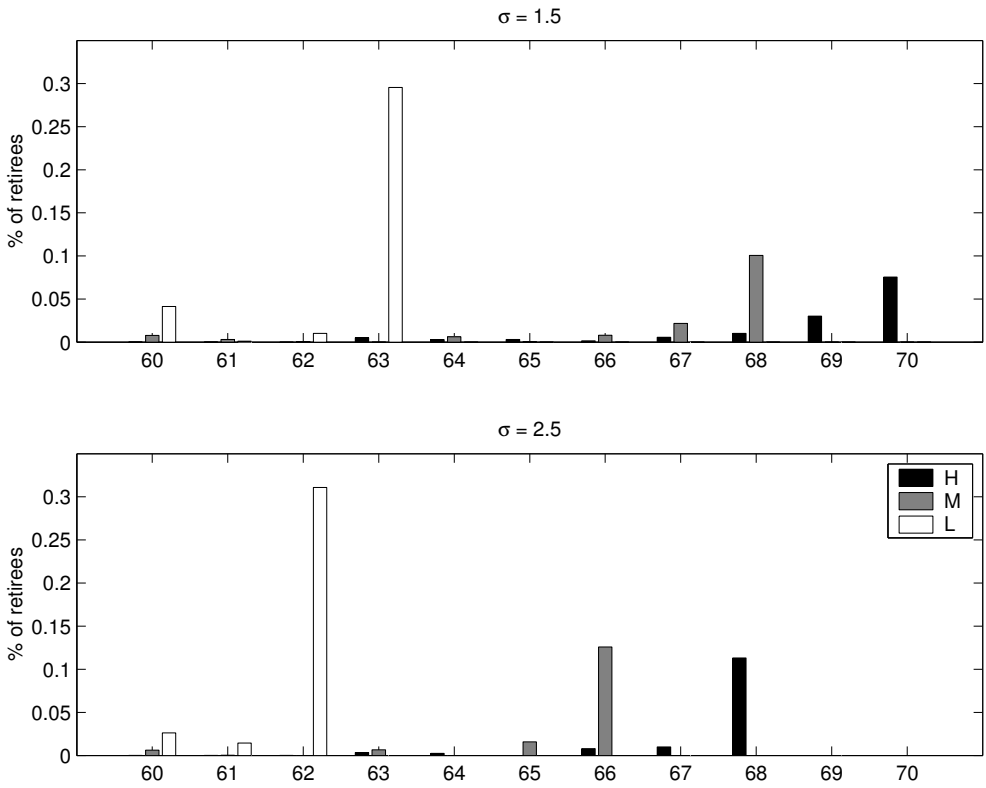
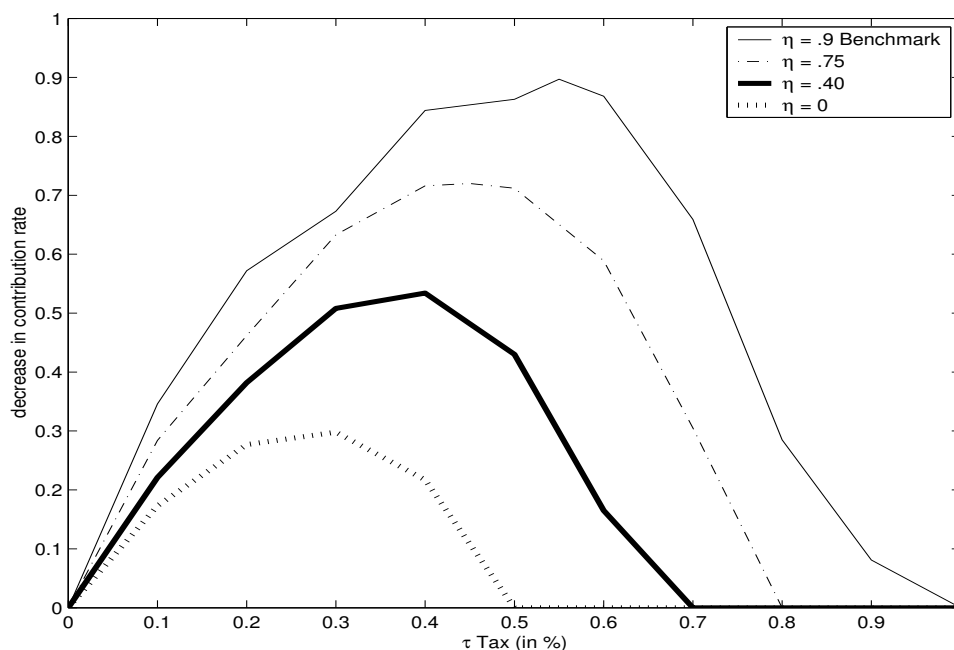

Figure 14: Laffer curve for various degrees of altruism η



calibration³⁸ of the altruism parameter (in order to match the French ratio of annual flow of bequests to aggregate financial wealth) constitutes a favorable case scenario for incentives lower than the actuarially-fair adjustment schemes³⁹. This is corroborated by the welfare sensitivity to altruism. Decreasing the degree of altruism leads the maximum of the welfare curve to shift leftward relative to Figure 9: for $\eta = 0.40$, the actuarially-fair pension adjustment is optimal. These results show that the degree of intergenerational linkages is a key dimension in the retirement decisions and needs to be taken into account in the quantification of the Laffer curve on the continued activity tax.

7 Conclusion

This paper proposes to give individuals only a fraction of the marginal actuarially-fair incentives in the case of postponed retirement and to redistribute the surplus then generated through a decrease in the payroll contributing tax. Social Security then faces a trade-off between giving

³⁸Notice that our calibration of altruism implies that agents are less altruistic than the perfect altruism case which is considered in the literature (Fuster, 1999; Castañeda et al., 2003; Fuster et al., 2003).

³⁹On the other hand, considering lower risk aversion would have improved the efficiency of this policy.

enough incentives to make individuals actually delay retirement and giving little increase in pensions in order to maximize the financial surpluses. This trade-off is captured by a Laffer curve that we quantify on French data. The maximum of the Laffer curve is reached when 45% of the actuarially-fair scheme is given to individuals willing to delay retirement, which is close to the 3% increase in pensions proposed by the 2003 French reform.

When the Social Security aims at maximizing welfare, the optimal tax on postponed retirement is lower than the one obtained from the Laffer curve but still strictly positive. With a positive tax on postponed retirement, the redistribution of the contributions collected on the additional working years are beneficial to liquidity-constrained and low ability workers and unemployed people at the end of working life. Maintaining a tax on continued activity allows the SS system to implement transfers across and within generations which are welfare-improving.

All these results are derived from a dynastic general equilibrium model where the endogenous wealth distribution and intergenerational linkages play a key role in determining retirement decisions, especially when incentive schemes are introduced in SS provisions.

This paper shows that countries whose SS system is still far from actuarially-fair pension adjustments should urgently implement a reform partially closing the gap. Such a delayed retirement age policy is incentive-compatible. Moreover, by lowering the payroll tax⁴⁰ while maintaining a tax on continued activity, the reform can spread the gains over all the population.

Decreasing the tax on continued activity, by putting off the end of career horizon, could also encourage a more intensive job-search by older unemployed workers before the early retirement age. In this paper, we have considered exogenous employment risks. This calls for a more general approach to older workers participation rate. Hairault et al. (2006) propose a first investigation toward this direction, but disregard wealth accumulation. It constitutes a promising avenue of research.

⁴⁰One could also say that this policy will limit the necessary increase in the payroll tax to finance the expected deficits in the coming years.

A The complementary schemes

The difference between the General Regime and Mandatory Complementary Schemes (MCS) lies in the way the contribution rate affects the level of the pension. In the General Regime, the level of the contribution rate, and so the magnitude of the contribution to the pension system, does not affect the level of the pension. The length of contribution and the average annual wage are the only elements of the individual's working life that are included in the pension formula. In contrast, in mandatory complementary schemes, the level of the contribution rate directly determines the level of the pension. The contribution rate enables people to buy points. Each year, a fixed proportion of the wage is devoted to the purchase of these points. The pension paid by mandatory schemes converts the number of points into euros. The General Regime is thus a defined benefit plan while complementary schemes are defined contribution plans.

A.1 Presentation

“Points” are purchased by each individual during his career. Each year, a fixed proportion c^{MCS} of wage w is devoted to the purchase of these points. One euro of earnings yields $1/p^{MCS}$ points. At the age of retirement, points are converted into euros of pension by multiplying the number of points by a coefficient denoted v^{MCS} (value of the point). The pension at age z then amounts to

$$\omega^{MCS}(z) = \text{points}^{MCS}(z) \times v^{MCS} \times \text{penalty}(z) \quad (9)$$

where $\text{points}^{MCS}(z) = \sum_{i=1}^z \frac{c^{MCS}(i)w(i)}{p^{MCS}(i)}$ denotes the total number of points accumulated throughout the years, v^{MCS} the value of each point at the date of retirement. If one chooses to retire before contributing the normal number of quarters d^n or before the age of 65, penalties ($\text{penalty}(z)$) are applied to the pension. For non-executives (L and M type workers), contributions are collected by MCS for Non Executives (hereafter MSCNE). For executives (H type workers), MCSNE (respectively MCS for Executives, hereafter MCSE) collects the contribution for the part of the wage below (respectively above) the Social Security cap. Executives' MCS pension is then paid by MCSNE and MCSE. For executives and non executives, different contribution rates c^{MCS} apply to the part of the wage below and above the Social Security cap. The contribution rate then depends non-linearly on the wage.

Table 14: MCSNE

c_1^{MCSNE}	c_2^{MCSNE}	p^{MCSNE}	v^{MCSNE}
0.04	0.1	22.4	2.455

Table 15: MCSE

c_2^{MCSE}	p^{MCSE}	v^{MCSE}
0.12	19.52	2.303

Finally, MCSNE and MCSE introduce a wedge between the contribution rate paid by workers ($c^{MCS'}$) and the contribution rate that grants them points (c^{MCS}). In the data, $c^{MCS'} > c^{MCS}$: by imposing this discrepancy between the tax paid and the tax giving the right to points, complementary schemes anticipate the expected deficit associated with the future demographic change. MCSNE and MCSE apply different wedges. Let $\frac{c^{MCSNE'}}{c^{MCSNE}}$ (respectively $\frac{c^{MCSE'}}{c^{MCSE}}$) be the wedge used by MCSNE (respectively MCSE). These ratios are endogenously determined at the stationary equilibrium.

A.2 Calibration

The Social Security cap used to compute the pensions paid by the General Regime and complementary schemes is set to its 1994 value, i.e. 156720Fr a year. The calibration of parameters of MCS in equation (9) are given by Tables 14 and 15. The contribution rates applied to non executives are c_1^{MCSNE} (c_2^{MCSNE}) for the part of the wage below (above) Social Security cap. For executives, the contribution rates are c_1^{MCSNE} (c_2^{MCSE}) for the part of the wage below (above) Social Security cap. The purchase price of each point p^{MCS} and the value of each point at retirement v^{MCS} differ for MCSNE and MCSE. These values correspond to the ones prevailing in 1994 and were provided by MCSNE and MCSE. 2/3 of the contributions to the complementary schemes are paid by employers. This ratio as well as MCS parameter values are left unchanged throughout the paper. Table 16 presents the value of penalties (equation (9)).

Table 16: Penalties for MCSNE and MCSE

Age z	55	56	57	58	59	60	61	62	63	64
$penalty(z)$	0.43	0.50	0.57	0.64	0.71	0.78	0.83	0.88	0.92	0.96

References

- Aglietta, M., D. Blanchet and F. Héran, *Démographie et Économie*, volume 35 of *Rapport CAE* (Paris: Conseil d'Analyse Economique, 2002).
- Aiyagari, S. R., "Uninsured Idiosyncratic Risk and Aggregate Saving," *The Quarterly Journal of Economics* 109 (August 1994), 659–684.
- Arrondel, L., "Risk Management and Wealth Accumulation Behavior in France," *Economics Letters* 74 (January 2002), 187–194.
- Arrondel, L. and A. Laferrere, "Taxation and Wealth Transmission in France," *Journal of Public Economics* 79 (2001), 3–33.
- Arrondel, L. and F. Laferrère, "Sucessions et Héritiers À Travers Les Données Fiscales," *Economie et Prévision* 100-101 (1991), 137–175.
- Attanasio, O. P., J. Banks, C. Meghir and G. Weber, "Humps and Bumps in Lifetime Consumption," *Journal of Business and Economic Statistics* 17 (1999).
- Aubert, P., D. Blanchet and D. Blau, "The Labour Market After Age 50 : Some Elements of a Franco - American Comparison," INSEE Working Paper g2005 - 13, INSEE, November 2005.
- Auerbach, A. and L. Kotlikoff, *Dynamic Fiscal Policy* (Cambridge Univ. Press, 1987).
- Bardaji, J., B. Sédillot and E. Walraet, "Les Retraites Du Secteur Public : Projections À L'horizon 2040 À L'aide Du Modèle de Microsimulation DESTINIE," Technical Report G 2004 / 14, INSEE, 2004.
- Becker, G. and N. Tomes, "An Equilibrium Theory of the Distribution of Income and Intergenerational Mobility," *Journal of Political Economy* 87 (1979), 1153–1189.
- Becker, G. and N. Tomes, "Human Capital and the Rise and Fall of Families," *Journal of Labor Economics* 4 (1986), s1–s39.

- Belhaj, H., “Les Indicateurs de Suivi Des Pensions : L’annexe Statistique Présentée Par la France Dans Le Rapport de Stratégie Nationale sur Les Pensions,” *Solidarité et Santé* 2 (Avril - Juin 2004), 29–52.
- Berkovec, J. and S. Stern, “Job Exit of Older Men,” *Econometrica* 59 (1991), 189–210.
- Blanchet, D. and G. Pelé, “Social Security and Retirement in France,” NBER Working Paper 6214, NBER, October 1997.
- Bozio, A., “Does Increasing Contribution Length Lead to Higher Retirement Age ? Evidence from the 1993 French Pension Reform,” Mimeo, PSE, 2005.
- Caballaro, R. J. and M. Hammour, “The Limits of Special Interest: What Caused Three Decades of High Unemployment in Europe?,” Mimeo, MIT, October 1999.
- Cagetti, M. and M. De Nardi, “Entrepreneurship, Frictions, and Wealth,” Working Paper 2005-9, Federal Reserve Bank of Chicago, 2005.
- Castañeda, A., J. Diaz-Gimenez and V. Rios-Rull, “Accounting for the U.S. Earnings and Wealth Inequality,” *Journal of Political Economy* 111 (2003), 818–857.
- Charpin, J. M., *Rapport Au Premier Ministre : L’avenir de Nos Retraites* (Documentation Française, 1999).
- Coile, C., P. Diamond, J. Gruber and A. Jousten, “Delays in Claiming Social Security Benefits,” *Journal of Public Economics* 84 (2002), 357–385.
- Colin, C., V. Iéhlé and R. Mahieu, “Les Trajectoires de Fin de Carrière Des Salariés Du Secteur Privé,” *Solidarité-Santé* (2000).
- Conesa, J. and D. Krueger, “Social Security Reform with Heterogeneous Agents,” *Review of Economic Dynamics* 2 (October 1999), 757–795.
- Cooley, T. and E. Prescott, “Economic Growth and Business Cycles,” in T. Cooley, ed., *Frontiers of Business Cycle Research* chapter 1 (Princeton University Press, 1995).
- Cremer, H., J. Lozachmeur and P. Pestieau, “Social Security, Retirement Age and Optimal Income Taxation,” *Journal of Public Economics* 88 (2004), 2259–2281.

- De Nardi, M., “Wealth Inequality and Intergenerational Links,” *Review of Economic Studies* 71 (July 2004), 743–768.
- der Klaauw, H. V. and K. I. Wolpin, “Social Security, Pensions and the Savings and Retirement Behavior of Households,” Mimeo, November 2002.
- Diamond, P. and J. A. Hausman, “Individual Retirement and Savings Behavior,” *Journal of Public Economics* 23 (1984), 81–114.
- DREES, “L’Âge de la Liquidation Des Droits À la Retraite de la Génération 1934,” *Etudes et Résultats* 237 (Mai 2003), available at <http://www.sante.gouv.fr/drees/etude-resultat/>.
- Fuster, L., “Is Altruism Important for Understanding the Long-Run Effects of Social Security?,” *Review of Economics Dynamics* 2 (1999), 616–637.
- Fuster, L., A. Imrohoroglu and S. Imrohoroglu, “A Welfare Analysis of Social Security in a Dynastic Framework,” *International Economic Review* 44 (November 2003), 1247–1273.
- Gale, W. and J. Scholz, “Intergenerational Transfers and the Accumulation of Wealth,” *Journal of Economic Perspectives* 8 (Autumn 1994), 145–160.
- Gruber, J. and D. Wise, “Social Security and Retirement: An International Comparison,” *American Economic Review* 88 (May 1998), 158–163.
- Gruber, J. and D. Wise, *Social Security Programs and Retirement Around the World: Micro-Estimation* (National Bureau of Economic Research Conference Report, 2004).
- Gustman, A. L. and T. L. Steinmeir, “The Social Security Early Entitlement Age in a Structural Model of Retirement and Wealth,” NBER Working Paper 9183, NBER, September 2002.
- Hairault, J., F. Langot and T. Sopraseuth, “The Interaction Between Retirement and Job Search: A Global Approach to Older Workers Employment,” IZA Discussion Paper DP 1984, IZA, February 2006.
- Hansen, G. and A. Imrogoroglu, “The Role of Unemployment Insurance in an Economy with Liquidity Constraints and Moral Hazard,” *Journal of Political Economy* 100 (1992), 118–142.

- Huggett, M. and G. Ventura, "On the Distributional Effects of Social Security Reform," *Review of Economic Dynamics* 2 (July 1999), 498–531.
- Imrohoroglu, A., S. Imrohoroglu and D. H. Joines, "Computational Models of Social Security: A Survey," in R. Marimon and A. Scott, eds., *Computational Methods for the Study of Dynamic Economies* (Oxford University Press, 1999), 221–237.
- INSEE, *Mobilité Sociale Tome Deux*, volume 89-90-91 of *Emploi et Revenus* (1995).
- INSEE, "Successions et Donations En 1994, De Plus En Plus de Successions Déclarées," *INSEE première* (June 1997).
- INSEE, "Le Patrimoine National," *INSEE première* (July 1998).
- INSEE, *La Structure Des Salaires En 1994*, volume 146-147 of *Emploi et Revenu* (1999a).
- INSEE, *Revenu et Patrimoine Des Ménages*, volume 28 of *Synthèses* (1999b).
- Kahn, J. A., "Social Security, Liquidity and Early Retirement," *Journal of Public Economics* 35 (1988), 97–117.
- Lindbeck, A. and T. Persson, "The Gains from Pension Reform," *Journal of Economic Literature* 41 (March 2003), 74–112.
- Ljungqvist, L. and T. J. Sargent, *Recursive Macroeconomic Theory* (MIT Press, 2000).
- Ljungqvist, L. and T. Sargent, "Obsolescence, Uncertainty and Heterogeneity : The European Employment Experience," Mimeo, November 2005.
- Low, H. W., "Self-Insurance in a Life-Cycle Model of Labour Supply and Savings," *Review of Economic Dynamics* 8 (2005), 945–975.
- Quadrini, V., "Entrepreneurship, Saving and Social Mobility," *Review of Economic Dynamics* 3 (January 2000), 1–40.
- Rios Rull, V., "Life-Cycle Economies and Aggregate Fluctuations," *Review of Economic Studies* 63 (July 1996), 465–490.

- Rust, J., “A Dynamic Programming Model of Retirement Behavior,” in D. Wise, ed., *The Economics of Aging* (Chicago Press, 1989), 359–398.
- Rust, J. and C. Phelan, “How Social Security and Medicare Affect Retirement Behavior in a World of Incomplete Markets,” *Econometrica* 65 (1997), 781–831.
- Stock, J. and D. Wise, “Pensions, the Option Value of Work, and Retirement,” *Econometrica* 58 (1990), 1151–1180.
- Storesletten, K., C. I. Telmer and A. Yaron, “The Risk-Sharing Implications of Alternative Social Security Arrangements,” *Carnegie-Rochester Conference Series on Public Policy* 50 (June 1999), 213–259.
- Vikram, N. and A. Dhareshwar, “A New Database on Physical Capital Stock: Sources, Methodology and Results,” Technical Report, World Bank, 1995.
- Villa, P., “Séries Longues Macroéconomiques,” Technical Report, CEPII, 1995, available on CEPII website : <http://www.cepii.fr/francgraph/bdd/villa/mode.htm>.