



HAL
open science

Labraunda 2010. A Preliminary report on the Swedish excavations

Olivier Henry, Lars Karlsson, Jesper Blid

► **To cite this version:**

Olivier Henry, Lars Karlsson, Jesper Blid. Labraunda 2010. A Preliminary report on the Swedish excavations. *Opuscula - Annual of the Swedish Institutes at Athens and Rome*, 2011, 4, pp.19-67. halshs-00721064

HAL Id: halshs-00721064

<https://shs.hal.science/halshs-00721064v1>

Submitted on 26 Jul 2012

HAL is a multi-disciplinary open access archive for the deposit and dissemination of scientific research documents, whether they are published or not. The documents may come from teaching and research institutions in France or abroad, or from public or private research centers.

L'archive ouverte pluridisciplinaire **HAL**, est destinée au dépôt et à la diffusion de documents scientifiques de niveau recherche, publiés ou non, émanant des établissements d'enseignement et de recherche français ou étrangers, des laboratoires publics ou privés.

Labraunda 2010

A preliminary report on the Swedish excavations

Abstract

The campaign of 2010 continued the work which was initiated last year. The excavations in the fortress on the Tepesar Hill were completed. The fortress consists of a large, early Hekatomnid tower where two black-gloss vessels indicated a dating of the tower to about 380–350 BC. In the two additions to the tower, several well-preserved vessels dating from the 3rd century BC were uncovered. The latest fragment was a painted piece from a *lagynos* from around 200 BC, but there were no fragments of Megarian bowls. The test probe of last year in the West Church Complex was extended to a larger trench measuring $c. 9 \times 12$ m. Evidence for three major phases could be established by J. Blid: (1) a Late Classical stoa; (2) the stoa colonnade is rebuilt into a Christian basilica of the 5th century AD; (3) a Middle Byzantine building of possibly 12th–13th-century date. Many marble pieces were retrieved from the marble furniture of the church, as well as three sections of white and polychrome mosaics. During the necropolis excavations 29 tombs were investigated, of which 11 were unlooted, in a newly discovered burial ground dating back to the 5th century BC. Although the tombs of this area were modest in shape and in terms of associated deposits, they provide a new insight for understanding the history of the *necropoleis* of Labraunda. Finally, architect Chet Kanra continued working on the plans for the restoration of Andron A, and marble conservator Agneta Freccero conducted trial conservation on an Ionic capital from Andron A. Thomas Thieme and Pontus Hellström gathered further information for their publication of the *andrones*.

Introduction

The sanctuary of Zeus with the double axe is located in Karia in Turkey, 14 kilometres north of Milas, ancient Mylasa (*Fig. 1*). The excavations here by Uppsala University were initiated in 1948, and since 2004 the following three, new research projects are being undertaken: Project director Lars Karlsson is inventorying and excavating in the defensive complexes located around the sanctuary, Jesper Blid is studying the sanctuary in Late Antiquity and conducting excavations in the West Church Complex and Olivier Henry is documenting and

excavating the tombs in the *necropoleis* around the sanctuary and along the Sacred Way.

This year the work in the fortresses included an extensive excavation in the Tepesar Kale fortress, where the main tower was dated to the Hekatomnid period and the extensions in the west and in the south to the 3rd century BC. The trial trench from last year in the West Church Complex was extended into a large excavation trench measuring 9×12 m. Here the remains of a colonnade from a church of the 5th century turned out to be the reused colonnade of a Late Classical stoa. In the necropolis, a large excavation area was opened along the modern road (which was the Sacred Way). In total, Olivier Henry excavated 29 tombs, of which 11 were untouched. The three sections that follow have been written by the three respective field directors.

In the field of marble and architectural conservation we initiated a new research project on the conservation of marble inscriptions and architectural elements lying in the open air at the site. Conservator Agneta Freccero will, in a future report, describe this work. The strengthening of the south wall of Andron A was studied by architect Chet Kanra from Stockholm and a new project is being planned together with a Turkish construction company.¹

¹ I would like to thank the participants in this year's campaign: Prof. Pontus Hellström, Gunilla Bengtsson, MA, and archaeology student Klara Borgström, all from Uppsala University, Lic. Ph. Jesper Blid, Stockholm University, PhD student Naomi Carless Unwin and archaeology student Augustus Lersten, both from the University of London and PhD student Baptiste Vergnaud, Université de Bordeaux. Also participating were architect, PhD Thomas Thieme, Chalmers Technical University, Göteborg, and architect Chet Kanra, Stockholm, Olivier Henry, PhD of Institut Français de l'Études Anatoliennes, Istanbul, Anne Marie Carstens, University of Copenhagen, and conservator, PhD Agneta Freccero, Göteborg. The Labraunda Second Director Suat Ateşlier of Aydın University, Turkey, took excellent care of the excavations during my absence. Representing the Turkish Ministry of Culture and Museums was Zerrin Akdoğan and Melek Çanga, both from the



Fig. 1. View of the Temple of Zeus and Andron A from the northeast. The hill in the background is Tepesar.

The fortresses. Tepesar Kale

(BY L. KARLSSON)

There are five free-standing towers and forts around the Sanctuary of Labraunda. In 2007, we excavated and documented the Burgaz Kale fortress.² During 2008–2009 we investigated the inner fort of the Acropolis Fortress as well as the small tower at Ucalan Kule.³ This year we worked at Tepesar Kale and in 2011 we hope to investigate the towers of Kepez Kule and Harap Kule.

Tepesar Kale is the only free-standing tower that was mentioned with a preliminary drawing in the first Labraunda

publication by Alfred Westholm.⁴ The name Tepesar is a contraction of *Tepe Hisar* meaning the “hill with the fortress”, and the conspicuous ruins must have suggested to people that a major castle once stood here. The hill is the highest and most prominent after the Labraunda acropolis hilltop, and it is the perfect place for a defensive structure (see Fig. 1). The view from the fortress is completely clear in all directions. The view towards the Sanctuary of Labraunda, located 1783 metres from the tower is superb as is the view down towards Mylasa, the Sacred Way and the fortress of Burgaz Kale, located one kilometre further southwest (see Fig. 2). The central tower is built on a level of 591 metres above sea-level, compared to the Temple of Zeus which is located 650 m above sea-level.

The defensive complex at Tepesar Kale consists of a main central tower connected to later added extensions in the west and the south (Figs. 3–4). The central tower is built of very large ashlar blocks, which measure 50 cm in height and are sometimes over 3 metres in length. The measurements of the tower are: 11.52 (east side) × 11.50 (south), 11.40 (north)

Ministry of Culture and Museums in Ankara. The campaign lasted for two months from August 16 to October 15, 2010. The excavations were supported with grants from The Royal Swedish Academy of Letters, History and Antiquities, The Department of Archaeology and Ancient History, Uppsala University, Åke Wiberg's Stiftelse, Helge Ax:son Johnson's Stiftelse, Gunvor and Josef Anér's Stiftelse, Stiftelsen Harald and Tonny Hagendahl's minnesfond, Stefan Lersten and Maggie Dan-Lersten, and The Labraunda Society, Sweden.

² See Karlsson 2008.

³ See Karlsson 2009 and Karlsson 2010.

⁴ *Labraunda* I:2, 13f. and fig. 3.

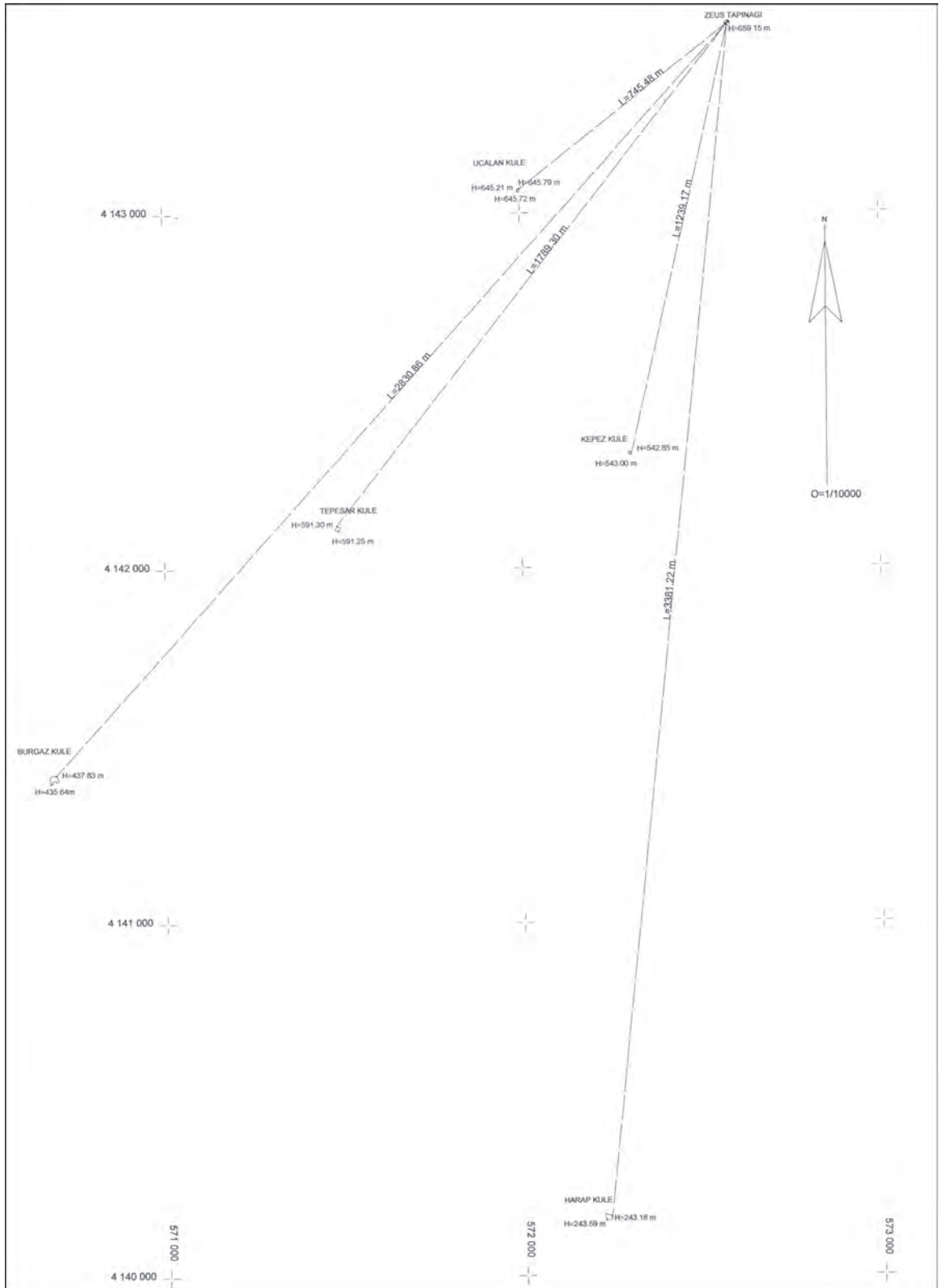

Fig. 2. Diagram indicating the distances of the forts from the Sanctuary of Labraunda.



Fig. 3. Excavation plan of Tepear Kale 2010. By L. Karlsson.

and 11.65 (west). It is divided into four inner rooms (Rooms 1a–d) with very large cross-walls (Fig. 5). The inner rooms measure on average 3.90×3.90 m. The preserved height of the tower is five masonry courses, i.e. 2.5 metres. The masonry consists of a header-and-stretcher technique (Fig. 6). At the corners there are double headers in every second course, a building technique that is typical for Hekatomnid structures⁵ (Fig. 7).

The later added extensions to the tower project out in the west and the south. The west extension is located 7.75 metres

west of the central tower and was probably connected with it by means of a bridge, as there are no setting beds for blocks in-between the buildings. The west tower extension measures 9.91 m in length (E–W) and 9.2 m in width (N–S) (Figs. 8–9). It has a central room and three smaller rooms bordering it in the west and in the south (Rooms 2a–d). In the reconstruction drawing we have put a roof over the central room, while the smaller surrounding rooms are made into battlements at the level of the roof (see Fig. 4). Many roof-tiles were found in the area but no tile fall can be said to be *in situ*.

The south extension is less well-preserved but its shape is similar to the west extension (Fig. 10). It measures 17.30 m in length (N–S) and 4.40 m in width. In the interior of the extension there is a central wall and a cross wall, probably

⁵ In Labraunda seen e.g. in the Stadion and the Southern terrace wall, as well as in the Burgaz and Acropolis fortresses. The feature can also be seen in Halikarnassos; see Pedersen 2011, 367f.

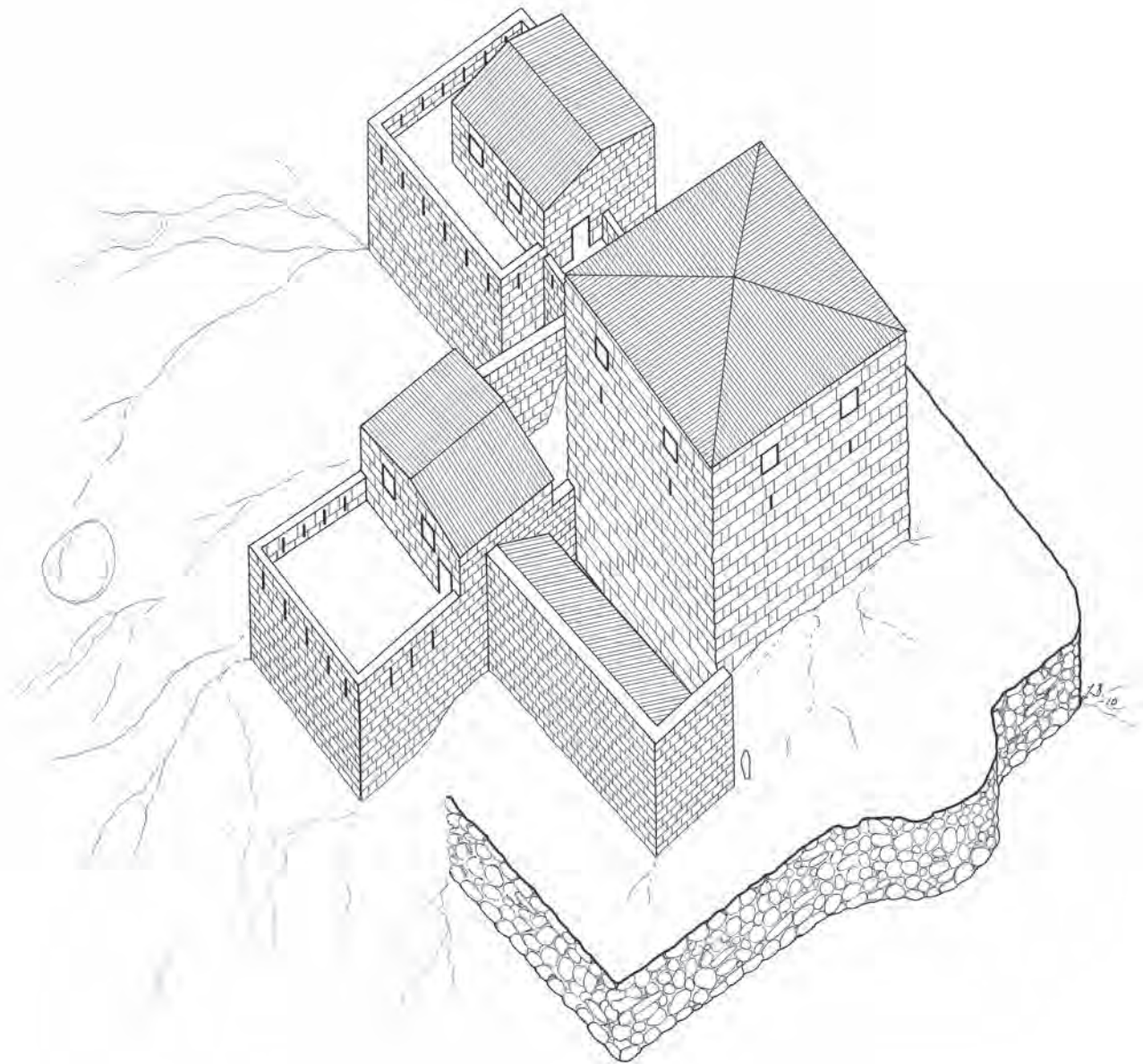

Fig. 4. Reconstruction sketch of the Tepesar Kale complex. By J. Blid.

creating four interior rooms (Rooms 3a–d). Here we have also restored a roof over the upper northern part of the extension and battlements over the lower part (see Fig. 4). In the west lower part of this extension, two large door jambs are still standing *in situ*, framing a door with a width of 1.10 m (the threshold block is marked with the elevation of 585.95 m above sea-level on Fig. 3). Between the lower room (Room 3c) and the upper room (Room 3a) a door-jamb is also preserved, but the right door-jamb has been removed and this door was closed off with a wall segment at a later date (the threshold block is marked with the elevation of 546 m).

The entire south extension has a somewhat truncated shape, probably because the east wall should connect with the south west corner of the central tower, while the west wall is more in line with the walls of the west extension.

Connected with the south extension, on the east side, there are two square rooms (Rooms 4a–b) separated by a corridor, which also continues along the south side of the central tower (see Fig. 3). The west room (Room 4a) was almost completely washed down the slope, only the upper northern corner was preserved *in situ*. This room measures approximately 5.26 (E–W) × 4.60 (N–S). However, the east room (Room



Fig. 5. View of the interior cross walls in the central Hekatomnid tower.



Fig. 6. Hekatomnid header-and-stretcher masonry of the central tower.



Fig. 7. Double headers at the corners of central tower.

4b) was well-preserved and a 60-cm deep excavation could be conducted here (Figs. 11–12). Room 4b measures 4.70 (E–W) × 4.60 (N–S). There are doors leading into both these rooms from the corridor. The door openings have a width of 1.15 m, with thresholds *in situ* (marked with the elevations of 589.93 and 590.01 above sea-level).

The wall in the extensions is built with smaller blocks than those in the Hekatomnid tower (Fig. 13). The blocks have a finely pointed surface and at the corners there are headers with a drafted margin (Fig. 14), a feature often found in 3rd-century BC masonry.⁶ The bottom blocks at the corners overlap to form a projecting, plaited finishing (Fig. 15), which can also be seen on the tower of Kepez Kule.⁷



Fig. 8. View of the western extension from the central tower in the east.

⁶ Karlsson 1992, 58 and 101–105.

⁷ See Karlsson 2011, 227 and fig. 17; the plaiting can be seen in a probably 3rd-century terrace wall at Bargylia.



Fig. 9. View of the western extension towards the central tower in the east.



Fig. 10. View of the southern extension from the central tower.



Fig. 11. View from the central tower of the east room.



Fig. 12. View of the interior of the east room towards the central tower.



Fig. 13. View of the corridor between the east room (to the left) and the central tower (to the right).



Fig. 14. View of the masonry of the east room. Note the carefully pointed surface and the drafted margin of the upper header.



Fig. 15. Plaited corner blocks in the southeast corner of the east room.



Fig. 16. The floor surface of the east room with broken pottery and traces of ash.



Fig. 17. View from the north of the proteichisma in front of the central tower.

In the centre of Room 4b we discovered a square block formation, measuring *c.* 0.66 × 0.66 m. It was a small oven or furnace for the smelting and heating up of iron. Several pieces of slag and iron were discovered here, as well as many pottery fragments and daub and mud-brick pieces (Fig. 16).

The entire fortress was, at least on its northern and eastern sides, bordered by a terrace wall built of uncut or roughly cut blocks (see Fig. 3). This terrace forms a platform around the central tower (Fig. 17) and must be understood as a *proteichisma*, a fore-wall to protect the main structures, commonly seen in the 3rd century BC.⁸

THE FINDS (FIG. 18)

A total of 106 finds were catalogued during the excavations this year at Tepesar Kale. 86 of these were pottery fragments, 8 roof-tile pieces, 1 bronze and 3 iron pieces, 3 sling-stones, 3 whetstones, 1 piece of slag and 1 daub fragment.

Fig. 18:1–3. In the central Hekatomnid tower several fragments of (probably) non-Attic black-gloss vessels were discovered. Two of these could be restored to diagnostic shapes. Number 1 (TS10-22) is a *bolsal*, the term which Beazley gave this shape,⁹ being a mixture of a skyphos and a shallow bowl (Fig. 19). Comparable examples from the Athenian Agora, Olynthos and Halikarnassos date between 380–350 BC.¹⁰

⁸ See e.g. around the 3rd-century catapult towers at Demetrias in Greece; Stählin *et al.* 1934.

⁹ Many of the cups from the Labraunda excavations are *bolsals*. The name derives from Bol(ogna) and Sal(onica), from where this shape is known, see *Agora* XII:1, 107.

¹⁰ *Agora* XII:1, 275 and *Agora* XII:2, fig. 6 (cat. no. 561); *Olynthus* XIII, 329 and pl. 213 (cat. no. 659); *Olynthus* V, 153 and pl. 123 (cat. no. 273); *Halikarnassos* 7, 216 and pl. 54 (cat. no. L39).

Nos. 2–3 (TS10-23 and TS10-24) are two different cup-kantharoi, dated by comparative examples from the Athenian Agora from the period 340–325 BC.¹¹

Fig. 18:4 (TS10-76). This small vessel is a miniature jug, as it seems to have had only one handle (Fig. 20). It measures only 11 cm in height, with a rim diameter of 4.8 cm. The body has a projecting bulge. It is made from compact, light red clay (2.5YR 5/6) and it is covered with a brick-red slip (10YR 4/8). The profile is very sophisticated and well-executed and it is surprising that I have not been able to find any parallels. It was discovered on the floor of the east room (see Fig. 16, a little to the right of the centre).

Fig. 18:5 (TS10-89). This a flat-footed jug with a vertical strap handle, measuring 11.8 cm in height with a rim diameter of 11.4 cm. It can be dated by similar examples from the Athenian Agora to the 3rd century BC.¹² It was discovered on the floor of the east room.

Fig. 18:6 (TS10-94). This is a Hellenistic one-handle jug with a high neck which is decorated with horizontal ribbing. It has a preserved height of 19.5 cm and a rim diameter of *c.* 8 cm. It was found in the corridor between the east and the west rooms, surrounded by and filled with charcoal fragments which are now being analyzed. The high neck with horizontal ribbing is typical for western Asia Minor, according to Susan Rotroff,¹³ and a very similar jug with horizontal ribbing was discovered this year in Tomb 81 (see Fig. 64). The jug from Tomb 81 preserves a high handle, which Rotroff called “Form 3 with high-swung handle”.¹⁴ It is likely that the Tepesar jug also had such a handle (see Fig. 21).

Fig. 18:7 (TS10-100). This is a wide-mouthed, balloon-shaped amphora, or possibly a hydria with vertical handles, discovered on the floor in the east room. The clay has a strong orange colour (5YR 6/8, reddish yellow). The diameter of the rim opening is 23 cm and the vessel can be restored to a height of *c.* 30 cm (see Fig. 22).

¹¹ *Agora* XII:1, 284f. and *Agora* XII:2, fig. 7 and pl. 28 (cat. no. 684).

¹² Round-mouth jug, Form 4, according to *Agora* XXXIII, 251, fig. 11 and pl. 11 (cat. nos. 60–61), dated 290–220 BC. The shape is also similar to the *chytra* form, see *Agora* XXXIII, 303, pl. 61 and fig. 71 (cat. nos. 557–558); *Agora* XII:1, 372 and *Agora* XII:2, fig. 18 (cat. no. 1932).

¹³ *Agora* XXXIII, 250 (cat. no. 51); see also *Larisa am Hermos* III, 160 and fig. 67a.

¹⁴ *Agora* XXXIII, 250. It is a 3rd-century form; see also *Halikarnassos* 7, 89 and pl. 3 (cat. no. A35).

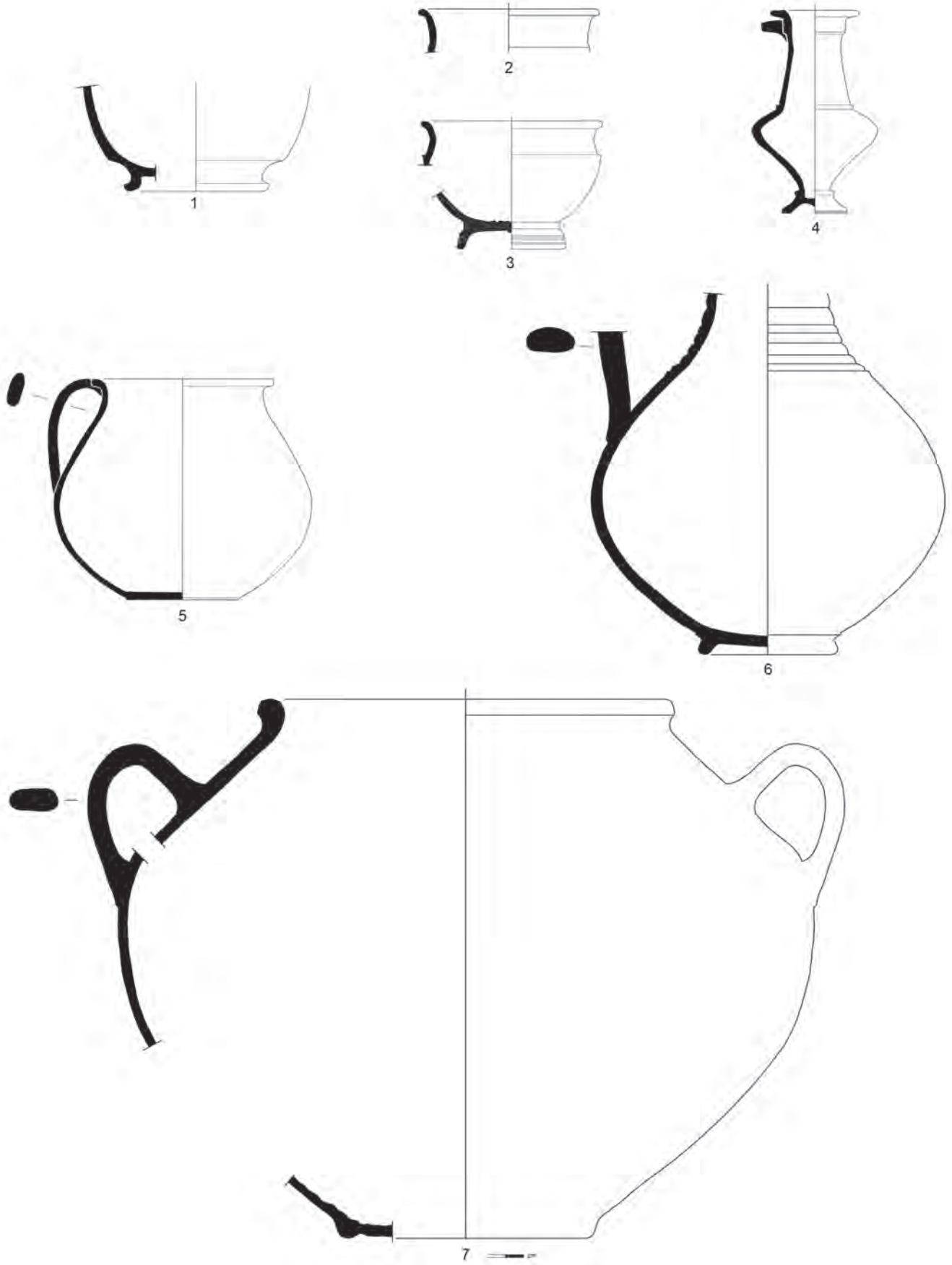

Fig. 18. Pottery: nos. 1–3 from the Hekatomnid central tower; nos. 4–7 from the east room. Scale 1:3. By L. Karlsson.



Fig. 19. Black-gloss bolsal fragments from no. 1 in Fig. 18.



Fig. 21. Hellenistic jug from Tepesar, as no. 6 in Fig. 18.



Fig. 20. Miniature jug, as no. 4 in Fig. 18.



Fig. 22. Jar or hydria from the east room, as no. 7 in Fig. 18.



Fig. 23. Three whetstones from the east room.



Fig. 24. Small fragment of a white-slipped *lagynos* decorated with a lyre (?) on the left.

CONCLUSION

The large central tower is built in a heavy header-and-stretcher masonry seen in the Burgaz and Acropolis fortresses, and it was dated in our excavations by the black-gloss fragments to the middle of or even the second quarter of the 4th century BC. The extensions, built in a later masonry employing smaller blocks treated with a point with plaited corners, are dated by the masonry and the pottery to the third century BC. In the east room (Room 4b) of the southern extension apparently there was a smithy. Slag, iron fragments, a spatula, daub and mud-brick fragments support this idea. Three whetstones were also discovered in this room, all showing clear evidence of having been used (Fig. 23). The latest datable pottery fragment is a small piece of a white-slipped and painted *lagynos* (TS10-64; Fig. 24), dating in the late 3rd century (or possibly the beginning of the 2nd century BC).¹⁵ However, it should be noted that there were no fragments of Megarian relief-moulded bowls. These facts combine to suggest that the complex at Tepesar Kale was abandoned or destroyed around 200 BC.

Excavations in the West Church Complex

(BY J. BLID)

One of the aims of the 2010 campaign was to expand the previous test probes in the so-called West Church Complex, located southwest of the sacred precinct, next to the ancient Sacred Way (Fig. 25). The area was surveyed in 2007 and geophysical investigations, along with minor excavations, were conducted here during the summer of 2009.¹⁶ The only remains of an ancient structure that was still visible, was a tall gneiss column standing in the middle of the plateau (Fig. 26). The geophysical survey could clearly distinguish a connection between the column and an elongated building that once occupied this area. The survey of 2007 had already spotted Late Antique activity at the site by recording a number of marble fragments reused in more recent terrace walls. Thus, this formed a preliminary chronological setting for the nearby ancient remains. Since there were fragments belonging to an *ambo* among the reused marbles, the elongated building was interpreted as a Christian basilica. Last year's test trenches were able to confirm remains of Late Antique pottery and walls just below the topsoil.¹⁷

¹⁵ Similar examples with musical instruments are published in *Sardis* 12, 72f. and pl. 46.

¹⁶ Blid 2010a.

¹⁷ Blid 2010a.

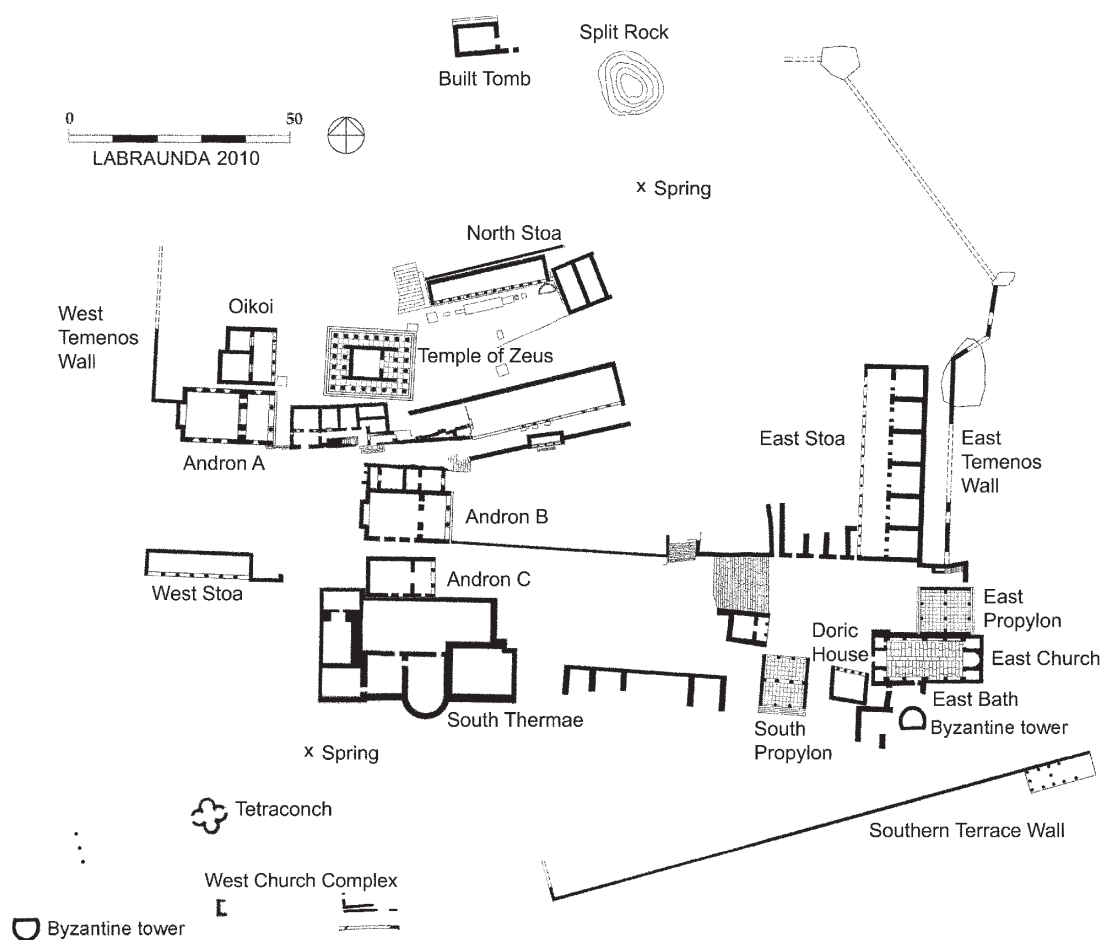

Fig. 25. *Labraunda, site plan 2010. By J. Blid.*

In the summer of 2010, we excavated the site during three weeks and the trench, which is subdivided into thirteen units, occupies a total area of *c.* 160 m² (Figs. 27–29). It soon became obvious that much building activity had taken place here, and not only during Late Antiquity. The trench contains almost a dozen occupation phases of which only a selection will be discussed in this preliminary report. Since the site has been cultivated in modern times the ancient walls are only preserved to a maximum height of 0.5 m. Probably for the same reason, the quantity of pottery and small finds found is surprisingly low. However, thanks to small, preserved deposits of datable finds and organic material at various foundation levels, some construction phases can be dated.

REMAINS OF THE EARLIEST PHASE, CONTEXT 1–2

Most of the trench is occupied by an intricate net of walls, of which several have well-built foundations and some were even cut down into the earlier levels. Certain walls also show traces of secondary repairs. The largest structure, which was first found in the geophysical survey, is the elongated building characterized by a stylobate inside the units I:I–I:IV, and a parallel back wall slightly more than 3 m further north, Units II:I–II:IV. This year's excavation may be able to show that this building is not the result of one single construction phase. The *c.* 7 m long stylobate section inside the units I:I–I:II is the earliest architectural phase recorded in the trench (Context 1), though the eastern section of the stylobate has been reconstructed at a later date. This is evident from the different levels of the stylobate's foundation courses. There are no additional walls that can clearly be associated with the early stylobate phase, but the gneiss column (Fig. 30) and the



Fig. 26 (left). The West Church Complex area before the excavation.

Fig. 27 (below). Plan of the West Church Complex. By J. Blid.

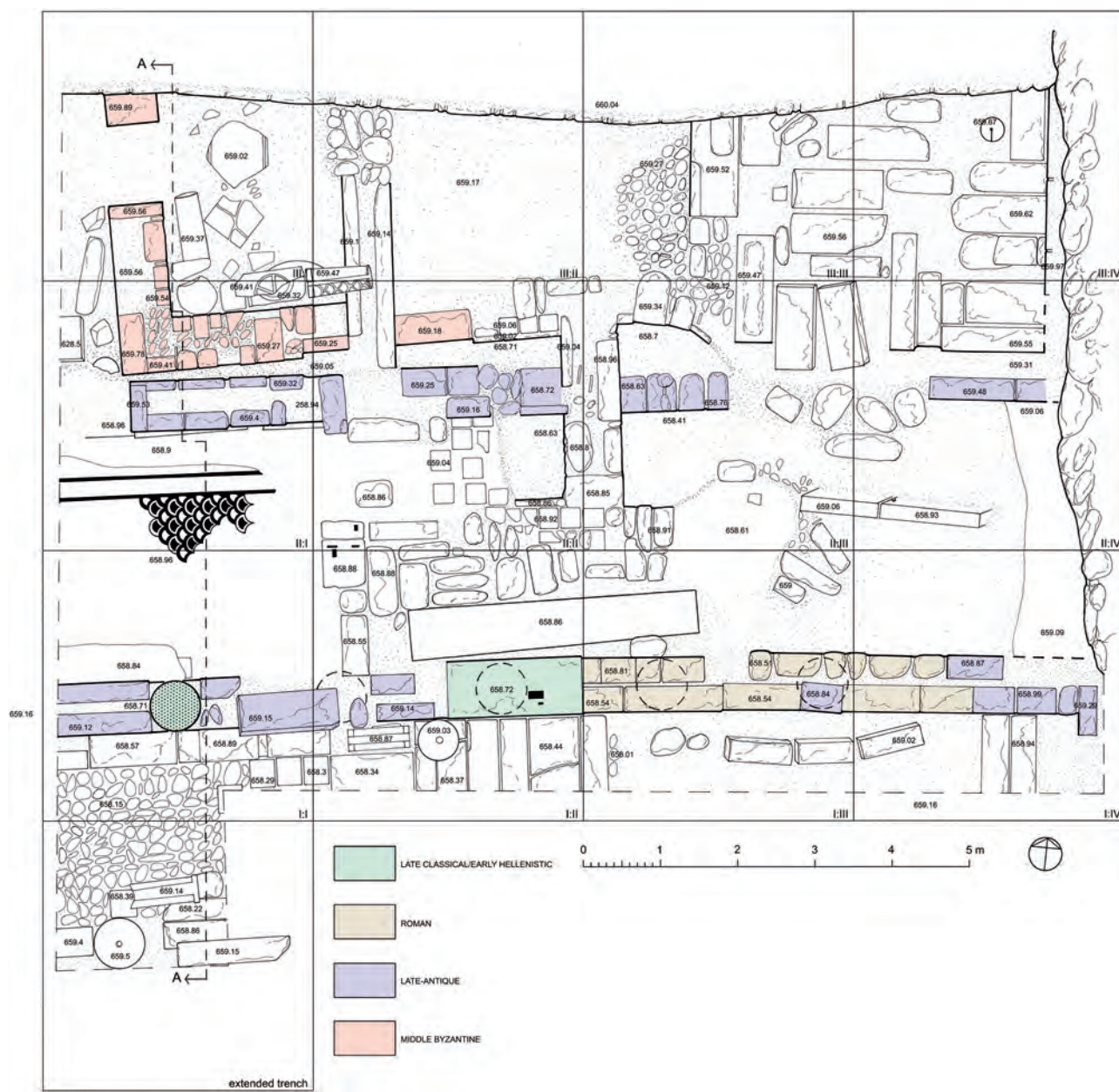



Fig. 28. The West Church Complex, seen from the southeast.



Fig. 29. The West Church Complex, seen from the southwest.

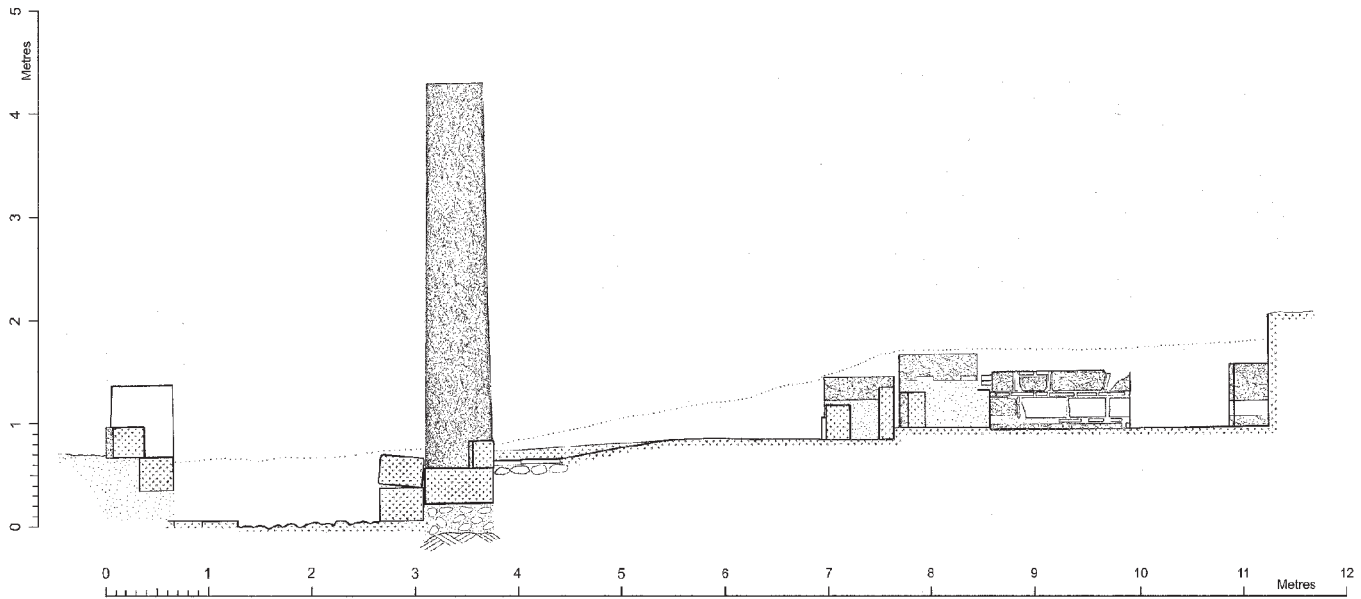

Fig. 30 (above). *The West Church Complex, Section A–A. By J. Blid.*

Fig. 31 (below). *The preserved stylobate in Section I:II.*



stylobate itself, which is also cut from the local stone, resemble stoa-buildings in Labraunda.¹⁸

The only fully visible stylobate block, which is not covered by later additions, can be found in the eastern part of Unit I:II. The block does not have any *empolion* holes or visible circular traces from columns, but it has cuttings for an intercolumnar gate (Fig. 31). The same arrangement has previously been identified by P. Hellström and T. Thieme at the East Stoa.¹⁹ Here, Hellström and Thieme noted a circular column mark immediately flanking one of the sides of the cuttings for the doorposts, which indicated that the gate was intercolumnar. The interaxis of the colonnade of the East Stoa is estimated to be *c.* 2.25 m.²⁰ As mentioned above, there is one column still standing *in situ* at the West Church Complex (Unit I:I). The lower diameter of this column measures 0.61 m. If we consider that the stylobate originally had another column of the same size flanking the western cutting for the door posts, like in the East Stoa, and one additional column in-between the two, we get an interaxis of *c.* 2.1 m with an intercolumniation of *c.* 1.5 m. This would be similar to the only slightly larger dimensions of the East Stoa. An alternative solution would be to have no additional columns, thus

¹⁸ E.g. the West Stoa; *Labraunda* I:2, fig. 55.

¹⁹ Hellström 1991, 157; see also the discussion on intercolumnar barriers in Coulton 1976, 133f.

²⁰ Hellström 1991, 157.

getting a wider intercolumniation of *c.* 3.6 m. However, this large span would not easily correspond to an intercolumnar gate and thus, the short span is the preferable estimation for this intercolumniation.

During the excavation, two different types of gneiss columns were recorded. They differ in size but stylistically they seem contemporaneous, i.e. they can be associated with the earliest stylobate phase (Fig. 32). The larger dimension, 3.7 m in height, is represented by three intact examples found in and around the trench. No corresponding capitals have been registered. Two intact examples of the smaller columns, 2.05 m in height, were found reused in modern terrace walls on top of the trench and another fragment was found above floor level in Unit II:I. Two Doric capitals in white marble, corresponding to the smaller column dimensions, have been found in Units II:I and II:III. The height of the smaller columns, including the capitals, is 2.27 m (5.7 lower diameters). It seems plausible to ascribe similar Doric capitals of corresponding size to the larger columns as well (giving a ratio of 6.6 lower diameters including the capital). Again, this size resembles the column dimensions of both the East and West Stoa. The smaller columns were likely related either directly to the building or to another structure in its close vicinity. Yet, since the columns and the capitals have remained at the site, they must also have been employed in various later building phases.

The preserved stylobate inside Units I:I–I:IV supported columns of the larger type. This colonnade was likely surmounted by a wooden entablature, considering that no architrave blocks have been identified.²¹ The building was originally covered by a wooden roof and this is indicated by a major destruction layer (Context 2), containing a large quantity of terracotta pan-tiles and iron nails (Fig. 33:1–2). The majority of the pan-tiles appear to be chronologically homogeneous but a few different specimens indicate minor secondary replacements. The roof tiles belonging to the earliest phase are similar in shape to those found in 2009 at the Ucalan Kule fortress, in the vicinity of Labraunda.²² Another site, close to Labraunda, where similar roof tiles have been recorded is the Maussolleion at Halikarnassos.²³ The imbrices belong to a pitched-roof type with projecting rolls on both sides of the exterior. The pan-tiles have raised side borders of varying thickness.

The dating of the earliest phase is based on the following find categories: pottery from the foundation level, roof tiles from the upper destruction layer and finally the architecture *per se*. The pottery found in the trench's bottom layer, at various locations, is Late Classical black-gloss ware, possibly of

Attic origin (Fig. 45:1–2). The pan-tiles are difficult to date so precisely, but as mentioned above, similar cover-tiles and imbrices were found at the Ucalan Kule fortress in 2009. L. Karlsson argued that this type is post-Hekatomnid but undoubtedly pre-Roman.²⁴ The similar examples published from the Maussolleion excavations in Bodrum, were found within a filling inside Well C. It is argued that the well had been filled up by the end of the 4th or the beginning of the 3rd century BC.²⁵ The marble capitals belonging to the small-size columns lack *annuli*, which are generally featured on Doric Hekatomnid capitals at Labraunda.²⁶ The proportion of the large gneiss columns and their estimated interaxis can be compared to the Hekatomnid East Stoa in Labraunda.²⁷ The dimensions of the columns also correspond to the West Stoa, which A. Westholm dated to the early Roman period.²⁸ However, the Hekatomnids characteristically used marble columns exclusively and this is not the case at the West Church Complex. Taking into consideration the different evidence, I suggest that we place the first construction of this possible stoa building in the period closely succeeding the Hekatomnids, towards the end of the fourth century. I also believe that the lack of *empolion* cuttings in the preserved stylobate block further indicates a date in the pre-Hellenistic period.²⁹ Additional pottery sherds, found under the destruction layer, show that the earliest building phase remained in use for centuries, most probably until the third or fourth centuries AD (Fig. 45:3–5). As mentioned above, there are traces of secondary repairs to the building. It has not been possible to date the reconstruction of the eastern section with ceramic finds, but a tooth was excavated close to the foundations and it has been dated to Cal. AD 50–230.³⁰

THE LATE ANTIQUE PHASES, CONTEXTS 3–6

The site was not cleared of rubble after the collapse of the roof (Context 2), so the earliest building in the West Church Complex was obviously never restored to its original condition. Instead, the foundations of the next phase, Context 3, rest directly upon the debris. The new occupation resulted in a major reshaping of the entire area. In all parts of the trench there are remains of a concrete platform of small stones fixed in mortar. The stones are placed in narrow bands with clear expansion joints, in the same manner as we have earlier observed in the East Church at Labraunda.³¹ The level of the

²¹ The East Stoa probably also had a wooden entablature, despite its more luxurious use of marble columns; Hellström 2007, 97f.

²² Karlsson 2010.

²³ Cf. *Halikarnassos* 7, pl. 27, cat. nos. G182, G186.

²⁴ Karlsson 2010.

²⁵ Cf. *Halikarnassos* 7, 133.

²⁶ Cf. Hellström 2007, 75 (the Doric building), 120 (the Oikoi).

²⁷ Hellström 1991, 157; Hellström 1994, 44f.

²⁸ *Labraunda* I:2, 100f. and 113.

²⁹ Hellström 1993, 121–131.

³⁰ 1885 ± 32 BP, Ua-40909.

³¹ Blid 2008, 126.

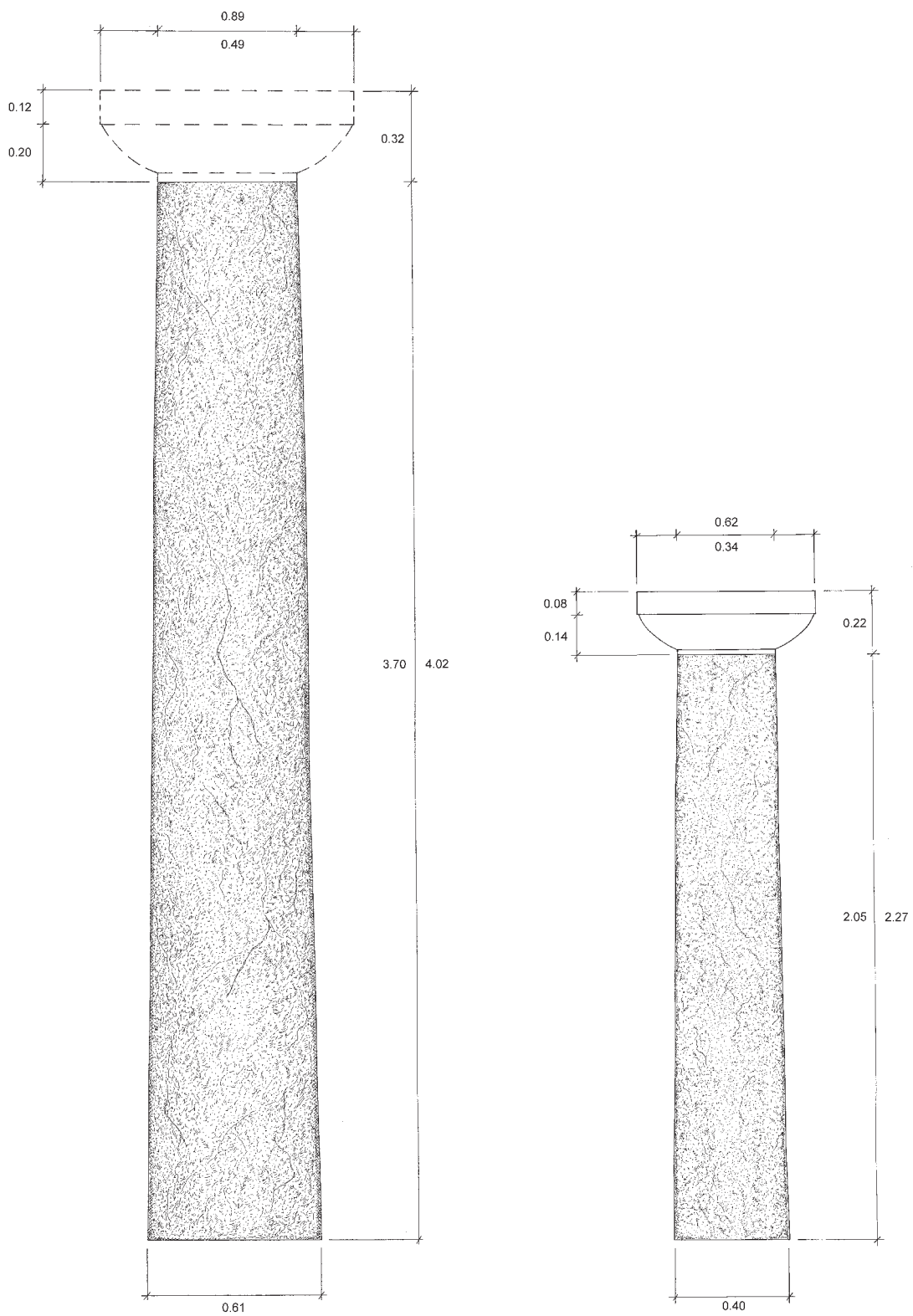

Fig. 32. Columns and capitals associated with Context 1. By J. Blid.

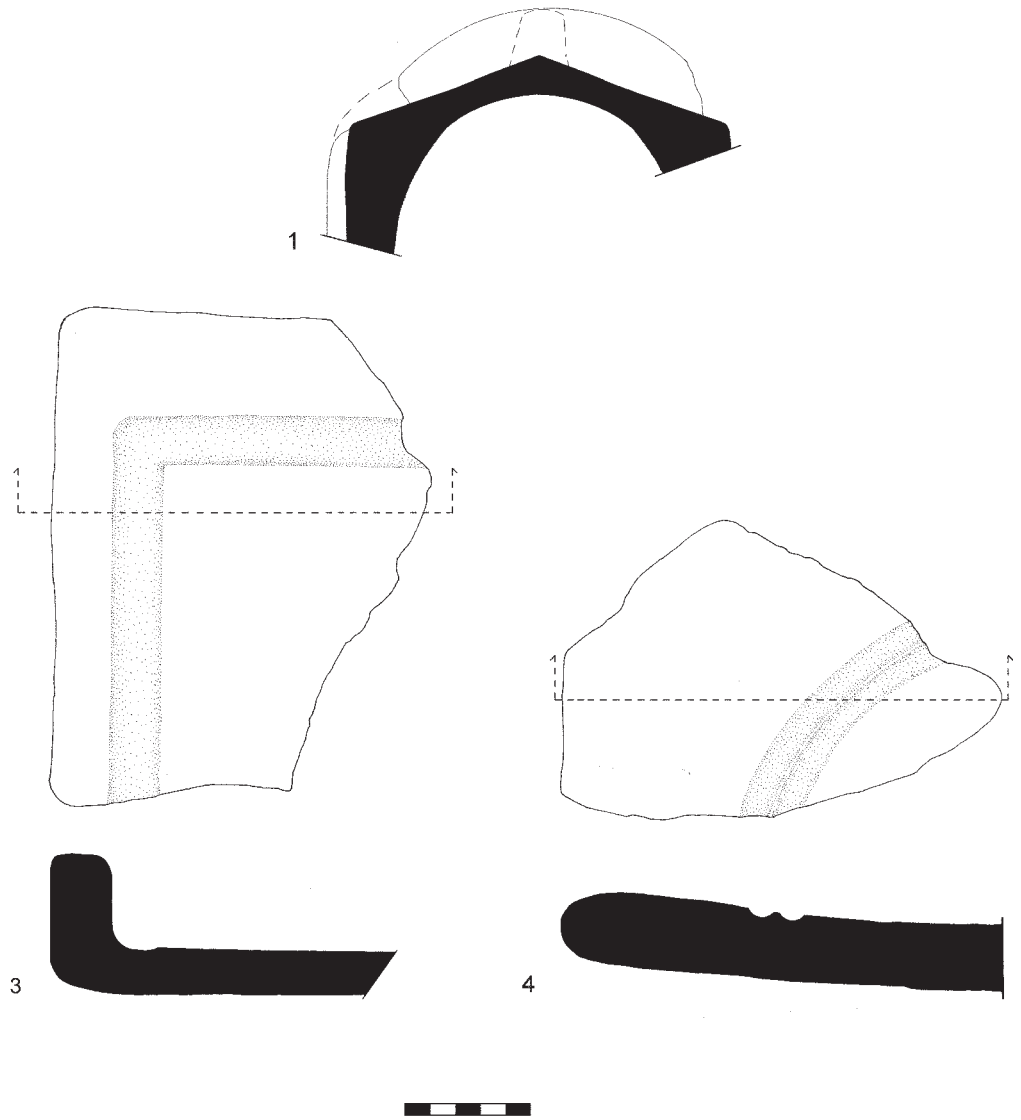

Fig. 33. Different types of pan-tiles and an imbrex found at the West Church Complex. By J. Blid.

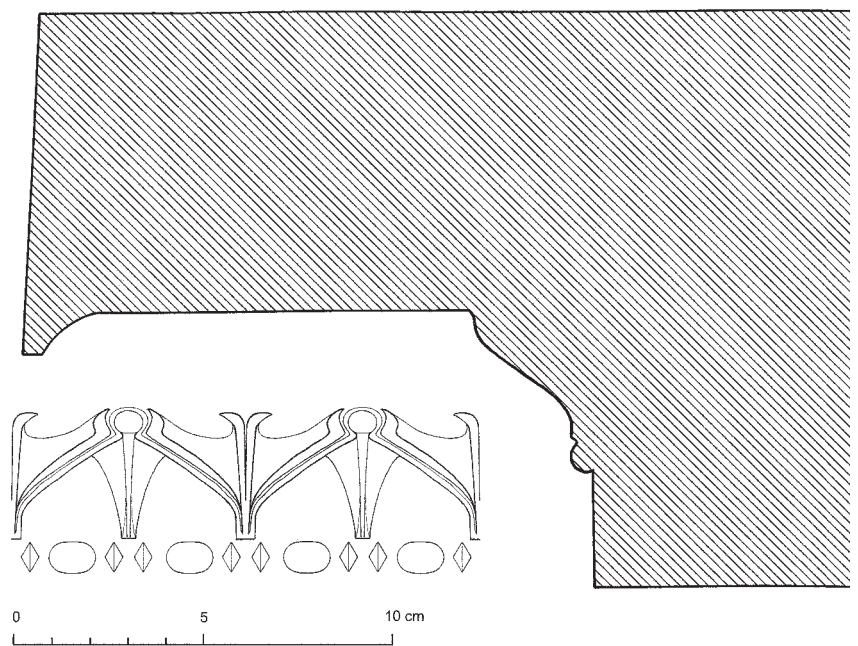

Fig. 34. Ionic geison block from Context 3. By J. Blid.

platform differs by almost a metre between the northern and southern areas of the trench. On top, the concrete foundation is covered by alternating tiles and stone slabs. Many of the slabs are marble blocks which have been reused from other parts of the sanctuary. Two fragments of an Ionic *geison* block were found just between Units I:II and II:II (Fig. 34). They are Hekatomnid in date and the character of the Lesbian *kymation* is very similar to other examples coming from the South Propylon.³² However, small differing features indicate that these blocks belong to an as yet undiscovered Hekatomnid building in Labraunda. One such feature, which is not

present on the *geison* blocks from the Propylaia or the Temple of Zeus, is the backward leaning of the *corona* towards the upper edge of the block. Another feature is the lack of the small projecting moulding at the very top of the *corona*.

It has proven hard to connect the large concrete platform, Context 3, to any other surrounding walls but it is certain that the colonnade remained integrated into this space. Several column fragments in local marble and *Marmor Phrygium*, comparable in size to the large gneiss columns, have been excavated close to the stylobate. It seems, therefore, that the

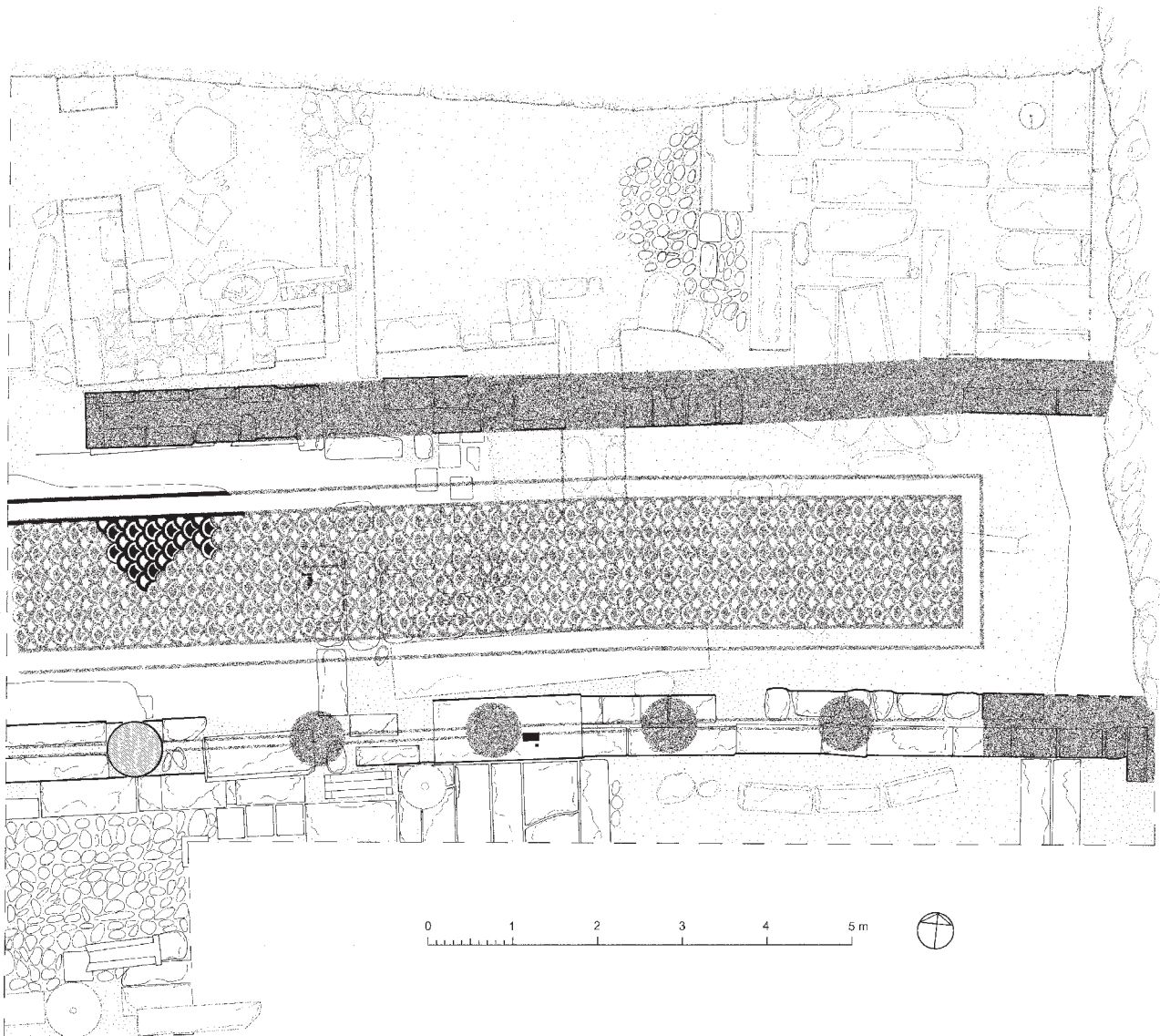

Fig. 35. Proposed reconstruction for Context 4. By J. Blid.

³² Cf. *Labraunda* I:1, pl. VI.



Fig. 36. Church at Karian Kaunos with stone barriers separating the nave from the aisles.

damaged colonnade was probably supplemented with reused columns of various types of stone.

Plenty of small finds can aid us in dating the concrete platform. Pottery and coins were found in different areas of the trench, either located just under the concrete, or between the concrete and the covering stone slabs. Four bronze coins were found in Units I:II, I:IV and II:II. Three of these coins were minted during the reign of the emperor Arcadius (395–408), the fourth is uncertain due to bad preservation but it is possibly a coin struck by the western usurper Eugenius Flavius (392–394). The analogous date of these coins further corresponds chronologically with fragments from a dish of African Red Slip ware (Fig. 45:6), found in the same layer.³³

Not long after the construction of the platform, an east–west oriented wall was built, Context 4, c. 3 m north of the stylobate. The major part of the wall's foundation reaches down below the level of the concrete platform, but in Unit II:II there is a section of the wall resting directly on the platform itself. This wall also contains reused marble blocks, some of which have large dimensions. At the same time as this northern wall was built, the intercolumniation, on top of the stylobate, was filled up by low stone barriers c. 0.4 m high.³⁴ This formed an aisle between the colonnade and the back wall further to the north, and here we now see the first

formation of what we believe is an ecclesiastical space (Fig. 35). The sixth-century church at Karian Kaunos preserves identical stone barriers, separating the nave from the side aisles (see Fig. 36).

Another destruction layer, Context 6, covered the floor level of Context 4. The majority of the finds in this layer are bricks and more than three thousand bricks were excavated. I suggest that the explanation for this huge quantity of bricks lies in a replacement of the wooden entablature in Context 1, with brick arcades in Context 4 (Fig. 37). We also registered some pan-tiles in Context 6 of the so-called Laconian type (Fig. 33:3). In Labraunda, the earliest known examples of such pan-tiles come from a securely dated context in the Tetraconch Bath and have been dated to 535–610 Cal. AD.³⁵

The floor level

The floor of the aisle has partly preserved monochrome and polychrome mosaics. In Units I:I and II:I, the mosaic is composed of a scale-pattern, alternating white, blue and reddish brown stone *tesserae* (Fig. 38). A border consisting of a double band of blue *tesserae* flanks the central motif. Outside the two dark bands is a monochrome white border featuring what seem to be minor, dark, cross-like patterns randomly distributed.³⁶ The outer mosaic borders the colonnade and the northern wall. Due to the mosaic's adoption of these barriers

³³ Cf. Hayes 1972, 116 (Form 67), dated c. 360–470.

³⁴ A similar enclosure, built up between columns, has been recorded in the Large Basilica at Nicopolis ad Istrum (fifth century), in modern Bulgaria; Poulter *et al.* 1995, 161f.

³⁵ Blid 2010a.

³⁶ Cf. Poulsen 2011, 433 and fig. 6.

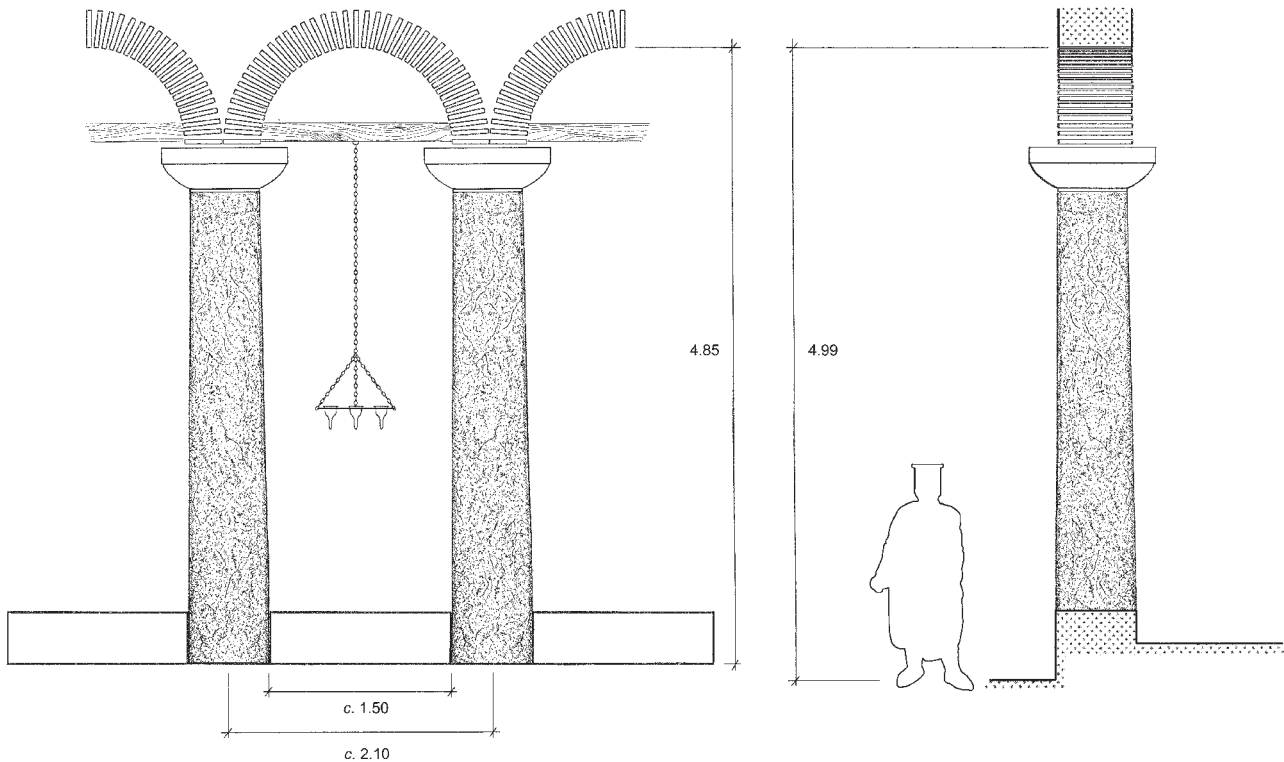

Fig. 37. Restored elevation of the colonnade in Context 4. By J. Blid.

we can assume that the mosaic and the barriers are all contemporaneous, i.e. Context 4. The colour and dimension of the *tesserae*, c. 1.5–2 cm², and the border pattern are identical to other mosaics found in Labraunda, e.g. at the East Bath/Church, the Doric House and Andron B's East Annex.³⁷ The type of scale-pattern seen in the central motif of the mosaic is a Late Antique composition known from all over the Roman Empire.³⁸ Since this pattern occurs over a very large geographical region and over a long period of time, it is crucial to study the known regional examples in order to provide an accurate date. The band border, built up by four blue *tesserae* in each row, is very similar to those found in a Late Roman villa at Halikarnassos,³⁹ in the south and north rooms of the Tetrapylon House at Aphrodisias,⁴⁰ in the so-called Bishop's

House in Torba,⁴¹ on Kos⁴² and in the Basilica of the Acropolis at Iasos.⁴³

From these examples we can observe that the scale-pattern is used both in secular and sacred architecture within the region. The different dating suggestions, of which several are based on reliable find contexts, should place the mosaic somewhere in the fifth century. The small finds from the floor layer of the West Church Complex cannot provide a more precise date. But fifth–sixth century pottery (Phocaeen Red Slip ware, Fig. 45:7) roughly confirms the stylistic date of the mosaic.⁴⁴ Several fragments of glass lamps were also found on top of the mosaics (Fig. 45:9–12) and archaeological investigations in Late Antique churches have shown that glass

³⁷ Blid 2006–2007, 244f.

³⁸ Note U. Serin's thorough research made on this particular motif: Serin 2004, 144–147.

³⁹ Dated to the middle or second half of the fifth century; Poulsen 1997, 12.

⁴⁰ S. Campbell has dated them to the early fifth century based on a stylistic comparison to mosaic floors in Sardis, Lydia, archaeologically dated to shortly after 400; Campbell 1991, 16–19.

⁴¹ This complex was in use between the late fourth and late fifth centuries, where the latter marks the *terminus ante quem* for the mosaics; Özet 2008, 23 and fig. 26.

⁴² Dated to the first half of the fifth century; Brouscari 1997, 65–77.

⁴³ This polychrome mosaic features a scale-pattern with bright red and yellow colours together with the colours represented at Labraunda. It is stylistically dated to the late fifth or first half of sixth century; Serin 2004, 147 and pl. IX.

⁴⁴ Cf. Hayes 1972, 329–338 (Form 3).



Fig. 38. Floor mosaics of Context 4.

lamps were very commonly used.⁴⁵ The majority of the glass lamps found in the West Church Complex belong to a type which was placed in *polykandela* of bronze. However, no such bronze fragments were recorded during the excavation. There is also a handle and base belonging to a bowl-shaped single suspended lamp (Fig. 45:12). Archaeological and textual evidence show that the *polykandela*-lamp type was primarily used in the nave and aisles, which might explain the dominance of this lamp category inside Units I:I and II:I.⁴⁶ The lamps were not the only glass objects found at this level. Fragments of glass window-panes in various colours were excavated in the eastern units, II:III–II:IV, of the aisle (Fig. 39). The deep blue coloured fragment is so far a unique find in Labraunda. However, window-panes in coloured glass have

⁴⁵ Cf. Jabal Harun and Petra: Keller & Lindblom 2008, 330–375; O’Hea 2001, 370–376; Kourion and Alassa, Cyprus: Young 2007, 495–500; Flourentzos 1996, 23; Basilica of St John, Ephesos: *Ephesos* IV, 265; Hagios Polyuktos, Istanbul: *Saraghane* II, 49; Alahan Monastir, Isauria: Gough *et al.* 1985, 53, fig. 10:17; Nicopolis ad Istrum: Poulter *et al.* 1999, 48.

⁴⁶ Keller & Lindblom 2008, 333.

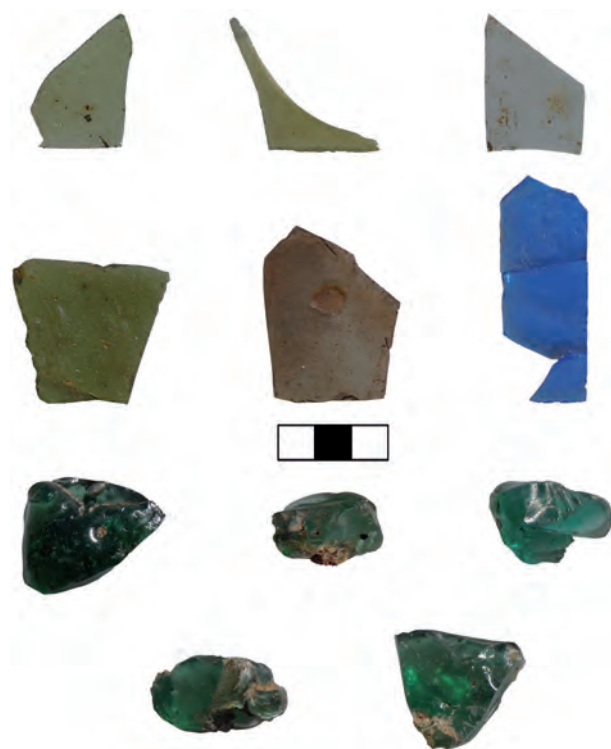

Fig. 39. Window glass and raw glass from Context 4.



Fig. 40. Deposition of architectural marbles.

been recorded in a number of Late Antique churches.⁴⁷ Some of the fragments found in the West Church Complex have preserved straight edges, which indicate rectangular panes,

⁴⁷ See, e.g., Jabal Harun and Petra, Jordan: Keller & Lindblom 2008, 350; O’Hea 2001, 371; Kourion, Cyprus: Young 2007, 509f.; Hagios Polyuktos, Istanbul: Dell’Acqua 2005, 197.

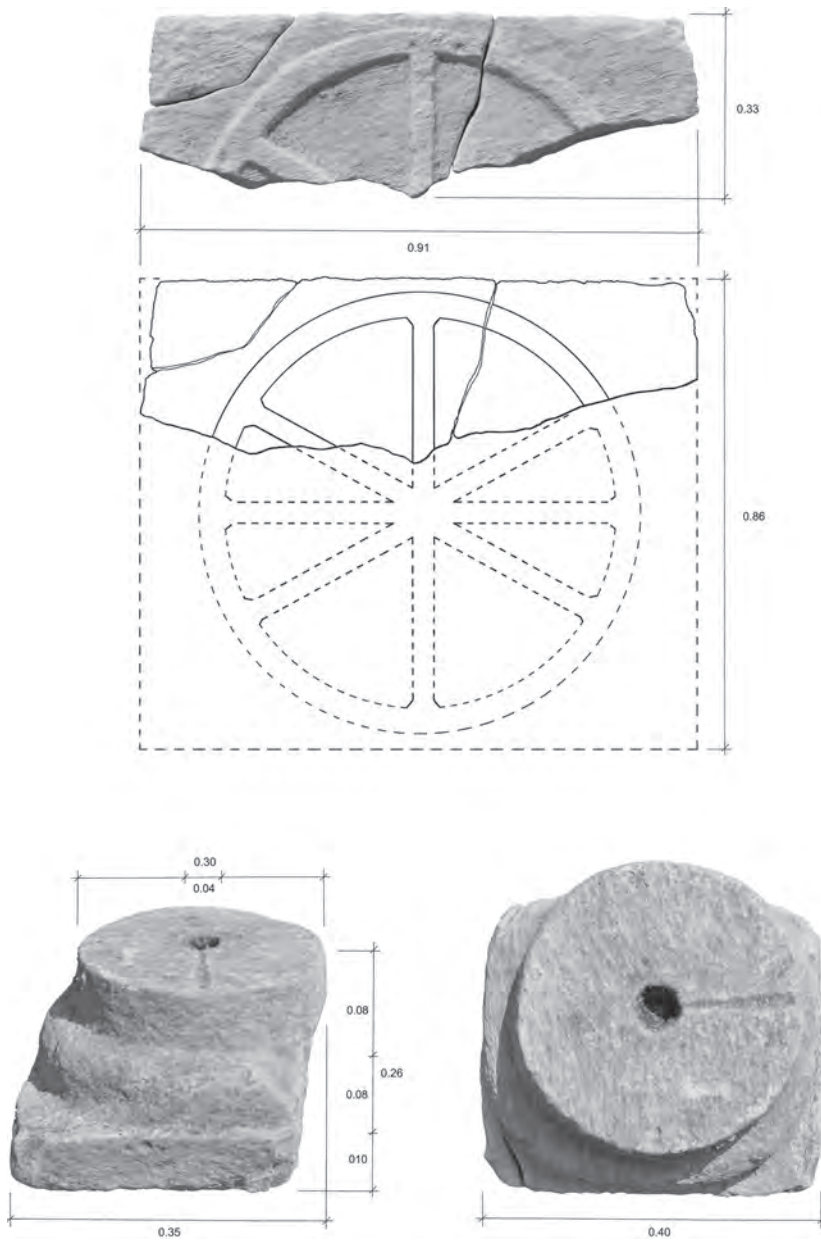

Fig. 41. Closure slab and column base from Context 4.

but no complete examples were retrieved and thus their original size is hard to estimate. Considering the location of these stained window-panes, I suggest that originally they were situated in the clerestory.

Another interesting find category consists of several small chunks of green raw glass (Fig. 39). Previously I have suggested the existence of a local glass workshop at Labraunda during Late Antiquity based on a large deposit of vessel glass found

at the East Church.⁴⁸ Since raw glass from production centres, mainly in North Africa, were distributed as chunks and made into vessel glass at regional ateliers, I consider these fragments to be a clear indication of a workshop in Labraunda.⁴⁹

In the eastern area of the aisle, Unit I:IV & II:IV, we excavated another white mosaic composed of larger *tesserae* with

⁴⁸ Blid 2010b.

⁴⁹ Traces of glass production have also been identified at the Late Antique church inside the ancient sanctuary of Letoon, in the neighbouring region of Lykia; Foss 1994, 13.

uneven sides (Context 5). It lies about 20 cm above the preserved mosaics in Units I:I–II:I, which indicates that this was laid in a later phase. Identical mosaics were also found in a secondary context during excavations inside the East Bath/Church in 2006. We lack small finds to date this secondary mosaic, but based on the finds from the subsequent layer I would suggest a date no earlier than the second half of the sixth century.⁵⁰

It is noteworthy that so many buildings in Labraunda seem to have been paved, or re-paved with mosaic floors, in a similar way at the same time. It probably illustrates the practise of travelling artisans, but it is also a measure of activity at Labraunda in the fifth century. Doubtlessly there was still a demand for lavish interiors coming from a local patron/patrons. When commissioned, the mosaic workshop must have lingered at Labraunda in order to ornate several buildings at the site all in a similar way, and perhaps the stylistic repertoire seen in the mosaics was a recognized manner of these particular artisans. However, should the expense of the mosaics be understood as a private or a collective initiative, and what was the commissioner's intent behind it? I believe that the mosaic program inside the churches at Labraunda illustrates the well-known phenomenon of greater piety and social status through donations. Three hundred years earlier, collaboration between individual citizens at Euromos, c. 14 km northwest of Labraunda, had covered the expense of building the *peripteros* around one of the city's major temples.⁵¹ In donating the key elements of the temple's exterior, the commissioners were likely to have strengthened their social status, which triggered the contribution. In the pagan temples, the façade was meant for public view whereas the interior space was only accessible to a privileged few. In time, the church allowed more public access than the pagan temples, which naturally switched much of the architectural focus from the exterior to the interior. The church space was formed into a pictorial venue, available to a larger audience: either for a parish, pilgrims or a monastic community.

Yet, at Labraunda the mosaic decoration also included the north-eastern annex of Andron B, a space without any obvious cultic connotations. The collective efforts evidenced in Euromos, which contributed to the completion of the Temple of Zeus, were solely focused on one sacred building in which the local gentiles could manifest their wealth. In Labraunda, the contribution of the church mosaics can be understood for the same reasons as donating an exterior of a temple, but why ornate the north-eastern annex of Andron B, which was probably a residential compartment? Could this

dwelling also have been in the hands of the church? I would favour this explanation considering the church's growing influence in the fifth century. If this is correct, it means that in the course of this century the church had started to reoccupy buildings among the ancient ruins inside Labraunda's old sacred precinct, but the sacred space—the churches, remained extramural. Chronologically, this territorial expansion by the church coincides with a phenomenon in Anatolia generally called “temple-conversion”, where the church starts to resettle in and around ancient pagan temples.⁵²

Architectural fragments from Context 4

A number of architectural fragments associated with the fifth-century phase were found in a piled-up marble deposit along the L-shaped wall inside Units II:I & III:I (Fig. 40). Different fragments from closure slabs, an ambo and an intact sculpted column were among the finds. One of the closure slabs partly preserves a Christogram inscribed in a circle (Fig. 41). This was a common iconographical theme during Late Antiquity and, there are other similar examples in the region around Labraunda, for instance at the Temple Cathedral at Aphrodisias, in the Acropolis Basilica at Iasos, in the so-called Byzantine Basilica at Priene and at Kastro Tigani on the island of Samos.⁵³ A Greek cross inscribed in a circle was also found on the underside of the raised ambo platform at Labraunda.⁵⁴

Urs Peschlow has shed new light upon the many different ways of segregating space with closure slabs within the churches of Late Antiquity.⁵⁵ By blocking the passages between the columns, movement between the aisles and the nave was prevented. One of the ways to achieve this was to build up low walls between the columns, and this is the case at Labraunda (see above). Due to this arrangement the segregation between the aisles and nave was complete. Therefore, I think that the closure slab with the Christogram belonged to the *templon* of the basilica instead.

Another architectural fragment which might belong to the *templon*, or perhaps to a small *ciborium*, is a marble column base found reused in a pavement in Unit III:IV (Fig. 41). No column shaft corresponding to the diameter of the base was found. However, comparisons with stylistically similar bases, of the same proportions, and also with preserved column shafts in the Basilica of St John at Ephesos and the Episcopal Church at Kourion on Cyprus suggest a total height

⁵⁰ A sixth-century dish was also found just under this level in one of last year's test probes in present Unit II:III; cf. Blid 2010a.

⁵¹ Bean 1971, 46f.

⁵² See, e.g., Elton *et al.*, 30; Hebert 2000, 35.

⁵³ Hebert 2000, pl. 92; Serin 2004, fig. 111; Westphalen 2000, fig. 11:c; *Samos* XIV, cat. nos. Z103, Z110.

⁵⁴ An octagonal ambo platform found in Karian Keramos has an identical sculptured cross; Falla Castelfranchi 1994, fig. 5:4.

⁵⁵ Peschlow 2006.

of c. 2.3 m, including base and column shaft.⁵⁶ The column base has no cuttings for closure slabs, but as U. Peschlow has demonstrated, the slabs were occasionally cut to fit the base, and not the other way around. The closure slabs found in the West Church Complex do not have any preserved features of this kind, which of course makes it difficult to securely attribute it to a *templon*. At the Basilica of St John in Ephesos, column bases of similar dimensions were used in the *ciborium* surrounding the altar.⁵⁷ Such an arrangement is certainly another plausible situation for the marble base at Labraunda. U. Serin has published an almost identical marble base from the nearby ancient city of Iasos.⁵⁸ It was found in the fifth–sixth century Acropolis Basilica, which helps us to chronologically place the marble base at Labraunda in the fifth-century context presented above.

Further fragments from closure slabs and column bases have been excavated but will not be presented in this preliminary report. However, there is also another more unusual architectural element in the form of a sculpted column, intended for separating the interior space. This column is cut in white marble and it is c. 0.9 m high and decorated with a scale-pattern in relief (*Fig. 42*). There are also cuttings for the fitting of a closure slab on one side. The scale-pattern is rather common on closure slabs and several other examples can be seen in Karia and in southern Ionia.⁵⁹ However, I have not been able to find other examples where this pattern has been carved onto columns. An interesting effect of this particular sculpted pattern is the formation of a harmonious correspondence to the scale-patterns preserved in the floor mosaic in Unit II:I. Here, we can observe what once must have been an aesthetic reflection between the floor decoration and liturgical furniture.

The scale-pattern relief covers just one side of the column and there are cuttings for a closure slab on one side only. This indicates that this particular column was either the initial (or final) element in a barrier of columns and slabs. Cuttings on the column's upper end show that an additional element surmounted it, perhaps a colonnette or a dome-shaped ornament, which often crowned chancel piers.⁶⁰ The configura-

tion and execution of the relief tell us that it was made by means of a template and that it was cut from left to right without consideration for the *entasis* of the column. Towards the upper part where the column is thinner, the semicircular scales, which are placed along a vertical centre axis in the lower section, become slightly displaced towards the right. Even though scale-patterns in relief are very rarely found on columns, other cut patterns occasionally occur. Different examples of columns with cut relief have been recorded from excavations in Istanbul; at Hagia Euphemia and Hagios Polyuktos there are examples where the reliefs have been used for inlaid gems or mosaics.⁶¹ Dressing columns with mosaics was probably an old and established way of decorating lavish interiors, examples of which can be observed in the suburban baths at Pompeii, dateable to the Julio-Claudian period,⁶² at the Villa of the Mosaic Columns and also at Pompeii (the mosaic columns are now exhibited in the National Museum at Naples). However, the grand examples of ecclesiastic architecture inside the Byzantine capital apparently also employed precious stones in these inlaid columns. The tradition of decorating columns with mosaics placed in shallow relief was later transmitted into Romanesque architecture, and in Sicily it can still be seen in the cortile of the twelfth-century cathedral at Monreale. I think it is possible that the sculpted column at Labraunda originally had some sort of inlaid decoration, though nothing of the sort remains.

The last architectural fragments to be discussed in this report are the remains of an ambo, which were discovered during this year's excavation (*Fig. 43*). Already in 2007 four ambo fragments were identified in this area, and this year nine more were recorded. The fragments found in 2007 were two joining parts of a staircase (cat. nos. Z07-1 & 2), an octagonal plinth and the remains of a raised octagonal platform (cat. nos. Z07-3 & 4). The staircases belong to a common regional ambo type,⁶³ which has stylistically been dated to the fifth/sixth century.⁶⁴ It consists of two monolithic staircases in marble adjoined to a raised octagonal platform which is supported by eight columns. The columns often stand directly on top of an octagonal plinth.

⁵⁶ *Ephesos* IV/3, fig. 29; House & Megaw 2007, 184 (cat. no. B14).

⁵⁷ Cf. the reconstruction proposals for this arrangement in *Ephesos* IV/3, Abb. 49; Thiel 2005, Taf. 34.

⁵⁸ Serin 2004, 118f, fig. 103.

⁵⁹ V. Ruggieri has drawn attention to examples in Bargylia, Gökova and Stratonikeia; Ruggieri 2005, figs. II/10, II/65 and II/66. A chancel screen with scale-patterns has also been found in the Byzantine Basilica at Priene; Westphalen 2000, figs. 6 and 11:e.

⁶⁰ Cf. at the Basilica of St John in Ephesos: *Ephesos* IV/3, Abb. 50; Thiel 2005, Taf. XXXIV; the Adyton Basilica in the Temple of Apollo at Didyma: Peschlow 1975, Abb. 4; the Petra Church: Kanellopoulos & Schick 2001, 204f, fig. 14; Basilica II at Sbeitla: Duval & Baratte 1973, fig. 33.

⁶¹ These have been found at the excavations of Hagia Euphemia: Mathews 1971, pls. 49–50; and at Hagios Polyuktos: see *Sarāḫane* I, figs. 138–140.

⁶² Ling 2005, 130.

⁶³ Cf. the examples from Bargylia: Falla Castelfranchi 2005, 429, 432–439; Ruggieri 2005, 325f.; Bodrum: Feld 1975, 199; Ruggieri 2005, 239–241; Iasos: Serin 2004, 69–82; Kaunos: Ruggieri 2005, 133; Kermos: Falla Castelfranchi 1994, 49–52; Kedreai, Milas: Ruggieri 2005, 227–241; Miletos: Feld 1975, 200–202; Myndos: Ruggieri 2005, 238f.; Peçin: Feld 1975, 199, Beilage 1; Ruggieri 237; Sinuri: Devambez & Haspels 1959, 38; Priene: Westfalen 2000, 278f.; Strobilos: Ruggieri 2005, 227–241.

⁶⁴ Falla Castelfranchi 1994, 51; Feld 1975, 202.

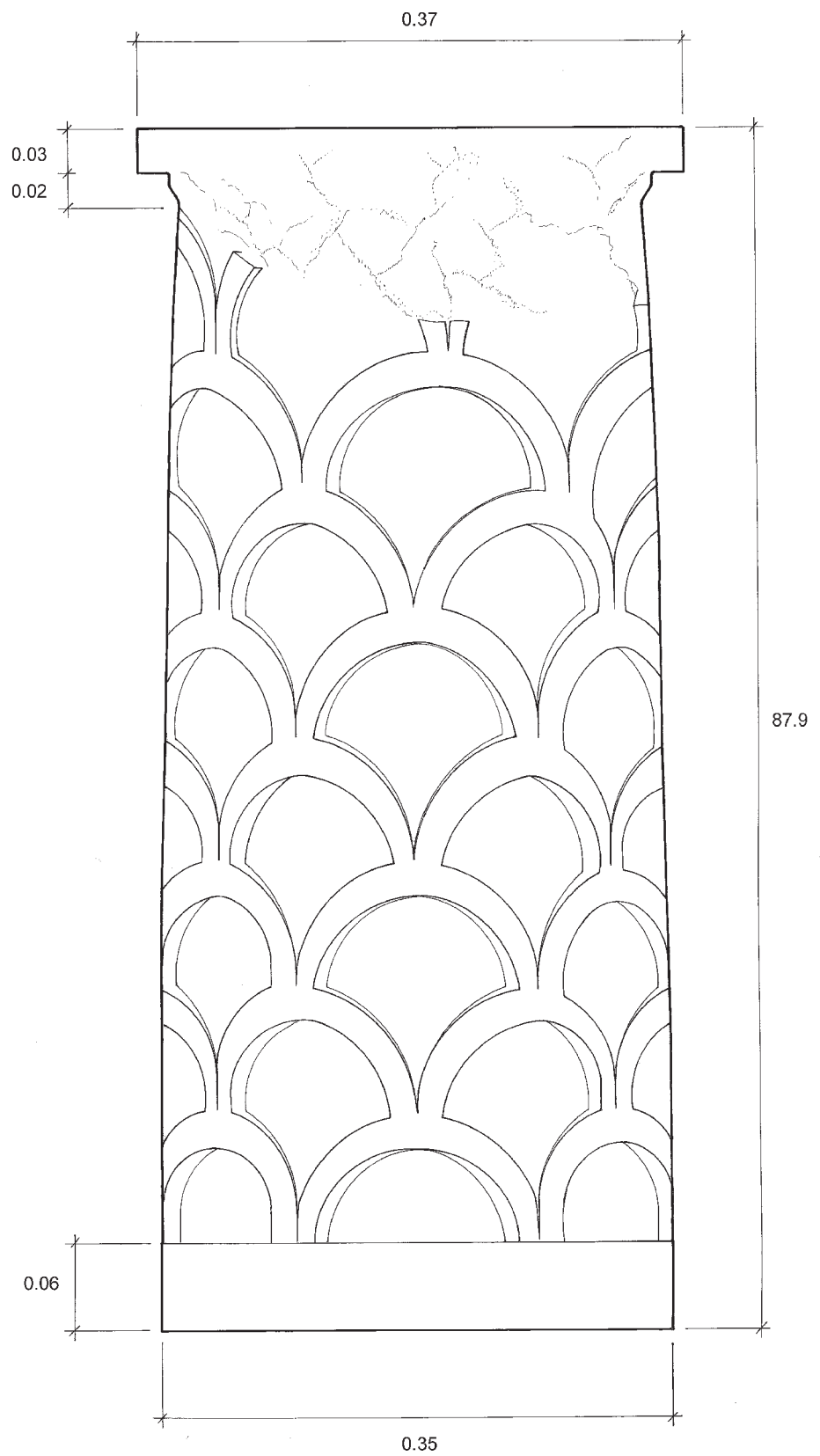

Fig. 42. Sculpted column from Context 4. By J. Blid.

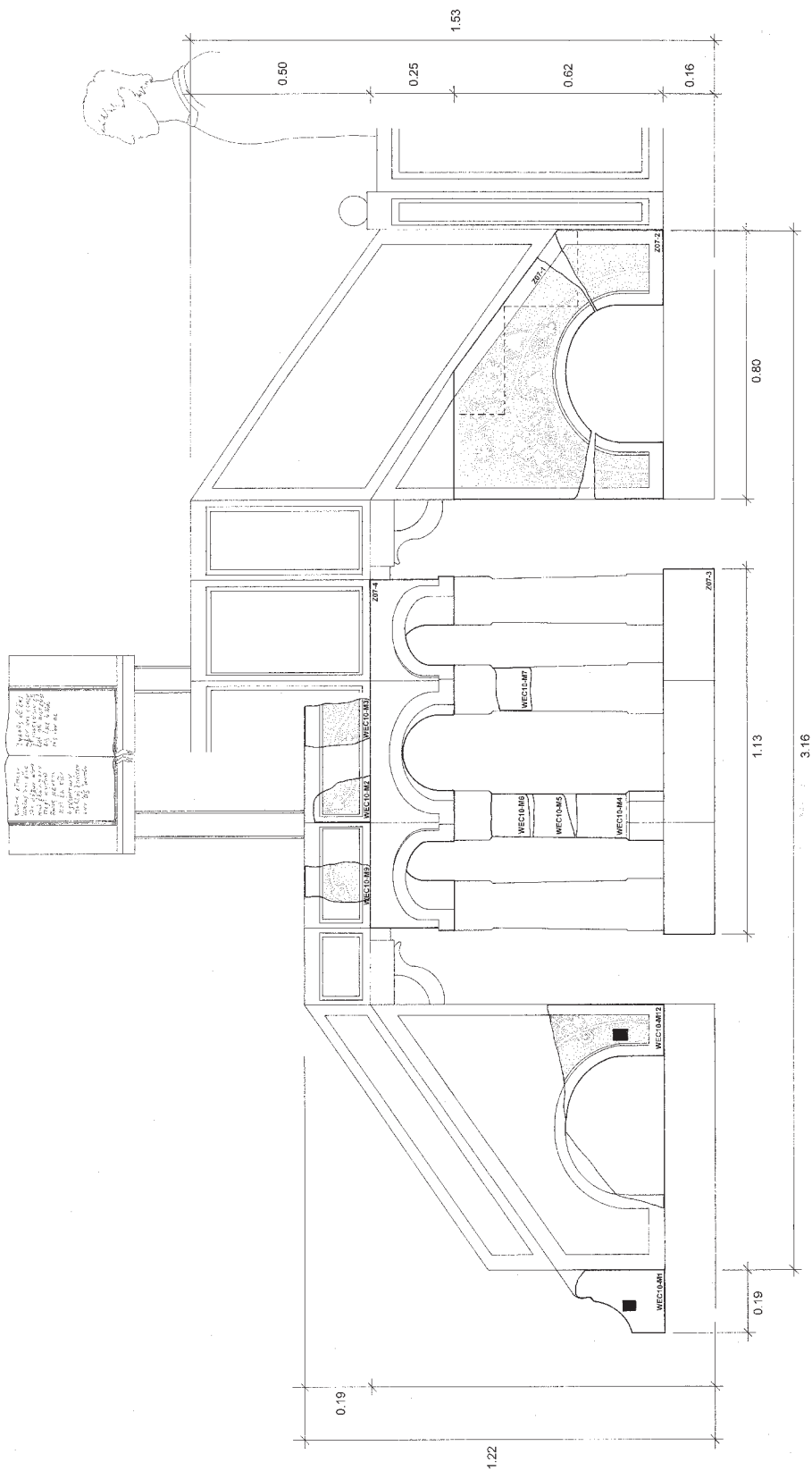

Fig. 43. Proposed reconstruction of the ambo from Context 4. By J. Blid.

The staircase fragments, which were found in 2007, are decorated with a shallow champlévé relief depicting foliated scrolls of ivy and vine. This year a large part of the pendant staircase was found between Units II:I & III:I (cat. no. WEC-10M12). This fragment also has a preserved, weathered relief showing a vine stem with a volute to the left and a bunch of three grapes to the right. As in Labraunda, the relief decorations of these ambos are usually cut directly into the sides of the staircases instead of using thin, decorated trapezoidal stringboards.⁶⁵ Also, the sides of the raised platform tend to be decorated with reliefs. The raised platform at Labraunda is weathered and does not have any sculptural decorations preserved; only a *gesims* following the arcades remains.

Four column fragments (cat. nos. WEC10-M4–7) were found together with the staircase (cat. no. WEC10-M12). This particular type of column, which originally supported the raised platform, is rarely found in excavations.⁶⁶ The column shafts are elliptical in shape and get narrower towards the top, at a slight but constant angle. One column fragment has a preserved pentagonal base, but there are no preserved foundation cuttings for these column bases on the octagonal plinth. However, the configuration of the supports for the columns on the raised platform is equivalently pentagonal in shape. This indicates that the capitals of these small columns had the same shape as their bases. In the region around Labraunda, there are better preserved ambo plinths with pentagonal cuttings for columns, which show that this was a common base form.⁶⁷ The proposed reconstruction of the ambo at Labraunda (Fig. 43) has a height of 1.03 m (excluding the parapet slabs).

The raised platform of the ambo was originally surrounded by parapet slabs, evidenced by a *c.* 0.1 m wide groove along the edge of the upper surface.⁶⁸ The thickness of this groove is similar to the groove on a set of three low slabs (cat. nos. WEC10-M2-3 & 9), which were found in connection with cat. nos. WEC10-M4–7 and WEC10-M12. The slab fragments are decorated with a *rincau*-pattern of vine and ivy. The stylistic composition of the ornamentation is identical to the previously mentioned sculptural decoration found on the sides of the ambo staircases, which suggests that these friezes

also belong to the ambo. Friezes with similar decoration and height have been found in the excavations of the Episcopal Complex at Kourion on Cyprus.⁶⁹ The friezes at Kourion have been dated to *c.* 430,⁷⁰ which again is chronologically analogous to the fifth-century Context 4 in the West Church Complex at Labraunda.

Most Late Antique ambos have been reconstructed with higher parapets than the reconstruction proposed for the Labraunda ambo (comparable with the reconstructed height in the right section of Fig. 43). However, only one attempt has previously been made to reconstruct this particular ambo type. As mentioned above, S. Westphalen has made a hypothetical reconstruction of the ambo in the Byzantine Basilica at Priene where the railing of the raised platform, of which nothing seems to remain, is hypothetically restored to a height of *c.* 0.65 m.⁷¹ This reconstructed height is likely the result of comparisons with other ambos outside the region.⁷² If the slabs WEC10 M2-3 & M9 really belong on top of the raised platform, the railing of the Labraunda ambo was significantly lower, *c.* 0.2 m, and it was used primarily for aesthetic reasons, and not to prevent a person standing on top of the ambo from falling down. Additionally, I believe that another pulpit in marble or wood was placed inside the parapet, in the middle of the raised ambo platform. Nothing of the sort remains at Labraunda but on the well-preserved raised platform from Bargylia,⁷³ now in the Archaeological Museum in Milas, there are two rectangular peg holes in the centre, which might have supported such an additional pulpit. This would offer the stability needed for the user of the ambo, which the low parapet did not.

The parapet slabs were probably adjoined to rhomboid stringboards of analogous height. These stringboards were attached with metal pegs onto the subsequent staircases.⁷⁴ One such peg hole is preserved on the railing of staircase fragment Z07-2. I think that this was the standard arrangement on the local ambo type since the ambo staircases in the Archaeological Museum in Milas and in the Castle Museum at Bodrum⁷⁵ have the very same type of peg holes.

One more marble fragment, possibly belonging to the ambo (cat. no. WEC10-M1), was found together with the other ambo parts. One square peg hole (?) on its side, also found in cat. no. WEC-10-M12, connects this block with the

⁶⁵ Examples of the stringboard type also occur in Karia and southern Ionia; cf. Didyma: Peschlow 1975, Abb. 4; Ephesos: *Ephesos* IV/3, Abb. 50; *Frühchristliches und byzantinisches Ephesos*, Abb. 57, 58, 68, 70; Thiel 2005, Taf. XXXI–XXXIV; Iasos: Serin 2004, 129, 136; Kizilbel: Ruggieri 2005, 235.

⁶⁶ Cf. the Petra Church: Kanellopoulos & Schick 2001, 204f., fig. 35; the church and chapel on the Mountain of Aaron (Petra): Lehtinen 2008, 208.

⁶⁷ Didyma: Peschlow 1975, Abb. 2; Iasos: Serin 2004, fig. 57; Priene: Westphalen 2000, fig. 1; Sinuri: Ruggieri 2005, fig. II/59.

⁶⁸ At Iasos, similar grooves have been registered on a raised ambo platform, measuring 0.08 m in width; Serin 2004, 72.

⁶⁹ Here, they were used as wall decorations in the eastern part of the church; Boyd 2007, 260 and 294, fig. 6.12.

⁷⁰ Boyd 2007, 260 and 294, fig. 6.12.

⁷¹ Westphalen 2000, fig. 1.

⁷² Cf. the ambo parapet found in Vezit Bahçesi in Istanbul in 1984, which measures 0.72 m in height; Flaminio 2010, 75.

⁷³ Serin 2004, fig. 68.

⁷⁴ Cf. Peschlow 1975, cat. no. 65, Taf. 50:5.

⁷⁵ Ruggieri 2005, figs. V/13, V/16, V/33.

ambo installation.⁷⁶ Cat. no. WEC10-M1 looks very like a base moulding and corresponds well in height with the lower part of the staircases. However, this proposed reconstruction is very uncertain since this place would normally be occupied by a pier adjoined to closure slabs along the sides of the *solea* (again, see the right construction proposal in *Fig. 43*).⁷⁷

THE MIDDLE BYZANTINE PHASE, CONTEXT 7

Previous excavations in Labraunda have unearthed remains of Byzantine activity at the site, mainly dating from the eleventh to the early thirteenth century.⁷⁸ The recent work done by the author at the Tetraconch Bath, directly northwest of the West Church Complex, has also uncovered pottery from the eighth century to the first half of the ninth centuries.⁷⁹ Thus, there seems to be some form of continued activity at Labraunda from Antiquity into the Middle Byzantine period. At the West Church Complex there are also a few Medieval remnants. Architecturally, an L-shaped wall, which mainly occupies Units II:I and III:I, is the best preserved example (the so-called Context 7). This wall has a slightly different orientation than the Late Antique church aisle to the south and is situated at a higher level than the latter. There are also differences in the construction techniques of the two: the L-shaped wall is built by recut rectangular marble and gneiss blocks and the joints between the blocks are filled up with



Fig. 44. Middle Byzantine wall inside Units II:I & III:I.

⁷⁶ A similar peg hole is also seen on the ambo at Priene, cf. Westphalen 2000, fig. 3.

⁷⁷ E.g., the ambo of the Adyton Basilica at Didyma: Peschlow 1975, fig. 4; The Beyazit ambo in Istanbul: Flaminio 2010, fig. 64; Basilica A at Philippi: Lemerle 1945, pl. 26; The Church of Helena on Paros: Alipantis 1996, fig. 7; Basilica of St John in Ephesos: *Ephesos* IV/3, Abb. 50; the ambo found in the Marzamemi shipwreck, outside of Sicily: Bass 1972, 136.

⁷⁸ Blid 2011, Karlsson 2009, 66f.; *Labraunda* I:2, 95, 114 and 117; *Labraunda* II:1, 46f.

⁷⁹ Blid 2010a.

bricks, which is typical for the Latmos region (*Fig. 44*).⁸⁰ The most famous examples are the nearby thirteenth-century monastery-buildings around Herakleia at Latmos.⁸¹

The ceramic evidence for Middle Byzantine occupation at the West Church Complex is surprisingly low, compared to the Acropolis Fortress at Labraunda for example. This is likely a result of erosion and modern agriculture, which have removed most of the small finds in the upper layers. Only one base fragment of glazed pottery was found in the excavation (*Fig. 45:8*), however, not in direct relation to the L-shaped wall. This base is weathered but the remains of a dark green glaze can still be seen on the interior. The sherd belongs to a bowl, but since the glaze is so badly deteriorated it is hard to make a certain classification. Solely based on the form of the vessel, I believe it is a regional example of Zeuxippos Ware, Type 1, dateable to the late twelfth–thirteenth century.

Due to the poor preservation of the Middle Byzantine Context 7, with regard to both the architecture and the small finds, it is hard to get a broader picture of the character of this level of occupation. However, Medieval chapels often occur, in connection with Late Antique basilicas, which is e.g. seen in the East Church at Labraunda.⁸² As previously mentioned, the masonry of the L-shaped wall is very similar to the monastic complexes in the Latmos region, just north of Labraunda, which may possibly suggest a Middle Byzantine replacement of the Late Antique basilica within the West Church Complex.

PRELIMINARY SYNOPSIS ON THE WEST CHURCH COMPLEX

Various occupations have continuously succeeded each other in the area of the so-called West Church Complex throughout Labraunda's long history. The foundations were laid here in the Late Classical period when it seems that a stoa was built flanking the Sacred Way, leading from Mylasa to Labraunda. This area, situated in the vicinity of the monumental southern propylon of the sanctuary, was surely a crowded space where stoas of a commercial nature must have been much needed. Ceramic evidence and ¹⁴C-datings from the West Church Complex confirm a continuous use of the stoa up to the third or fourth centuries AD.

Around 400, the then ruined stoa was rebuilt. The colonnade was mended by reusing columns from other buildings in Labraunda and a concrete foundation was constructed on

⁸⁰ See the elevation drawing of this wall to the far right in *Fig. 28*.

⁸¹ Ousterout 1999, 177; Peschlow 74, Abb. 98.

⁸² Blid 2011.

both sides of the stylobate. The function of the building at this time is uncertain but it could very well be an initial church phase, contemporaneous with the East Church at Labraunda. This architectural development, where an extant portico was rebuilt into a Christian basilica, has been recorded at various sites around the Mediterranean.⁸³ Somewhat later in the fifth century, the building was turned into what seems to be a traditional three-aisled basilica. The northern aisle remains, but much of what lies to the south was destroyed when the modern road to Labraunda was constructed here in 1960. The architectural disposition of the basilica can partly be reconstructed from the excavated finds. The colonnades between aisles and nave carried brick arcades and a clerestory with both stained and translucent windowpanes, illuminating the interior space. Additionally, glass lamps were used to lighten up the church. As in many other Late Antique churches, the northern aisle had a higher floor level and was decorated with mosaics.⁸⁴ To further accentuate the segregation between the aisles and nave, low barriers were built up between the columns. This arrangement finds close parallels within the region.⁸⁵ The fifth-century basilica was equipped with liturgical furniture made in the regional manner. A *templon* with marble closure slabs divided the sanctuary from the nave and several fragments of an ambo have also been found. I believe that the established chronology of Context 4 has provided a more reliable dating for this regional ambo type, originating in pre-Justinianic times.

Remnants of glass manufacture in connection with the church have also been found. Perhaps a local glass atelier was needed in Labraunda to provide the churches with lamps and vessels for liturgical use.

Excavations in the Tetraconch Bath, northwest of the West Church Complex, have shown sporadic occupation in the area during the “Dark Ages”. We have now also been able to establish twelfth–thirteenth century activity in the West Church Complex. Walls of the characteristic Latmos type signal renewed Byzantine interest in this area, possibly in the form of a small church or chapel replacing the Late Antique basilica.

⁸³ See, e.g., the Asklepieion in Athens: Travlos 1971, figs. 171 and 172; the Gymnasium Church at Assos: Arslan & Böhlendorf-Arslan 2010, 142f.; the Early Christian basilica inside a Roman villa complex at Kastoro Tigani on Samos: *Samos* XIV, Taf. 1.

⁸⁴ Cf. other churches where the aisles have been given different floor levels: the Western Church at Assos: Arslan & Böhlendorf-Arslan 2010, 144f.; S. Apollinare in Classe near Ravenna, the Lechaion Church near Corinth and in the church at Brauron in Attica: Peschlow 2006, 66; the Basilica at Alahan Monastir: Gough *et al.* 1985, fig. 42.

⁸⁵ E.g., at Priene and Aphrodisias; Peschlow 2006, 69.

LIST OF POTTERY AND GLASS (FIG. 45)

Bowls, Black-gloss ware

Fig. 45:1. Rim to base (WEC10-I:IV5).

Findspot: Unit I:IV, Context 1.

Fabric: 7.5YR 6/4, light brown.

Description: Ø c. 8 cm, H. 2 cm.

Date: Late Classical/Early Hellenistic.

Parallels: *Ephesos* XIII/1:1, cat. no. 279.

Fig. 45:2. Base and wall (WEC10-II:III19).

Findspot: Unit II:III, Context 1.

Fabric: 7.5YR 6/4, light brown.

Description: Ø base 6 cm, H. 1.8 cm. Rouletted on the interior.

Date: Late Classical.

Parallels: *Halikarnassos* 7, cat. no. J8, 185, pl. 38;

Labraunda II:I, cat. no. 42, pl. 33.

Bowl, Megarian type

Fig. 45:3. Rim to body (WEC10-II:III12).

Findspot: Unit II:III, Context 1.

Fabric: 5YR 6/8, reddish yellow; slip: 2.5YR 4/8, red.

Description: Ø 15 cm, H. 2.5 cm, two preserved flowers in relief on wall.

Date: Hellenistic.

Parallel: *Labraunda* II:1, pl. 9:100.

Bowls, regional (?) Terra Sigillata

Fig. 45:4. Rim to body (WEC10-I:II15).

Findspot: Unit I:II, Context 1.

Fabric: 5YR 7/6, reddish yellow; slip: 10R 4/8, red.

Description: Ø 17 cm, H. 2.6 cm.

Date: first–second centuries.

Fig. 45:5. Rim to body (WEC10-I:III11).

Findspot: Unit I:III, Context 1.

Fabric: 10R 6/1, reddish grey; slip: 10R 4/3, weak red.

Description: Ø 14 cm, H. 2.2 cm.

Date: first–second centuries.

Parallels: *Agora* XXXII, cat. no. 1619 (Knidian ware);

Labraunda II:1, 38f (Brittle ware); *Samos* XIV, 162.

Dish, African Red Slip ware

Fig. 45:6. Rim, wall and base (WEC10-II:III7-8).

Findspot: Unit II:III, Context 3.

Fabric: clay 10R 6/8, light red; slip: 10R 6/8, light red.

Description: Ø c. 34 cm.

Date: late fourth–mid-fifth century.

Parallel: Hayes 1972, 116 (Form 67).

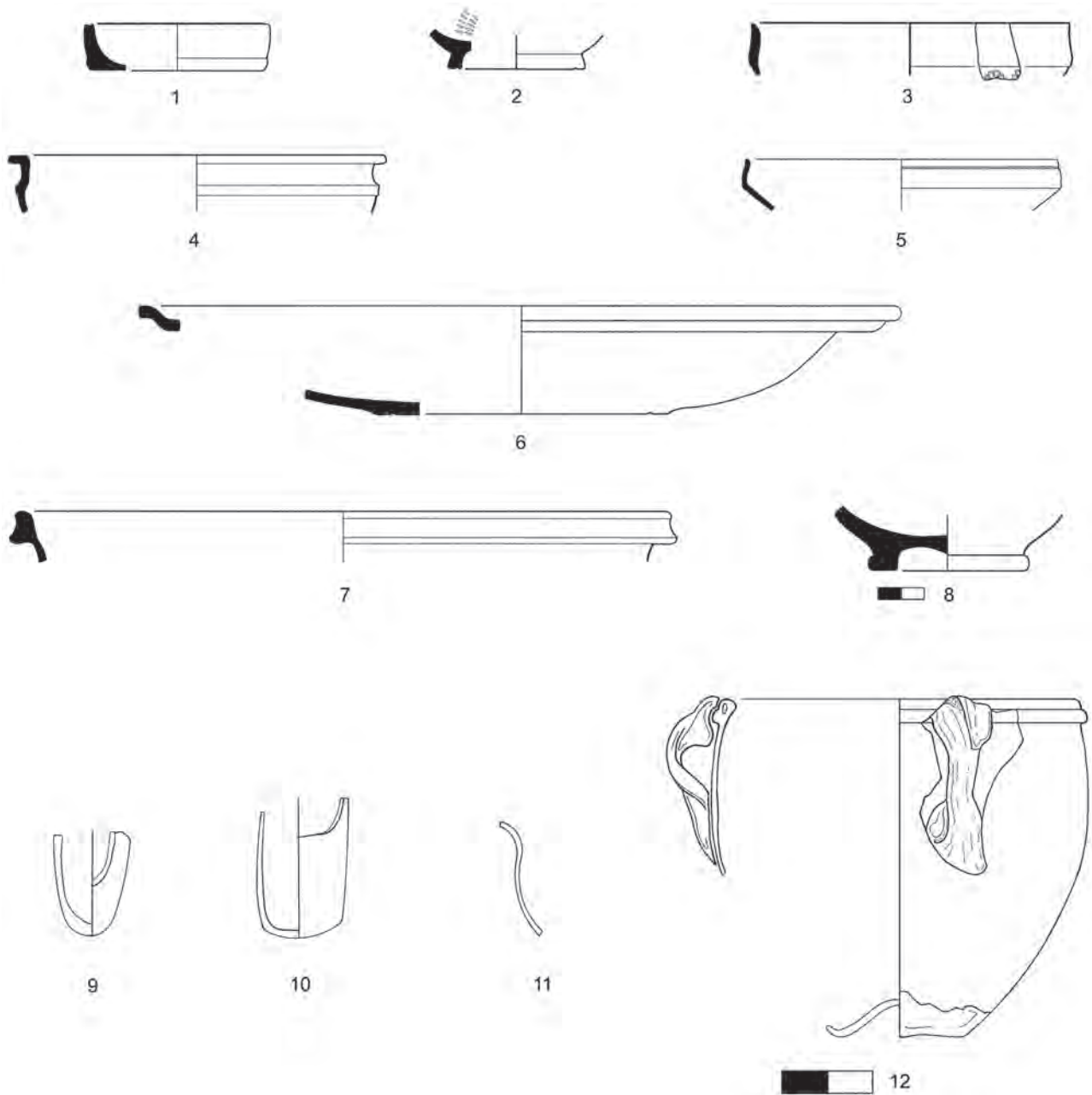

Fig. 45. Pottery and glass from the West Church Complex. By J. Blid.

Dish, Phocaean Red Slip ware

Fig. 45:7. Rim (WEC10-II:I13).

Findspot: Unit II:I, Context 4.

Fabric: 10R 6/8, light red; slip: 10YR 4/8, red.

Description: Ø 29 cm, H. 2.3 cm.

Date: fifth–sixth century.

Parallel: Hayes 1972, 329–338 (Form 3).

**Bowl, Byzantine glazed pottery
(possibly Zeuxippos Ware, Type I)**

Fig. 45:8. Wall to base (WEC10-I:IV3).

Findspot: Unit I:IV, Context 7.

Fabric: 2.5YR 5/6, red; glaze: traces of green glaze on interior.

Description: Ø 7 cm (of base), H. 0.4 cm.

Date: late twelfth–thirteenth century.

Parallel: Doğer 2007, pl. XIV.

Stemmed lamps, polykandela-type*Fig. 45:9.* Stem (WEC10-II:IG4).

Findspot: Unit II:I, Context 4.

Description: Ø 1.6 cm (of stem), H. 2.2 cm; greenish blue glass with a few bubbles.

Parallels: cf. Young 2007, fig. 16.5; Flourentzos 1996, pl. XXXIX.

Fig. 45:10. Stem (WEC10-I:IG2).

Findspot: Unit I:I, Context 4.

Description: Ø 1.9 cm (of stem), H. 3.1 cm; olive green glass with some bubbles.

Parallels: cf. Young 2007, fig. 16.5; Flourentzos 1996, pl. XXXIX.

Fig. 45:11. Wall fragment (WEC10-I:IG1).

Findspot: Unit I:I, Context 4.

Description: H. 2.6 cm; translucent glass with some bubbles.

Parallel: Young 2007, fig. 16.5:59.

Bowl-shaped lamp, suspended type*Fig. 45:12.* Rim to wall, handle and base (WEC10-I:IG3).

Findspot: Unit I:II, Context 4.

Description: Ø 8 cm, Ø 2.8 cm (of base), H. 7.5 cm (restored); greenish blue glass with few bubbles, fire-rounded rim.

Date: fifth–sixth century.

Parallel: Young 2007, 496 (cat. no. 46).

**The necropolis excavation
(BY O. HENRY)**

The 2010 campaign in the necropolis lasted four weeks and during these weeks, we resumed the cleaning and documentation work on the already known, plundered tombs from previous campaigns. We pursued the survey on the western part of the necropolis and opened two trenches in the south-western part of the necropolis. This year a total of 29 tombs were investigated (*Fig. 46*), including 18 newly discovered tombs, 11 of which were unlooted.⁸⁶ After the 2010 campaign the total number of tombs discovered around the sanctuary of Labraunda has reached 104.

⁸⁶ Already known tombs that were cleaned in 2010 are: T17, T18, T19, T20, T21, T22, T23, T54, T55, T56 and T58. Newly discovered but plundered tombs are: T79, T80, T84, T86, T89, T95, T96. Newly discovered tombs, unlooted, are: T81, T82, T83, T85, T87, T88, T90, T91, T92, T93, T94.

THE ROCK-CUT SARCOPHAGI

The 10 rock-cut sarcophagi that were explored are all situated in the western area of the necropolis.⁸⁷ Although all of them have been conceived after the same principle (a deep rectangular, two-storeyed pit, cut on the top of a boulder and covered by a monolithic, pitched lid⁸⁸), one can notice important variations in the geography, topography and the architectural features of these tombs.

Tomb 23 in particular shows dramatic features. Located about 300 m west of the sanctuary and 50 m north of the ancient Sacred Way, it is situated at one of the highest points of the surrounding landscape (*Fig. 47*). It dominates the terrain and its lid can be seen from a distance of several hundred metres. The lid, measuring 2.70 m in length and 1.60 m in width, with a maximum height of 57 cm, is one of the largest ever seen in the necropolis of Labraunda. Its weight can be estimated at around 4.44 tons.⁸⁹ It is so big that, instead of the usual six lifting bosses found on most of the lids of the rock-cut sarcophagi (two on each of the long sides and one on each short side),⁹⁰ it carries a total of eight bosses, two on each of its sides (*Fig. 48*). Besides the imposing size of the lid, the increased number of bosses can also be explained by the particularly high and narrow space in which the tomb was arranged. The presence of a second, partly unfinished and broken lid, found in a reverse position in the immediate vicinity of the tomb (*Fig. 49*), seems to indicate the difficulties of providing the tomb with a cover. This second lid has the exact same length and height as the first one, but with a slightly reduced width (1.5 m). It can be assumed that this lid also belongs to T23. Both its reverse position and the large crack seem to indicate that this lid fell while being carried into position and was replaced by the other one, which was provided with larger and more numerous lifting bosses.

The case of Tomb 17 (*Fig. 50*), also investigated during the 2010 campaign, offers another way of handling the transportation of huge lids. The lid of this tomb measures c. 2.8 m in length, over 1.3 m in width and it is particularly high (0.78 m) giving it a weight estimated at over 5.2 tons. In this case, it seems that the lid came directly from the rock that was cut down from the topside of the boulder in order to shape the platform in which the pit was cut. Although this platform seems to be situated on a high elevation, seen from the southern side, its northern side clearly shows that it was in fact cut down over more than 60 cm from the top of the boulder (*Fig. 51*). Moreover, the northern part of the platform offers, parallel to the pit, a large empty space the use of which can hardly

⁸⁷ T17, T18, T19, T20, T21, T22, T23, T54, T58, T84, T88.

⁸⁸ Lids of T19, T22, T54, T58, T84 and T88 have disappeared.

⁸⁹ Calculation of the weight is based on a density of the gneiss of 2.75.

⁹⁰ Karlsson 2008, 119 and Henry & Ingvarsson-Sundström 2011.

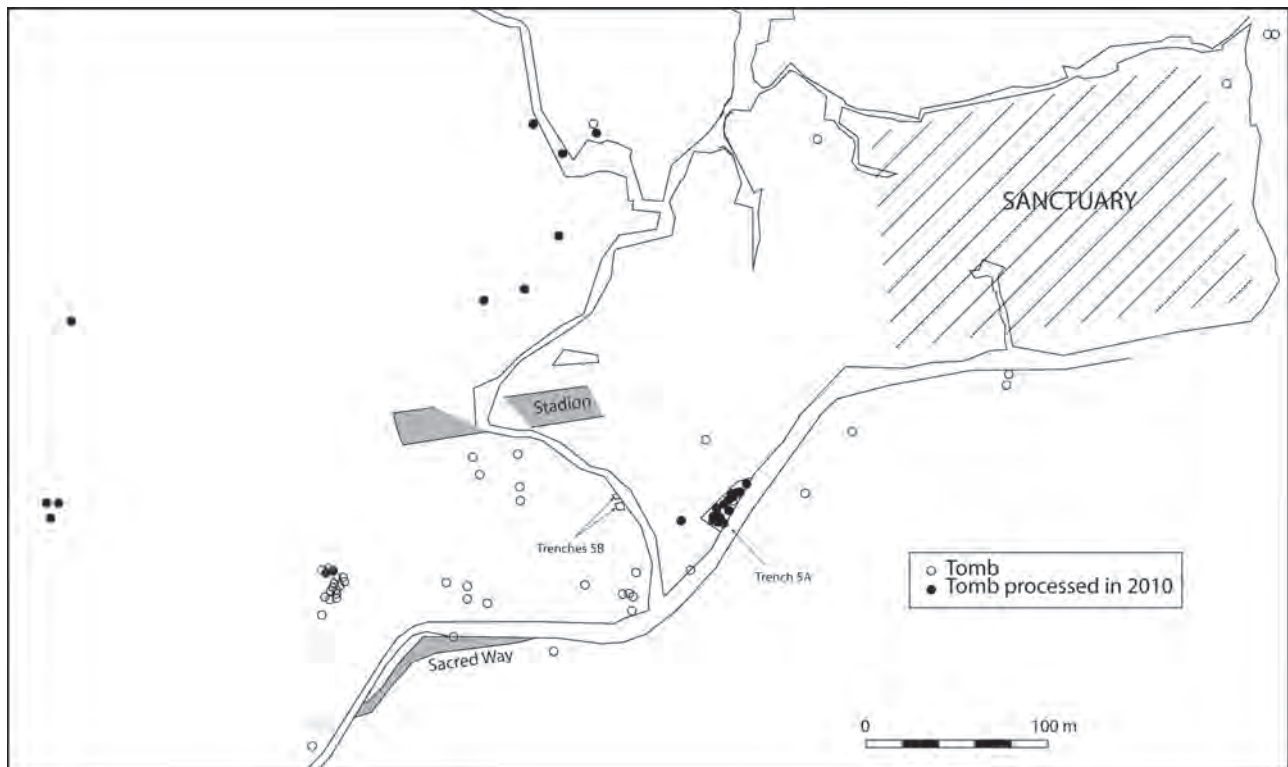

Fig. 46. Map of the tombs investigated in 2010. By O. Henry.

be explained. However, this open space shows several regular cutting marks, orthogonally arranged, which might correspond to the extraction of a large monolithic block, most probably the lid itself. If accepted, such an interpretation reveals a thoughtful process for the preparation of the tomb: two different teams might have been able to work simultaneously. Thus, one team could carve the pit while the second would be cutting the lid and once the lid was completed the workers would only have to move it laterally for a very short distance. Such a process might also explain the differences noticed between the size and shape of the bosses on the lid's long and short sides: slightly protruding but extended on the long sides (for lifting), while very thick and projecting at length on the short sides (for pulling) (Fig. 52).

Although the location, size and weight of the lids of the rock-cut sarcophagi were a source of complication for people arranging the tombs, the reasons why they continued producing such huge pieces for closing the pits can be understood in two, complementary ways. While the location and size of the lids provided ostentation (increased in some cases by the presence of a shelf for carrying vessels on the top of the lids, as in T17, or a stele fixed into a mortise, as in T23), the resulting weight of the stone provided security since apparently it could not be moved easily. Nonetheless, an experience gained from our on-site work showed that a fairly modest workforce



Fig. 47. General view of Tomb 23.

provided with strong levers was enough to push the lid aside and enter the pit. Some of the planners of the tombs seem to have been aware of this and responded to this threat by providing the lid with other features which help to secure its position. Tomb 18 gives a good example of such features.

Tomb 18 is located on top of a high and narrow boulder (Fig. 53). The imposing size and weight of the lid necessitated the addition of a third lifting boss on each of the long

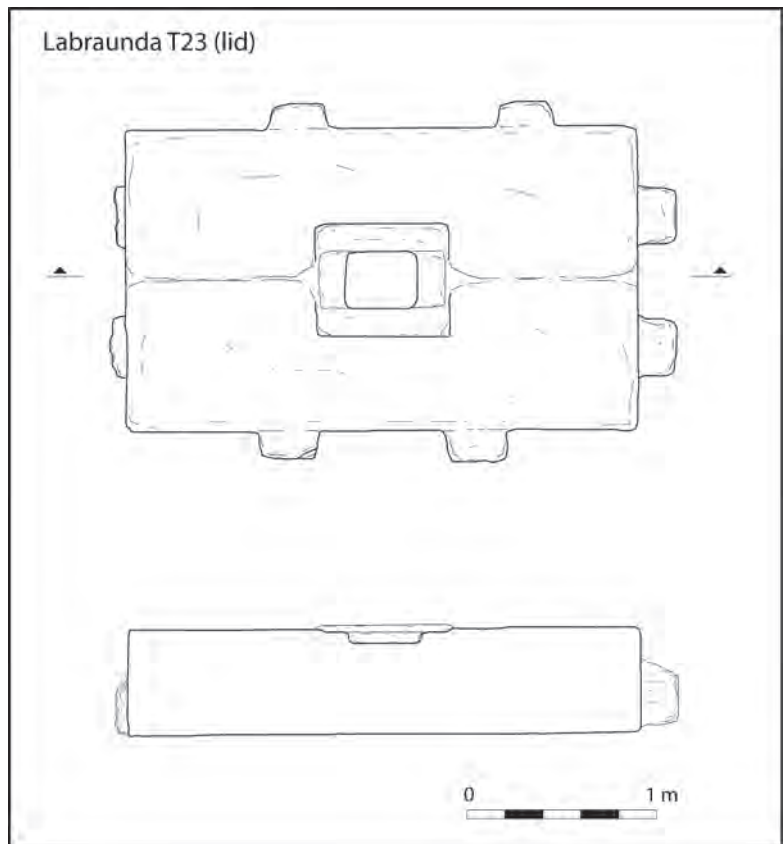

Fig. 48. The lid of Tomb 23. By O. Henry.



Fig. 49. The unfinished lid near Tomb 23.



Fig. 50. Tomb 17, seen from the south.



Fig. 51. Tomb 17, seen from the east.

sides, which is a very unusual feature.⁹¹ The stone-cutters of the tomb also carved a deep continuous groove on the four sides of the lower face of the lid (Fig. 54), while the upper edges of the pit were provided with a surrounding projecting band. When put into position, the grooves in the lid would cover the projecting band of the pit and therefore prevent any attempt to slide away the covering stone. The only possible ways to move the lid out of position were then to either lift it by means of heavy machinery or break the contact between the lid and the pit on one of the long sides (as has been recently done by tomb robbers). Neither operation could be completed unnoticed when the necropolis was still in use.

Due to the constant depredation of these ostentatious tombs, their cleaning revealed very few fragments of associated grave goods. Nonetheless, the almost systematic presence of pottery sherds from different periods, coming from the same pit, confirmed the reuse of the tombs over a wide chronological period. The earliest pottery that could be retrieved seem to be fragments of a black-gloss *bolsal*, in T84, probably from the early Hellenistic period (Fig. 55: T84.3), while the latest pieces are fragments of cooking pots from the Roman period (Fig. 56: T22.1).

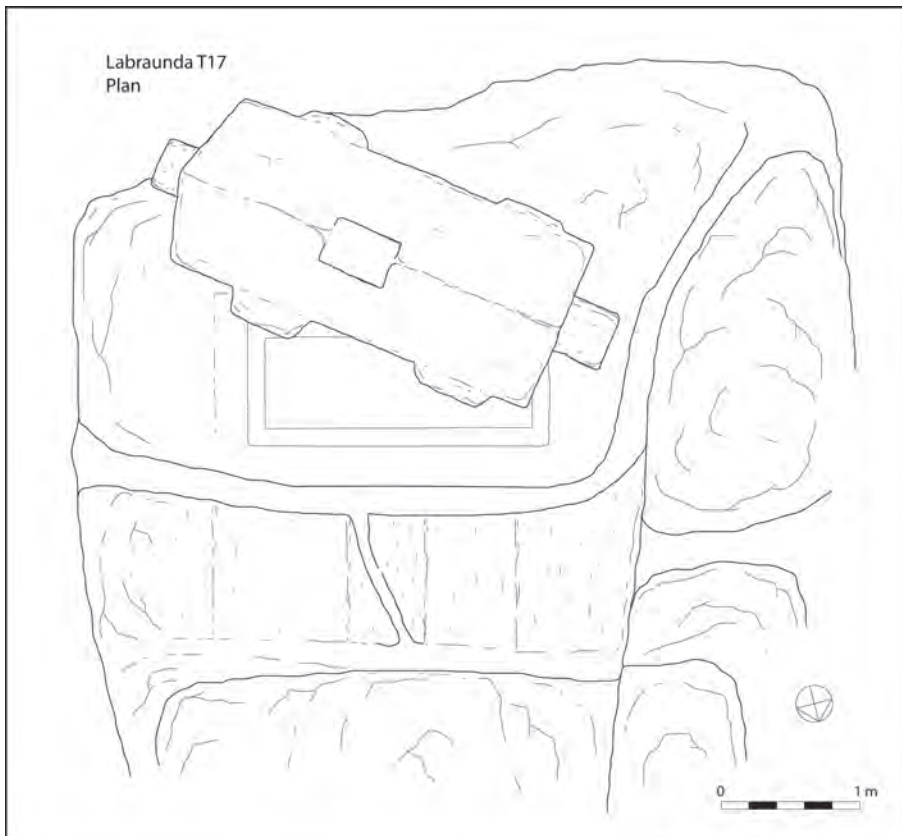

Fig. 52. Plan of Tomb 17. By O. Henry.

⁹¹ The T18 lid measures 2.72 m in length and 1.34 m in width with a total height of 0.58 m. It weighs more than 4.5 tons.



Fig. 53. General view of Tomb 18.



Fig. 54. Lower face of the lid of Tomb 18.



Fig. 55. Black-glass fragment of a possible bolsal (T84.3).



Fig. 56. Fragment of a Roman cooking pot (T22.1).

THE 5TH CENTURY BC SECTION OF THE NECROPOLIS

Besides the work on the single rock-cut sarcophagi, most of the 2010 necropolis campaign was concentrated on the opening of three trenches in the south-western part of the necropolis. The positions for these trenches were determined after the geophysical investigation conducted in 2009, which indicated a high density of subterranean tombs in these areas.⁹² Two trenches were opened along the path leading from the main road to the stadium (Area 5A), while the third one was located along the modern road that covers the ancient Sacred Way, approximately 150 m before reaching the sanctuary (Area 5B).

The two trenches in area 5A were negative as no burial could be found (*Fig. 57*). On the other hand, the trench opened in area 5B revealed a dense group of 16 tombs (*Fig. 58*), to which Tomb 61 belong, excavated in 2007 (*Fig. 59*). Besides T61, which was found unopened, eleven more untouched tombs were excavated this year, while the other four were cleaned. Most of these tombs were arranged in the same pattern: a rectangular pit carved into the rocky ground and covered by a series of roughly cut slabs (*Fig. 60*). Only four tombs showed different arrangements: T86 is a cist tomb (*Fig. 61*), made of four vertical slabs (its cover disappeared);



Fig. 57. General view of the area 5A.

Fig. 58. General view of area 5B after excavation.



⁹² See Karlsson 2010.

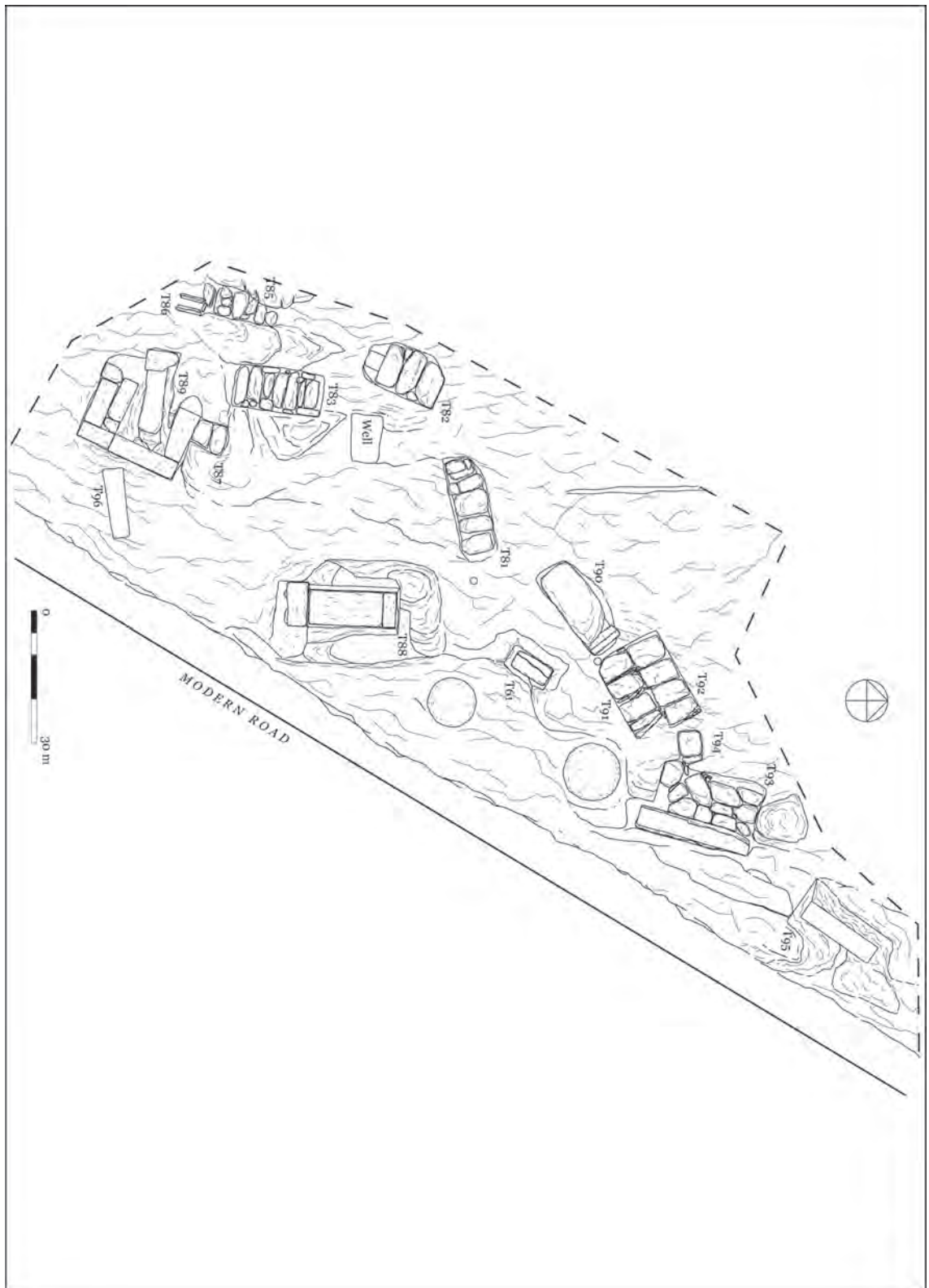

Fig. 59. Situation plan of the tombs in trench 5B. By O. Henry.



Fig. 60. Tomb 83 before/after excavation.

T89 had its pit surrounded by a low pi-shaped wall, made of one single row of four ashlar blocks carefully cut in the local gneiss (Fig. 62); T88 and T93 had very deep two-storeyed pits, with a lower section closed by a very large slab resting on the narrow projection of the side walls (Fig. 63).

When found unlooted, it appeared that most of the tombs were provided with a couple of drinking vessels: almost systematically a *bolsal* and a water jug. The *bolsals* retrieved from the tombs presented different clays and treatments, but all of them have the same shape and comparable dimensions (Fig. 64). The water jugs, on the other hand, exhibit a large variety of shapes and dimensions (Fig. 65): *amphoriskos* in T94, *chytra* in T91 (Fig. 66), *olpe* in T88, mushroom water jug in T90, *oinochoe* in T81, T83 (Fig. 67) and T90, and a table amphora in T93 (Fig. 68). The vessels were usually placed near each other at one end of the pit (Fig. 69). As often happens in Labraunda, no remains of bones could be found in the tombs due to the

acidity of the local soil, and it is therefore impossible to decide whether the vessels were placed at the foot or at the head of the deceased. An interesting point is to emphasize the modesty of the grave deposits; four tombs did not have any associated material (namely T82, T85, T86 and T92) while only three others had metallic material: a silver coin in T83 (Fig. 70), fragments of a bronze stemless cup in T93, and an iron object in T90, possibly a strigil.⁹³ In one tomb we retrieved a broken piece of jewellery (a fragment of a glass bead in T91).

The date of these tombs is most interesting. The material retrieved from the tombs is comparable in shape and size to Attic vessels, although the lack of black glaze and the local clay clearly indicate that they were copies. Nonetheless, the close similarities allow us to provide a fairly good dating for most of them. A first quick analysis of this material, based on a comparative approach with the material from the Athenian Agora, gives a homogeneous chronological horizon around

⁹³ For comparison: 14 iron strigils were found in the Pantanello necropolis at Metaponto, see Carter 1998, 799.



Fig. 61. Tomb 86.



Fig. 62. Tomb 89, seen from the north.

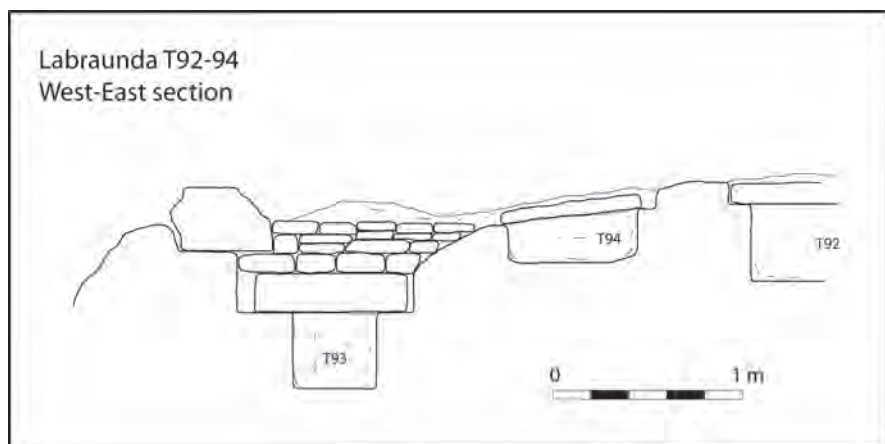

Fig. 63. Section of Tomb 93. By O. Henry.



Fig. 64. General view of some of the material retrieved from the tombs in area SB.

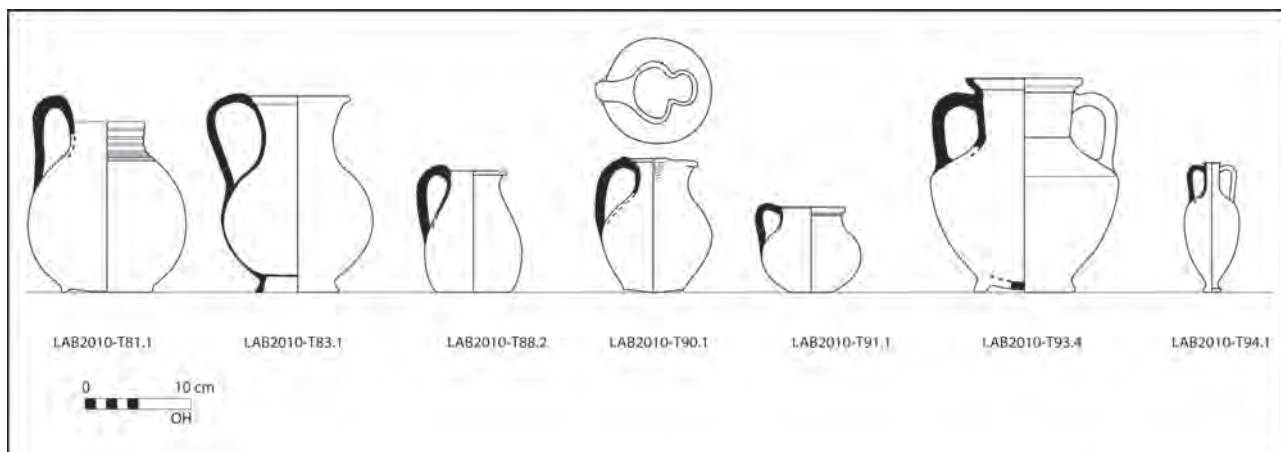

Fig. 65. The jugs from the tombs in area SB.



Fig. 66. Chytra from Tomb 91 (T91.1). By O. Henry.



Fig. 68. Table amphora from Tomb 93 (T93.4). By O. Henry.



Fig. 67. Oinochoe, from Tomb 83 (T83.1). By O. Henry.



Fig. 69. Deposit in Tomb 88.



Fig. 70. Silver coin from Tomb 83.



Fig. 71. Cup from Tomb 93.

425–420 BC,⁹⁴ a dating that also fits the Miletus silver coin from T83.⁹⁵

The discovery of this new section raises several questions and offers new insights concerning the establishment of the necropolis around the sanctuary:

Firstly, the date of the tombs. Up to now the earliest tombs dated back to the mid-fourth century BC and the establishment of the necropolis was considered to express a kind of “fashion” following the erection of the large built tomb over

the temple terrace. With the discovery of the 5th century burial ground in 2011, we discovered that the necropolis pre-dates the Hekatomnid era and that the roots of the necropolis are linked to the cult in the sanctuary rather than to the development of its architecture or celebrity. Considering that the first temple dates back to the late 6th century BC, it would not then be surprising if, in the coming seasons, we uncover tombs from this period.

Secondly, the variety of the tomb configurations is surprising: one finds here twin tombs—probably for couples, as well as single tombs and child tombs. The amount of the latter seems unusual since out of 16 tombs, 4 of them belong to children (T61, T86, T87 and T91). Furthermore, differences in the type of burial were noticeable: in most of the cases it seems that the pits were filled up and the corpses covered with soil before the burials received their covering slabs. In just two cases (namely T88 and T93) the pits were almost empty, including only very fine colluviums. It is worth noticing as well that these two burials were not the only ones to benefit from a deep, two-storeyed pit—the lowest one being covered by a very large slab, but also that T93 was the richest of all, with its bronze stemless drinking cup and its black-gloss vessel (Fig. 71). Also the excavation of T93 revealed that a series of protective measures had been taken in order to protect the burial from looting: the huge monolithic slab covering the pit was “locked” by two lateral “keystones”, the extremities of which were blocked by a huge ashlar block (Fig. 72) and the space between the monolithic slab and the top of the upper pit was filled up with roughly cut heavy stones (Fig. 73).

Thirdly, we noticed that most of the vessels placed inside the pits were broken. This concerns mostly the drinking cups (*bolsals* and stemless drinking cups), which have one or both handles missing. Interpreting such practice is not easy (perhaps a way to “kill” the vessel so that it can accompany the dead towards the other world?).

Fourthly, in the southeast part of the burial ground one notices the presence of two hemispherical pits. They were probably originally located immediately along the ancient path leading to the sanctuary, now covered by the modern road. The size of the cuttings (60–80 cm in diameter) seems to point out devices linked to the funerary sacrifices or rituals (*bomos*, fire-place, libation, etc.). It is also worth noticing that a shallow well (c. 2.40 m deep, rectangular in shape), was found in the middle of this burial ground. It was filled up with earth and broken ceramics, particularly vessels connected with water (amphorae, an oinochoe, a “pilgrim flask”). The well is dry and does not seem to have been fed by an underground water spring, but rather by rainwater. A last kind of cutting concerns two small post-holes (15 cm in diameter and some 10 cm deep) located near the eastern corner of T81 and near the southwest corner of T91 respectively. It is believed

⁹⁴ T83: *oinochoe* (Agora XII, cat. nos. 187–188), *bolsal* (Agora XII, cat. no. 539): c. 425 BC; T87: *bolsal* (Agora XII, cat. no. 539): c. 420 BC; T88: *olpe* (Olynthus V, cat. no. 228, late 5th BC), *bolsal* (Agora XII, 539: c. 420 BC); T90: *oinochoe* with flat bottom (Louvre Museum CA 1683: c. 425 BC), mushroom jug (Agora XII, 66–68: c. 425 BC, although different foot); T91: *chytra* (Agora XII, cat. nos. 1937–1938: 5th century, probably 425–400 BC); T93: bowl (Agora XII, no. 785: c. 420 BC), table amphora (late version of a Fikellura-shaped amphora? close to Agora XII, cat. no. 1467: 375–300 BC); bronze stemless cup (belonging to the “Delicate class” described in Agora XII, 102–105) with the same kind of a central rosette and dated to the last quarter of the 5th century BC (Agora XII, cat. no. 490).

⁹⁵ SNG Keckman II, nos. 263–282.



Fig. 72. Tomb 93 after first cleaning of the surface.



Fig. 73. Tomb 93 with the upper pit emptied.

that those post-holes were meant to receive a wooden *sema* (they seem too shallow to have been able to hold a heavier material such as stone).

Finally, one might raise the question of the economic status of the buried population as revealed by the excavations. Indeed, although the buried deposits and tomb shapes were extremely modest, one should recall that the very same kind of tombs provided a rich collection of jewellery pieces during the 2008 excavations.⁹⁶ Therefore, it seems difficult to draw conclusions about the social background of the dead from the 5th century BC as their relative poverty might reflect a poor social background as well as a general economic situation in 5th-century Karia.

One of the aims of the 2011 campaign will be to extend the trench in area 5B that will, hopefully, bring as many new elements as it did in 2010.

LARS KARLSSON
Department of Archaeology and Ancient History
Uppsala University
Box 626
SE-UPPSALA
lars.karlsson@antiken.uu.se

JESPER BLID
Department of Archaeology and Classical Studies
Stockholm University
SE-106 91 STOCKHOLM
jesper.blid@antiken.su.se

OLIVIER HENRY
Institut Français d'Etudes Anatoliennes
Nuru Ziya Sok. 10, P.K. 54
TR-34433 ISTANBUL
olivierhenry@gmail.com

⁹⁶ Karlsson 2008, 81.

Bibliography

- Aliprandis 1996 Θ.Χ. Αλιπράντης, *Η Εκατονταπυλιανή της Πάρου: 1670 χρόνια από τό Τάμα της Αγίας Ελένης*, Paros 1996.
- Arslan & Böhlendorf-Arslan 2010 N. Arslan & B. Böhlendorf-Arslan, *Assos: an archaeological guide*, Istanbul 2010.
- Agora XII:1–2 B.A. Sparkes & L. Talcott, *The Athenian Agora. Results of excavations conducted by the American School of Classical Studies XII:1–2. Black and plain pottery of the 6th, 5th and 4th centuries B.C.*, Princeton 1970.
- Agora XXXII J. Hayes, *The Athenian Agora. Results of excavations conducted by the American School of Classical Studies at Athens XXXII. Roman pottery: fine-ware imports*, Princeton, N.J. 2008.
- Agora XXXIII S.I. Rotroff, *The Athenian Agora. Results of excavations conducted by the American School of Classical Studies XXXIII. The Hellenistic pottery. The plain wares*, Princeton 2006.
- Bass 1972 G.F. Bass, *A history of seafaring based on underwater archaeology*, London 1972.
- Bean 1971 G.E. Bean, *Turkey beyond the Meander: an archaeological guide*, London 1971.
- Blid 2006–2007 J. Blid, 'New research on Carian Labraunda in Late Antiquity', *OpAth* 31–32, 2006–2007, 231–255.
- Blid 2008 J. Blid, 'The Byzantine churches', in Karlsson 2008, 122–126.
- Blid 2010a J. Blid, 'Research on Labraunda in Late Antiquity', in Karlsson 2010, 80–90.
- Blid 2010b J. Blid, 'Late-antique glass in sacred context: a hagiaσμα at Carian Labraunda', in *Late antique glass in Anatolia (A.D. 4th to 8th cent.)*, Izmir, October 26–28, 2009, eds. E. Lafli & S. Fünfschilling, Izmir 2010.
- Blid 2011 J. Blid, 'Recent research on the churches of Labraunda', in *Labraunda and Karia*, 99–108.
- Boyd 2007 S. Boyd, 'Champlevé revetments', in *Kourion: excavations in the Episcopal precinct* (Dumbarton Oaks Studies, 38), Cambridge, Mass. 2007, 235–296.
- Campbell 1991 S. Campbell, *The mosaics of Aphrodisias in Caria*, Toronto 1991.
- Carter 1998 J.C. Carter, *The chora of Metaponto. The necropoleis*, Austin, TX 1998.
- Coulton 1976 J.J. Coulton, *The architectural development of the Greek stoa*, Oxford 1976.
- Dell'Acqua 2005 F. Dell'Acqua, 'Enhancing Luxury through Stained Glass, from Asia Minor to Italy', *DOP* 59, 2005, 193–211.
- Devambez & Haspels 1959 P. Devambez & É. Haspels, *Le sanctuaire de Sinuri près de Mylasa. Seconde partie: architecture et céramique*, Paris 1959.
- Doğer 2007 L. Doğer, 'Byzantine ceramics: excavations at Smyrna Agora (1997–98 and 2002–03)', in *Late Antique and medieval pottery and tiles in Mediterranean archaeological contexts (=Byzas 7)*, eds. B. Böhlendorf-Arslan, A.O. Uysal & J. Witte-Orr, Istanbul 2007, 97–122.
- Duval & Baratte 1973 N. Duval & F. Baratte, *Les ruines de Sufetula Sbeitla*, Tunis 1973.
- Elton *et al.* H. Elton, E. Equini-Schneider & D. Wannagat, *Temple to church. The transformation of religious sites from paganism to Christianity in Cilicia*, Istanbul 2007.
- Falla Castelfranchi 1994 M. Falla Castelfranchi, 'Amboni carii: un caso desueto', *Boreas* 17, 1994, 49–52.
- Falla Castelfranchi 2005 M. Falla Castelfranchi, 'Il complesso ecclesiale di Bargylia', *Iasos e la caria – nuovi studi e ricerche* (PP, 60:2–6), ed. R. Pierobon Benoit, Napoli 2005, 419–464.
- Feld 1975 O. Feld, 'Christliche Denkmäler aus Milet und seiner Umgebung', *IstMitt* 25, 1975, 197–209.
- Flaminio 2010 R. Flaminio, 'Liturgical furnishings', in *The sculptures of the Ayasofya Müzesi in Istanbul: a short guide*, eds. C. Barsanti & A. Guiglia, Istanbul 2010, 69–78.
- Flourentzos 1996 P. Flourentzos, *Excavations in the Kouris Valley II. The Basilica of Alassa*, Nicosia 1996.

- Ephesos* IV/3 J. Kiel, *Forschungen in Ephesos* IV/3. *Die Johanneskirche*, Wien 1951. House & Megaw 2007 G. House & A.H.S. Megaw, 'Architectural sculpture and revetment', in *Kourion. Excavations in the Episcopal precinct* (Dumbarton Oaks Studies, 38), Cambridge, Mass. 2007, 179–233.
- Ephesos* XIII/1:1 V. Gassner, *Forschungen in Ephesos* XIII/1:1. *Das Südtor der Tetragonos-Agora*, Wien 1997.
- Foss 1994 C. Foss, 'The Lycian coast in the Byzantine age', *DOP* 48, 1994, 1–52. Kanellopoulos & Schick 2001 C. Kanellopoulos & R. Schick, 'Marble furnishings of the apses and the bema, Phase V', in *The Petra Church*, eds. Z.T. Fiema *et al.*, Amman 2001, 193–214.
- Frühchristliches und byzantinisches Ephesos* *Frühchristliches und byzantinisches Ephesos*, eds. O. Kresten, F. Krinzinger, R. Pillinger & E. Russo, Wien 1999. Karlsson 1992 L. Karlsson, *Fortification towers and masonry techniques in the hegemony of Syracuse, 409–211 B.C.* (ActaRom-4°, 49), Stockholm 1992.
- Gough *et al.* 1985 M. Gough *et al.*, *Alaban. An early Christian monastery in southern Turkey*, Toronto 1985. Karlsson 2008 L. Karlsson, 'Labraunda 2004–2007. A preliminary report on the Swedish excavations, with contributions by Olivier Henry and Jesper Blid', *IstMitt* 58, 2008, 109–133.
- Halikarnassos* 7 L.E. Vaag, V. Nørskov & J. Lund, *The Maussolleion at Halikarnassos, Reports of the Danish Archaeological Expedition to Bodrum 7. The pottery. Ceramic material and other finds from selected contexts*, Aarhus 2002. Karlsson 2009 L. Karlsson, 'Labraunda 2008. A preliminary report on the Swedish excavations with contributions by Olivier Henry and Jesper Blid', *Opuscula. Annual of the Swedish Institutes at Athens and Rome* 2, 2009, 57–87.
- Hayes 1972 J.W. Hayes, *Late Roman pottery*, London 1972.
- Hebert 2000 L. Hebert, *The Temple-Church at Aphrodisias*, diss. Institute of Fine Arts, New York University, 2000. Karlsson 2010 L. Karlsson, 'Labraunda 2009. A preliminary report on the Swedish excavations with contributions by Olivier Henry and Jesper Blid', *Opuscula. Annual of the Swedish Institutes at Athens and Rome* 3, 2010, 61–104.
- Hellström 1991 P. Hellström, 'Labraynda 1990', in *XIII. AST Çanakkale 1990*, Ankara 1991, 155–158.
- Hellström 1993 P. Hellström, 'Labraynda 1991', in *Kazı Sonuçları toplantısı* 14:2, 1993, 123–131. Karlsson 2011 Lars Karlsson, 'The forts and fortifications of Labraunda', in *Labraunda and Karia*, 216–252.
- Hellström 1994 P. Hellström, 'Architecture. Characteristic building-types and particularities of style and technique. Possible implications for Hellenistic architecture', in *Hekatomnid Caria and the Ionian renaissance* (Halikarnassian Studies, 1), ed. J. Isager, Odense 1994, 36–57. Keller & Lindblom 2008 D. Keller & J. Lindblom, 'Glass finds from the church and the chapel', in *Petra – The Mountain of Aaron* 1. *The church and chapel*, eds. Z.T. Fiema & J. Frösén, Helsinki 2008, 330–376.
- Hellström 2007 P. Hellström, *Labraunda: a guide to the Karian sanctuary of Zeus Labraundos*, Istanbul 2007. *Labraunda* I:1 K. Jeppesen, *Labraunda, Swedish excavations and researches* I:1. *The Propylaea* (ActaAth-4°, 5:1:1), Lund 1955.
- Henry & Ingvarsson-Sundström 2011 O. Henry & A. Ingvarsson-Sundström, 'The story of a tomb at Labraunda', in *Labraunda and Karia*, 177–197. *Labraunda* I:2 A. Westholm, *Labraunda, Swedish excavations and researches* I:2. *The architecture of the Hieron* (ActaAth-4°, 5:1:2), Lund 1963.

- Labraunda* II:1 P. Hellström, *Labraunda, Swedish excavations and researches* II:1. *Pottery of Classical and later date, terracotta lamps and glass* (ActaAth-4^o, 5:2:1), Lund 1965.
- Labraunda and Karia* *Labraunda and Karia. Proceedings of the international symposium commemorating sixty years of Swedish archaeological work in Labraunda, Stockholm, November 20–21, 2008* (Boreas. Uppsala Studies in Ancient Mediterranean and Near Eastern Civilizations, 32), Uppsala 2011.
- Larisa am Hermos* III J. Boehlau & K. Schefold, *Larisa am Hermos. Die Ergebnisse der Ausgrabungen 1902–1934* III. *Die Kleinfunde*, Berlin 1942.
- Lehtinen 2008 A. Lehtinen, 'Marble furnishing and decoration', in *Petra – The Mountain of Aaron* 1. *The church and chapel*, eds. Z.T. Fiema & J. Frösén, Helsinki 2008, 187–234.
- Lemerle 1945 P. Lemerle, *Philippe et la Macédoine orientale à l'époque chrétienne et Byzantine*, Paris 1945.
- Ling 2005 R. Ling, *Pompeii: history, life & afterlife*, Stroud 2005.
- Mathews 1971 T.F. Mathews, *The early churches of Constantinople: architecture and liturgy*, London 1971.
- O'Hea 2001 O'Hea 2001, 'Glass from the 1992–93 excavations', in *The Petra Church*, eds. Z.T. Fiema et al., Amman 2001, 370–376.
- Olynthus* V D.M. Robinson, *Excavations at Olynthus V. Mosaics, vases, and lamps of Olynthus found in 1928 and 1931*, Baltimore & London 1933.
- Olynthus* XIII D.M. Robinson, *Excavations at Olynthus XIII. Vases found in 1934 and 1938*, Baltimore & London 1950.
- Ousterout 1999 R. Ousterout, *Master builders of Byzantium*, Princeton 1999.
- Özet 2008 A. Özet, 'Excavations in the Torba Monastery', in *Halicarnassian Studies* 5, ed. P. Pedersen, Odense 2008, 9–42.
- Pedersen 2011 P. Pedersen, 'The Ionian Renaissance seen from the Karian lewis hole', in *Labraunda and Karia*, 365–388.
- Peschlow 1975 U. Peschlow, 'Byzantinische Plastik in Didyma', *IstMitt* 25, 1975, 211–258.
- Peschlow 1996 U. Peschlow, 'Die Latmosregion in byzantinischer Zeit', in A. Peschlow, *Der Latmos. Eine unbekannte Gebirgslandschaft an der türkischen Westküste*, Mainz am Rhein 1996, 58–86.
- Peschlow 2006 U. Peschlow, 'Dividing interior space in early Byzantine churches: the barriers between nave and aisles', in *Thresholds of the sacred. Architectural, art historical, liturgical and theological perspectives on religious screens, east and west*, ed. S.E.J. Gerstel, Cambridge, Mass. 2006, 53–71.
- Poulsen 1997 B. Poulsen, 'The city personifications in the Late "Roman Villa" in Halikarnassos', in *Patron and pavements in Late Antiquity* (Halicarnassian Studies, 2), eds. S. Isager & B. Poulsen, Odense 1997, 9–23.
- Poulsen 2011 B. Poulsen, 'Halikarnassos during the Imperial period and Late Antiquity', in *Labraunda and Karia*, 425–443.
- Poulter et al. 1995 A.G. Poulter et al., *Nicopolis ad Istrum: A Roman, Late Roman and Early Byzantine city. Excavations 1985–1992*, London 1995.
- Poulter et al. 1999 A.G. Poulter et al., *Nicopolis ad Istrum: A Roman to Early Byzantine city. The pottery and glass*, London 1999.
- Samos* XIV R. Tölle-Kastenbein, *Samos XIV. Das Kastro Tigani: die Bauten und Funde griechischer, römischer und byzantinischer Zeit*, Bonn 1974.
- Saraçhane* I R.M. Robinson, *Excavations at Saraçhane in Istanbul I. The excavations, structures, architectural decoration, small finds, coins, bones, and molluscs*, Princeton 1986.
- Saraçhane* II J. Hayes, *Excavations at Saraçhane in Istanbul II. The pottery*, Princeton 1992.
- Sardis* 12 S.I. Rotroff & A. Oliver Jr., *Archaeological exploration of Sardis 12. The Hellenistic pottery from Sardis. The finds through 1994*, Cambridge, Mass. 2003.

- Serin 2004 U. Serin, *Early Christian and Byzantine churches at Iasos in Caria: an architectural survey* (Monumenti di antichità cristiana, II serie, 17), Città del Vaticano 2004.
- SNG Keckman II *Sylloge Nummorum Graecorum, The Erkki Keckman collection, Finland II*, ed. R. Ashton, Helsinki 1999.
- Stählin *et al.* 1934 F. Stählin, E. Meyer & A. Heidner, *Demetrias und Pagasai*, Berlin & Leipzig 1934.
- Thiel 2005 A. Thiel, *Die Johanneskirche in Ephesos*, Wiesbaden 2005.
- Travlos 1971 J. Travlos, *Bildlexikon zur Topographie des antiken Athen*, Tübingen 1971.
- Westphalen 2000 S. Westphalen, 'The Byzantine Basilica at Priene', *DOP* 54, 2000, 275–280.
- Young 2007 S.H. Young, 'Glass', in *Kourion: excavations in the Episcopal precinct* (Dumbarton Oaks Studies, 38), Cambridge, Mass. 2007, 485–526.

