



**HAL**  
open science

## Genealogical variant locations and simplified stemma: a test case

Jean-Baptiste Camps, Florian Cafiero

► **To cite this version:**

Jean-Baptiste Camps, Florian Cafiero. Genealogical variant locations and simplified stemma: a test case. *Analysis of Ancient and Medieval Texts and Manuscripts: Digital Approaches (Lectio: studies in the transmission of texts & ideas, 1)*, Tara Andrews; Caroline Macé, Apr 2012, Louvain, Belgium. pp.69-93, 10.1484/M.LECTIO-EB.5.102565 . halshs-01435633

**HAL Id: halshs-01435633**

**<https://shs.hal.science/halshs-01435633v1>**

Submitted on 21 Jan 2017

**HAL** is a multi-disciplinary open access archive for the deposit and dissemination of scientific research documents, whether they are published or not. The documents may come from teaching and research institutions in France or abroad, or from public or private research centers.

L'archive ouverte pluridisciplinaire **HAL**, est destinée au dépôt et à la diffusion de documents scientifiques de niveau recherche, publiés ou non, émanant des établissements d'enseignement et de recherche français ou étrangers, des laboratoires publics ou privés.

# Genealogical Variant Locations & Simplified Stemma : a Test Case\*

J.-B. Camps & F. Cafiero  
Univ. Paris – Sorbonne

## Introduction

The method to be presented here relies upon text-genealogical principles inspired by the Lachmannian or neo-Lachmannian tradition,<sup>1</sup> and attempts to computerise them, following and extending the procedure first proposed by E. Poole in the 70's (Poole 1974, 1979). More than the application of computerised methods to philology, this method seeks to extend philology through the aid of the computer.<sup>2</sup> It favours interaction between philologist and computer, and requires the former's critical judgement at some points.<sup>3</sup>

After a careful selection of variant locations<sup>4</sup>, needed to eliminate contamination and

---

\* Sources used for this article are available at <http://graal.hypotheses.org/625>. Readers are welcome to contact the authors at [jbcamps@hotmail.com](mailto:jbcamps@hotmail.com) or [florian.cafiero@polytechnique.edu](mailto:florian.cafiero@polytechnique.edu).

- 1 The hesitation in terminology here deserves some explanation. Parts of what is traditionally considered the 'Lachmannian method' do not stem from Karl Lachmann, but from other philologists and scholars. *Stemmata* themselves did not appear in Lachmann's work; the idea of elaborating a genealogy of manuscripts based on their common readings (though not yet common errors) goes back to the XVIII<sup>th</sup> century and scholars such as Bengel (see particularly in Bengel 1763, p. 20–21, where he states that the entire tradition of the New Testament could be summarised in a *tabula genealogica*, a statement presented along with the concept of elimination of singular readings inside each family), and the first actual *stemmata* appeared almost concurrently in Schlyter and Collins 1827, Zumpt 1831, I, p. XXXVIII, and Ritschl 1832, p. XXX. Even after *stemmata* became common, Lachmann never took the time to draw any in his editions, perhaps considering them an unnecessary simplification, in contrast to some of his followers such as Karl Nipperdey. The confusion between the work of Lachmann and the method of the 'common errors', often erroneously attributed to him, seems to go as far back as the 1860s and contributions by Goebel in 1860 and by Boeckh in 1877 (see Fiesoli 2000, part. p. 261 and 370). However, the idea that only the 'common errors' (and not 'common readings') have a genealogical value is to be attributed to Gaston Paris in 1872, although not clearly stated and theorised until Paul Lejay, first in a review of a work by Sabbadini in 1888 ('[...] dans sa liste de variantes, il [M. Sabbadini] introduit de bonnes leçons de *B H b* qui ne prouvent rien. Si, en effet, *B H b* ont une bonne leçon contre une faute ou plutôt une innovation de *M*, cela ne peut prouver seulement que le copiste de *M*, comme tout autre, a ses fautes personnelles,' p. 282); and then more clearly even in an other review from 1903 ('Une famille de manuscrits est constituée par leurs fautes communes, ou, si l'on préfère ce terme plus exact, par leurs innovations communes. Ainsi, l'existence d'une série de leçons correctes et authentiques dans plusieurs manuscrits ne peut prouver que ces manuscrits dérivent d'une source commune. Les fautes seules sont probantes,' p. 171). In a strict sense, Lachmann's originality resides more in his intent to reconstruct the text of the archetype mechanically, without having to appeal to critical *judicium*. Nonetheless, the term of 'Lachmannian' is broadly used to qualify a philologic current of thought whose foundations go back earlier than our German scholar, and that was further developed and enriched after him by famous philologists such as G. Paris, P. Collomp, G. Pasquali or P. Maas, to name but a few. See the enlightening works on the genesis of this method by Timpanaro 2003, and Fiesoli 2000. For the history of the elaboration of the principle of 'common errors', see Reeve 1998 or the shorter and less precise summary by Froger 1968, p. 41–42.
- 2 As such, it seeks to take into account the question of Duval (2011) on computerised stemmatological methods: 'Quel éditeur pourra juger du degré de confiance à placer dans des algorithmes complexes, dont il ne maîtrise pas les soubassements?'
- 3 It is in that regard similar in perspective to the contribution in this volume by P. Roelli, 'Petrus Alfonsi or On the mutual benefit of traditional and computerised stemmatology'.
- 4 A variant location (*lieu variant*), sometimes called a 'place of variation' is to be understood as a 'part of a text in which the extant text versions show one or more different ("competing") variants' (Salemans 1996), or more precisely in our case, as the largest textual unit showing stable common variation among witnesses and opposing at least one witness to the others, be it at the word- or syntagm-level; it is to be noted that it corresponds to the way variants are commonly displayed in the critical *apparatus* of an edition (i.e. attached to a common *lemma*).

polygenesis (the two major factors that could impede the elaboration of a stemma), we will then proceed to produce a stemma that is, at least at first, a simplification. It is of course to be noted that a stemma is by its very nature a simplification. In particular, Weitzman 1985, p. 82 notes that:

The stemmatic method involves the following assumptions: (i) the author nowhere left variant readings; (ii) every manuscript (except the original) was copied from a single source; (iii) no two copyists originated the same error independently; (iv) errors were not removed by conjecture; (v) every relevant manuscript (i.e. a manuscript that survives or leaves extant progeny) except the original introduced at least one new error, at a point where no relevant manuscript had yet erred; (vi) of the errors introduced by a given relevant manuscript, at least one can be identified by critics as an error.

It is obvious that, in most text traditions, this will never be strictly the case. This is why we will, in the first instance, focus all our efforts on the removal of all variant location that do not fit these principles (*i-iv*)—and it is in that sense that the stemma produced will have to be considered a simplification. Moreover, we choose not to postulate any supposedly lost manuscript that is not strictly necessary to represent the genealogy of the extant ones. We will, on the other hand, have to assume that rule (*v*)—the introduction of at least one new error by each of the ‘relevant manuscripts’, an error that should be at this point found only in this manuscript<sup>5</sup>—always applies. Fortunately, as we shall see, our method is not bound by rule (*vi*) as it is based only on disagreements.

### *The Method : Selecting readings – Preliminaries*

To establish our first selection of variant location and readings, a few things need to be said about the nature of the texts with which we intend to work. As medieval vernacular works, they are usually characterized by what has been called a ‘*tradizione attiva*’ (Varvaro 1970, p. 87)—that is, a tradition in which scribes feel at liberty to introduce modifications to the text in order to ‘improve’ it according to their own perception or tastes. In many cases they are even expected to do so, for instance, to adapt the text to the uses or tastes of their region, time, or a particular audience. The most obvious examples of such modifications are diachronic or diatopic variations, such as graphical change induced to give a word a more modern or locally appealing aspect. At this level, this kind of transformation may even not necessarily be conscious. Of course, they can also happen on a larger scale and be the outcome of a fully conscious intention to transform, interpolate, or rewrite parts of the source<sup>6</sup>

This phenomenon—be it called ‘*mouvance*’ (Zumthor 1972) or, perhaps more properly considering the written more than oral nature of this transformation, ‘*variance*’ (Cerquiglini 1983)—results in each medieval copy being what Cesare Segre calls a ‘diasystem’, that is, a compromise between two or more systems: the system of the original and that of the scribes. Those two systems interact with each other and result in a compromise inherent to each

---

5 Contrarily to Weitzman, we think that the error in itself should be unique to this manuscript at this point, not that the existence of an error should be unique; this new error could coexist with other different errors found elsewhere in the tradition at the same variant location, and still play the role Weitzman attributes to it. On the other hand, there is a need to add another principle, that could be formulated as: “every relevant manuscript has kept intact at least one of the errors belonging to his source” – a principle slightly different from (*iv*) as it excludes any modification to the error, not just its being removed by conjecture.

6 See the summary of these questions, done from the point of view of scribal behaviour in Camps 2012.

medieval copy, a new system including its own form of variation (Segre 1976, 1979).

Moreover, the texts are heavily transformed by the process of text copying itself. A good understanding of this process, which is in itself interesting, also enables us to gain a better understanding of text variation, and, eventually, of text genealogy. In that case, books like Louis Havet's *Manuel de critique verbale* (Havet 1911) are highly valuable: his catalogue of errors can also be read as a fundamental study on what text copying in the Middle Ages was, and we strongly believe that any stemmatological method must be grounded in sound knowledge of the mechanisms of text copying, especially in what concerns the genesis of variations and errors.

In this regard, we can only sympathize with Marichal's regret (1979, p. 287) that there is no equivalent to Havet's book for vernacular languages, apart from several attempts, of limited broadness, such as the one found in Robert Marichal's editions of Marguerite de Navarre's texts<sup>7</sup>:

Les latinistes ont le *Manuel de critique verbale* de Havet [...]. Pour la langue vulgaire, nous n'avons rien. [...] c'est un travail long et fastidieux, démoralisant parce qu'il est très complexe ; il requerrait d'ailleurs la collaboration d'un psychologue. Mais il ne paraît pas douteux qu'un gros catalogue, bien fait, fondé sur de nombreux textes variés, nous donnerait une compréhension beaucoup plus profonde de la psychologie d'un copiste et permettrait d'aboutir à une pondération statistique des variantes.

It would indeed certainly be a very fruitful project to build a database of errors that could be used to identify the mechanisms inherent to text variation—the environmental, psychological, and textual factors inseparable from text copying—and its impact would certainly be broader than stemmatology. Beyond the weighting of readings hinted at by Marichal, such a catalogue would be very helpful (including what was mentioned above) to help in the elaboration of sets of text–genealogical rules, such as the inspiring one from Salemans 1996.

### *The Method : Selecting readings – Encoding and selection of variant locations*

The first step is of course to create a database and select the readings. According to the aforementioned principles, and to eliminate the most likely cases of *polygenesis*—what Havet (1911, § 1614) calls '*rencontres*', and Salemans (1996) or Schmid (2004) '*parallelisms*'<sup>8</sup>—we differentiate between:

1. **indicative readings** (useful for dating, localisation or work on the scribe's system), such as simple graphical changes, synonymisms, diachronic or diatopic variations, flexional changes in tense or case, simple inversions, which are excluded from the database;
2. **potentially genealogical readings** characterised by:
  - (a) being not easily reproducible independently;
  - (b) being not easily corrigible through conjecture;

<sup>7</sup> See the 'Catalogue des fautes' in Marichal 1956 and in Marichal 1971.

<sup>8</sup> Contrarily to what Salemans 1996, p. 8, n. 5 affirms Havet does not use the term of '*parallélisme*' with the same meaning as he does. For Havet 1911 § 543, a '*parallélisme*' is a scribal error ('*confusion de passage*') due to analogies in two close parts of a text: 'Lorsque deux portions de texte voisines ont des analogies, les auteurs s'efforcent d'y varier l'expression ; les copistes, au contraire, tendent à l'uniformiser [...]'.  

---

- (c) producing a semantic alteration;
- (d) being somehow meaningful by themselves (a reading ‘must fit inconspicuously in context’ [Salemans 1996], a rule also referred to as elimination of ‘nonsense readings’ [Colwell 1969; Duplacy 1979; Epp 1967], or, to quote Maas [1957, p. 32]: ‘Besonders sicher kenntlich als Trennfehler sind solche Fehler [...], die in ihrer Umgebung gar nicht als Fehler erkannt werden, also keinen Anreiz zu konjekturaler Beseitigung geben konnten’); it results, for instance, in the exclusion of nonexistent words.

Amongst potentially genealogical readings, a distinction must be made between: (i) readings that are potentially genealogical *only in certain configurations*, i.e. singular readings (SR) or *omissions*; (ii.) readings shared by at least two manuscripts, or common readings (CR).

When, for a given potentially genealogical variant location, we have at least two different potentially genealogical readings, each of which is shared by at least two manuscripts (i.e., two different CR), we can assume the presence of at least one genealogically usable significative error or *Leitfehler* (Maas 1937).<sup>9</sup> Since we do not want to have to judge *ex ante* which (if any) reading is original and which is innovated or erroneous, we will work only on textual disagreements (and not on agreements), in which case—assuming no *varianti di autore* (Pasquali 1934, p. 396ff.)—we assume that at least one of those readings is not original and that we are thus left with one usable separative error—*errores separativi* or *Trennfehler* (Maas 1937)<sup>10</sup>—of course, with three different CR, we can assume two usable separative errors.

Or to say it more formally, let  $R_a$  be the set of manuscripts containing the same Reading  $a$ , let  $L$  be a variant Location such as  $L = \{R_a, \dots, R_i\}$ , and  $S$  the number of Separative errors:

$$\forall L, \exists (R_a, R_b), (\text{Card}(R_a) > 1) \wedge (\text{Card}(R_b) > 1) \Rightarrow 1 \leq S \leq 2 \quad (1)$$

We will see later how the disagreements can be used to build the stemma. For now, nonetheless, as Schmid 2004 tries to demonstrate, a set of text–genealogical rules for the selection of variant readings does not suffice to rid oneself completely from accidental common variations (polygenesis, also called ‘*rencontres*’ or ‘parallelisms’). Moreover, we are still left to face the most terrifying foe of every text–genealogist, i.e., *contamination*, against which, to use the very famous quotation of Maas 1937, p. 294, ‘*ist noch kein Kraut gewachsen*’ (or in an even less optimistic way: ‘*ist kein Kraut gewachsen*’, Maas 1957, p. 31). To that end, we will make use, at first, of a quite archaic medical principle to be able to produce a (simplified) stemma: *amputate that what you cannot treat*.

<sup>9</sup> This can be compared, in some regards, to Salemans 1996, p. 19, fourth genealogical rule and his notion of ‘type-2 variation’ (‘Only if all text versions show at a place of variation exactly two genealogically significant variants, and if each variant does occur in at least two text versions, can these variants be directly used for the determination of the structure of the stemma [...]. This fundamental variation is called a ‘type-2’ variation’), with the important difference that we see a limitation to binary variant locations as dangerous, and that our method allows to take into account variant locations containing more than two CR, and, to some extent, also to take singular readings into account.

<sup>10</sup> Since we will not group manuscripts if they share one CR, but instead, will separate them if they are opposed on two different CR, we are freed from the traditional Lachmannian necessity to differentiate between an original reading, the sharing of which has no genealogical weight, and a ‘common error’, implying parentage.

The application of our method must be strict, making it necessary for all non-genealogical or contaminated readings to be properly filtered out using our aforementioned principles; after this first selection *by individual examination*, we then proceed to a second algorithmic selection.

*The Method: Selecting readings – Detecting genealogically unusable variant locations*

**The principle:** Once we have selected potentially genealogical variant location, we need to assess which ones truly are, and which ones result from either left out cases of polygenesis or contamination. To this end we shall make use of an algorithmic selection of variant location based on an inspiring article from Poole (1979). Its principle is both easy to understand and very powerful. Variant locations are systematically compared two by two. For the sake of the demonstration, we can picture this as a table, figuring the different readings of the first variant location (where in this example three variant readings are found, labelled 1-1 to 1-3), and those of the second variant location (four variant readings, labelled 2-1 to 2-4). Each combination, extant in at least one manuscript, of a reading from the first variant location with a reading from the second variant location is marked in the table (fig.1 and 2).<sup>11</sup> As long as there is no ‘closed configuration’, no problem arises, and the two variant location may both correspond to a possible genealogy (1). On the other hand, as soon as there is a closed configuration, there is a problem (either polygenesis or contamination), because this configuration cannot correspond to a normal genealogical tradition (2).<sup>12</sup>

	1-1	1-2	1-3
2-1	A	D	
2-2			C
2-3	B		
2-4		E	

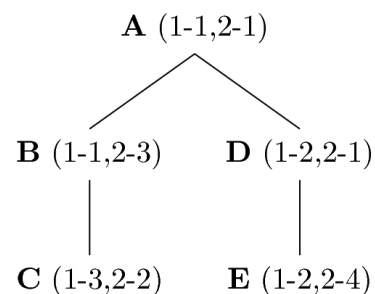

**Figure 1:** Crossing the readings of two potentially genealogical variant locations: table (left) and an example of a possible genealogy it could correspond to (right).

	1-1	1-2	1-3
2-1	A	D	
2-2			C
2-3	B	E	
2-4			

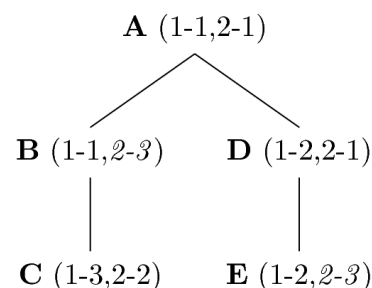

**Figure 2:** Conflicting variant locations: table (left) and absence of a possible normal genealogy (right).

<sup>11</sup> To take a virtual example for clarity’s sake, for the first table, we could have a first variant location: cuer *AB* iex *DE* chief *C*, and a second: esragiement *AD* forment *C* estraiement *B* per engien *E*. For the second, we could have a first variant location: cuer *AB* iex *DE* chief *C*, and a second: esragiement *AD* forment *C* estraiement *BE*.

<sup>12</sup> Our approach can be compared to the procedure proposed by Roelli in his contribution in this volume (see the ‘Previous Research’ section); they actually seem more or less equivalent, with a slight difference in the treatment of *lacunae*, when there is exactly two different readings for each of the considered variant location, but tend to differ in other cases.

This ‘closed configuration’ can also be formalised as: let  $x,y$  be readings of the first variant Location  $L$  and  $x',y'$  readings of the second variant Location  $L'$ , such as:

$L = \{x, y, \dots\}, L' = \{x', y', \dots\}$ , let  $M = \{m_1, \dots, m_k, \dots, m_n\}$  be the set of all manuscripts, and  $G$  the group of genealogical variant locations:

$$\left\{ \begin{array}{l} \{x, x'\} \in m_k \\ \{x, y'\} \in m_{k'} \\ \{x', y'\} \in m_{k''} \\ \{y, y'\} \in m_{k'''} \\ (k, k', k'', k''') \in [1; n]^4 \end{array} \right. \quad (2)$$

$$\Rightarrow (L \notin G) \vee (L' \notin G)$$

In that case, the two variant locations are considered to be ‘conflicting’ with each other, and at least one of them is genealogically unusable at that point.

This is, we think, a typical example of how traditional stemmatic methods can be extended by the use of the computer: it allows one to perform a number of comparisons that would not be possible manually, while still following the same principles.

We then implement a method allowing us to determine, as often as possible, which of these conflicting variant locations are genealogical and which are not.

### Representing conflicts.

To represent the conflicts between variant locations, we create a graph  $G = (V, E)$ , where  $V(G)$  is the set of all the conflicting variant locations, and  $E(G)$  the set of all links between these variant locations. A link  $\{u, v\}$  is drawn between two variant locations  $u$  and  $v$  if and only if  $u$  and  $v$  are in conflict with each other. The network is obviously not oriented. We choose not to add any weights in this network, thus assuming that all the conflicts between variant locations are of the same significance. We then implement an algorithm to deduce from this graph  $G$  appropriate variant locations to build our stemma.

**Step 1: isolate the most conflicting variant locations.** Variant locations which are most in conflict with other variant locations can be of two types: some may actually participate in the normal genealogy—the numerous variant locations in conflict with them being non-genealogical. However, most of them should be non-genealogical themselves, containing random parallelisms or contaminated readings, thus hardly of any use to build our stemma. Poole (1979) described this situation with this metaphor: Picture a room full of people, some of them drunk, some of them sober. The drunken one can crash into everybody, while the sober ones will not initiate a crash by themselves; thus, two sober persons will never crash into each other. To define which are the most conflicting variant locations (the probable ‘drunken’ ones), different approaches might be adopted. A simple method would be to define a threshold above which the number of links pointing towards a variant location is such that the variant location is considered ‘over-conflicting’. It is, however, hard to think that there actually exists an absolute number of conflicts that should be considered abnormal. A simple and classic solution would be to set a threshold, not on the degree of a node, but on its degree centrality<sup>13</sup>  $C_i$ , defined as:

<sup>13</sup> In Graph theory, the degree of a node is the number of links (here representing conflicts) drawn between this node and other nodes of the graph.

$$C_i = \frac{deg(u)}{n-1}$$

where  $n$  denotes the number of nodes in the graph  $G$ . Yet, taking into account the number of nodes might not be the best way, as what interests us is not only the number of variant locations, but also how many conflicts there are between them. This is why we chose to set a threshold on another index, computed as follows:

$$C_i = \frac{deg(u)}{e - deg(u)}$$

where  $e$  denotes the total number of conflicts. The threshold, based on the second index, has been chosen here on a heuristic basis.

**Step 2: isolating variant locations in conflict with the over-conflicting variant locations.**

In the second step of our algorithm, we make the obvious assumption that a variant location that is in conflict with the ‘over-conflicting variant locations’ as defined above has reasonable chances to be reliable. This is why we call these variant locations ‘potentially reliable’.

**Step 3. Determining reliable variant locations.**

**3.a. Conflicts between ‘potentially reliable variant locations’.** Since it is impossible to determine if variant locations that are ‘potentially reliable’ but are in conflict with each other are really reliable or not, if two potentially reliable variant locations are in conflict, they are both deleted (fig. 3 left); another possibility is of course to resort to the critical judgement of the philologist and examine these cases individually, if feasible.

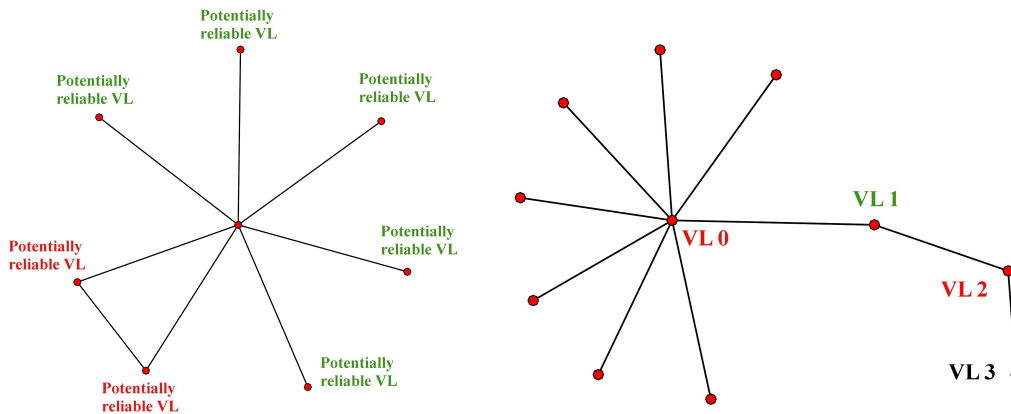

**Figure 3:** Non-assessable variant locations.

**3.b. Path superior or equal to 3.** The nature of a variant location whose minimal path to an over-conflicting variant location is superior or equal to 3 is not assessable (fig. 3 right): a variant location connected to a ‘potentially reliable’ variant location is not reliable. These variant locations have a distance 2 to an over-conflicting variant location; and variant location connected to them may be either reliable or not (being in conflict with a weakly rejected variant location does not help to decide whether a variant location is reliable or not). Again,



these variables shall be either eliminated by the algorithm, or examined individually by the expert.

### *Algorithmic Aggregation method : Benign and severe disagreements*

The aggregation method is based not on agreements, but on disagreements, with an important difference to be made between *benign* and *severe* disagreement between two manuscripts:

1. A benign disagreement is a disagreement between two manuscripts, on two readings of which at least one is a singular reading or an *omission*. This kind of disagreement involving a singular reading does not necessarily signify that one manuscript could not have shared the same model as the other, or that one could not have been copied from the other;
2. A severe disagreement is a disagreement between two manuscripts, on two readings both shared with at least one other manuscript. Since we consider only disagreements, the concurrence of two different readings means that at least one of them is erroneous or innovated and thus constitutes a *Trennfehler* (see above, section 1.1.2, p. 8).

### *Algorithmic Aggregation method : Grouping manuscripts*

To build the stemma, the algorithm goes through the following steps:

1. Manuscripts that have no severe disagreement between each other form a group.
2. For each group a virtual model of it is constituted. For each variant location:
  - (a) if all manuscripts agree on one reading, this reading is assigned to the virtual model.
  - (b) if not:
    - i. if all, except one, are singular readings or omissions (or *lacunae*), the non-singular reading is assigned;
    - ii. if all are singular readings or omissions (or *lacunae*): the reading of the model is not assessable.<sup>14</sup>
3. All manuscripts of the group are then compared to this virtual model:
  - (a) if a manuscript of the group has no benign disagreement with the model, it is the model of the group;
  - (b) if several manuscripts can correspond to the model, there is not enough data to decide;
  - (c) if none can be the model, then the model is outside the group, and the virtual model will be compared in the same fashion to all extant and virtual manuscripts outside the group;

---

<sup>14</sup> We recommend that these cases, very rare from our experience, be systematically examined individually, because they can contain interesting information about the state of the tradition at this level. In some cases, this impossibility of assessing the reading of the model is solved at aggregation step 3(a), if a manuscript of the group is identified with the reconstructed model.

(d) if again none can be the model, then it is assumed that the model is a lost manuscript.

4. Once all groups are formed, child manuscripts (*codices descripti*) are removed, and the algorithm goes back to step one, until the top of the stemma is reached.

Let  $a$  and  $b$  be two different manuscripts,  $L$  a variant location, and  $R$  readings:

$$(\nexists L = \{\{R_a, R_i, \dots\} \{R_b, R_j\}\}) \Rightarrow \{a, b\} \in G \quad (3)$$

$G$  being a group of manuscripts. For this group, to reconstruct the model  $m$  :

$$G = \{a, b, \dots, i\}, j \notin G \quad (4)$$

$$\forall L, R_a = R_b = R_i \Rightarrow R_m = R_a \quad (4)$$

$$\forall L, R_a \neq R_b = R_i \Rightarrow R_m = R_b \quad (5)$$

$$\forall L, R_a \neq R_b \neq R_i, R_a = R_j \Rightarrow R_m = R_a \quad (6)$$

For manuscript  $a$  and model  $m$

$$(\nexists R_a \neq R_m) \Rightarrow a = m \quad (7)$$

### *Algorithmic Aggregation method : Orientation*

The stemma's orientation is obtained through the progressive resolution of severe disagreements and their transformation into benign disagreements, through the *eliminatio codicum descriptorum* to which we proceed at each step as well as the ensuing transformation of some of the common readings into singular readings.

To summarise, two things are necessary to have an orientation, a bottom and a top. The bottom—meaning here the absence of extant descent—is provided by the singular readings: following our definition of benign disagreements, manuscripts with the most singular readings inside each family are likely to be grouped first, and thus provide us with the bottom. This is legitimate since we expect manuscripts to transmit to their descendants at least one of their errors or innovations.

For a manuscript that would directly descend from the original or archetype while still having an important number of singular readings and no extant descent, we can reasonably assume—an assumption equally necessary to traditional stemmatological methods—that it would also have kept some of the original readings, sharing at least one of them with at least one other family while at least one other family does not, the direct result of which would be a severe disagreement that would only be resolved when all the other families have been reduced to their archetype, so that our manuscript would still be grouped in time and at its rightful place.

The top is obtained by the reconstruction of the model of each group and its comparison to the extant manuscripts: a manuscript completely corresponding to the virtual reconstructed model has good chances to be that model—it could also of course be an almost exact copy of it, but in that case the editorial difference would be almost negligible.

As we climb up the branches of the stemma, the amount of data (i.e. the number of disagreements between manuscripts and therefore the number of presumed errors) consequently decreases, and so does the certainty of the orientation and of the links between

manuscripts. This becomes most appreciable at the very top of the stemma, where the number of disagreements (both severe and benign) can be extremely low (hence the necessity to use as much data as possible). Moreover, at the last step, the method will encounter a difficulty if there are three or fewer manuscripts left: with fewer than four manuscripts, it will no longer be possible to use severe disagreements as a way to determine the potential existence of two groups without resorting to a critical judgement on the quality of the readings. It will be the same if the tradition is bipartite—this is of course not particular to our method and is a, perhaps *the*, fundamental stumbling block of the Lachmannian method itself and has been abundantly noted as such, most famously by Bédier 1928 who saw in it sufficient reason to reject the method *en bloc*. As the two manuscripts will have at this stage only singular readings, the parentage of one over the other will be impossible to assess for the algorithm. It is then recommended that, in this case, the decision over the parentage of one over the other, or their sharing a common lost model, be made by the expert, who should probably also consider the possibility of two different redactions of his work by the author.

### *Testing the Method on a fictional modern corpus*

The first tests of the method were done on a database provided by Matthew Spencer and Heather F. Windram (Spencer et al. 2004) for the Computer-Assisted Stemmatology Challenge held in 2009 in Helsinki (Roos and Heikkilä 2009). It consists of 21 copies by volunteer scribes of ‘the first eight paragraphs (834 words, 49 sentences)’ (Spencer et al. 2004, p. 504) of the Middle High German poem *Parzival* by Wolfram von Eschenbach, translated to English by A.T. Hatto (Eschenbach 1980), of which 5 copies were removed. We were thus able to test our method and to compare it to the actual tradition. The network of conflicts between variant locations is represented on fig.4 (for the sake of evaluation by the reader, nodes figuring non-genealogical variant locations are printed in red, nodes figuring genealogical ones in green).

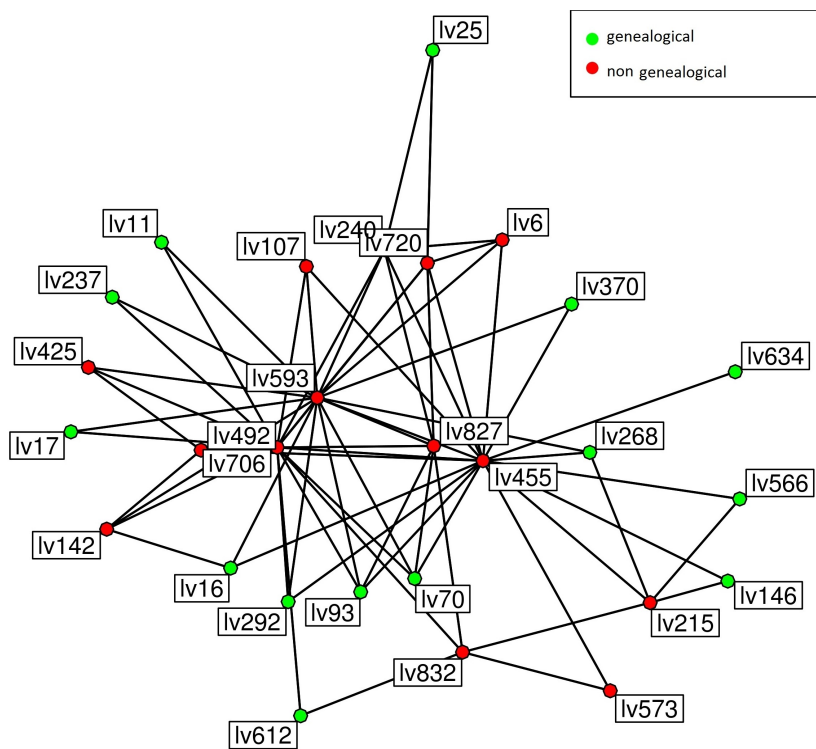

**Figure 4:** Network of conflicts for the *Parzival* test sample<sup>15</sup>.

Our principles led us to keep the truly genealogical variant locations 11, 16, 17, 25, 70, 93, 146, 237, 268, 292, 370, 566, 612, 634 but also the actually non-genealogical 6, 107, 425, 573; and to suppress the truly non-genealogical 142, 215, 240, 455, 492, 593, 706, 720, 827, 832 while suppressing none actually genealogical (24 successes and 4 errors; error rate, 14.29%).

Then, the stemma was constructed and compared to the true stemma (fig. 5, where the original is the central node adjacent to *p9*). The differences concerns manuscripts 2 and 8, and the model of {1,4}

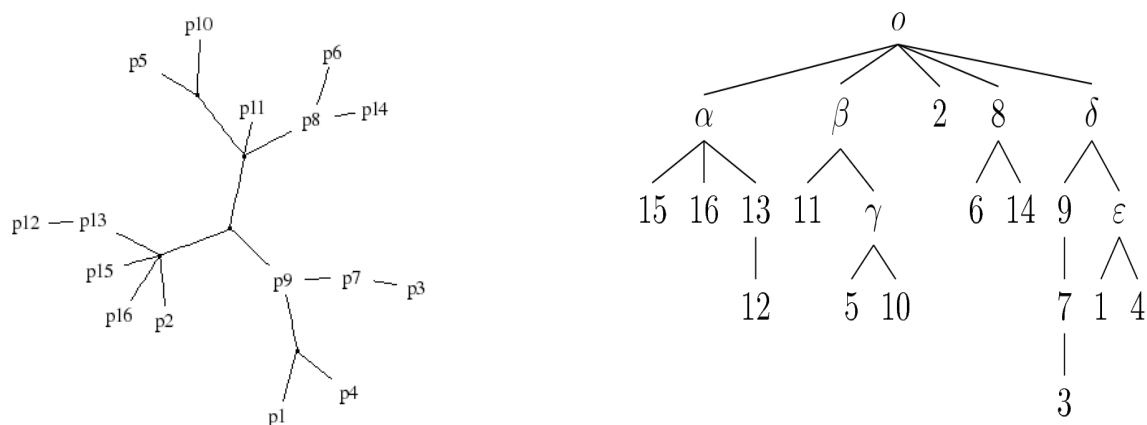

**Figure 5:** True stemma of the corpus (left) and our stemma (right).

<sup>15</sup> In this figure, as well as in fig. 7, the variant locations are named with an arbitrary alphanumeric identifier (the letters 'lv' followed by the order number of the variant location in the database).

### *Testing the Method on a medieval corpus*

Though testing our method on a fictional modern corpus yielded interesting results on its accuracy, and since our method rests heavily on the concept of variation linked to the modalities of production and copy of medieval (vernacular) texts, it was necessary to give it a test in ‘real combat conditions’. Facing the inability to find a medieval tradition of a vernacular romance text whose original or archetype would be known to us—a fact which would have enabled us to judge our accuracy by the editorial results of our stemma—we consequently decided to test it against a quite undisputed stemma produced by a major philologist and chose the edition by Segre (1957) of the *Bestiaires d’Amors* by Richart de Fournival, a XIII<sup>th</sup> century (c. 1250) Picard prose text, of roughly 1,000 lines. Its manuscripts are divided into two groups (according to Segre): manuscripts *IDKOBEAHCJ* deriving from archetype  $\gamma$  in a mostly uncontaminated tradition for which C. Segre drew the stemma on fig. 6; and a group of contaminated manuscripts *FGVMQP* deriving from a second archetype ( $x$ ).

We chose to work on the mostly uncontaminated tradition (manuscripts deriving from  $\gamma$ ), first on a sample from the beginning up to p. 9 of the edition (which makes up 120 potentially genealogical variant locations and roughly 7% of the text)—a sample that proved sufficient to display the more general groupings of the manuscripts but lacked precision inside the  $\alpha$  family), resulting in  $\{\{I, D, K, \{O, B\}\}, \{C, \{A, H\}\}\}$ —before being led to increase the size of our sample, to be able to include manuscripts *E* and *K* (that have long *lacunae* in the beginning of the text), by adding p. 18–30 of the edition (in total up to 20% of the text and almost 300 variant locations).

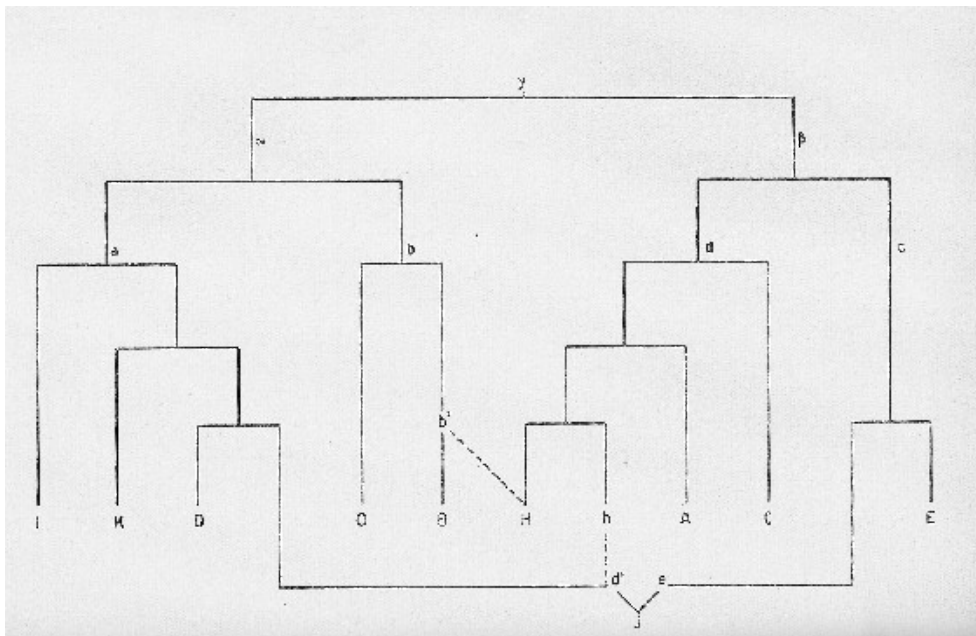

**Figure 6:** Segre’s stemma for the *Bestiaires*<sup>16</sup>.

<sup>16</sup> Richart de Fournival (1957), p. 104.



(1957) in favour of a grouping *IKD OB* (more precisely  $\{\{I, \{K, D\}\}, \{O, B\}\}$ ), before being put forward again by Speroni (1980).<sup>20</sup>

According to which variant location we choose to eliminate, we will find ourselves either with a stemma following the Holmberg-Speroni solution (fig. 8 left)<sup>21</sup> or the Vitte-Segre (fig. 8 right). This choice cannot be made by the algorithm, nor by quantitative criteria, since there is in our sample a strict equivalence of the number of cases. The only option is to submit it to a critical evaluation, and it seems, as it did to Speroni, that the variant location backing *DB(O)* vs. others<sup>22</sup> show less risk of polygenesis than the one backing *DK* vs. others<sup>23</sup>.

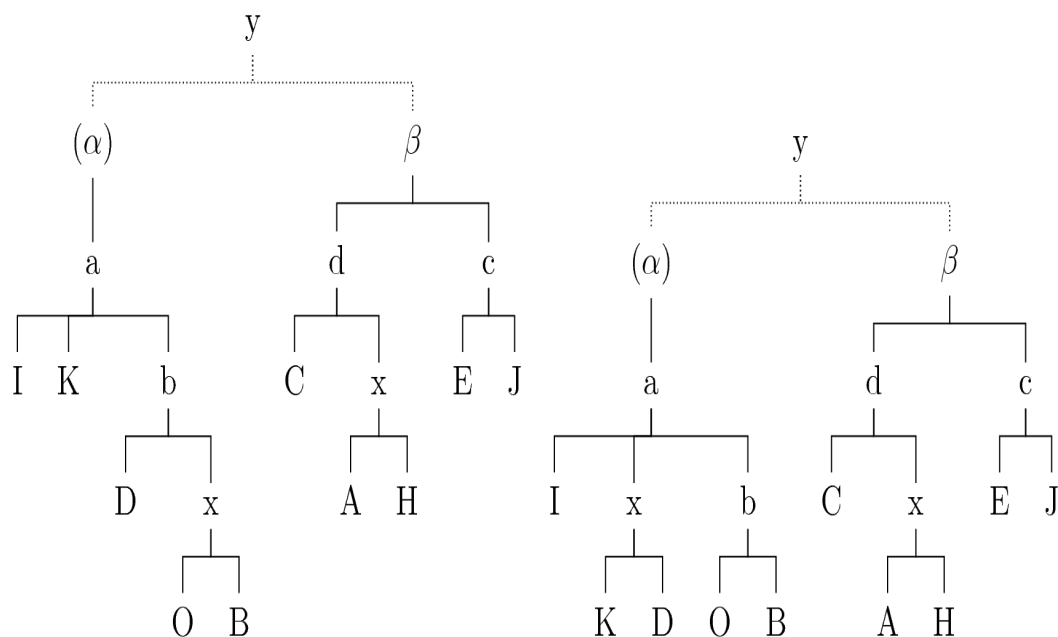

**Figure 8:** Our two stemmata for the *Bestiaires* based on an extended sample.

The placement of *J* together with *E* is consistent with Segre's assessment (1957, p. XCVI) that 'sino a p. 51 *J* s'accorda costantemente con  $\beta$ , mentre da p. 51 in avanti l'accordo è, se non fedelissimo, abbanstaza costante, con  $\alpha$ ', and that *J* descends for its first part from a parent of *E*, and for the second from a parent of *D* contaminated by a parent of *H*<sup>24</sup>.

A more important difference between our stemmata and Segre's concerns the exact relation

20 Speroni (1980, p. 349–352) proposes indeed a return to Holmberg's hypothesis of a *DBO* group, and backs this hypothesis by a cross examination of the readings uniting *DBO* and those uniting *IDK* or *DK*, that he judges more likely to be casual or to go back to  $\alpha$ , and by the study of the newly found MS *W*, which is according to him to be integrated in a *DWOB* group.

21 In our stemmata the dotted lines represent the stage of the aggregation method where a manual intervention was necessary.

22 Variant locations 64 (6,1,6: enpire *DB* ampite *O* ne peire *AHC**IK* missing by material loss *EJ*) and 230 (25,4: es (as *O* en *B*) iex *DOB* maint (et maint *J*) en (el *AH*) cuer others).

23 Variant locations 169 (20,2,3: puist redescaucier *DK* ait deschaussiet *O* puist descauchier others) and 280 (29,2,2: regarder *I* regarder mon malade (malage *D*) *DK* regarder moi malade *BAH* moi regarder *C* moi regarder malade *OEJ* – which, if we do not take inversions into account, opposes *DK* to others, with a lacuna in *I*, and, for the second part in *C*). Both of these two variant locations barely fit into our selection principles and seem to offer stronger possibilities of polygenesis.

24 Despite the erroneous statement (inversion) by Bianciotto 2009, p. 103, that 'La copie *J* a la particularité d'avoir emprunté à deux modèles, d'abord à  $\alpha$  pour un peu moins de la moitié du texte, puis à  $\beta$  dans la suite'.

between *b* and *a* (a relationship that has not yet, to our knowledge, been questioned since<sup>25</sup>). In both instances our sample did not contain any disagreement *a* vs. *bβ* that would have led our algorithm to distinguish *a* and *b* as descendants from the same lost model (Segre's  $\alpha$ ). On the contrary, in both cases, we only had disagreements *b* vs. *aβ*, that did not preclude *a* from being the model for *b*.

It is obvious that, due to the limited size of our sample, our stemmata cannot really be perceived as disagreeing with Segre's. Since we only took into account a 20% sample (as opposed to Segre, who accounted for the full text), we would, in any case, need to extend our database, and to take into account the five manuscripts discovered since 1957<sup>26</sup> before being able to formulate—or not—another hypothesis.

### *Further work*

The next step in improving our method is to find a way to take contamination into account. An obvious way to do this might be to return to the non genealogical variant locations, once the stemma is drawn, and there try to distinguish polygenesis from genuine contamination. This could perhaps be achieved through statistical evaluation: for example, consistent agreements between a manuscript and a family outside its own, verified against a random distribution through various statistical tests. Another improvement, suggested by Poole (1979), could be to reincorporate formerly conflicting variant locations when they cease to be, due to the progressive *eliminatio codicum descriptorum*. Nonetheless, such a procedure, valid in cases of contamination, could prove dangerous in cases of polygenesis—it also falls within the scope of the philological debate about whether a variant location that is obviously in its whole non-genealogical when the totality of the tradition is considered can be attributed meaning in establishing the relationships at another level (inside a single family or at a certain level of the stemma).<sup>27</sup>

Apart from the assessment of contamination, the most important source of improvement to this method would surely be its testing against all sorts of *corpora*, both fictional and medieval, and its systematic comparison to either known true stemma or to the stemma achieved through traditional means.

### *Bibliography*

D'A. S. Avalle (1958), [Review of Segre (1957)], in *Cultura Neolatina*, 18, p. 77–88.

J. Bédier (1928), 'La tradition manuscrite du *Lai de l'ombre* : réflexions sur l'art d'édition des anciens textes', in *Romania*, 54, p. 161–196 and 321–356.

J.A. Bengel (1763), *Apparatus criticus ad Novum Testamentum*, Tubingae.

Richart de Fournival (2009), *Le Bestiaire d'amour et La Response du Bestiaire*, ed. G. Bianciotto, Paris: H. Champion (Champion classiques).

---

25 Even the quite controversial contribution by Ham 1959—mostly disproved by Segre 1961—did not alter it, despite its apparent lack of taste for so-called 'needless complications'.

26 Among these, *W* seems to be close to *D* in a *WDOB* group and *Y* to *H* in the *d* group, Speroni 1980, while *S* and *T* would both belong to the contaminated manuscripts descending from the second archetype *x*, Vitale-Brovarone 1980. A fifth manuscript, called 'T' by Roy 2006 and *R* by Bianciotto 2009, is probably a close parent of *C*, be it either its direct ascendant (for Roy) or not (for Bianciotti).

27 For some elements on this debate, here surrounding the precise case of the *Bestiaire d'Amours*, see the aforementioned contributions by Ham (1959), Segre (1961), and the point of view of Avalle (1958).



- J.-B. Camps (2012), 'Le Scribe face au texte : Regards sur quelques cas de doute et sur des formes de pensée philologique au Moyen Âge', in *Questes*, 23, p. 65–84.
- B. Cerquiglini (1983), 'Éloge de la variante', in *Langages*, 17–69, p. 25–35. Doi: 10.3406/lgge.1983.1140.
- E. C. Colwell (1969), 'Method in Classifying and Evaluating Variant Readings', in *Studies in Methodology in Textual Criticism of the New Testament*, Leiden: Brill (New Testament Tools and Studies, 9), p. 96–105.
- J. Duplacy (1979), 'Préalables philologiques à la classification automatique des états d'un texte', in J. Glenisson, J. Irigoien, R. Marichal et al. (eds), *La Pratique des ordinateurs dans la critique des textes*, Paris: CNRS Éditions, p. 23–33.
- F. Duval (2011), 'Conflit d'interprétations : typologie des facteurs de choix éditoriaux', in *Les enjeux intellectuels des pratiques d'édition (Paris les 4, 5 et 6 mai 2011)*, Paris.
- E. J. Epp (1967), 'The Claremont Profile Method for Grouping New Testament Minuscule Manuscripts', in B. L. Daniels & M. J. Suggs (eds.), *Studies in the History and Text of the New Testament in Honor of K.W. Clark*, Salt Lake City: Univ. of Utah Press, p. 27–38.
- Wolfram von Eschenbach (1980), *Parzival*, trans. A. T. Hatto, New York: Penguin Books.
- G. Fiesoli (2000), *La genesi del lachmannismo*, Firenze: Sismel.
- R. de Fournival (1957), *Li bestiaires d'amours di maistre Richart de Fornival e li response du bestiaire*, ed. C. Segre, Napoli: R. Ricciardi.
- Dom J. Froger (1968), *La critique des textes et son automatisation*, Paris: Dunod (Initiation aux nouveautés de la science).
- E. B. Ham (1959), [Review of Segre (1957)], in *Romance Philology*, 13, p. 461–466.
- L. Havet (1911), *Manuel de critique verbale appliquée aux textes latins*, Paris.
- J. Holmberg (1925), *Eine mittelniederfränkische Übertragung des Bestiaire d'Amour : Sprachlich untersucht und mit altfranzösischem Paralleltex*t, Uppsala: Almqvist & Wiksell (Uppsala universitets årsskrift, 2).
- P. Lejay (1888), [Review of] 'R. Sabbadini, *La Critica del testo del de Officiis di Cicerone e delle poesie Pseudo-Vergiliane secondo due nuove codici*', in *Revue critique d'histoire et de littérature*, 26, p. 281–283.
- (1903), [Review of] 'Aeli Donati quod fertur Commentum Terenti... Recensuit Paulus Wessner', in *Revue critique d'histoire et de littérature*, 56, p. 168–172.
- G. Lozinski (1925), 'Un fragment du Bestiaire d'Amour de Richard de Fournival', in *Romania*, 51, p. 561-568.
- Lucken (2010), 'Les manuscrits du *Bestiaire d'Amours* de Richard de Fournival', in Olivier Collet and Yasmina Foehr-Janssens (eds), *Le Recueil au Moyen Âge. Le Moyen Âge central*, Turnhout: Brepols, p. 113-138.
- P. Maas (1937), 'Leitfehler und stemmatische Typen', in *Byzantinische Zeitschrift*, 37, p. 289–294. DOI: 10.1515/byzs.1937.37. 2.289.
- (1957), *Textkritik 3., verbesserte und vermehrte Auflage*. Leipzig: B.G. Teubner.
- Marguerite d'Angoulême, *La Navire, ou Consolation du roi François Ier à sa soeur Marguerite*, ed. R. Marichal, Paris: H. Champion, 1956 (Bibliothèque de l'École des Hautes études. Sciences historiques et philologiques 306).
- *La coche*, ed. R. Marichal, Genève & Paris: Droz & Minard, 1971 (Textes littéraires français, 173).

Marichal, R. (1979), 'Conclusion', in J. Glenisson, J. Irigoïn, R. Marichal et al. (eds), *La Pratique des ordinateurs dans la critique des textes*. Paris: CNRS Éditions, p. 285–288.

*La vie de saint Alexis: poème du XI<sup>e</sup> siècle et renouvellements des XII<sup>e</sup>, XIII<sup>e</sup>, et XIV<sup>e</sup> siècles publ. avec préfaces, variantes, notes et glossaires*, ed. G. Paris & L. Pannier, Paris: A. Franck, 1872 (Bibliothèque de l'École des hautes études, 7).

G. Pasquali (1934), *Storia della tradizione e critica del testo*. Florence: F. le Monnier.

E. Poole (1974), 'The Computer in Determining Stemmatic Relationships', in *Computers and the Humanities* 8, p. 207–216.

— (1979), 'L'analyse stemmatique des textes documentaires', in J. Glenisson, J. Irigoïn, R. Marichal et al. (eds.), *La Pratique des ordinateurs dans la critique des textes*. Paris: CNRS Éditions, p. 151–161.

M. D. Reeve (1998), 'Shared innovations, dichotomies, and evolution', in Anna Ferrari (ed.), *Filologia classica e filologia romana: esperienze ecdotiche a confronto*, Spoleto, p. 445–505.

*Thomae Magistri sive Theoduli Monachi Ecloga vocum Atticarum*, ed. F. Ritschl, Halle, 1832.

T. Roos & T. Heikkilä (2009), 'Evaluating methods for computer-assisted stemmatology using artificial benchmark data sets', in *Literary and Linguistic Computing*, 24, p. 417–433.

B. Roy (2006), 'Un nouveau manuscrit du Bestiaire d'Amours', in C. Galderisi & J. Maurice (eds.), *Qui tant savoit d'engin et d'art': mélanges de philologie médiévale offerts à Gabriel Bianciotto*. Poitiers: Université de Poitiers, Centre d'études supérieures de civilisation médiévale, p. 205–213.

B. J. P. Salemans (1996), 'Cladistics or the Resurrection of the Method of Lachmann. On Building the Stemma of Yvain', in P. van Reenen & M. J. P. van Mulken (eds.), *Studies in Stemmatology*, Amsterdam: John Benjamins, p. 3–70.

D. C. J. Schlyter & D.H.S. Collins (1827), *Corpus iuris Sueo-Gothorum antiqui...* Stockholm.

U. Schmid (2004), 'Genealogy by chance! On the significance of accidental variation (parallelisms)', in P. van Reenen, A. den Hollander, M. van Mulken et al. (eds.), *Studies in stemmatology II*, Amsterdam : John Benjamins, p. 127–143.

Richart de Fournival (1957), *Li bestiaires d'amours di maistre Richart de Fornival e li response du bestiaire*. ed. C. Segre, Napoli : R. Riociardi.

C. Segre (1961), 'Questions de méthode: à propos du Bestiaire d'amours', in *Romance Philology*, 15, p. 124–129.

— (1976), 'Critique textuelle, théorie des ensembles et diasystème', in *Bulletin de la classe des lettres et des sciences morales et politiques de l'Académie royale de Belgique*, 62, p. 279–292.

— (1979), 'Les transcriptions en tant que diasystèmes', in J. Glenisson, J. Irigoïn, R. Marichal et al. (eds), *La Pratique des ordinateurs dans la critique des textes*. Paris, p. 45–49.

M. Spencer et al. (2004), 'Phylogenetics of artificial manuscripts', in *Journal of theoretical biology*, 227, p. 503–511.

G. B. Speroni (1980), 'Due nuovi testimoni del Bestiaires d'Amours di Richard de Fournival', in *Medioevo Romano*, 7, p. 342–369.

S. Timpanaro (2003), *La genesi del metodo del Lachmann*, 4<sup>th</sup> ed., Torino: Utet Libreria.

A. Varvaro (1970), 'Critica dei testi classica e romana, problemi comuni ed esperienze diverse', in *Rendiconti della Accademia di Archeologia Lettere e Belle Arti*, 45, p. 73–117.

A. Vitale-Brovarone (1980), 'Un testimone sconosciuto ed uno recuperato del Bestiaire d'Amours', in *Medioevo Romano*, 7, p. 370–401.

S. Vitte (1929), 'Richard de Fournival. Étude sur sa vie et ses œuvres suivie de l'édition du

bestiaire d'amour, de la Réponse de la Dame et des Chansons' (thèse pour le dipl. d'arch. paléogr., non publiée, Paris: École nationale des chartes).

M. Weitzman (1985), 'The Analysis of Open Traditions', in *Studies in Bibliography*, 38, p. 82–120.

Cicero (1831), *Ciceronis Verrinarum libri VII*, ed. C. T. Zumpt, Berlin.

P. Zumthor (1972), *Essai de poétique médiévale*, Paris: Éditions du Seuil (Poétique, 4).

## Appendix

### The manuscripts of Richart de Fournival, *Li Bestiaires d'Amours*<sup>28</sup>

**A** : Paris, BnF, fr. 25566 (*olim* 72 ; La Vallière 81 ; Debure 2736 ; anc. petit fonds 2736)

**B** : Paris, BnF, fr. 412 (*olim* Lancelot 9 ; Lancelot 125 ; Regius 7019<sup>3</sup>)

**C** : Paris, BnF, fr. 12786 (*olim* suppl. fr. 319)

**D** : Paris, BnF, fr. 12469 (*olim* suppl. fr. 540,1)

**E** : Paris, BnF, fr. 1444 (*olim* B 23 ; ancien fonds 7534)

**F** : Paris, BnF, fr. 24406 (*olim* La Vallière 59 ; ancien petit fonds 2719)

**G** : Paris, BnF, fr. 15213 (*olim* 3579 ; suppl. fr. 766)

**H** : Dijon, Bibl. Municipale, MS 526 (*olim* Collège des Godran, 299)

**I** : Paris, Bibl. Sainte-Geneviève, MS 2200 (*olim* N. 7 ; B. b. 2 ; 41 ; R. l. in-4°. 17)

**J** : Arras, Bibl. Municipale, MS 139(657) (*olim* Bibliothecæ monasterii Sancti Vedasti Atrebatensis, 1628. K. 2.)

**K** : Bruxelles, KBR, 10394-414

**L** : London, BL, Harley MS 273

**M** : New York, Pierpont Morgan Library, MS M.459

**O** : Oxford, Bodleian Library, MS Douce 308

**P** : Firenze, Biblioteca Mediceo-Laurenziana, Plut. LXXVI, 79

**Q** : Firenze, Biblioteca Mediceo-Laurenziana, Ashb. 123 (*olim* Libri 50)

**R** : Switzerland, private collection (manuscript *T* for Roy 2006)

**S** : Genève, Bibl. publique et universitaire, *Comites latentes* 179

**T** : Torino, Biblioteca Nazionale, L.III.22

**V** : Wien, ÖNB, cod. 2609

**W** : Milano, Biblioteca Ambrosiana, cod. I. 78 sup.

**Y** : Milano, Biblioteca Braidense AC.X. 10

**p** : Saint-Petersbourg, private coll. Likhatchev as of 1925 (one leaf fragment of 46 lines found in a binding, transcribed in Lozinski 1925)

---

<sup>28</sup> For a description of these manuscripts, see Richart de Fournival (1957), particularly '*I manoscritti*', p. XXXIII-LXV, to be updated concerning *RSTWY* by Speroni (1980), Vitale-Brovarone (1980), Roy (2006), Richart de Fournival (2009) and Lucken (2010); for the *p* fragment, see Lozinski (1925).