



HAL
open science

French-Ethiopian Archaeological Mission in Eastern Tigray (Ethiopia). Report on the 2020 season. The Region of Wolwalo.

Anne Benoist, Iwona Gajda, Jérémie Schiettecatte, Daa Albukaai, Rozan Alkhatib-Alkontar, Ninon Blond, Marie-Belean Dhorne, Hugo Reiller, Gauthier Tavernier, Julie Bouvot, et al.

► To cite this version:

Anne Benoist, Iwona Gajda, Jérémie Schiettecatte, Daa Albukaai, Rozan Alkhatib-Alkontar, et al.. French-Ethiopian Archaeological Mission in Eastern Tigray (Ethiopia). Report on the 2020 season. The Region of Wolwalo.. [Research Report] CNRS; Université Lyon 2; Université de Strasbourg. 2020. halshs-02954201

HAL Id: halshs-02954201

<https://shs.hal.science/halshs-02954201v1>

Submitted on 30 Sep 2020

HAL is a multi-disciplinary open access archive for the deposit and dissemination of scientific research documents, whether they are published or not. The documents may come from teaching and research institutions in France or abroad, or from public or private research centers.

L'archive ouverte pluridisciplinaire **HAL**, est destinée au dépôt et à la diffusion de documents scientifiques de niveau recherche, publiés ou non, émanant des établissements d'enseignement et de recherche français ou étrangers, des laboratoires publics ou privés.



Distributed under a Creative Commons Attribution - NonCommercial - NoDerivatives 4.0 International License

FRENCH-ETHIOPIAN ARCHAEOLOGICAL MISSION IN EASTERN TIGRAY

- ETHIOPIA -

REPORT ON THE 2020 SEASON

THE REGION OF WOLWALO

Directed by Anne Benoist, Iwona Gajda & Jérémie Schiettecatte

With contributions by

Diaa Albukaai, Rozan al-Khatib Alkontar, Anne Benoist, Ninon
Blond, Marie-Belean Dhorne, Hugo Reiller, Jérémie Schiettecatte
and Gauthier Tavernier

Drawings by Julie Bouvot & Maria Gorea



**FRENCH-ETHIOPIAN ARCHAEOLOGICAL MISSION
IN EASTERN TIGRAY
- ETHIOPIA -**

**REPORT ON THE 2020 SEASON
THE REGION OF WOLWALO
25 FEBRUARY - 22 MARCH**

Directed by Anne Benoist, Iwona Gajda & Jérémie Schiettecatte

With contributions by

Diaa Albucaai, Rozan al-Khatib Alkontar, Anne Benoist, Ninon
Blond, Marie-Belean Dhome, Hugo Reiller, Jérémie Schiettecatte
and Gauthier Tavernier

Drawings by Julie Bouvot & Maria Gorea



Paris - Lyon
2020

Introduction	7
Location and history of the mission.....	7
Aim of the 2020 field season	8
Working conditions and accommodation	9
The consequences of the sanitary crisis (Covid-19).....	9
Team	10
Support	10
REGIONAL SURVEY IN THE WOLWALO AREA	11
Archaeological survey of the Wolwalo plateau, south-eastern quarter	13
Schedule & team.....	13
Objective	13
Methodology	13
Sites surveyed in the South-Eastern quarter of the Wolwalo plateau	16
Preliminary remarks.....	32
References	34
Geomorphological survey of the Wolwalo plateau	35
Aim and schedule	35
Geographical and geomorphological surveys.....	35
Sampling.....	36
Main observations	37
Perspectives.....	40
References	41
THE ARCHAEOLOGICAL SITE OF GRA EMNI IN THE WOLWALO AREA	43
Gra Emni (SAZ 249) - Topography of the site.....	45
Topographic setting.....	45
Map of Gra Emni (SAZ 249)	45
Extent and relief of Gra Emni (SAZ 249)	48
Setting up the limits of the excavated areas.....	49
Drawing the plans of the soundings and excavated structures	50
Geophysical survey of Gra Emni (SAZ 249) and Waragena (SAZ 256 & 266)	53
Introduction	53
Material and metrology.....	53
Gra Emni (SAZ 249).....	54
Comparison between magnetic data and archaeological excavations	67
Modelling	72
Waragena (SAZ 256 and 266).....	80
General Conclusions.....	84
Gra Emni (SAZ 249) - Excavation of the site.....	85
Aim and schedule	85
Trench 1	87
Trench 2	87
Trench 3	97
Trench 4	98
Trench 5	107
Reference	109
Gra Emni (SAZ 249) - The pottery from Trenches 1, 2, 4 and 5	119
Introduction	119
The pre-Aksumite pottery from Trench 5.....	119
The late Aksumite pottery from Trenches 1, 2 and 4	120
Conclusion	132
References	133

INTRODUCTION

Location and history of the mission

Since 2011, the French-Ethiopian Archaeological Mission in Eastern Tigray (MAFTOr in French) has been carrying out archaeological and epigraphic researches in the Tigray region, Ethiopia, focusing on ancient occupation, from the pre-Aksumite to the late Aksumite period (7th century BCE–9th century CE).

Located 60 km north-east of Wuqro, and east of Edaga Hamus, the research area encompasses a high plateau at an altitude of c. 2800 m a.s.l. bordered to the east by a mountainous area sloping down eastwards to the Danakil depression, thus forming a natural barrier between the plateau and the Red Sea (figs. 1-2).

Between 2012 and 2014, the Aksumite settlement at Wakarida was excavated. It revealed several Aksumite buildings dated to the 4th–7th centuries CE. Systematic field survey was carried out around the main site over an area of 10 × 8 km. Several sites revealed pottery similar to that from Wakarida, suggesting a comparable date. Together these helped to delineate the territorial extent of an Aksumite urban settlement across the area.

Other sites, however, revealed a different, seemingly older pottery assemblage. These sites were scattered across the landscape, mostly in the southern part of the surveyed area, along the May Wayni valley, which

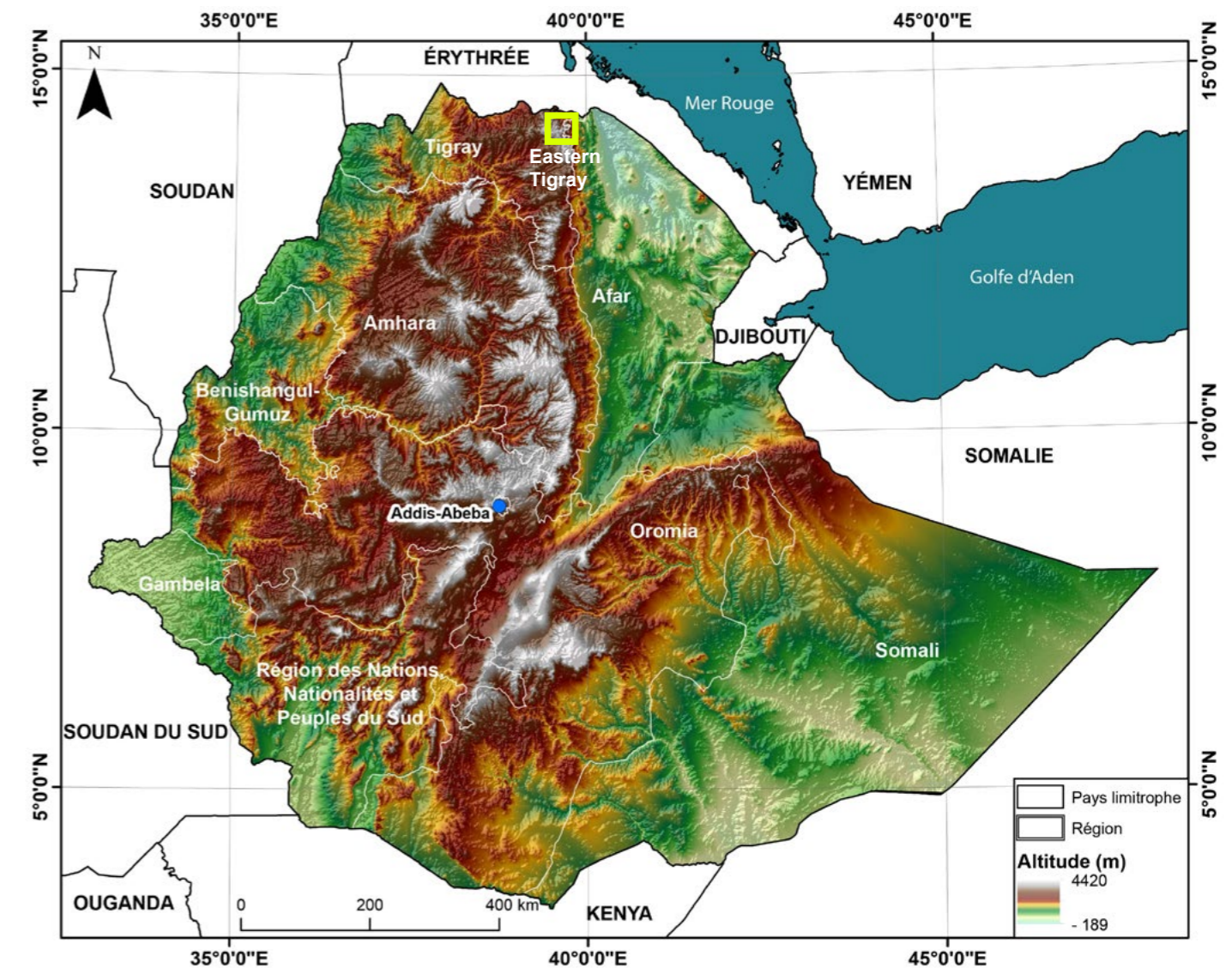

Figure 1 - Location of the research area (rectangle at the top), in the northern fringes of Ethiopia (N. Blond - MAFTOr).

is the most accessible area from the Tigray Plateau, and to a lesser extent in the Ka'ebile. In 2015 and 2017, test excavations were undertaken on three of these pre-Aksumite sites: Armengela, Mangagebit and Alakile Daga (fig. 2).

8 Since 2017, the surveyed area was widened westward, on the plateau, around the modern village of Wolwalo (fig. 2). The survey was pursued in this area in 2018 and a trench was excavated at Sebdera, south of Wolwalo, yielding the first evidence of a post-Aksumite occupation (7th–9th century CE). Resuming our field activity in the Wolwalo area offered good prospects of completing the archaeological map of the region, to understand the settlement process, and to highlight the yet poorly known post-Aksumite period.

Aim of the 2020 field season

The main purpose of this season's work was to characterise the area of Wolwalo, where a group of archaeological sites had been identified during the two previous seasons (see 2017 and 2018 reports), leading us to consider the possibility of the presence of an antique town in this area. This antique town is marked by several surface concentrations of pottery often associated to visible remains (walls, buildings, graves). The surface pottery is rather homogenous, but distinct from the one at Wakarida. A first trial trench carried out in 2018 allowed us to obtain a ¹⁴C dating of this pottery assemblage between the 7th and the 9th century CE. This period

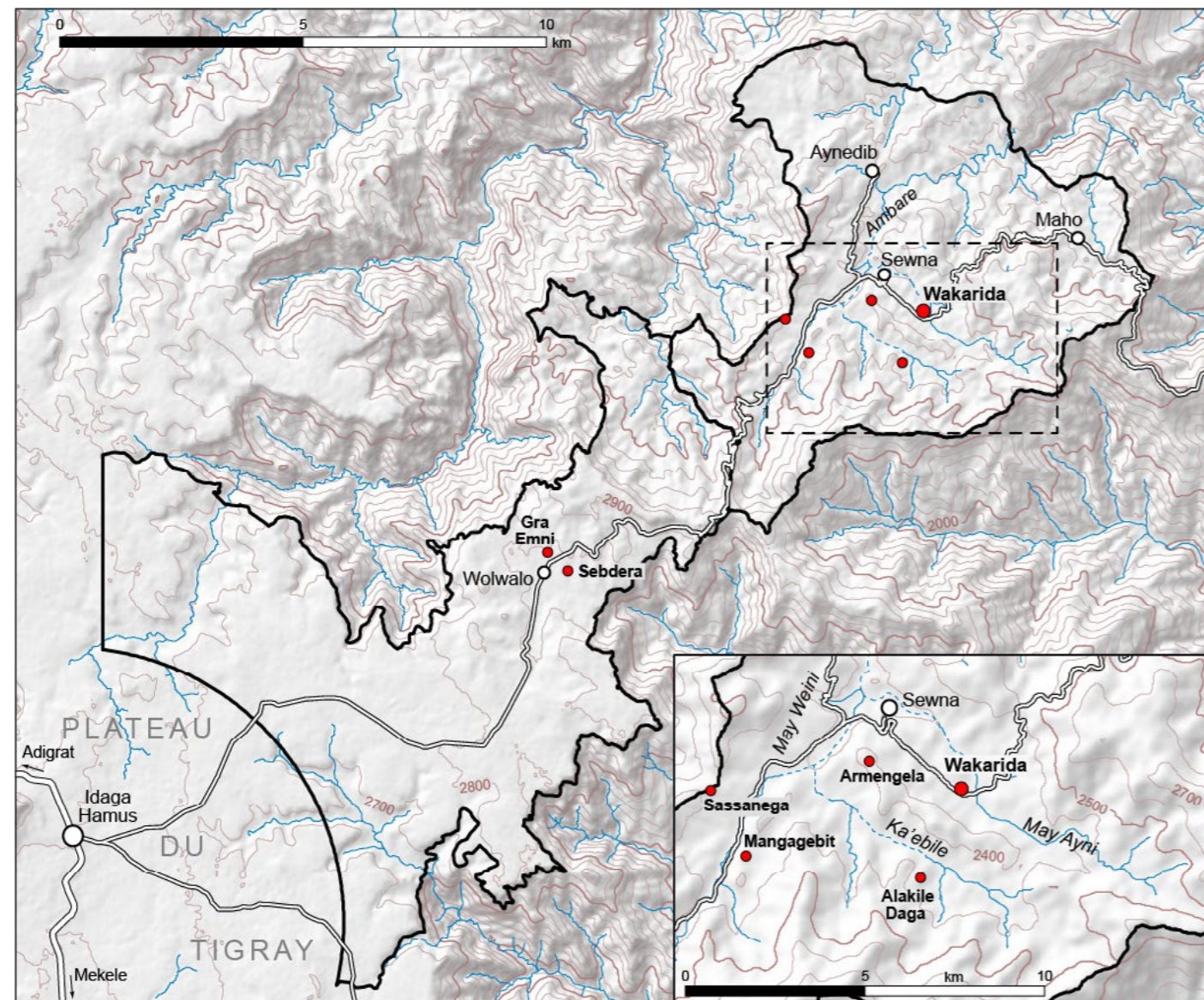

Figure 2 - The French-Ethiopian research area in the Eastern Tigray. Excavated areas in red (O. Barge - MAFTOr).

marks the fall of the kingdom of Aksum. Since it remains scarcely documented, it prompted us to investigate the area.

Four axes of research were simultaneously conducted during this season's fieldwork:

- The survey of the Wolwalo area was completed in the south-east quarter of the plateau (J. Schiettecatte).
- An environmental study of the plateau of Wolwalo was initiated through a geomorphological survey (N. Blond).
- A geophysical survey was conducted in the area of Gra Emni, north of Wolwalo, which was thought to be the potential ancient urban centre in the area (R. Al-Khatib Alkontar & H. Reiller).
- Excavations were conducted in the area of Gra Emni to determine its archaeological potential and complete the pottery assemblage (D. Albucaai, M.-B. Dhorne & G. Tavernier).

Besides, the pottery material was studied by Anne Benoist, photographed by J. Schiettecatte, and drawn by M. Gorea & J. Bouvot.

Working conditions and accommodation

The *Centre Français des Études Éthiopiennes* (CFEE) in Addis Ababa provided a valuable assistance to the mission by facilitating administration and contacts with the Ethiopian authorities. It rented two cars to the mission and provided us with an electrical generator as well as a part of the camping material.

As during the previous seasons, some of our equipment was kindly provided by two CNRS laboratories: UMR 8167 (photo camera, satellite phone, D-GPS), and UMR 5133 (photo and video equipment).

The French archaeological mission was accommodated in tents spread around a traditional house, which was rented as workroom. The camp was initially set on the site of Wakarida. After a few days we moved for practical reasons to a farm located in the area of Wolwalo (fig. 3).



Figure 3 - Tent camp at Wolwalo, Sebdera area (G. Tavernier - MAFTOr).

The consequences of the sanitary crisis (Covid-19)

The worldwide health crisis (Covid-19 pandemic) had two direct consequences on our activities:

- 1/ Several members of the team were not able to join us.
- 2/ The fieldwork was aborted on the 16th of March 2020, i.e. 12 days before the planned closure. The excavation trenches were promptly filled up and the artefacts stored in the Saesie Tsaeda Emba Culture and Tourism Office, Freweyni, Tigray, accordingly to the recommendations of the Ethiopian authorities.

The study and registering of the material were not fully achieved. Neither were the survey of the plateau and the excavation of Trench 4 at Gra Emni.

Team

European Part

- Diaa ALBUKAAI (UMR 5133 Archéorient, Lyon) – Archaeologist
- Rozan ALKHATIB ALKONTAR (University of Strasbourg, UMR 7516 IPGS-EOST) – Geophysicist
- Anne BENOIST (CNRS, UMR 5133 Archéorient, Lyon) – Archaeologist, codirector
- Ninon BLOND (University of Lyon 2, UMR 5133 Archéorient, Lyon) – Geomorphologist
- Julie BOUVOT – Draughtsman
- Marie-Belean DHORNE (PhD student, University of Lyon 2) – Archaeologist
- Maria GOREA (University of Paris 8, UMR 8167 Orient & Méditerranée, Paris) – Draughtsman
- Hugo REILLER (CNRS, UMR 7516 IPGS-EOST, Strasbourg) – Geophysicist
- Jérémie SCHIETTECATTE (CNRS, UMR 8167 Orient & Méditerranée, Paris) – Archaeologist
- Gauthier TAVERNIER – Archaeologist

European Part (unable to reach the field due to the Covid-19 lockdown)

- Michele DEGLI ESPOSTI – Archaeologist
- Iwona GAJDA (CNRS, UMR 8167 Orient & Méditerranée, Paris) – Historian, codirector
- Mathilde KANIA – Draughtsman
- Emmanuelle VILA (CNRS, UMR 5133 Archéorient, Lyon) – Archaeozoologist

Ethiopian Part (Scientific team)

- Beruk JIFARA (ARCCH, Addis-Ababa) – ARCCH representative
- Guesh TSEHAYE (TCTB, Mekele) – TCTB representative
- Kibrom GEBREGERGIS (Saesie Tsaeda Emba Culture and Tourism Office, Freweyni) – Archaeologist
- Desta HAILEYESUS (University of Mekele) – Archaeologist
- Gebretsadkan MULUBRHAN DESTA (University of Adigrat) – Archaeologist

Ethiopian Part (Logistics)

- Semene BACHA (CFEE, Addis Ababa) – Driver
- Ayoub GODANA (CFEE, Addis Ababa) – Cook
- Temachache YIFRU (CFEE, Addis Ababa) – Driver
- Godana YOHANNES (CFEE, Addis Ababa) – Cook

Support

Several institutions contributed by their technical, logistics, administrative and human support to the field activities:

- the ARCCH - Authority for Research and Conservation of Cultural Heritage, Addis Ababa
- the CFEE - Centre Français d'Études Éthiopiennes, Addis Ababa
- the IPGS - Institut de physique du globe de Strasbourg - UMR 7516, Strasbourg
- the SCAC at the French Embassy in Ethiopia, Addis Ababa
- the TCTB - Tigray Culture and Tourism Bureau, Mekele
- the University of Adigrat
- the University of Lyon 2

Our field activities were funded by:

- the French Ministry of Europe and Foreign Affairs, Paris
- the CNRS, UMR 8167 Orient & Méditerranée in Paris and UMR 5133 Archéorient in Lyon
- the Foundation Simone et Cino Del Duca, Paris

We would like to thank all the above-mentioned institutions most warmly for their support as well as all the people who put their trust in our work and did their best to make fieldwork possible and easier in Addis Ababa and Paris.

REGIONAL SURVEY IN THE WOLWALO AREA

ARCHAEOLOGICAL SURVEY OF THE WOLWALO PLATEAU, SOUTH-EASTERN QUARTER

Jérémie SCHIETTECATTE (CNRS, UMR 8167 Orient & Méditerranée)

Schedule & team

The archaeological survey of the Wolwalo region was carried out during 4 working days between 5 and 11 March, 2020. The survey was slowed down by the delay to reach the field, the relocation of the camp from Wakarida to Wolwalo, and the early departure due to sanitary issue (Covid-19).

Olivier Barge (CNRS, Jalès), in charge of the survey during the 2012-17 field seasons, was not able to join the team. Like in 2018, it was therefore carried out by Jérémie Schiettecatte (CNRS, Ivry-sur-Seine). He was accompanied by Kibrom Gebregergis (TCTB, Freweyni), archaeologist and interpreter, and Ninon Blond (Univ. Lyon 2), geomorphologist.

Objective

For many years, the main objective of the archaeological survey has been to document, date and study the distribution of the archaeological sites located around the main Aksumite settlements of Wakarida and Wolwalo, as well as in the area between these two settlements.

Wakarida is a middle-late Aksumite settlement located in a valley at c. 2 350 m while Wolwalo is mainly a late Aksumite group of settlements located on a high plateau at c. 2 800 m. They are separated by the pass of Waragena (c. 2 850 m). The settlement pattern and chronology of the two areas differ. Therefore, a detailed cover of the territory between these two sites may highlight the impact of the natural environment and cultural context on the settlement process in the Eastern Tigray highlands and the surrounding valleys.

A secondary objective is to draw a detailed archaeological map of the Wolwalo plateau and to characterise at the same time the very nature of the settlement pattern (centralized vs. fragmented).

If the systematic survey of the Wakarida and Waragena areas is close to achievement, it is not the case of the Wolwalo area for which several parts of the map are still left blank. After a first extensive cover by Olivier Barge (2017) and an intensive survey of the northern half of the Wolwalo plateau by Jérémie Schiettecatte (2018), the purpose of the 2020 survey was to explore the southern half of the Wolwalo plateau. Because of time restrictions, only the south-eastern quarter was surveyed.

Methodology

The devices used during the survey were:

- Hand GPS Garmin Etrex Summit (accuracy c. 5 to 10 m)
- Camera Canon EOS 7D Mark II with an embedded GPS (accuracy c. 2 to 5 m)

The location of the sites was documented with these devices and accordingly to the limitation of their accuracy (GPS coordinates acquired in what was considered as the central part of a site). The extent of the site was assumed according to the distribution of surface material and described with the help of geographical and anthropic features to permit its accurate determination on satellite imagery during a post-fieldwork stage (to be processed in the office).

The sites were systematically:

- Located (geographic coordinates)
- Photographed (general view, detailed view)

- Described (location, place name, structures, artefacts, current owner)
- Sampled (surface sampling of pottery and obsidian).

A registration system was implemented:

- Pictures were processed in Adobe Bridge: metadata were systematically implemented in every picture file (coordinates, altitude, credits, description, keywords).
- Site description was processed on a FileMaker Pro card (fig. 1).

On the field, the aim was to survey in a systematic and regular way the south-eastern part of the Wolwalo plateau, where only four sites were previously located by Olivier Barge.

The plateau is peppered with hills of various heights. We systematically explored every hilltop and its surroundings. Local farmers were interviewed by Kibrom Gebregergis in Tigrinya and Jérémie Schiettecatte in Arabic to document place names, local legends, and report the potential presence of sites worth being noticed.

In four days, 13 new sites were registered in the south-eastern quarter of the Wolwalo plateau (SAZ 313 to SAZ 329; SAZ = Surveyed Archaeological Zone). Besides, four sites already located in 2017 were visited again and received additional documentation (description, photographs, sampling of potsherds). These are SAZ 313 [= SAZ 273], SAZ 318 [= SAZ 254], SAZ 319 [= SAZ 268], and SAZ 325 [= SAZ 274] (figs. 2-3).

FRENCH ARCHAEOLOGICAL MISSION IN EASTERN TIGRAY		ARCHAEOLOGICAL SITES	
N°	Saz 319	Name of the site	Hawuli Michael
Date of the visite	07/03/2020	Latitude N [WGS 84]	14,2282
Longitude E [WGS 84]	39,662749	Altitude [m a.s.l.]	2765
<p>CHRONOLOGY</p> <input checked="" type="checkbox"/> Indeterminate <input type="checkbox"/> Prehistory <input type="checkbox"/> Pre-Aksumite <input type="checkbox"/> Proto-Aksumite <input type="checkbox"/> Classical Aksumite <input type="checkbox"/> Middle Aksumite <input type="checkbox"/> Late Aksumite <input type="checkbox"/> Post Aksumite <input type="checkbox"/> Recent			
<p>REMAINS</p> <input type="checkbox"/> Complete building <input checked="" type="checkbox"/> Double-face wall <input type="checkbox"/> Terrace wall <input type="checkbox"/> Indeterminate wall <input type="checkbox"/> Cistern/wells <input type="checkbox"/> Mine <input type="checkbox"/> Smelting place <input type="checkbox"/> Workshop <input type="checkbox"/> Church <input type="checkbox"/> Isolated tomb <input checked="" type="checkbox"/> Necropolis <input type="checkbox"/> Stone quarry <input type="checkbox"/> Lithic workshop <input type="checkbox"/> Other			
<p>ARTEFACTS</p> <input checked="" type="checkbox"/> Pottery <input type="checkbox"/> Obsidian <input type="checkbox"/> Iron slag <input checked="" type="checkbox"/> Grinding tool <input checked="" type="checkbox"/> Other stone tool <input type="checkbox"/> Earthenware polisher <input type="checkbox"/> Figurine <input type="checkbox"/> Coin <input type="checkbox"/> Metal artefact <input type="checkbox"/> Carved stones <input type="checkbox"/> Other			
<p>BUILDING MATERIAL</p> <input checked="" type="checkbox"/> Small stones (<20cm) <input checked="" type="checkbox"/> Medium stones (20-40cm) <input type="checkbox"/> Large stones (>40) <input type="checkbox"/> Mixed			
<p>DESCRIPTION</p> <p>Identical to SAZ 268</p> <p>In the South-Eastern part of the plateau of Wolwalo, South of the Beri river, on several successive agricultural terraces immediately to the south of the church Hawuli Michael.</p> <p>Very high density of pottery sherds on the surface of several agricultural terraces belonging to 3 land owners : - Tesfay Agus - Tehleaymanat Lema - Gebre Meskel Lama</p> <p>The second came along for the visit of the site. He mentioned the presence of several walls buried in the ground ; two walls are visible (one in a section of a terrace, the second is outcropping on the ground).</p> <p>On the surface, sampling or photographs of : many pottery sherds, 1 slag, several millstone fragments, stone tool, steatite vessel.</p> <p>To the south, Tehleaymanat Lema mentioned that he personally excavated 9 graves : individual graves with no deposits. 9 skeletons were excavated, all being adults. The covering slabs of schists were reused on the roof of his farm.</p> <p>Pottery: high density</p>			

Figure 1: Screenshot of the FileMakerPro site card

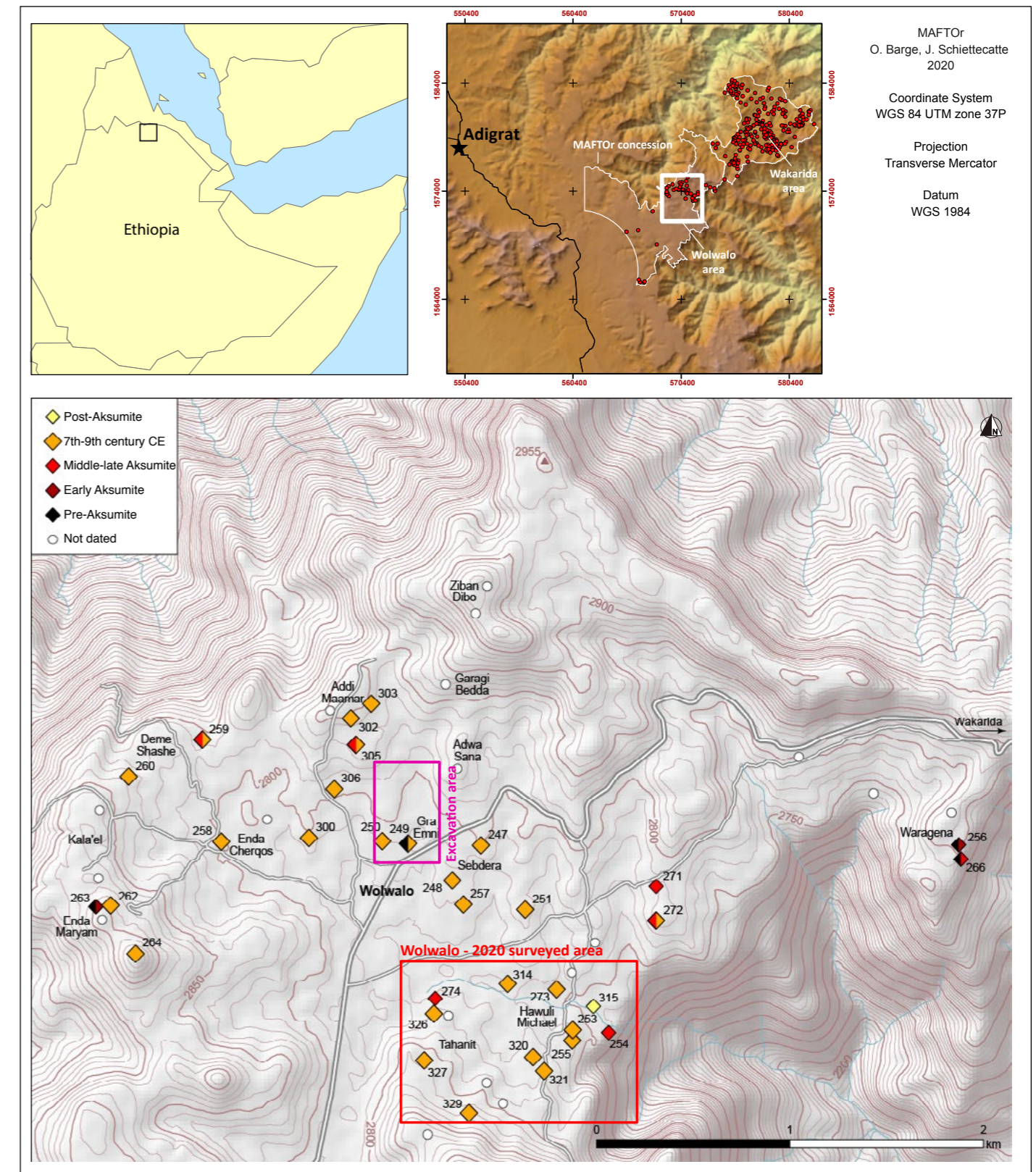

Figure 2: Map of the 2020 survey in the south-eastern part of the Wolwalo plateau (O. Barge, J. Schiettecatte - MAFTOr).



Figure 3: Panoramic view of the Wolwalo plateau and location of sites surveyed in 2020, looking north (J. Schiettecatte - MAFTOr).

Sites surveyed in the south-eastern quarter of the Wolwalo plateau

SAZ 313 [= SAZ 273] – Hawuli Michael NE

- Date of visit: 05/03/2020
- Coordinates: 14.230806°N - 39.662126°E
- Altitude: 2 762m
- Remains: indeterminate wall
- Artefacts: pottery
- Pottery density: high
- Building material: small stones (< 20 cm); medium stones (20-40 cm)
- Date: late and post-Aksumite period. The red and black pot suggests an earlier occupation, to be confirmed.

Description: In the central part of the plateau of Wolwalo, on the slope bordering the northern side of the Berih thalweg; rocky outcrop with several buildings of the farm of Enda Haleka Hadequ surrounded by agricultural terraces. The site stretches on the ground of the farm on a length of c. 30 to 40 m. The density of potsherds rapidly decreases on the surrounding agricultural terraces.

On the ground, an ancient wall is outcropping. The surface ground is densely covered with potsherds. The farm owner showed us a complete small hole-mouth jar with a brown burnished slip, blackened at the top and on its inner side (fig. 4). Red brown black topped wares are described in many pre-Aksumite assemblages (e.g. Phillips, 2000) and form a part of the pre and late pre-Aksumite potteries from the region of Wakarida (Benoist *et al.* 2020). But vessels with a reddish slip partly blackened are also recorded in small quantities at Wakarida during the middle Aksumite period. The pottery also includes two fragments of large common ware basins with impressions on the inside (Group 22: WK4651 and 4652), a common ware globular bowl (Group 21: WK4649) with a black band painted on the inside of the rim, and an everted rim of a large storage jar, with a banded rim (WK4650). These types are characteristic of the late and post-Aksumite potteries from excavated contexts in Gra Emni (SAZ 249) and Sebdera (SAZ 248).



Figure 4: SAZ 313 Hawuli Michael NE: Brown burnished hole-mouth jar (MAFTOr – J. Schiettecatte).

SAZ 314 – Hawuli Michael NW

- Date of visit: 05/03/2020
- Coordinates: 14.230966°N - 39.659902°E
- Altitude: 2 766m
- Remains: none
- Artefacts: pottery; stone tools
- Pottery density: low
- Date: Aksumite period, likely middle and late and post-Aksumite

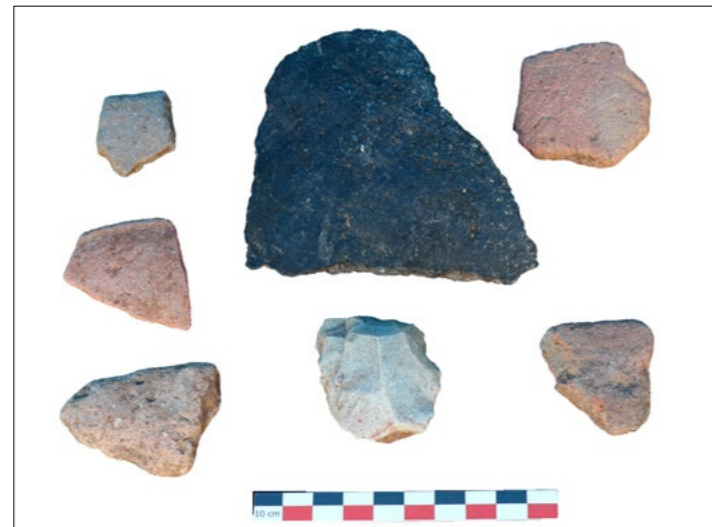

Figure 5: SAZ 314 Hawuli Michael NW: Surface potsherds and stone flake (MAFTOr – J. Schiettecatte).

Description: In the central part of the plateau of Wolwalo, on the slope bordering the northern side of the Berih thalweg, on three successive agricultural terraces; low density spread of potsherds (fig. 5). The site extends over c. 50 m wide; it is c. 250 m west of SAZ 313 (Hawuli Michael East).

Surface pottery is not very characteristic. A fragment of black ware is probably of modern date. A fragment of a possible basin with a small ledge rim could indicate a middle or late and post-Aksumite date.

SAZ 315 – Berih River

- Date of visit: 07/03/2020
- Coordinates: 14.229897°N - 39.664°E
- Altitude: 2 744 m
- Remains: none
- Artefacts: pottery, obsidian
- Pottery density: very low
- Building material: small stones (< 20 cm)
- Date: no diagnostic potsherd

Description: Along the bed of the Berih river, on the left and right banks, natural sections of sediment incised by the water course. The accumulation is up to 2 m high (fig. 6). It is disturbed by deep and thick tree roots. In the sedimentary sections, presence of rounded sherds (heavy weathering), small stone blocks, few charcoals, an obsidian flake. These are likely intrusive due to gravity along the slopes overlooking the river banks.

SAZ 316 – Meheva' Tabwot North

- Date of visit: 07/03/2020
- Coordinates: 14.228978°N - 39.665215°E
- Altitude: 2 739 m
- Remains: isolated tomb
- Artefacts: pottery
- Pottery density: medium
- Date: Aksumite period, likely late and post-Aksumite

Description: Meheva' Tabwot North is located at the outlet of the Berih river, south-east of the plateau of Wolwalo, at the border of the Afar region. On the right bank of the watercourse, a limestone cliff overlooks the river. Steps are hewn in the rock and three small caves are walled with small to medium stones (fig. 7). They are graves for former populations. These funerary practices are no more in use.

While climbing the steep cliff of the right bank along a built path, up to the plateau, sampling of numerous



Figure 6: SAZ 315 Berih River: Bioturbated sediment along the river bank (MAFTOr – J. Schiettecatte).



Figure 7: SAZ 316 Meheva' Tabwot North: Burials in the cliff (MAFTOr – J. Schiettecatte).

sherds on the slope. They are probably coming from the upper part of the plateau. Up the plateau, very little pottery material on the ground.

Potsherds (fig. 8) include common Aksumite ware (groups 3, 5, possibly 21 and 22) including several fragments of basins with everted or thickened rim. They seem to include an example of a possibly badly preserved fragment of pottery from group 21 with a red painted band on top of the rim.



Figure 8: SAZ 316 Meheva' Tabwot North: Surface potsherds on the slope (MAFTOr – J. Schiettecatte).

SAZ 317 – Meheva' Tabwot South

- Date of visit: 07/03/2020
- Coordinates: 14.228699°N - 39.665364°E
- Altitude: 2 731 m
- Remains: isolated tomb
- Artefacts: none
- Pottery density: null
- Date: unknown

Description: Meheva' Tabwot South is located south of the Berih river, south-east of the plateau of Wolwalo, on the border of the Afar region. On a flat area of the plateau overlooking the valleys of the Afar province, there are several limestone outcrops. In one of them, a small cavity was used for a burial (fig. 9). Although it might have been walled, the wall is not preserved. Human bones are partially exposed (long arm bones, phalanxes, coastal bones).



Figure 9: SAZ 317 Meheva' Tabwot South: Burial in the rock (MAFTOr – J. Schiettecatte).

SAZ 318 [= SAZ 254] – Derash

- Date of visit: 07/03/2020
- Coordinates: 14.22855°N - 39.66466°E
- Altitude: 2 730 m
- Remains: complete buildings
- Building material: medium stones (20–40 cm)
- Artefacts: pottery
- Pottery density: medium
- Date: Aksumite period, likely late and post-Aksumite

Description: Derash is located south of the Berih river, south-east of the plateau of Wolwalo, at the border of the Afar region, midway between Meheva' Tabwot South (SAZ 317) and Hawuli Michael (SAZ 319). The

remains of two houses are partially preserved, on the very edge of the plateau (fig. 10), overlooking deeply incised valleys (Afar region). Some of the walls are up to 2 to 3 m high. On the ground, numerous potsherds are probably similar to the sherds retrieved on the slope of Meheva' Tabwot North, immediately to the north of Derash. They mainly include fragments of large basins with everted or thickened rounded rim common during the late and post-Aksumite period (fig. 11).



Figure 10: SAZ 318 Derash: Ruins of the dwellings (MAFTOr – J. Schiettecatte).



Figure 11: SAZ 318 Derash: Surface potsherds (MAFTOr – J. Schiettecatte).

SAZ 319 [= SAZ 268] – Hawuli Michael

- Date of visit: 07/03/2020
- Coordinates: 14.2282°N - 39.662749°E
- Altitude: 2 765 m
- Remains: double-faced wall, Indeterminate wall, Necropolis
- Building material: small stones (< 20 cm), medium stones (20–40 cm)
- Artefacts: pottery, grinding tools, other stone tools
- Pottery density: high density
- Date: Aksumite period, likely late and post-Aksumite

Description: In the south-eastern part of the plateau of Wolwalo, south of the Berih river, on several successive agricultural terraces immediately south of the church Hawuli Michael: very high density of potsherds

on the surface of several agricultural terraces belonging to three landowners:

- Tesfay Hagos
- Tehleaymanat Lema
- Gebre Meskel Lama

The second led us about the site and mentioned the presence of several walls buried in the ground; two walls are visible (one in a section of a terrace, the second outcropping on the ground). On the surface, sampling or photographs of many potsherds, a slag, several grinding stone fragments, stone tools, steatite vessels. To the south, Tehleaymanat Lema mentioned that he personally excavated nine graves. These were individual graves with no funerary deposits. Nine skeletons were excavated, all being adults. The covering slabs of schists were reused for roofing the farm.

The pottery is clearly contemporaneous with that collected in excavations at Gra Emni (SAZ 249) and Seb-dera (SAZ 248). There are fragments of large bowls with banded rim (fig. 13: bottom left, bottom right), one with incisions on the outside of the rim. There is also a fragment of rim of a basin or dokka in common ware



Figure 12: SAZ 319 Hawuli Michael: General view of the site looking south (a), outcropping wall (b) and (c), grinding stones (d) (MAFTOr – J. Schiettecatte).

(group 22) showing irregularities on the lower part of the outside due to moulding in the floor, a feature not attested in the region before the 7th century CE (fig. 13: middle). A fragment of a handled pan in coarse grey ware could indicate further occupation: it has parallels among the grey coarse pottery from Period II at Wakarida (10th–12th centuries CE).

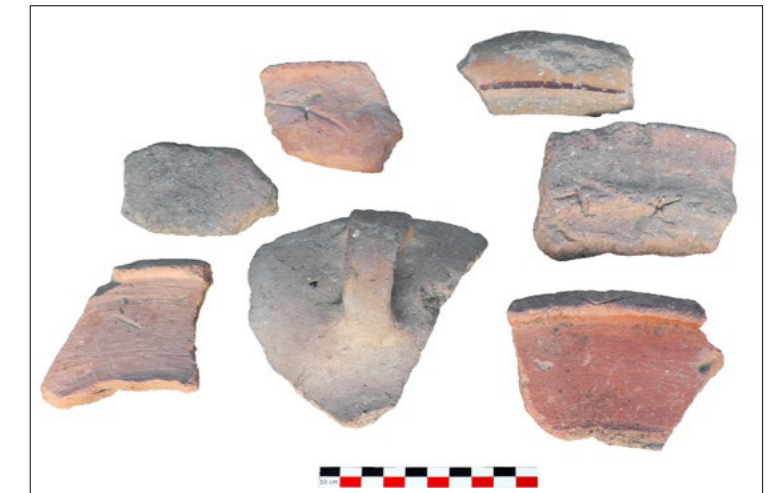

Figure 13: SAZ 319 Hawuli Michael: Surface potsherds (MAFTOr – J. Schiettecatte).



Figure 14: SAZ 320 Tahanit 1: General view, looking south-west (MAFTOr – J. Schiettecatte).

SAZ 320 – Tahanit 1

- Date of visit: 10/03/2020
- Coordinates: 14.22755°N - 39.66111°E
- Altitude: 2 777 m
- Remains: none
- Artefacts: pottery
- Pottery density: very low
- Date: Aksumite period, likely middle and late and post-Aksumite



Figure 15: SAZ 320 Tahanit 1: Surface potsherds (MAFTOr – J. Schiettecatte).

Description: In the southern part of the plateau of Wolwalo, south of the Berih river, on successive agricultural terraces south-west of the church Hawuli Michael: Wide area named Tahanit divided in ten archaeological sites (Tahanit 1 to 10). Tahanit 1 is a spread of weathered potsherds on the surface of two agricultural terraces (fig. 14) belonging to two landowners: Tesfay Kahazay (north) and Abraha Hagos (south), including two small fragments of everted rims of large basins characteristic of the middle and late and post-Aksumite periods (fig. 15). On the section of a terrace in Tesfay’s farm, brown sedimentary horizon sampled by Ninon Blond.

SAZ 321 – Tahanit 2 “Ferras”

- Date of visit: 10/03/2020
- Coordinates: 14.22689°N - 39.66162°E
- Altitude: 2 779 m
- Remains: double-faced wall, Indeterminate wall
- Artefacts: pottery, grinding tools, other stone tools
- Pottery density: medium to high
- Building material: small stones (< 20 cm) and medium stones (20–40 cm)
- Date: Aksumite period, likely middle and late and post-Aksumite

Description: In the southern part of the plateau of Wolwalo, south of the Berih river, on successive agricultural terraces south-west of the church Hawuli Michael: Wide area named Tahanit divided in ten archaeological sites (Tahanit 1 to 10). Tahanit 2 is located in the farm of Desta Abraha Shfar (fig. 16); the place is known as “Ferras”, meaning “ruins”. Immediately to the north of the farm, remains of outcropping masonry are visible (fig. 17) as well as many potsherds including possible complete shapes (basins, pots) and stone tools (fig. 18). The density of the potsherds rapidly decreases beyond a radius of 30 m around the farm. Around the farm, several outcropping double-faced walls indicate either a large building or several small buildings.

The pottery is abundant on surface judging by the sampling (figs 19-21). Potsherds are mainly common ware (groups 21–22) similar to the one appearing at Gra Emni (SAZ 249) and Sebdera (SAZ 248) but also several fragments similar to potteries from Wakarida. Among the diagnostic shapes are two fragments of braziers, one with an up-turned ledge rim (WK. 4629) the other with a T-shaped ledge rim (WK. 4642). Fragments of large storage jars include slightly flaring necks with an everted or thickened rim (WK. 4630, 4631). Rims also include large ledge rims with a flattened vertical lip, similar to examples from Gra Emni (WK. 4639, 4640, 4641), and fragments of large basins with everted rim (WK. 4633, WK. 4643). A fragment of a bottle rim in common incised ware and a small handle in brown incised ware (group 8) have also been collected, as well as a bowl with a lug on the rim made in a fabric reminding the brown incised ware as for texture and surface treatment, but which could also represent a more recent production (WK. 4638: fig. 21). These sherds clearly indicate a late and post-Aksumite occupation. An occupation including levels from the middle-late Aksumite period (dating similar to Wakarida: 4th–7th centuries CE) and the post-Aksumite period (dating similar to Gra Emni: 7th–9th centuries CE) appears possible.

SAZ 322 – Tahanit 3 “Sesiha”

- Date of visit: 10/03/2020
- Coordinates: 14.22537°N - 39.65968°E
- Altitude: 2809 m
- Remains: double-faced wall
- Building material: medium stones (20–40 cm)
- Artefacts: none
- Pottery density: null
- Date: unknown

Description: In the southern part of the plateau of Wolwalo, south of the Berih river, on successive agricultural terraces south-west of the church Hawuli Michael: Wide area named Tahanit divided in ten archaeological sites (Tahanit 1 to 10). Tahanit 3 is a flat rocky outcrop, on the piedmont of the plateau of Giratenes, with the presence of an outcropping double-faced wall (fig. 22). Its eastern side is hidden by an agave and to the west by an acacia.



Figure 16: SAZ 321 Tahanit 2: General view, looking south (MAFTOr – J. Schiettecatte).



Figure 17: SAZ 321 Tahanit 2: outcropping wall (MAFTOr – J. Schiettecatte).

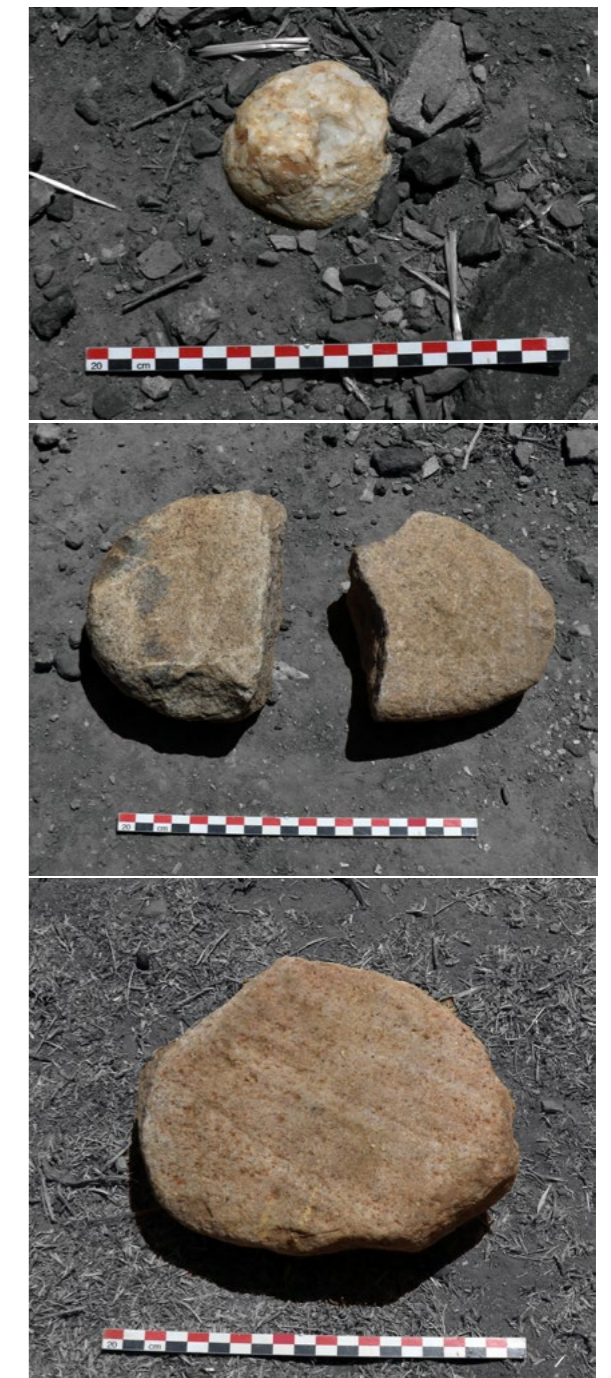

Figure 18: SAZ 321 Tahanit 2: stone tools and grinding stones (MAFTOr – J. Schiettecatte).



Figure 19: SAZ 321 Tahanit 2: Surface potsherds (MAFTOr – J. Schiettecatte).



Figure 20: SAZ 321 Tahanit 2: Surface potsherds (MAFTOr – J. Schiettecatte).



Figure 21: SAZ 321 Tahanit 2: Bowl sampled on the surface (MAFTOr – J. Schiettecatte).



Figure 22: SAZ 322 Tahanit 3: General view, looking north-east (MAFTOr – J. Schiettecatte).



Figure 23: SAZ 323 Tahanit 4: Outcropping wall (MAFTOr – J. Schiettecatte).

SAZ 323 – Tahanit 4

- Date of visit: 10/03/2020
- Coordinates: 14.22634°N - 39.65889°E
- Altitude: 2 812 m
- Remains: double-faced wall
- Building material: medium stones (20–40 cm)
- Artefacts: pottery
- Pottery density: low
- Date: unknown

Description: In the southern part of the plateau of Wolwalo, south of the Berih river, on successive agricultural terraces south-west of the church Hawuli Michael: Wide area named Tahanit divided in ten archaeological sites (Tahanit 1 to 10). On a flat rocky outcrop, on the piedmont of the plateau of Giratenes, presence of two outcropping double-faced walls on the edge of an opuntia grove.

SAZ 324 – Tahanit 5

- Date of visit: 11/03/2020
- Coordinates: 14.22948°N - 39.65706°E
- Altitude: 2 783 m
- Remains: none
- Artefacts: pottery, obsidian
- Pottery density: low
- Date: late and post-Aksumite periods

Description: In the southern part of the plateau of Wolwalo, south of the Berih river, on successive agricultural terraces south-west of the church Hawuli Michael: Wide area named Tahanit divided in ten archaeological sites (Tahanit 1 to 10). Tahanit 5 is located in the surroundings of Tamrat Hagos's farm, on a small rocky ridge between two drainage areas. On a rocky outcrop between two houses, a woman showed us a small complete late and post-Aksumite jar in common ware (group 8) unearthed on the spot (fig. 24: left). The potsherds collected on the surface also include fragments of everted rims in common ware (group 3, 5 or 21-22). Two sherds might be of later date: a fragment of red common ware with oblique lines on the inside face, resulting from intentional surface smoothing with a flat tool, and a sherd with a red slip becoming black in the upper part (fig. 24: right). Both could indicate an older post-Aksumite occupation, yet to be confirmed.

SAZ 325 [= SAZ 274] – Tahanit 6

- Date of visit: 11/03/2020
- Coordinates: 14.23027°N - 39.6564°E
- Altitude: 2 786 m
- Remains: none
- Artefacts: pottery, obsidian
- Pottery density: high
- Date: Aksumite period, likely middle and late and post-Aksumite

Description: In the southern part of the plateau of Wolwalo, south of the Berih river, on successive agricultural terraces south-west of the church Hawuli Michael: Wide area named Tahanit divided in ten archaeological sites (Tahanit 1 to 10). Tahanit 6 is a rocky ridge to the north of SAZ 324, overlooking the Berih river. There, a highly dense spread of potsherds and obsidian covers a 20-m-wide area. On the north-western slope, the land was recently used as a stone quarry and the sediment has been excavated (fig. 25). In that

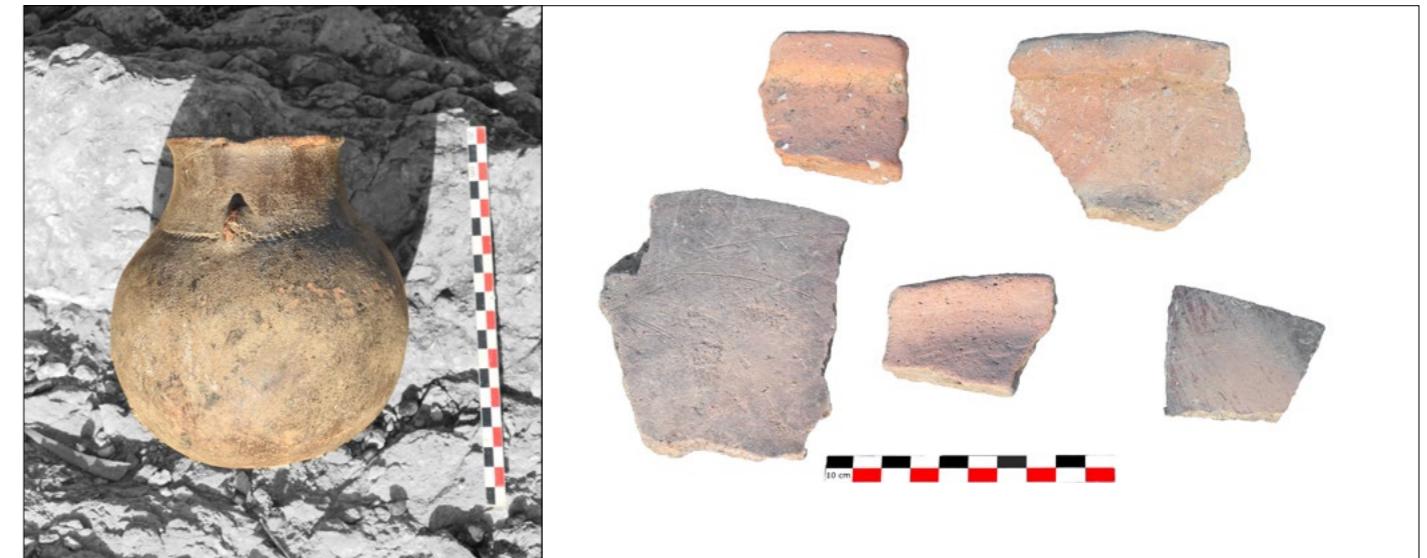

Figure 24: SAZ 324 Tahanit 5: Jar unearthed by an inhabitant (a) and surface potsherds (b) (MAFTOr – J. Schiettecatte).



Figure 25: SAZ 325 Tahanit 6: Site recently excavated by the inhabitants for stone quarrying, looking north (MAFTOr – J. Schiettecatte).



Figure 26: SAZ 325 Tahanit 6: Surface potsherds (MAFTOr – J. Schiettecatte).

5 × 5 m wide area, very high density of potsherds. The pottery collected is mainly represented by fragments of everted rim of basins in common ware (group 5, WK. 4621–4626, **fig. 26**), a group present at Wakarida, still appearing in smaller quantity at Gra Emni (SAZ 249). Some of these basins have impressions on the inside (WK. 4621).

SAZ 326 – Tahanit 7 “Messe Gwaguhe”

- Date of visit: 11/03/2020
- Coordinates: 14.22958°N - 39.65635°E
- Altitude: 2 790 m
- Remains: double-faced wall, complete building
- Building material: medium stones (20–40 cm)
- Artefacts: pottery
- Pottery density: low
- Date: Aksumite period, likely middle and late and post-Aksumite

Description: In the southern part of the plateau of Wolwalo, south of the Berih river, on successive agricultural terraces south-west of the church Hawuli Michael: Wide area named Tahanit divided in ten archaeological sites (Tahanit 1 to 10). Tahanit 7 is locally named “Messe Gwaguhe” which means “abundant sage”. On the same rocky ridge as SAZ 324, west of it, overlooking the bed of the Berih river, close to Ametah Bayru’s farm, remains of a large building outcropping on the ground: three double-faced walls are partly exposed, partly covered by a cultivated terrace (**fig. 27**). Pottery is not very abundant, it includes a ring base, an everted rim and a rounded rim of a globular bowl (**fig. 28**). These shapes suggest an Aksumite dating, middle or late and post-Aksumite.

SAZ 327 – Tahanit 8 “Tshaaw”

- Date of visit: 11/03/2020
- Coordinates: 14.2274°N - 39.65589°E
- Altitude: 2 816 m
- Remains: none
- Artefacts: pottery
- Pottery density: very low
- Date: unknown

Description: In the southern part of the plateau of Wolwalo, south of the Berih river, on successive agricultural terraces south-west of the church Hawuli Michael: Wide area named Tahanit divided in ten archaeological sites (Tahanit 1 to 10). Tahanit 8 is locally named “Tshaaw”. In Hagos Gebre Madin’s farm, the land-owner showed us a fragment of a large clay spoon (grey fabric), found at a distance from the farm (**fig. 29**). It was not possible to set the discovery in its context.

SAZ 328 – Wumbro

- Date of visit: 11/03/2020
- Coordinates: 14.2239417°N - 39.6560567°E
- Altitude: 2 883 m
- Remains: none
- Artefacts: pottery, obsidian, other stone tools
- Pottery density: very low
- Date: unknown

Description: On a western flat rocky plateau, west of the plateau of Giratenes, at mid-slope, isolated farm



Figure 27: SAZ 326 Tahanit 7: Outcropping building west of the farm of Ametah Bayru (MAFTOr – J. Schiettecatte).



Figure 28: SAZ 326 Tahanit 7: Surface potsherds (MAFTOr – J. Schiettecatte).



Figure 29: SAZ 327 Tahanit 8: Surface potsherd (MAFTOr – J. Schiettecatte).



Figure 30: SAZ 328 Wumbro: Surface stone tools and potsherd (MAFTOr – J. Schiettecatte).

surrounded by cultivated terraces. On the ground, very rare artefacts: a single flake of obsidian, very low density of potsherds (**fig. 30**).

SAZ 329 – Tahanit 9

- Date of visit: 11/03/2020
- Coordinates: 14.224944°N - 39.65803°E
- Altitude: 2 837 m
- Remains: double-faced wall, complete building
- Building material: medium stones (20–40 cm)
- Artefacts: pottery
- Pottery density: high
- Date: Aksumite period, likely late and post-Aksumite

Description: In the southern part of the plateau of Wolwalo, south of the Berih river, on successive agricultural terraces south-west of the church Hawuli Michael: Wide area named Tahanit divided in ten archaeological sites (Tahanit 1 to 10). Tahanit 9 is located on the northern piedmont of the plateau of Giratenes, at mid-slope; north of Alem Beyene's farm. There, double-faced walls (**fig. 32**) are set perpendicularly to each other and belong to a same 8-m-wide building (**fig. 31**). The building is eroded to the north (collapse in the slope); to the south, it is hidden by the enclosure of the farm.

The pottery collected at Tahanit 9 (**fig. 33**) includes a fragment of basin with a small oblique ledge rim and a fragment of a brazier with an up-turned ledge rim. Both types are present in Wakarida; a similar basin was also found at Gra Emni (SAZ 249). These two shapes suggest a late and post-Aksumite occupation. A fragment of vertically pierced lug has also been found; its dating remains uncertain.

Preliminary remarks

The systematic survey of the south-eastern quarter of the Wolwalo plateau and the excavation of the site of Gra Emni led us to confirm some assessments made in 2018.

1 – A dense Aksumite occupation

Although the variations in the density of surface artefacts is important, the past human occupation is visible in most of the sectors of the plateau that we visited. The main markers of this occupation are middle to late and post-Aksumite potsherds scattered on the ground. Sporadically, we found grinding stones and polishers. All these markers point to a main phase of ancient occupation during the Aksumite period. Most of the pottery is comparable to that of Gra Emni and Sebdera, characterizing the 7th–9th centuries CE (early post-Aksumite). But the surface material could hide older Aksumite levels. It does not rule out earlier and later presence.

2 – The low visibility of architectural remains

If scattered surface potsherds are frequent, the remains of architectural buildings are rare, mainly for taphonomic and topographic reasons. Most of the time, they are buried under the modern cultivated terraces and modern farms. The dense stone cover of some fields is significant of their presence.

Whenever visible, this architecture appears homogeneous and similar to the structures excavated in Sebdera (SAZ 248) and Gra Emni (SAZ 249, sounding 4): c. 55 to 70-cm-large outer walls with two faces of squared stones and smaller inner perpendicular walls (e.g. Tahanit 7, Tahanit 9).

3 – The absence of deep stratigraphical sequences

Nowhere can we observe a deep stratigraphic sequence above the bedrock. The presence of a deep sediment



Figure 31: SAZ 329 Tahanit 9: Outcropping building north of the farm of Alem Beyene (MAFTOr – J. Schiettecatte).



Figure 32: SAZ 329 Tahanit 9: Outcropping wall (MAFTOr – J. Schiettecatte).



Figure 33: SAZ 329 Tahanit 9: Surface potsherds (MAFTOr – J. Schiettecatte).

accumulation — and hence a deep multi-period stratigraphic sequence — is highly unlikely on the plateau. It has been proven by the excavation at Sebdera and Gra Emni where bedrock appears at a depth comprised between 40 and 150 cm below the surface of cultivated terraces.

4 – Some thoughts about the settlement pattern

The preliminary model for the settlement pattern of the Wolwalo plateau defined in 2018 has to be put into perspective according to the results of the excavation at Gra Emni (SAZ 249).

The first results of the 2017–18 survey suggested a centralized and hierarchized settlement pattern organized in concentric circles around Gra Emni (see the 2018 field report). In fact, excavations at Gra Emni rather showed a scattered occupation of the area with a few buildings, and no densely built settlement. There is no such central place as the one firstly postulated.

The settlement pattern rather appears in the shape of clusters of small settlements on hilltops and upper slopes characterised by a very high density of surface material scattered on a limited area (c. 0.5 to 1 ha), i.e. Hawuli Michael NE (SAZ 313), Hawuli Michael (SAZ 319), Tahanit 2 (SAZ 321), Tahanit 7 (SAZ 326), Tahanit 9 (SAZ 329). They often yielded evidence of the presence of one or two large buildings. They rarely exceed 50 to 60 m in diameter. They appear as large farms or small settlements scattered over the plateau and surrounded by smaller settlements (isolated dwelling?) with a low density of surface material and rare architectural remains visible on the ground, i.e. Hawuli Michael NW (SAZ 314), Derash (SAZ 318), Tahanit 1 (SAZ 320), Tahanit 3 (SAZ 322), Tahanit 4 (SAZ 323), Tahanit 6 (SAZ 325).

In the drainage areas and thalwegs, also shaped today in terraces, the presence of past occupation is very rare. They were probably cultivated areas, although no ancient terrace system has been discovered so far.

References

A. Benoist, I. Gajda, J. Schiettecatte, N. Blond, P. Wolf, S. Büchner, S. Matthews. 2020. On the diffusion of possible Sabaeon influences in Ethiopia during the first millennium BC: A view from the margins of the eastern Tigray plateau. *Proceedings of the Seminar for Arabian Studies* 50: 17–34.

Phillips J., 2000. Pottery and clay objects. In Phillipson 2000, *Archaeology at Aksum, Ethiopia, 1993-7, Vol II, Chapter 10 The D site at Kidane Mehret*. The British Institute in Eastern Africa, The Society of Antiquaries of London, London: 303–336.

GEOMORPHOLOGICAL SURVEY OF THE WOLWALO PLATEAU

Ninon BLOND (University of Lyon 2, UMR 5133 Archéorient)

Aim and schedule

This year's mission was devoted to geographical, geomorphological and geoarchaeological surveys in the Wolwalo region (Tigray Plateau), where the MAFTOr has been carrying out archaeological excavations since 2018. The main objective was to identify potential work sites for future seasons in connection with the archaeological surveys.

Several setbacks have disrupted the initial organisation, reducing the effective working time.

Table 1 – Work schedule during the mission

March 04	Installation of Gra Emni test pits/Survey around Sebdera + Berih Valley
March 05	Survey Enda Gaber Asha Heiti
March 06	Survey around Gra Emni
March 07	Survey in the Berih Valley
March 10	Survey Tahanit + sampling in Sebdera in the afternoon
March 11	Survey Tahanit + sampling Ruwa Ruwa in the afternoon
March 12	Sampling in Berih valley + tube cuttings and OSL sampling in Sebdera in the afternoon
March 13	End of sampling Ruwa Ruwa (sediments + OSL)

The work was organised in two main stages: surveys on the one hand, and stratigraphic studies and sampling on the other (Table 1).

Geographical and geomorphological surveys

The first part of the work consisted of geographical and geomorphological surveys, carried out jointly with Jérémie Schiettecatte, who was in charge of the archaeological survey. The sites were visited in pairs, and identified according to the points of interest of each of us. The covered area is quite small, due to a rather short working time. We travelled around the Gra Emni site, the Sebdera site (excavated the previous year), on the left bank of the Berih River, as well as the course of the Berih and its tributaries, at the level of the town of Wolwalo. Finally, the survey also extended to the right bank of the river, on the foothills of the plateau, to the south, at the sites of Tahanit, Hawuli Mikael, and Derash.

Several potentially interesting sites were identified during this campaign. Most of them are stratigraphic sections in agricultural terraces, located in the small thalwegs separating the hills. These sections show a fairly homogeneous, mixed, colluvial type material (coarse elements not or not very rounded, in a fine, silty matrix).

Other sites have been identified in untrimmed tanks, sometimes several metres deep. Some of them show a fairly clear bedding, with alternating phases of fine and coarse deposits. Some of the cisterns were dug in the small terraced thalwegs, others close to the dwellings, and still others in the minor bed of the Berih. Finally, the bottom of the Berih River revealed interesting sedimentary accumulations as a result of the incision of the major bed. However, the presence of water did not allow direct sampling, so a hand auger had to be used.

Sampling

A colluvial accumulation on agricultural terraces was studied near the Gra Emni site (GEa). In a terrace in Tahanit, a cut was studied because it had a surprisingly black base, which will have to be explained by analysis (TAa). A section was also studied at Sebdera, near the site excavated in 2018 (SDa), in the bottom of a cistern, two at Ruwa Ruwa, in a cistern (RRa and RRb), and one was studied by means of core sampling with an auger (SBEa) upstream of the Berih River valley. Sections locations are reported on the map (fig. 1). Sediment and coal samples were collected in bulk. Sediment blocks for micromorphology and OSL dating tubes were also collected. Additional observations (routes, photos) were made on all the prospected sites.

Due to the sanitary crisis caused by Covid-19, the samples were not exported. For the time being, they are still kept at ARCCCH, pending more favourable conditions for their shipment to France. The sediment samples will be analysed at the OMEAA platform (UMR 5133 and UMR 5600, Lyon) for sedimentology. The coals will be prepared for dating at the 14C dating centre in Lyon and dated at the Saclay accelerator. Thin sections for micromorphology will be prepared and analysed at the OMEAA platform, while the OSL tubes will be sent for dating at an institution yet to be determined.

Main observations

The surveys and the first samples taken provide some elements for the understanding of the current landscapes. They will have to be supplemented by analyses and other observations.

Thalweg deposits between the hills

– At Sebdera, whitish, laminated, fairly indurated deposits in a cistern could indicate palustrine/lacustrine clays. The proximity of the building, excavated during the previous season, invites us to date and analyse these deposits. Sediment samples and OSL dating tubes were taken for this purpose (fig. 2).

– The recurrent presence, in the thalweg deposits between hills, of very mixed sediments, combining fine silts and centimetric-sized, angular and slightly rounded elements, indicates colluvial deposits. They may be an indication of frequent runoff from higher elevations, especially those of the plateau (fig. 3).

– This hypothesis makes it possible to question the remains found in some sections. The rounded sherds or obsidian fragments present on the deposits may be the result of a surface coating linked to colluviation.

– Archaeological and geomorphological surveys made it clear that the settlement sites are most often found on high points. Indeed, few or no remains have been observed in the thalwegs between the hills. This raises the question of the location of cultivated areas associated with human occupation in ancient times. In the Wakarida sector, we were able to demonstrate that the current terraces were recently built and that the cultivated areas were probably located on the slopes or high points, close to the dwellings, in the pre-, proto-Aksumite and Aksumite periods (Blond *et al.* 2018; Blond 2019). In the Wolwalo region, the topography is different: the slopes are very steep (edges of the plateau), and the high points very rocky, with very little soil. The presence of grinding stones and knurls, both in the surface material found during the survey and in the excavations, however, indicates the cultivation of cereals. This question of the location of the cultivation areas will have to be investigated in future missions. The participation of specialists, in particular palaeobotanists, could be useful.

– At Gra Emni (SAZ 249), the presence of a pre-Aksumite building buried under nearly one metre of sediment, also indicates erosive processes that are currently very active. This idea is supported by the fact that the occupations excavated, at Sebdera or Gra Emni, are generally based on bedrock.

– These initial observations would tend to indicate a possible change in sedimentary dynamics between ancient and present times. It is also conceivable that the substrate was cleared to lay the foundations of the building, although the loss of such a cultivable surface raises questions, as does the possible “burial” of the building that such a process could cause. The height of the thresholds in relation to the substrate could provide some answers.

– At Ruwa Ruwa, the study of two sections in a cistern dug at the outlet of a small tributary coming from the plateau (fig. 4) revealed significant changes in the competency of the flows, with the passage from deposits of blocks and pebbles to deposits of gravel, sand and silt (fig. 5). It is now a matter of dating them, by radio-carbon or OSL. Very few charcoals have indeed been found in these deposits.

Valley bottom deposits

In the Berih valley, part of the studied deposits are located in the gorge section of the valley, a short distance downstream from the border with the Afar (fig. 6). In this area, silty deposits were observed, which form an alluvial terrace in the valley floor. During the survey, the river showed weak surface flows, used for washing clothes, which cut into the valley bottom deposit in alluvial terraces. Some of the remains (shards, obsidian fragments) present in the deposits probably come from colluviation from the surrounding slopes (edges of the plateau notched by the gorge) or from alluvial deposits from the upstream part of the river, which is less steeply incised. The presence of sites on the high points rather argues for colluvial processes.

The upstream part of the Berih was also studied using hand auger coring. The samples revealed, under the topsoil at the bottom of the bed, deposits that were initially sandy and then became increasingly clayey as one moved away from the surface. The change over time from clayey to sandy deposits indicates a change in flow competence, and might also be the result of alteration of the sandstone substrate on the slopes. This could be related to its exposure, following soil erosion and/or deforestation of the slopes. The coring was abandoned before reaching the substrate, as the clay was settling under the effect of the auger.

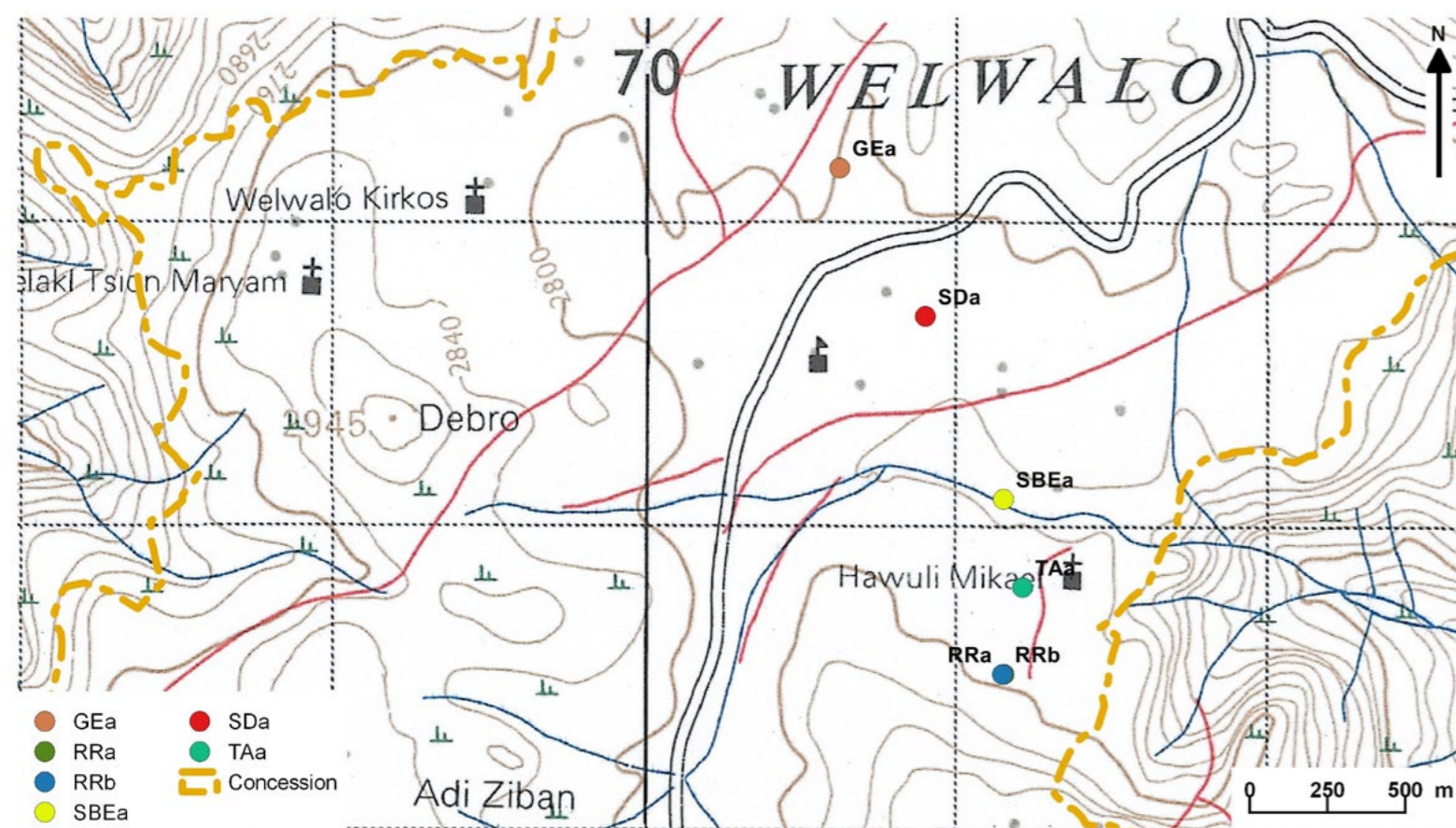

Figure 1: Location of the sections studied during field season 2020 (N. Blond – MAFTOr/Map: National Mapping Agency).



Figure 2: SDa section with holes for OSL sampling (N. Blond - MAFTOr).

Figure 3: Section in Tahanit (TA06), next to TAa, showing colluvial characteristics (N. Blond - MAFTOr).

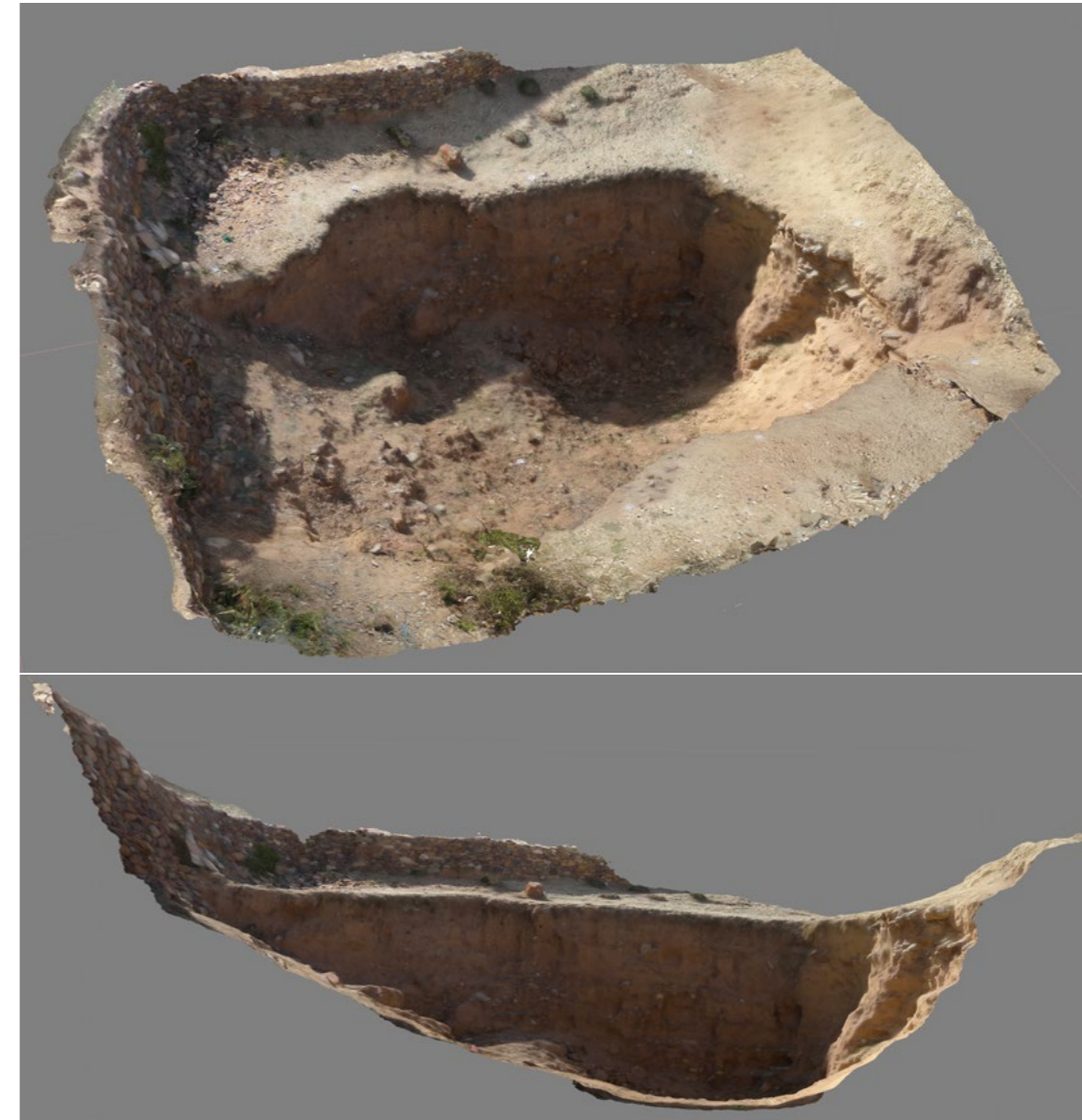

Figure 4: Ruwa Ruwa: 3D model and transect of the natural section in the cistern (J. Schiettecatte - MAFTOr).

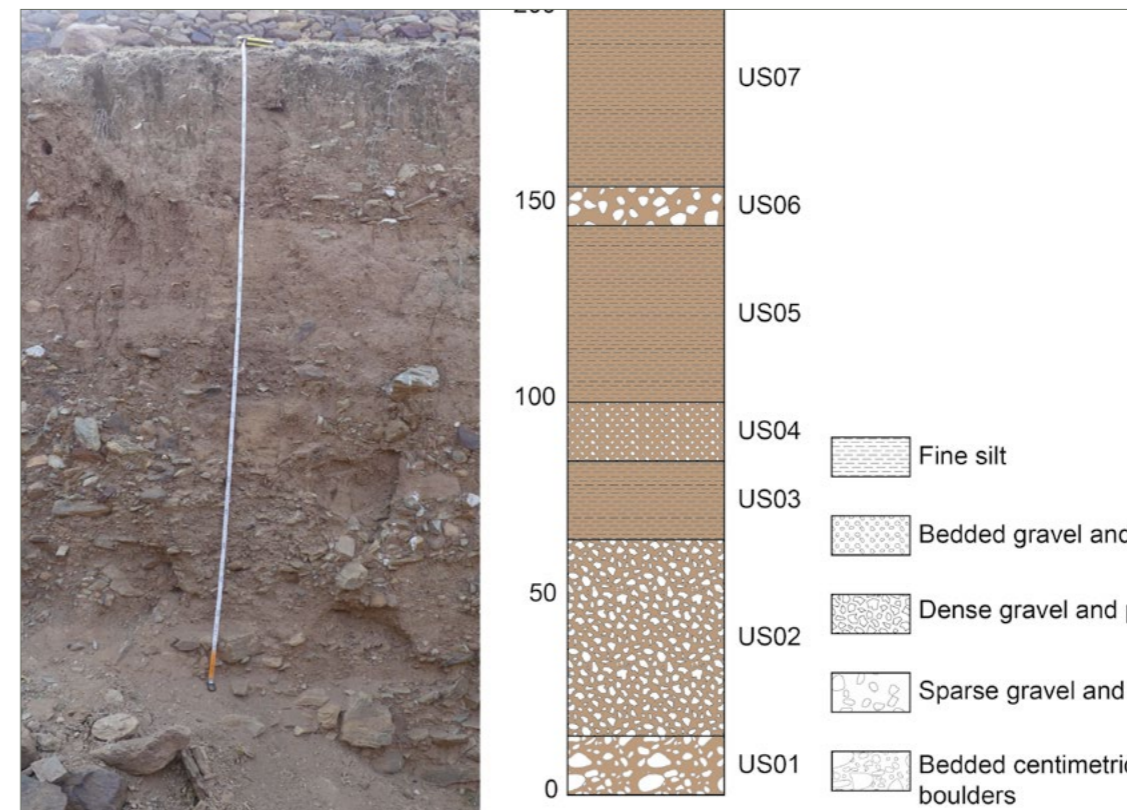

Figure 5 - Ruwa Ruwa: picture and drawing of section RRb (N. Blond - MAFTOr).

Perspectives

For the next campaigns, the geographical, geoarchaeological and geomorphological work can be continued in the following directions:

- The samples taken during this year will be sent to France when the sanitary conditions will be better. They will then be analysed and dated, which will provide initial elements to be completed during a future season.
- The hand auger test was relatively conclusive, but the sediments, which are rather loose, have been re-worked by the coring. It would be interesting to do a test with a manual gouge, to better identify the transitions. Ideally, it would even be possible to carry out more complete coring, until the substrate is reached, using a Cobra-type corer. An alternative would be to dig test pits to gain access to the valley bottom stratigraphy. Transects will be carried out in the bed of the Berih River in order to document the paleoenvironmental and geomorphological evolution of this region.
- At Sebdera as at Ruwa Ruwa, dating the deposits will make it possible to specify the paleoenvironmental chronology of the region and to relate it, as far as possible, to the cultural chronology provided by the archaeological excavations.
- The observations made during the prospection, as well as former surveys around Wakarida, will enable the construction of a geomorphological map of the region, which will be completed during the next campaigns by spot checks in the field.
- Finally, the very important issue of agriculture, in Wolwalo as in Wakarida, invites the repetition of the ethnogeomorphological and ethnoarchaeological survey, carried out in 2017 on the Tigrayan territory of the Wakarida survey area. It seems important to extend this survey to the Afar populations of the prospecting area, as well as to the surroundings of Wolwalo, on the Tigray Plateau.

Ultimately, the aim of this work is to complete the environmental chronology of East Africa — and in particular of Eastern Tigray — during the Holocene (the last 11 700 years), focusing on ancient periods and the relationship of populations with their environment.

References

- Blond N. 2019. *Dynamiques sédimentaires holocènes et terrasses agricoles dans les montagnes du Tigray oriental (Éthiopie)*. PhD thesis. Université Lumière Lyon 2, Lyon, France. Available at: <https://halshs.archives-ouvertes.fr/halshs-02407967>.
- Blond N., Jacob-Rousseau N. & Callot Y. 2018. Terrasses alluviales et terrasses agricoles. Première approche des comblements sédimentaires et de leurs aménagements agricoles depuis 5000 av. n. è. à Wakarida (Éthiopie). *Géomorphologie : relief, processus, environnement* 24(3): 277–300. DOI: 10.4000/geomorphologie.12258.

Figure 6: Natural section on the Berih river side (N. Blond - MAFTOr).



**THE ARCHAEOLOGICAL
SITE OF GRA EMNI IN
THE WOLWALO AREA**

GRA EMNI (SAZ 249) - TOPOGRAPHY OF THE SITE

Jérémie SCHIETTECATE (CNRS, UMR 8167 Orient & Méditerranée)

The topographic work was carried out by Jérémie Schiettecatte. The aim was manifold:

- draw a map of the site showing its extent and topography;
- provide altimetric data;
- set the soundings according to a UTM grid of reference;
- map the excavated archaeological structures.

The device used for this survey was a D-GPS Trimble R4/R8s.

Topographic setting

No previous topographic work had been carried out on the site and there was no geodesic marker in the area. Two permanent ground stations have been set (St. 1 and St. 2).

Universal Transverse Mercator projection, area 37P, and WGS 84 datum were used.

The first station (St. 1) was located by interpolating two geographic coordinates given by hand GPS (Garmin Etrex Summit and Garmin GPSMap 64) and one obtained on GoogleEarth. The arbitrary location of St. 1 is E570666 N1574123, 2 795 m a.s.l., with a horizontal error of c. 1 m, vertical error of c. 2 m.

St. 1 was used to set the GPS base (Trimble R8s). All the coordinates obtained on the field with the mobile D-GPS Trimble R4 were obtained with real-time kinematic (RTK) positioning — horizontal delta error of 0.01 m; vertical delta error of 0.02 m. All the points benefit from this low delta error margin. However, it must be kept in mind that the global working grid at Gra Emni has a delta error of 1 m on the terrestrial coordinate system, due to the low accuracy of St. 1 positioning.

Station St. 2 was set on the ground with RTK positioning. Coordinates are E570591,95 N1574347,58, and 2 813,06 m a.s.l.

Map of Gra Emni (SAZ 249)

The map of the site was obtained by photogrammetric processing of kite aerial pictures taken in November 2018 by Thomas Sagory. At that time, the shooting was done as a preliminary aerial review of the significant sites in Wolwalo area. The initial purpose was not a proper photogrammetric review of the site itself. In 2020, a new aerial shooting was not possible. For want of anything better, the set of photographs taken in 2018 was used to produce the map of the site.

It has to be considered as a preliminary map, taking into account that pictures are not covering properly the eastern and southern margins of the site (**fig. 1**), and that D-GPS anchorage references are not evenly distributed. They are concentrated to the very south and north of the sites (**fig. 2**).

The photogrammetry was computed with the Agisoft Photoscan 1.4 software, with the following processing sequence:

- aligning photos with a high accuracy; key point limit: 40,000; tie point limit: 1,000;
- building a dense cloud of high quality and aggressive depth filtering;
- building mesh based on the dense cloud, with a high face count and enabling interpolation;
- building a texture with a generic mapping mode, mosaic blending mode and a texture size/count of 8192.

An orthomosaic and a digital elevation model (DEM) of the site were derived, exported, and processed on ESRI ArcMap to produce the map of the site (**fig. 3**).

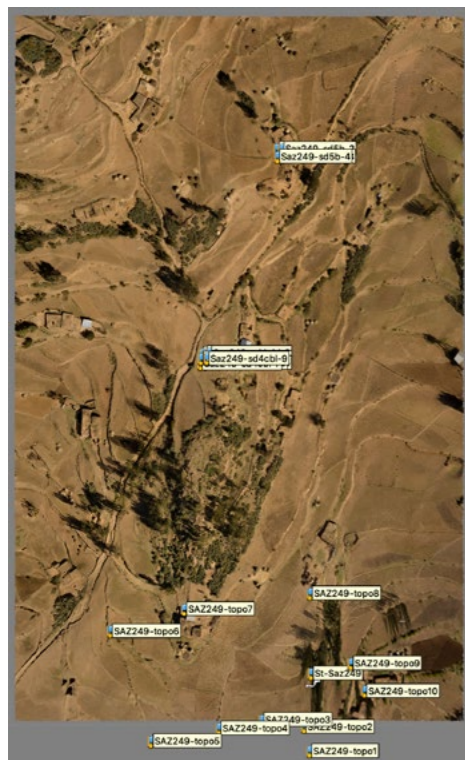
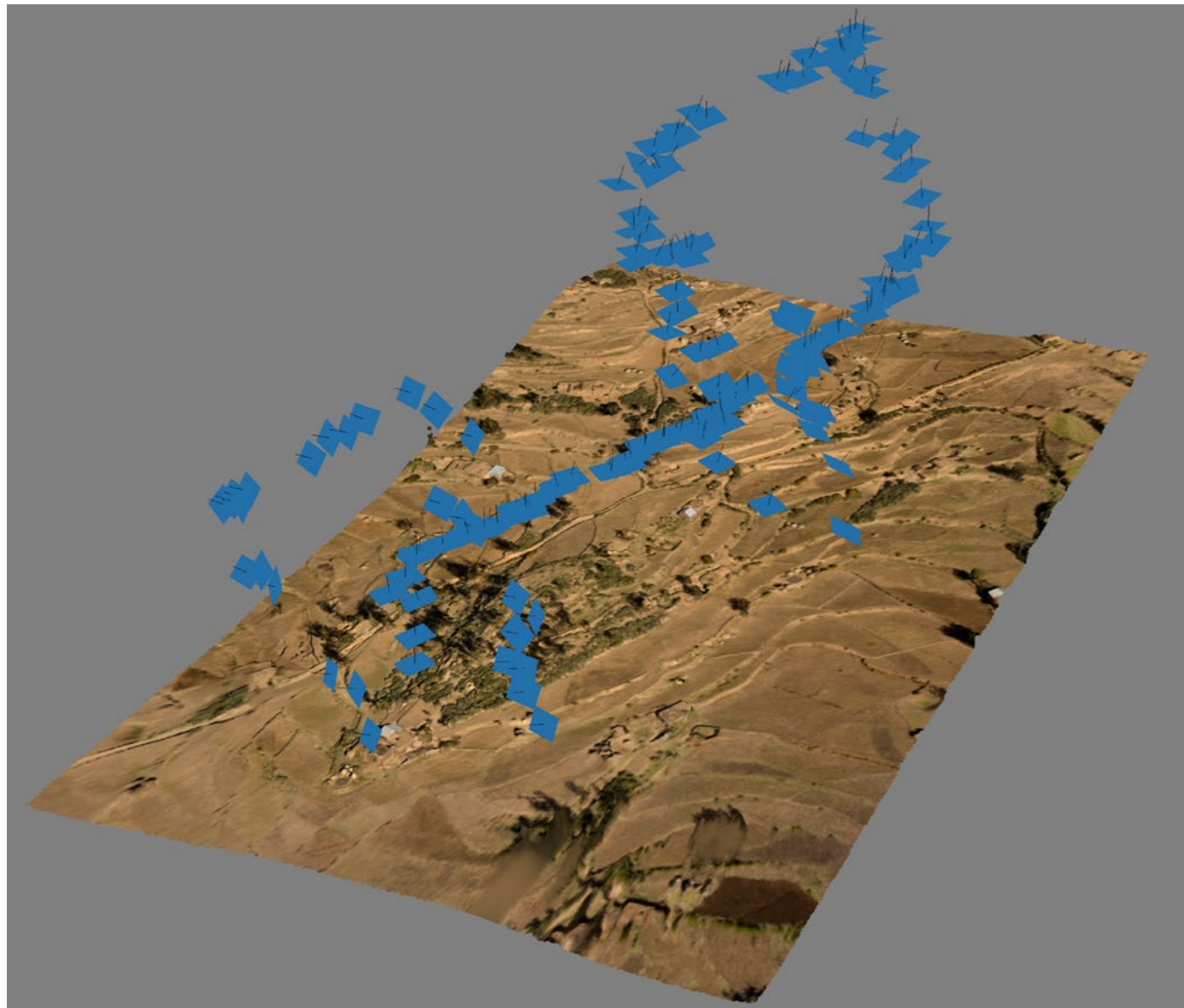

▲ **Figure 1:** Gra Emni (Saz 249): Distribution of the kite aerial pictures (J. Schiettecatte - MAFTOr).

◀ **Figure 2:** Gra Emni (Saz 249): Distribution of the D-GPS anchorage references (J. Schiettecatte - MAFTOr).

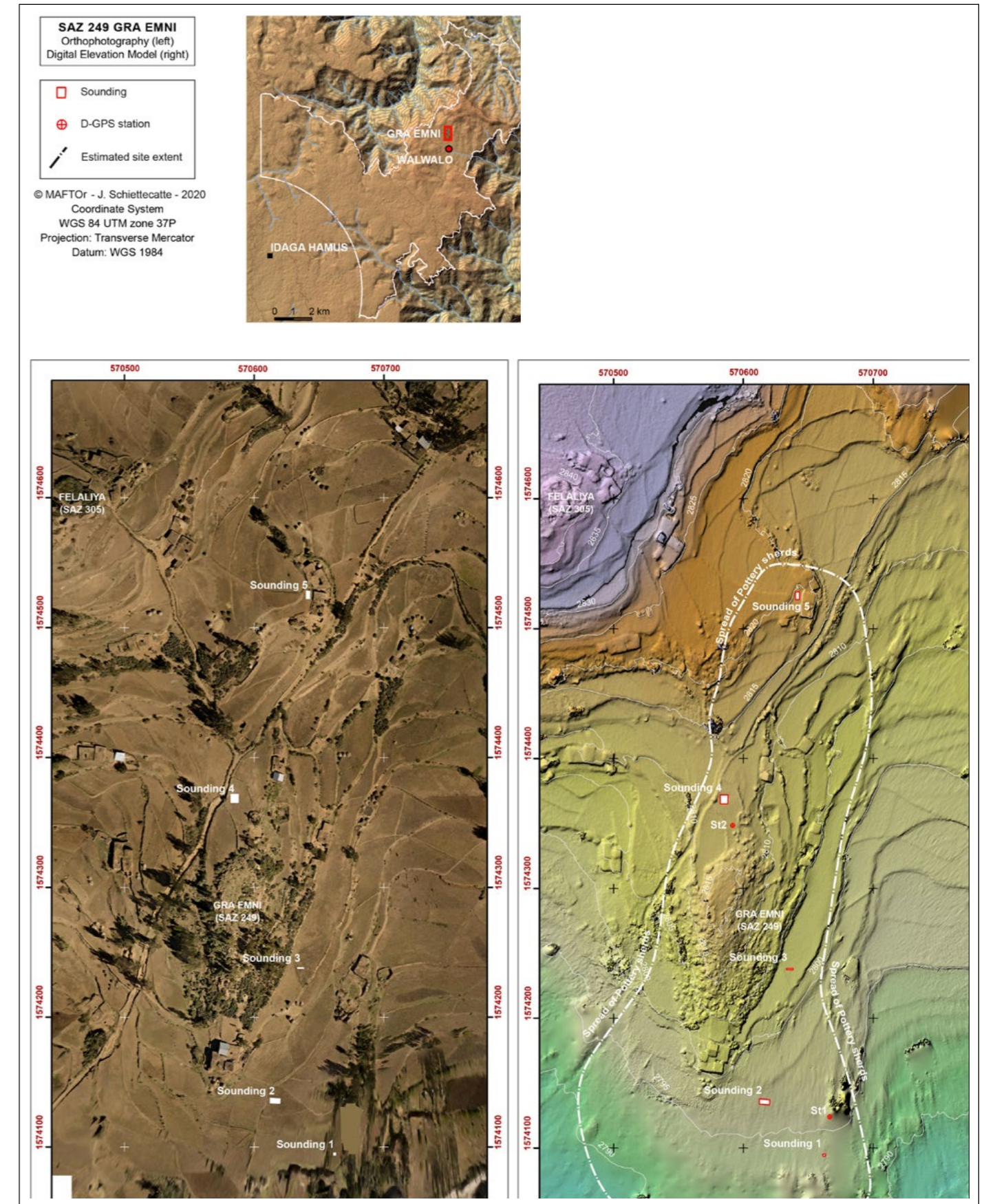

Figure 3: Gra Emni (Saz 249): Orthophotograph (left) and DEM (right) of the site (J. Schiettecatte - MAFTOr).

Extent and topography of Gra Emni (SAZ 249)

The centre of Gra Emni corresponds to a 15-m-high rocky hill covered with eucalyptus and opuntia (i.e. prickly pear or barbary fig). The slopes are entirely shaped in modern agricultural terraces hiding ancient remains of walls. The only evidence of this ancient occupation is the pottery material spread on the surface. The extent of this pottery spread is c. 450 m from north to south, and 100 to 175 m from east to west (fig. 3, right). The site is occupied by six farms (fig. 4) whose landowners reported the presence of ancient walls under their cultivated terraces and plantations; four landowners showed us potsherds and jars coming from these contexts. The farms are, from south to north:

Farm 1 – Owned by Mabraatu Hagos: in the courtyard: an Aksumite bowl and two large Aksumite jars have been unearthed in the field north of the farm – one is a wide-open jar; the second a globular jar with a concave neck. North of the farm, the terrace fields are covered with potsherds and stones. According to the owner, buildings are buried c. 1 m below the surface. South of the farm, in a plantation of barbary fig trees, a cistern is dug in the out-cropping bedrock (c. 2 × 2 × 2 m); many sherds on the surface. East of the farm, on the surface of a grassy terrace, the corner of a levelled building is visible. Westward, the cultivated terraces are covered with small stones and potsherds of Aksumite red ware. A wall is visible in the section of a terrace. The density of scattered surface sherds declines when getting close to the track Wolwalo-Addi Maamar.

Two soundings were opened north of the farm: **SOUNDING 1** and **SOUNDING 2** (fig. 3).

Farm 2 – Owned by Tesfay: high density of potsherds on the terraces; the presence of buried walls is assumed by the owner.

On the hilltop: series of small levelled walls preserved on a few courses only (the bedrock outcrops nearby). These walls are built in small stones and do not exceed 50–55 cm in width. Presence of Aksumite sherds and obsidian flakes on the surface.

Farm 3 – Owned by Abraha: north-east of the hill. The owner showed us a small incense burner in earthenware, red and black ware with deep imprints on the inner side, and rim of jars; they

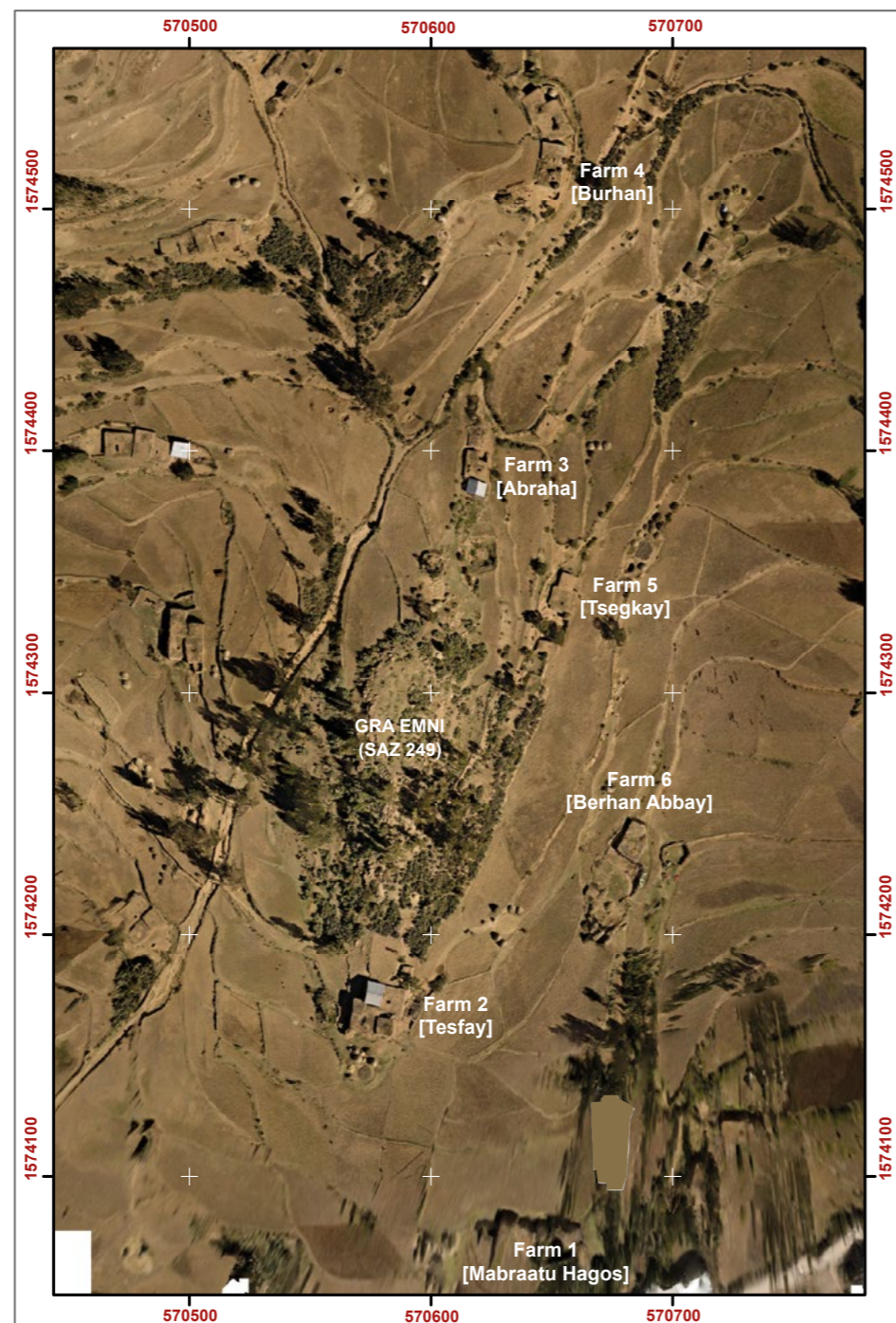

Figure 4: Gra Emni (Saz 249): Distribution of the farms (J. Schiettecatte - MAFTOr).

come from one of his fields. **SOUNDING 4** was opened on an adjacent terrace, west of the farm (fig. 3).

Farm 4 – Owned by Burhan: north of the hill. Along the west and north walls of the farm, the owner has dug a trench in the section of which a 6-m-long dry-stone masonry is visible. It is built with small and medium stones and preserved on 1.2 m high, under c. 50 cm of silt and earth. Down the section, a fragment of red ware with a décor (frieze of dots) seems to be pre-Aksumite. The landowner showed us a selection of stone tools unearthed while digging the trench around the farm: two elongated grinding stones and a cylindrical grinding stone (or mortar). East of Burhan's farm, a small path is bordered by opuntia cactus. According to the landowner, rests of a burial were unearthed while planting opuntia cactus (isolated grave?). North of the farm, the density of scattered surface potsherds decreases rapidly. **SOUNDING 5** was opened west of this farm (fig. 3).

Farm 5 – Owned by Tsegkay: east of the site. The owner showed us an Aksumite pottery assemblage unearthed in an opuntia plantation east of the hilltop. **SOUNDING 3** (fig. 3) was opened on a terrace, east of the site. It was empty of any anthropic remain.

Farm 6 – Owned by Berhan Abbay: south-east of the site. It corresponds to the eastern limit of the potsherds spread.

Setting up the limits of the excavated areas

Five soundings were plotted with the D-GPS and the RTK positioning (fig. 3):

Sounding 1, to the south. This square excavation is 2 × 2 m.

The coordinates (UTM 37P/WGS84) are:

	Easting	Northing	Altitude
NW corner	570661.04	1574095.37	2794.38
SE corner	570663.12	1574093.48	2794.34

Sounding 2, to the south. This rectangular excavation is 8 × 4 m.

The coordinates (UTM 37P/WGS84) are:

	Easting	Northing	Altitude
NW corner	570612.16	1574137.82	2797.21
SE corner	570620.05	1574133.26	2796.54

Sounding 3, to the east was an elongated rectangular trench of 8 × 1 m.

The coordinates (UTM 37P/WGS84) are:

	Easting	Northing	Altitude
NW corner	570633.22	1574238.32	2802.07
SE corner	570641.20	1574237.37	2802.02

Sounding 4, to the centre was a rectangular trench of 7 × 6 m.

The coordinates (UTM 37P/WGS84) are:

	Easting	Northing	Altitude
NW corner	570581.92	1574371.88	2813.76
SE corner	570587.95	1574365.06	2813.75

Sounding 5, to the north was an elongated rectangular trench of 6 × 3 m.

The coordinates (UTM 37P/WGS84) are:

	Easting	Northing	Altitude
NW corner	570639.96	1574528.30	2819.81
SE corner	570642.91	1574522.23	2819.96

Drawing the plans of the soundings and excavated structures

The plans of the soundings were realized from a photogrammetric processing of pictures taken by two Ricoh GR II cameras attached to a pole. Similarly, to that of the site, the photogrammetry was computed with Agisoft Photoscan 1.4, with the following processing sequence:

- aligning photos with a high accuracy; key point limit: 40,000; tie point limit: 1,000;
- building a dense cloud of high quality and aggressive depth filtering;
- building mesh based on the dense cloud, with a high face count and enabling interpolation;
- building a texture with a generic mapping mode, mosaic blending mode and a texture size/count of 8192.

An orthomosaic and a digital elevation model (DEM) of each sounding (excepted the empty Sounding 3) were exported and processed on ESRI ArcMap to produce a map of each of them. The maps were exported in *.ai format and CAD was realized on Adobe Illustrator CS 2020 software.

For Soundings 1, 2, 4 and 5, the number of pictures and anchorage references of the photogrammetry are as follow (fig. 5):

Sounding	Size	Number of aligned cameras	Number of D-GPS spatial references
Sounding 1	2 × 2 m	33	4
Sounding 2	8 × 4 m	112	12
Sounding 4	7 × 6 m	57	8
Sounding 5	6 × 3 m	81	4

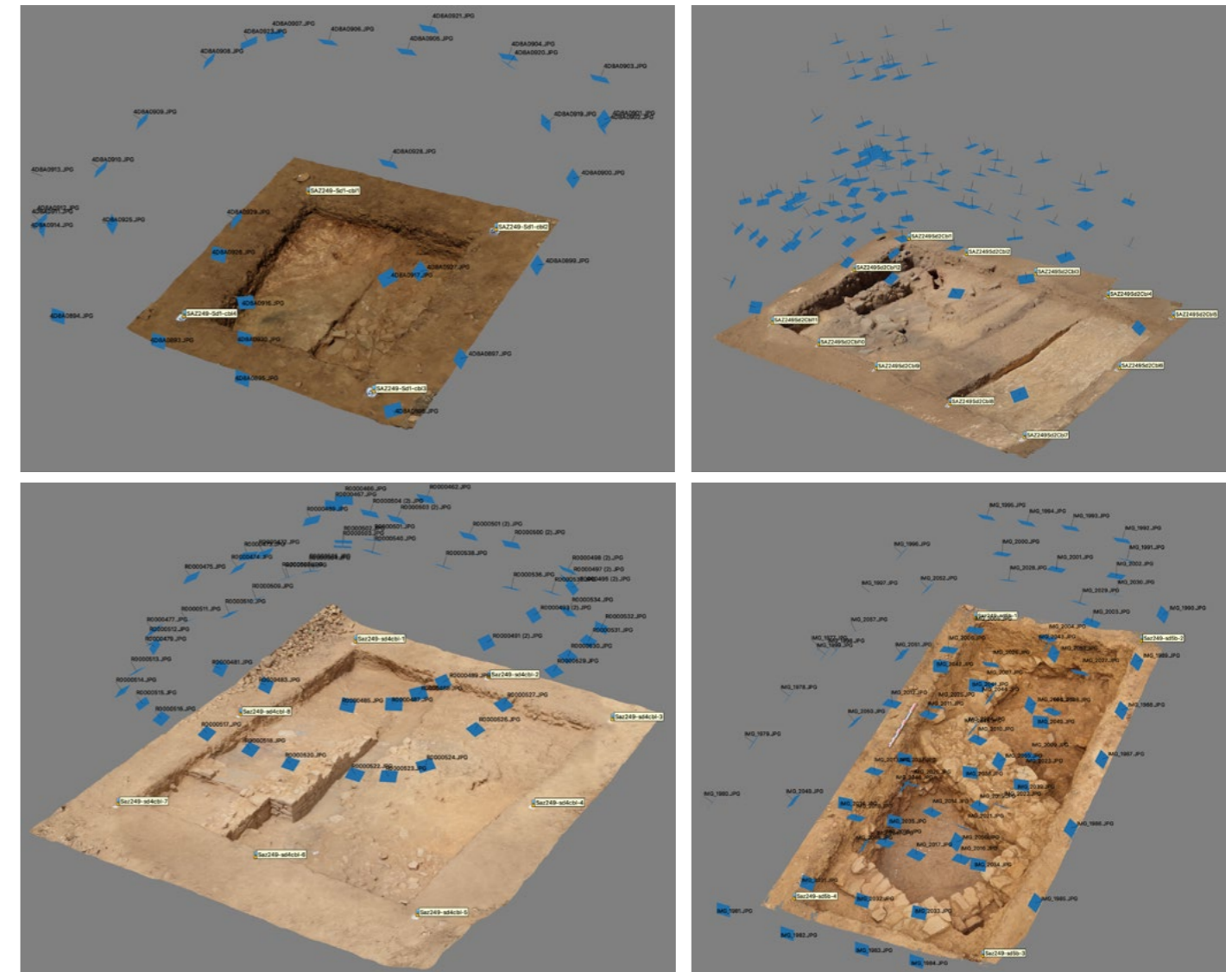

Figure 5: Distribution of the kite aerial pictures and D-GPS anchorage references for (a) Sounding 1; (b) Sounding 2; (c) Sounding 4; (d) Sounding 5 (J. Schiettecatte - MAFTOr).

GEOPHYSICAL SURVEY OF GRA EMNI (SAZ 249) AND WARAGENA (SAZ 256 & 266)

Rozan AL KHATIB ALKONTAR (University of Strasbourg, UMR 7516 IPGS-EOST)

Hugo REILLER (CNRS, UMR 7516 IPGS-EOST)

Introduction

Geophysics allow to study the nature and the structure of the subsurface by imaging anomalies due to contrasts of physical parameters; with the magnetic method it is contrasts of magnetization that are characterised. This method allows to make surveys in a non-destructive way. It is based on the measurement of the earth magnetic field to identify anomalies due to archaeological remains like walls, foundations, kilns, ditches. This kind of structures can generate local anomalies in the earth magnetic field if they show a strong enough magnetization contrast with their surroundings.

In this Ethiopian case study, magnetic surveys have two goals: guide the excavation and understand the spatial distribution of remains at a scale larger than the excavations.

Two locations have been surveyed: Gra Emni (SAZ 249) and Waragena (SAZ 256 and 266) (**fig. 1**).

At Gra Emni, we did the magnetic surveys where archaeologists found clues of Aksumite occupation: the survey area corresponds to the place where large amounts of potteries were found on the soil.

At Waragena, the survey area is close to archaeological sites located in 2017, but not excavated so far. The magnetic survey was done to assess the presence and distribution of remains.

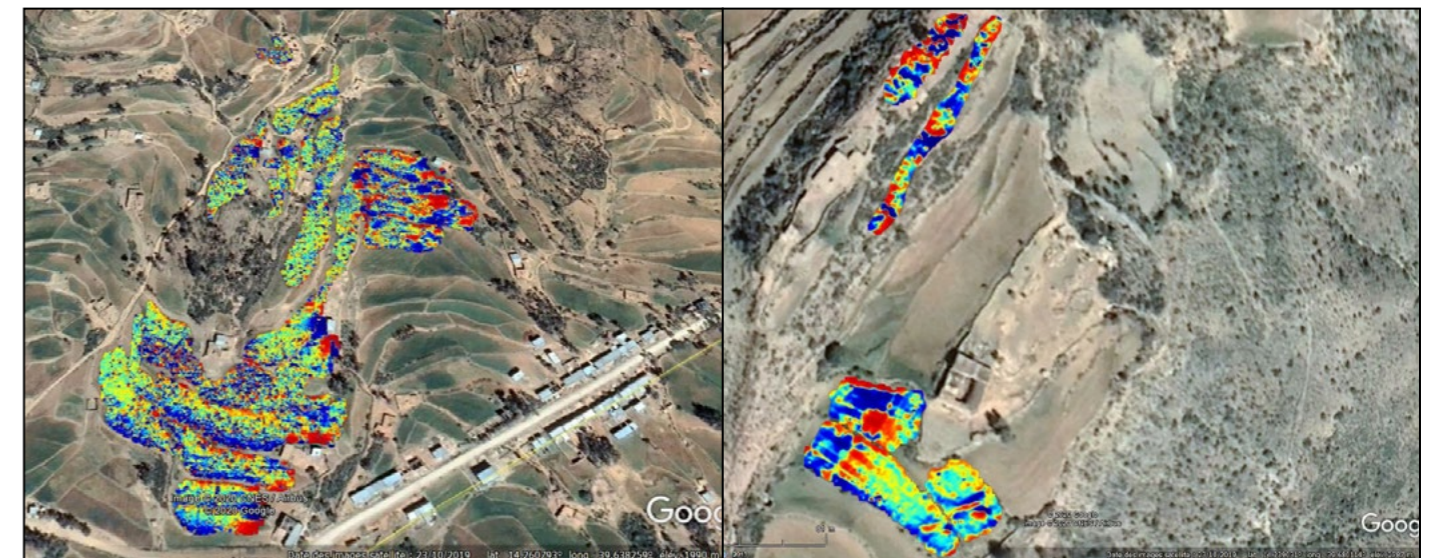

Figure 1: Sites of magnetic surveys: Gra Emni (left) and Waragena (right) (R. Al Khatib Alkontar, H. Reiller – MAFTOr/IPGS-EOST).

Material and metrology

Measurements are done with a device developed by IPGS and constituted of a stick at the end of which are placed six fluxgate magnetic sensors. The stick is fixed on a backpack bearing a digitizer and GPS/GNSS antenna (**fig. 2**). After acquisition, data are computed to make maps of the intensity anomaly of the earth magnetic field in order to spot anomalies that could be linked to archaeological remains.

Equipment:

- Electronic 15F8 (IPGS/Diefi)
- 3 components fluxgate magnetometer (Bartington MAG03MC)
- Backpack and aluminium stick
- Head mounted display
- GNSS antenna (Trimble R4)

Protocol of data acquisition:

1) Calibration and compensation procedure.
 2) Acquisition of the profiles. Six magnetometers are placed at around 0.3 m above the ground to measure 6 magnetic profiles simultaneously every 0.5 m. Then, we proceed to the acquisition of the tie-lines. Magnetic data are measured at a frequency of 25 Hz. GNSS data are measured at a frequency of 1 Hz.

3) Calibration and compensation procedure.

Tie-line: the operator makes profiles perpendicularly to the magnetic profiles at approximately every 10 m to make a quality control of the measurement at the crossing points and to be used to correct micro-levelling effect during the data processing.

The intensity anomaly of the magnetic field is computed by removing a constant to each profile so as to minimize the standard deviation at the crossing points.

The map of the anomaly is a grid with a fixed step of 0.25 m where the fit with the data is partly defined by the “smooth parameter” chosen by the operator.

Two types of color scale are proposed to represent the map of the intensity anomaly of the magnetic field:

- “equipopulation” scale (each colour of the scale has the same number of pixel on the map. This representation allows the identification of a large range of anomalies).
- “linear” scale.

To better identify anomalies due to shallow structures, the vertical derivative operator is applied to the maps of the intensity anomaly of the magnetic field.

The work of interpretation consists in highlighting the clearest lineations. They do not necessarily indicate the presence of archaeological remains.

The colour scale of the map of the intensity anomaly of the magnetic field is in nanotesla (nT). The colour scale of the maps of the vertical derivative is in nT/m. The axes of the maps are in metre.

Gra Emni (SAZ 249)

The site is divided in several terraces used for farming. A large amount of rocks is present on the surface. The rocks were probably excavated during the tilling of fields and it is possible that they come from archaeological remains (wall or foundations). Moreover, the action of tilling may lead to have a first layer of around 0.3 m deep that is a mix of sediment and blocks coming from archaeological structures.

The survey on this site lasted eight days.

6 March 2020

The first step is to setup the device; it took around 2 hours with no particular problems.

The second step is to find a place to make the calibration and the compensation procedure.

First test

Name of the file: 15F8105_20200306063338.txt. Beginning: 06:33:41 End: 06:51:49.

The standard deviation after correction is included between 1.3 and 5 nT (fig. 3).



Figure 2: Measuring device developed by IPGS with six magnetometers (N. Blond – MAFTOr).

We want to reach a standard deviation after correction less than 1 nT for each magnetometer in order to assess subtle variations of the intensity of the magnetic field that could be linked to the remains.

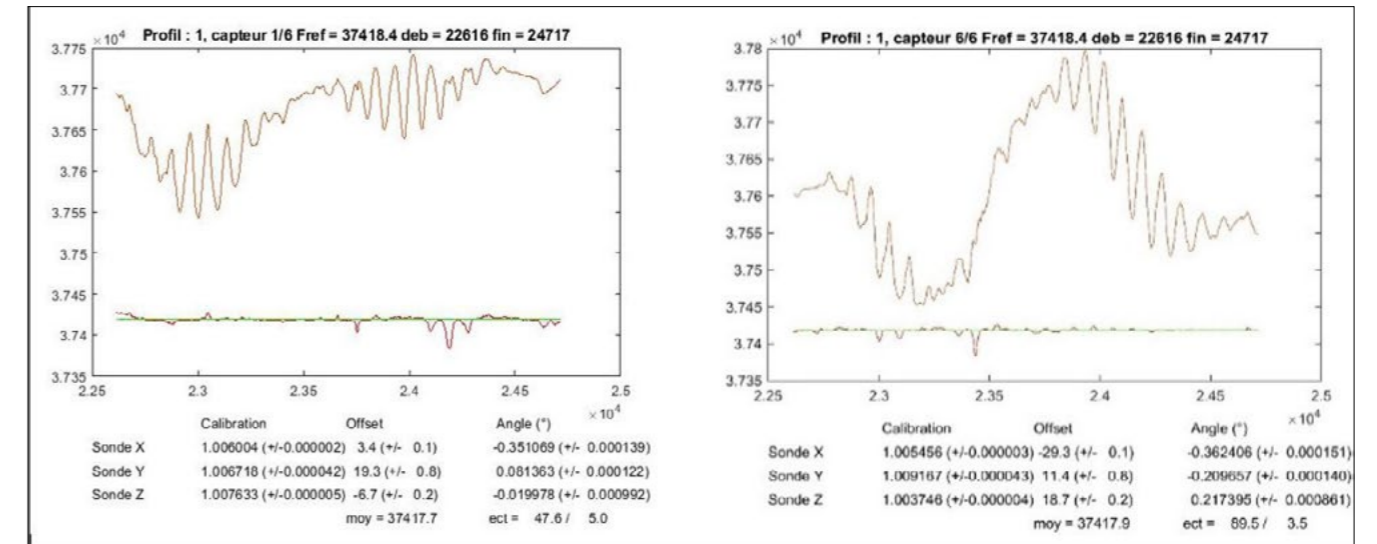

Figure 3: First test - Compensation/calibration of the magnetometer with the highest standard deviation after correction that correspond to the magnetometer placed at the extremities of the stick (R. Al Khatib Alkontar, H. Reiller – MAFTOr/IPGS-EOST).

Second test: a second place with less rock on the surface was chosen.

Name of the file: 15F8105_20200306070807.txt. Beginning: 07:08:10 End: 07:11:11.

The standard deviation after correction is included between 0,9 and 1,4 nT (fig. 4).

The limit of 1 nT for each magnetometer is still not reached.

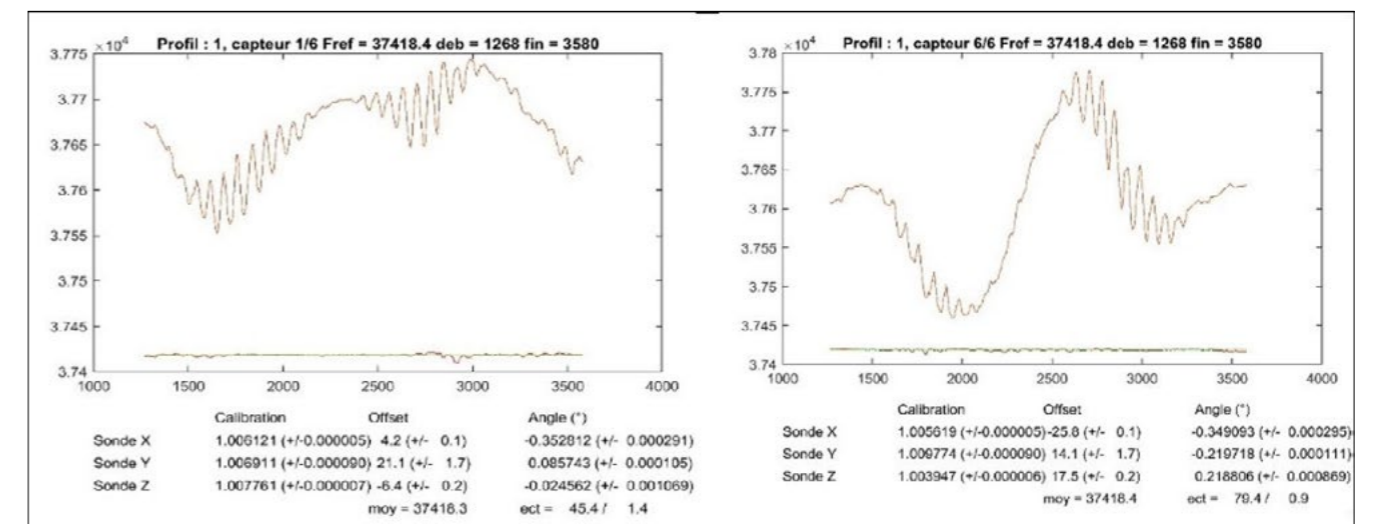

Figure 4: Second test - Compensation/calibration of the magnetometer with the highest standard deviation after correction that correspond to the magnetometer placed at the extremities of the stick (R. Al Khatib Alkontar, H. Reiller – MAFTOr/IPGS-EOST).

Third test: the area of the first test was cleaned (fig. 5): rocks on the surface were put aside of the area.

Name of file 15F8105_20200306073058.txt. Beginning: 07:31:01 End: 07:33:46.

The standard deviation after correction is between 0.4 and 0.8 nT (fig. 6).

This place was chosen to make the calibration and compensation procedure as often as possible. Now that the place to make the compensation and calibration procedure is found, the magnetic prospection of terraces can start.



Figure 5: First place of compensation/calibration before (left) and after cleaning (right) (R. Al Khatib Alkontar, H. Reiller – MAFTOr/IPGS-EOST).

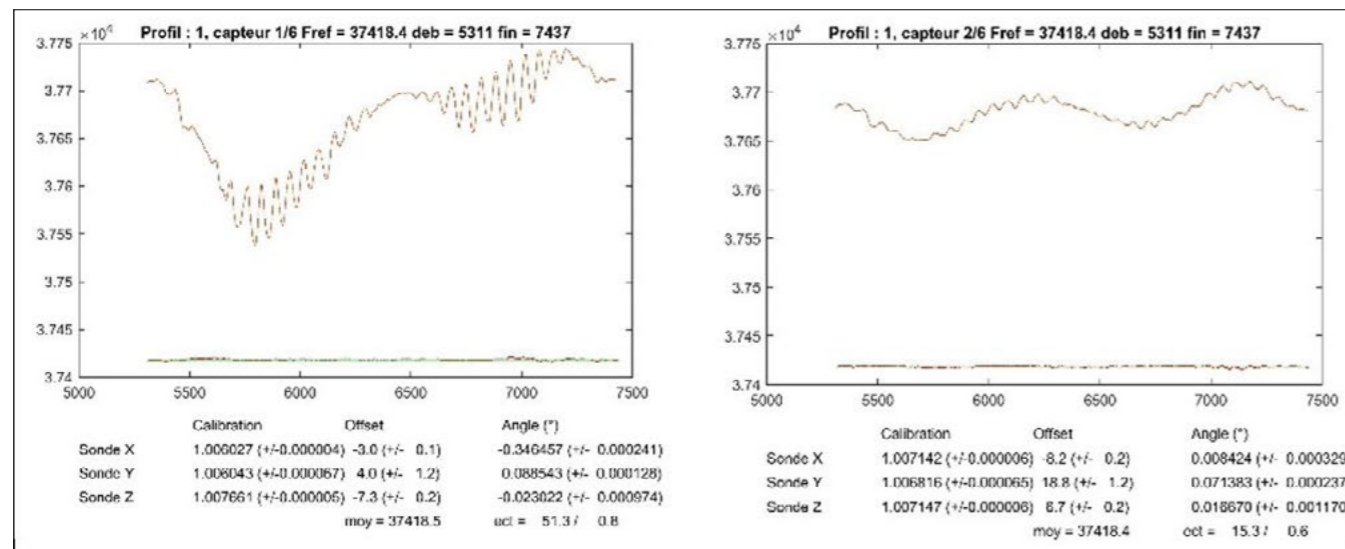

Figure 6: Third test - Compensation/calibration of the magnetometer with the highest standard deviation after correction (R. Al Khatib Alkontar, H. Reiller – MAFTOr/IPGS-EOST).

Terrace 1: 67 profiles (fig. 7).

Name of file: 15F8105_20200306074938.txt

Beginning: 07:50:53 End: 09:29:00.

Terrace 2: 22 profiles (fig. 8).

Name of file: 15F8105_20200306094051.txt

Beginning: 09:40:55 End: 10:18:47.

Magnetic maps of the terrace 2: Only one lineation is highlighted on the map of the vertical derivative (fig. 10).

In order to check if this anomaly is due to archaeological remains, especially a wall or a foundation, a decision to make an East-West trench crossing this anomaly is taken with the archaeologists. This excavation was finished on 10 March and results are developed below (See “Comparison between magnetic data and archaeological excavations - terrace 2”). Generally, the maps on figs. 9-10 are characterised by a large number of dipolar anomalies. A part of them could be due to rocks on the surface.



Figure 7: Profiles and tie-lines on terrace 1 (R. Al Khatib Alkontar, H. Reiller – MAFTOr/IPGS-EOST).



Figure 8: Profiles and tie-lines on terrace 2 (R. Al Khatib Alkontar, H. Reiller – MAFTOr/IPGS-EOST).

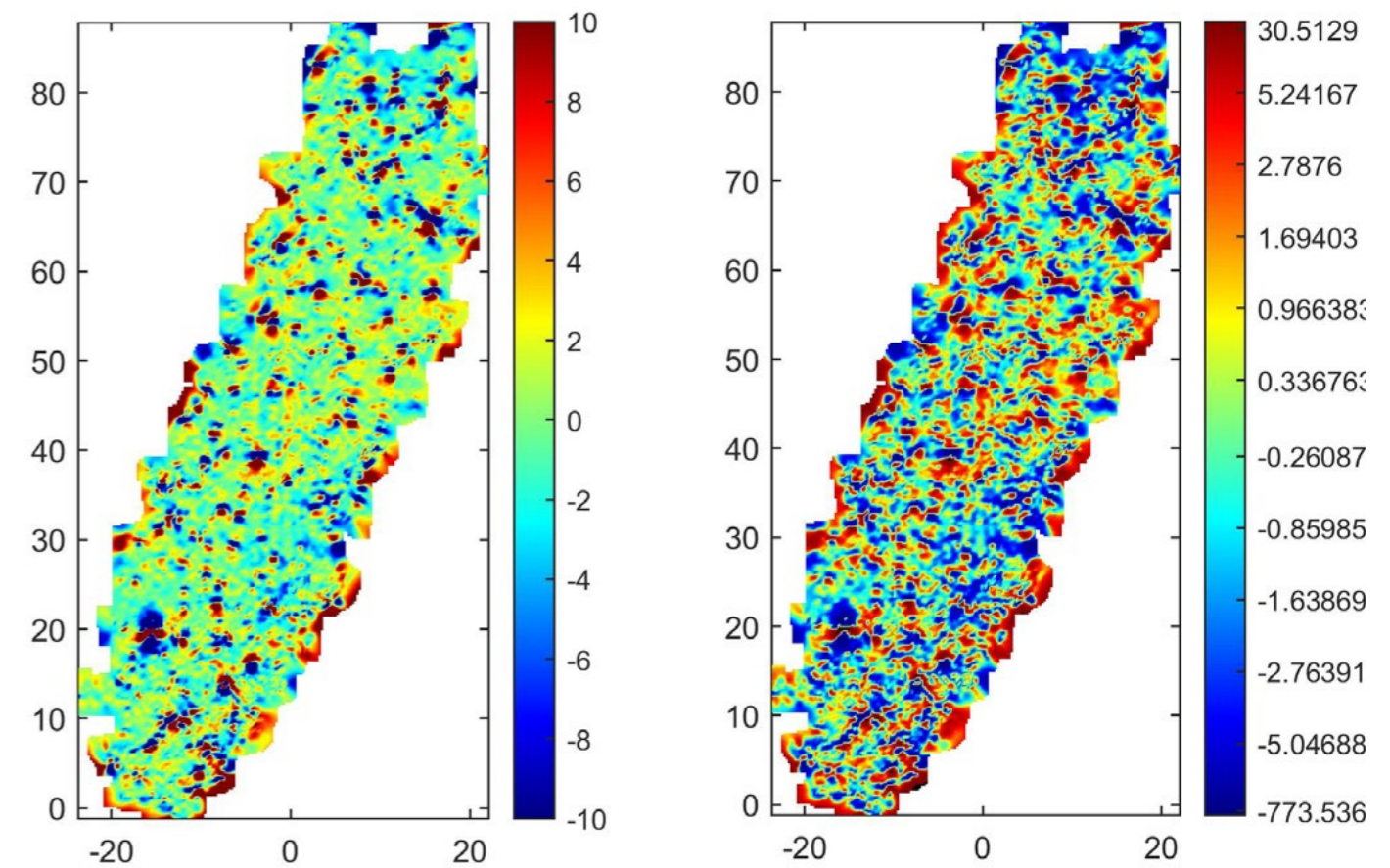

Figure 9: Map of the intensity anomaly of the total magnetic field of terrace 2 with the “linear” scale (left) and “equipopulation” scale (right) (R. Al Khatib Alkontar, H. Reiller – MAFTOr/IPGS-EOST).

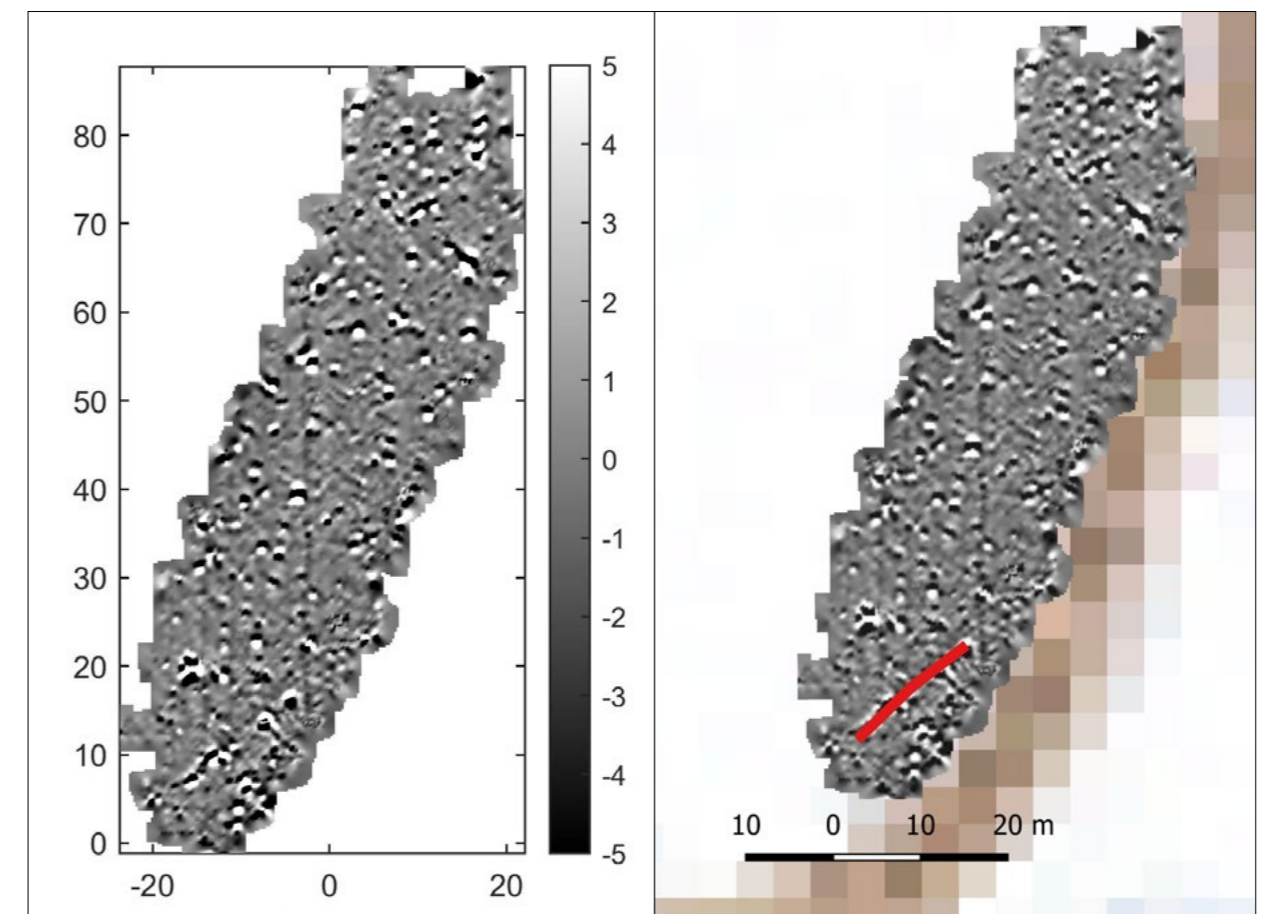

Figure 10: Map of the vertical derivative of the intensity anomaly of the total magnetic field of terrace 2 at the order 1 and the interpretation (red lineation) (R. Al Khatib Alkontar, H. Reiller – MAFTOr/IPGS-EOST).

7 March 2020

119 profiles were made.

Terrace 3 (fig. 11)

Name of file: 15F8105_20200307060520.txt.

Beginning: 06:07:15.9 End: 08:15:37.2.

Name of file: 15F8105_20200307082452.txt.

Beginning: 08:24:57 End: 09:06:34.

Terrace 4 (fig. 11)

Name of file: 15F8105_20200307094057.txt.

Beginning: 09:40:59 End: 10:14:25.

Magnetic maps of the terraces 1, 3 and 4:

Data of the three terraces are combined to make one magnetic map (fig. 12). On that map, the two big anomalies (several hundred of nT) highlighted with black circles are due to modern houses. The data corresponding to these structures are removed (fig. 13) to avoid potential issues with further computation linked to the fact that they do not appear complete (only part of the whole anomalies is visible on fig. 12).

On the map of the vertical derivative (fig. 14), it is possible to identify several lineations. The two lineations named 1 and 2 on fig. 14 are due to limits of terraces marked by piles of stones on the field. For the other highlighted lineations, if there are no structures on the surface, that means that the anomalies are due to shallow structures.

Generally, the maps on figs. 13-14 are characterised by a large number of dipolar anomalies. Part of them could be due to rocks on the surface.



Figure 11: Profiles and tie-lines on terraces 1, 3, and 4 (R. Al Khatib Alkontar, H. Reiller – MAFTOr/IPGS-EOST).

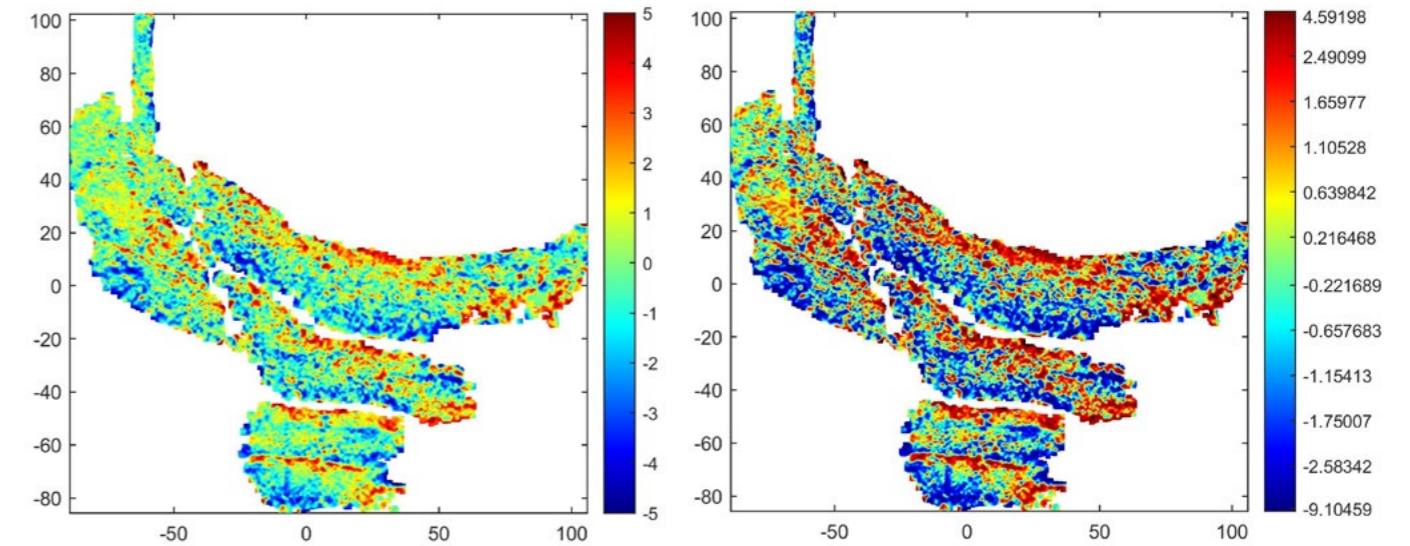

Figure 13: Map of the intensity anomaly of the total magnetic field of terraces 1, 3 and 4 with the “linear” scale (left) and with the “equipopulation” scale (right) (R. Al Khatib Alkontar, H. Reiller – MAFTOr/IPGS-EOST).

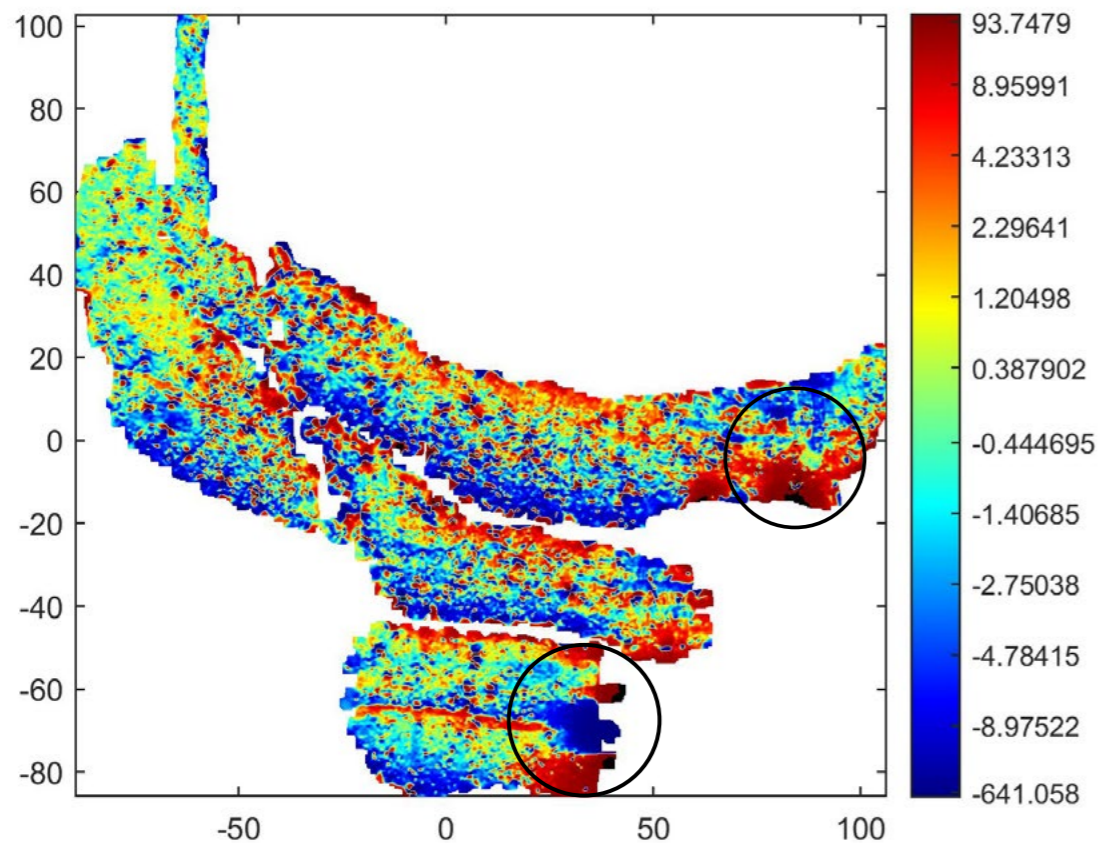

Figure 12: Map of the intensity anomaly of the total magnetic field of terraces 1, 3 and 4 with the “equipopulation” scale (R. Al Khatib Alkontar, H. Reiller – MAFTOr/IPGS-EOST).

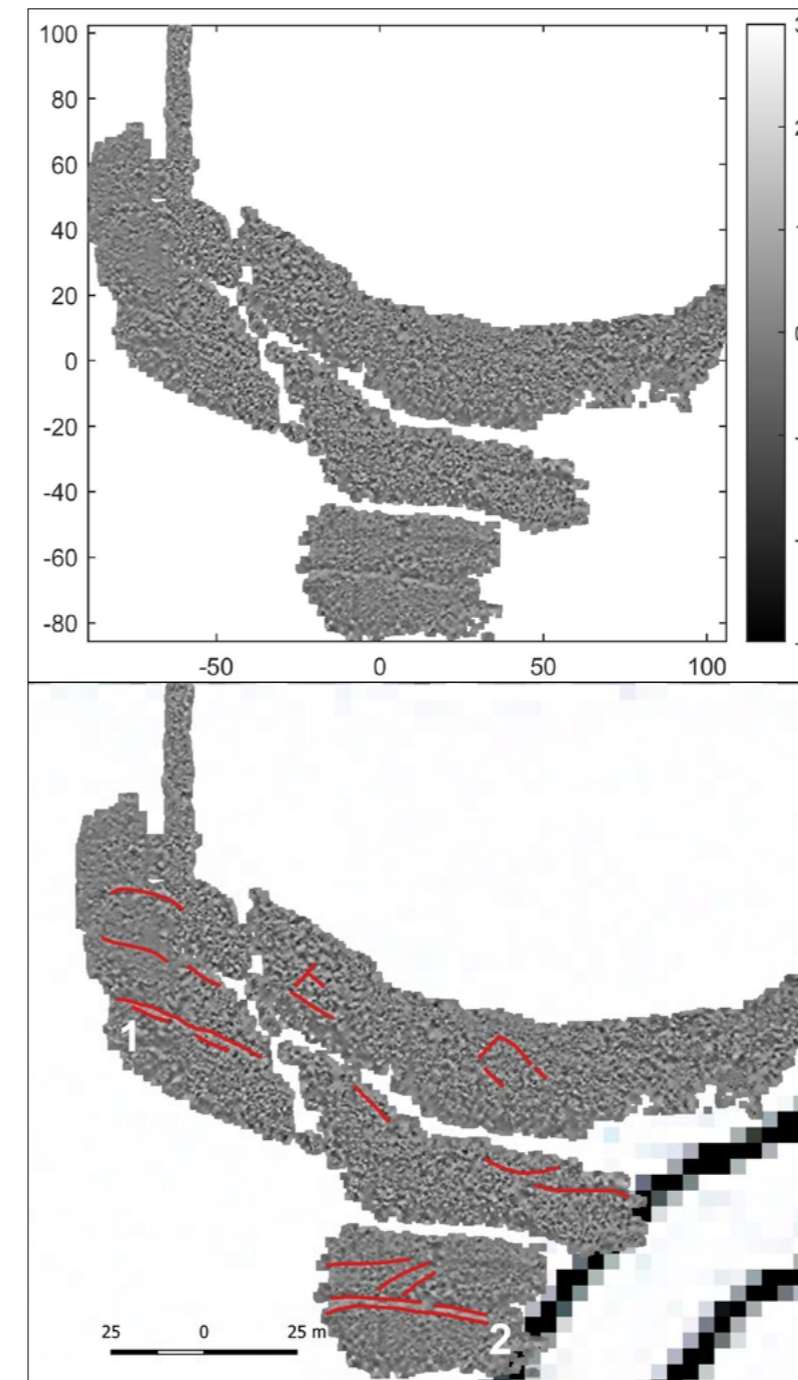

Figure 14: Map of the vertical derivative of the intensity anomaly of the total magnetic field of terraces 1, 3 and 4 at the order 1 (up) with the interpretation (red lineation) on a QGIS background (bottom) (R. Al Khatib Alkontar, H. Reiller – MAFTOr/IPGS-EOST).

9 March 2020

118 profiles were made.

Name of file: 15F8105_20200309054602.txt. Beginning: 05:46:24 End: 07:57:32.

Name of file: 15F8105_20200309080554.txt. Beginning: 08:09:30.9 End: 09:35:51.

There is a problem of synchronisation of GNSS data in these two files of data: these data are not processed to make a magnetic map. Survey on this area was repeated on 12 and 13 March.

At the end of the morning, archaeologists have found a terrace (Terrace 5) where they suspected the presence of walls or foundations thanks to a cross section at the edge of the terrace. Before any excavation, we decided to make a survey in this area; the comparison between the magnetic data and the archaeological excavation is more widely discussed below (See “Comparison between magnetic data and archaeological excavations - terrace 5”).

Terrace 5: 40 profiles (fig. 15)

Name of file: 15F8105_20200309094534.txt.

Beginning: 09:47:05 End: 10:50:52.

Magnetic maps of the terrace 5:

At the south of the map of the vertical derivative signal (fig. 17), a structure with a square shape is highlighted. Generally, the maps on figs. 16-17 are characterised by a large number of dipolar anomalies. A part of them could be due to rocks on the surface.

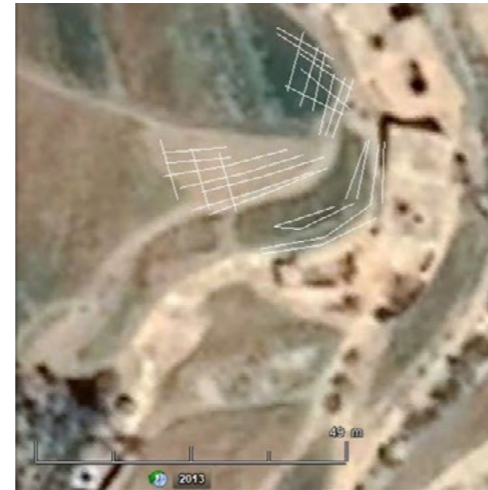

Figure 15: Profiles and tie-lines on terrace 5 (R. Al Khatib Alkontar, H. Reiller – MAFTOr/IPGS-EOST).

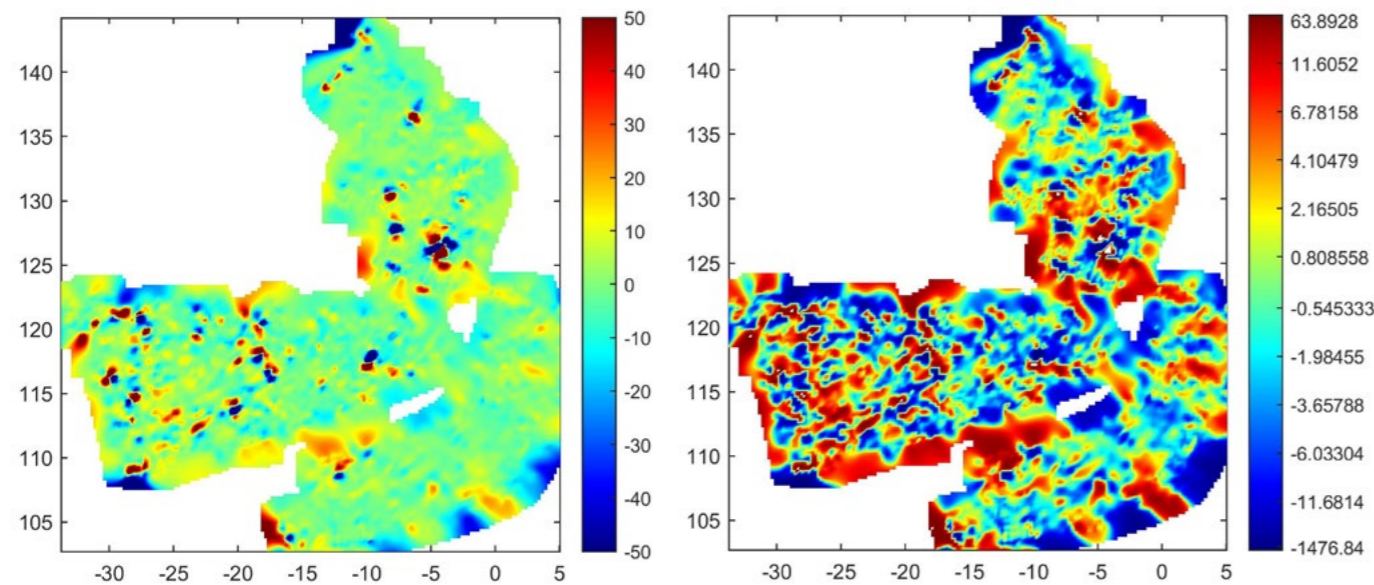

Figure 16: Map of the intensity anomaly of the total magnetic field of terrace 5 with the “linear” scale (left) and “equipopulation” scale (right) (R. Al Khatib Alkontar, H. Reiller – MAFTOr/IPGS-EOST).

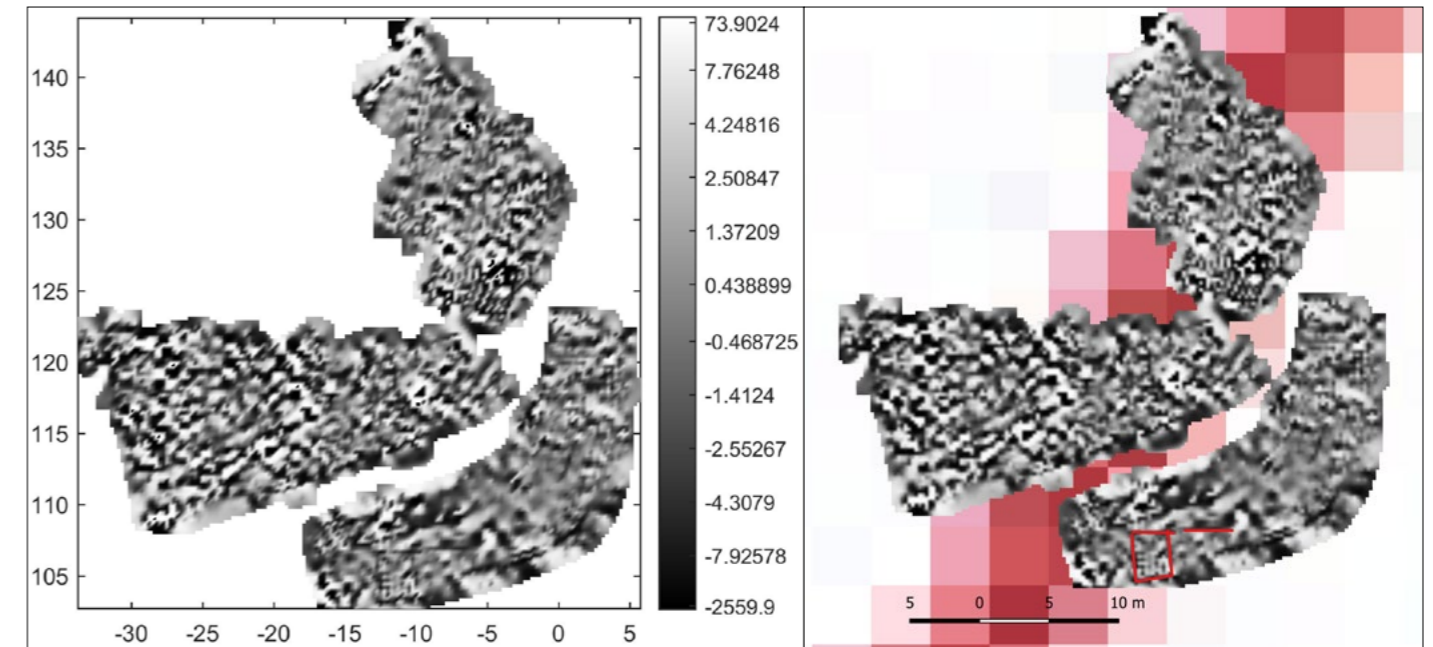

Figure 17: Map of the vertical derivative of the intensity anomaly of the total magnetic field of terrace 5 at the order 1 (left) with the interpretation (red line) on a QGIS background (right) (R. Al Khatib Alkontar, H. Reiller – MAFTOr/IPGS-EOST).

10 March 2020

135 profiles were made.

Thanks to information coming from a local farmer, archaeologists suspected the presence of walls or foundations on a terrace (Terrace 6). Before any excavation, we decided to make a survey in this area; the comparison between the magnetic data and the archaeological excavation is more widely discussed below (See “Comparison between magnetic data and archaeological excavations - terrace 6”).

Terrace 6: (fig. 18)

Name of file: 15F8105_20200310045732.txt.

Beginning: 04:59:57 End: 06:21:53.

Terrace 7: (fig. 18)

Name of file: 15F8105_20200310065407.txt.

Beginning: 06:54:10 End: 08:34:16.

11 March 2020

120 profiles were made.

Terrace 8: (fig. 18)

Name of file: 15F8105_20200311052858.txt.

Beginning: 05:30:30 End: 06:58:51.

Terrace 9: (fig. 18)

Name of file: 15F8105_20200311071317.txt.

Beginning: 07:13:18 End: 09:26:16.

Magnetic maps of the terraces 6, 7, 8 and 9:

Data of the four terraces are combined to make one magnetic map (figs. 19-20). Several lineations are highlighted on the map of the vertical derivative (fig. 21). If there are no structures on the surface, that means that the anomalies are due to shallow structures. Generally, the maps on figs. 19-21 are characterised by a large number of dipolar anomalies. A part of them could be due to rocks on the surface.

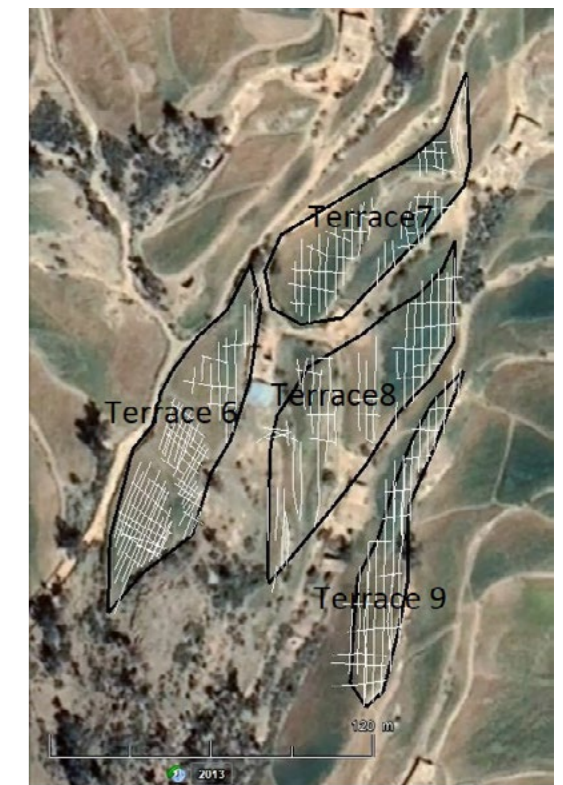

Figure 18: Profiles and tie-lines on terraces 6, 7, 8, and 9 (R. Al Khatib Alkontar, H. Reiller – MAFTOr/IPGS-EOST).

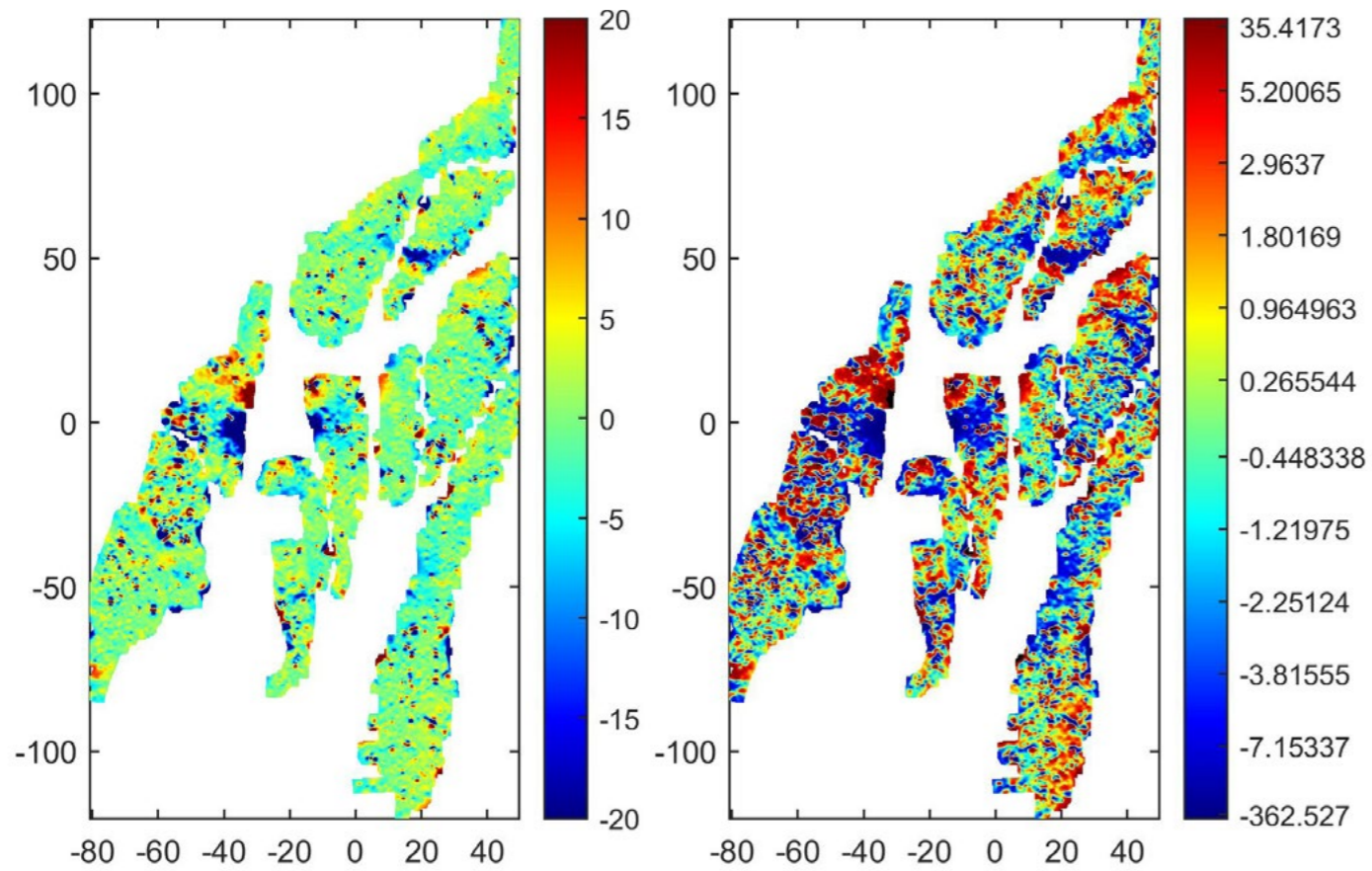

Figure 19: Map of the intensity anomaly of the total magnetic field of terraces 6, 7, 8, and 9 with the “linear” scale (R. Al Khatib Alkontar, H. Reiller – MAFTOr/IPGS-EOST).

Figure 20: Map of the intensity anomaly of the total magnetic field of terraces 6, 7, 8, and 9 with the “equipopulation” scale (R. Al Khatib Alkontar, H. Reiller – MAFTOr/IPGS-EOST).

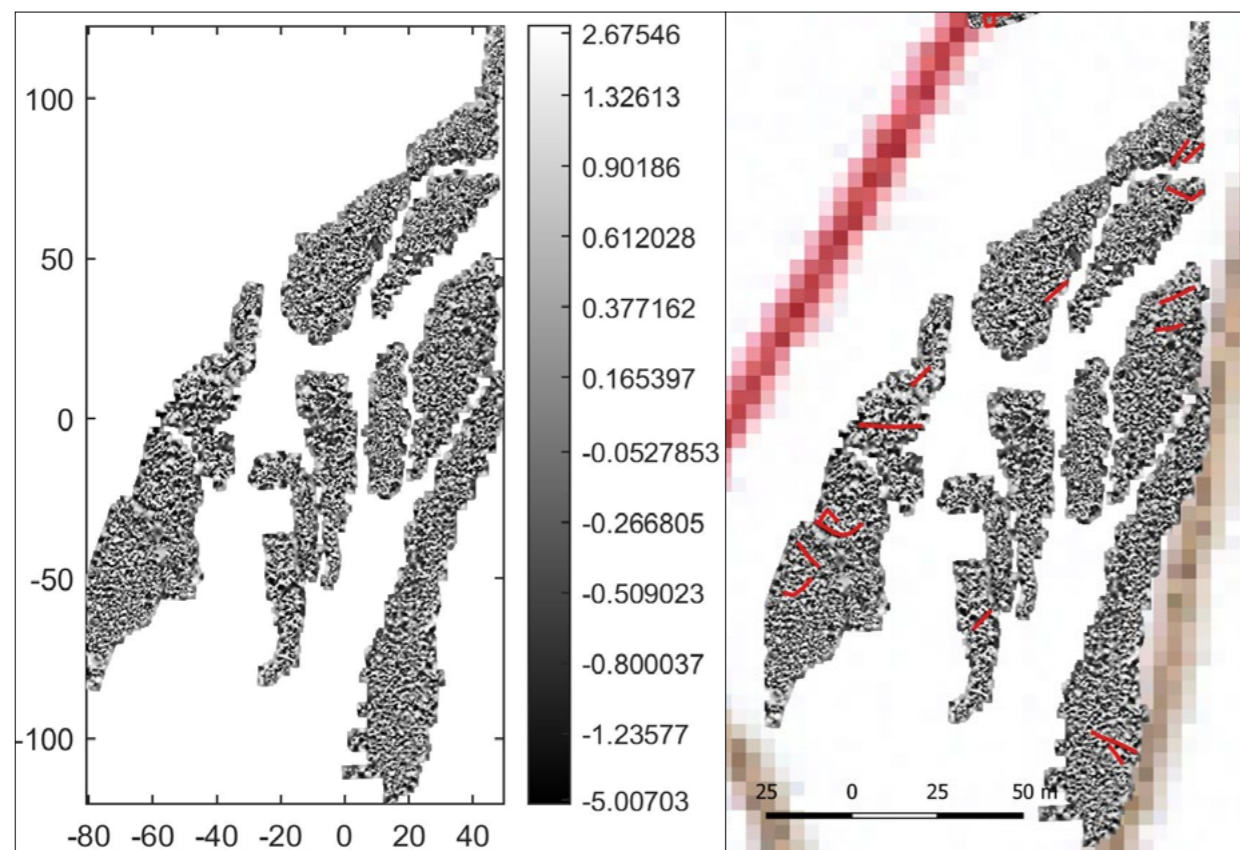

Figure 21: Map of the vertical derivative of the intensity anomaly of the total magnetic field of terrace 6, 7, 8, and 9 at the order 1 (left) with the interpretation (red lineation) on a QGIS background (right) (R. Al Khatib Alkontar, H. Reiller – MAFTOr/IPGS-EOST).

12 March 2020

117 profiles were made.

Terrace 10: (fig. 22)

Name of file: 15F8105_20200312042100.txt.

Beginning: 04:22:26 End: 06:31:15.

Terrace 11: (fig. 22)

Name of file: 5F8105_20200312063824.txt.

Beginning: 06:39:52 End: 08:14:10.

Terrace 12: (fig. 22)

Name of file: 15F8105_20200312142853.txt.

Beginning: 14:28:56 End: 14:57:59.



Figure 22: Profiles and tie-lines on terraces 10, 11, and 12 (R. Al Khatib Alkontar, H. Reiller – MAFTOr/IPGS-EOST).

Magnetic maps of the terraces 10, 11 and 12:

Data of the three terraces are combined to make one magnetic map (fig. 23).

The lineation highlighted on the terrace 12 is characterised by a shape with a right angle. Due to this particularity, this anomaly could be due to archaeological remains.

There are more dipole anomalies on the map of terrace 10 than on the map of terraces 11 and 12. On the field, we observed that there are more rocks on the surface on the terrace 10 than on the terrace 11 (fig. 24).

The quantity of rocks on the surface and the quantity of dipolar anomalies could be linked.

The black circle at the east of the terrace 12 on the fig. 23 identifies an anomaly due to a modern house. The data corresponding to these structures are removed to calculate the map of the vertical derivative (fig. 25) where several lineations are highlighted.

If there are no structures on the surface, that means that the anomalies are due to shallow structures. The anomaly with a shape of right angle highlighted on the fig. 23 can still be identified.

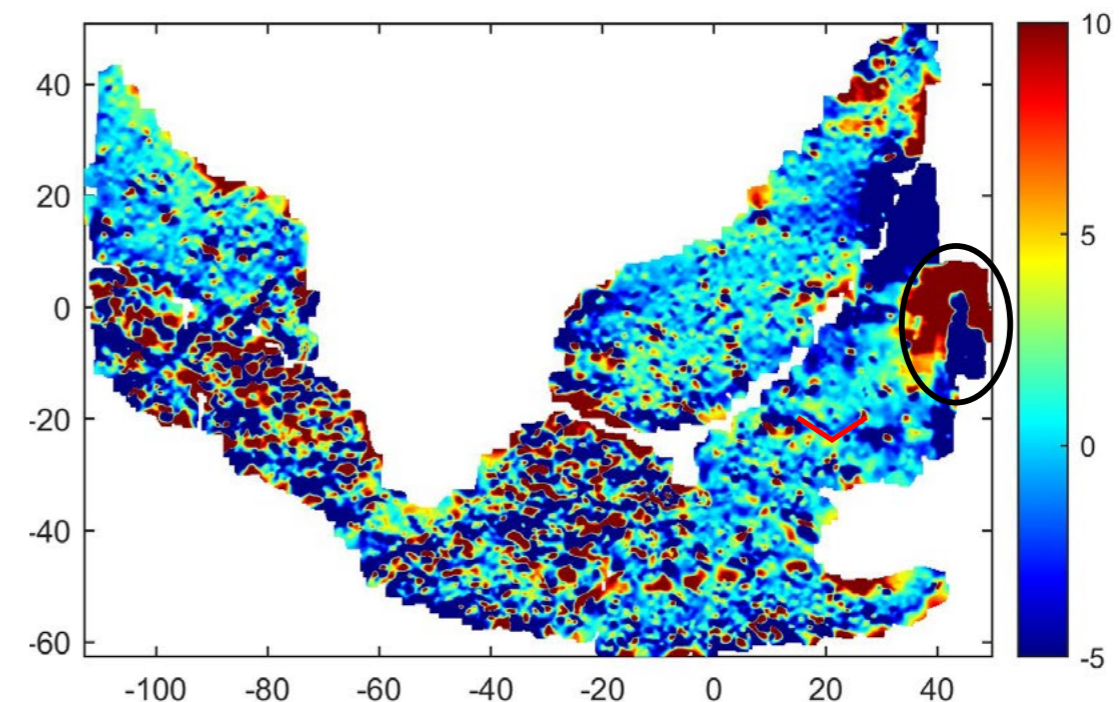

Figure 23: Map of the intensity anomaly of the total magnetic field of terraces 10, 11, and 12 with the “linear” scale with the interpretation (red lineation) (R. Al Khatib Alkontar, H. Reiller – MAFTOr/IPGS-EOST).



Figure 24: Photographs of terraces 10 (left) and 11 (right) (R. Al Khatib Alkontar, H. Reiller – MAFTOr/IPGS-EOST).

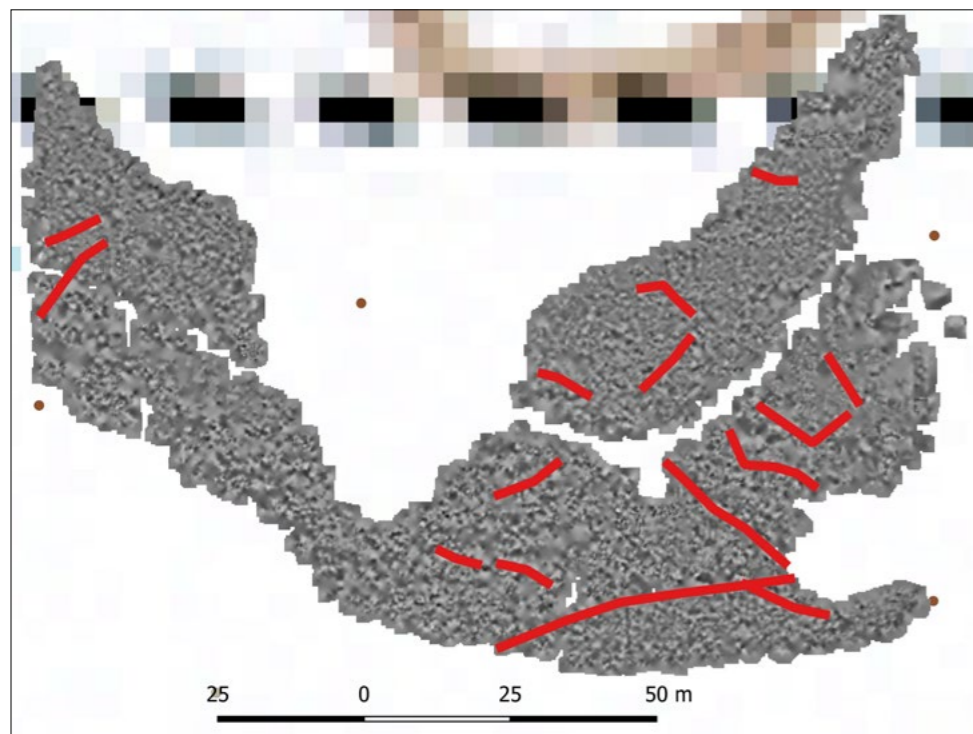
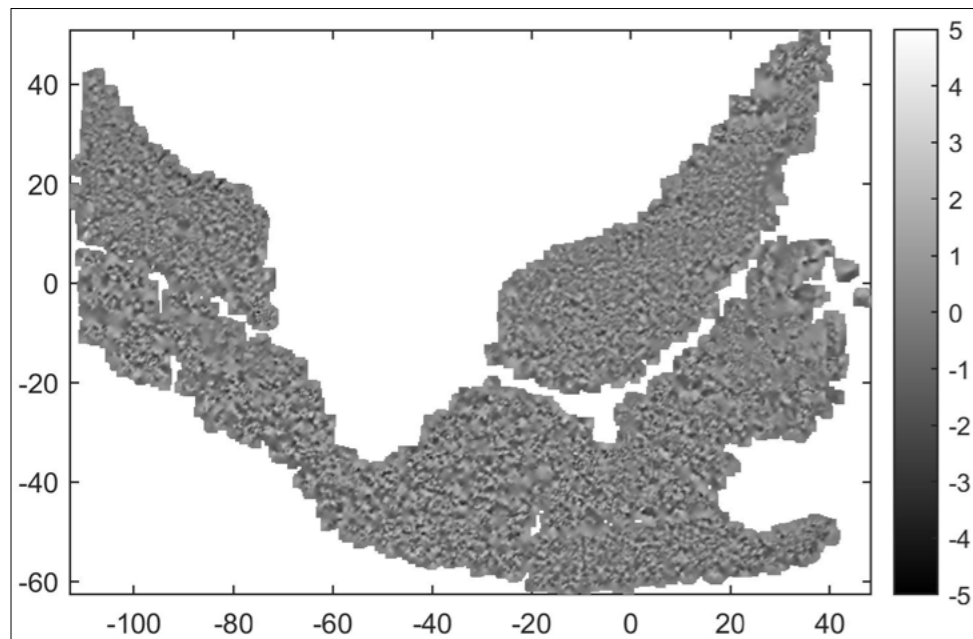

Figure 25: Map of the vertical derivative of the intensity anomaly of the total magnetic field of terraces 10, 11, and 12 at the order 1 (up) with the interpretation (red lineation) on a QGIS background (bottom) (R. Al Khatib Alkontar, H. Reiller – MAFTOr/IPGS-EOST).

13 March 2020

161 profiles were made.

Terrace 13: (fig. 26)

Name of file: 15F8105_20200313051132.txt.

Beginning: 05:11:36 End: 08:01:54.

Name of file: 15F8105_20200313082819.txt.

Beginning: 08:29:58 End: 09:57:32.

Terrace 14: (fig. 26)

Name of file: 15F8105_20200313082819.txt.

Beginning: 08:29:58 End: 09:57:32.

Name of file: 15F8105_20200313131001.txt.

Beginning: 13:10:10 End: 13:54:02.

14 March 2020

Terrace 15: (fig. 26)

Name of file: 15F8105_20200314043933.txt.

Beginning: 04:39:58 End: 06:24:35.

Name of file: 15F8105_20200314062903.txt.

Beginning: 06:29:06 End: 08:20:37.

Name of file: 15F8105_20200314082753.txt.

Beginning: 08:27:55.8 End: 09:17:17.

Magnetic map of the terraces 13, 14 and 15

Data of the three terraces are combined to make one magnetic map (fig. 27).

A separation between the east and the west of the map is highlighted on the fig. 27. The West is characterised by a larger number of dipolar anomalies. The east is characterised by low frequency anomalies due to the topography or geological contrasts.

The dark contrast to the north-east of the map (fig. 27) identifies an anomaly due to a modern house.

Several lineations are highlighted on the map of the vertical derivative (fig. 28).

The two lineations named 1 and 2 on fig. 28 are due to limits of terraces marked by piles of stones on the field. For the others highlighted lineations, if there are no structures on the surface, that means that the anomalies are due to shallow structures.

Conclusions

The method used does not allow the identification of the spatial distribution of remains of Aksumite building at a large scale. The shape of most of the highlighted lineations does not allow to strongly suspect the presence of archaeological remains; for example right angles are rarely identified. The lineations highlighted do not necessarily indicate the presence of archaeological remains.

It seems that there is a link between the quantity of rocks on the surface and the quantity of dipole anomalies on the magnetic maps. Note that a few numbers of metallic garbage and several high magnetization rocks were found on the field; this type of object can also provoke dipole anomalies.



Figure 26: Profiles and tie-lines on terraces 13, 14, and 15 (R. Al Khatib Alkontar, H. Reiller – MAFTOr/IPGS-EOST).

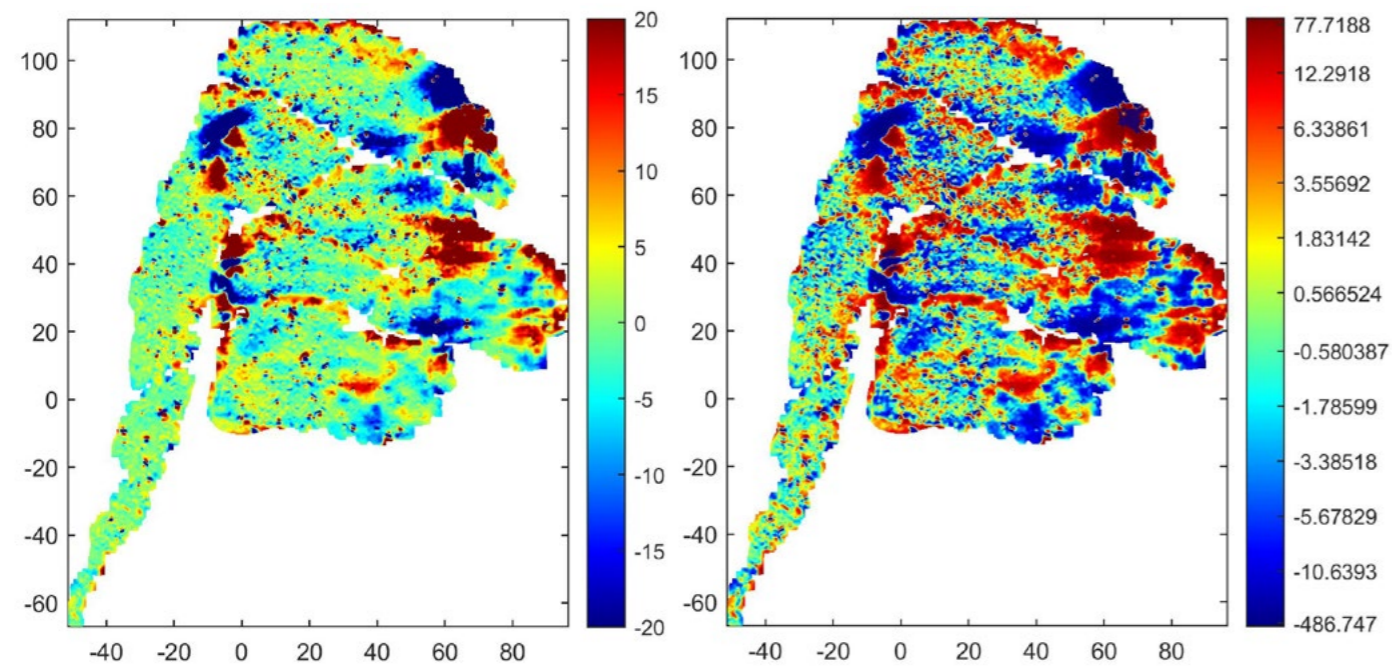

Figure 27: Map of the intensity anomaly of the total magnetic field of terraces 13, 14, and 15 with the “linear” scale (left) and with the “equipopulation scale” (right) (R. Al Khatib Alkontar, H. Reiller – MAFTOr/IPGS-EOST).

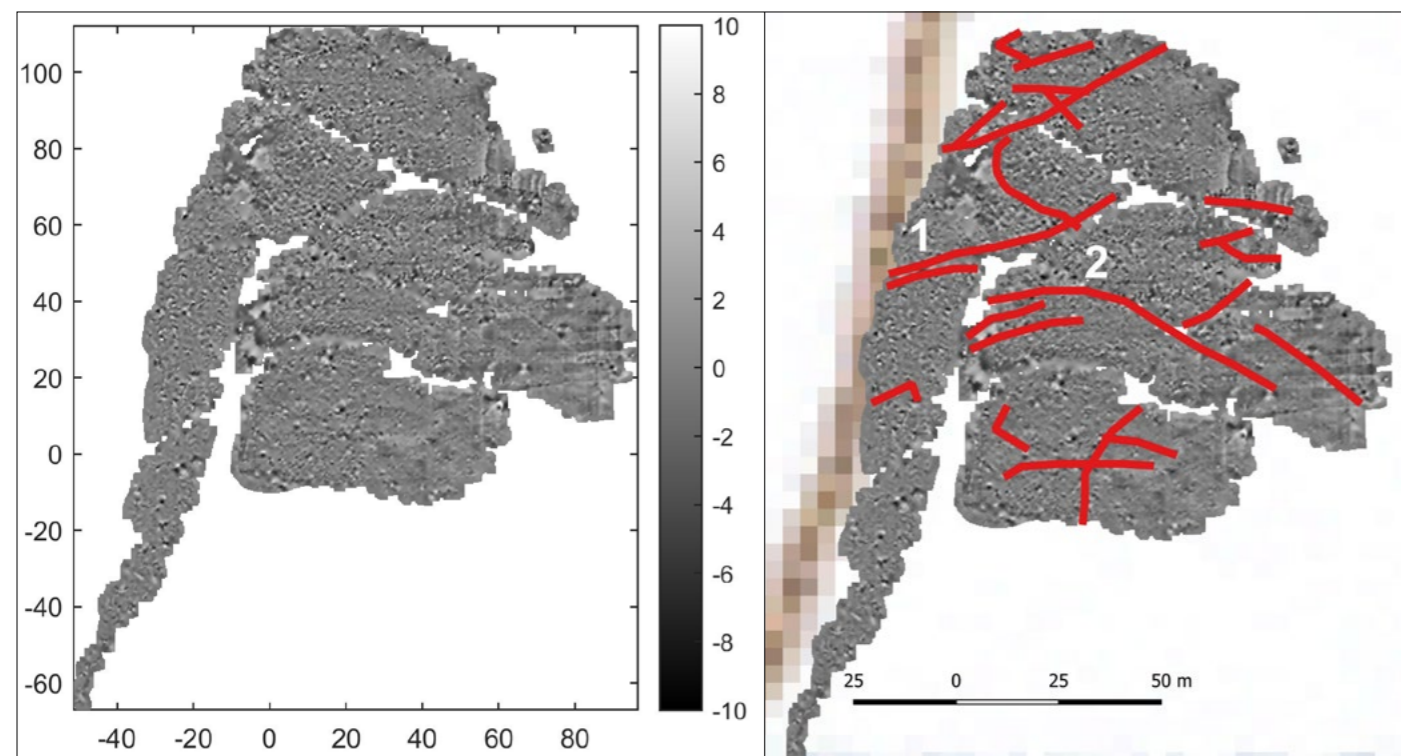

Figure 28: Map of the vertical derivative of the intensity anomaly of the total magnetic field of terraces 13, 14, and 15 at the order 1 (left) with the interpretation (red lineation) on a QGIS background (right) (R. Al Khatib Alkontar, H. Reiller – MAFTOr/IPGS-EOST).

Comparison between magnetic data and archaeological excavations

Terrace 2 - Archaeological sounding 3

This excavation has been made on 10 March to check if the lineation highlighted on **fig. 10** was due to archaeological remains. The sounding was only filled with a 30 to 80-cm-deep homogeneous layer of sediments and rocks over the bedrock (**fig. 29**). The lineation highlighted is not due to archaeological remains. The origin of this anomaly remains unknown.



Figure 29: Archaeological sounding 3 on terrace 2. It yielded no anthropic occupation (R. Al Khatib Alkontar, H. Reiller – MAFTOr/IPGS-EOST).

Terrace 5 - Archaeological sounding 5

The discovery of the remains of walls and foundations on a natural section of an agricultural terrace led to the opening of an archaeological sounding (Sounding 5) on terrace 5. It yielded the remains of a stone building (**fig. 30**).

Two geophysical surveys have been conducted on this spot (**fig. 32**) previously to the beginning of the excavation (9 March), and on 13 March after the excavation.

There is an apparent 3-metres difference in the coordinate system of the geomagnetic map of 9 March, and that of the archaeologists in which orthophotographs of the soundings are displayed. Indeed, there are no magnetic data at the north of the excavation, whereas the area was surveyed on the field. For the next analyse (**fig. 31**), a 3-metres shift toward the south is applied to the magnetic map of 9 March. This problem occurred probably because of a gap in the coordinate system ascribed to the base antenna of our GNSS and the one used by archaeologists for RTK measurements.

On the map of 9 March, an anomaly is identified at the level of wall 249047 (black circle). This anomaly is still identified on the map of 13 March, but with a lower amplitude, which means that this anomaly is probably not due to wall 249047. On the other parts of the two maps, anomalies do not fit with structures found in the excavation.

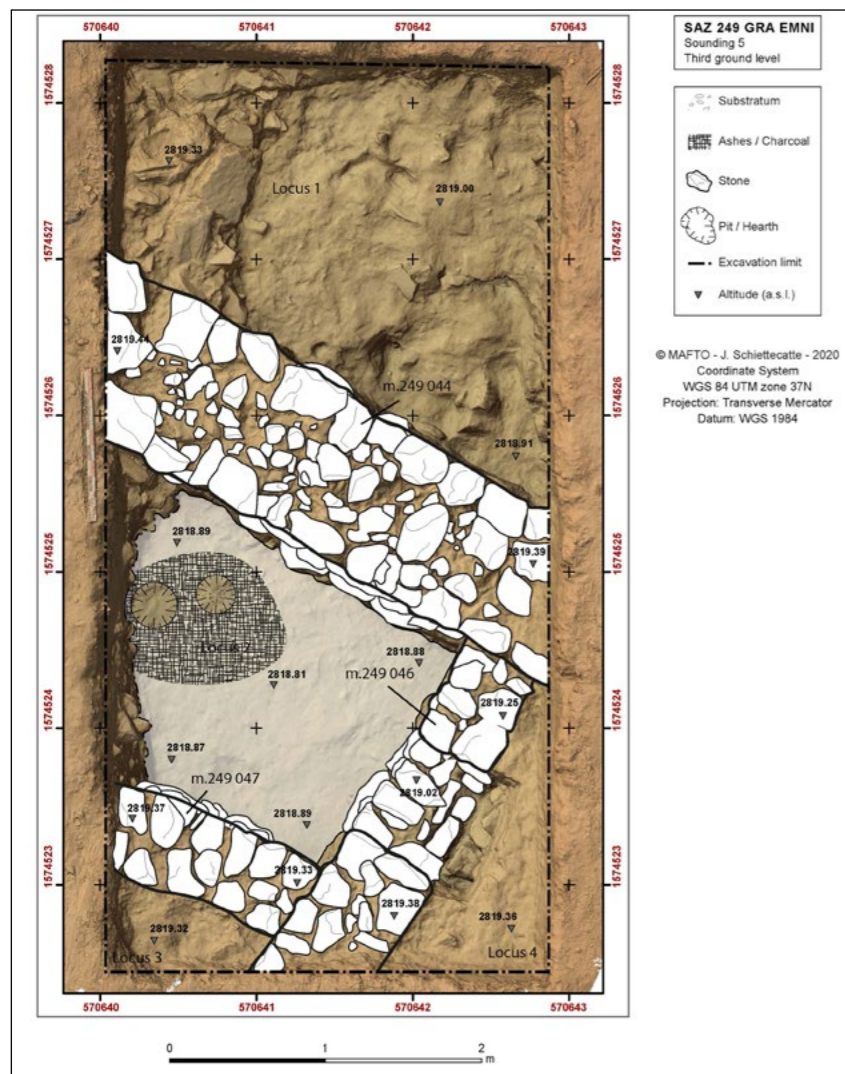

Figure 30: Gra Emni (SAZ 249) - Sounding 5, plan (J. Schiettecatte - MAFTOr)

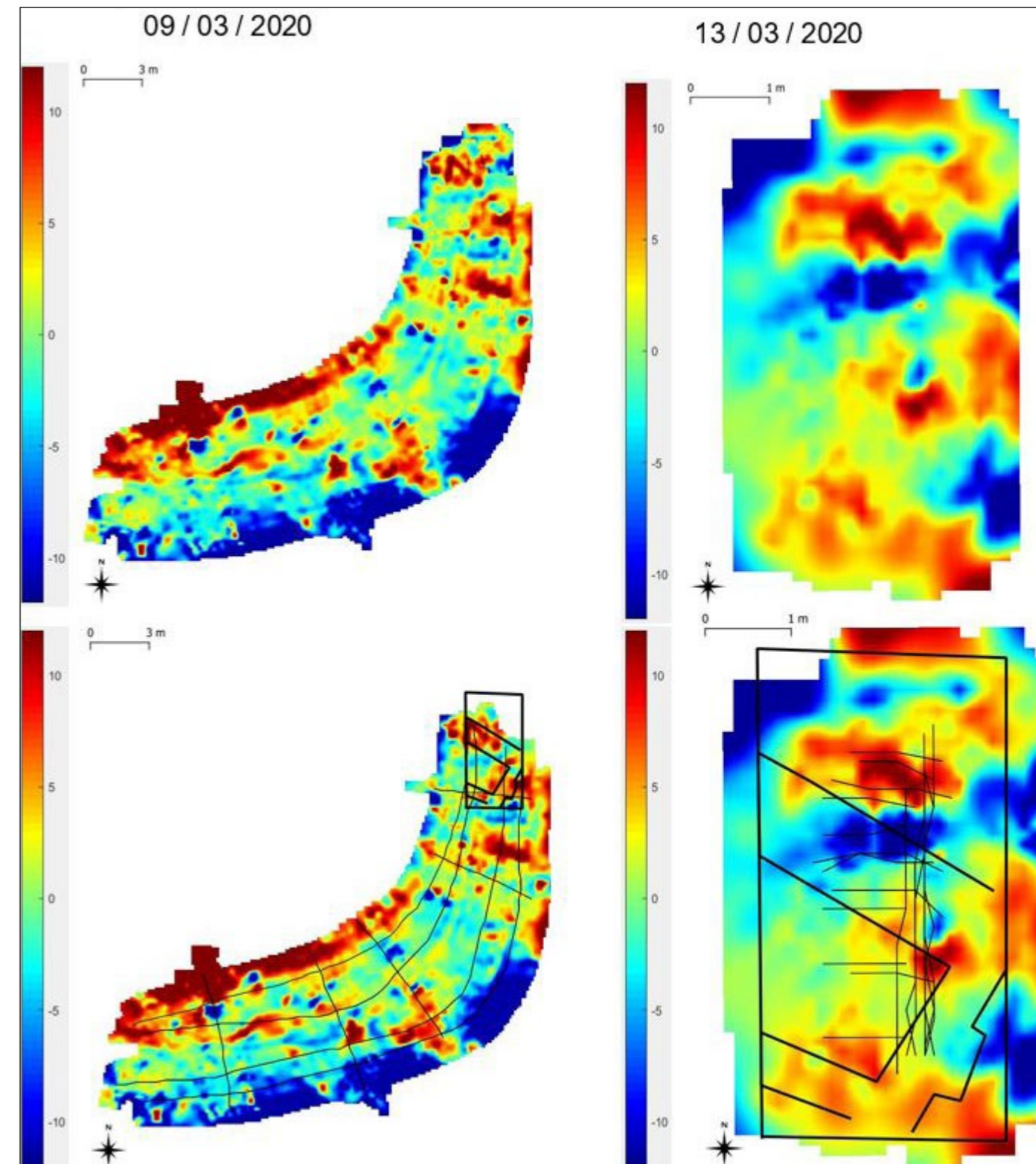

Figure 32: Terrace 5 - Map of the intensity anomaly of the magnetic field of 9 March (left), and 13 March (right), with the location of the magnetic profiles (thin black lines) and of the archaeological structures (thick black lines) (R. Al Khatib Alkontar, H. Reiller - MAFTOr/IPGS-EOST).

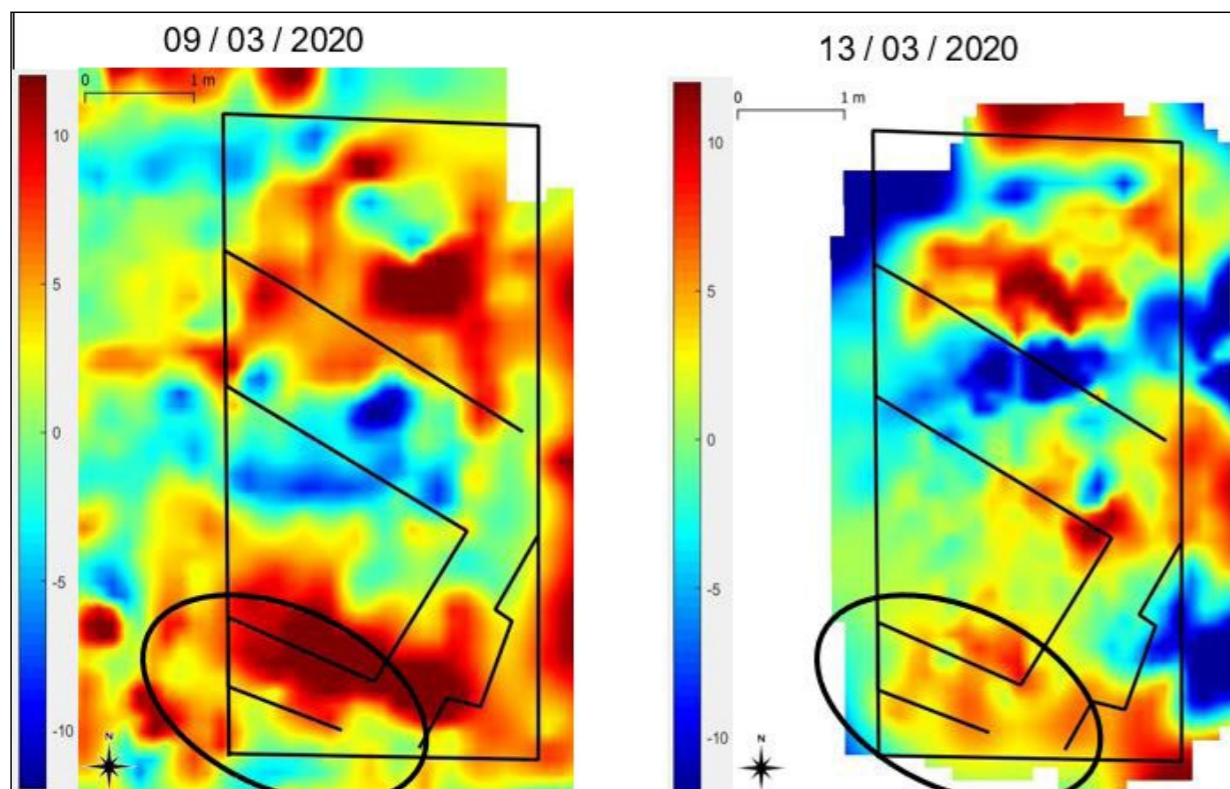

Figure 31: Terrace 5 - Map of the intensity anomaly of the magnetic field of 9 March (left), and 13 March (right) (R. Al Khatib Alkontar, H. Reiller - MAFTOr/IPGS-EOST).

Terrace 6 - Archaeological sounding 4

Thanks to information coming from a local farmer, archaeologists suspected the presence of walls or foundations on terrace 6. Sounding 4 proved it to be right (fig. 33).

Two surveys were conducted on this site (fig. 34): previously to the excavation on 10 March, and on 12 March after the excavation.

It seems that there is a gap between the location of the excavation and our map of 12 March. We see it because north-south profiles are not in the middle of the excavation, as we did on the field. For the next analyse (fig. 35), a 1.5-metre shift toward the west is applied to the magnetic map of 12 March.

As already mentioned, this problem occurred probably because of a gap in the coordinate system ascribed to the base antenna of our GNSS and the one used by archaeologists for RTK measurements.

On the magnetic map of 10 March, six anomalies are pointed out because their form suggests an anthropogenic origin. The two at the north in the excavation are not identifiable on the map of 12 March, and they do not fit with archaeological remains found in excavations. The one at the south of the excavation is still identifiable on the map of 12 March (black circle). Its shape is not the same and no longer suggests an anthropic origin on the map of 12 March: no right angle is identified.

The one at the south of the two maps is not included within the excavated area: it is normal to identify it in the same way on the two maps. The shape in right angle of this anomaly suggests an anthropic origin.

On the map of 12 March, an anomaly with a shape of right angle is identified at the southeast corner of the excavation. No anomaly is pointed out on the map of 10 March at this location.

Generally, interpretations of magnetic maps do not fit with excavated structures.

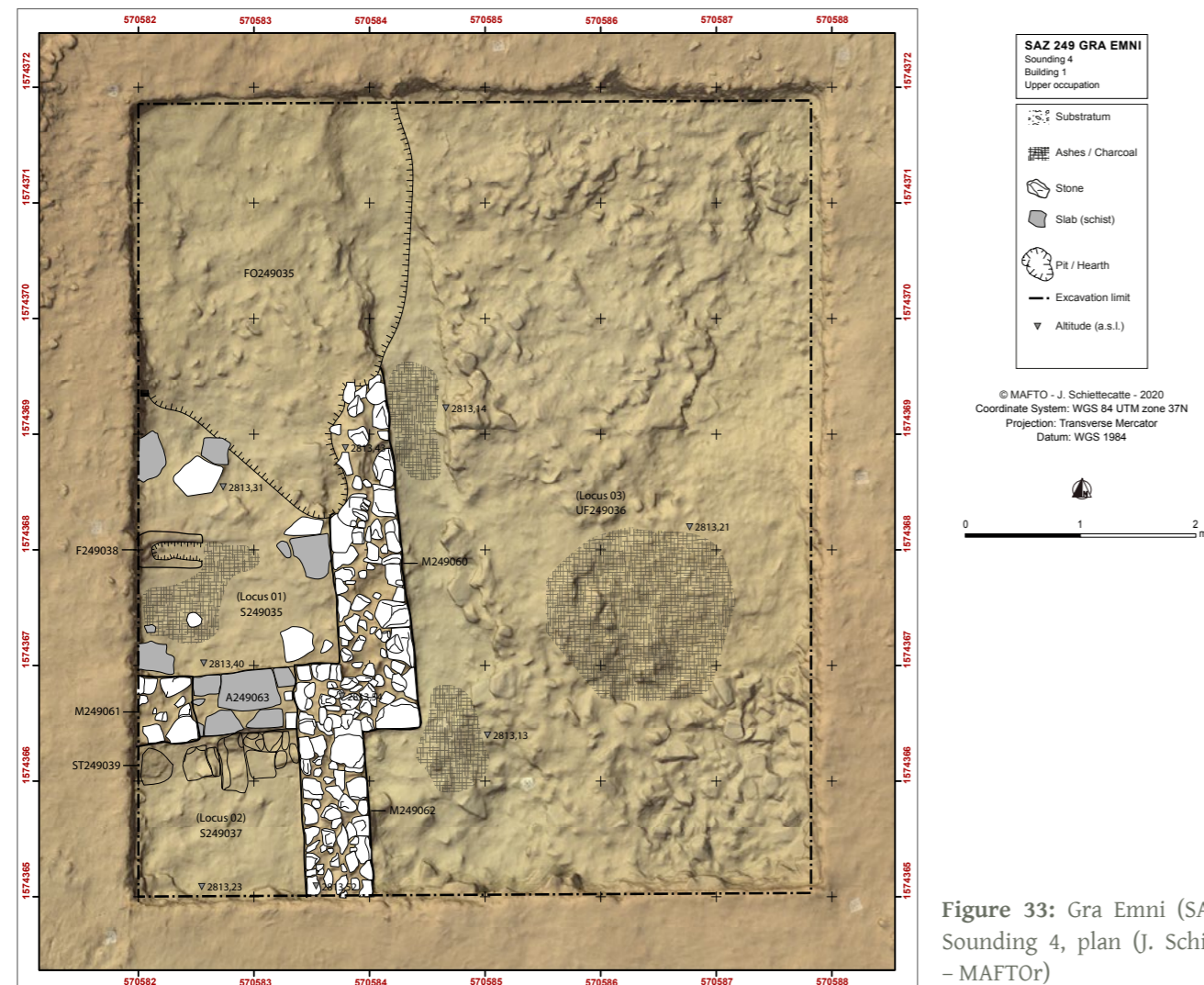

Figure 33: Gra Emni (SAZ 249) - Sounding 4, plan (J. Schiettecatte - MAFTOr)

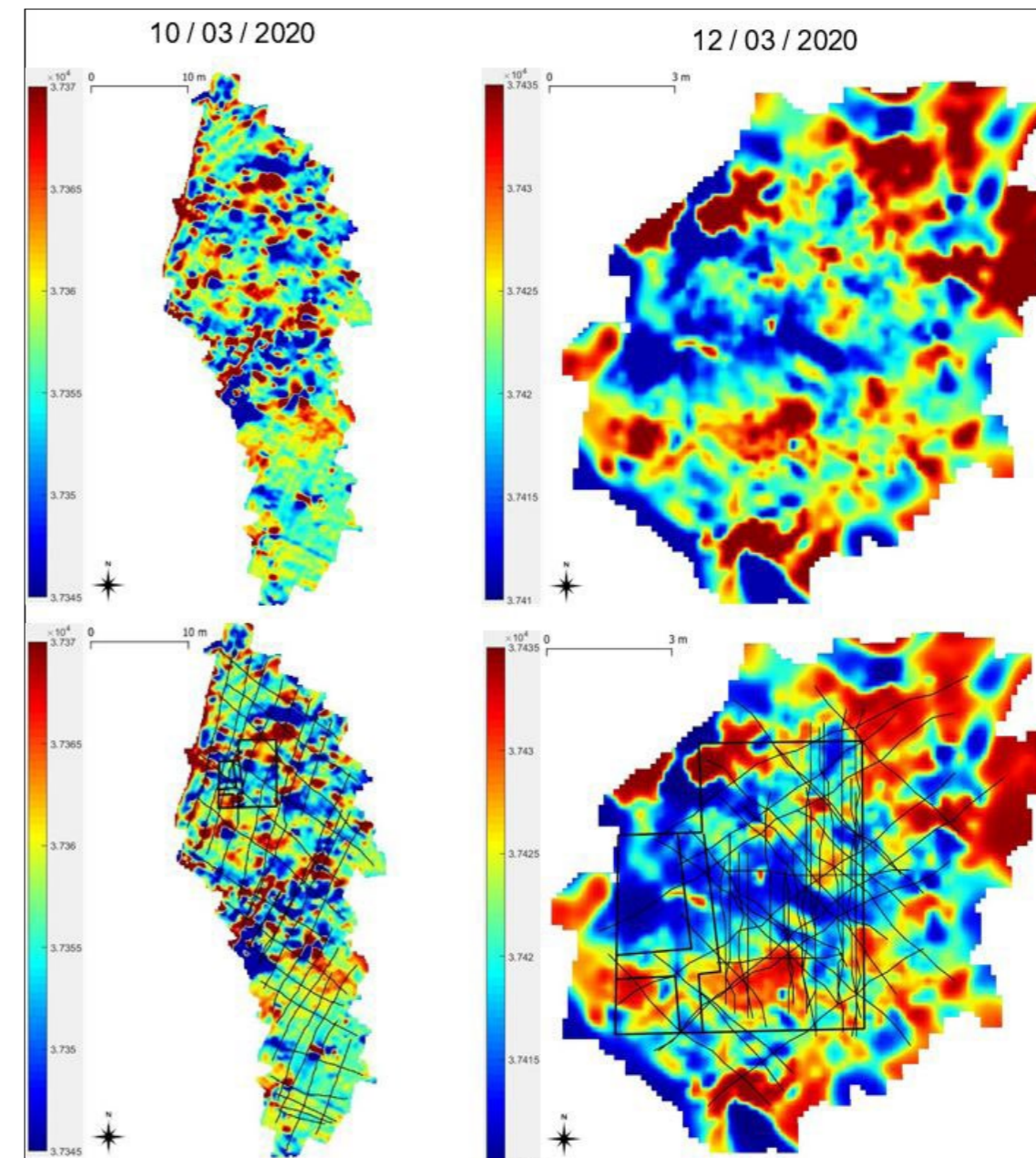

Figure 34: Terrace 6 - Map of the intensity anomaly of the magnetic field of 10 March (left), and 12 March (right), with the location of the magnetic profiles (thin black lines) and of the archaeological structures (thick black lines) (R. Al Khatib Alkontar, H. Reiller - MAFTOr/IPGS-EOST).

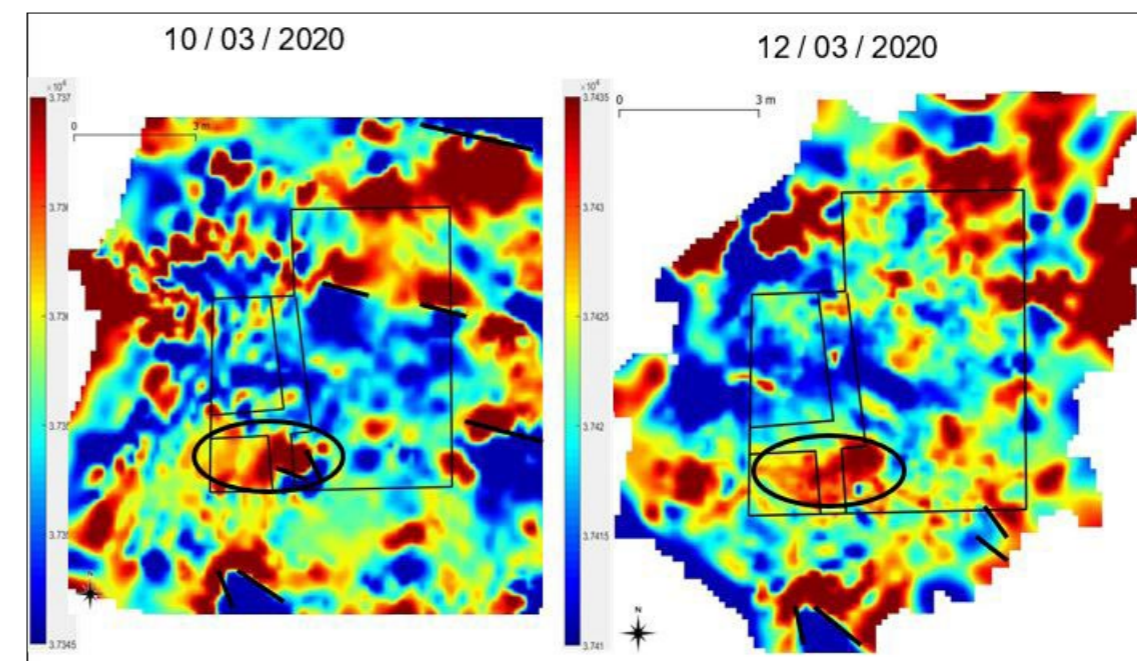

Figure 35: Terrace 6 - Map of the intensity anomaly of the magnetic field of 10 March (left), and 12 March (right) (R. Al Khatib Alkontar, H. Reiller - MAFTOr/IPGS-EOST).

Terrace 10 - Archaeological sounding 2

On terrace 10, an excavation (fig. 36 A, F) has been conducted. A first magnetic survey was conducted after the completion of the excavation and before filling up (fig. 36 B). Several structures were identified: a furnace (1), a north-south wall (2), an east-west wall (3) and a north-west – south-east wall (4) (fig. 36 A, F). On the map (fig. 36 B), it is possible to identify the anomalies due to the furnace and the walls (2) and (3), while no anomaly linked to wall (4) seems to appear.

On the map of the vertical derivative (fig. 36 C), limits of the walls (2) and (3) are outlined better than on the map of the anomaly intensity. In addition, the vertical derivative reveals an anomaly linked to wall (4), even if both anomalies of furnace (1) and wall (4) seems to be partly overlapping.

Another magnetic survey was conducted after the completion and filling up of the excavation (fig. 36 D), in order to compare the magnetic measurements before and after excavation. On the map of the anomaly intensity (fig. 36 D1) and the map of the vertical derivative (fig. 36 D2), it is possible to identify an anomaly due to furnace (1) while no lineations are linked to walls (2), (3) and (4).

The difference of interpretation between the two surveys could be explained by the difference of height of the sensors relative to the structure: around 0.3 m for the survey before the filling up and 0.6 m for the survey after the filling up. The furnace causes an anomaly characterised by an amplitude big enough to be identified even if the measurements are done 0.6 m above. It is not the case for the anomaly due to the walls and it might be explained by the magnetization contrast with the surrounding, a few orders of magnitude lower compared to the furnace.

Conclusions

The magnetic method used on the field was not successful to identify archaeological remains. The excavation on terrace 2 demonstrates that lineations pointed out with magnetic maps do not necessarily indicate the presence of archaeological remains like walls or foundations. In general, the comparison of magnetic surveys conducted before excavations and after the completion of the excavation (before filling up) does not allow to point out anomalies that fit with the discovered archaeological remains.

The difficulty was increased by the gap between the geolocation of the magnetic maps and that of orthophotographs. It makes the comparison between the two types of information (magnetic and archaeological) very sensitive and can partly explain why archaeological and magnetic results do not fit.

Modelling

On the site of Gra Emni, several excavations allowed to discover different types of archaeological remains especially walls and foundations. The aim of the modelling part is to understand why the magnetic surveys on these areas do not show clear anomalies linked to these structures, a priori characterised by a mostly induced magnetization. To do that, it is important to have an idea of the magnetization contrast between archaeological structures and their surroundings. The magnetic susceptibility is measured on several archaeological structures and their surroundings. Contrast of this parameter can be directly used to make model. Magnetic susceptibilities have been measured with the SM20 GF Instrument device on several rock (on walls/foundations and on demolition rubble) and on the surrounding of Soundings 4 and 5.

Modelling parameters:

- Inclination of magnetic fields: 15.1511° (based on IGRF20)
- Declination of magnetic fields: 2.61507° (based on IGRF20)
- Intensity of the magnetic field: 37 478 nT

Susceptibility data

All the data are 10³ SI.

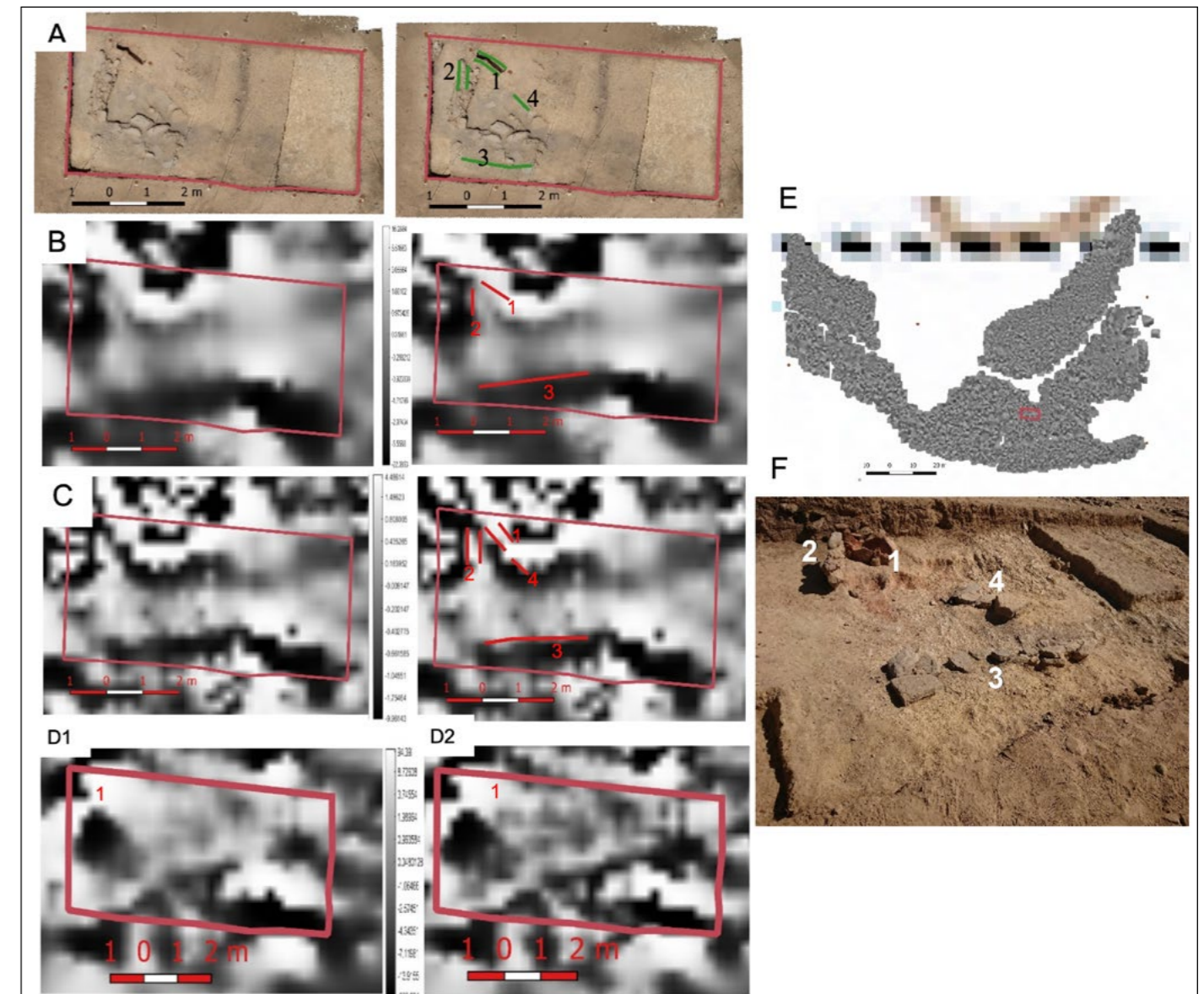

Figure 36: Terrace 10 - A) orthophoto and the interpretations of archaeologists (green lines), B) map of the intensity anomaly before the filling up, C) Map of the vertical derivative at the order 1 before the filling up, D1) map of the intensity anomaly after the filling up, D2) map of the vertical derivative after the filling up, E) position of the excavation on terrace 10 (red square), F) photo of the excavation (R. Al Khatib Alkontar, H. Reiller – MAFTOr/IPGS-EOST).

Wall 249060	Wall 249061	Wall 249062	Locus 02	Locus 01		Locus 03	
				Demolition Blocks	Sediment	Demolition Blocks	Sediment
0.115	0.233	0.057	0.493	0.023	0.746	0.091	0.845
0.175	0.246	0.037	0.645	0.215	1.06	0.045	0.502
0.107	0.062	0.045	0.594	0.042	0.699	0.062	0.7
0.149	0.122	0.085	0.446	0.077	1.14	0.085	0.729
0.115	0.125	0.074	0.915	0.118	0.491	0.082	1.17
0.11	0.096	0.112	0.593	0.275	1.03	0.115	1
0.077	0.147	0.036	0.695	0.083	0.929	0.119	1.07
0.255	0.15	0.065	0.635	0.108	0.527	0.155	0.651
0.172	0.123	0.086	0.707	0.224	1.35	0.06	0.618
0.217	0.197	0.066	0.526		0.645	0.257	1.17
0.274	0.233	0.091	0.612		0.868	0.041	0.779
0.306	0.217	0.076	1.06		1.03	0.036	0.821
0.162	0.216	0.093	1.67		1.12	0.087	0.622
0.172		0.07	0.547		0.704	0.094	0.589
		0.086	0.584		1.32		0.645
			0.529		0.748		0.886
			0.586		1.34		
			0.716				
			0.811				
0.171857	0.166692	0.071933	0.703368421	0.12944	0.92629	0.0885	0.79981
0.068783	0.0600228	0.0216249	0.277246623	0.087979	0.276709	0.067305	0.209189

Table 1: Susceptibility data of Sounding 4. The bold values down the table represent the average (first line) and the standard deviation (second line) (R. Al Khatib Alkontar, H. Reiller – MAFTOr/IPGS-EOST).

Wall 249044	Wall 249046	Wall 249047	Locus 02		Locus 01	
			Demolition Blocks	Sediments	Demolition Blocks	Sediments
0.045	0.072	0.115	0.084	0.588	0.081	0.901
0.043	0.101	0.224	0.189	0.506	0.123	0.878
0.036	0.064	0.03	0.158	0.483	0.088	0.682
0.03	0.291	0.045	0.098	2.44	0.087	0.855
0.027	0.078	0.034	0.053	0.833	0.118	0.688
0.031	0.07	0.038	0.082	0.88	0.061	0.864
0.029	0.062	0.079	0.049	0.77	0.044	1.12
0.038	0.08	0.056	0.041	0.975	0.054	0.958
0.031	0.079	0.016	0.085	0.921	0.102	0.98
0.033	0.066	0.017	0.224	0.981	0.086	0.806
0.056	0.044	0.042	0.039	0.933	0.124	0.765
0.038	0.069	0.052	0.177		0.517	
0.041	0.092	0.05	0.123		0.134	
0.06	0.088	0.145			0.538	
0.021	0.112	0.237				
0.065	0.103	0.078				
0.039	0.091938	0.078625	0.107846154	0.9372727	0.154071429	0.863363636
0.012345	0.05586	0.0684026	0.061332218	0.5308759	0.160535864	0.129125732

Table 2: Susceptibility data of Sounding 5. The bold values down the table represent the average (first line) and the standard deviation (second line) (R. Al Khatib Alkontar, H. Reiller – MAFTOr/IPGS-EOST).

East-west wall models (Sounding 4, Wall 249061)

Modelling parameters

- Magnetic susceptibility of the sand surrounding = 0.863×10^{-3}
- Height of measure in comparison to the surface: 0.3 m
- Thickness of the wall: 0.5 m
- Depth of the wall: 0.25 m
- Magnetic susceptibility of walls/foundations and demolition rubble = 0.167×10^{-3}
- Contrast of susceptibility between walls/foundations/demolition rubble and the surrounding (i.e. value put in models) = 0.696×10^{-3}

On all the figures that show profiles, the north is on the right and the south is on left.

2D modelling

The software used to calculate the magnetic signal of the models is based on the Talwani method. In the model of fig. 37, the “full” wall means that there is no sand filling between rocks composing the wall. A more realistic model could be to introduce sand filling between rocks composing the wall (fig. 38). There is a difference of amplitude of the intensity of the magnetic anomaly of around 15 nT between the two models (fig. 39) what is not negligible considering that the anomaly caused by the “full” wall is c. 60 nT. So, the state of conservation of the wall/foundation influences significantly the amplitude of the anomaly. In the two models, the amplitude of the anomaly is big enough to identify the archaeological structure with the magnetic method (fig. 39). Considering these models, the contrast of susceptibility between walls/foundations and the surrounding (0.696×10^{-3}) cannot explain why magnetic maps do not show clear east-west lineations due to walls or foundations.

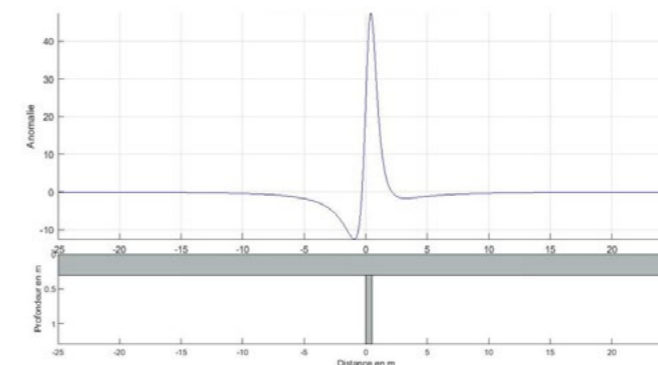

Figure 37: Magnetic anomaly caused by a “full” wall of 0.5×1 m at 0.3 m of depth (R. Al Khatib Alkontar, H. Reiller – MAFTOr/IPGS-EOST).

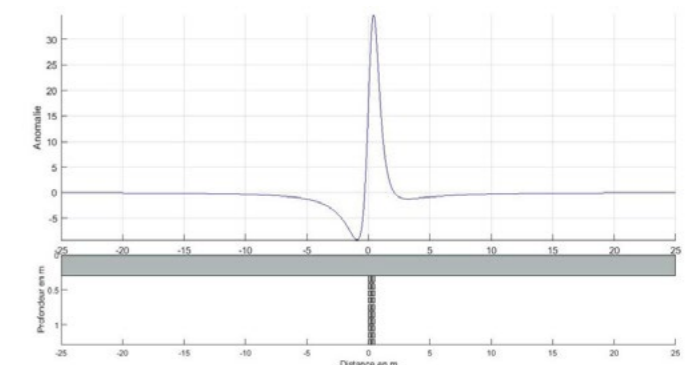

Figure 38: Magnetic anomaly caused by a “remain” of wall of 0.5×1 m at 0.3 m of depth (R. Al Khatib Alkontar, H. Reiller – MAFTOr/IPGS-EOST).

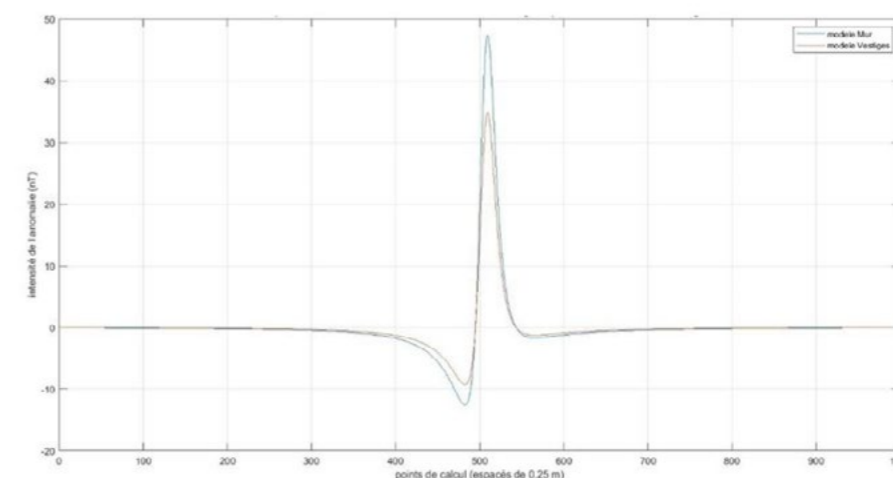

Figure 39: Comparison between magnetic anomalies caused by a “vestige” of wall (orange curve) and by a “full” wall (blue curve) (R. Al Khatib Alkontar, H. Reiller – MAFTOr/IPGS-EOST).

3D modelling

The software used to calculate the magnetic signal of the models considers that the space is full of dipoles whose volume depend on the step of the grid (here 0.25m in the three directions of the space). On figures modelling 3D anomalies, the model is presented on the left (red points correspond to dipoles) at a depth of 0.75 m.

Firstly, note that there is a difference of the anomaly amplitude of c. 10 nT between the 2D model and the 3D model if we consider just a wall and a homogenous surrounding (fig. 40). It can be explained by the difference in the way the anomaly is calculated (Talwani/dipole).

Now that we consider a 3D space, it is possible to add punctual objects to the model like demolition rubble. Different quantities of demolition rubble are considered in the surrounding: 25 % (fig. 41), 50 % (fig. 42) and 75 % (fig. 43).

Even if it is possible to identify an anomaly corresponding to the wall with the highest rate of block of demolition (75 % of the surrounding), we see that its signal is hidden by anomalies caused by demolition rubble. In the model with a rate of demolition rubble of 50 % and 75 %, it is difficult to locate precisely the wall in the east-west direction. In the model with a rate of demolition rubble of 25 %, it is possible to identify a lineation that locate precisely the wall.

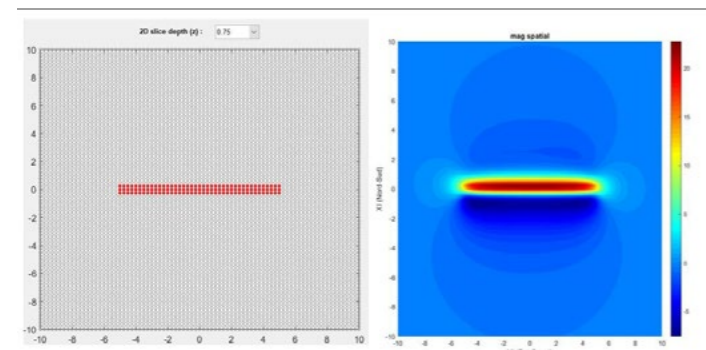

Figure 40: Magnetic anomaly caused by a wall of 0.5 × 1 m at 0.25 m of depth (R. Al Khatib Alkontar, H. Reiller – MAFTOr/IPGS-EOST).

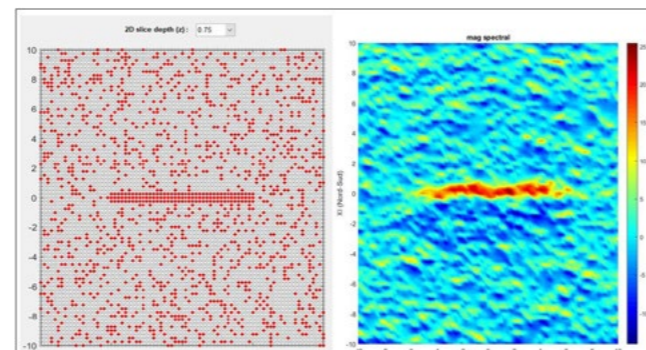

Figure 41: Magnetic anomaly caused by a wall of 0.5 × 1 m at 0.25 m of depth, surrounded by demolition rubble [25 %] (R. Al Khatib Alkontar, H. Reiller – MAFTOr/IPGS-EOST).

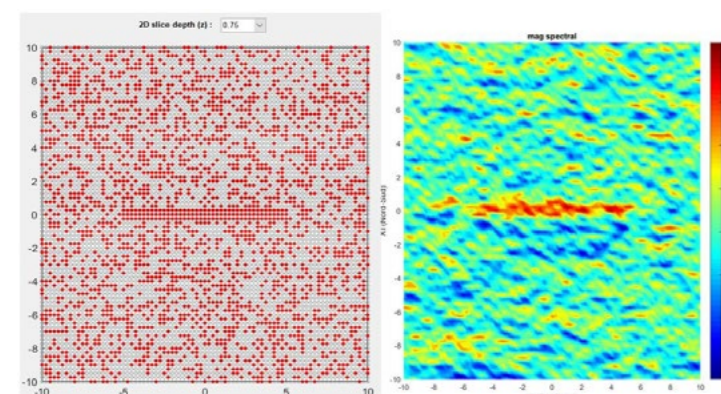

Figure 42: Magnetic anomaly caused by a wall of 0.5 × 1 m at 0.25 m of depth, surrounded by demolition rubble [50 %] (R. Al Khatib Alkontar, H. Reiller – MAFTOr/IPGS-EOST).

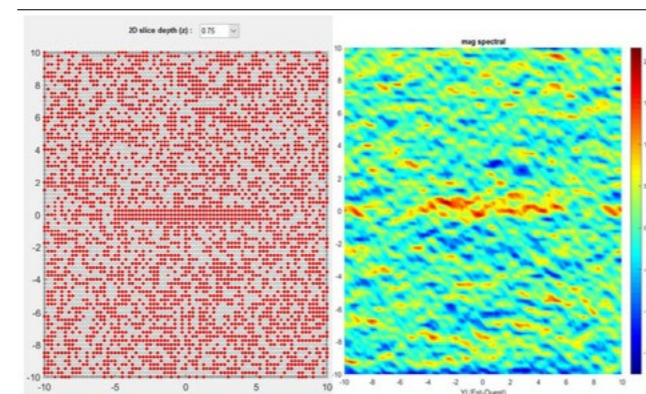

Figure 43: Magnetic anomaly caused by a wall of 0.5 × 1 m at 0.25 m of depth, surrounded by demolition rubble [75 %] (R. Al Khatib Alkontar, H. Reiller – MAFTOr/IPGS-EOST).

North-south wall model (Sounding 4, Wall 249060)

Modelling parameters

- Magnetic susceptibility of the sand surrounding = 0.863×10^{-3}
- Height of measure in comparison to the surface: 0.3 m
- Thickness of the wall: 0.5 m
- Depth of the wall: 0.25 m
- Magnetic susceptibility of walls/foundation and demolition rubble: $= 0.172 \times 10^{-3}$
- Contrast of susceptibility between walls/foundations/demolition rubble and the surrounding (i.e. value put in models) = 0.691×10^{-3}

On all the figures that show profiles, the west is on the left and the east is on the right.

2D modelling

The same two models are used: “full” wall and “remain” wall (fig. 44). In this model, the amplitude of the anomaly cause by the wall is under 5 nT. We are close to the limit of detection.

3D modelling

The extremities of the wall could be identified: amplitudes of the anomalies are more than 5 nT. No lineation can be identified all along the wall (fig. 45). Different quantities of demolition rubble are considered in the surrounding: 25 % (fig. 46) and 50 % (fig. 47). If we consider the demolition rubble, it becomes impossible to identify the extremities of the wall.

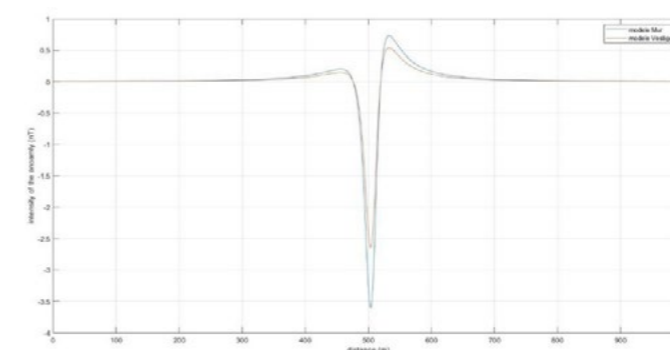

Figure 44: Comparison between magnetic anomalies caused by a “vestige” of wall (orange curve) and by a “full” wall (blue curve) (R. Al Khatib Alkontar, H. Reiller – MAFTOr/IPGS-EOST).

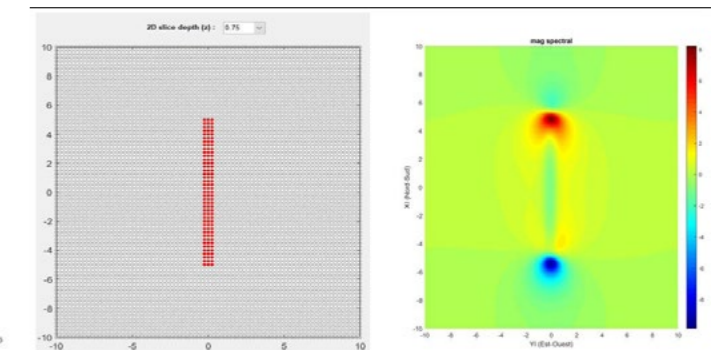

Figure 45: Magnetic anomaly caused by a wall of 0.5 × 1 m at 0.25 m of depth (R. Al Khatib Alkontar, H. Reiller – MAFTOr/IPGS-EOST).

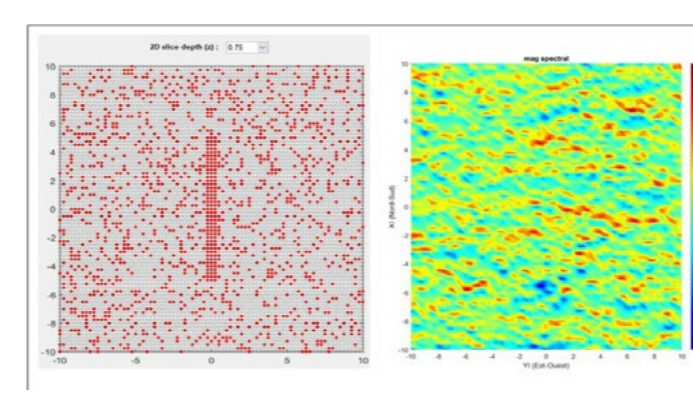

Figure 46: Magnetic anomaly caused by a wall of 0.5 × 1 m at 0.25 m of depth, surrounded by demolition rubble [25 %] (R. Al Khatib Alkontar, H. Reiller – MAFTOr/IPGS-EOST).

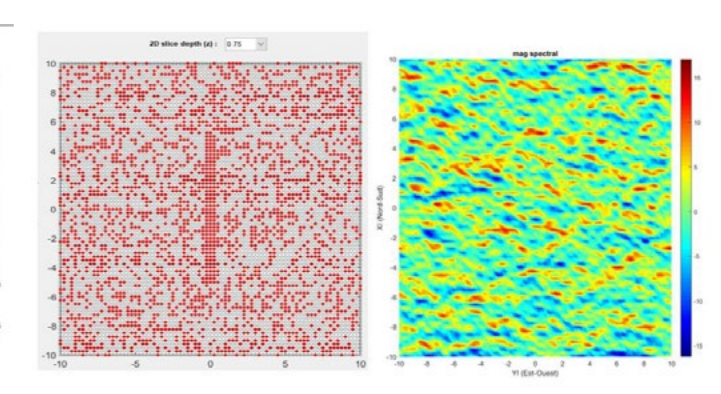

Figure 47: Magnetic anomaly caused by a wall of 0.5 × 1 m at 0.25 m of depth, surrounded by demolition rubble [50 %] (R. Al Khatib Alkontar, H. Reiller – MAFTOr/IPGS-EOST).

North-west – south-east wall model (Sounding 5, Wall 249044)

Modelling parameters

- Thickness of the wall: 1 m
- Depth of the wall: 0.5 m
- Orientation of the wall: 60° N
- Magnetic susceptibility of walls/foundation and demolition rubble: = 0.039×10^3
- Contrast of susceptibility between walls/foundations/demolition rubble and the surrounding (i.e. value put in models) = 0.861×10^3

3D modelling

The amplitude of the anomaly caused by the wall is more than 25 nT (fig. 48), which is enough to identify a lineation linked to the wall on a magnetic map.

Different quantity of demolition rubble are considered in the surrounding: 25 % (fig. 49), 50 % (fig. 50) and 75 % (fig. 51). With a rate of demolition rubble of 25 %, the limits of the wall are identifiable. On the other hand, even if it is possible to suspect the presence of the wall with rates of demolition rubbles of 50 % and 75 %, its extremities are not identifiable.

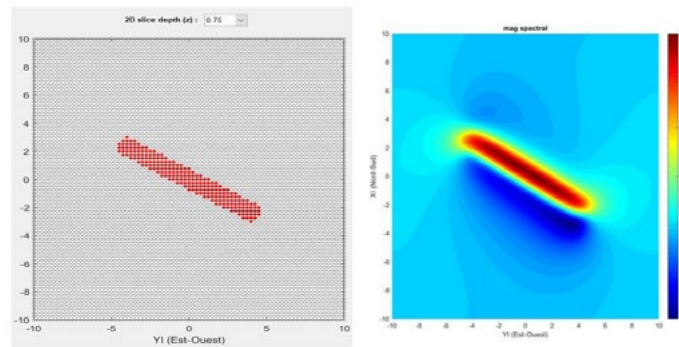

Figure 48: Magnetic anomaly caused by a wall of 1 × 1 m at 0.5 m of depth (R. Al Khatib Alkontar, H. Reiller – MAFTOr/IPGS-EOST).

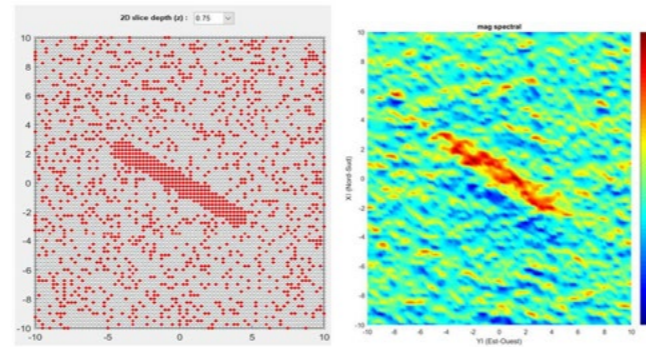

Figure 49: Magnetic anomaly caused by a wall of 1 × 1 m at 0.5 m of depth, surrounded by demolition rubble [25 %] (R. Al Khatib Alkontar, H. Reiller – MAFTOr/IPGS-EOST).

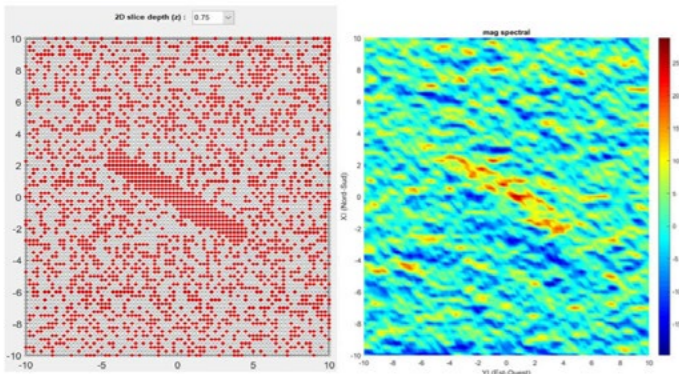

Figure 50: Magnetic anomaly caused by a wall of 1 × 1 m at 0.5 m of depth, surrounded by demolition rubble [50 %] (R. Al Khatib Alkontar, H. Reiller – MAFTOr/IPGS-EOST).

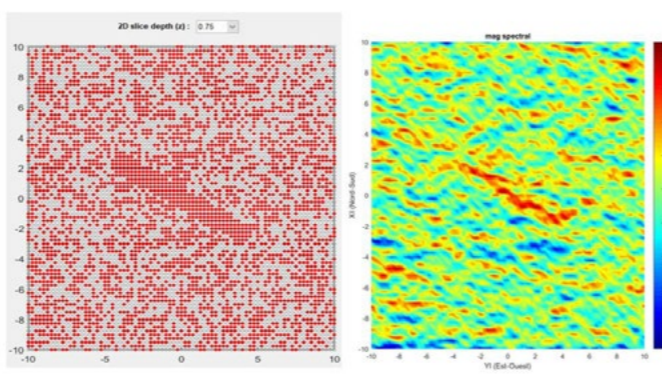

Figure 51: Magnetic anomaly caused by a wall of 1 × 1 m at 0.5 m of depth, surrounded by demolition rubble [75 %] (R. Al Khatib Alkontar, H. Reiller – MAFTOr/IPGS-EOST).

Conclusions

It is important to consider the extended direction of a wall to appreciate which kind of anomaly it generates. In the case of a wall with a north-south direction, it does not create a clear lineation in the north-south direction and only its extremities are identifiable. It is a very specific case in the surveyed area: the direction of the wall is almost parallel to the direction of the vector of the regional magnetic field. So, considering a pure induced magnetization of remains, it can be difficult to identify this type of structure considering the shape of the anomaly it creates. Moreover, the amplitude of the anomaly at the extremities of the wall is near to the limit of detection.

Walls in other directions seem to be identifiable: they create anomalies with a shape of a lineation and with an amplitude big enough to be detected. Therefore, we wonder why we were not able to identify this type of structure on the map of the anomaly intensity of the magnetic field.

A first reason could be the state of conservation of the wall. The 2D modelling allows to appreciate the effect of the state of conservation on the amplitude of the anomaly linked to a wall. Note that 3D models do not take this aspect into account.

A second reason could be the high rate of demolition rubble on the surface and around remains in the surrounding. 3D models allow to quantify this effect and show that a high rate of demolition rubble could be linked to many dipole anomalies that “hide” the magnetic signal of the wall. It could be possible to consider a more realistic distribution of the demolition rubble with the highest rate next to the wall and a lowest rate far from the wall; the rate of demolition rubble would be decreasing as one moves away from the wall.

A third reason is the presence of high magnetization elements on the field (ceramics or high magnetization rocks). They can create anomalies with an amplitude higher than the amplitude of the anomaly linked to the wall. Susceptibility measurements have been conducted on this type of objects (Tables 3 and 4). There are a priori characterised by a predominantly remnant magnetization. Therefore, susceptibility measurements are not appropriate to characterise the total magnetization vector of this object. Models with just this parameter can only give an idea of the amplitude of the anomaly it could provoke in comparison to the amplitude of the anomaly of the walls. More complex measurements could lead to more realistic models.

To finish, it is important to consider that models give a biased representation of the reality. They do not take into account constraints of the field and technical aspects we could face off during the survey. One aspect in particular seems to be important and could be improved on the device used: the location of data.

UF	UF	UF	UF	UF	UF	UF	UF	UF	UF	UF	UF	UF	UF	UF
249032	249034	24030	249033	249029	249033	249030	249034	249031	249033	249024	249030	249033	249036	249049
3.7	10.9	24.1	7.19	3.83	10.7	5.45	3.86	8.71	4.71	14.8	10.2	18.3	6.51	10.2
3.55	9.94	25	10.9	7.93	10.2	5.72	3.25	18.7	9.25	9.63	8.95	9.96	13.9	9.13
	5.06	24.1	5.37	5.33	9.15	5.82	5.19	0.206	5.92	9.54	6.42	11.4	3.9	12.1
	7.28	5.93	6.02	7.72	7.35	15.5	20.8	9.64	3.19	7.24	9.54	4.78	7.45	10.6
	4.33	6.15	5.73		13	13.9	5.38	79.7	11.8	2.07		10.6	4.79	12.3
	14.3	9.9	5.41		3.15	4.66	21.7	17.9	10.3	19.2		9.44	6.85	13.6
	12.1	10	7.09		5.47	15.3			12.1	9.59		9.55	7.89	7.97
	13.2	5.67			9.71				9.22				5.58	
	4.99	12.6			8.69				10				9.38	
	4.73	11.8												
		4.37												

Table 3: Susceptibility data of pottery from 15 stratigraphic units (UF = Unité de Fouille). All the data are 10^3 SI (R. Al Khatib Alkontar, H. Reiller – MAFTOr/IPGS-EOST).

Sample 1 UF 249005 E536	Sample 2 UF 249028 E605
535	0,97
527	1,2
357	0,332
365	1,04
393	1,55
370	

Table 4: Susceptibility data of rock samples, supposedly ferrous. All the data are 10^3 SI (R. Al Khatib Alkontar, H. Reiller – MAFTOr/IPGS-EOST).

Waragena (SAZ 256 and 266)

The survey was carried out on March 16, 2020. The site of Waragena is characterised by similar agricultural terraces as those at Gra Emni (fig. 52-53). 120 profiles were made (fig. 54).

Name of file: 15F8105_20200316050730.txt Beginning: 05:07:33 End: 06:09:43.

Name of file: 15F8105_20200316060946.txt Beginning: 06:09:48 End: 07:11:39.

To analyse the magnetic map, the site is divided between a northern part (SAZ 256 = terraces 1 and 2) and a southern part (SAZ 266 = terraces 3, 4 and 5).

In the northern part, the map of the anomaly intensity shows two anomalies with a big amplitude (fig. 55: black circles). The map of the vertical derivative (fig. 56) shows several lineations. In the southern part, the map of the anomaly intensity shows several anomalies (fig. 57):

- On terrace 3, an anomaly has a big amplitude (black circle); it could be provoked by a geological contrast.
- On terrace 4 and 5, the shape of the anomalies leads to suspect the presence of archaeological remains (black lines).



Figure 52: Waragena (SAZ 256), terraces 1 and 2 (R. Al Khatib Alkontar, H. Reiller – MAFTOr/IPGS-EOST).



Figure 53: Waragena (SAZ 266), terraces 3, 4 and 5 (R. Al Khatib Alkontar, H. Reiller – MAFTOr/IPGS-EOST).



Figure 54: Waragena (SAZ 256 and 266), Profiles and tie-lines (R. Al Khatib Alkontar, H. Reiller - MAFTOr/IPGS-EOST).

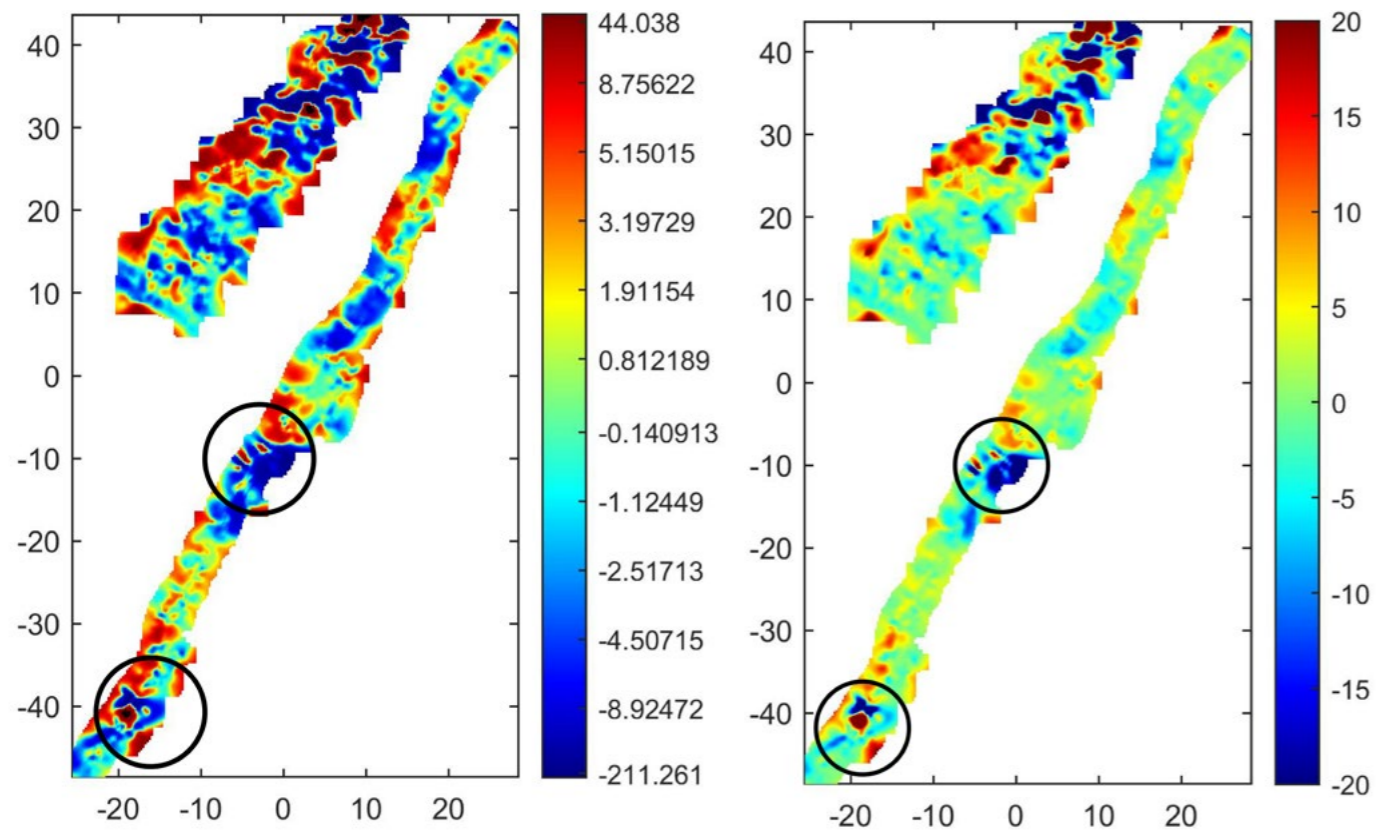

Figure 55: Waragena (SAZ 256). Map of the intensity anomaly of the total magnetic field of terraces 1 and 2 with the “linear” scale (right) and “equipopulation” scale (left) (R. Al Khatib Alkontar, H. Reiller - MAFTOr/IPGS-EOST).

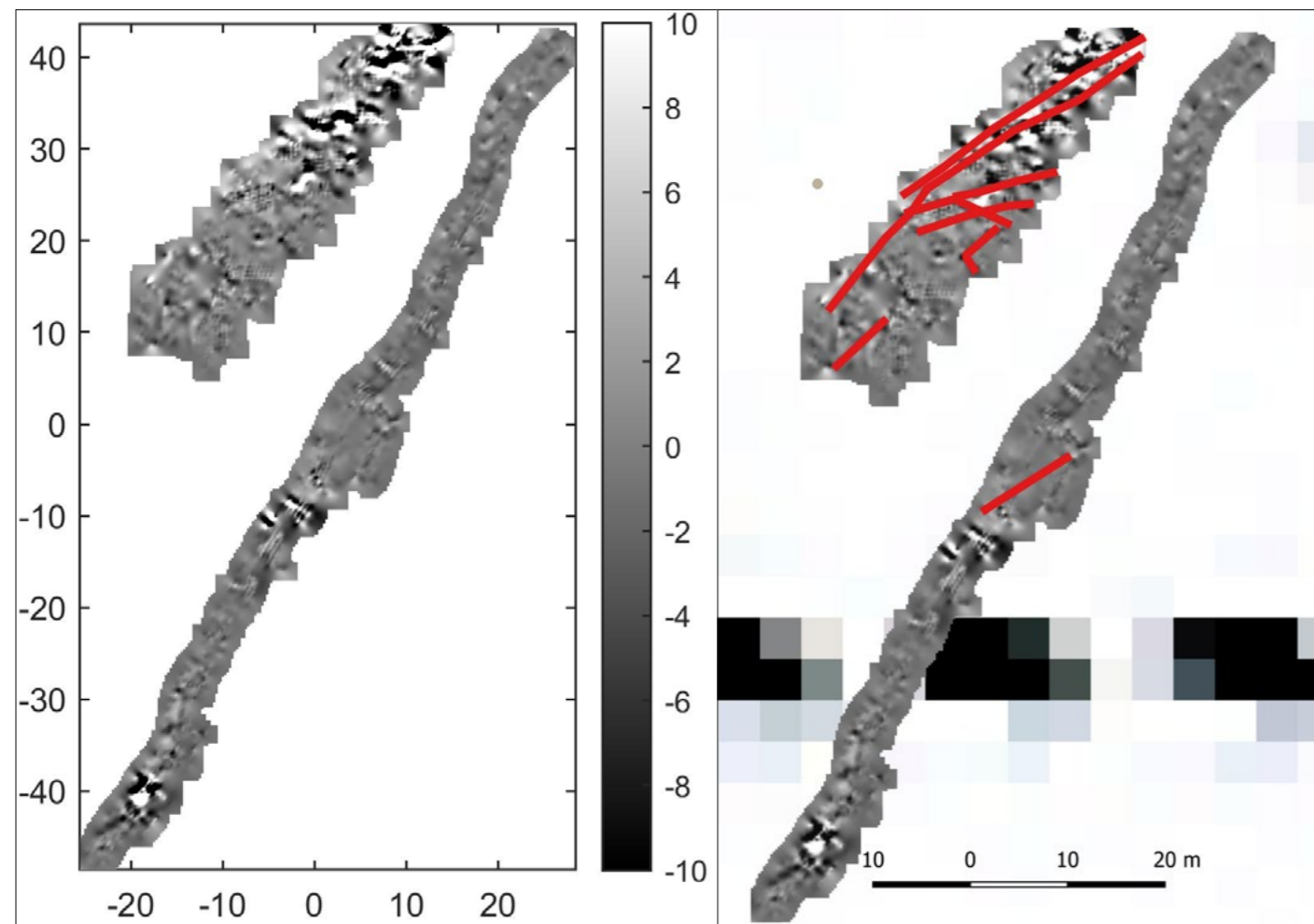

Figure 56: Waragena (SAZ 256). Map of the vertical derivative of terraces 1 and 2 at the order 1 interpreted (red lines) (R. Al Khatib Alkontar, H. Reiller - MAFTOr/IPGS-EOST).

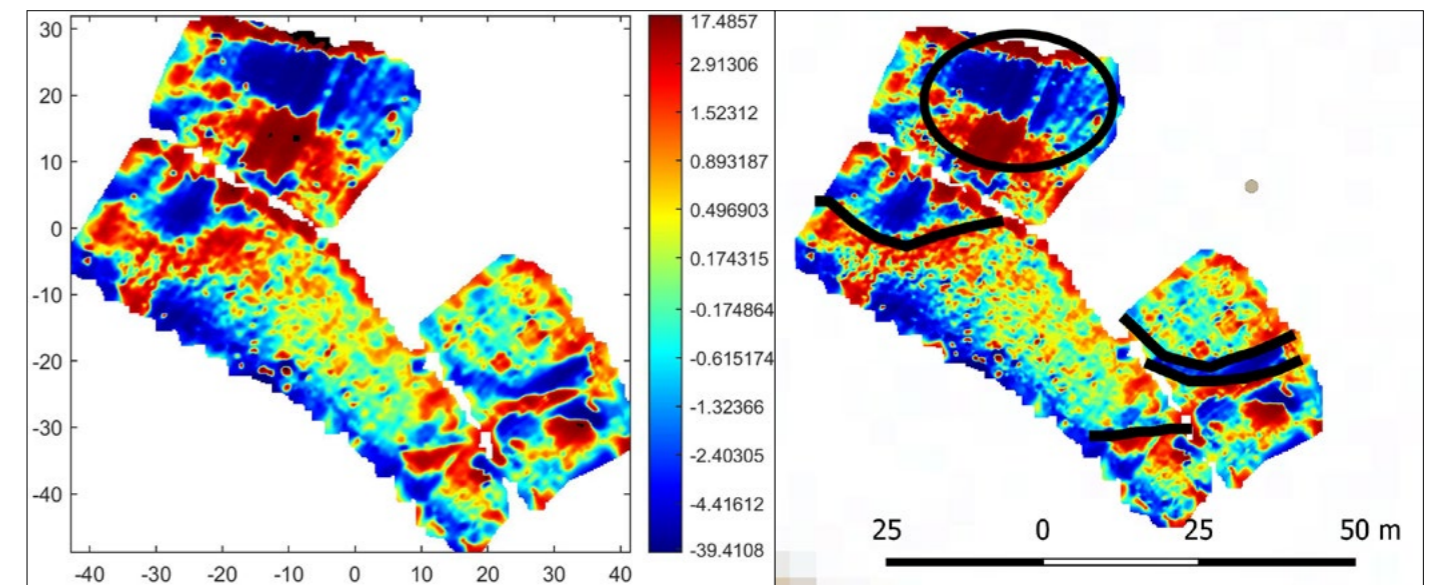

Figure 57: Waragena (SAZ 266). Map of the intensity anomaly of the total magnetic field of terraces 3, 4, and 5 with “equipopulation” scale interpreted (black lines) (R. Al Khatib Alkontar, H. Reiller - MAFTOr/IPGS-EOST).

General Conclusions

On the site of Gra Emni (SAZ 249), except for certain specific places, the method that we used did not allow to identify lineations linked to ancient walls or foundations. We were unsuccessful in guiding archaeological excavations on a large scale. In general, archaeological results did not fit with the interpretation of magnetic maps.

In our study, the comparison is biased by a coordinate gap between archaeological and magnetic data.

Besides, the high rate of demolition rubble on the surface and in the surroundings makes the identification of lineations on magnetic maps very difficult. In the context of Gra Emni, the state of conservation of the archaeological remains seems to be linked to the rate of demolition rubble in their surroundings.

In addition, remains of walls or foundations oriented in the north-south direction can be difficult to identify on a magnetic map in this specific context.

Models could be improved by taking into account the presence of high magnetization objects.

In the eastern area of Waragena, we identified anomalies which could be linked to the presence of archaeological remains; however it has to be checked against the results of a future excavation.

GRA EMNI (SAZ 249) - EXCAVATION OF THE SITE

Diaa ALBUKAAI (UMR 5133 Archéorient)

Anne BENOIST (CNRS, UMR 5133 Archéorient)

Marie-Belean DHORNE (PhD student, University Lyon 2)

Jérémie SCHIETTECATTE (CNRS, UMR 8167 Orient & Méditerranée)

Gauthier TAVERNIER (Independent archaeologist)

Aim and schedule

Wolwalo is a wide area, occupied in its centre by a small modern town. In the surroundings of the modern town, several contiguous localities show traces of past occupation (Sebdera, Gra Emni, Felaliya, Zebede, etc.). The survey led to formulate the hypothesis that a major occupation could have been located at the localities of Sebdera and Gra Emni, respectively immediately to the south and north of the modern town of Wolwalo.

In 2018, the locality of Sebdera was tested with a trench. In 2020, the main aim was to explore the very nature and density of the occupation in Gra Emni (SAZ 249), and date it. In parallel with the mapping of the site (see chapter “*Gra Emni (SAZ 249) - Topography of the site*”) and its geomagnetic survey (see chapter “*Geophysical survey of Gra Emni (SAZ 249) and Waragena (SAZ 256 & 266)*”), excavation started at Gra Emni. Five trenches were successively opened during the present season.

The location of the trenches was dictated by information provided by local farmers about the presence of underground remains (Trenches 1, 2 and 4), by the presence of remains in natural sections (Trench 5) and by the assumed presence of remains according to the geomagnetic survey (Trench 3). Only four yielded traces of occupation (Trenches 1, 2, 4, and 5). Trench 3 was empty of any anthropic material (see chapter “*Geophysical survey of Gra Emni (SAZ 249) and Waragena (SAZ 256 & 266)*”).

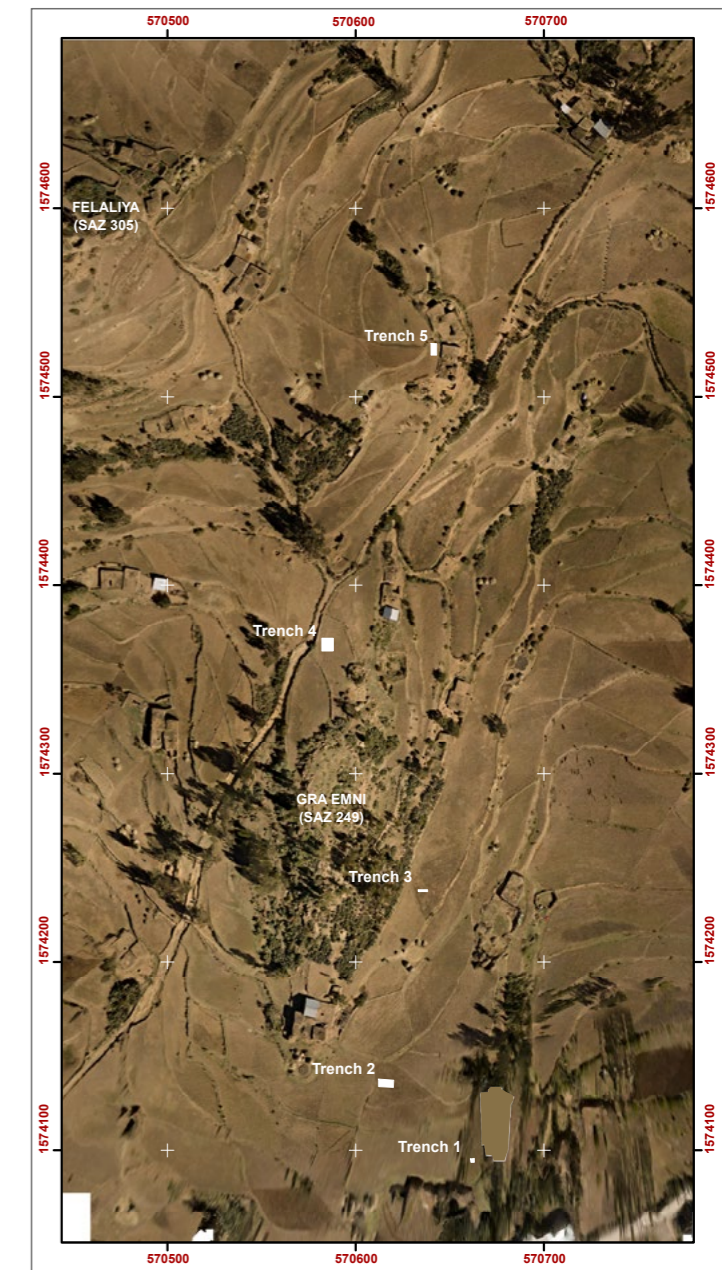
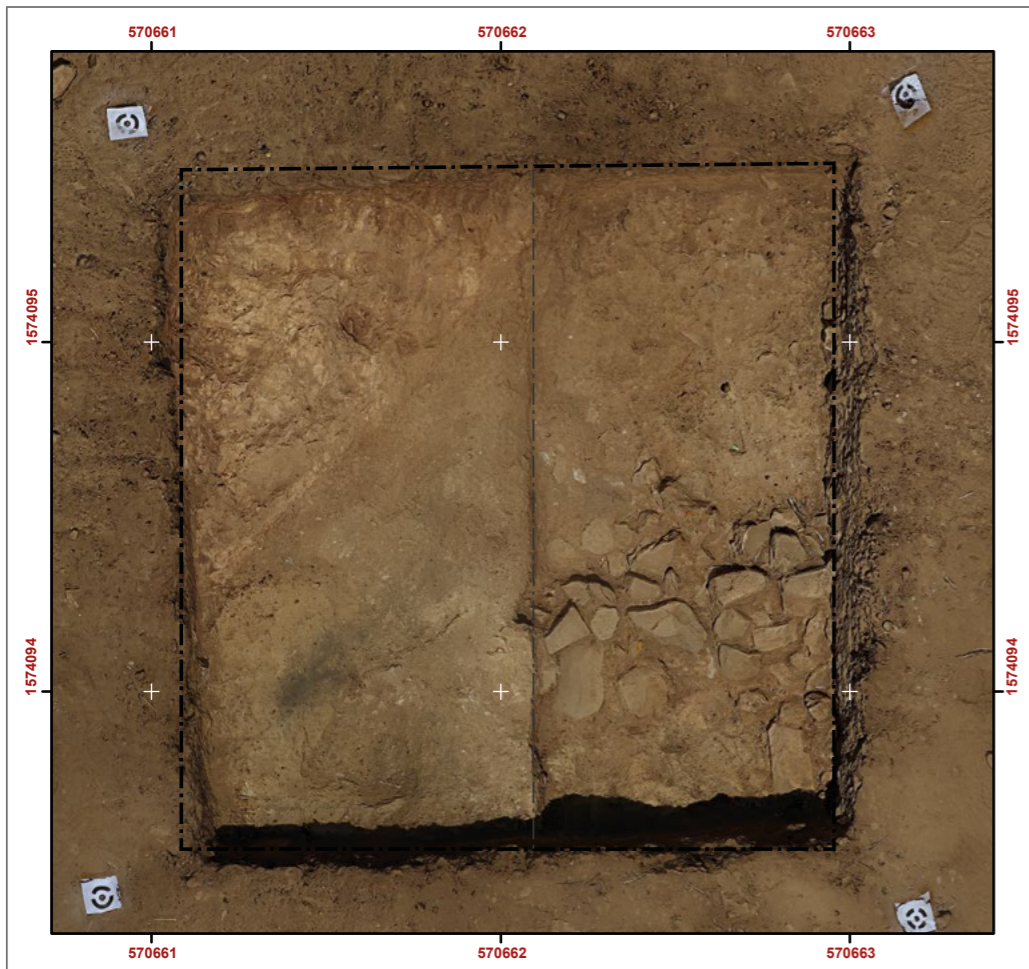

Figure 1: Gra Emni (Saz 249): Location of the 5 trenches on the orthophotograph of the site (J. Schiettecatte - MAFTOr).



SAZ 249 GRA EMNI
Trench 1
Orthophotograph

© MAFTOr - J. Schiettecatte - 2020
Coordinate System
WGS 84 UTM zone 37P
Projection: Transverse Mercator
Datum: WGS 1984



◀ **Figure 2:** Gra Emni (Saz 249) - Trench 1. Orthophotograph (J. Schiettecatte - MAFTOr).

▼ **Figure 3:** Gra Emni (Saz 249) - Trench 1. DEM and plan (J. Schiettecatte - MAFTOr).

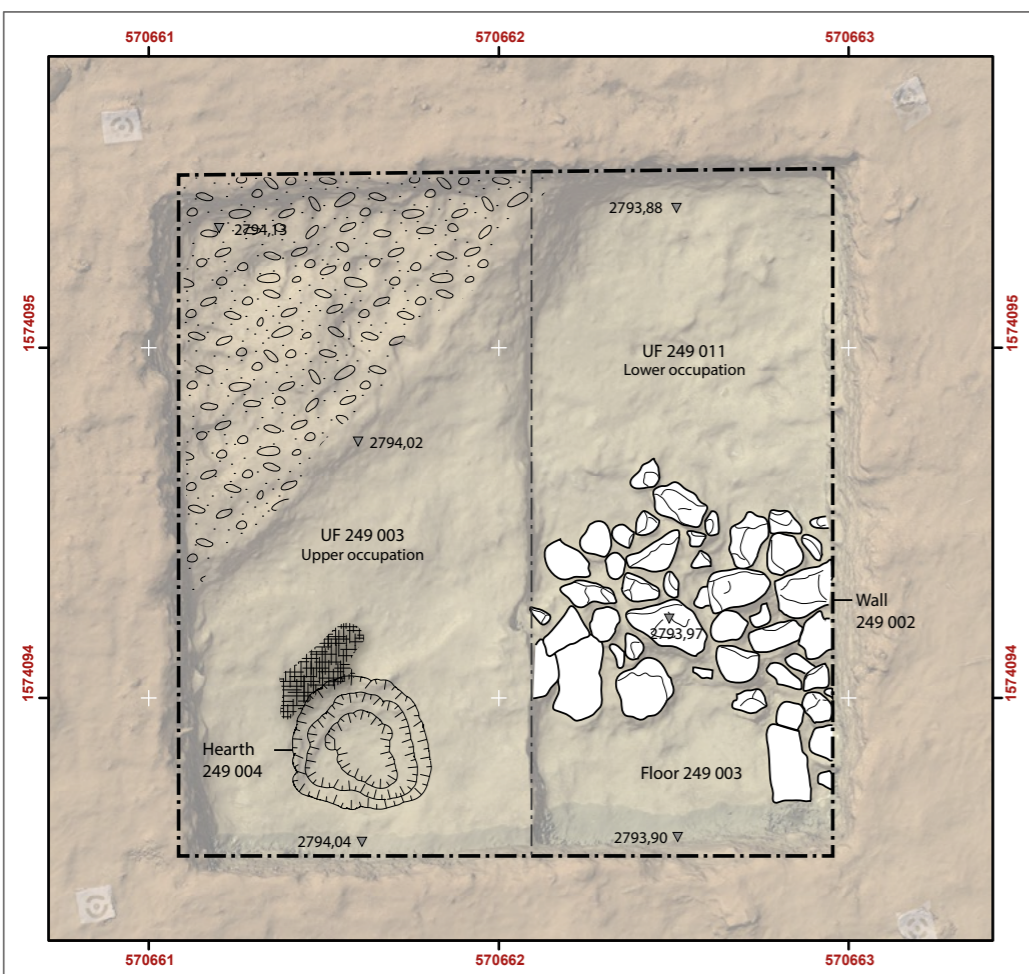

SAZ 249 GRA EMNI
Trench 1
Level 1, 2

- Substratum
- Ashes / Charcoal
- Stone
- Pit / Hearth
- Excavation limit
- Altitude (a.s.l.)

© MAFTOr - J. Schiettecatte - 2020
Coordinate System
WGS 84 UTM zone 37P
Projection: Transverse Mercator
Datum: WGS 1984



0 1 2 m

Trench 1

[by Diaa Albukaai]

This excavation was the first to be opened on the site of Gra Emni. It is located on the south-east limit of the site, in a field immediately to the north of the farm of Mabraatu Hagos. The farm owner mentioned the presence of buried structures, leading us to dig a first trial trench.

An area measuring 2 × 2 m was opened in an agricultural terrace. The sediment was only 20 to 45 cm thick above the bedrock. This accumulation was noticeably disrupted in the upper part because of ploughing activities. Under the upper layer, two occupation levels were identified below a level of destruction (figs. 2-3).

The lower layer (oldest occupation, UF 249 011) was represented by a 50-cm-large wall oriented east-west. It was built in small and medium stones. South of the wall there was an occupation level of compacted silt (floor 249 003) including some fragments of charcoals. It lied directly on the bedrock which was reached in the north-west corner of the excavation.

Above this, a more recent layer of occupation (UF 249 003) was made of compacted silt covering the top of the previous wall. A rounded hearth, 40 cm in diameter and 8 cm in depth, was found in the south-eastern part of the trench (hearth 249 004).

Although the excavation produced a few artefacts including potsherds, the paucity of the archaeological deposits and the quick apparition of the bedrock led us to look for another location.

Trench 2

[by M.B. Dhorne & G. Tavernier]

Trench 2 is set in Gra Emni, to the north-east of Trench 1, on a cultivated terrace located in Mabraatu Hagos's farm. This terrace is set on a slight north to south slope. The opening of a trench in this area was justified by the presence of a large quantity of ceramics on the surface noticed during the survey in 2018. The owner of the terrace also informed us of the presence of walls on his plots, including a north-south wall.

A first trial trench, 2 × 2 m, was opened. This excavation was extended twice: first by two metres to the east and to the north and secondly by four metres to the east. The total area excavated thus corresponds to a 4 × 8 m rectangle (fig. 4).

It was possible to distinguish four phases of occupation and a phase of abandonment (figs. 5-9).

1 - A pit in the southern part of the excavated area

The earliest phase of occupation, above the bedrock, was materialized by a partly unearthed oval-shaped pit on the southern edge of the excavation (pit 249 017: fig. 10 [under UF 249 019] and fig. 11). This pit was almost 2 m in diameter and 0.26 m deep. It was filled with a silty level rich in pottery (UF 249 019; UF 249 024), which also yielded two grindstones (M473; M485). Its bottom sits directly on the bedrock.

2 - Traces of a dismantled building

The second occupation phase is visible through a set of very badly preserved structures (fig. 10).

West of the trench, a very compact yellowish silty floor was identified (floor 249 011), which had delivered little pottery and mainly small sherds. A quartz grindstone was found associated with this floor (M 484). The floor was limited to the south and east by a network of trenches c. 50 cm wide and 35 cm deep. One of these trenches followed a north-south direction (fig. 10: trench 249 010, UF 249018). A second trench ran perpendicular to the previous one (fig. 10: trench 249 006, UF 249 021). Both trenches intersect at right angles south-east of the excavation area.

The filling of these trenches (UF 249 021; UF 249 018) was characterised by a brown silt including a large quantity of fauna and lithic tools (two grinding stones in the filling of trench 249 006: M474; M476 - see



Figure 4: Gra Emni (Saz 249) - Trench 2 - Orthophotograph (J. Schiettecatte - MAFTOr).

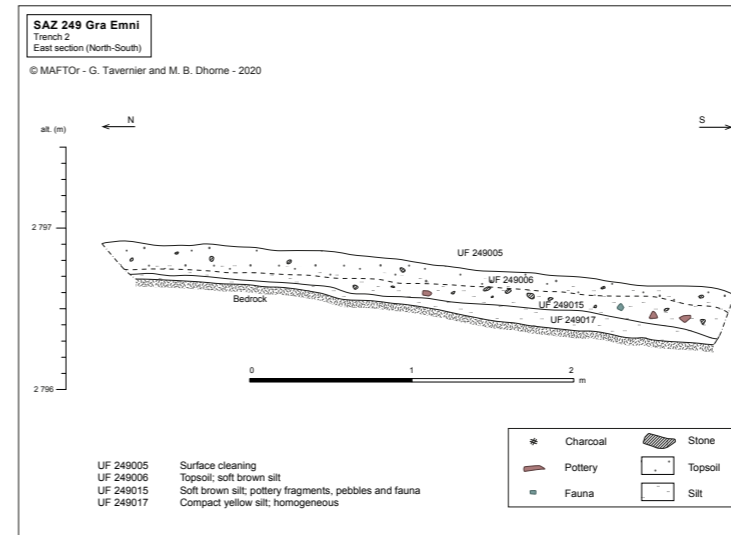

Figure 7: Gra Emni (Saz 249) - Trench 2 - North-south section, east of the trench (G. Tavernier/M.B. Dhorne - MAFTOr).

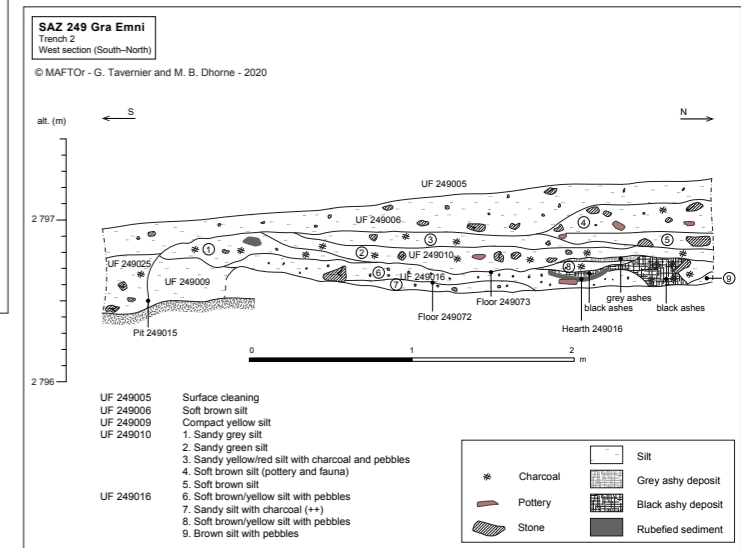

Figure 8: Gra Emni (Saz 249) - Trench 2 - South-north section, west of the trench (G. Tavernier/M.B. Dhorne - MAFTOr).

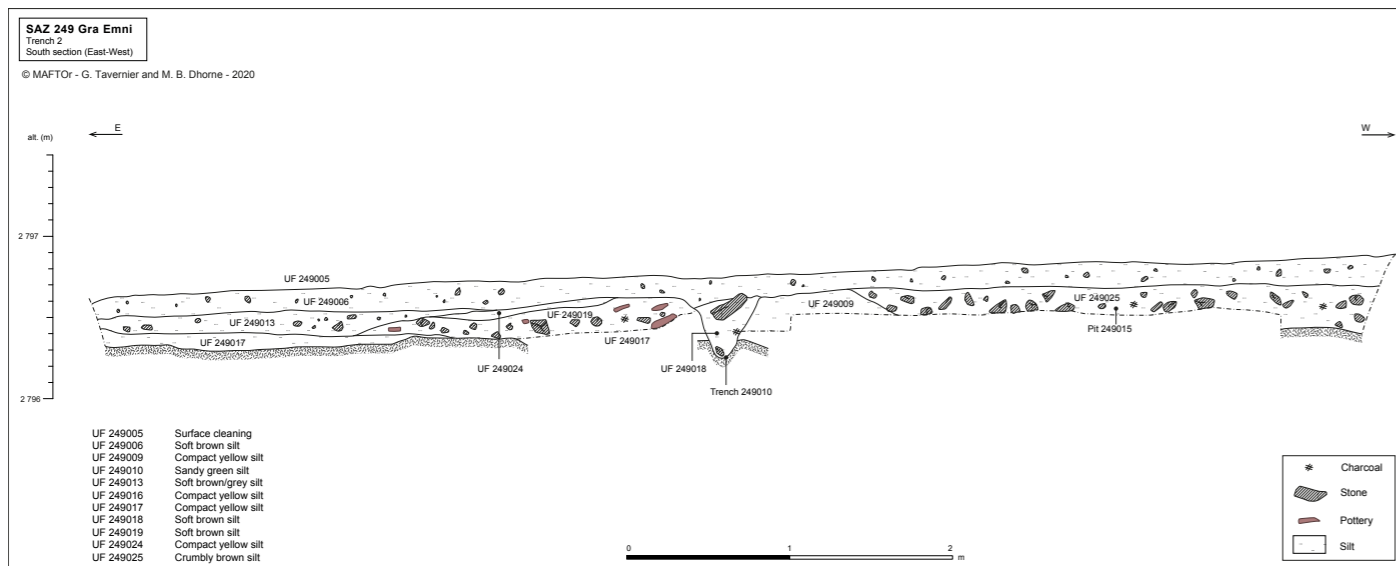

Figure 5: Gra Emni (Saz 249) - Trench 2 - East-west section, south of the trench (G. Tavernier/M.B. Dhorne - MAFTOr).

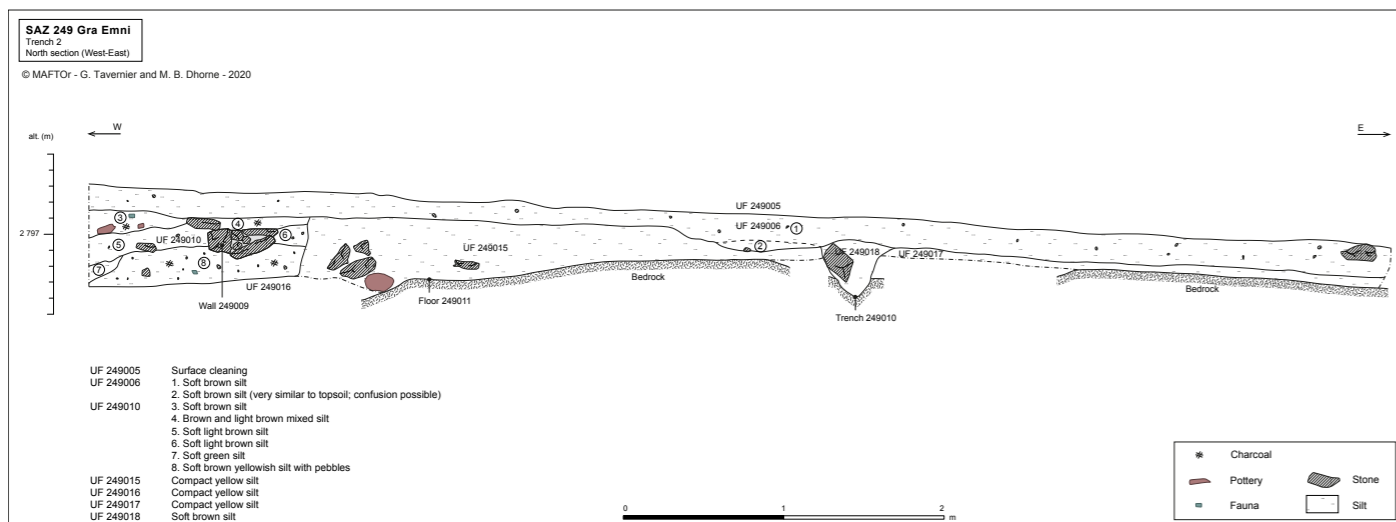

Figure 6: Gra Emni (Saz 249) - Trench 2 - West-east section, north of the trench (G. Tavernier/M.B. Dhorne - MAFTOr).

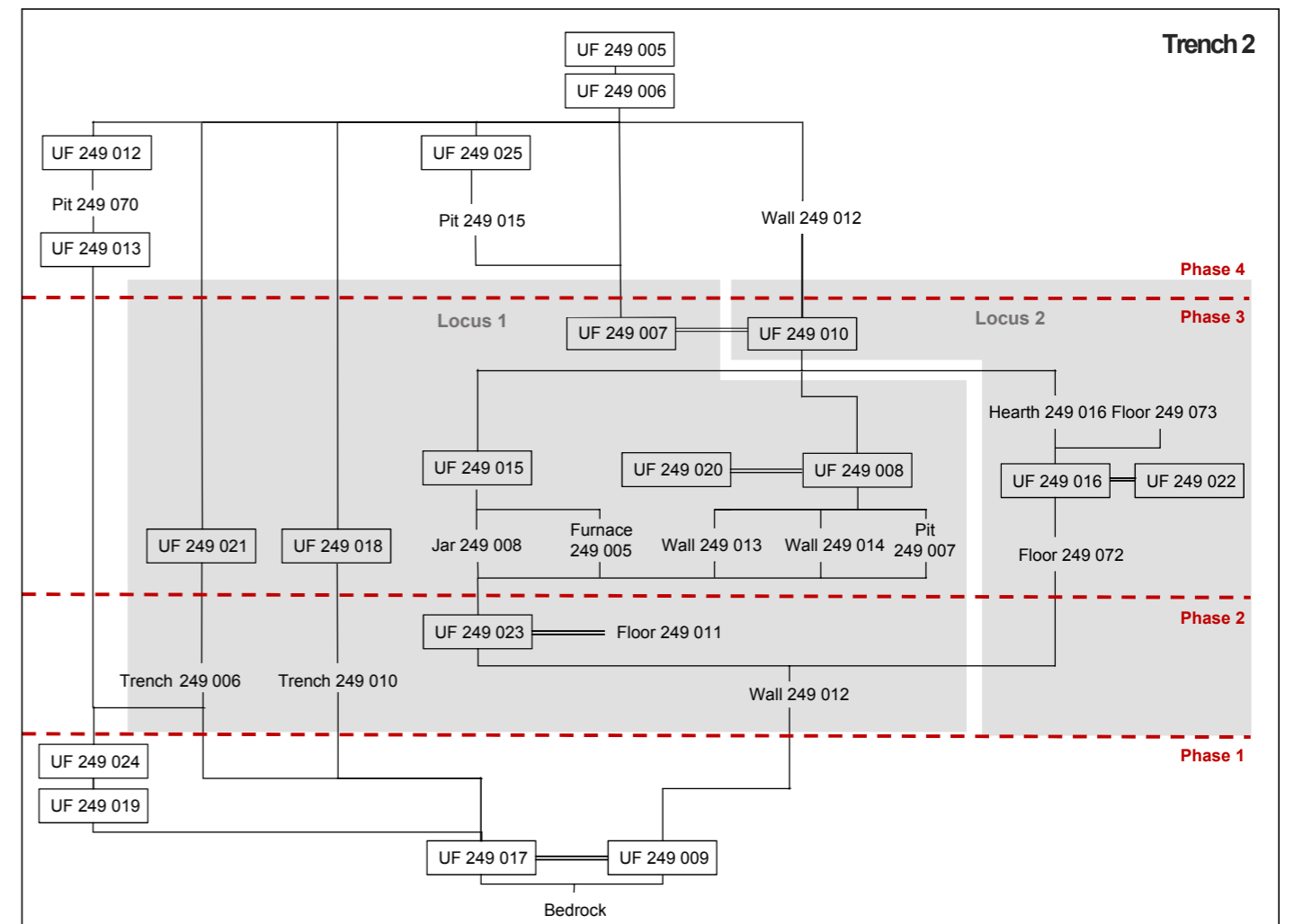

Figure 9: Gra Emni (Saz 249) - Trench 2 - Stratigraphic sequence (G. Tavernier/J. Schiettecatte - MAFTOr).

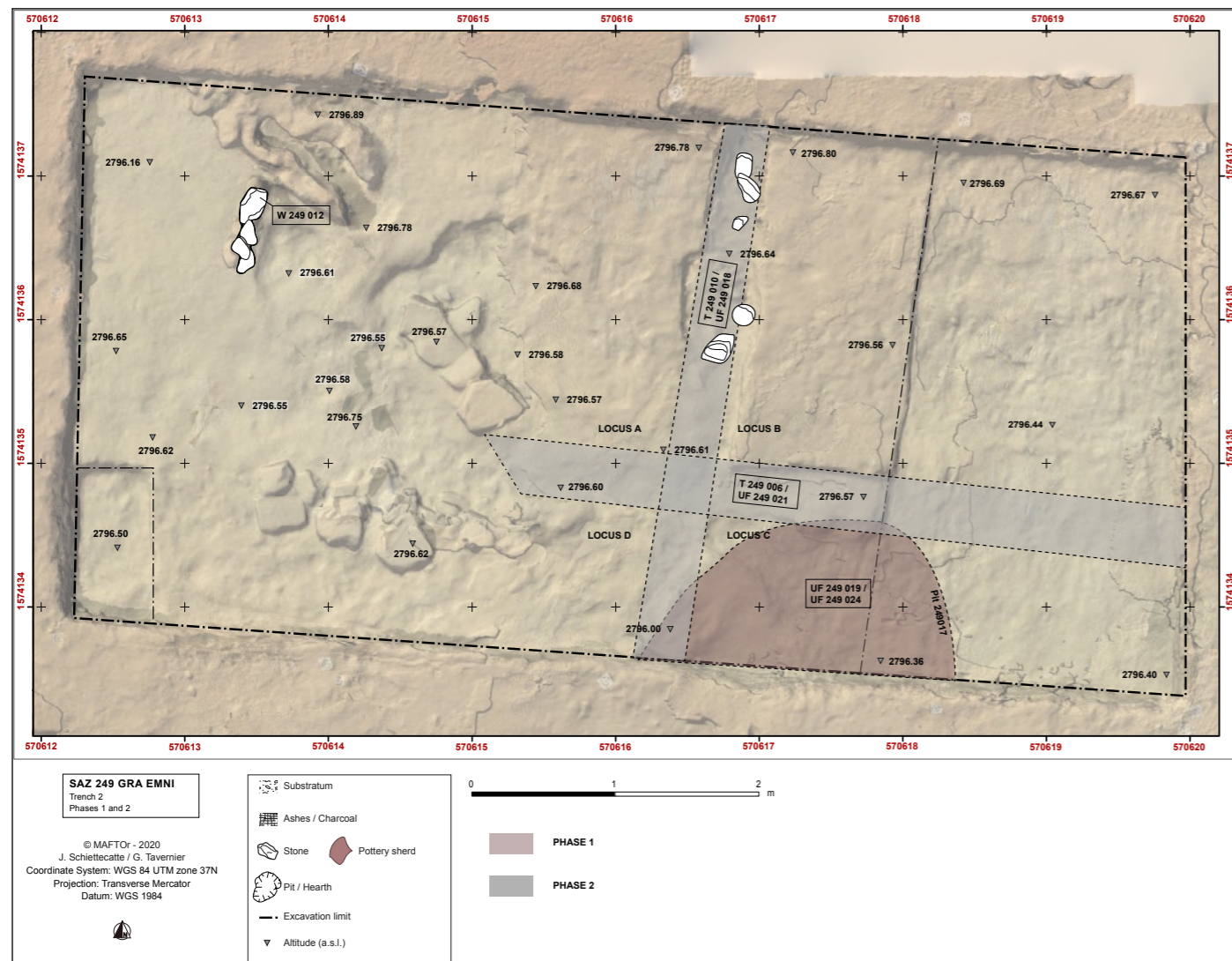

Figure 10: Gra Emni (Saz 249) - Trench 2 - Phases 1 and 2 with floor 249011, Trenches 249 006 and 249 010, remains of wall 249 012 and location of the different loci (J. Schiettecatte/G. Tavernier - MAFTOr).



Figure 11: Gra Emni (Saz 249) - Trench 2 - Pit 249 017 (phase 1) before its excavation (G. Tavernier - MAFTOr).

fig. 20) and four grinding stones and a hammer in the filling of trench 249 010: M475; M480; M481; M482; and M478 - see fig. 20). This filling was rather similar in texture and material to the sediment characterising the next phase.

These trenches could be the remains of foundation trenches for walls that might have been totally removed during the following phase for stone reuse. These trenches provided the outlines of a portion of a building extending on a surface of at least 6.8×4 m. This first building would have been totally dismantled. These trenches seem to continue beyond the north, south and east limits of the excavated area. These levelled walls delineated three to four rooms (fig. 10: loci A, B, C, and D).

In the western part of the excavation, the remains of a stone construction were found lying directly on top of the first occupation layers (Wall 249 012). This wall was 17 cm large and today only 60 cm long. Four courses were preserved, with an average height of 15 cm each. This low wall was oriented north-south, parallel to the north-south trench 249 010. The northern part of the structure ended up close to a furnace built during a later occupation phase.

This construction might represent the remains of an older wall, which would have been the western limit of locus A during phase 2. If so, the wall would have been partially preserved during phase 3 in order to protect furnace 249005 from the wind. It is also possible that this wall was only built during the next phase. Nevertheless, we observed that floor 249 011 abutting the eastern face of this structure. If this wall was built during phase 3, it seems to follow the layout of a previous structure, the blocks of which could have been reused.

3- A domestic occupation

The next occupation observed in Trench 2 corresponds to the setting-up of a domestic area including a furnace (249 005), a fireplace (hearth 249 007), and a layer of ashes and charcoals related to the oven deposited over the previous remains to the east of the wall 249012 (fig. 12).

If the low wall 249 012 predated these structures, its remaining part having probably been voluntarily kept standing by the builders of the furnace to protect it against the wind. The low wall continued north, beyond the limits of the trench. We do not know whether the builders of the furnace achieved the destruction of previous walls (see phase 2) or if it was already done. The shallow trenches for the construction of walls were probably still exposed: this would explain why the bottom of trench 249 006 was filled with a layer of ashes very similar to those covering the floor in all this area.

Furnace 249 005 was built in clay, with a few stone blocks 15 to 20 cm in length, totally sunk in a clay mortar. It had an elongated shape broadly resembling an “8”, opened at one end, with a small round-triangular chamber measuring 24×26 cm on the western end, against the remains of wall 249 012, and an oval chamber in the front measuring 56×32 cm opening onto it (figs. 13-14). The front chamber had straight vertical walls, the back chamber had slightly bending walls. The eastern end of the oven had a 20-cm-wide opening. In front of the door of the oven was a shallow pit with a small circular concentration of ashes.

The first chamber was slightly deeper than the second one and set directly on the bedrock. A first level of ashy filling was limited to this space. The second filling, characterised by a very homogeneous grey silt with occasional charcoals, extended equally between both parts of the furnace. Then follows a third, highly carbonaceous level followed by a compact yellow silt, rich in gravel, corresponding to the level of demolition (UF 249 015; UF 249 010).

South of the furnace, a layer of ashes extended outside over a roughly triangular area (UF 249 020 - figs. 12-13). It was probably the disposal area for the ashes from the furnace. This layer included ashes, charcoals, bones fragments, and potsherds in huge quantity in a silty matrix. This layer was very similar in texture to the layer of ashes filling the bottom of foundation trench 249 006 (location on fig. 10). The bottom of this trench was probably emptied when stones of a former wall were reused, possibly for the need of the construction of the furnace. The foundation trench was partly filled with ashes afterwards.

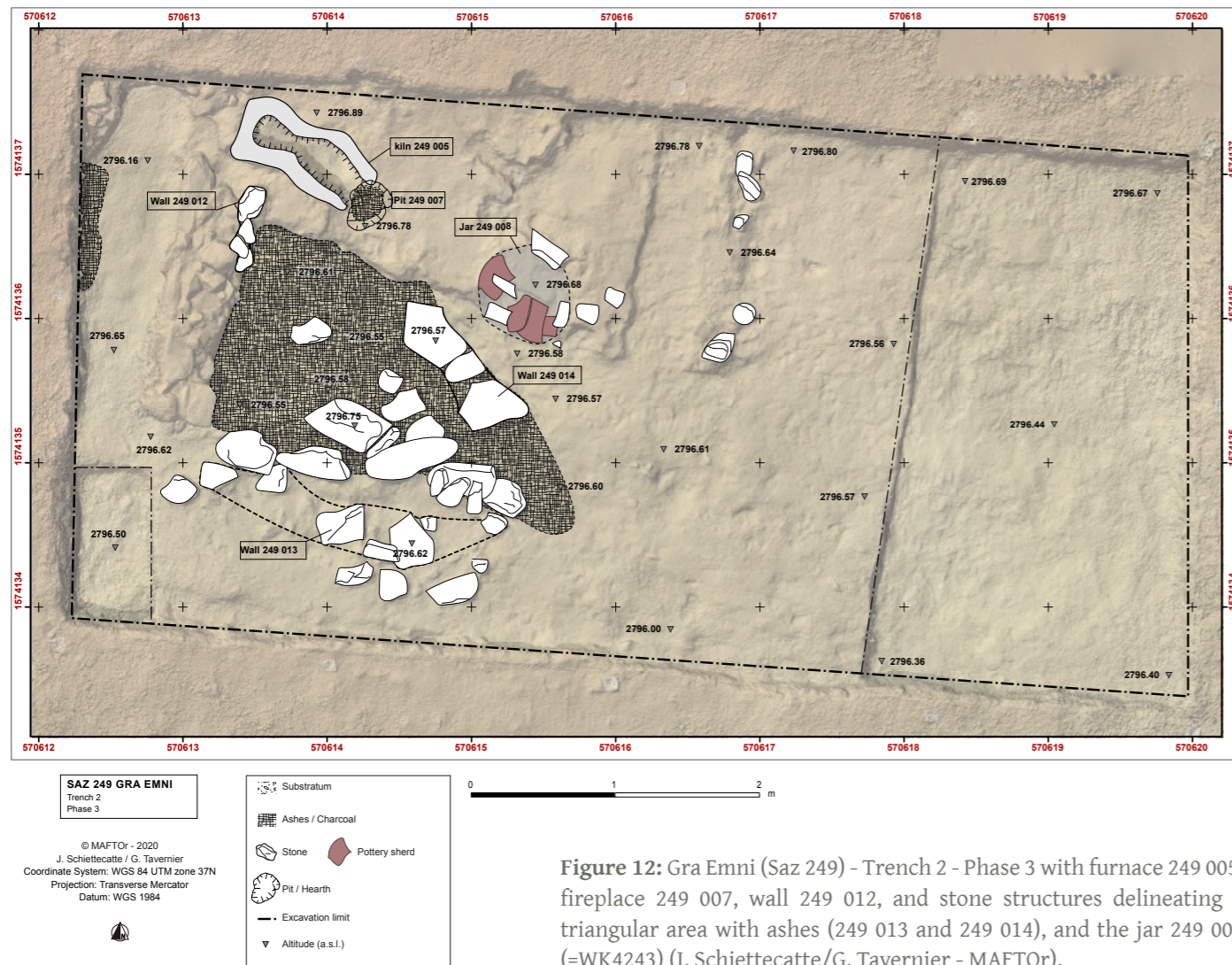

Figure 12: Gra Emni (Saz 249) - Trench 2 - Phase 3 with furnace 249 005, fireplace 249 007, wall 249 012, and stone structures delineating a triangular area with ashes (249 013 and 249 014), and the jar 249 008 (=WK4243) (J. Schiettecatte/G. Tavernier - MAFTOr).



13 | 14

15

Figure 13: Gra Emni (Saz 249) - Trench 2 - Stone structures 249 013 and 249 014 bordering a triangular ashy area. Looking north (G. Tavernier - MAFTOr).

Figure 14: Gra Emni (Saz 249) - Trench 2 - Furnace 249 005 (G. Tavernier - MAFTOr).

Figure 15: Gra Emni (Saz 249) - Trench 2 - Ashy pit 249 007 (G. Tavernier - MAFTOr).



The triangular area related to the furnace (figs. 12-13) was roughly delineated to the south and to the north-east by stone alignments. To the south, stone structure 249 013 might have been directly built with the last stones of a former wall set in Trench 249 006: its foundation trench is just below. To the north-east, stone structure 249 014 was built obliquely, following a north-west – south-east direction. These two limits were surrounded by several erratic blocks, likely the remains of the collapse of the upper parts of these structures.

A small pit was dug on the floor south of the furnace (pit 249 007). This pit had a circular shape and a bowl-shaped profile. It is 40 cm large and 24 cm deep (fig. 15). The pit was filled with a very ashy silt, containing a fragment of a grinding stone (M 483 - fig. 20) and some potsherds. This structure could also have benefited from the wind shield offered by low wall 249 012. Despite the significant presence of charcoals within the structure, the sides of the pit were not burnt, which prevents its interpretation as a hearth.

C. 1 m south-east of the furnace, the remains of a complete storage jar in common ware (structure 249 008 - WK4243) were found on the floor, in a shallow pit (fig. 16). The potsherds of the jar were showing no traces of any contact with the ashy area further south-west. They were surrounded by several stone blocks which might represent the remains of a stone wedging around the jar. A complete bowl in common red ware (WK4217) and a small pot in common brown ware with geometrical incisions (WK4218) were found nearby. West of low wall 249 012, two floors were superimposed (figs. 8, 17). The lower one was probably associated to the disappeared building (floor 249 072 at the bottom of UF 249 016). A yellowish loamy soil rich in charcoal develops on the same level as floor 249 011. The limit between both soils follows the axis of the low wall M 249 012. Above it was a second floor marked by a yellow silt loaded with gravel (floor 249 073). This level abutted against the low wall M 249 012 to the west. A calcareous-sandstone grindstone was discovered on the second floor (M 465). The floor also included a small round hearth (hearth 249 016) characterised by a simple concentration of ashes on the floor.

Both spaces extending to the west and east of low wall 249012 were then covered by a similar layer which marks the end of the occupation before the abandonment. This last occupation is characterised by an ashy silt, rich in potsherds and fauna (UF 249 008/UF 249 010). East of the low wall, it corresponds to the ashy level (UF 249 020) associated with the furnace. A crusher and a fragment of a grindstone (M 471; M 487) were found west of low wall 249 012. East of the wall, we collected a single grindstone (M 479). North of furnace 249 005 and low wall 249 014, the area was filled with an occupation layer of yellow silt (UF 249 015). This layer was distinct from the ashy occupation by the low quantity of charcoals that it included. In addition to the complete storage jar (WK4243), the bowl (WK4217) and the small pot (WK4218), this level delivered two grindstones (M 469; M 470) and a hammerstone (M489). The two loci were sealed by an abandonment level of yellow silt (UF 249 010).

Several hypotheses have been raised during the excavations concerning the activities carried out in and around the furnace. Its presence could indicate craft activities. Metallurgic activity has been ruled out due to the lack of identification of slag-like waste. Considering the ethnographic observations carried out as part of the mission, the furnace could have been used as a space for drying ceramic products before firing. However, this use is difficult to prove. The fact remains that there is an association of a heating structure with a storage area, a soil very rich in charcoal and fauna as well as the presence, within the site and in the filling of the trenches, of a very large number of stone tools. All these elements could indicate a domestic area where culinary activities were carried out. This interpretation is the most likely.

4 - Few evidences of a later occupation (fig. 19)

A few structures appear to be more recent. East of the trench, a large circular pit almost 1.30 m in diameter (pit 249 070; UF 249 012), rich in ceramics, was identified directly below the ploughing level (UF 249 006). Above wall 249 012 appeared the lower course of an upper wall built directly atop of it (wall 249 009). This double-faced wall was built with rough stones c. 30 cm long. It was preserved on a single course of stones. It was not associated to any occupation level but is surrounded by an important layer of stone collapse



Figure 16: Gra Emni (Saz 249) - Trench 2 - Phase 3 - complete storage jar in common ware (structure 249 008 - WK4243) (G. Tavernier - MAFTOr).



Figure 17: Gra Emni (Saz 249) - Trench 2 - Western bench showing two superimposed floors 249 072 and 249 073 (G. Tavernier - MAFTOr).



Figure 18: Gra Emni (Saz 249) - Trench 2 - Wall 249 009. Looking east (G. Tavernier - MAFTOr).

extending mainly to the east. The wall seemed to extend beyond the limit of the trench, further north (upper part of UF 249 010). The archaeological remains were covered by a c. 20-cm-thick layer of topsoil (UF 249 006) (figs. 18-19).

Finally, in the south-west corner of the excavated area, a pit or a trench appeared just below the topsoil (pit 249 015, UF249 025). It went through the previous layers, down to the bedrock (figs. 8, 19). Its filling consisted of a very loose silt including a lot of stones. The observable part of the structure was 3.14 m long, 0.32 m wide and 0.38 m deep. It showed a rather straight limit oriented east-west.

This structure only appeared at the extreme southern limit of Trench 2, and the restitution of its shape remains conjectural. It may have been a foundation trench for another east-west wall. This remains conjectural.

Artefacts in Trench 2

Objects collected in the excavation only include potsherds and stone tools (fig. 20). Pottery is discussed in a following chapter. Stone tools are briefly reported here.

Several types of lithic tools have been identified within the site. The most frequent type is represented by a series of multifunction stones which were found in almost all the phases, from the oldest layer to the surface sampling. These tools were made from rocks of different kinds. Several types of sandstone, sandstone-limestone, as well as quartz have been identified (M 474, M 481, M 475 - fig. 20). This heterogeneity in the selection of the raw materials contrasts with a clear standardisation of shapes. Most multifunction stones have a broad similar spheroid form, ranging from 6 to 8 cm in diameter, often with two slightly flattened sides. Their size makes them easy to be handled with one hand. Traces of abrasion can be identified on almost all the faces. These marks were also systematically associated with small cavities due to hammering, more or less discreet, scattered over the entire surface of the objects (M 460, M 464, M 465, M 473, M 481).

Other lithic tools include six small pebbles in a hard stone, 3 to 4 cm in diameter. These pebbles showed signs of wearing on their flattened side or on the edge (fig. 20: M477). Regional ethnographic studies (M.B. Dhorne, 2017-18) have shown that potters use this type of tool for the smoothing and polishing of pottery. These objects, like the crushers, were present in all the phases.

To finish, two fragments of grinding stone (fig. 20: M483) and a polisher (fig. 11: M519) were found, the first in the filling of hearth 249 007, and the second in the demolition layer UF 249 010. It is an elongated tool made of sandstone with a bevelled end and abraded on one side. Another polisher was identified in the same layer. It is made from a potsherd.

Conclusion and perspectives

Four phases were identified within this Trench 2. The first is limited to a circular pit south of the area. The second phase corresponds to a building identified by the presence of two trenches as well as the remains of a possible north-south wall. These structures delimit a space of which only a floor has been partially preserved (Locus A). During the next phase (phase 3), the foundation blocks that were filling these trenches were removed and probably reused for the construction of low walls. Only a short part of the north-south wall remained in place, or was rebuilt, probably to shelter from the wind a furnace set up directly to the north of it. We observe, during this third phase, the establishment of a domestic activity area, characterised by the presence of this furnace, a storage jar, and two low walls delineating an ash discharge area very rich in potsherds and fauna. The occupation also developed to the west of the north-south wall where two successive floors and a hearth have been identified. Following the abandonment of this domestic area, a wall was built, atop the previous north-south wall. Two pits, to the east and south of the excavated area, were also set up after the abandonment of the domestic space.

Extending Trench 2 further east, west and north would certainly provide us with a better understanding of the organization and purpose of the second and third phase. Concerning phase 2, it might highlight the organization of the rooms, their surface and their purpose. For phase 3, extending the trench to the west

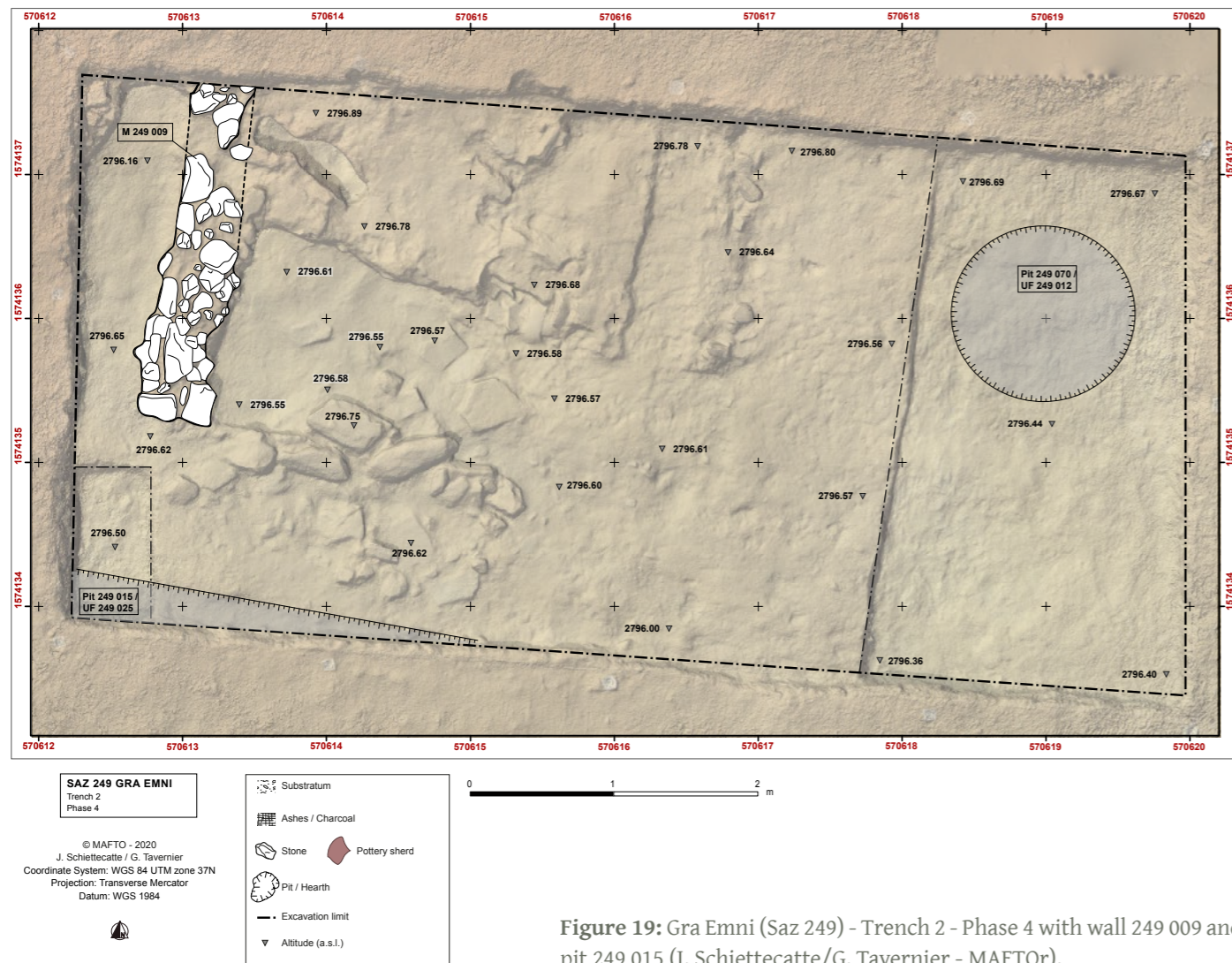

Figure 19: Gra Emni (Saz 249) - Trench 2 - Phase 4 with wall 249 009 and pit 249 015 (J. Schiettecatte/G. Tavernier - MAFTOr).

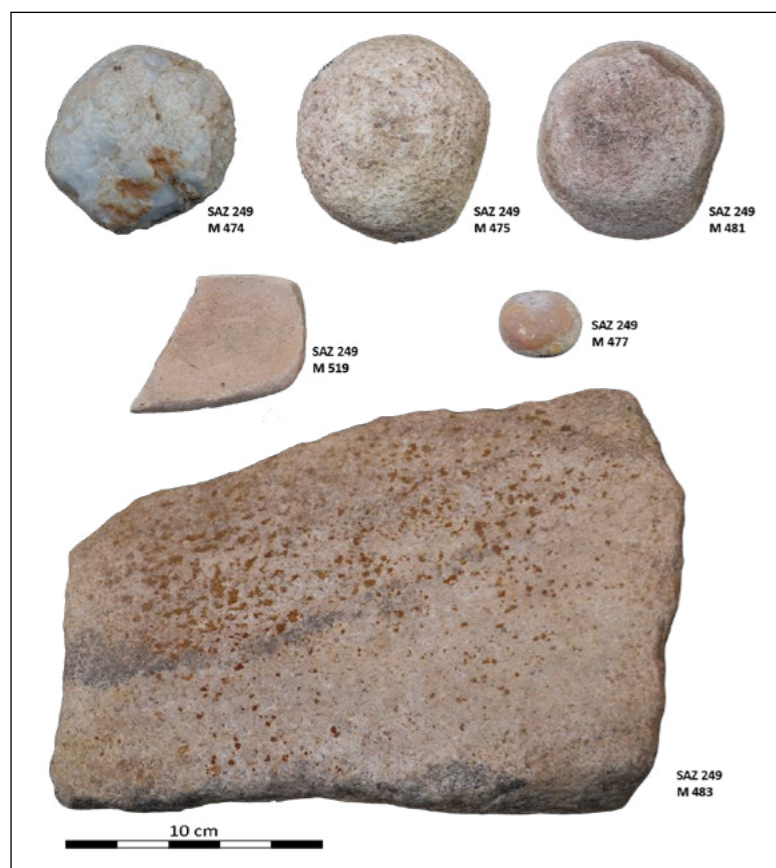

Figure 20: Gra Emni (Saz 249) - Trench 2. Stone tools from Trench 2 (M.B. Dhorne/J. Schiettecatte - MAFTOr).

would provide clues regarding the partially excavated floors. North of the trial, several complete potteries appeared during the straightening of the section. This extension could also enable to follow the development of wall 249 009 (phase 4).

Trench 3

[by J. Schiettecatte]

On the eastern slope of the hill of Gra Emni, the geomagnetic survey revealed a lineation which we thought to be indicative of the presence of a buried structure (fig. 21). An 8 × 1-m-long trench was excavated to check the nature of this magnetic anomaly and the potential presence of remains. The sounding was only filled with a 30 to 80-cm-deep homogeneous layer of silty clay and stones lying directly on the bedrock (fig. 22). The magnetic anomaly was not related to an anthropic signal; it was probably due to the spread of rocks on the surface generating a large number of dipolar anomalies (see chapter “Geophysical survey of Gra Emni (saz 249) and Waragena (saz 256 & 266)”).

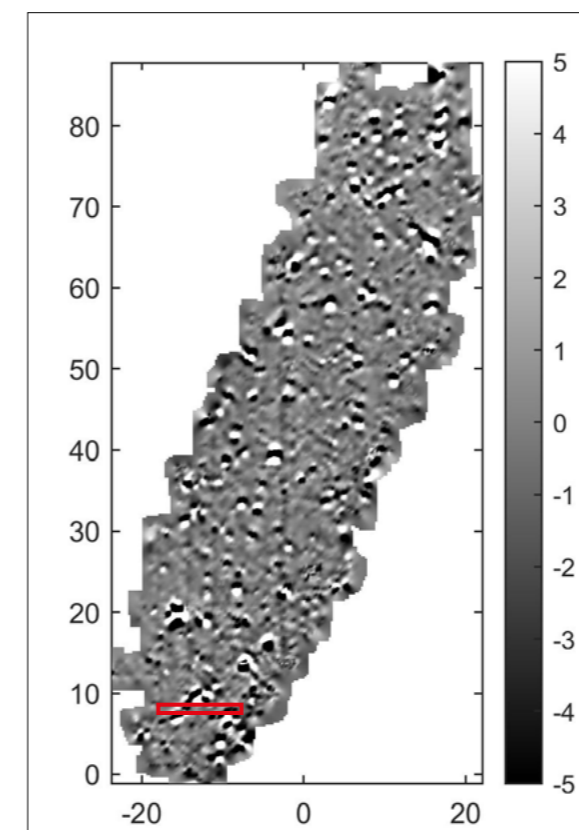

Figure 21: Location of Trench 3 on a lineation generated by a magnetic anomaly on terrace 2 (R. Al Khatib Alkontar, H. Reiller - MAFTOr/IPGS-EOST).



Figure 22: Trench 3 with no anthropic feature (R. Al Khatib Alkontar, H. Reiller - MAFTOr/IPGS-EOST).

Trench 4

[by Diaa Albukaai]

98 Trench 4 is located north of the hilltop of Gra Emni (fig. 1), on an agricultural terrace, immediately to the west of Abraha's farm. The terrace was partly dug by the owner in order to reuse stones. The local administration was informed of the discovery of architectural remains and stopped the digging here. The mention by local people of architectural remains in this area motivated our choice to open an excavation here. The trench measures 7 × 6 m.

Space organisation and stratigraphy in the excavated area

The excavation allowed the unearthing of the remains of a stone building preserved on a height of 50 cm (fig. 23) with at least two phases of occupation before its collapse and abandonment, and a possible reoccupation of the area after the collapse of the building (figs. 24, 26).

A scarce post-collapse occupation of the area

Under a surface layer of silt and stones (UF 249 029), a wide collapse layer was unearthed. It was made of a superimposition of an ashy layer of silt (UF 249 034) atop a thick layer of collapsed stones (UF 249030) (fig. 25). The upper ashy layer resulted from scattered hearths. Between these two layers, in the southern part of the trench, a fragmentary statuette of a woman has been found. Only the torso is preserved (figs. 27a-27c).

A main architectural occupation of the area

Below the ashy layer, the remains of a stone building were preserved on a height of c. 50 cm (fig. 25). Three loci have been distinguished.

Locus 1 is located in the middle of the western part of the trench. It is a room bordered by wall 249 060 to the east and wall 249 061 to the south. The north-east limit is unknown, due to the presence of a large pit (249 068). The western wall was located beyond the edge of the trench, further west. The excavated area of that room is 2 × 1.85 m. Two successive occupation layers have been distinguished. Only the upper one was unearthed (floor 249 035), the lower being only visible in the section created by pit 249 068.

The upper occupation was characterised by a pavement made of flat slabs in schist, limestone, and sandstone still visible at different places on the floor, especially along the eastern and southern walls. West of the locus, the lower part of an elongated oven (oven 249 038) oriented east-west was preserved. It is made of a 10-cm-thick U-shaped wall, 91 × 31 cm, built in clay, with an opening located to the east measuring c. 11 cm in width (fig. 28). The wall of the oven was compact and reddened, which suggests a high-temperature heating. Charcoals were sampled inside and in the immediate vicinity for ¹⁴C dating. A concentration of ashes was visible to the south of the oven.

Locus 2 is located in the south-east corner of the excavated area. It was bordered by wall 249 061 to the north, 249 062 to the east. Possible western and southern walls were located beyond the benches and have not been unearthed. An access (249 063) was given to locus 1, to the north, through a door with a nicely built threshold in schist slabs (fig. 29). Only a limited part of locus 2 was excavated (c. 1.4 × 1.3 m). The floor (F. 249 037) was made of rammed earth; it was covered with a succession of yellowish compact clay layers alternating with grey layers of ashes (UF 249 032). Above floor 249 037, a structure made of two courses of stones (St. 249 039) was built along the northern wall 249 061, just in front of access 249 063 linking Loci 1 and 2 (fig. 29). It cannot be stated whether the purpose of this structure was to strengthen the wall, to create a step or to wall the door.

Locus 3 is located in the eastern part of the excavation area. It appears as an open-air area, where no additional constructions were found. Two occupation layers separated by a layer of stone collapse were identified.

The lower occupation (UF 249 036) lied directly on the bedrock. It was made of packed earth and includes a large quantity of artefacts. In the centre of the excavated area, a complete pot has been found in situ together with a large grindstone, two small crushers and two lids made in a slab of schist (fig. 30).

The upper occupation was a greyish ashy layer, rich in material (potsherds, small lid in schist, numerous stone tools: crushers, hammers, grindstones) and a large quantity of faunal remains (UF 249 033). This layer was only preserved on a 1.5 m large strip along walls 249 060 and 249 062. It was not preserved further east, where it was replaced by a layer of yellowish earth and stones which seems to be part of the destruction layer below (UF 249 064 and 249 065).

The architecture

Trench 4 yielded the remains of a well-preserved building of which only two rooms were excavated this season (loci 1 & 2). They were connected together by a door. Walls were built in stones of various size. Large blocks were relatively scarce.

Wall 249 060. This wall oriented north-south was only preserved in its southern part, the northern end having been destroyed by a modern pit (249 068). The wall was 55 cm thick and was double faced. The western face, on the inside, was made of small stones. The inner filling was composed of small and medium stones and of a mortar of yellowish clay. The eastern face, on the outside, was built with large stones in header or boulder. It included two parts (figs. 31-32).

- At the corner of the building the southern end of the wall was preserved on four courses on a height of 50 cm. The lower course was 20 cm high and rested directly on the bedrock. It was covered with three courses of flat stones 8 to 12 cm thick carefully superimposed.
- The rest of the outer face of the wall was less homogenous. The three lower courses were in the continuity of the two lowest courses of the corner. The upper part was made of irregular large blocks consolidated by smaller stones.

Wall 249 062 was 50 cm thick and 50 cm high and also oriented north-south. In its northern part, the wall had only two courses, the first being a 35-cm-high stone (figs. 32-33). The rest of the wall was made of blocks of various sizes (fig. 33). The wall was double faced. The inside was filled in with small and medium stones tied with a mortar of yellowish clay. In its northern part the wall was tied with wall 249 061, set perpendicular. However, it was not tied with wall 249 060, which was abutting against it. Wall 249062 continued beyond the excavation limit to the south.

Wall 249 061 was 50 cm thick. It was oriented east-west and tied to the east with walls 249 060 and 249 062. It separated the two rooms Loci 1 and 2 (fig. 29). The two faces of the wall were built in stones of medium size. The inner filling was made of smaller stones. The last course but one was made of large slabs of schist (20 to 40 cm in length) set horizontally. In the middle of the wall, they constituted the threshold. The foundations of the wall were not unearthed so far. The western part of the wall continued beyond the excavation limit.

Door 249 063 is located in the eastern part of wall 249 061. It linked the two rooms Loci 1 and 2. The door-step was built in a course of slabs of schist which was in continuity with the course of schist slabs observed in the wall 240 061. The door was 95 cm large. The threshold was 4 cm higher than the floor of Locus 1 and 10 cm higher than the floor in Locus 2 (fig. 29).

Artefacts from Trench 4

Trench 4 has yielded a rich corpus of artefacts, which will be described in this preliminary note, with the exception of pottery which will be described in the next chapter.

Anthropomorphic figurine

A fragment of a clay anthropomorphic figurine has been collected in the destruction layer covering Locus 3 (UF 249 030) (figs. 27a-27c). It represents the torso of a woman. The statuette is 5.8 cm high. The head is



Figure 23: Gra Emni (Saz 249) - Trench 4 - Orthophotograph (J. Schiettecatte - MAFTOr).

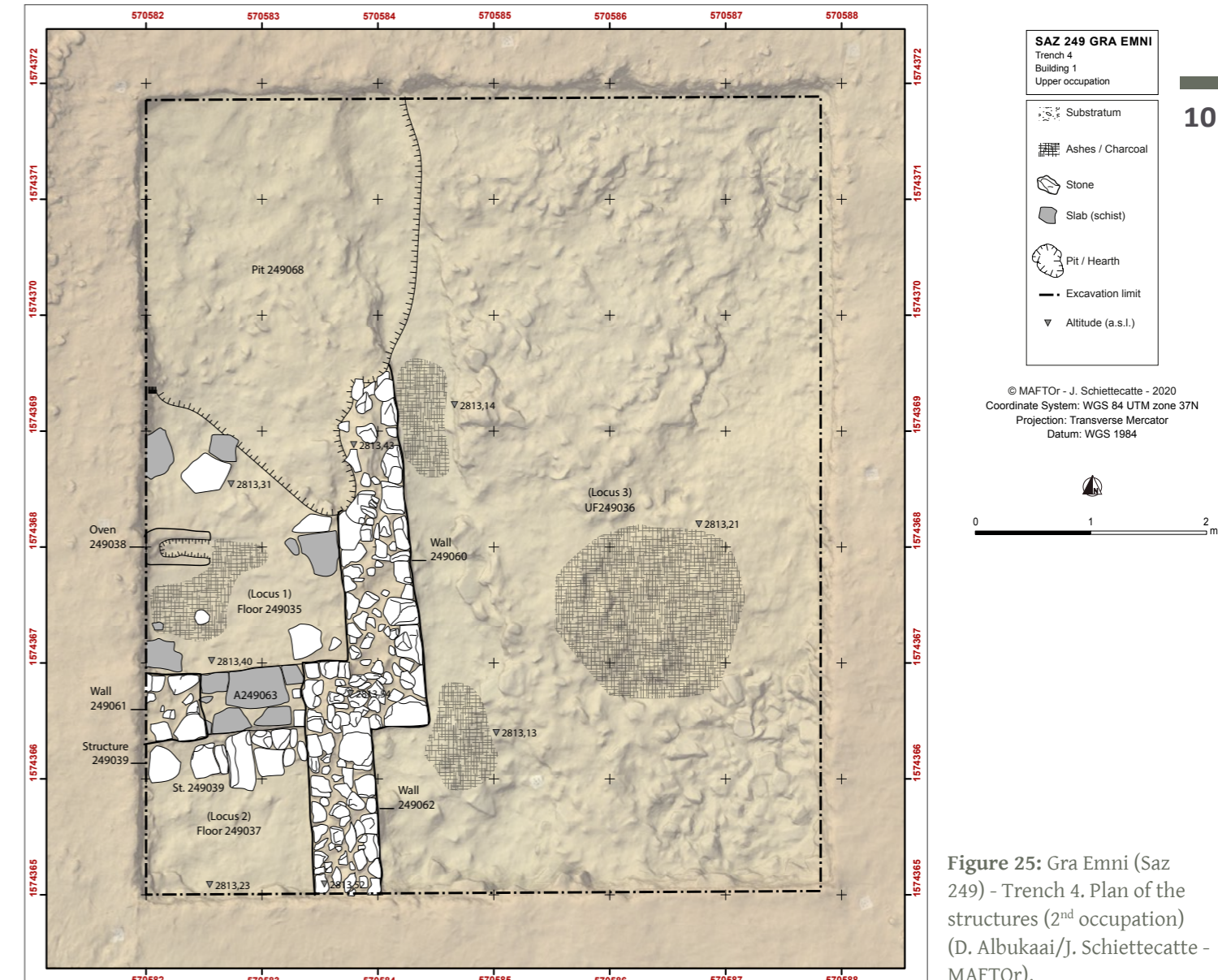

Figure 25: Gra Emni (Saz 249) - Trench 4. Plan of the structures (2nd occupation) (D. Albuakaai/J. Schiettecatte - MAFTOr).

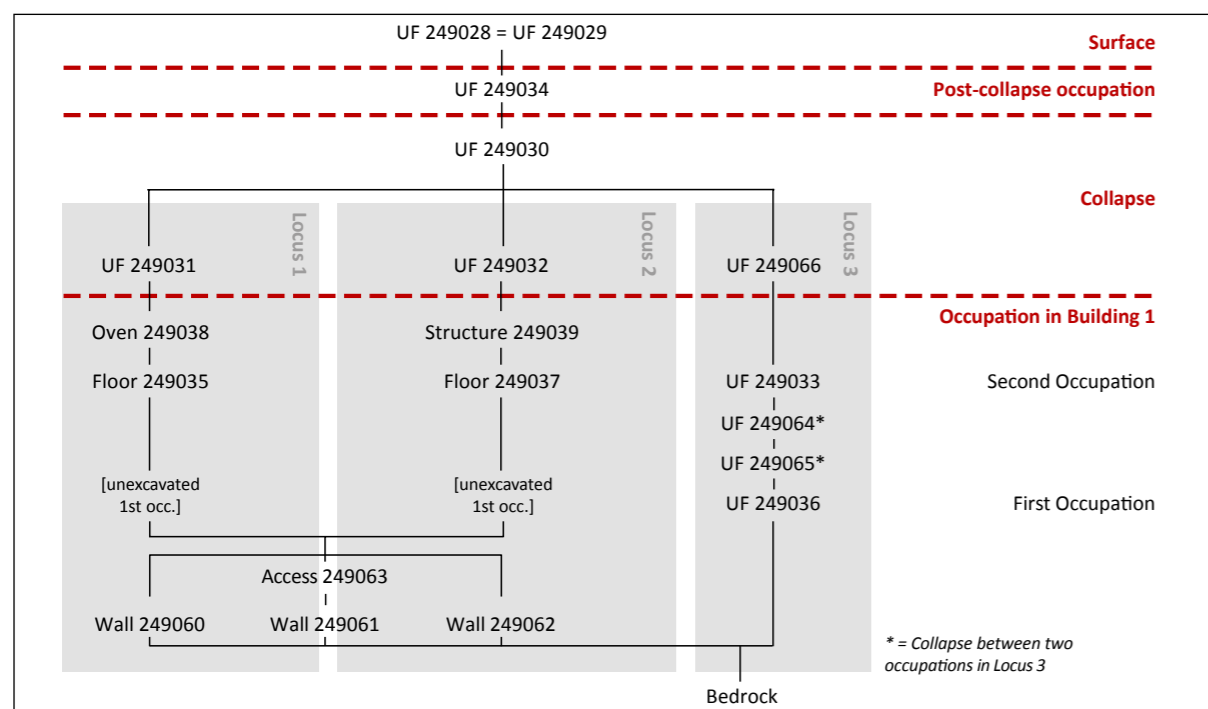

Figure 24: Gra Emni (Saz 249) - Trench 4 - Stratigraphic sequence (Diaa Albuakaai/J. Schiettecatte - MAFTOr).

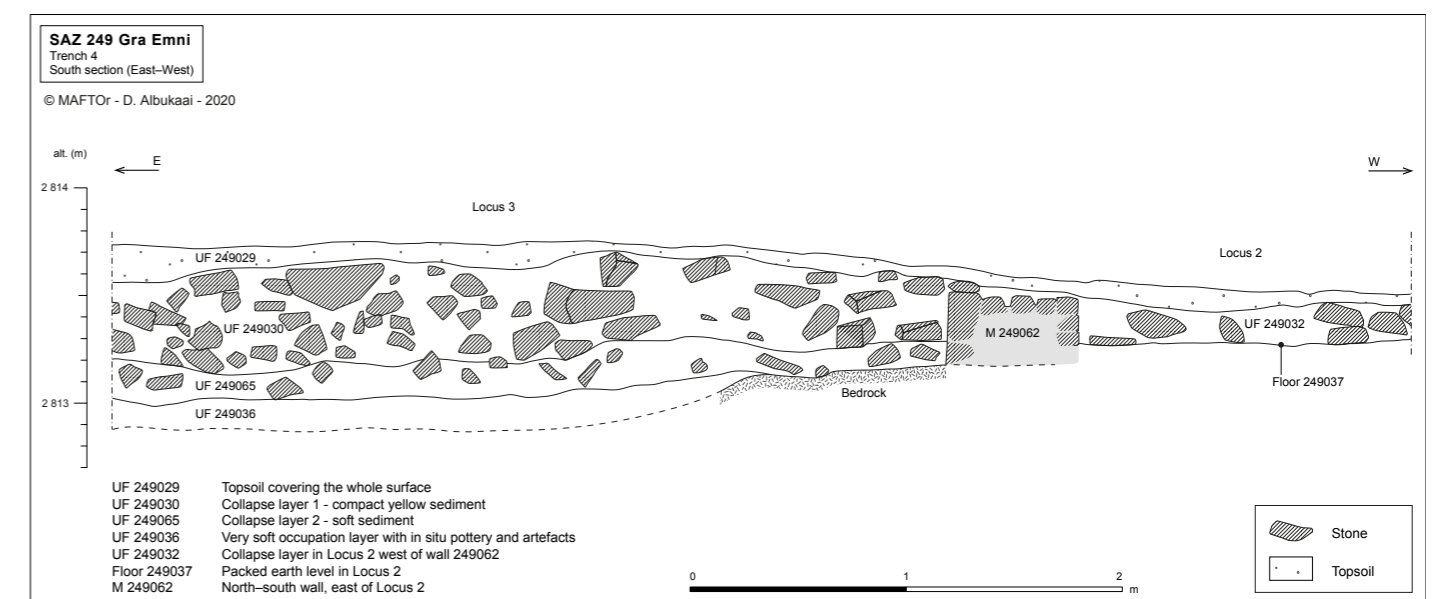
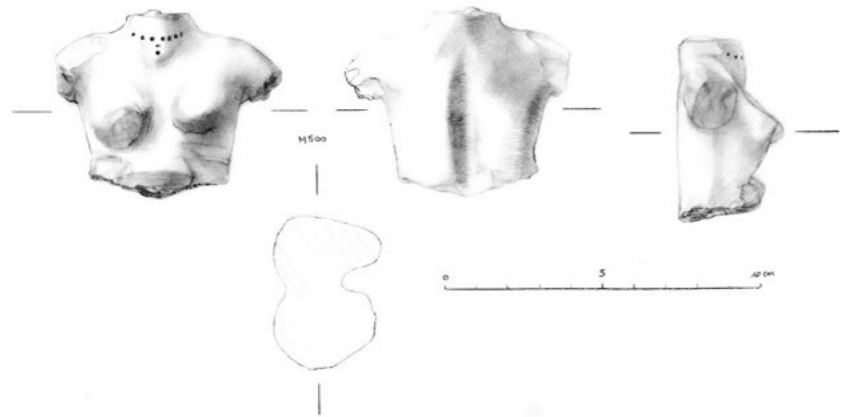

Figure 26: Gra Emni (Saz 249) - Trench 4 - East-west section, south of the trench (D. Albuakaai - MAFTOr).



SAZ249 - Gra Emni
UF 249030
M500 - Statuette



Wakarida
Us 3069
M227 - Statuette

27a | 27b
27c |

Figure 27a: Gra Emni (Saz 249) - Trench 4. Location of the clay statuette M.500 in the collapse layer (UF 249 030) (D. Albukaai - MAFTOr).

Figure 27b: Close-up view of the clay statuette M.500 in the collapse layer (UF 249 030) (D. Albukaai - MAFTOr).

Figure 27c: Clay statuette M.500 compared to a clay statuette from Wakarida (M227) (Drawing J. Bouvot, photograph: J. Schiettecatte/S. Antonini - MAFTOr).



Figure 28: Gra Emni (Saz 249) - Trench 4. Oven 249 038 in locus 1 (D. Albukaai - MAFTOr).



Figure 29: Gra Emni (Saz 249) - Trench 4. Doorstep 249 063, in wall 249 061, between loci 1 (up) and 2 (bottom). A stone structure (249 039) was built later in front of the access (D. Albukaai - MAFTOr).



Figure 30: Gra Emni (Saz 249) - Trench 4. Locus 3 - Artefacts and pottery from the lower level of occupation (UF 249 036) (D. Albukaai - MAFTOr).



▲ **Figure 31:** Gra Emni (Saz 249) - Trench 4. East face of wall 249 060 (D. Albucaai - MAFTOr).



◀ **Figure 32:** Gra Emni (Saz 249) - Trench 4. South end of wall 249 060 (right) abutting against the north end of wall 249 062 (left) (D. Albucaai - MAFTOr).



Figure 33: Gra Emni (Saz 249) - Trench 4. East face of wall 249 062 (D. Albucaai - MAFTOr).

missing as well as both arms. The chest is naked. Breast are well marked as well as some slight curves around the stomach. Seven aligned pointed impressions draw a horizontal line on the front side of the neck. Below this line two perforations are superimposed vertically. These perforations could represent a neckless or a tattoo. Two horizontal lines also appear on the stomach below the breast. The spinal column is marked by a vertical depression on the back side of the figurine.

This figurine is reminiscent of several similar figurines discovered on other sites. One of them was collected at Wakarida, 10 km NE of Gra Emni, in a middle-late Aksumite context. Another comparable figurine was found on the site of Matara, c. 50 km to the NW, in a pre-Aksumite context (Anfray & Annequin 1965).

Stone artefacts

A total of 90 stone tools has been collected in Trench 4, especially in the collapse layers and in the open-air area (Locus 3). Among them, 46 come from the collapse layers. This kind of object may have been reemployed in the masonry-work.

Obsidian industry: Obsidian artefacts have been collected in the collapse layers and in the lower layer of occupation of Locus 3 (UF 249 036). These obsidian fragments are mainly small size non retouched flakes. Only two tools from a blade debitage are obviously retouched on the edges.

Grindstones and grinders: 11 grindstones and 4 small grinders have been collected in the trench (fig. 34: M 498, M 506, M 546). They are generally in limestone or in sandstone. Most of them are broken: on a total of 15 objects, a single one was complete (M 582). It was found in the lower occupation level of Locus 3, together with other artefacts.

Multifunction stone tools: Hammers and crushers: Stone tools showing traces of crushing and/or hammering are also frequent in all the layers. Most of them are in limestone or sandstone, with a few examples in quartz. Most of these objects appear as natural stones chosen for their size and rounded shape (diameter mostly c. 10 cm) that make them easy to handle with one hand, and many show multiple traces of use associating abrasion marks and traces of hammering, suggesting their multiple functions (fig. 34: M 497, M 521, M 526, M 548).

Polishers: Oval or rounded small pebbles in hard calcareous stone show traces of abrasion on a face or on their sides. These small stones, 2 to 4 cm large, could have been used to smooth leather or pottery.

Lids: Three lids made in a slab of schist have been found in Locus 3. They have a disc shape, a diameter of 8 to 12 cm, and a thickness of 2 to 2.5 cm. Two come from the lower occupation level of Locus 3, the last one from the upper layer of occupation (fig. 34: M 537).

Conclusion and perspectives

The building discovered in Trench 4 includes several characteristics reminiscent of the Aksumite architecture. These are: 1/ the presence of projecting rooms in the corners, like in large residences of Wakarida, Matara, and Aksum; 2/ the building techniques, with corners showing tied walls and large blocks set with a particular care; 3/ courses of slabs of schists inside the masonry. The pottery material seems to indicate a date of **occupation from the 7th–9th centuries CE, at the very end of the Aksumite period.**

The quality of the masonry and the pottery assemblage suggest a prestigious building. The presence of an oven inside the building indicates that it included a domestic space. The extension of the excavation is required to specify its very function.

Type of stone tool	Nb of artefacts
Obsidian	25
Grindstone/grinder	15
Hammer	2
Crusher	7
Multifunction handstone	22
Polisher	16
Lid in schist	3

Table 1: Distribution of stone tools from Trench 4 (D. Albucaai - MAFTOr).



Figure 34: Gra Emni (Saz 249) - Trench 4. Stone tools (J. Schiettecatte/M.B. Dhorne - MAFTOr).

Trench 5

[by G. Tavernier & M.B. Dhorne]

Trench 5 was carried out in the northern part of the Gra Emni site (SAZ 249), on the edge of a cultivated terrace. It was located 150 m north of Trench 4 (fig. 1), next to Burhan's farm. The farm house was located immediately next to the terrace. Only a 1-m-wide alley was dug between the western wall of the house and the terrace. The section of the terrace was thus visible previously to the excavation. It revealed the presence of at least two walls oriented east-west, associated with two levels of demolition. The landowner showed us archaeological artefacts collected on the surface and in diggings, among which ceramics and grinding stones. The latter have been rehabilitated by the occupants, who use them for their domestic activities.

The extent of the trench was limited by the width of the terrace, the need to preserve a circulation and strengthen the slope to prevent a collapse of the land against the house. Thus, only a 6 × 3 m rectangle with a north-south orientation was excavated (fig. 36).

Plan and stratigraphy (figs. 36-40)

The first archaeological levels appeared under more than 60 cm of sediment (UF 249 041 and 249 042). Four areas could be distinguished inside the excavation (loci 1, 2, 3 and 4), two of which were partly excavated (loci 1 and 2). Loci 3 and 4, respectively located in the south-west and south-east corners, were not fully excavated as the portion of their surface was very small, making deep excavation difficult. Only Locus 2, in the southern part of the excavation, was excavated down to the bedrock.

Locus 1

Locus 1 in the northern part of the excavated area included an important level of collapse, characterised by a compact brown silt loaded with large blocks (UF 249 043). Among the material from this layer, several fragments of obsidian (M 515, M 574 - fig. 48), two grindstone fragments (M 578, M 586), a crusher (M 587) and a hammerstone (M 579) have been recorded. The bottom of this level was not reached during the excavation, despite the removing of 40 cm of collapsed stones.

Locus 2 - three successive phases (figs. 41a-c)

Locus 2 was bordered by three walls delimiting a 1.85-m-wide room. The length of the room exceeds 2.63 m since it continued beyond the excavation limit (fig. 42). Three successive occupation were identified, each associated with a floor and architectural changes. Only the last phase could be related to domestic activities, suggesting that the two oldest ones were related to the construction process.

Stage 1: building of wall 249 044 and circulation level 249 059 (fig. 41a):

The first circulation level (UF 249 059) was directly lying on the bedrock, and was associated with a south-east - north-west wall (249 044). The wall is preserved on four irregular 20-cm-high courses (fig. 43). This wall consists of two faces of large irregularly shaped blocks with an average diameter of 35 cm, and an inner filling of medium-sized blocks, ranging from 10 to 15 cm in diameter. The south face was slightly battered. The wall continued beyond the eastern and western limits of the excavation. Since we could only access the



Figure 35: Gra Emni (Saz 249) - Alley between Burhan's farm house and a cultivated terrace. The section shows archaeological remains (J. Schiettecatte - MAFTOr).

northern limit, the overall surface of the room could not be estimated.

Stage 2: building of wall 249 046 and setting-up of floor 249 053 (fig. 41b)

A second north-east – south-west wall (249 046) was abutting against the previous masonry (wall 249 044), and not tied to it. It was built directly above the previous circulation level (UF 249 059) (fig. 44). Wall 249 046 has two faces. It is 52 to 62 cm wide. The wall continues beyond the southern limit of the excavated area.

An 80-cm-large door was opened in wall 249 046. It was linking Locus 1 and Locus 4. The door had a stone threshold, 40 cm above the base of the wall. The top of the threshold was made of a layer of stones set perpendicularly to the axis of the door. Over this layer, on the outer side (locus 4), in front of the threshold, a 56-cm-long, 20-cm-wide and 6-cm-deep rectangular space was filled with loose sediment, possibly the imprint of a wooden plank (fig. 45). A large stone was partly covering this rectangular imprint.

The lowest part of wall 249 046 was made of three courses of stones approximately 20 to 30 cm long and 10 cm thick. Above these courses, on both sides of the door, the masonry of the wall changed: courses of stones were c. 6 cm thick. It cannot be stated whether this change in the size of stones between the three courses at the bottom and the upper courses existed from the beginning or was linked to a resumption of the masonry. In the latter case, it would have happened during stage 3, as a possible rebuilding of the upper part of the wall.

A second circulation level (UF 249 053) was associated with the lower part of wall 249 046 and was bordered by the two masonries (walls 249 044 and M 249 046). The only artefact associated with this level was a handstone (M 570 - fig. 48).

Step 3: building of wall 249 047 and occupation floor 249 049 (fig. 41c)

A third wall (W 249 047), oriented south-east – north-west, was built directly against wall 249 046, abutting it but not tied to it. With the two prior walls, it formed a rectangular space, locus 2, and constituted the south-west limit of the room. It continued further west, beyond the excavation limit. The wall rested on top of the second circulation level (UF 249 053). The first foundation appeared some 20 cm higher than the previous masonry (W 249 044 and W 249 046) (fig. 46). The building technique of wall 249 047 was similar to that of wall 249 046. Its width varied from 50 to 58 cm. The masonry comprised two faces of blocks c. 20-30 cm in length. The four irregular courses were c. 10 cm thick. The wall was slightly curved, which led to a widening of the room to the west.

A level of occupation is associated with the base of the wall (floor 249 049). Two structures were found *in situ* associated with this floor (figs. 41c, 47). The first was a complete jar (st. 249 054), wedged with small stones and filled with homogenous silty ashes. This included a few centimetres of raw reddened earth which may be linked to the abandonment of the site. 10 cm northeast of the jar, a hearth (st. 249 055) was set in the neck of a jar set upside down. The ceramic was very crumbly and surrounded by a ring of reddened earth, 2 to 4 cm thick.

This layer yielded numerous fragments of obsidian (M 514 - fig. 48), two fragments of grindstones (M 516, M 517 - fig. 48), a crusher (M 520). A fragmentary grindstone (M 588) was used as a masonry element in wall 249 047. Three beads (M 513), likely made with glass paste, were collected at the northeast corner of the room. These beads are biconical in shape with a central flattening perpendicular to the axis of the perforation. The two largest are 0.6 cm long and 0.7 cm wide. One is black and the second is dark red. The third bead is only 0.4 cm long, 0.5 cm wide and is dark blue (fig. 49).

Conclusion and perspectives

Trench 5 revealed the presence of a space progressively organized by the addition of successive walls abutting one against the other. The two first stages of occupation probably corresponded to two successive events in the process of the construction of the building. They yielded a very small quantity of material including fragmented potsherds and rare stone tools. The third stage corresponds to the main occupation of the building. Its floor 249 049 is the only one having delivered structures *in situ*. Their natures – heating and possibly storage – was indicative of domestic activities. It was also the only one that yielded pottery

including identifiable shapes. This last level of occupation was followed by an important collapse layer, that sealed the room. The morphology of the masonry and the preliminary study of the ceramic indicated a likely **pre-Aksumite occupation**. Charcoals have been sampled in every level of occupation and will be analysed for ¹⁴C dating.

Several issues invite us to resume the excavation of this structure during next season: the collapse layer of locus 1 (UF 249 043) has to be entirely removed and the limits of locus 2 and 3 have to be set. An extension of the trench, to the south and west, would allow us to characterise more precisely the nature of this occupation and its phasing. Finally, we could not find the two masonries observed on the section of the terrace during the excavation. They do not correspond to any of the walls exposed during the excavation and deserve to be inserted within the picture.

Reference

ANFRAY F. & ANNEQUIN G. 1965. Matarā - Deuxième, troisième et quatrième campagnes de fouilles. *Annales d'Éthiopie* 6: 49–86.



SAZ 249 GRA EMNI
Trench 5
Orthophotograph

© MAFTOr - 2020
J. Schiettecatte
Coordinate System
WGS 84 UTM zone 37N
Projection: Transverse Mercator
Datum: WGS 1984

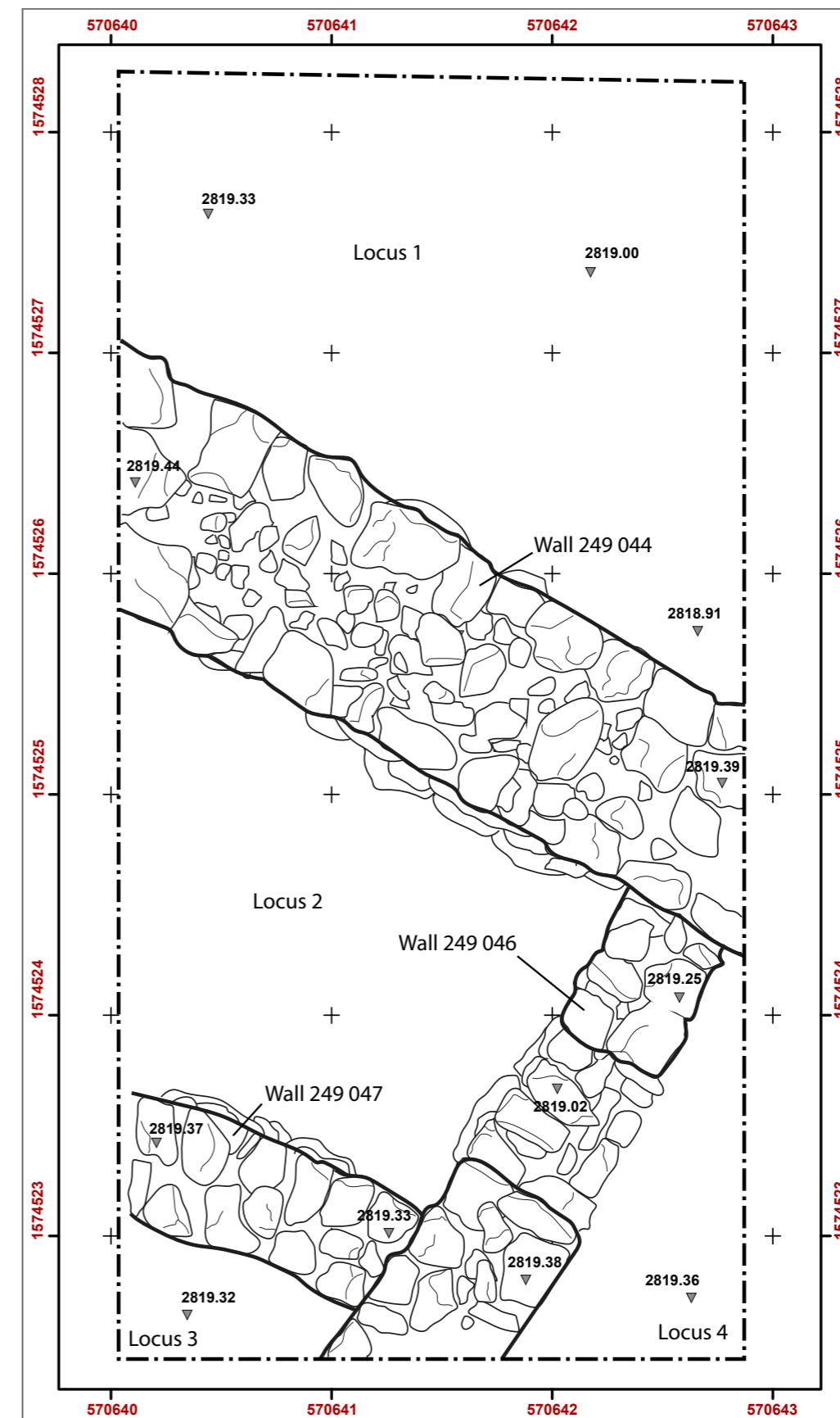

SAZ 249 GRA EMNI
Trench 5
Plan

- Substratum
- Ashes / Charcoal
- Stone
- Pit / Hearth
- Excavation limit
- Altitude (a.s.l.)

© MAFTO - 2020
J. Schiettecatte - G. Tavernier
Coordinate System
WGS 84 UTM zone 37N
Projection: Transverse Mercator
Datum: WGS 1984



Figure 36: Gra Emni (Saz 249) - Trench 5 - Orthophotograph (J. Schiettecatte - MAFTOr).

Figure 37: Gra Emni (Saz 249) - Trench 5 - Plan (J. Schiettecatte/G. Tavernier - MAFTOr).

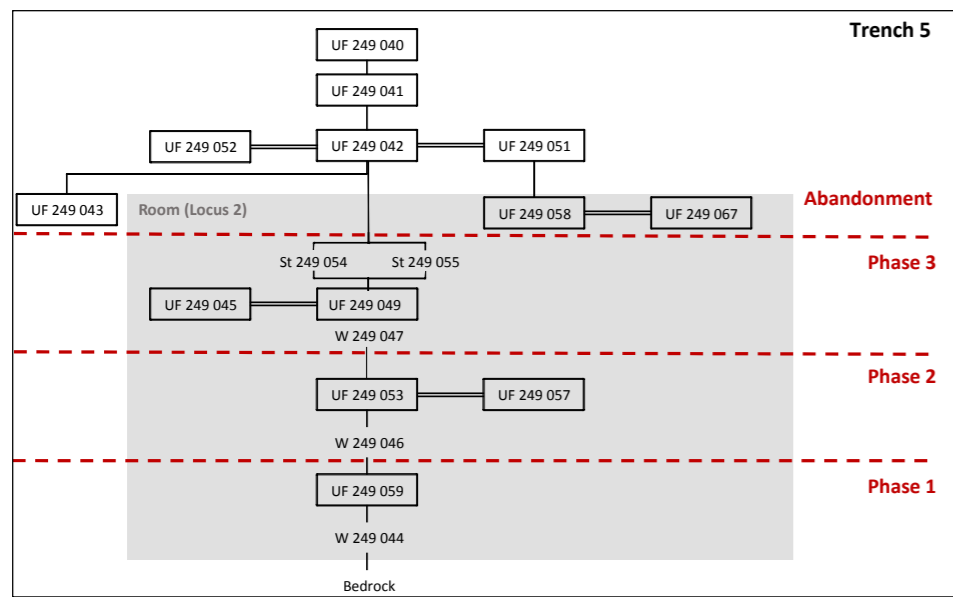

Figure 38: Gra Emni (Saz 249) - Trench 5 - Stratigraphic sequence (G. Tavernier - MAFTOr).

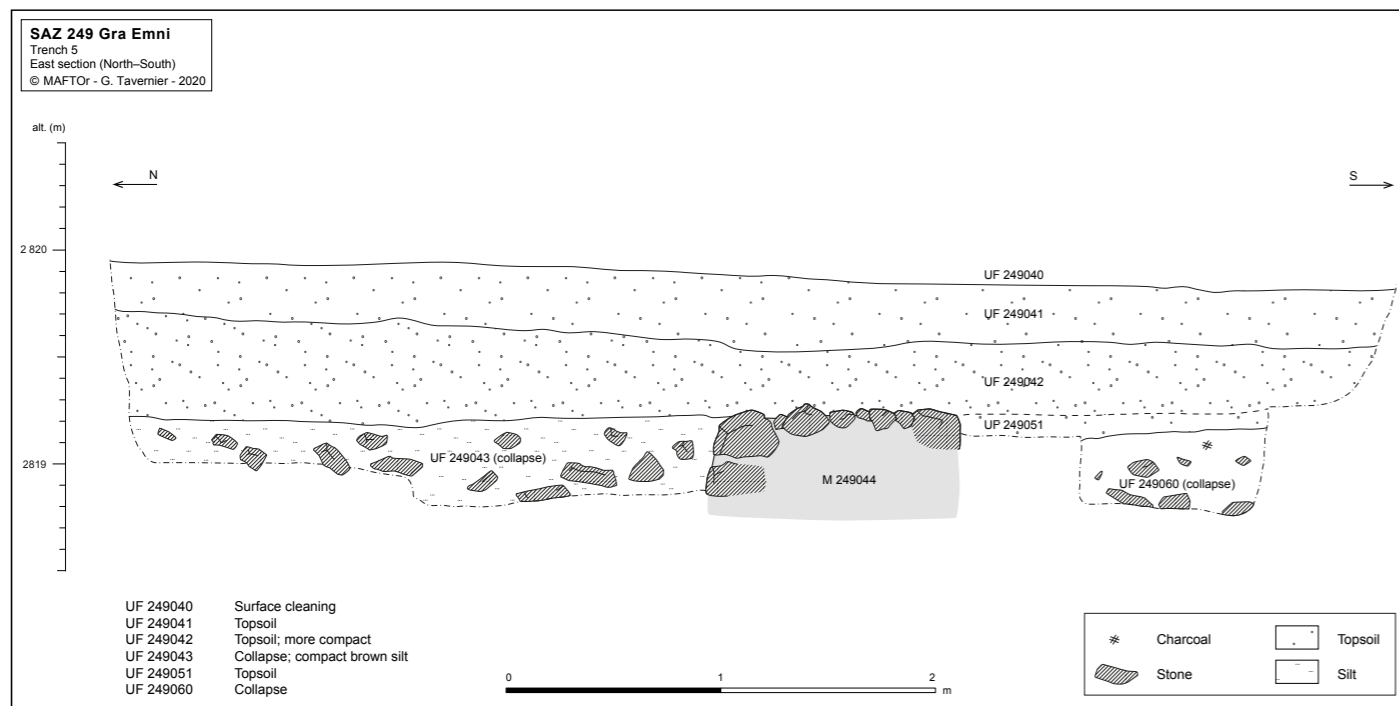

Figure 39: Gra Emni (Saz 249) - Trench 5 - North-south section, east of the trench (G. Tavernier - MAFTOr).

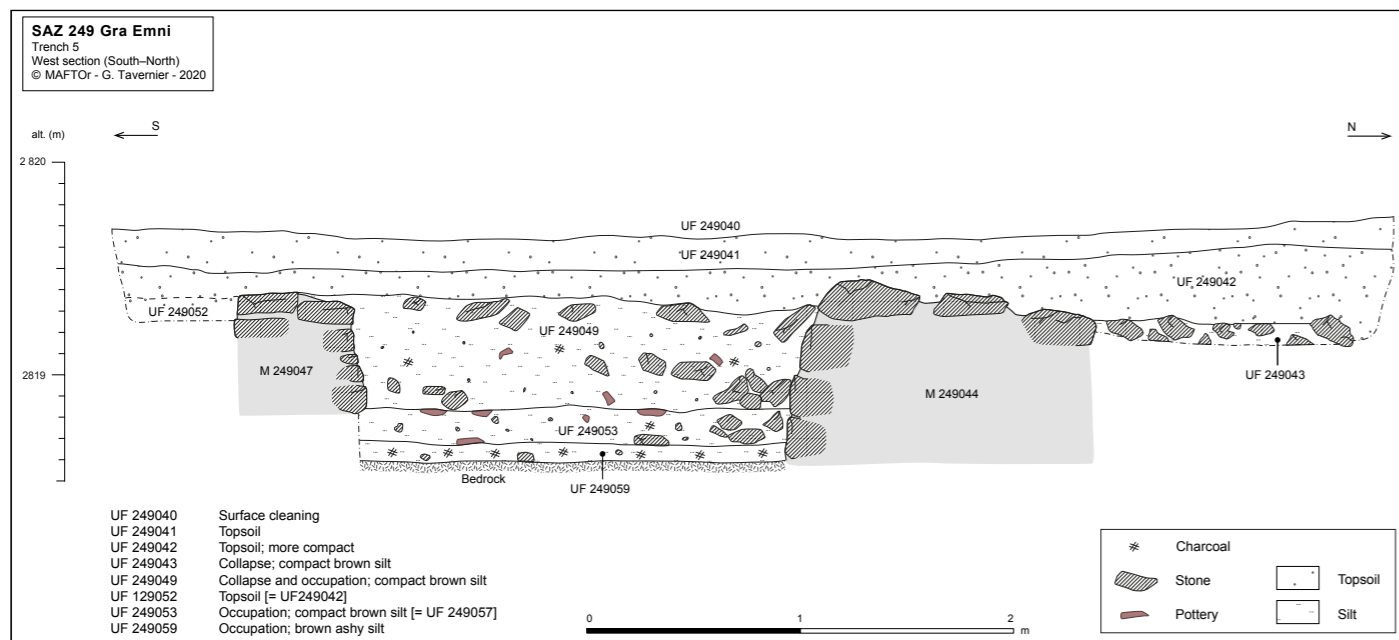
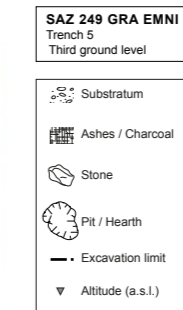
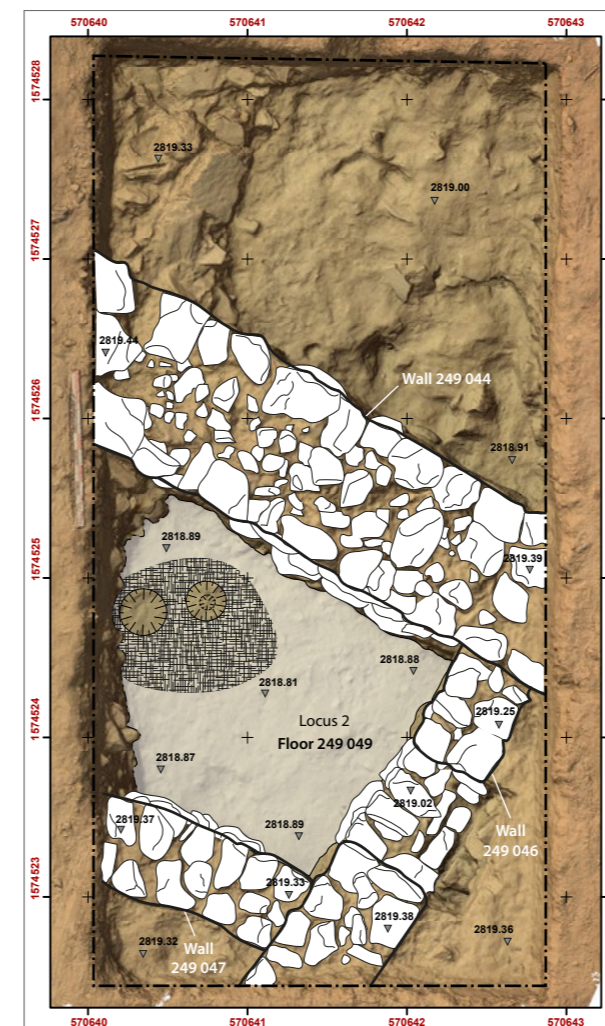
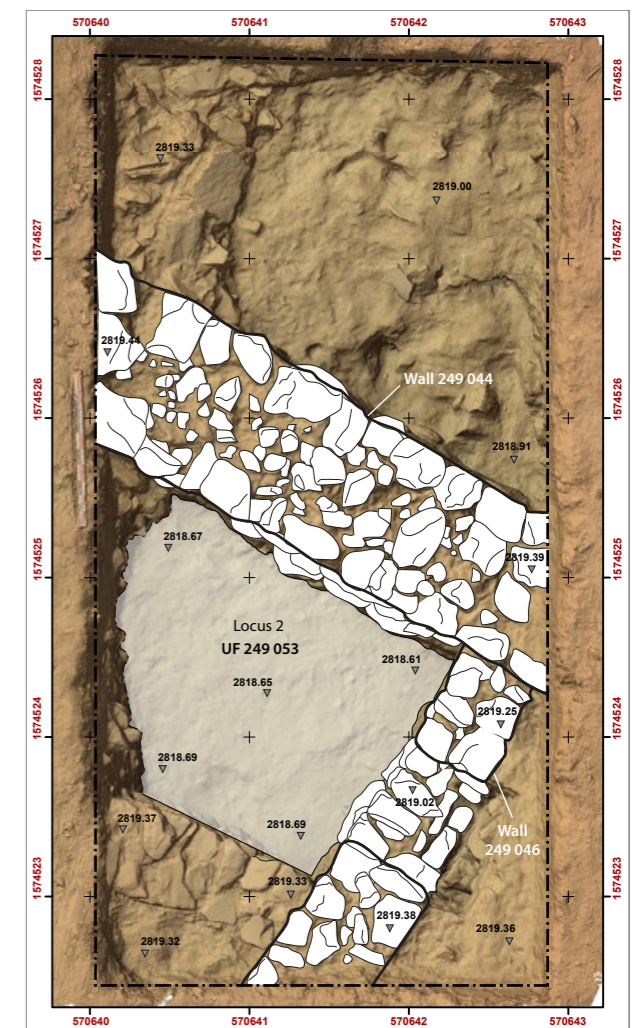
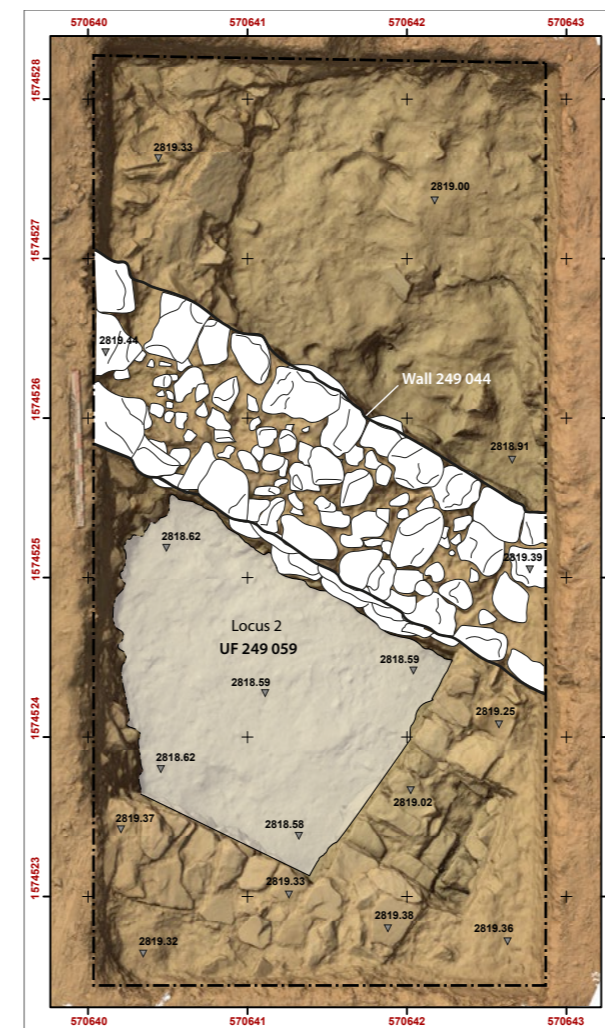

Figure 40: Gra Emni (Saz 249) - Trench 5 - South-north section, west of the trench (G. Tavernier - MAFTOr).



© MAFTOr - 2020
J. Schiettecatte & G. Tavernier
Coordinate System
WGS 84 UTM zone 37N
Projection: Transverse Mercator
Datum: WGS 1984

0 1 m

41a | 41b
41c

Figure 41a: Gra Emni (Saz 249) - Trench 5. Plan of stage 1 (G. Tavernier/J. Schiettecatte - MAFTOr).

Figure 41b: Gra Emni (Saz 249) - Trench 5. Plan of stage 2 (G. Tavernier/J. Schiettecatte - MAFTOr).

Figure 41c: Gra Emni (Saz 249) - Trench 5. Plan of stage 3 (G. Tavernier/J. Schiettecatte - MAFTOr).



Figure 42: Gra Emni (Saz 249) - Trench 5 - Locus 2. Looking east (G. Tavernier - MAFTOr).



Figure 44: Gra Emni (Saz 249) - Trench 5 - Wall 249 046 with a door opening in it, between Loci 2 and 4. Looking east (G. Tavernier - MAFTOr).



Figure 43: Gra Emni (Saz 249) - Trench 5 - Wall 249 044. Looking north (G. Tavernier - MAFTOr).



Figure 45: Gra Emni (Saz 249) - Trench 5 - Top of wall 249 046 and the door in it, between Locus 2 (bottom) and Locus 4 (top). The east of the door, the possible imprint of a wooden plank is partly covered by a large stone, either a collapse or a step (G. Tavernier - MAFTOr).



Figure 46: Gra Emni (Saz 249) - Trench 5 - Wall 249 047. Looking south (G. Tavernier - MAFTOr).



Figure 47: Gra Emni (Saz 249) - Trench 5 - Two structures found in situ on floor 249 049: a complete jarwedged with stones (st. 249 054) and a hearth in the neck of a jar (st. 249 055) (G. Tavernier - MAFTOr).

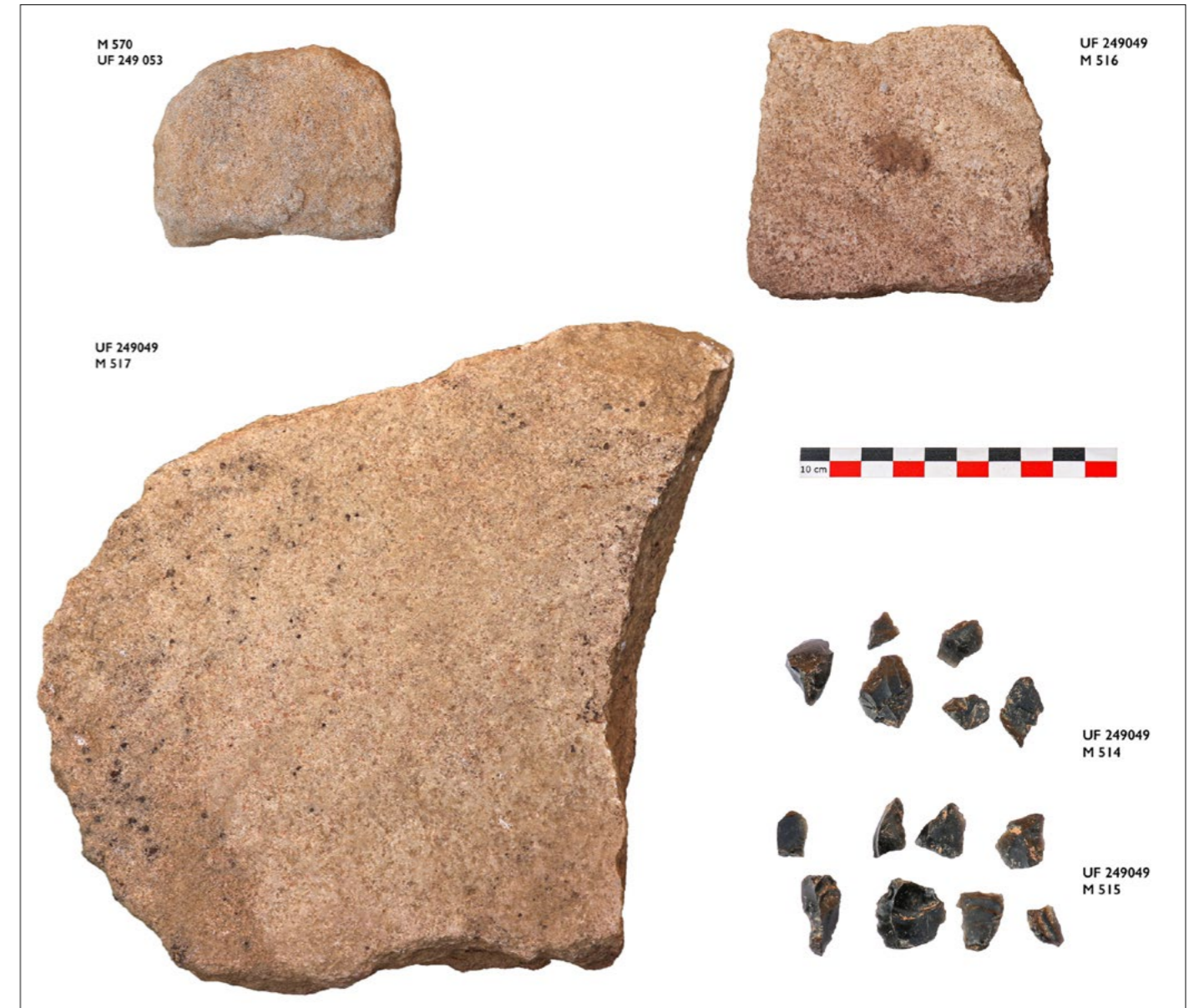

Figure 48: Gra Emni (Saz 249) - Trench 5 - Stone tools and obsidian flakes (J. Schiettecatte/M.B. Dhorne - MAFTOr).



Figure 49: Gra Emni (Saz 249) - Trench 5 - Three beads from the 3rd stage of occupation (J. Schiettecatte/M.B. Dhorne - MAFTOr).

GRA EMNI (SAZ 249) - THE POTTERY FROM TRENCHES 1, 2, 4 AND 5

Anne BENOIST (CNRS, UMR 5133 Archéorient)

Introduction

Excavations and survey in Wolwalo area have yielded an important quantity of pottery part of which only has been studied because of the unexpected interruption of fieldwork. The totality of the material has nevertheless been packed and stored in the TCTB office at Freweyni. It shall be studied and registered next season. Thus, the present report is to be considered as preliminary.

Four trenches carried out at Gra Emni have yielded an important pottery material allowing a first dating and a few remarks on the nature or the function of the unearthed remains. Three trenches (1, 2, and 4) have yielded a pottery material comparable to the one already documented at Sebdera, where a ¹⁴C dating dated the occupation between the 7th and the 9th centuries CE. In the present state of research, this period could be named early post-Aksumite: it is contemporaneous with the fall of the kingdom of Aksum, but the different steps of this evolution are not precisely dated yet. At Wakarida this period corresponds to a hiatus between the end of period I (occupation of the town between the 4th and the 7th century CE) and period II (camp in perishable material settled over the ruins of the city between the 10th and the 12th century CE).

The last trench (Trench 5) has provided a pottery assemblage that can be dated to the pre-Aksumite period, between the 8th and the 1st century BCE. It finds comparisons among the material from the classical pre-Aksumite period (8th-5th centuries BCE) documented at Alakile Daga (SAZ 42), but also among assemblages from the late pre-Aksumite period (4th-1st centuries BCE) collected at Armengela (SAZ 32) and Mangagebit (SAZ 44) (Benoist *et al.* 2020).

The pre-Aksumite pottery from Trench 5

This material has been collected during the last days of the present season. It is not very abundant: only nine diagnostic fragments have been recorded. But the pottery has been found in situ and several pots are complete. Unfortunately, they are heavily weathered which makes their restoration difficult.

Pottery recorded in Trench 5 includes only one technical group (provisionally labelled Group 11B). It has an orange to red-orange fabric, often grey or brown at core, with a light and friable texture, a fine mineral temper including occasional white inclusions and fine grey-green shiny grits. Pots are hand shaped, probably using coil-making, but the use of large bands or plaques can also be considered. Pottery walls are often irregular in thickness. Surfaces are rough and mate, without slip, with traces of smoothing by hand or with a flat tool (spatula in wood or flat bone). Some of the potteries show incised decorations (**fig. 1**). A unique case of an appliqué decor in relief appears on a jar, together with incised lines (**fig. 2**).

The pottery collected in Trench 5 are very comparable to those collected around Wakarida on the sites of Alakile Daga, Armengela and Mangagebit and more especially to the pottery belonging to Group 11, defined as a group with a temper of inclusions of a grey-greenish soft stone (possibly talc). The similarity of the fabric has still to be verified. Pottery collected in Trench 5 seems softer and more friable, which could also be the result of taphonomic processes. Potsherds have rounded edges, and the clay easily breaks into powder, whereas potteries from the main area around Wakarida appear more compact, and maybe more charged in shiny grits. The pottery from Trench 5 could be a local production on the plateau using the same principles as those used by the potters from the Wakarida region, but with a slightly different recipe. Because of the sudden end of the fieldwork this season, we did no sampling of Groupe 11B. This will be done next season for comparative analyses with pre-Aksumite potteries from the Wakarida region.

Only nine shapes have been recorded (nb. 4655 to nb. 4663). They include eight fragments of jars with a

globular or oval body and a concave neck, the link between body and neck being continuous and barely marked (fig. 1). All jar necks but one present a rounded or pitched rim, the last one shows a banded rim. Similar banded rims are attested on the pre-Aksumite site of Meqaber Ga'ewa, in the region of Wukro (Büchner, personal comm).

Three jars are decorated with one or two wavy lines placed at the base of the neck, incised with a spatula or a pointed tool. (WK4658, WK4659, WK4660 - figs. 1, 3). Such wavy lines are often mentioned in pre-Aksumite assemblages. They are sometimes described as incisions made with a comb (D'Andrea *et al.*, 2008), which is not the case here. However, in the region of Wakarida, pre-Aksumite pottery also includes incisions made with a spatula with a more or less regular edge drawing a variety of wavy lines, some including parallel lines, and others a single line.

A fourth jar rim (WK4655) shows an unusual decor with an appliqué in relief surrounded by large incisions (figs. 2-3). The appliqué covers the neck and the upper part of the body and includes two small circles one above the other, and two vertical bands below. Incisions underline the appliqué in the lower part of the pattern. In the central part, on both sides, incised decoration draws two curved lines diverging from the outline of the appliqué. The decoration is reminiscent of a schematic human silhouette with the arms raised on both sides of the body. This pattern has no identified parallel, although an appliqué decor in relief was found on a small carinated jar from the Late Pre-Aksumite site of Armengela (WK2726 - see Benoist *et al.* 2020: fig. 8: 8). In this case nevertheless, the appliqué draws a different pattern.

Pottery collected in Trench 5 also includes a fragment of a large bowl with a rounded rim and with a crescent moon-shaped lug in the upper part (WK4662 - fig. 3). This kind of lug appears among the late pre-Aksumite assemblage of Mangagebit (Benoist *et al.* 2020: fig. 7: 10) and are reported on the classical pre-Aksumite sites of Ziban Adi (Matthews & Büchner in press: fig. 8: f) and the D site at Kidane Merhet (Phillips 2000: fig. 269: b). In comparison with these, the lug from Trench 5 is upside down (convex part turned toward the bottom).

The recording of the pottery from Trench 5 is still incomplete. But it seems that the fine ware with a red burnished or polished slip becoming black in the upper part and on the inside is absent here. This pottery group recorded at Armengela, Mangagebit and Alakile Daga in Wakarida region (Group 13) is also mentioned as one of the main markers of the pre-Aksumite period on several other sites, such as Yeha (Anfray 1963: pl. CXXX: E2240, E2157. Poteries rouges à intérieur noir), Seglamen (Makonnen *et al.* 2009: "BTRPFW": Black topped red polished fine ware), or the D site at Kidane Mehret (Phillips 2000: 303: "BTRW": Black topped red ware). Also absent from this assemblage are the few grey to brown wares decorated with incisions recorded at Armengela and Mangagebit in the Wakarida region (Group 14). We do not know yet whether the absence of these two groups is significant in terms of chronology or not. Samples of charcoal have been collected on the floors of the building for ¹⁴C dating. The results shall better insert this limited assemblage in the local chronology.

The late Aksumite pottery from Trenches 1, 2 and 4

The pottery collected in Trenches 1, 2 and 4 forms a homogenous assemblage which suggests a single chrono-cultural phase although slight differences appear in the material from a Trench to another. This pottery set is also similar to the one collected at Sebdera (SAZ 248) in 2018, another site from the Wolwalo area, located 400 m south-east of Gra Emni. The occupation layer excavated at Sebdera was ¹⁴C dated to the 7th-9th centuries CE. This period corresponds to the decline of the kingdom of Aksum. There is a lack of historical data precising whether the Aksumite policy was still exerting a strong control of Eastern Tigray during this period, or if it was no more significant or inexistent in this region. It may have been challenged by another political formation. This period of the 7th-9th centuries CE also corresponds to the hiatus in the occupation of the site of Wakarida, between the end of the occupation of the city (period I) and the resuming of an occupation of its ruins by a nomadic camp (period II). Stylistically the pottery of Gra Emni is in continuity with the pottery of the period I at Wakarida. But it differs from the latter in several aspects.



▲ Figure 1: Gra Emni (Saz 249), Trench 5. Fragments of jar necks with incised decorations WK4658 (left) and WK4659 (right) (J. Schiettecatte/M.B.Dhorne - MAFTOr).



◀ Figure 2: Gra Emni (Saz 249), Trench 5. Fragment of jar WK4655 decorated with an appliqué in relief and incisions (J. Schiettecatte/M.B.Dhorne - MAFTOr).

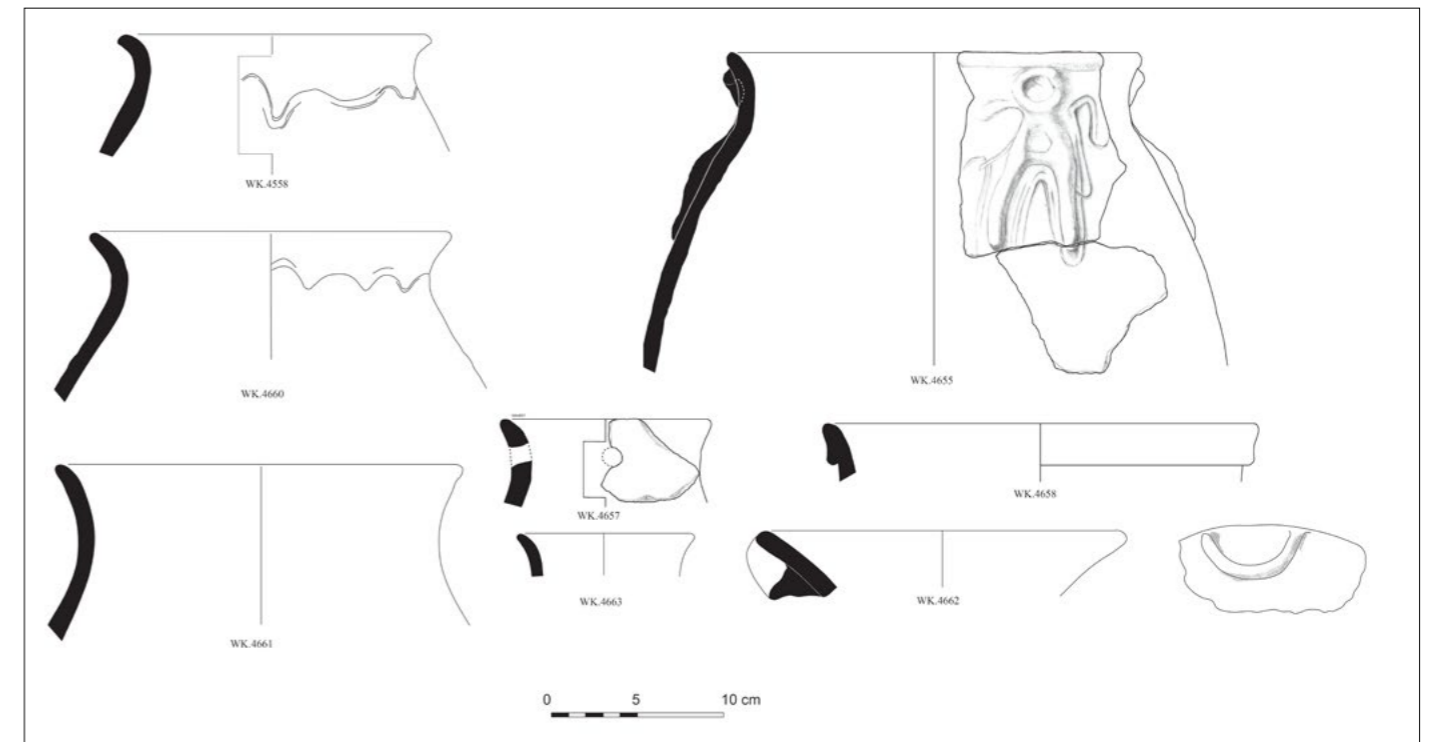

▼ Figure 3: Gra Emni (Saz 249), Trench 5. Pottery assemblage: jars and basin with crescent-shaped lug (J. Bouvot - MAFTOr).

Pottery groups defined in Trenches 1, 2 and 4

Group 21: Common orange ware

122

This group represents the vast majority of the collected sherds (82.7 %). The fabric is light to bright orange with sometimes a thin light grey or grey band at core. The texture is compact and well fired, sherds have sharp and regular edges. There are few or no porosities: potsherds seem “heavy”. The fabric includes a mineral temper abundant but relatively well sorted with fine to medium inclusions. The latter include numerous fine grey greenish or grey whitish shiny grits less than 1 mm thick, probably issued from a soft stone, small red to dark brown inclusions of medium size, or more rarely fine to medium black rounded grits. The thickness of the potsherds varies from 0.6 to more than 1.5 cm; they are generally c. 1 cm thick.

Pots seem to have been shaped by hand, probably by coiling. On some potsherds, especially fragments of ledge rims or bases of necks, the link between two coils or two plaques is visible and the adding of some clay on one or both sides of the central coil for thickening the wall, shaping the rim or the upper part of the neck is then visible in the potsherd breaks: the initial coil is surrounded by one or two thinner plaques applied around.

Surface treatment allows to distinguish several variants:

- A group of pottery with a polished surface of light colour, varying from a pearly white or pinkish colour, to a light brown-caramel colour. The surface is uniformly polished, lustrous, without any visible strips. The presence of a slip is not certain in all the potsherds: most of the time the surface colour could result from the application of a wet clay of the same nature that the paste (wash), and the accentuation of the colour of the surface might then result from the combination of polishing and firing.
- A group of pottery with a red polished or burnished slip, light red to bright red. The surface is uniformly polished or can present slight strips suggesting the use of a flat tool. It has a shiny aspect.
- A last group of pottery without slip with a surface simply smoothed or too eroded to distinguish clearly traces of polishing or burnishing or the application or not of a slip or a wash.

Shapes most commonly encountered among Group 21 are:

- Short-neck jars with a globular or oval body and a slight flaring neck in a large oblique ledge rim terminated by a rounded or a flattened or slightly thickened and flattened vertical or oblique lip (**fig. 4**).
- Large bowls and basins with a straight or slightly convex wall and slightly thickened and flattened oblique rim (**fig. 5**).
- Large carinated plates with a flaring upper part forming a large ledge rim terminated by a slightly thickened and flattened lip (**fig. 6**).
- Globular bowls with a rounded or flattened rim turned towards the inside (**fig. 7**).
- Globular pots with a short flaring neck and a rounded or flattened rim (**fig. 8**).

Incised decorations and impressions are present on some jars and large opened vessels in this common ware (Group 21). They are often placed on the lip of the rim, outside, but can also be present on the inner face of ledge rims. These decorations mostly include incised chevrons and small round impressions made with a tubular or pointed tool. Similar decorations can be found at Aksum on the top of some ledge rim basins, dated from the late Aksumite period (Wilding 1989: fig. 16: 208, 211). A few appliqués in relief appear on the inside of some ledge rims, together with incisions or impressions. Such decorations were also present on the site of Wakarida and seem to be a legacy from the previous period. Although less elaborated than during the previous periods, these appliqués are also present on some ledge rims of Aksum during the late Aksumite period (Wilding 1989: fig. 16: 358, 359).

Some vessels in this common ware, especially those with a light buff-whitish or light brown polished surface, show painted decorations in black, dark red or dark brown (**figs. 9-10**). These painted decorations are

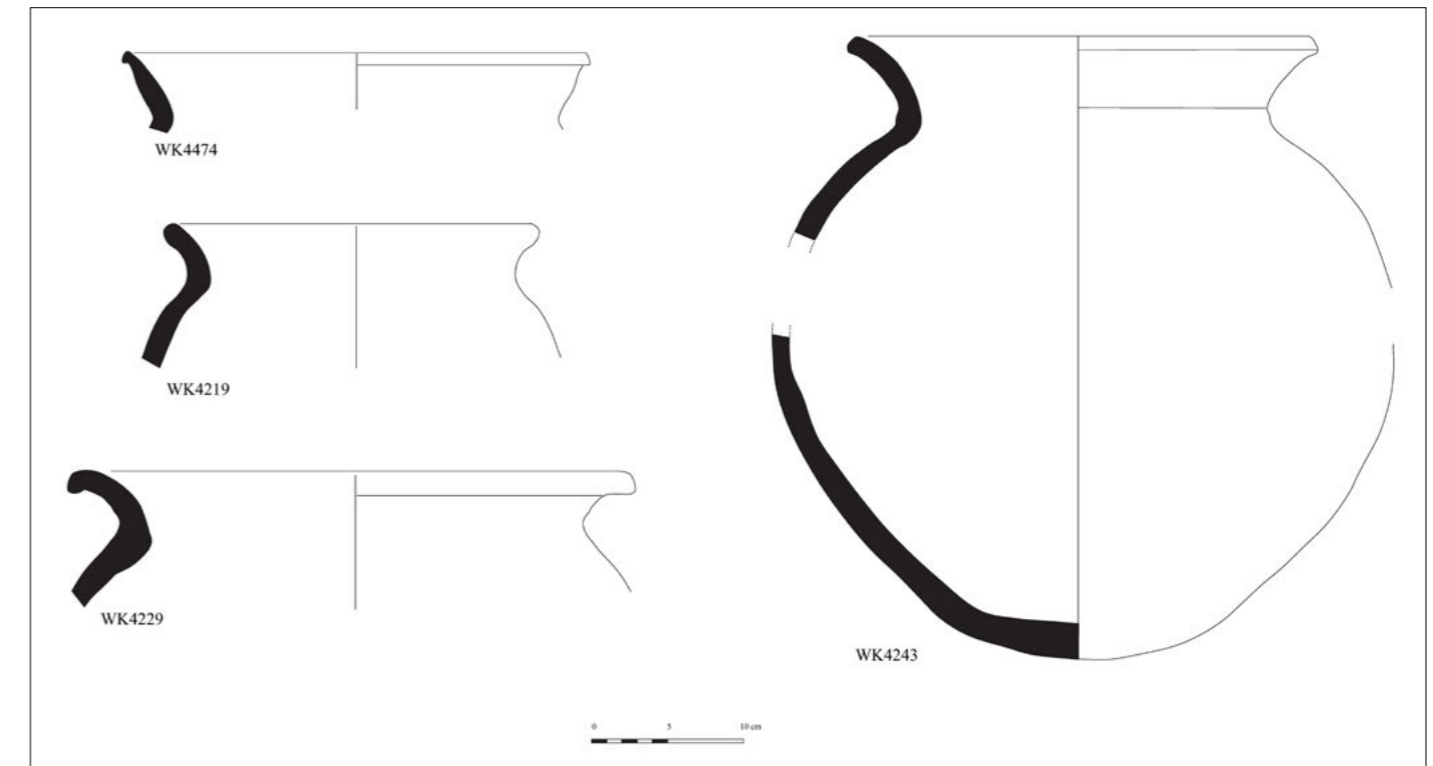

Figure 4: Gra Emni (Saz 249). Group 21: jars from Trenches 2 and 4 (J. Bouvot/M. Gorea - MAFTOr).

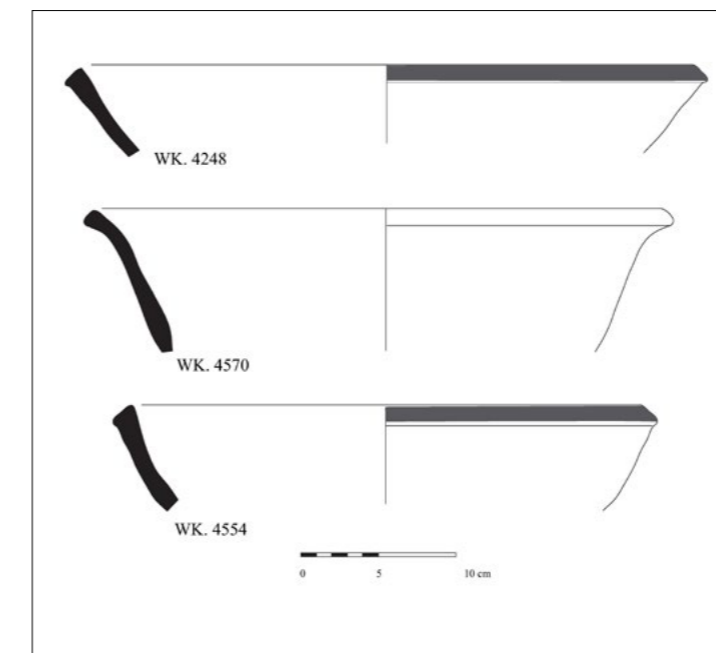

Figure 5: Gra Emni (Saz 249). Group 21: large open vessels from Trenches 2 and 4 (J. Bouvot/M. Gorea - MAFTOr).

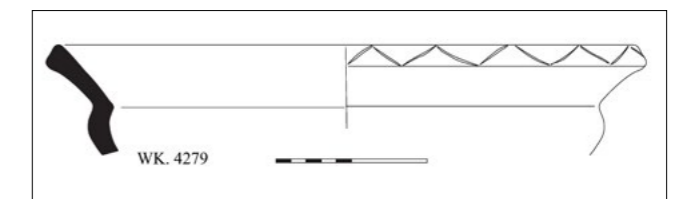

Figure 6: Gra Emni (Saz 249). Group 21: carinated plate from Trench 2 (M. Gorea - MAFTOr).

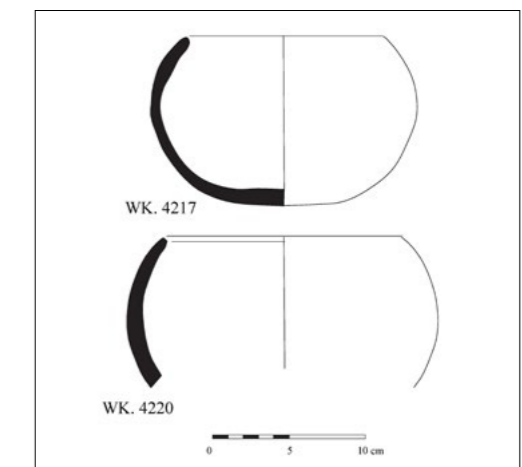

Figure 7: Gra Emni (Saz 249). Group 21: Globular bowls from Trench 2 (J. Bouvot/M. Gorea - MAFTOr).

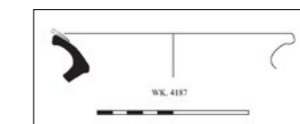
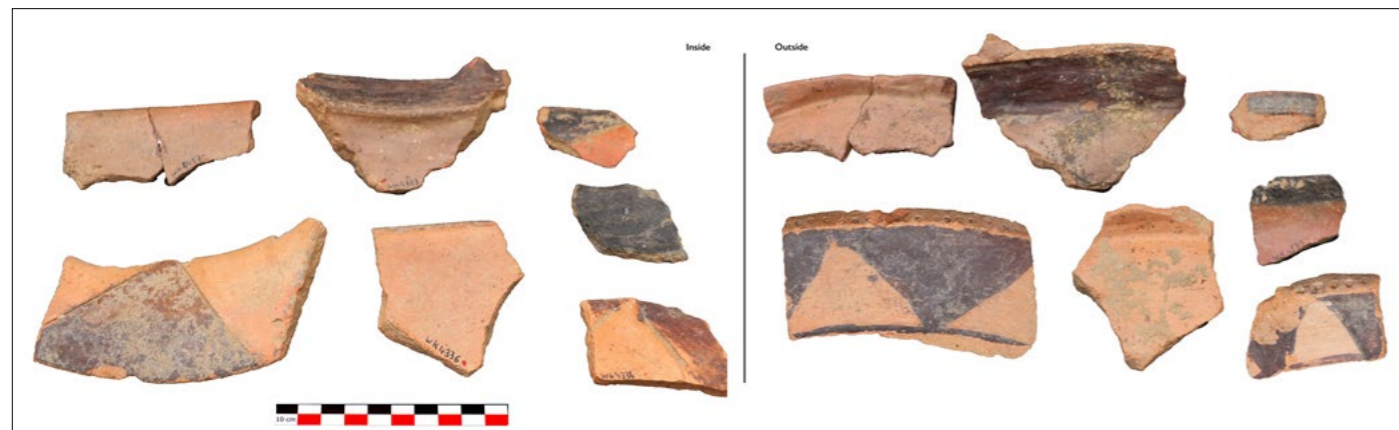

Figure 8: Gra Emni (Saz 249). Group 21: Globular pot with short everted rim from Trench 2 (J. Bouvot - MAFTOr).

123

generally concentrated around the rim and possibly the base of the pots. Among the most common patterns are large triangles on the inner face of ledge rims. The border of these triangles is often underlined with incisions. Triangles also appear on the outside faces of the same vessels, but without incisions around the border. Other decorations include a horizontal strip placed on the top of the rim, outside or inside. On some globular bowls these horizontal strips also include a small incised cross pattern. Decorations underlined by incisions, cross patterns and a horizontal band on top of the rim are elements inherited from a previous period and attested at Wakarida on the fine painted ware (Groups 2 and 7: Benoist *et al.* 2016: fig. 5: 2, 4, 5, 6 10). They are also mentioned in Aksum (Wilding 1989: fig. 16: 458).



▲ Figure 9: Gra Emni (Saz 249). Group 21 with painted decorations from Trench 4 (J. Schiettecatte/M.B.Dhorne - MAFTOr).

◀ Figure 10: Gra Emni (Saz 249). Group 21 with painted decorations from Trench 4 (J. Bouvot/M. Gorea - MAFTOr).

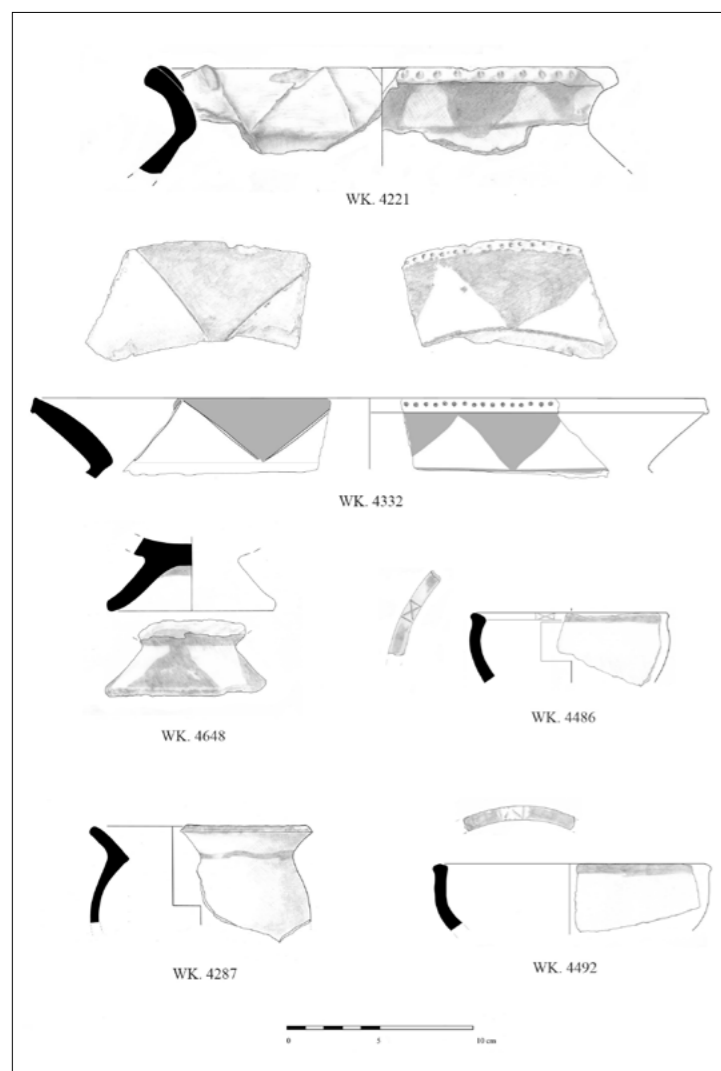

Group 22: Coarse common ware

This group is a thicker and coarser variant of the previous group. The fabric is similar to Group 21, with a coarser and less well sorted temper. The grey shiny grits in particular are larger, reaching 2-3 mm. Vessels are handmade using several techniques (coiling or assembling large plaques, possibly moulding the bottom of some vessels on the one of other vessels, etc.). Shapes mainly include large storage jars and large open vessels (fig. 11). There are also small pots and globular bowls roughly hand-shaped, without any surface treatment, in small quantity. The surface remains more irregular than the one characterising pots and bowls from Group 21, with fingerprints and small irregularities (fig. 12).

A group of large plates and basins shows a particular technique of shaping consisting in moulding the vessel on the ground, without retouching the lower part: the outside surface, regular in the upper part, becomes very irregular in the lower part, including clumps separated by deeps or large cracks (figs. 13-14). The inside surface is smoothed and sometimes pierced by large and deep impressions made with a triangular tool. These imprints obviously have a particular function in relation with food transformation. Similar prints although often smaller are present on large plates and basins from Wakarida: the examples from Gra Emni although thicker and with coarser prints probably had the same function.

Large plates and basins with an irregular outside surface moulded on the ground are also reminiscent of a group of vessels encountered in Sudan during the Meroitic period and later which are interpreted as plates used for cooking bread. Some examples showing an internal wall a bit abraded are interpreted as millstones. Their presence in northern Tigray might reflect a convergence of culinary practices in both regions, in contact since the 4th century CE onwards. On the other hand, there are no examples of such vessels with deep impressions on the inner face in Sudan: these impressions are so far restricted to the Ethiopian area. They are present in Aksum during the late Aksumite period (Wilding 1989: fig. 16: 185).

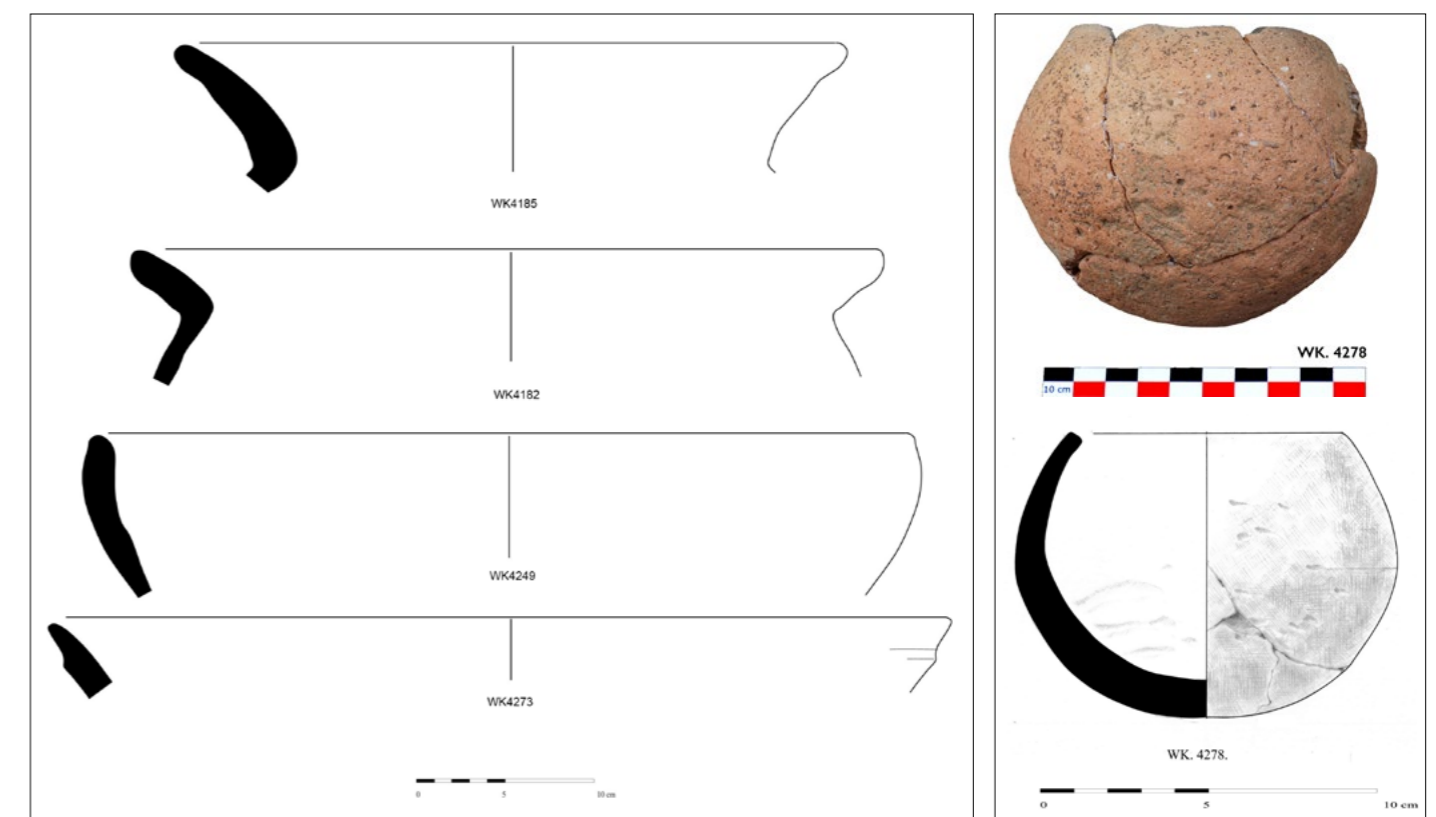

Figure 11: Gra Emni (Saz 249). Group 22. Large storage jars and opened vessels from Trench 2 (J. Bouvot/M. Gorea - MAFTOr).

Figure 12: Gra Emni (Saz 249). Group 22. Globular bowl from Trench 2 (Photograph: J. Schiettecatte/Drawing: M. Gorea - MAFTOr).



Figure 13: Gra Emni (Saz 249). Group 22. Fragment of a large plate with irregular lower part on the outside from Trench 2 (J. Schiettecatte/M.B. Dhorne - MAFTOr).

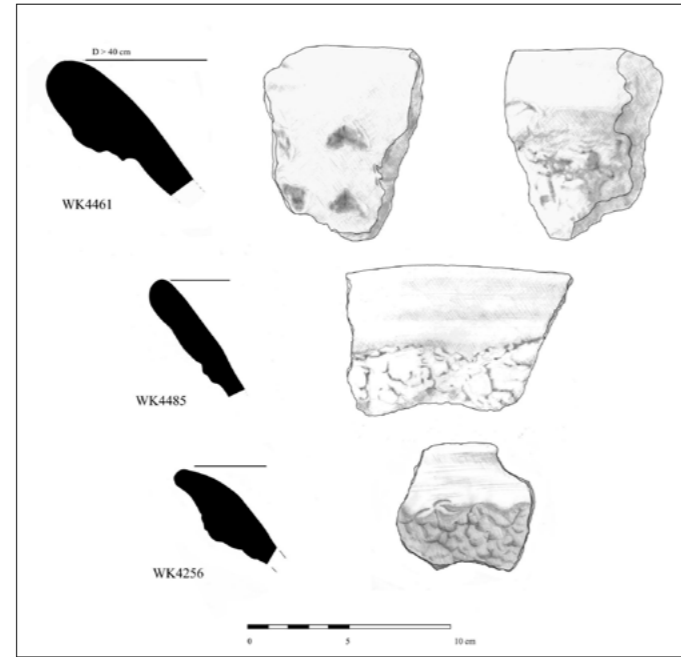

Figure 14: Gra Emni (Saz 249). Group 22. Fragment of vessels with irregular lower part from Trench 2. WK4461 also shows deep imprints on the inside (J. Bouvot/M. Gorea - MAFTOr).

Group 5: Thin common orange ware with fine shiny inclusions

This group has already been observed at Wakarida and reappears here in limited quantity. It includes light orange or pinkish fabrics sometimes with a light grey core, with a generally unslipped surface, more rarely slipped in red or brown, and showing traces of sub-horizontal burnishing. The walls of the vessels are generally thinner than those of groups 21 and 22: 0.5 to 0.8 cm, with sometimes large vessels (jars and basins) showing a relatively thin wall in the medium or lowest part. The fabric includes small occasional red and white grits and a high quantity of fine grey shiny inclusions of soft stone, which give a soapy texture to the clay.

In Gra Emni most of the vessels from that group are large basins with a thin wall in the lower part and a thickened rounded rim (fig. 15). In Sebdera a globular jar with a short neck and a handle in thin common ware (Group 5) has been collected on the floor of the building. At Wakarida the number of jars, bowls and basins in this group is more important.

Groups 21 and 5 can be distinguished mainly because of the sorting of the temper (better in Group 21), the thickness of the walls (thicker in Group 21), and the surface finishing (often more elaborate in Group 21). However, the composition of the fabrics seems close, at first sight. Microscopic analysis shall be done on these two groups to confirm (or not) their proximity.

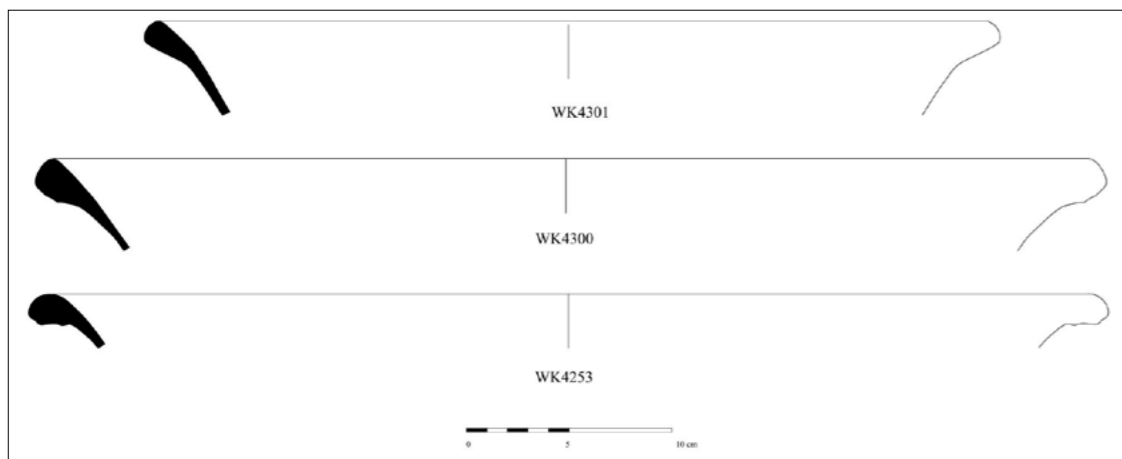

Figure 14: Gra Emni (Saz 249). Group 5. Large vessels with a thin wall and a thickened rim from Trench 2 (J. Bouvot/M. Gorea - MAFTOr).

Group 8: brown incised ware

Group 8 includes suspension vessels — neck jars and pots — characterised by an orange to brown grey ware, hand shaped, with an unslipped rough surface decorated with geometrical incisions forming complex patterns on the neck and the upper part of the body. Neck jars present two small opposite handles most often placed at the base of the neck completed by two small appliqués in relief set on each side of an axis perpendicular to that of the handles. Handles and appliqués are often located along a rib running around the base of the neck. Incised patterns extend around the rim of the jar, over the neck, on the rib, on and around the handles and on the upper side of the body. They combine hatched triangles or rectangles, criss-cross patterns and long oblique lines in chevrons around the body.

This group has been observed in Wakarida (fig. 16) and is also represented in small quantity at Sebdera (fig. 17).

The macroscopic aspect of the fabrics suggests that it is a heterogeneous group including different fabrics. The most frequent has a fine mineral temper including small grey and white inclusions. Pastes are soft and slightly friable, also including fine vegetal imprints. Our present hypothesis is that this group of common incised wares was the result of a domestic production distinct from that of workshops producing common orange wares (Groups 3 and 5 at Wakarida, Groups 5, 21 and 22 at Gra Emni). A first microscopic study of some common brown incised ware from Wakarida has reinforced this hypothesis. Stylistically nevertheless, these potteries remain relatively standardized.

The pottery from Group 8 collected at Gra Emni includes three half complete jars. Two were found in the destruction layer of Trench 4 (WK4605 and WK4606 - fig. 18), the third one (WK4218 - fig. 19) comes from the occupation level in Trench 2.

In Wakarida Common brown incised ware represents 2 to 14 % of the corpus, and mainly develops in period IB, i.e. the end of the occupation of the city. In Wolwalo the common incised ware constitutes only 1 % of the corpus. It could have been a declining residual production.

A common brown incised ware with shapes and decoration strongly reminiscent of our Group 8 is also mentioned by R. Wilding in several late Aksumite contexts in Aksum (Wilding 1989: fig. 16: 407–409) and by J. Phillips in the late Aksumite levels of D site at Kidane Mehret (Phillips 2000: fig. 276: c) (fig. 20). Two jars with similar shapes and decoration have been found in late Aksumite levels in Matara (Anfray & Annequin 1965: pl. LIII: JE2841, JE2758). The regional extension of this group of vessels is much wider than the sole regions of Wakarida and Wolwalo.

The shapes and decoration of the common incised ware also recall the shapes and decorations of a pottery still produced today in the region of Nagash and sold on several markets from Edaga Hamus to Wukro (fig. 21). The ethno-archaeological study realised during the previous seasons led us to document a certain number of techniques used to produce vessels similar to the suspension vessels of Group 8. The modern jars are shaped starting with the bottom, which is moulded on the round bottom of another vessel. After a time of drying up, the body of and the neck of the jar are shaped adding bands over the bottom, surface is smoothed by hand with water. Meanwhile the pot is set inside another vessel that the potter is turning with her hand. Incisions are made with a twig. Interviews of potters selling on local markets have shown that the present suspension jars have various names and uses depending on their size. These elements could bring some light on the techniques used by ancient potters for making suspension vessels in common brown incised ware. A more precise comparison of ancient and recent ware should be made during the next seasons in order to verify if the actual techniques could be a legacy of Antiquity.

Other fabrics

Other fabrics are present in small quantity. A few of them are reminiscent of some groups already observed on the site of Wakarida such as a fine grey fabric with a polished or burnished black slip (Group 4) or a fine red fabric with a red to black or brown to black burnished slip (Group 12). At Gra Emni both fabrics have yielded fragments of small globular and oval pots with everted rim. A grey pottery with a black burnished or

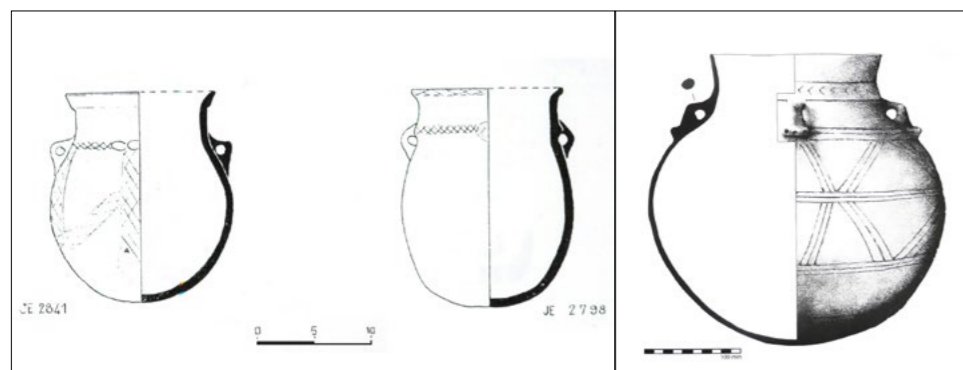
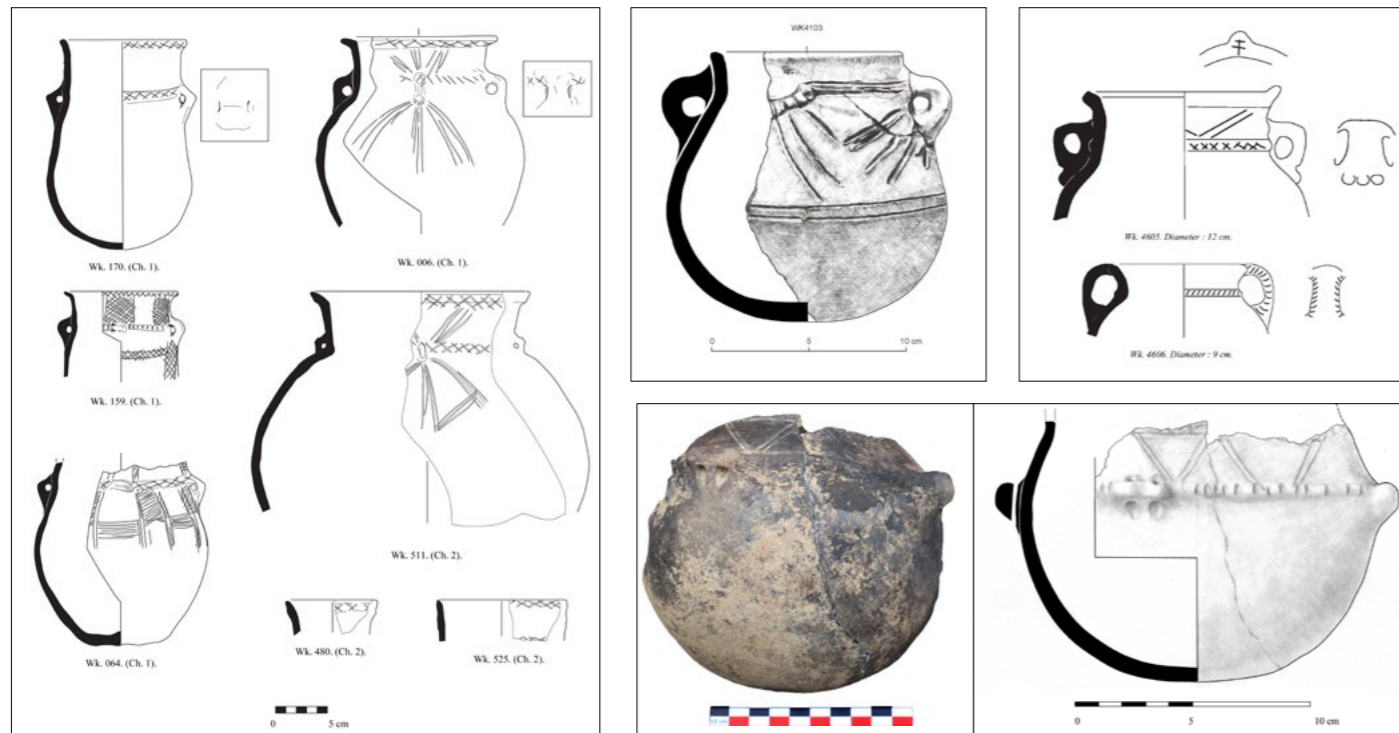

Figure 16: Wakarida. Group 8. Common incised ware (MAFTOr).

Figure 17: Sebdera (Saz 248). Group 8. Jar in common incised ware from the 2018 excavation (M. Gorea - MAFTOr).

Figure 18: Gra Emni (Saz 249). Group 8. Two jars WK4605 and WK4606 from Trench 4 (sketch drawing from the pottery inventory by A. Benoist - MAFTOr).

Figure 19: Gra Emni (Saz 249). Group 8. Fragment of a jar in common incised ware (WK4218) from Trench 2 (Photograph: J. Schiettecatte/M.B. Dhorne/Drawing: M. Gorea - MAFTOr).

Figure 20: Pottery from other Ethiopian sites comparable to the suspension jars of Group 8. Left: Two jars from Tertre B at Matara (Anfray & Annequin 1965: pl. LIII: JE. 2841, JE2758); right: jar from the late Aksumite levels on D site at Kidane Mehret (Phillips 2000: fig. 276: c).

Figure 21: Suspension jar sold in 2012 on the market of Wukro (A. Benoist).

	17	18
16	19	
	20	
21		

polished surface or with a grey surface simply smoothed shows incised or impressed decorations (fig. 22). It includes small hole-mouth pots decorated with vertical incisions, small dot impressions and horizontal or zigzag lines and a pear-shaped bottle with a narrow neck decorated with horizontal incisions. These fragments require further investigation to be interpreted.

Finally, it should be noted that to the contrary of Wakarida, fragments of ribbed amphorae are absent in the sector of Wolwalo, be that in the trenches dug in 2020 at Gra Emni or in the trench dug in 2018 at Sebdera. Even among the surface collections from the survey, none has been found. Such an absence might be chronologically significant.



Figure 22: Gra Emni (Saz 249). Sherds in grey fabric with incised decoration. Left: WK4470 from Trench 2; right: WK4157 from Trench 1 (Photograph: J. Schiettecatte/M.B. Dhorne/Drawing: J. Bouvot - MAFTOr).

Distribution of the pottery from Trenches 1, 2, and 4

The pottery from the different excavations carried out in the Gra Emni area have been unequally studied because of the sanitary interruption of the fieldwork. The pottery from Trenches 1 and 2, opened at the beginning of the season, were almost entirely registered.

In **Trench 1**, 256 potsherds were recorded, including 40 diagnostic sherds (fragments of rims or bases, handles, decorated fragments, etc.). They are mainly coming from the superficial layers (UF 249 000 and UF 249 001, respectively the surface layer and the vegetal earth below).

In **Trench 2**, 849 potsherds were recorded including 209 diagnostic sherds. They are distributed in all the different identified layers and this recording, even if not fully achieved, gives a relatively faithful picture of the assemblage from the earliest layers to the most recent ones (fig. 23). A huge quantity of potsherds was collected in the superficial layers from the same trench. They were not entirely counted but all the diagnostic fragments were kept in order to be described: they are 114.

In **Trench 4**, the registered pottery is mainly coming from the three first stratigraphic units to be excavated: the surface layer (UF 249 028), the vegetal earth just below (UF 249 029) and a part of the collapse layer covering the occupation layers (UF 249 030). 1,720 potsherds have been registered before the end of the season. They include 293 diagnostic fragments. The pottery that could be studied forms a collection rich enough to be considered as representative of the whole material but it cannot be used for a detailed study of the stratigraphic sequence that was partly unearthed below the destruction layer. Given the amount of material recorded in the destruction layer, it is likely that the pottery was partly stored in the upper part of the building (roof, rooms located on a first floor, possible niches in the walls, etc). A similar situation was observed on the site of Wakarida in Building A, Area 2, where a huge collection of material was trapped in the lower part of the destruction. The hypothesis of a storage on the roof or in a room installed atop of the eastern corner of the building has been proposed (Benoist *et al.* in press).

The three trenches 1, 2 and 4 at Gra Emni have yielded a homogeneous material, thus suggesting a contemporary occupation (Table 1). In most of the layers, the majority of the pottery is composed of common ware from Group 21 followed by coarser pottery from Group 22 and common pottery recalling Wakarida examples from Group 5. Common incised ware appears in small quantity in Trenches 2 and 4. Finally, in the three trenches, a small number of other fabrics also appeared, including occasional black or red and black slipped wares (Groups 4 and 12) and some grey wares yet to be better qualified (tables 1-2).

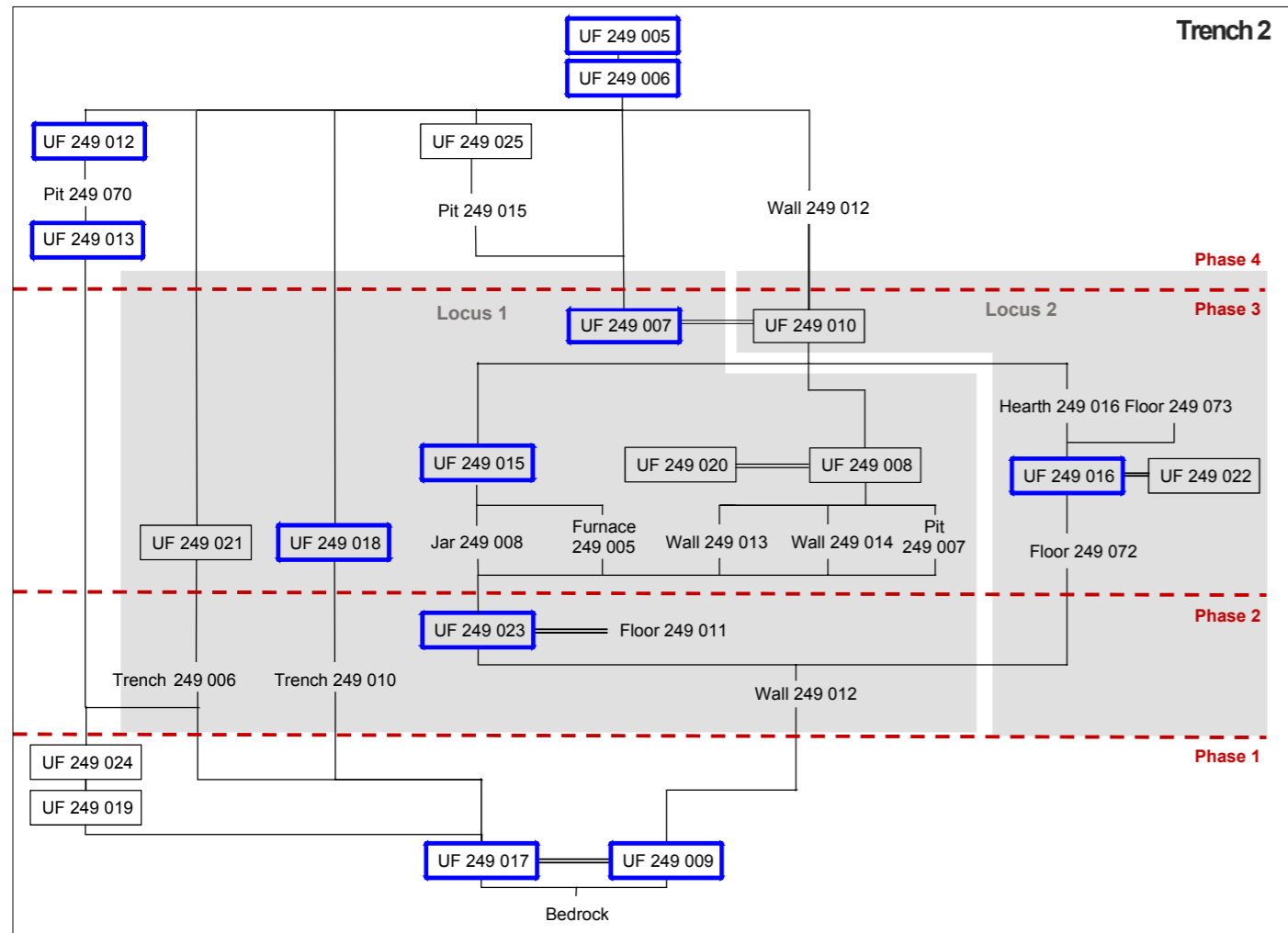

Figure 23: Gra Emni (Saz 249). Trench 2 - Stratigraphic sequence: in blue, stratigraphic units with recorded pottery. Other units are still pending (G. Tavernier/J. Schiettecatte - MAFTOr).

Pottery groups	Subgroups	Trenches				Trenches			
		1	2	4	1-2-4	1	2	4	1-2-4
Group 21	Light polished surface	42	93	182	317	14	18.9	10.5	12.6
	Burnished red slip	13	91	516	620	4.3	18.5	29.9	24.6
	Painted	1	11	83	95	0.3	2.2	4.8	3.8
	Without slip	104	150	797	1051	34.6	30.4	46.1	41.7
Group 22	Red slip	41	0	1	42	13.6	0	0.1	1.7
	Without slip	10	27	14	51	3.3	5.5	0.8	2
Group 5	Red slip	0	17	0	17	0	3.4	0	0.7
	Without slip	46	66	49	161	15.3	13.4	2.8	6.4
Group 8	With incisions	0	4	19	23	0	0.8	1.1	0.9
Group 4	Black burnished	1	2	41	44	0.3	0.4	2.4	1.7
Group 12	Red and black burnished	0	10	6	16	0	2	0.3	0.6
Other	Grey fabrics	43	15	19	77	14.3	3	1.1	3
	Others including burnt sherds	0	7	1	8	0	1.4	0.1	0.3
Total		301	493	1728	2522	100	99.9	100	100

Number of potsherds % of the total corpus of potsherds

Table 1. Distribution of all the potsherds sampled in Trenches 1, 2, and 4 (early post-Aksumite contexts), sorted by groups (A. Benoist - MAFTOr).

Pottery groups	Subgroups	Trenches				Trenches			
		1	2	4	1-2-4	1	2	4	1-2-4
Group 21	Light polished surface	11	19	15	45	27.5	12.6	5.6	9.8
	Burnished red slip	1	8	88	97	2.5	5.2	32.6	21.0
	Painted	1	11	67	79	2.5	7.3	24.8	17.1
	Without slip	15	33	79	127	37.5	21.9	29.3	27.5
Group 22	Red slip	0	0	0	0	0	0	0	0
	Without slip	9	3	6	18	22.5	2.0	2.2	3.9
Group 5	Red slip	0	2	0	2	0	1.3	0	0.4
	Without slip	0	68	0	68	0	45.0	0	14.8
Group 8	With incisions	0	4	8	12	0	2.6	3.0	2.6
Group 4	Black burnished	0	1	5	6	0	0.7	1.8	1.3
Group 12	Red and black burnished	0	1	2	3	0	0.7	0.7	0.7
Other	Grey fabrics	3	0	0	3	7.5	0	0	0.7
	Others including burnt sherds	0	1	0	1	0	0.7	0	0.2
Total		40	151	270	461	100	100	100	100

Number of potsherds % of the total corpus of potsherds

Table 2. Distribution of the diagnostic potsherds sampled in Trenches 1, 2, and 4 (early post-Aksumite contexts), sorted by groups (A. Benoist - MAFTOr).

Pottery groups	Subgroups	Phase (in Trench 2)				Phase (in Trench 2)			
		1	2	3	4	1	2	3	4
Group 21	Light polished surface	12	36	50	32	7.2	38.7	15.2	12.7
	Burnished red slip	38	7	53	37	22.8	7.5	16.1	14.7
	Painted	1	1	7	8	0.6	1.1	2.1	3.2
	Without slip	58	4	109	85	34.7	4.3	33.1	33.9
Group 22	Red slip	0	0	0	0	0	0	0	0
	Without slip	10	7	20	12	6.0	7.5	6.1	4.8
Group 5	Red slip	0	0	17	0	0	0	5.2	0
	Without slip	40	38	35	63	23.9	40.9	10.7	25.1
Group 8	With incisions	0	0	4	14	0	0	1.2	5.6
Group 4	Black burnished	1	0	2	0	0.6	0	0.6	0
Group 12	Red and black burnished	0	0	10	0	0	0	3.0	0
Other	Grey fabrics	0	0	2	0	0	0	0.6	0
	Others including burnt sherds	7	0	20	0	4.2	0	6.1	0
Total		167	93	329	251	100	100	100	100

Number of potsherds % of the total corpus of potsherds

Table 3. Distribution of the potsherds sampled in Trench 2, sorted by groups and phases (A. Benoist - MAFTOr).

In Trench 2 where a stratigraphic sequence has been observed, the pottery does not change significantly from the earliest levels to the latest ones. This led us to consider that the occupation took place within a relatively short span of time in a single chrono-cultural phase (table 3). Common ware (Group 21) represents the main pottery group in the four phases of occupation, together with common ware (Group 5). Inside Group 21, there is no significant evolution in the surface treatment from the earliest to the latest levels. In phase 1, the proportion of red burnished slipped vessels among Group 21 appears very high (22.8 %) and the proportion of vessels with a pearly white polished surface appears low (7.2 %) in the same group. On the contrary, the proportion of vessels with a pearly white polished surface is high in phase 2 (38.7 %) while the red burnished slips are less represented (7.5 %). In the next two phases, both groups become almost equivalent. We cannot tell whether these changes are significant or not and how they should be interpreted. The proportion of painted ware tend to increase slightly from the deepest level to the upper one. Brown incised ware (Group 8) is absent in phases 1 and 2. Since this group is attested in earlier contexts on the site of Wakarida, this absence is probably not significant.

Slight differences are sensible from one trench to another (tables 1-2).

- Group 21- painted ware is more frequent in Trench 4 than in Trench 2 (indiscriminate sherds: 4.8 % vs. 2.2 %; diagnostic sherds: 24.8 % vs. 7.3 %).
- Group 21 - red burnished slip is more frequent in Trench 4 than in Trenches 1 and 2 (indiscriminate sherds: 29.9 % [T4] vs. 4.3 % [T1] and 18.5 % [T2]; diagnostic sherds: 32.6 % [T4] vs. 2.5 % [T1] and 5.2 % [T2]).
- Group 5 is practically absent from Trench 4, whereas they are well represented in Trench 2 (indiscriminate sherds: 16.8 % [T2] vs. 2.8 % [T4]; diagnostic sherds: 46.3 % [T2] vs. 0 % [T4]). This group mainly includes large basins with a thin wall and a thickened rim; their diameter can exceed 60 cm, they were probably used collectively.

The differences in the proportion of painted ware, red slipped ware and light polished ware among Group 21 could also be a matter of archaeological context. In Trench 4 the remains partly unearthed show a relatively elaborated architecture and could belong to a wealthy residence. But they also include an area of domestic activities with an oven in one room. In Trench 2, there are traces of a possible building (phase 2) but the state of preservation does not allow any further interpretation. In this area, the best-preserved remains are the one of phase 3 which also includes an area of open-air domestic activities. Thus, comparisons between both trenches should be made with caution.

Conclusion

The pottery from Gra Emni is quite similar to that excavated at Sebdera in 2018, another contemporary archaeological sector of the Wolwalo area (early post-Aksumite). This assemblage can be easily distinguished from the pottery collected at Wakarida (Period I - middle/late Aksumite), although it remains stylistically close to it. Most of the shapes collected at Gra Emni (notably short-neck jars and short-neck pots, globular bowls and large opened vessels with a thickened rim) are reminiscent of comparable shapes from Wakarida. Therefore, the pottery of Gra Emni is a later continuous chrono-cultural evolution of the assemblage of Wakarida. The main differences between both assemblages are:

- a global thickening of the walls of the vessels whatever their size;
- a better quality of the surface treatment of most of the vessels showing a surface treatment;
- an augmentation of the size of the ledge rims of many vessels;
- a possible increase of the frequency of painted decoration. This hypothesis remains questionable because in Wakarida too, differences appeared from one area to another in the ratio of painted pottery;
- an evolution of the distribution of painted decorations: the size of the painted vessels as well as the thickness of their wall is higher in Gra Emni than in Wakarida where the painted vessels

are generally vessels of small size in fine ware. In Gra Emni the painted vessels usually present a common fabric although the quality of the common wares (better sorted temper, better polished surfaces, better fired fabrics) is higher than the one of the common wares from Wakarida. The two groups of fine painted wares and common wares which were quite distinct at Wakarida seem to intermingle at Gra Emni.

- decorations do not differ much at Wakarida and Gra Emni, and some characteristic patterns remain in use: the horizontal bands over the rims, the incisions underlining some motives, the cross pattern appearing on both sites. However, new designs expand at Gra Emni that were not present at Wakarida: the main example is the triangle.
- some pottery groups encountered at Wakarida are still attested at Gra Emni in small quantity: Group 5 (common ware), Group 8 (common incised ware), Group 4 (fine black polished ware), and Group 12 (fine red and black polished or burnished ware).

Pottery collected at Gra Emni appears much more distinct from the one registered at Wakarida during Period II, between the 10th and the 12th century CE, and if there was a break to be underlined in chrono-cultural evolution, we would be tempted to place it here, at the end of 9th/beginning of the 10th century CE. Yet, we cannot exclude comparisons to be made in the future with other pottery assemblage posterior to the 9th century CE on the Tigray plateau because the difference between Gra Emni and Wakarida (Period II) could also be the consequence of the evolution of the way of living of populations. In the mountainous area around Wakarida, the occupation observed during period II is likely to reflect a nomadic way of life, which has replaced a more sedentary economy based on agriculture and livestock farming. This change could be restricted to the mountainous area and a different evolution may be evidenced on the Tigray plateau itself in the future.

It is still difficult to precise exactly at which moment of the evolution of the kingdom of Aksum the occupation of Gra Emni took place: traditionally the fall of the kingdom of Aksum is dated sometime between the 7th and the 9th century CE, which is likely the period of occupation at Gra Emni. It has been related to the growing competition between African populations and Arab newcomers for the control of the trading networks along the Red Sea. Two characteristics of the material collected at Gra Emni could speak for a break of the region with interregional exchange network and a possible weakening of the Aksumite policy:

- the absence of imported amphorae among the pottery assemblage, not only at Gra Emni, but also at Sebdera and in all the samples collected during the survey;
- the total absence of coins in the excavated layers and on surface.

Hopefully, future researches will bring further evidence about this possible evolution.

References

- ANFRAY F. 1963. Une campagne de fouilles à Yehā (février-mars 1960). *Annales d'Éthiopie* 5: 171–232.
- ANFRAY F. & ANNEQUIN G. 1965. Matarā - Deuxième, troisième et quatrième campagnes de fouilles. *Annales d'Éthiopie* 6: 49–86.
- BENOIST A., GAJDA I. & CHARBONNIER J. 2016. Investigating the eastern edges of the Kingdom of Aksum. The architecture and pottery from Wakarida. *Proceedings of the Seminar for Arabian Studies* 46: 25–40.
- BENOIST A., GAJDA I., MATTHEWS S., SCHIETTECATTE J., BLOND N., BÜCHNER S. & WOLF P. 2020. On the nature of South Arabian influences in Ethiopia during the late first millennium BC: late pre-Aksumite settlement on the margins of the eastern Tigray plateau. *Proceedings of the Seminar for Arabian Studies* 50: 17–34.
- BENOIST A., GAJDA I., SCHIETTECATTE J., BLOND N. & ANTONINI S. IN PRESS [2021]. What was the South Arabian impact on the development of Ethiopian margins in Antiquity? Evolution of settlement pattern in the Wakarida region from pre-Aksumite to late Aksumite periods. In R. Ruzicka & G. Hatke (eds.) *Proceedings of the 23rd Rencontres Sabéennes held in Vienna (June 2019)*. Vienna.

- D'ANDREA A.C., MANZO A., HARROWER M.J. & HAWKINS A. 2008. The pre-Aksumite and Aksumite settlement of NE Tigray, Ethiopia. *Journal of Field Archaeology* 33: 151–176.
- MAKONNEN H., PHILLIPSON L. & SERNICOLA L. 2013. Archaeological Expedition at Aksum, Ethiopia, of the Università Degli Studi Di napoli 'L'orientale" 2011 field season. *Newsletter di Archeologia CISA* 4: 343–439.
- MATTHEWS S. & BÜCHNER S. [2021 - In press]. DAI excavations at Ziban Adi, near Wuqro: A 'provincial palace' of the pre-Aksumite period? In Gajda I & Benoist A. (eds.) *Recent archaeological research in Ethiopia. Proceedings of the international conference on the archaeology of ancient Ethiopia 14-16 April 2016*.
- PHILLIPS J. 2000. Pottery and other clay objects ("The D Site at Kidane Mehret"). In D.W. Phillipson (ed.), *Archaeology at Aksum, Ethiopia, 1993-1997, vol. 2* (Memoirs of the British Institute in Eastern Africa, 17): 303–337. London.
- WILDING R.F. 1989. The pottery. In Munro-Hay S.C. (ed.) *Excavations at Aksum. An account of researches at the ancient Ethiopian capital directed in 1972-1974 by the late Dr Neville Chittick* (British Institute in Eastern Africa, Memoir 10): 235–316. London: British Institute in Eastern Africa.