



HAL
open science

Shahr-i Sokhta and the chronology of the Indo-Iranian regions

Jean-François Jarrige, Aurore Didier, Gonzague Quivron

► **To cite this version:**

Jean-François Jarrige, Aurore Didier, Gonzague Quivron. Shahr-i Sokhta and the chronology of the Indo-Iranian regions. *Paléorient*, 2011, 37 (2), pp.7-34. 10.3406/paleo.2011.5420 . halshs-02978691

HAL Id: halshs-02978691

<https://shs.hal.science/halshs-02978691>

Submitted on 28 Dec 2022

HAL is a multi-disciplinary open access archive for the deposit and dissemination of scientific research documents, whether they are published or not. The documents may come from teaching and research institutions in France or abroad, or from public or private research centers.

L'archive ouverte pluridisciplinaire **HAL**, est destinée au dépôt et à la diffusion de documents scientifiques de niveau recherche, publiés ou non, émanant des établissements d'enseignement et de recherche français ou étrangers, des laboratoires publics ou privés.

Shahr-i Sokhta and the chronology of the Indo-Iranian regions

Jean-François Jarrige, Aurore Didier, Gonzague Quivron

Citer ce document / Cite this document :

Jarrige Jean-François, Didier Aurore, Quivron Gonzague. Shahr-i Sokhta and the chronology of the Indo-Iranian regions .
In: Paléorient, 2011, vol. 37, n°2. pp. 7-34;

doi : <https://doi.org/10.3406/paleo.2011.5420>

https://www.persee.fr/doc/paleo_0153-9345_2011_num_37_2_5420

Fichier pdf généré le 28/06/2022

Résumé

Dans un article publié en 2008 dans *Paléorient*, une série d'arguments a été présentée pour dater la phase finale de la période III et la période IV de Shahr-i Sokhta au cours de la seconde moitié du III^e millénaire et au tout début du II^e millénaire av. J.-C. Une telle datation pourrait impliquer de possibles interactions entre les sites du système de l'Helmand (Shahr-i Sokhta et Mundigak) et la civilisation de l'Indus. Cet article nous conduit tout d'abord à un examen d'ensemble des questions chronologiques à l'échelle des régions indo-iraniennes. Nous passons ensuite en revue les éléments utilisés par les auteurs de l'article précédent pour soutenir une contemporanéité entre les sites de l'Helmand aux périodes III et IV de Shahr-i Sokhta et la civilisation de l'Indus. Puis, en nous fondant notamment sur la séquence des sites de la bordure occidentale de la vallée de l'Indus et du Makran, nous examinons le bienfondé de ces rapprochements proposés entre Shahr-i Sokhta et les sites de la civilisation de l'Indus.

Abstract

In an article published in 2008 in *Paléorient*, a series of arguments have been listed which would allow dating the last phase of Period III and Period IV at Shahr-i Sokhta in the course of the second half of the 3rd millennium and the very beginning of the 2nd millennium BC. This would imply that the sites of the Helmand system, Shahr-i Sokhta and Mundigak, have interacted with the Indus civilization. This article offers an opportunity to go through the main questions concerning the chronology of the Indo-Iranian regions. Then, we review the arguments used by the authors to sustain that the sites of the " Helmand" system at the time of Shahr-i Sokhta, Periods III-IV, and the Indus civilization would be contemporaneous. On the basis of the data provided in particular by sites at the western border of the Indus valley and from Makran, we examine the validity of the comparative elements between Shahr-i Sokhta and the Indus civilization.

SHAHR-I SOKHTA AND THE CHRONOLOGY OF THE INDO-IRANIAN REGIONS

J.-F. JARRIGE, A. DIDIER and G. QUIVRON

Abstract: *In an article published in 2008 in Paléorient, a series of arguments have been listed which would allow dating the last phase of Period III and Period IV at Shahr-i Sokhta in the course of the second half of the 3rd millennium and the very beginning of the 2nd millennium BC. This would imply that the sites of the Helmand system, Shahr-i Sokhta and Mundigak, have interacted with the Indus civilization. This article offers an opportunity to go through the main questions concerning the chronology of the Indo-Iranian regions. Then, we review the arguments used by the authors to sustain that the sites of the “Helmand” system at the time of Shahr-i Sokhta, Periods III-IV, and the Indus civilization would be contemporaneous. On the basis of the data provided in particular by sites at the western border of the Indus valley and from Makran, we examine the validity of the comparative elements between Shahr-i Sokhta and the Indus civilization.*

Résumé: *Dans un article publié en 2008 dans Paléorient, une série d'arguments a été présentée pour dater la phase finale de la période III et la période IV de Shahr-i Sokhta au cours de la seconde moitié du III^e millénaire et au tout début du II^e millénaire av. J.-C. Une telle datation pourrait impliquer de possibles interactions entre les sites du système de l'Helmand (Shahr-i Sokhta et Mundigak) et la civilisation de l'Indus. Cet article nous conduit tout d'abord à un examen d'ensemble des questions chronologiques à l'échelle des régions indo-iraniennes. Nous passons ensuite en revue les éléments utilisés par les auteurs de l'article précédent pour soutenir une contemporanéité entre les sites de l'Helmand aux périodes III et IV de Shahr-i Sokhta et la civilisation de l'Indus. Puis, en nous fondant notamment sur la séquence des sites de la bordure occidentale de la vallée de l'Indus et du Makran, nous examinons le bien-fondé de ces rapprochements proposés entre Shahr-i Sokhta et les sites de la civilisation de l'Indus.*

Keywords: *Chronology; 3rd millennium BC; Sistān; Indus; Balochistan; Interrelationships.*

Mots-clés : *Chronologie ; 3^e millénaire av. J.-C. ; Séistan ; Indus ; Balochistan ; Interactions.*

INTRODUCTION

In an article published in 2008 in the journal *Paléorient*, E. Cortesi, M. Tosi, A. Lazzari and M. Vidale¹ have presented—based mainly upon the data provided by the site of Shahr-i Sokhta (Sistān, Iran)—a review of the principal phenomena of cultural interactions between the sites of the different regions situated from the east of the Iranian plateau to the Indus valley. But the main purpose of the article was to present new arguments to show that the great urban civilization of the Indus valley, which occurred between 2500 and 1900 BC, has coincided with the phenomena of urbanism defined by M. Tosi

as the “*Helmand civilization*”,² during the final phase of Period III and during Period IV of Shahr-i Sokhta, and by extension with the last part of Mundigak Period IV.³

This article offers the opportunity to go through the arguments presented by our Italian colleagues who maintain that some of the data collected at Shahr-i Sokhta in the latest periods of occupation “discussed together with finds from (...) Mundigak (Kandahar, Afghanistan)”⁴ could indicate that these sites were still occupied during the whole time of the Indus civilization. With due respect for the pioneering work accomplished by the Italian mission at Shahr-i Sokhta, we would like

1. Cortesi *et al.*, 2008: 5-35.

2. Lamberg-Karlovsky and Tosi, 1973: 26.

3. Cortesi *et al.*, 2008: 28-29.

4. *Ibid.*: 5.

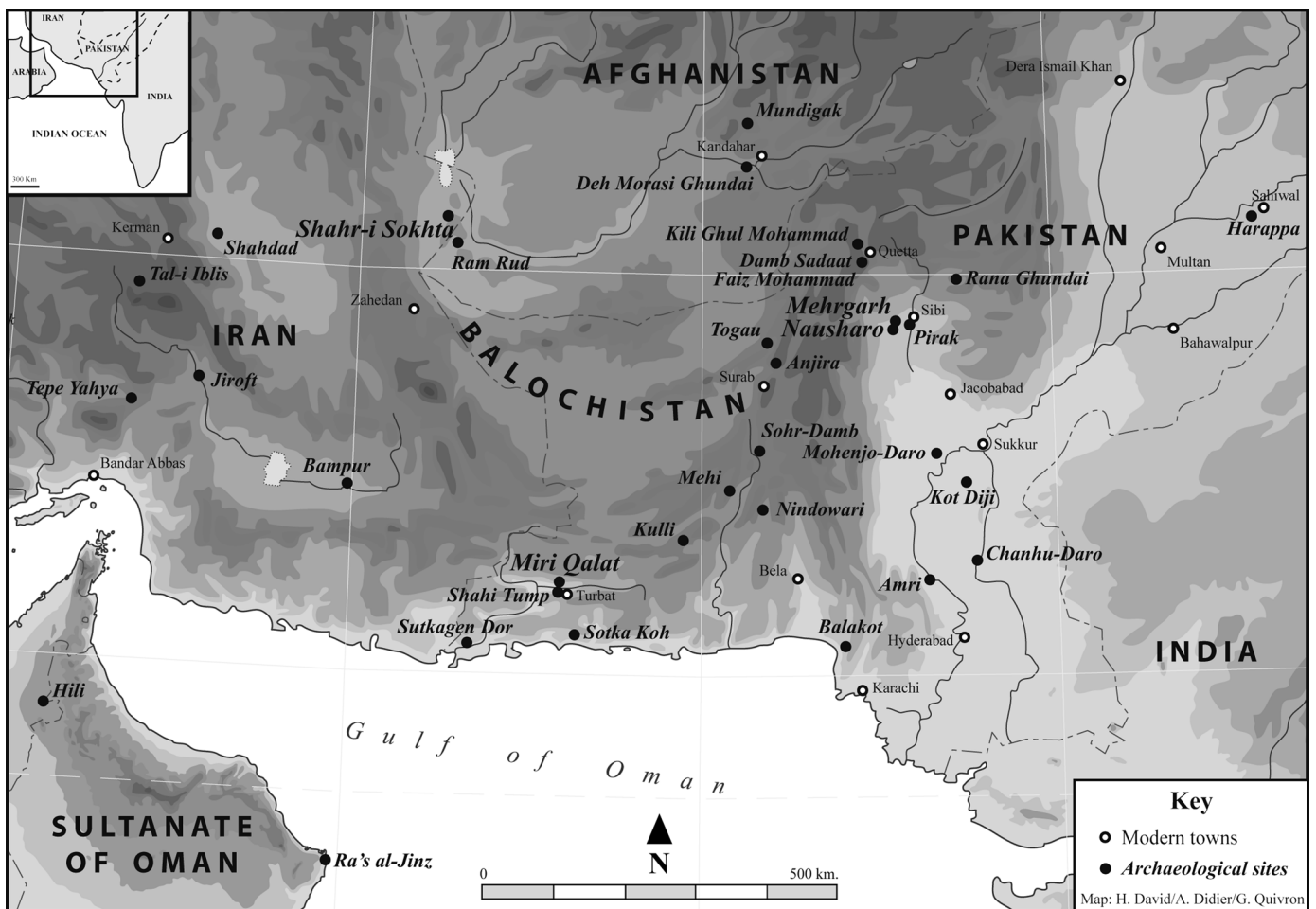

Fig. 1 – Map of the Indo-Iranian Borderlands with archaeological sites mentioned in the text.

to review some of these arguments to see if any of them could support in a convincing way the assertion that the Indus civilization and Shahr-i Sokhta could have interacted in the course of the second half of the 3rd millennium BC.

Since the Italian excavations at Shahr-i Sokhta in the 1970's, information concerning the archaeology of the Indo-Iranian regions (fig. 1) has grown considerably. In several articles,⁵ we have already presented a series of arguments questioning the chronology of the latest occupation of this site from the sequence of the Kachi-Bolan region. Besides, the chronological sequence of Shahr-i Sokhta defined by the Italian archaeologists has recently been revised on the basis of calibrated ¹⁴C dating⁶ and the resumption of excavations in the

graveyard by an Iranian team directed by S.M.S. Sajjadi since 1997⁷ have provided new data that allow further comparisons with the neighbouring regions. For Balochistan there is now a large amount of evidence yielded by sites of the Kachi-Bolan region, such as Mehrgarh and Nausharo.⁸ The research work of the French mission in Makran, in particular at Miri Qalat and Shahi Tump,⁹ has also shown the dynamism of south-western Pakistani Balochistan in the 4th and 3rd millennia BC and provided a more reliable chronological sequence whereas the only known reference for the region was the relatively limited excavations of B. De Cardi at Bampur,¹⁰ on the Iranian

5. Jarrige, 1993 and 1996.

6. The new results presented by Salvatori and Tosi state a low dating of Periods III and IV (Salvatori and Tosi, 2005: figs. 1 and 13).

7. Sajjadi, 2003, 2007 and 2009.

8. Jarrige *et al.*, 1995; Jarrige J.-F., 1988, 1989, 1990, 1993, 1994 and 1996.

9. Besenval, 1994, 1997a and b, 2000 and 2005.

10. De Cardi, 1970.

Table 1 – ^{14}C datings from Nausharo IB-C and Makran IIIb-IIIc. * Radiocarbon dating: Laboratory Beta Analytic, Miami, Florida; ** Radiocarbon dating: Laboratory AMS, University of Arizona, Tucson.

Sample	Region	Site / period	^{14}C Age BP	68 % (1σ) cal BC ranges	95.4 % (2σ) cal BC ranges
Beta 18843*	Kachi-Bolan	Nausharo IB	4070 ± 70	cal BC 2865-2498	
Beta 18842*	Kachi-Bolan	Nausharo IC	4030 ± 70	cal BC 2855-2470	
Beta 18844*	Kachi-Bolan	Nausharo IC	4010 ± 80	cal BC 2853-2463	
P786-AA85551**	Makran	Site 170, Period IIIb	4125 ± 42	cal BC 2861-2621	cal BC 2872-2579
Pa 2413**	Makran	Miri Qalat IIIc	3955 ± 30	cal BC 2565-2368	cal BC 2569-2346
Pa 2417**	Makran	Miri Qalat IIIc	4015 ± 40	cal BC 2571-2488	cal BC 2618-2470

side.¹¹ Considering the Kachi-Bolan and Makran regions and for the periods that will be discussed here (first half of the 3rd millennium BC), the calibrated ^{14}C dating supplemented with new data¹² (table 1) are consistent with the ceramic sequences which would place Nausharo Period IB-D and Makran Periods IIIb-IIIc between 2800 and 2500 BC.¹³ We have also to mention the recent excavations carried out by the German team at Sohr Damb/Nal which have brought further data for the chronology of Southern Balochistan,¹⁴ while the publication of the excavations at Nindowari,¹⁵ with its pre-Kulli and Kulli levels, contributes to a better understanding of these regions in the 3rd millennium BC. For the Indus valley, besides the relatively old excavations at Amri and Kot Diji, the resumption of investigation in 1986 at Harappa by the Harappa Archaeological Research Project, today co-directed by R.H. Meadow and J.M. Kenoyer, constitutes a solid basis to explain the internal sequence of the Indus civilization.¹⁶

Insofar as the authors of the article refer several times to Period 3C at Harappa, we must remind that since the exca-

vation at Amri, conducted by J.-M. Casal in 1961-62,¹⁷ the Indus civilization has been divided into three main periods which date approximately to between 2500 and 1900/1800 BC (Amri IIIA, IIIB, IIIC). Harappa excavations have confirmed this sequence with Periods 3A, 3B and 3C. This division is consistent with the “Harappan” sequence defined at Nausharo, with Periods II, III and IV.¹⁸ It is striking to observe how the Indus civilization evolved in a very coherent way over a vast territory during its first two periods, while the third one, at the end of the 3rd millennium BC, is characterized by the appearance of regional variants and external elements due to (among other factors) the settling of groups whose cultural assemblage is obviously related to the Oxus civilization, or as it is also called, to the *Bactria-Margiana Archaeological Complex*. At Nausharo, the presence of a well-attested “Oxus” component in the Indus material of Period IV remains nevertheless a minority, although the funerary objects collected in the contemporary graveyard of Mehrgarh (zone MR.8) were mainly of “Oxus” type.¹⁹ Since some confusion has occurred,²⁰ it is important to emphasize that the MR.8 graveyard that constitutes Period VIII in the general sequence of the site, does not directly follow the Period VIIC occupation. Between the end of Period VIIC, probably a little before 2600 BC, and Period VIII, at the very end of the 3rd millennium, there is a long break of four or five centuries corresponding to Periods ID, II and III of Nausharo.

11. We have also to mention the recent investigation carried out by an Iranian team at Bampur (Sajjadi, 2005). However, the chronology defined by De Cardi is still relevant today.

12. The authors acknowledge R. Besenval and V. Marcon, founder and currently at the head of the French mission in Makran, to have kindly provided these data.

13. Considering Miri Qalat Period IV, it is important to notice that the late dating of the two samples from the Indus levels (to which our Italian colleagues systematically refer), placed in a chronological bracket corresponding to 2200-2100 BC, is in contradiction with the fact that the “Harappan” pottery of Miri Qalat is stylistically relevant to the first main period of the Indus civilization (corresponding to Period II at Nausharo). Without the intention of opening a new debate on the chronological sequence of Miri Qalat, it is difficult to accept a break of four centuries at least between Periods IIIc and IV of Miri Qalat, whereas the stratigraphy and the local pottery that persists during the “Indus” period show strong elements of continuity between these two periods.

14. Franke-Vogt, 2005; Franke-Vogt and Ibrahim, 2005.

15. Jarrige *et al.*, 2011.

16. Kenoyer and Meadow, 1997, 2005 and 2008.

17. Casal, 1964.

18. Jarrige J.-F., 1988, 1989, 1990, 1993 and 1996.

19. Jarrige and Quivron, 2008.

20. In 1982, Bridget and Raymond Allchin published by error a plate with Mehrgarh pottery from period VII to illustrate the findings of the MR.8 graveyard, which is four or five centuries later (Allchin and Allchin, 1982: 233-234).

“INTERACTIONS SPHERES IN THE INDO-IRANIAN BORDERLANDS”: THE REVISED CULTURAL SEQUENCE OF PROTOHISTORIC SITES IN BALOCHISTAN

The discovery of Shahr-i Sokhta and the work undertaken at this site contributed to breaking the relative isolation of the pioneer site of Mundigak, excavated in the 1950s in the Kandahar region (Southern Afghanistan).²¹ It became an essential basis for new studies on the interactions and trade between the sites belonging to the hydrographic system of the Helmand River and the neighbouring regions during the 4th and 3rd millennia BC. The article published in 1973 in *East and West* by C.C. Lamberg-Karlovsky and M. Tosi is the result of these comparative studies and marks an important stage in the archaeology of the Indo-Iranian regions.²² Discoveries at Shahr-i Sokhta Period I of a proto-Elamite tablet, of seals and impressions belonging to the “Mesopotamian koinè of the Jemdet Nasr Period”,²³ of a few potsherds with suspension lugs, probably a local version of jars in the style of *Jemdet Nasr*, indicate links with Tepe Yahya IVC and several other sites of the Iranian plateau. However, the absence of proto-Elamite elements at Mundigak has been noted, in spite of obvious parallels between Mundigak III and Shahr-i Sokhta I, at the end of the 4th and at the very beginning of the 3rd millennium BC. Nevertheless, a fragment of a polychrome jar with perforated lug had been found by Casal in a house from Mundigak Period III.6, contemporary to Period I of Shahr-i Sokhta.²⁴ This potsherd, not documented by Casal and kept today in Musée Guimet, is comparable to the models of the Jemdet Nasr Period.²⁵

But for most of specialists,²⁶ another important link was the presence of pottery at Mundigak III and Shahr-i Sokhta I, close by their painted motifs to the *Geoksyur-Namazga III* ceramic style in southern Turkmenistan and to the *Quetta-Damb Sadaat* II and III style in Balochistan. As a consequence, almost until today, models assigning a major role to influences from southern Central Asia, particularly those of the *Geoksyur-Namazga III* complex, became prevalent to explain the appearance in Balochistan of painted pottery styles with geometric stepped motifs.

In the mid 1970s, the discovery of a long chrono-cultural sequence in the Kachi-Bolan region has provided solid data for a new examination of archaeological phenomena in the Indo-Iranian regions.²⁷ This sequence starts with an aceramic Neolithic period at Mehrgarh, which probably began at the end of the 8th millennium BC, till the Indus occupations at Nausharo covering the second half of the 3rd millennium BC and the late Bronze Age / Iron Age occupations at Pirak during the 2nd and 1st millennia BC.²⁸ We have also to take into account the very important contribution of archaeological research in Pakistani Makran, with the excavations at Miri Qalat and Shahi Tump and the surface collecting carried out on many sites in the Dasht Plain, mainly dated to the 4th and 3rd millennia BC.²⁹ These data, based on solid stratigraphic evidence, have enabled a more precise analysis of the phenomena defined as “*the Helmand civilisation*” and of its relations with Balochistan and the Indus valley.

The appearance, probably a little before 6000 BC, of a coarse chaff-tempered pottery at Mehrgarh Period IIA, gave to the ceramic crafts of Balochistan a temporal depth that nothing had previously indicated in these regions.³⁰ Mehrgarh Neolithic (Periods I and II), and Chalcolithic (Period III) levels, the latter dated to the 5th and the very beginning of the 4th millennium BC, have revealed a technological and especially pyrotechnological skill, which has never before been recorded for Balochistan in such early contexts.³¹ For example, it is at the beginning of Mehrgarh III that early *Kili Ghul Mohammad* and *Togau* ceramics decorated with geometric designs and already using a rotating support in their manufacture occurred.³²

The long-lasting Period III of Mehrgarh (5th and beginning of the 4th millennium BC) has enabled to follow the development of different craft techniques in several areas, particularly in the pottery styles called *Togau A* and *Kili Ghul Mohammad II* and III widespread in Balochistan. It is actually interesting to notice that the early fine *Togau* ware of Balochistan shows parallels with the fine black-on-red ceramics known at Cheshmeh Ali in the northern Central Iranian Plateau, which have been dated to 5200-4300 BC (Transitional Chalcolithic).³³ This pottery is typically decorated with various geometric designs, but also with stylized birds and goats in rows,³⁴ which show

21. Casal, 1961.

22. Lamberg-Karlovsky and Tosi, 1973.

23. Amiet and Tosi, 1978: 24-25.

24. Jarrige, 1987.

25. *Ibid.*: 661-666.

26. For example, see Biscione, 1974.

27. Jarrige, 1995.

28. *Ibid.*

29. Besenval, 1994, 1997a and b, 2000; Besenval et Didier, 2004.

30. Jarrige, 1998.

31. Jarrige *et al.*, 1995 ; Jarrige C., 2008: 11.

32. Wright, 1995: 664-666.

33. Wong *et al.*, 2010: 1-2.

34. *Ibid.*

similarities with some *Togau* decorations. It is also significant that the pottery of Mundigak I, the earliest occupation of the “Helmand” cultural complex, corresponds to the Mehrgarh III pottery, in technique—quality of the paste and manufacture—as well in the shapes and decoration, probably within a phase dated to the end of the 5th millennium.³⁵ The pottery of Mundigak I-II (fig. 2: 3-5, 7-8) can also be related to the context of Balochistan ceramic productions, especially from Mehrgarh IV around 3500 BC (fig. 2: 1-2). Two potsherds corresponding to the same *Togau* style (one decorated with stylized goats) have been discovered at Sarazm in upper Zerafshan (Tajikistan), in association with Namazga II vessels³⁶ (fig. 2: 6,9). The extensive geographical scale of the diffusion zone for the *Togau* ware, characteristic of Mehrgarh III, may now be appreciated.³⁷ Later, at Sarazm, an increasing assemblage of pottery (about 15% of studied material³⁸), especially from Periods III and IV, offers obvious parallels with Mehrgarh VI and VII vessels dated to the end of the 4th and to the beginning of the 3rd millennium BC, while the pottery of *Geoksjur* style remains in the majority.³⁹ Thus another evidence of the diffusion of ceramic productions from Balochistan to Central Asia, north of the great mountain barrier of the Hindu Kush, is now well attested.

However, the questions of the appearance and development of different pottery types in Balochistan remain relatively complex. Considering the very long sequence of Mehrgarh Period III, it could be assumed that *Kili Ghul Mohammad* II and *Togau* A wares have provided the prototypes of different pottery assemblages in neighbouring regions, especially Southern Balochistan or Sistān during the foundation of Shahr-i Sokhta. But, in Makran, unlike Central and Eastern Balochistan, the sites apparently remained aceramic until the beginning of the 4th millennium BC. It is only in the first centuries of the 4th millennium (Period II in Makran chronology) that, relatively suddenly, a pottery of quality using coil-building technique and probably a rotating support appeared at Miri Qalat and at Shahi Tump.⁴⁰ As B. Mutin noticed,⁴¹ the Period II pottery shows very few links with the ceramic productions from Central and Eastern Balochistan, as it can be seen in particular at Mehrgarh. In fact, the closest parallels can rather be found in south-eastern Iran,

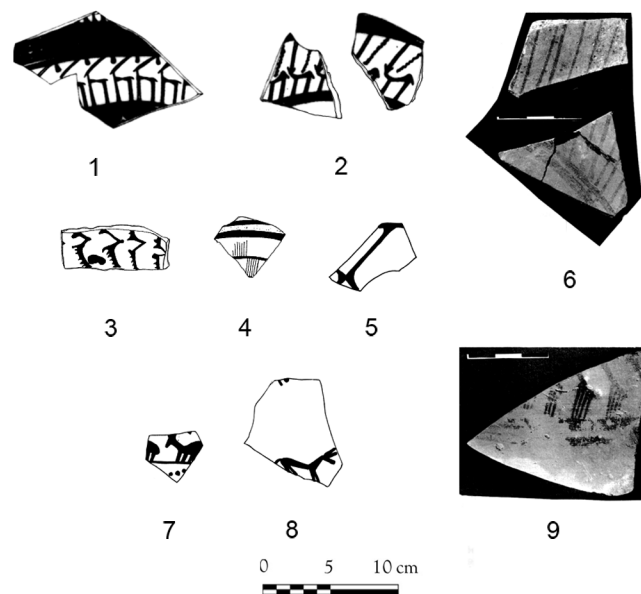

Fig. 2 – *Togau* ware with motifs of stylized caprids. 1-2, Buff reddish ware from Mehrgarh III (C. JARRIGE et al., 1995: fig. 3.2, a-c); 3-5, 7-8, Ceramics from Mundigak I (CASAL, 1961: fig. 49.9, 11-12, fig. 50.26, 29a); 6, 9, Ceramics from Sarazm (ISAKOV et LYONNET, 1988: pl. 1, 2-3).

for instance at Tal-i Iblis (Kerman), in the *Aliabad* ware period, and at Tepe Yahya VI-V.⁴²

The Makran pottery from the following Period IIIa is particularly well-represented in tombs at Miri Qalat and Shahi Tump dating to the last centuries of the 4th millennium and very beginning of the 3rd millennium BC.⁴³ As B. Mutin noticed,⁴⁴ a part of the Period I pottery from the graveyard of Shahr-i Sokhta,⁴⁵ especially the bowls decorated with pseudo-swastikas⁴⁶ (fig. 3: 1-6), are stylistically very close to the Makran IIIa funerary pottery⁴⁷ (fig. 3: 7-9). At Mundigak III, besides the several shapes and decorations showing strong affinities with central and eastern Balochistan, large bowls or cups decorated inside with motifs clearly related to decorative traditions of south-eastern Iran (particularly in Makran) also appear in con-

35. Casal, 1961 : fig. 49-50.

36. Isakov et Lyonnet, 1988: pl. I, n° 2-3; Lyonnet, 1996 : 56-57, pl. III.

37. Jarrige C. et al., 1995: fig 3.2.

38. Isakov et Lyonnet, 1988: 35.

39. *Ibid.*: 31-34.

40. Didier et Mutin, in press.

41. Mutin, 2007.

42. Didier et Mutin, in press; Mutin, in press.

43. Besenval, 2000: 169-171, fig. 11-20.

44. Mutin, 2007; Mutin, in press; Didier et Mutin, in press.

45. Sajjadi, 2003: 61, fig. 26.

46. Bonora et al., 2000: 505, fig. 7.

47. Mutin, 2007 (vol. 4) : fig. II.150, n° 4 and II.167; Mutin, in press; Stein, 1931: pl. XV-XVI.



Fig. 3 – Bowls decorated with “pseudo-swastika” motifs. 1-6, Ceramics from Shahr-i Sokhta cemetery, Period I (SAJJADI, 2003: fig. 26); 7-9, Ceramics from Nilag (Dasht Plain, Makran), Period IIIa (MUTIN, 2007 : fig. II.278, 12-14).

temporary contexts.⁴⁸ The discovery at Miri Qalat IIIa of bevelled-rim bowls that can be linked to the proto-Elamite sphere in Eastern Iran⁴⁹ strengthens the links between Makran and Sistān where, if no bevelled-rim bowls have been recorded, other “proto-Elamite” elements are frequently found.

“THE NAL CERAMICS”: THE QUESTION OF THE ORIGIN OF POLYCHROME DECORATIONS IN BALOCHISTAN

A great importance has also been attached to the appearance of bichrome and polychrome decorations that occurred in the Indo-Iranian regions in the second half of the 4th millennium BC. At Mehrgarh, the first known examples of bichrome decorations painted in red and black on a beige background are recorded in the last phase of Period III, around 4000 BC.⁵⁰ The development of this decorative technique in Balochistan, mainly attested in the *Kechi Beg* vessels, was also considered to be a phenomenon of external origin, either related to an influence by the *Jemdet Nasr* pottery from Mesopotamia or by the *Geoksyur-Namazga III* pottery from southern Turkmenistan. However, very different types of polychrome pottery were ascribed in a questionable way to the *Kechi Beg* style. At Mehrgarh IV, around 3500 BC, large cups and carinated pots in *Kechi Beg* pottery decorated with complex combinations of motifs painted in black and red⁵¹ coexist in the same levels with another specific polychrome production. This pottery includes large truncated-conical shaped vessels, jars and carinated bowls covered with red paint and decorated with black and white motifs⁵² (fig. 4: 1-3). This decoration with white pigments is a striking feature in the pottery production from Mehrgarh IV and V.

A recent study carried out in collaboration with the Centre de recherche et de restauration des musées de France (C2RMF) has shown that the white pigment on one sample dated to Mehrgarh IV is obtained from fired steatite.⁵³ The use of such a pigment is consistent with the succession of tech-

niques using heat developed by craftsmen in the Kachi-Bolan region to change, in the last phase of the pre-pottery Neolithic, black steatite into white steatite, and to produce, in the beginning in the 5th millennium BC, steatite beads covered with a copper oxide glaze.⁵⁴ In such a context, it is not surprising to find evidence as a further technical step, around 3500 BC, of fired steatite to produce “coloured” pigments used for the pottery painting decoration. The use of an additional white pigment, which nature may vary according to the different areas, is widespread in Balochistan and in the Indus valley during the second half of the 4th millennium BC. But the ceramic shapes and decorations often differ substantially in the various pottery manufacturing areas. At Mehrgarh, combinations of geometric motifs are predominant whereas flowers or fish decorations occur at Rehman Dheri II.⁵⁵ Nevertheless, the forms of the large truncated-conical shaped vessels from Mehrgarh IV and V (fig. 4: 1-3) are also found at Sohr Damb/Nal⁵⁶ (fig. 4: 7), in the cemetery of Shahi Tump in Makran⁵⁷ (fig. 4: 5-6), and further west in the *Aliabad ware* at Tal-i Iblis⁵⁸ (fig. 4: 4). These shapes are sufficiently rare and limited in time scope, with their almost monumental aspect and their complex polychrome decoration, to be undoubtedly associated. It is important to observe that the *Aliabad* vessels, produced in a chronological context prior to the foundation of Shahr-i Sokhta, are less carefully manufactured than it is the case for the exceptional products from Mehrgarh or Makran. Considering the question of ways of influences raised frequently in the archaeology of the Indo-Iranian regions, it becomes necessary to study the factors related to specific craft techniques when attempting to establish a cartography of the development of phenomena such as the diffusion of bichrome and polychrome decoration in this vast geographic territory.

This also appears clearly when the question of the *Nal* polychrome ware is tackled. In their article, our Italian colleagues provide a systematic review of the *Nal* pottery discovered at Shahr-i Sokhta, in particular the canister pots.⁵⁹ The decorative quality of this pottery found over a vast zone of the Indo-Iranian regions, from Makran to Afghanistan and to Iranian Sistān, has often been noted.⁶⁰ But it is only in the heart of the

48. Casal, 1961 : fig. 54-55.

49. Besenval, 1997b: 210, fig. 18.

50. Wright, 1995: 665-666.

51. Jarrige *et al.*, 1995: 28, figs. 2.11-2.13.

52. *Ibid.*: figs. 1.9, 4.14, 8.21.

53. Didier, in press; A. Didier, Polychrome wares from Pakistani Makran, Mehrgarh/Nausharo (Pakistan) and Mundigak (Afghanistan): First results of the archaeometric studies. *20th International Conference of the European Association of South Asian Archaeologists (EASAA)*, Vienna, Austria (July 5th-10th, 2010), forthcoming.

54. Barthélemy de Saizieu and Bouquillon, 1997 ; Barthélemy de Saizieu, 2003.

55. Durrani, 1988: pl. XVIIA-B.

56. Franke-Vogt, 2005: fig. 8.

57. Mutin, 2007 (vol. 4) : fig. II.198.

58. Sarraf, 1981: abb. 26; Mutin, in press.

59. Cortesi *et al.*, 2008: 10-14.

60. Amiet and Tosi, 1978: 22-23, fig. 4a; Franke, 2008: 661.

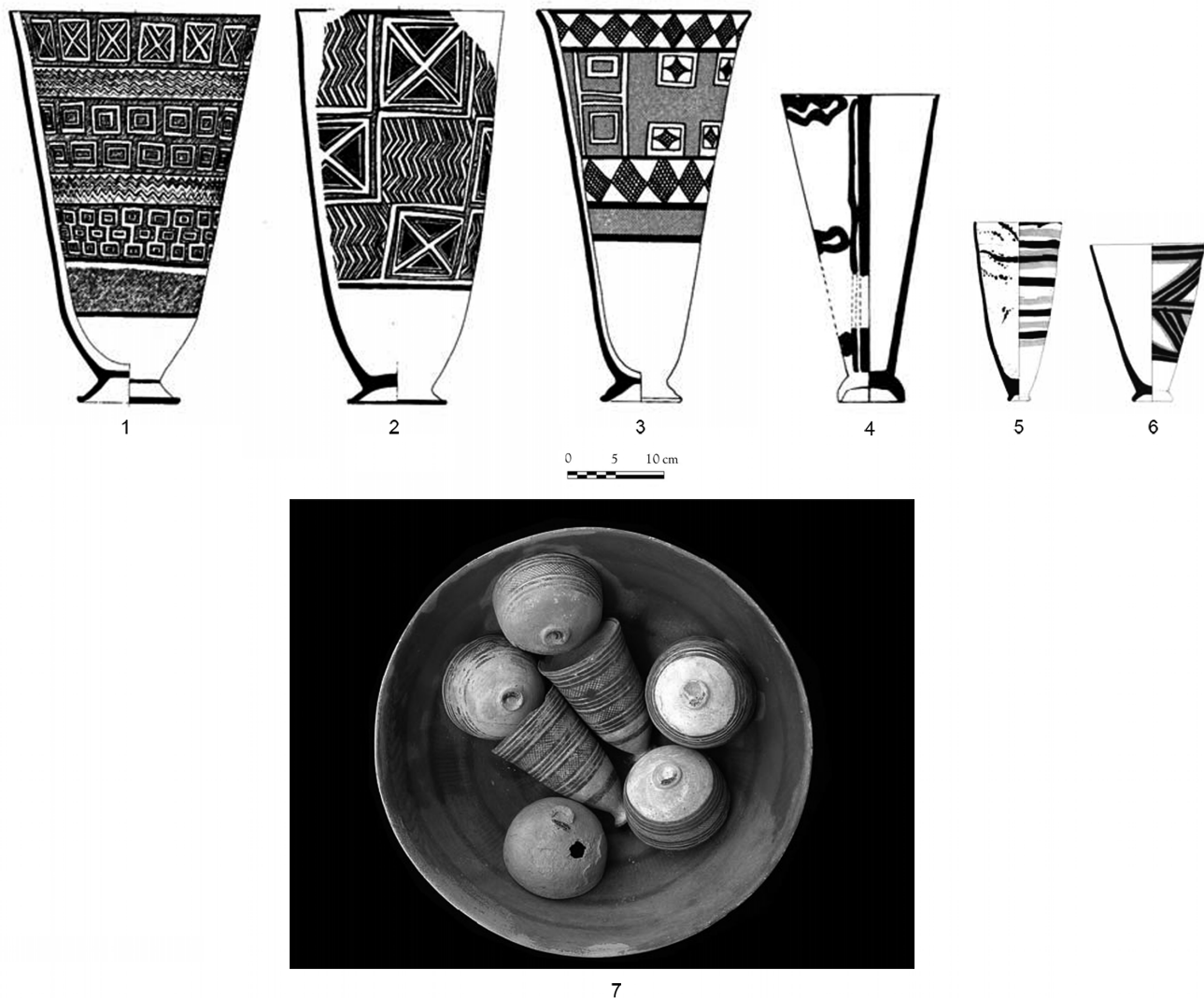

Fig. 4 – Truncated-conical goblets with polychrome or monochrome painted decorations. **1-3**, Ceramics from Mehrgarh IV-V (drawings MAI); **4**, Ceramic from Tal-i Iblis (SARRAF, 1981: *abb.* 26); **5-6**, Ceramics from Makran, Period IIIa (MUTIN, 2007: *fig.* II.194, n° 13-14); **7**, Ceramics from Sohr-Damb/Nal I (FRANKE-VOGT, 2005: *abb.* 8).

territory of the *Nal* culture, in Southern Balochistan, that the complex iconographic patterns probably related to a particular symbolism can be observed. This is demonstrated by several painted vessels discovered by Hargreaves, then by U. Franke in the context of Period II at Sohr Damb/Nal, dated between 3100 and 2700 BC⁶¹ (fig. 5). Relatively recent looting in this region has resulted in the evermore frequent appearance in various

sale catalogues of many representations of winged griffons, raptors with spread wings, lion friezes and, more significantly, human figures with lion heads. However, outside the *Nal* core area, the canister pots mainly have geometric designs using a range of colours (black, red, yellow, turquoise and green) which have likely been applied after firing. But besides these containers in the “spirit” of *Nal* pottery, other polychrome vessels that differ significantly from the *Nal* style in their shapes and their decorations occur at Shahr-i Sokhta or in the Dasht plain (fig. 6) even though the same range of colours was used.

61. Franke-Vogt, 2005: 71, fig. 12; Franke, 2008: 661, figs. 19-20, 31; Hargreaves, 1929.

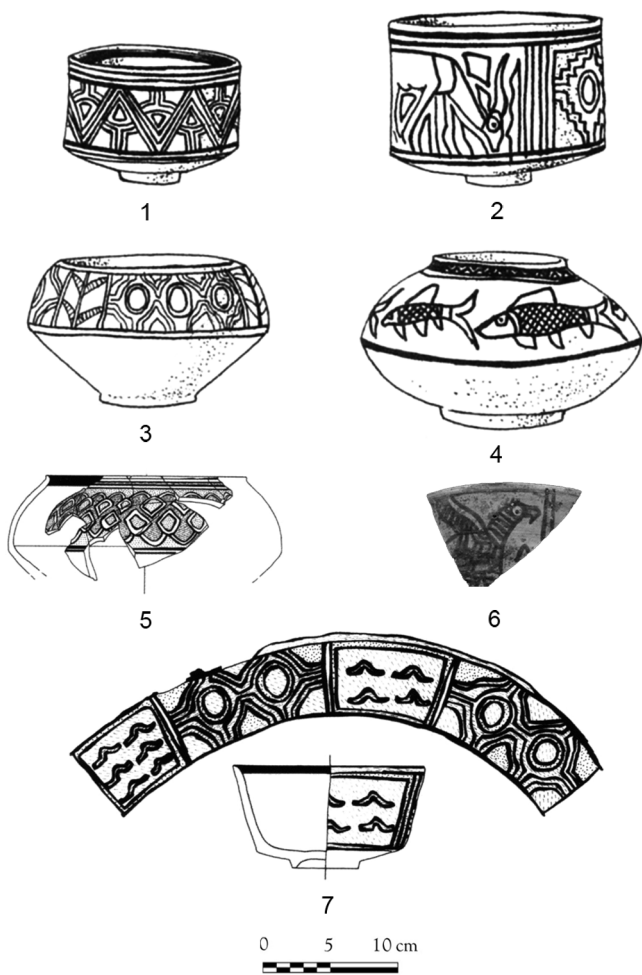

Fig. 5 – Nal polychrome ware from Balochistan. 1-4 (FAIRSERVIS, 1975: fig. 40); 5-7 (FRANKE-VOGT, 2005: fig. 60).

Although only few *Nal* polychrome sherds can be recorded at Shahr-i Sokhta I,⁶² the majority of the polychrome vessels from this site belong to a very individualized production, found in contexts dated to Period II and which can be linked to a “Helmand” (or Shahr-i Sokhta II) style⁶³ (fig. 7). It is moreover interesting to observe that several sherds of *Nal* polychrome pottery appear at Mehrgarh in the levels of Period VB (fig. 8: 1), while in Periods VIIA and B and in Nausharo IA-B,

62. Amiet and Tosi, 1978: fig. 4.

63. Mugavero and Vidale, 2003.

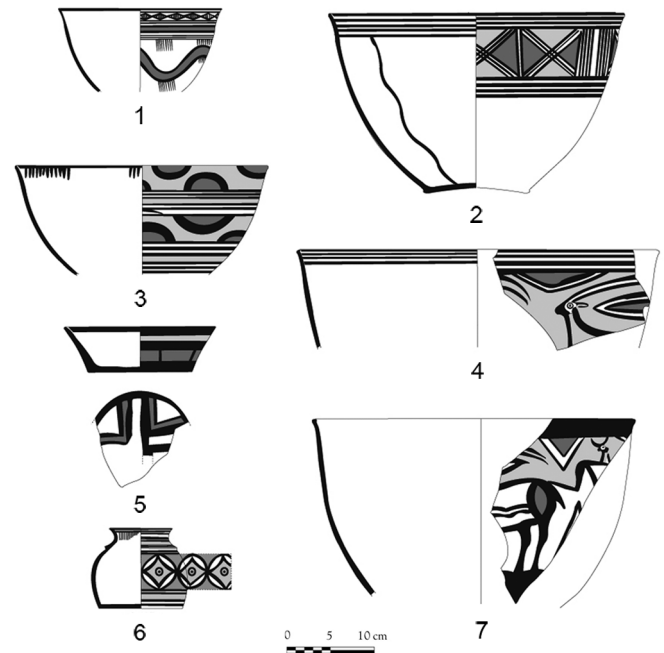

Fig. 6 – Dasht polychrome ware from Makran IIIb (drawings MAFM).

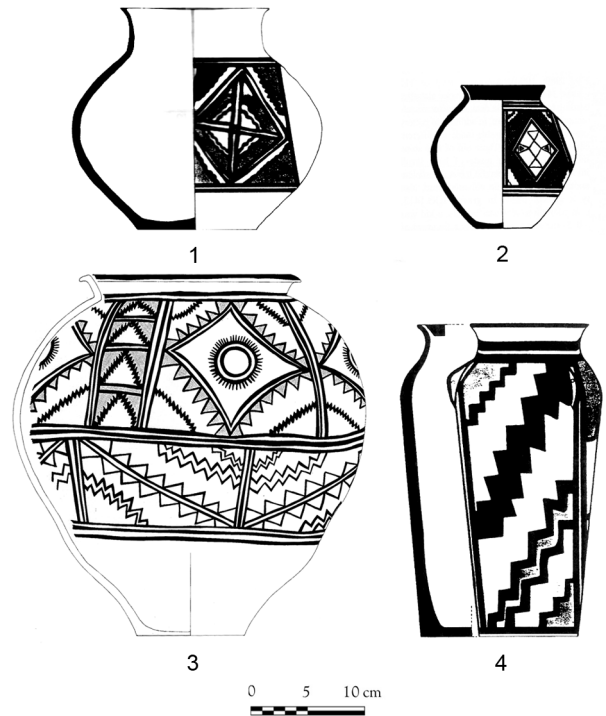

Fig. 7 – Polychrome ware from Shahr-i Sokhta II (SALVATORI and VIDALE, 1997: fig. 161; SAJJADI, 2003: fig. 30).

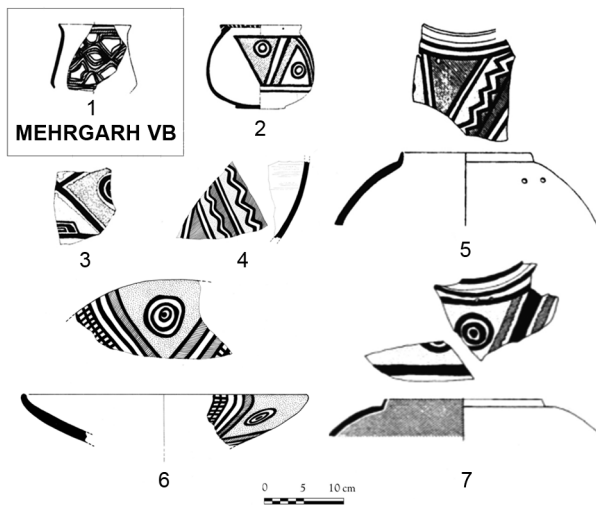

Fig. 8 – Polychrome ware from Mehrgarh VB, VIIA-B and from Nausharo IA-B (drawings MAI).

most of the polychrome pottery are related to the pottery of Shahr-i Sokhta II (fig. 8: 2-7).

Thus the study of technical skill can bring a major contribution to a better understanding of the interactions between the sites of the Indo-Iranian regions. This is true for other craft activities such as bead manufacturing, including the production of steatite faience beads that occurs at the beginning of Mehrgarh VI⁶⁴ and at Mundigak IV, and as metallurgy characterized by the early lost-wax casting technique. An exceptional discovery is the ovoid weight with handle found in a Period IIIa tomb from Shahi Tump (Makran).⁶⁵ This artifact with a lead core consists of a cast jacket in copper-lead alloy (the whole weighs more than 15 kg). It is ornamented with leopard and goat motifs made in incrustated shells.

For the pottery, the wide distribution of *Nal* polychrome ware and the production of the Dasht plain and Shahr-i Sokhta II polychrome vessels occurred at the same time around 3000 BC and in the same areas as the development of the *Faiz Mohammad* and *Emir grey* wares. Rita Wright has shown that these grey wares are relevant to the same technical tradition.⁶⁶ The *Emir Grey Ware* is present on many sites of the Dasht plain in Makran Period IIIb (2800-2600 BC),⁶⁷ at

Bampur I-IV,⁶⁸ and at Shahr-i Sokhta II;⁶⁹ the *Faiz Mohammad Grey Ware* with its rich variety of geometric, animal and plant designs, is well attested at Mehrgarh VI-VII and Nausharo I.⁷⁰ The levels of Mundigak IV also provided several fragments of *Faiz Mohammad Grey Ware*⁷¹ which were probably imports from the production centre of the Kachi-Bolan region, as for Shahr-i Sokhta.⁷²

Other links can be established between Shahr-i Sokhta and several production centres of fine grey ware in Balochistan. It may be the case with the very few sherds of incised grey ware found in the levels of the Period IV Burnt Building at Shahr-i Sokhta.⁷³ The incised grey ware has often been considered as typical of South-Eastern Iran and Oman and as a good marker to give “a first glimpse of the wide interaction area in which Shahr-i Sokhta is placed in late III – early II millennium BC”.⁷⁴ More recently the discovery of incised grey ware in Makran shows that this type of pottery occurs from Period IIIb (*ca* 2800-2600 BC) in the Dasht Plain⁷⁵ and is also represented in the following Period IIIc (*ca* 2600-2500) at Miri Qalat.⁷⁶ Even if a very few samples of incised grey ware are still attested in the levels of Miri Qalat Period IV, it is worth pointing out that the closest parallels with the incised grey ware of Shahr-i Sokhta are precisely found at Miri Qalat IIIc.⁷⁷

Without further developing this subject, we wish to stress that when good chronological evidence is available, it is possible to clearly observe on several sites of the Indo-Iranian regions the successive and cumulative appearance of technical innovations occurring in productions which are sometimes different stylistically but similar in their technology. We may then better analyse the phenomena of multi-directional interaction and exchange between Southern Balochistan (Makran), Sistān, the Mundigak region, Central and Eastern Balochistan and the sites of the Indus valley during the centuries that preceded the beginning of the Indus civilization.

64. Barthélemy de Saizieu, 2003 : 30-31.

65. Mille *et al.*, 2005: 236-244.

66. Wright, 1984.

67. Besenval et Didier, 2004 : fig. 16.

68. De Cardi, 1970: 257-265 and 279-291, figs. 16-26.

69. Salvatori and Vidale, 1997: figs. 187, 191, 223-227.

70. Jarrige *et al.*, 1995: figs. 2.21-2.23, 3.13-3.14.

71. Casal, 1961 : fig. 87.

72. Piperno and Salvatori, 1983: fig. 11.

73. Biscione, 1979: 293.

74. *Ibid.*

75. Didier, 2007.

76. Besenval et Didier, 2004 : 169-170 and fig. 13.

77. Didier, 2007 : fig. 307-311 ; Besenval et Didier, 2004: 169-172 and fig.13.

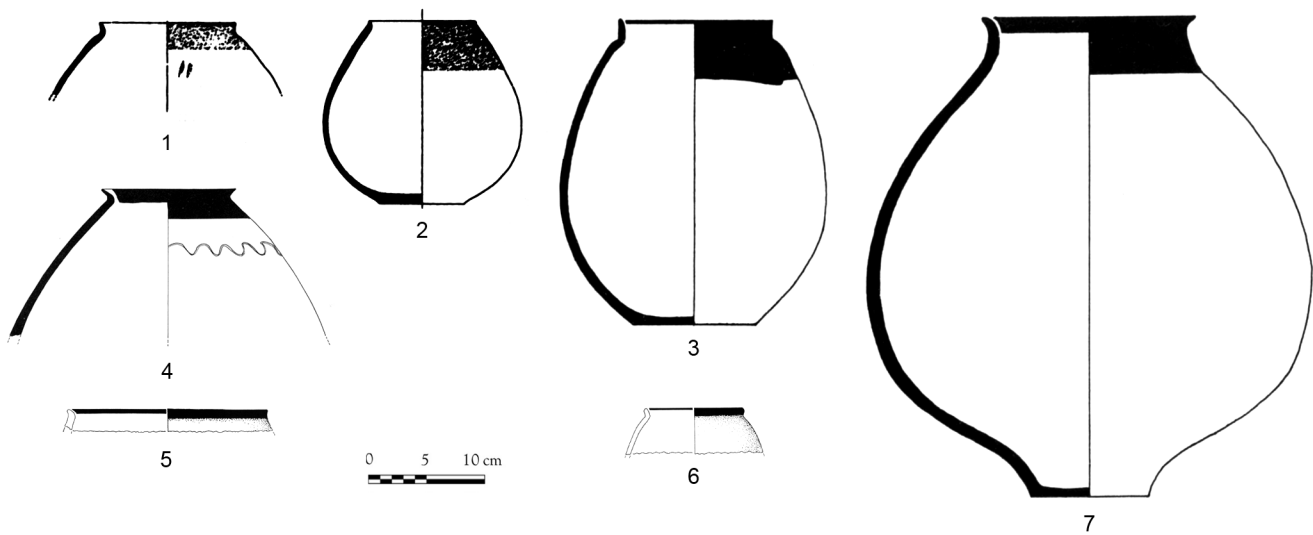

Fig. 9 – Kot-Diji pottery. **1-2**, Ceramics from Mehrgarh VIIA/B (drawings MAI); **3, 7**, Ceramics from Nausharo I (JARRIGE, 1993: fig. 1); **4**, Ceramic from Mundigak IV.1 (CASAL, 1961: fig. 75.249); **5-6**, Ceramics from Harappa 1-2 (DALES, 1991: fig. 5.3).

“HELMAND VERSUS INDUS”

To complete this brief summary, we should point out that, in their article, our Italian colleagues emphasize the relations between the sites of the Helmand system and those of the Indus valley in the part subtitled “*Helmand versus Indus*”.⁷⁸ The term “Indus” also includes Balochistan. We agree with the links, which we ourselves often observed, between Shahr-i Sokhta I, II and III and Mundigak III and IV and between the sites of Balochistan and the Indus valley at the end of the 4th millennium and in the first half of the 3rd millennium BC. The authors declare:

“In fact J.-F. Jarrige and other scholars, on the basis of their sound knowledge of the ceramic sequence of the region and specific ceramic comparisons, have considered Shahr-i Sokhta Period III as contemporary with the Kot-Dijian phase of the core area (*i.e.* with Period II at Harappa, ascribed by a consistent series of calibrated ¹⁴C dating to the range of 2800-2600 BCE).”⁷⁹

Periods I, II and III of Shahr-i Sokhta and Periods III and IV of Mundigak should indeed be placed in the same chronologi-

cal horizon between about 3100 and 2600 BC. However, in the following points of the article, the authors attempt to extend these comparisons up to the context of the second half of the 3rd millennium BC.

It is difficult for us to accept the authors’ use of the term “Kot Dijian” to qualify all the cultural assemblage that, in Balochistan and in the Indus valley, preceded the Indus civilization. Kot Diji is an Indus valley site excavated by F.A. Khan in the second half of the 1950s and early 1960s.⁸⁰ The levels of Kot Diji I, prior to the Indus civilization, yielded many examples of jars with rims encircled by a painted brownish-black band. Afterward, it became customary to use these vessels to define a *Kot Diji* style, with numerous examples found on several sites of the Indus valley and Balochistan. Thus, at Mehrgarh VII⁸¹ and at Nausharo, especially in Period I, several *Kot Diji* jars were found among many other vessels with different types of decoration corresponding to styles associated with various names according to the different scholars (fig. 9: 1-3, 7). Some of these *Kot Diji* jars are also present at Mundigak IV.1 (fig. 9: 4) and at Harappa in the Period 1 and 2 levels which also precede the beginning of the Indus civilization⁸² (fig. 9: 5-6).

Without going beyond the scope of this article, it is worth reminding how the archaeology of the Indo-Iranian regions

78. Cortesi *et al.*, 2008: 9-10.

79. *Ibid.*: 9.

80. Khan, 1965.

81. Jarrige *et al.*, 1995: 236, fig. 4.18c.

82. Dales, 1991: 64-65, fig. 5.3.

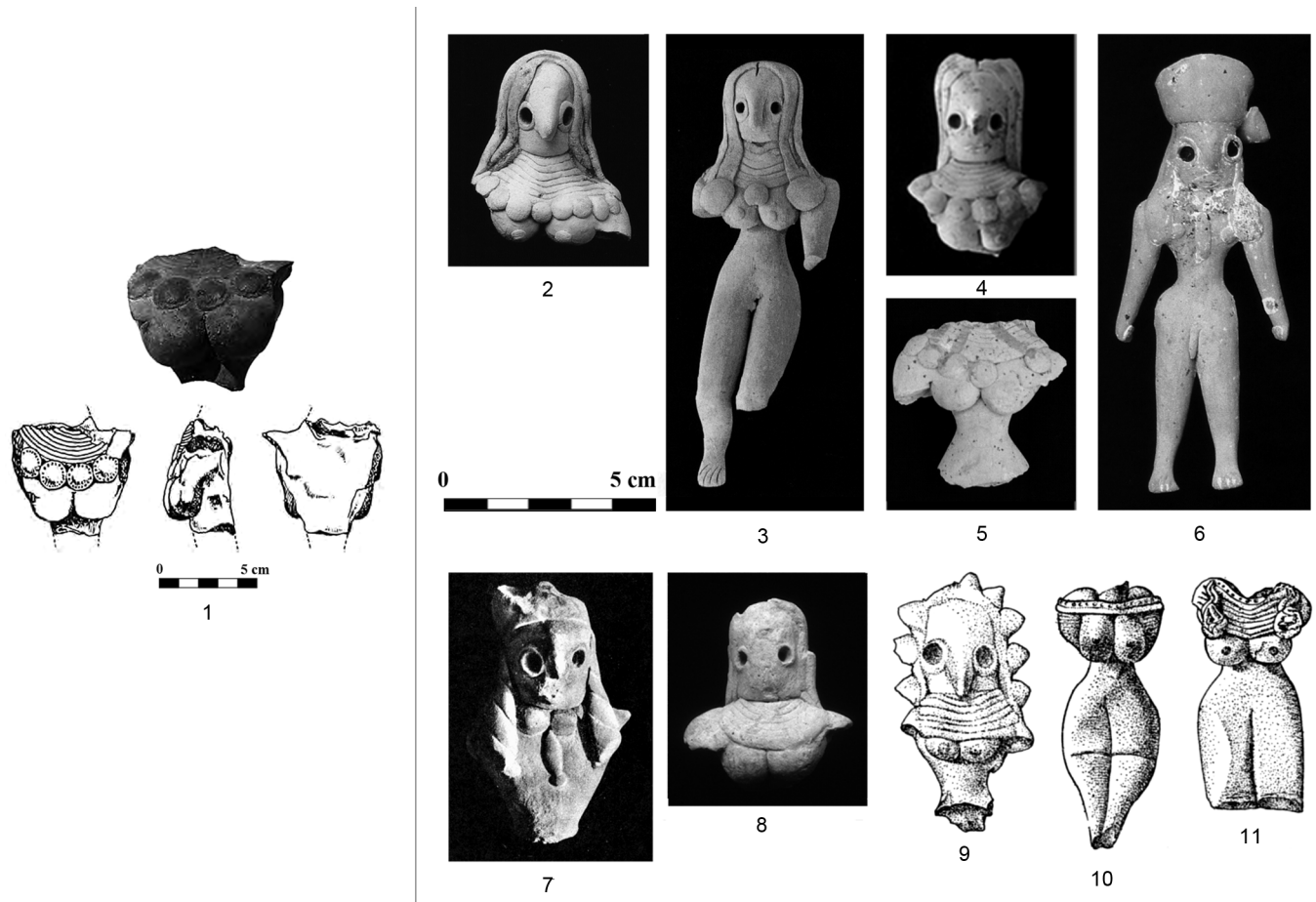

Fig. 10 – Terracotta female figurines. **1**, Figurine from *Shahr-i Sokhta II* (CORTESE et al., 2008: fig. 11); **2-6**, Figurines from Mehrgarh VII (photos MAI); **7-8**, Figurines from Mundigak (CASAL, 1961: pl. XLI, 8-9); **9-11**, Figurines from Damb-Sadaat II-III, site Q8 (FAIRSERVIS, 1956: fig. 16).

has often remained confused due in particular to the use of pottery categories or styles to define distinct cultural horizons. In the domestic contexts or in the potter's area from Mehrgarh, Nausharo or Lal Shah, the pottery reflects the stylistic and technical diversity of productions manufactured in the same workshops. It is important to stress the point that there is no reason for classifying the first 3rd millennium sites in Balochistan or in the Indus valley in a single chrono-cultural phase called "Kot Diji". Although a few examples of *Kot Diji* jars were found at Mundigak IV⁸³ (fig. 9: 4), this site has provided many more ceramic comparisons with Mehrgarh VII and Nausharo I, including the stepped and bracketed motifs of the *Quetta ware* and several obviously imported examples of *Faiz Mohammad* and *Emir grey wares* not represented at Kot Diji or Harappa.

83. Jarrige, 1993: 153.

The diversity of these productions, lying in a common technical skill, does not allow them to be unified under the name of a single site. The existence of a so-called "Kot Dijian" cultural entity would imply that sites such as Kot Diji or the "Kot Dijian levels" of Harappa, Period 2 would have played a more crucial role in the development of the Indus civilization than other sites for instance in lower Sind or along the western borders of the Indus valley. In an article based upon the study of several thousand ceramic vessels from Nausharo and other Indus sites, G. Quivron has clearly demonstrated the existence of a first "Harappan" style of which there is evidence in an obviously identical chronological context at Nausharo Period II, in the deepest levels of Chanhu-daro, at Amri IIIA as well as at Harappa 3A.⁸⁴

84. Quivron, 2000.

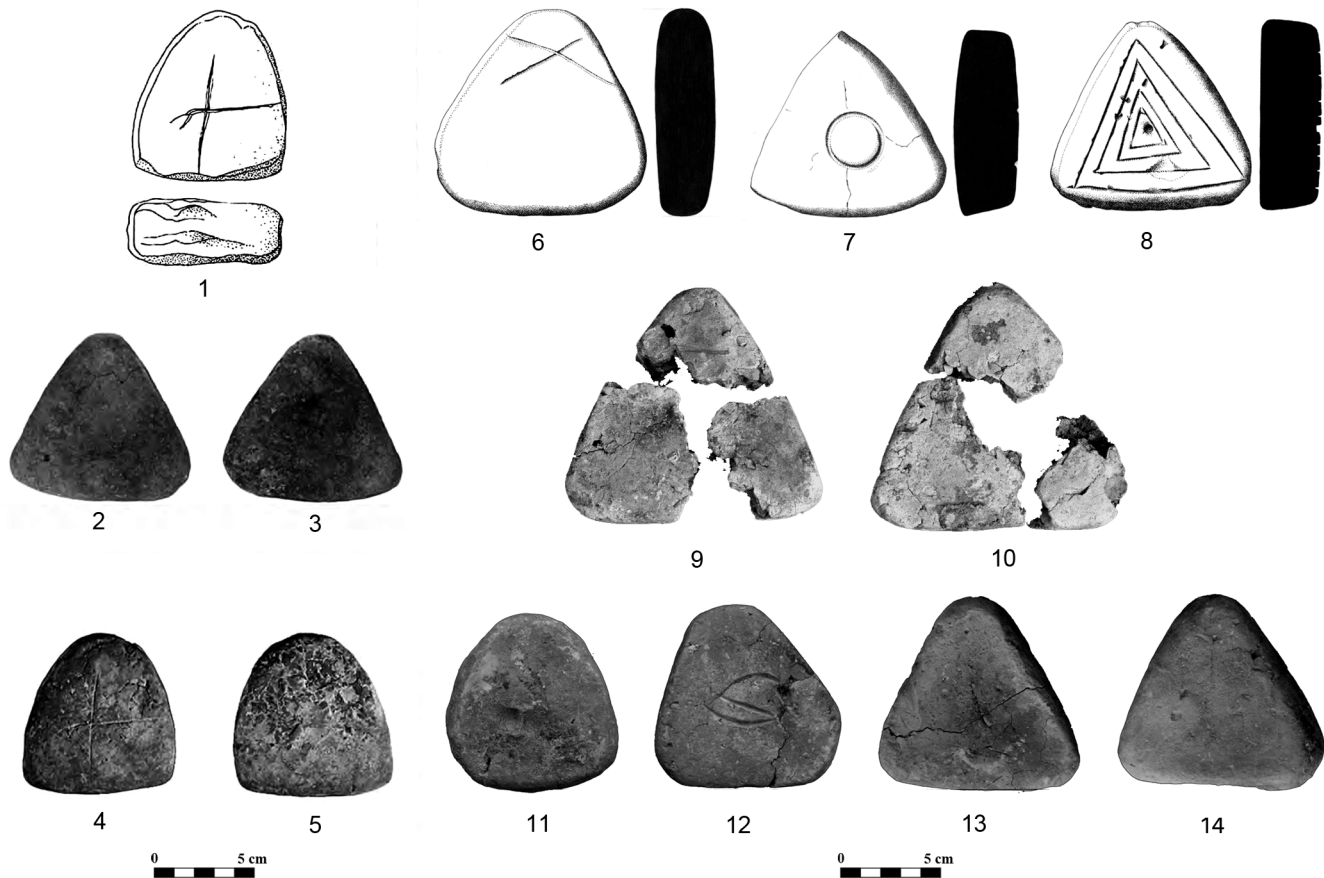

Fig. 11 – Terracotta cakes: 1-5 from Shahr-i Sokhta II-III (CORTESI et al., 2008: fig. 12); 6-14 from Nausharo IB-IC / Mehrgarh VII (drawings and photos MAI).

“ZHOB-LIKE FRAGMENTARY CLAY FIGURINE” AND “TERRACOTTA CAKES”

From these available chronological elements, the parallels rightly established between the possible imported objects from Shahr-i Sokhta and various finds from Balochistan and the Indus valley fit perfectly into the temporal framework of the first half of the 3rd millennium BC. This is particularly true for the human figurines of *Zhob* type found at Shahr-i Sokhta II⁸⁵ (fig. 10: 1), at Mundigak IV⁸⁶ (fig. 10: 7-8) and at Deh Morasi Ghundai⁸⁷ (Kandahar, Afghanistan) which correspond to well-known examples recorded in large numbers at Mehrgarh VII

(fig. 10: 2-6) and at Nausharo I.⁸⁸ The *Zhob* figurines, according to a terminology established by Fairservis⁸⁹ from the excavations at Damb Sadaat (fig. 10: 9-11), appear to be imported objects from Balochistan, perhaps more typical of the Kachi-Bolan area than of the *Zhob* valley. At Nausharo, they occur in the levels preceding Period ID (2600-2500 BC). Period ID has provided human figurines of a characteristic style different from those of Mundigak and Shahr-i Sokhta objects.

Concerning the triangular terracotta cakes, it is true that for a long time they have been considered as emblematic elements of the Indus civilization. This probably has led our Italian colleagues to present examples found at Shahr-i Sokhta as “not unknown in the Indus Valley”⁹⁰ (fig. 11: 1-5). The triangular

85. Tosi, 1983: pl. LXIX, 61.

86. Casal, 1961 : pl. XLI.8-9.

87. Dupree, 1963 : 92-98, fig. 8.

88. Jarrige C., 1988, 1997 and 2008.

89. Fairservis, 1956: 224-226, fig. 16; Fairservis, 1959: 361.

90. Cortesi et al., 2008: 17.

and oblong terracotta cakes were discovered in hundreds of thousands on the different Indus sites, including Nausharo II and III. The authors point out, as we have done before,⁹¹ that these cakes could have been items for storing heat and used to heat water and food. Such indirect heating techniques have been documented as early as Mehrgarh Neolithic in the 7th millennium BC. The latter has provided circular hearths dug into the floor and filled with burnt pebbles or, in one case, with fired oblong terracotta nodules.⁹² Still today in Balochistan, bread is occasionally baked by laying the dough on heated pebbles. At Mehrgarh I to VII and at Nausharo I, large amounts of pebbles were used as processes of indirect heating.

With the emergence of the Indus civilization, triangular cakes and oblong rolls have replaced pebbles in the hearth zones of Nausharo Period II. Once broken, these cakes were used as foundation beds upon which buildings, streets and alleys were built. However, triangular cakes were already found in the levels of Period VII at Mehrgarh⁹³ and at Nausharo I, in a context prior to the Indus civilization (fig. 11: 6-14). It is worth pointing out that they are very close by their sizes to the examples published by E. Cortesi *et al.* in figure 12, which come from Shahr-i Sokhta II, III and IV. One of these cakes (fig. 11: 1) shows an incised sign that can be compared to an example from Nausharo IC (fig. 11: 6). Other Shahr-i Sokhta cakes have seal impressions, suggesting that they might have had an administrative role.⁹⁴ Although Cortesi *et al.* assign Periods III and IV of Shahr-i Sokhta to the second half of the 3rd millennium, we think that the cakes presented in their article belong to the same tradition as in Nausharo or elsewhere during the first half of the 3rd millennium BC and that they do not provide a convincing argument to attribute some of them to a context contemporaneous with the Indus civilization. It is however difficult to explain the relation between the cakes of the first half of the 3rd millennium from Balochistan and their mass production during the Indus civilization.

“THE LATER PHASE OF PERIOD III”: A CRITICAL RE-EXAMINATION OF THE DATING OF PERIODS III-IV AT SHAHR-I SOKHTA

Although they assign the beginning of Shahr-i Sokhta Period III (phase 4) to 2500 BC, our Italian colleagues consider the existence of a later phase of this Period III (phase 3) that could date “between approximately 2350 and 2200 BCE”.⁹⁵ On a previous occasion,⁹⁶ we have already raised several arguments to question this late dating. It is obvious that the Indus civilization did not appear *ex nihilo* but was rooted in an earlier local context. Among the numerous “Harappan” elements that pre-existed, especially in the Kachi-Bolan region, before the Indus civilization, we may list the pottery decorated with intersecting circles, a whole variety of pipal leaves or with fish scale motifs, open bowls decorated on the internal surface with radiating motifs incised with reeds, and perforated jars. At Nausharo II, which corresponds to the very first phase of the Indus civilization, many elements of the cultural assemblage can be linked with models known in the earlier levels of period ID and even in the earlier levels of periods IB and IC between 2800 and 2600/2500 BC.⁹⁷ Therefore, few elements from Mundigak IV.3, that Casal has connected to the Indus civilization, find very clear parallels in the context of Nausharo IC and Mehrgarh VIIC as well as at Lal Shah, a site of potter’s kilns near Mehrgarh.⁹⁸

In this period marked by the generalization of the fast wheel technique,⁹⁹ we can also notice the presence of large bowls decorated on the internal surface with stylized pipal leaves arranged in large volutes (fig. 12). These bowls are particularly numerous at Lal Shah¹⁰⁰ (fig. 12: 1) and at Nausharo IC (fig. 12: 4-5), and are also found at Rehman Dheri III¹⁰¹ (fig. 12: 2), at Mundigak IV¹⁰² (fig. 12: 7) and at Miri Qalat IIIc, in a context earlier than 2500 BC¹⁰³ (fig. 12: 6). A fragment of a similar bowl was also found in the Burnt Building of Shahr-i

91. Jarrige J.-F., 1988: 75.

92. Jarrige *et al.*, 1995: 455.

93. *Ibid.*: 237, fig. 4.19b.

94. Cortesi *et al.*, 2008: 17.

95. *Ibid.*: 9; Salvatori and Tosi, 2005.

96. Biscione, 1990 ; Jarrige, 1993.

97. Jarrige, 1989, 1990 and 1996.

98. Pracchia, 1985.

99. An entire category of vessels was detached using a wire from a wheel still in rotation as indicated by concentric traces impressed on the bases. This operation required expert manipulation to remove the vessels without deforming them.

100. *Ibid.*: 462, fig. 4A.

101. Durrani, 1988: figs. XXXVII-XXXVIII.

102. Casal, 1961 : fig. 94.

103. Besenval et Didier, 2004 : fig. 8.2, 9.2; Didier, 2007 : fig. 205-206.



Fig. 12 – Bowls and dishes decorated with vegetal motifs. **1**, Ceramic from Lal Shah, Period Nausharo IC (PRACCHIA, 1985: fig. 4a); **2**, Ceramic from Rehman Dheri IIIB, scale not available (DURRANI, 1988: Pl. XXXVII); **3**, Ceramic from Shahr-i Sokhta IV, Scale not available (BISCIONE, 1990: fig. 6); **4-5**, Ceramics from Nausharo IC (drawing MAI); **6**, Ceramic from Miri Qalat IIIc (BESEVAL and DIDIER, 2004: fig. 8.2); **7**, Ceramic from Mundigak IV.3 (CASAL, 1961: fig. 94.429); **8, 10**, Ceramics from Shahr-i Sokhta IV, Grave 1705, n° 32 and 21 (SAJJADI, 2003: fig. 17); **9**, Ceramic from the Dasht Plain (Makran), Period IIIb (drawing MAFM); **11**, Ceramic from Mehrgarh VIIA/B (drawing MAI).

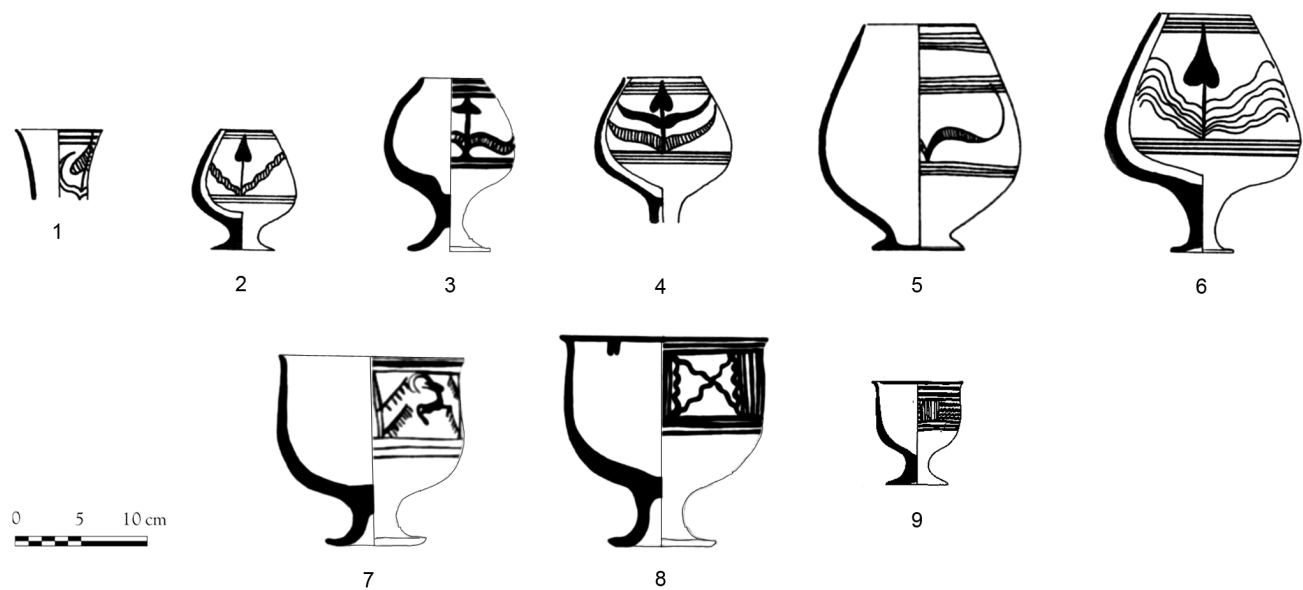

Fig. 13 – Pedestal beakers decorated with geometric and naturalistic motifs. **1, 5**, Ceramics from Nausharo IC (drawings MAI); **3, 7-8**, Buff ware from Shahr-i Sokhta IV, Grave 731, n° 8094, 8081, 8059 (PIPERNO and SALVATORI, 2007: fig. 675); **2, 4, 6, 9**, Ceramics from Mundigak IV.1 (CASAL, 1961: fig. 65.179, 181-182, fig. 66.192).

Sokhta IV (phase 2)¹⁰⁴ (fig. 12: 3), which establishes without any doubt the contemporaneity between Periods III and IV at Shahr-i Sokhta, Lal Shah and Mehrgarh VIIC, between 2800 and 2600 BC.

More recently the excavations conducted by S.M.S. Sajjadi in the graveyard of Shahr-i Sokhta from 1997 to 2000¹⁰⁵ have revealed a series of tombs dated to Period IV. Tomb 1705 has provided a bowl decorated inside with stylized pipal leaves arranged in large volutes in the same style as the bowl mentioned above (fig. 12: 8), and very similar to the examples from Lal Shah and Nausharo IC.¹⁰⁶ Other pipal designs found on bowls in tomb 1705 (fig. 12: 10) are obviously very close to decorations characteristic of the same area in Balochistan¹⁰⁷ (fig. 12: 9, 11). These significant and complex designs cannot be submitted to a fortuitous comparison, unlike the simple geometric motifs.

The Shahr-i Sokhta tombs dated to Period IV have thus yielded vessels that may be definitely related to Lal Shah and its pottery kilns, Mehrgarh VIIC, Nausharo IC, Miri Qalat IIIc

as well as Mundigak IV.3. It is quite natural that the Period III levels of Shahr-i Sokhta, which can be assumed to be earlier than those of Period IV, offer evident comparisons with the preceding period on the mentioned sites. Considering the later phase of Shahr-i Sokhta Period III, the authors refer in particular to the grave goods from tomb 731.¹⁰⁸ This tomb contained several footed beakers widespread in the Indo-Iranian regions during the first half of the 3rd millennium BC. (fig. 13: 3, 7-8). One of these beakers (fig. 13: 3) is decorated with a whole leaf with stem symmetrically framed by two volute leaves. These vessels are among the most emblematic pottery of Mundigak IV.1¹⁰⁹ (fig. 13: 2, 4, 6) and the specimens found in tomb 731 are very likely imports from the Mundigak area. Beakers with leaf motifs were also discovered at Nausharo I (fig. 13: 1, 5).

Another bowl with a decoration of fish among aquatic plants¹¹⁰ (fig. 14: 1) is also very close to examples from Pakistani Balochistan and from Mundigak (fig. 14: 2-3, 6, 8). This iconography is often found on bowls in *Faiz Mohammad Grey ware*, well represented in the levels of Mehrgarh VIIA and B

104. Biscione, 1990: figs. 5a, 6, 8.

105. Sajjadi, 2003.

106. *Ibid.*: figs. 17, 22e.

107. *Ibid.*: fig. 22f.

108. Cortesi *et al.*, 2008: 24-25; Piperno and Salvatori, 2007: 287-295.

109. Casal, 1961 : fig. 63-65.

110. Piperno and Salvatori, 2007: fig. 681.

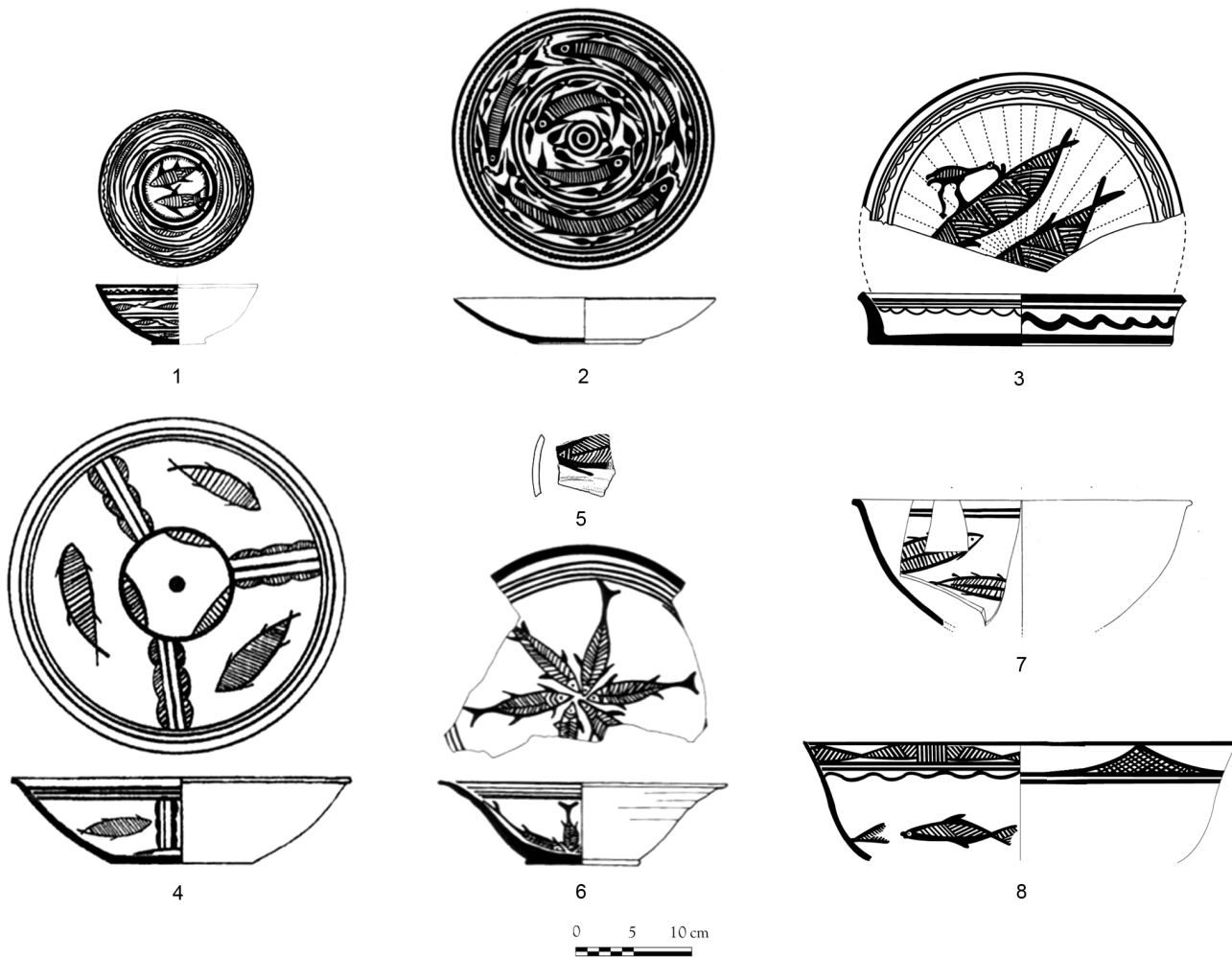

Fig. 14 – Ceramics with “fish” motifs. **1**, Buff ware bowl from Shahr-i Sokhta IV, Grave 731, n° 8075 (PIPERNO and SALVATORI, 2007: fig. 681); **2**, Faiz Mohammad Grey ware from Mehrgarh VIIA/B (drawing MAI); **3**, Streak burnished ware dish from Miri Qalat IIIc (BESEVAL and DIDIER, 2004: fig. 9.5); **4**, Buff ware bowl from Shahr-i Sokhta IV, Grave 1705, n° 50 (SAJJADI, 2003: fig. 17); **5**, Surface potsherd from Shahr-i Sokhta (CORTESI et al., 2008: fig. 7.4); **6**, Bowl from Nausharo IC (drawing MAI); **7**, Pinkish buff bowl from Mundigak IV.2 (CASAL, 1961: fig. 92.398); **8**, Fine ware bowl from the Dasht Plain (Makran), Period IIIb (drawing MAFM).

and at Nausharo IA and IB (fig. 14: 2), but also in the *Emir Grey ware* from Pakistani Makran (fig. 14: 8). In Makran, it is precisely in Period IIIb (2800-2600 BC) that many bowls in *Emir* pottery decorated with fish motifs¹¹¹ occur, while plant motifs are particularly well represented on bowls and dishes from Period IIIc (2600-2500 BC) (fig. 14: 6). It is important to remember that a few sherds of *Faiz Mohammad* and *Emir*

Grey wares occur in the levels of Mundigak IV.1. They are considered to be imports from Balochistan at the time of Mehrgarh VIIA and VIIB.¹¹²

111. Didier, 2007 : fig. 104.

112. Wright, 1995: 662-671.

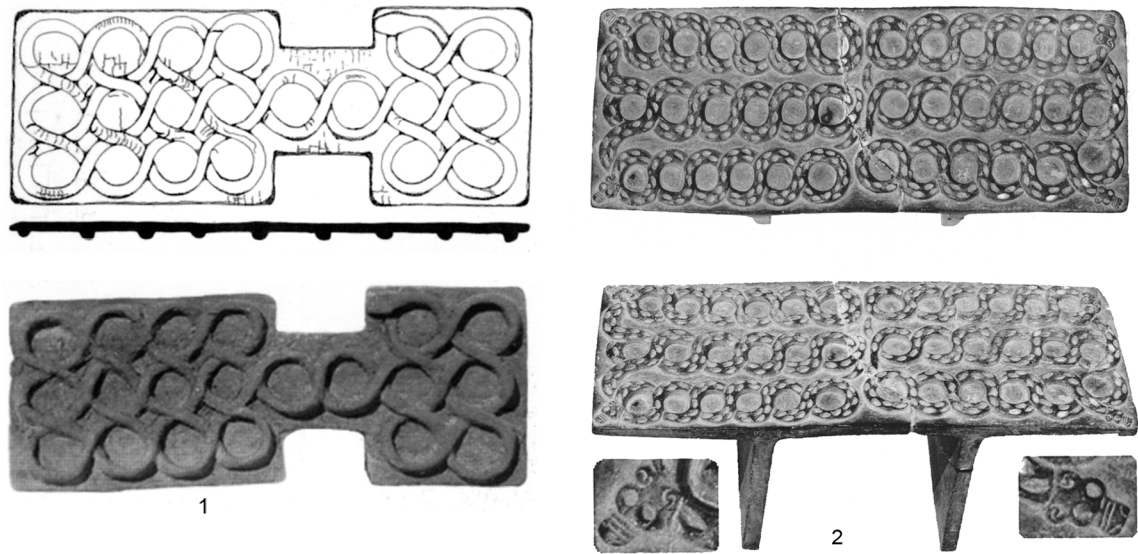

Fig. 15 – Parallels between Shahr-i Sokhta and Jiroft objects. **1**, Wooden game-board from Shahr-i Sokhta IV, Grave 731, n° 8087, Scale not available (PIPERNO and SALVATORI, 2007: fig. 691); **2**, “Chlorite” board from Jiroft, Scale not available (MADJIDAZADEH, 2003: 108).

“GAMING PIECES AND DICE”

Other artefacts seem to justify, for the authors, a late dating for tomb 731, contemporary to the Indus civilization, especially the wooden game elements.¹¹³ The game-board found in tomb 731 (fig. 15: 1) consists of small circular spaces formed by the interlacing of a snake and is reminiscent in its shape of one of the game discovered in the royal tombs at Ur. However, it has no known equivalent in the Indus valley, which has produced examples of terracotta game-boards with incised compartments at Mohenjo-Daro¹¹⁴ and at Lothal.¹¹⁵ In contrast, a chlorite tray set on two feet was found among objects probably coming from looted tombs in the Jiroft area (south-eastern Iran).¹¹⁶ Its surface is covered with interlacing snakes which form circular concavities, very similar to the wooden game-board from Shahr-i Sokhta (fig. 15: 2). It is difficult to date the chlorite objects from irregular excavations, but it is interesting to note here that a chlorite fragment decorated with a lion mane in the same style was discovered at Nausharo IC (around 2700 BC) (fig. 16). Concerning the pieces in wood or stone associated with this game-board, they might be considered as

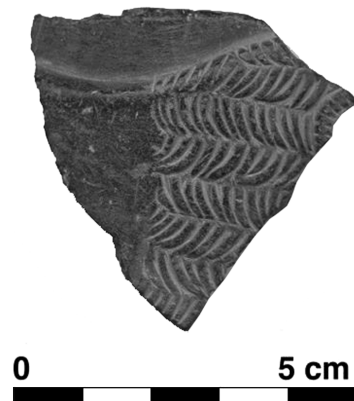

Fig. 16 – Fragment of “chlorite” vessel from Nausharo, Period IC (photograph MAI © C. JARRIGE).

prototypes of game pieces in bone or ivory still used nowadays, and common to the Indus and Oxus civilizations. However, we can notice that there is no example of sticks or long dice decorated with an incised ‘X’ motif in the Indus civilization, similar to the example of Shahr-i Sokhta. Cubic dice in wood have also been discovered at Shahr-i Sokhta IV.¹¹⁷ Although no game board is recorded at Mehrgarh or Nausharo, we have to

113. Cortesi *et al.*, 2008: 24-27, figs. 19-21.

114. Mackay, 1937: pl. CXLII.

115. Rao, 1973: pl. XXXIIIID.

116. Madjidzadeh, 2003: 108.

117. Tosi, 1983: 174, fig. 10.

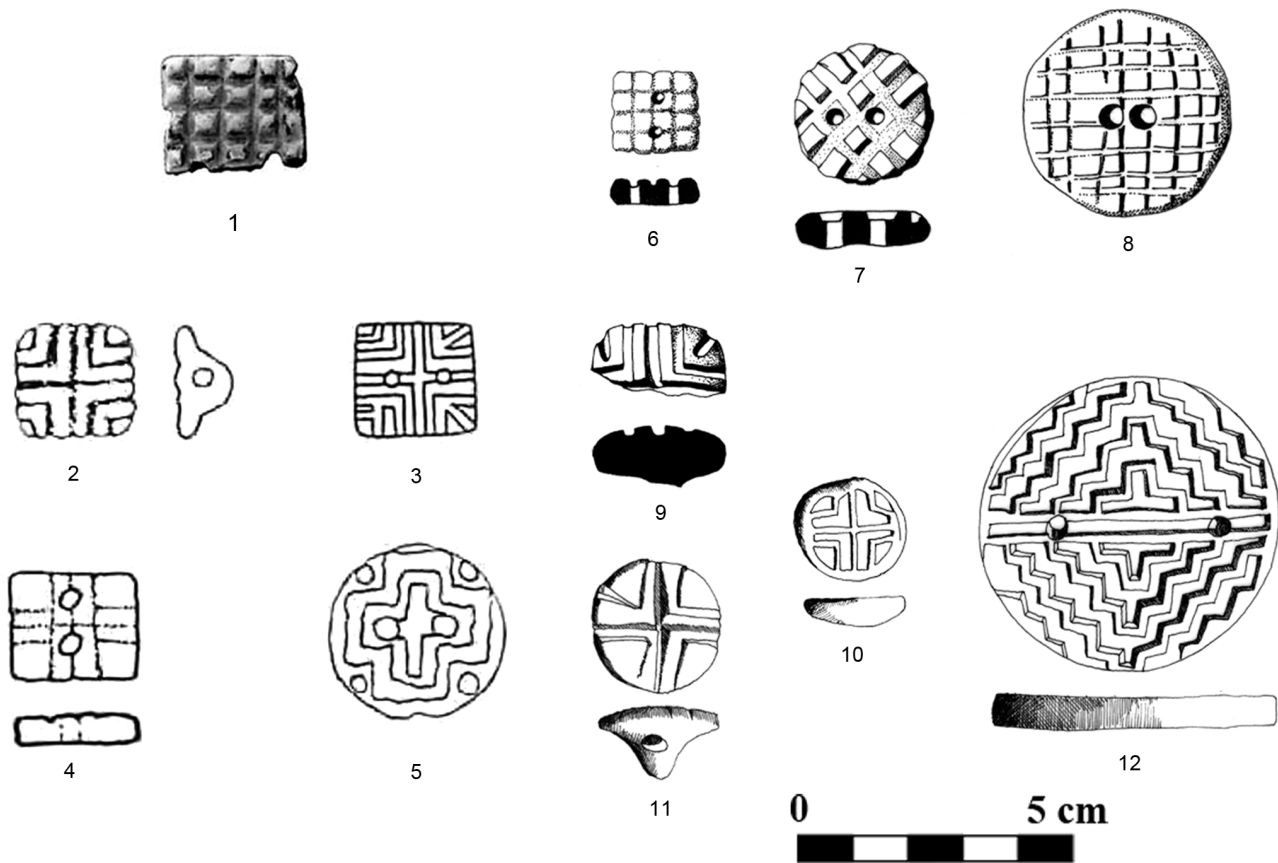

Fig. 17 – Parallels between *Shahr-i Sokhta I-IIIa* surface seals 1-5 (CORTESEI et al., 2008: fig. 13, 1 and fig. 15, 1-2, 4, 8) and *Nausharo I* terracotta seals 6-12 (drawings MAI).

emphasize the discovery of terracotta pawns that could have been used on a game surface, either drawn on the ground or on perishable materials. It is important to remember that Shahr-i Sokhta is one of the few sites in which wood is particularly well preserved thanks to the dry air. It is indeed quite possible that some of the ivory dice from Indus sites can be related to an earlier tradition, in which the use of wood would be frequent. But there is no reason to believe, as we have already indicated, that the Indus civilization has invented everything.

“MOUSETRAPS”, “STONE STATUES OF KNEELING PERSONAGES” AND “BEADS”

This is also true for other artefacts mentioned in the article, such as the discoid beads in steatite which have been pro-

duced as early as the beginning Neolithic in Mehrgarh, the seals (fig. 17) and the mousetraps. For each of these objects, especially the mousetrap dating to Period IV at Mundigak,¹¹⁸ the two fragments of a trap from Bampur, site Y (level 2),¹¹⁹ and the incised seals, we have examples from levels well dated to earlier periods than the Indus civilization.¹²⁰ Possible links between the few stone sculptures found in the Indo-Iranian regions and in the Indus valley have often been made, but we must remind that the statuette in steatite sometimes called the “priest-king” is firmly situated in the last great phase of the Indus civilization, in the upper levels of Mohenjo-daro, during

118. Casal, 1961 : 145-146, fig. 84.314.

119. De Cardi, 1970: 327.

120. *Ibid.*: 250-251; the author states that the pottery of site Y-L2 of Bampur, found in the same context as the two fragments of the mousetrap, should be placed in relation with the period III pottery of site Z, which corresponds to a context dated to around 2800-2700 BC.

a period of strong interactions between the Oxus civilization and the Indus civilization.¹²¹ This period is also marked by the “treasure” of Quetta, the graveyards of Mehrgarh VIII and Dauda Damb and by the occupation layers of Sibri.¹²² There is thus no reason to systematically link the stone head from Mundigak¹²³ to this late cultural horizon corresponding to the end of the 3rd millennium and very beginning of the 2nd millennium BC.

A SO-CALLED “FRAGMENT OF AN INDUS BLACK-ON-RED PAINTING JAR” AND “A STEATITE CYLINDER-SEAL WITH AN INDUS INSCRIPTION”

A further argument that might prove that Shahr-i Sokhta could have been a site partly contemporary to the Indus civilization is provided by a potsherd illustrated in figure 7, 5b of Cortesi *et al.*' article in *Paléorient*. This figure shows a jar with a concavo-convex profile typical of the second period of the Indus civilization at Nausharo III, while in the first Indus Period (Nausharo II), this type of shape is squatter.¹²⁴ This shape was reconstructed from a small body sherd without rim or bottom coming from a surface collection at Shahr-i Sokhta. The potsherd is decorated with a quadruped beneath a sun and above a criss-cross band. It should be pointed out that there is no similar decoration in the pottery corpus of the Indus civilization so far recorded. The relatively numerous examples of this type of jar in the Indus sites are decorated with well-known motifs, usually combinations of intersecting circles, plant friezes and peacocks. Considering the very small size of the potsherd, there is no need to insist on the fact that a great variety of spherical jars existed from all the periods and this find is unfortunately not associated to a context which could allow to define its chronological horizon.

It is also well-known that seals from the Indus civilization have been recorded as far as in Mesopotamia. A fragment of a cylinder seal published by R. Knox,¹²⁵ which presents six signs vaguely similar to those found on the Indus seals, is mentioned by the authors as an obvious evidence of contact between Sistān and the Indus civilization. Quoting R. Knox, the authors remind that this object was collected in 1906 dur-

ing a topographical mission led by General MacMahon to define the frontiers of the British Raj from Swat to Sistān. This object is compared with finds such as a cylinder-seal and an amulet with Indus signs discovered at Sibri in the Kachi-Bolan region. It is important to notice that, around 2000 BC, the Kachi-Bolan region is marked by the settling of groups whose cultural assemblage is obviously connected to the Oxus civilization. This is particularly true in the graveyard of Mehrgarh VIII,¹²⁶ but also at Nausharo Period IV that have brought evidence of interaction between these groups related to the Oxus civilization and the population of the Indus civilization. In his survey in Afghan Sistān, G. Dales has also found several objects related to the Oxus civilization.¹²⁷ But no find showing connection with the Oxus civilization has been so far reported at Shahr-i Sokhta or elsewhere in the Iranian Sistān. Therefore, it is likely that the cylinder seal combining Indus and “Oxus” features mentioned above has been collected by General MacMahon in Afghan Sistān.

Future research will perhaps enable to discover occupations from the second half of the 3rd millennium BC in the regions of Helmand, near Shahr-i Sokhta or Mundigak. Such evidence could throw light on possible interactions between these regions and the Indus civilization, as well as with the sites of the “Oxus” cultural complex or with south-eastern Iranian sites such as Shahdad. But, in the present state of our knowledge, the current available data do not enable to consider that one of the great highways of interaction between the Indus civilization and Mesopotamia could have been marked by sites such as Mundigak and Shahr-i Sokhta.¹²⁸ It is likely that these sites were no longer occupied, while the route of exchanges was lined up in south-eastern Iran with sites such as Shahdad, Tepe Yahya and the Jiroft area.

“THE HELMAND CIVILIZATION, BALUCHISTAN AND THE INDUS VALLEY” BEFORE THE EMERGENCE OF THE INDUS CIVILIZATION

Research in the Indo-Iranian regions, in particular Balochistan and Southern Afghanistan, has often led the scholars to discern “Harappan” elements in the material assemblages discovered in these regions. This is true of W.A. Fairservis

121. Jarrige and Quivron, 2008.

122. Jarrige and Usman-Hassan, 1989.

123. Casal, 1961 : pl. XLII-XLIV.

124. Quivron, 2000.

125. Knox, 1994: 373-378.

126. Jarrige, 1989: 150-166.

127. Dales, 1972: 14-40; Dales, 1977: 17-27.

128. Wright, 2010: 228.

in his explorations of the regions of Quetta, Loralai and the valley of the Zhob.¹²⁹ “Harappan” occupations have existed in Balochistan, for example at Nausharo, as well as at Dabar Kot, a site discovered by Aurel Stein,¹³⁰ and also on a site of the Ispelaji basin, south of the Quetta plateau, where we ourselves collected some Indus pottery. But the few potsherds found on the sites located in the highlands of Balochistan, that Fairservis qualified as “Harappan”, are limited to fragments of bowls with radiating motifs incised with reeds and to perforated jars.¹³¹ Such elements, which are now well documented at Mehrgarh VII and at Nausharo I as we mentioned above, have led Casal to wrongly believe in a possible “Indus” influence during Period IV.3 at Mundigak.

The excavations at Nausharo have provided evidence of a transitional period (Nausharo ID) between the final occupation of Mehrgarh (Period VIIC), contemporary with Nausharo IC, and the beginning of the Indus occupation (Nausharo Period II). This Period ID which can be dated to between 2600 and 2500 BC, in spite of an obvious continuity with the preceding Period VIIC at Mehrgarh and IC at Nausharo, is marked by major changes such as the disappearance of motifs from the *Quetta-Damb Sadaat* tradition and of the polychrome decorations as well as the typical *Kot Diji* jars. But one notices the development of shapes and motifs heralding the “Harappan” pottery of Nausharo II. It is highly probable that the equivalent of this Period ID material would be found, probably on a larger scale, if the deep levels of the sites in the Kachi plain, such as Pathani Damb and Judeiro-daro, of Chanhudaro in the Sind and maybe of Mohenjodaro, could be excavated. It should be recalled that, in a 1967 article long before the discovery of Nausharo, Fairservis stressed the fact that the Kachi region, bordered by the ancient bed of the Indus, the “hollow of Sind”, is a favourable area to provide significant information on the context related to the emergence of the Indus civilization.¹³²

If many parallels have been established between Shahr-i Sokhta III and IV, Mundigak IV and several sites in Balochistan at the time of Mehrgarh VII A-C and Nausharo I A-C, it is no longer the case with Nausharo ID. We have already stated that the human figurines from Shahr-i Sokhta or Mundigak related to the so-called *Zhob* style display connection only with figurines from Mehrgarh VII and Nausharo IA-C and never with the new types occurring in Nausharo Period ID. The explorations carried out by Fairservis in the high valleys of Quetta, in

Loralai and Zhob regions, indicate that occupation on many sites belonging to the *Quetta-Damb Sadaat* III cultural complex apparently ended rather abruptly. To explain this phenomenon, it has been suggested, following Sir Mortimer Wheeler¹³³ that the development of the Indus civilization has led to the disappearance of the cultures in the highlands and foothills of Balochistan. But we know today that some of the phenomena that appear to have affected the valleys and plateaus of Central and Northern Balochistan occurred before the establishment of the cultural assemblage characteristic of Nausharo ID, and thus before the Indus civilization itself in its classic form (Nausharo II). It is likely that these transformations, which occur around 2600 BC, are significant elements for a better comprehension of the genesis of the Indus civilization. But it can also be assumed that such phenomena including the abandonment of several sites in the highlands of Balochistan have also to be accounted to understand the lack of data concerning the vast area of the Helmand system in the course of the second half of the 3rd millennium BC.

Of course Balochistan did not become deserted with the emergence of the Indus civilization. In the southern part of this province, in the Jhalawan region, the original Kulli culture shows an evident cultural and economic dynamism throughout the second half of the 3rd millennium BC.¹³⁴ In Makran, Indus occupations have been recorded at several sites such as Sotkako and Sutkagen-Dor, and Miri Qalat Period IV.¹³⁵ At Miri Qalat IV, most of the pottery belongs to the Indus style but also includes a local pottery in direct line from Periods IIIb and IIIc vessels.¹³⁶ Most of the previous ceramic groups are represented, including the painted grey ware. Among it, several fragments of canister pots were found, comparable with examples found in Iran at Bampur and in the Oman Peninsula.¹³⁷ It is worth mentioning the existence of a “canister pot” decorated with ibexes in the Period V levels of Shahr-i Sokhta IV¹³⁸ (fig. 18: 1).

The canister pot of Shahr-i Sokhta (MAI 3335)¹³⁹ was discovered in 1969 on the floor of the room CXXXIX in the last occupation phase of the Burnt Building.¹⁴⁰ It is a medium/

129. Fairservis, 1956: 226, 230, 329, 341, 352, 355, 357-360 and pl. 15; Fairservis, 1959: 291-292, 364.

130. Stein, 1929.

131. Fairservis, 1956: 355-356.

132. Fairservis, 1967.

133. Wheeler, 1950.

134. Quivron, 2008; Jarrige *et al.*, 2011.

135. Besenval, 1997a: 27-28.

136. Besenval et Didier, 2004: 175; Didier, 2007.

137. Didier et Mutin, in press: fig. 7.

138. Tosi, 1983: pl. XXXII, fig. 55.

139. A. Didier would like to thank Prof. M. Tosi and Dr. A. Lazzari to have given access, with the permission of the Museo Nazionale d'Arte Orientale (MNAOR) in Rome, to the canister pot of Shahr-i Sokhta.

140. Biscione, 1979: 293-294, figs. 3-4; Lamberg-Karlovsky and Tosi, 1973: fig. 64; Tosi, 1976: 85, figs. 3-4; Tosi, 1983: figs. 8 and 55.

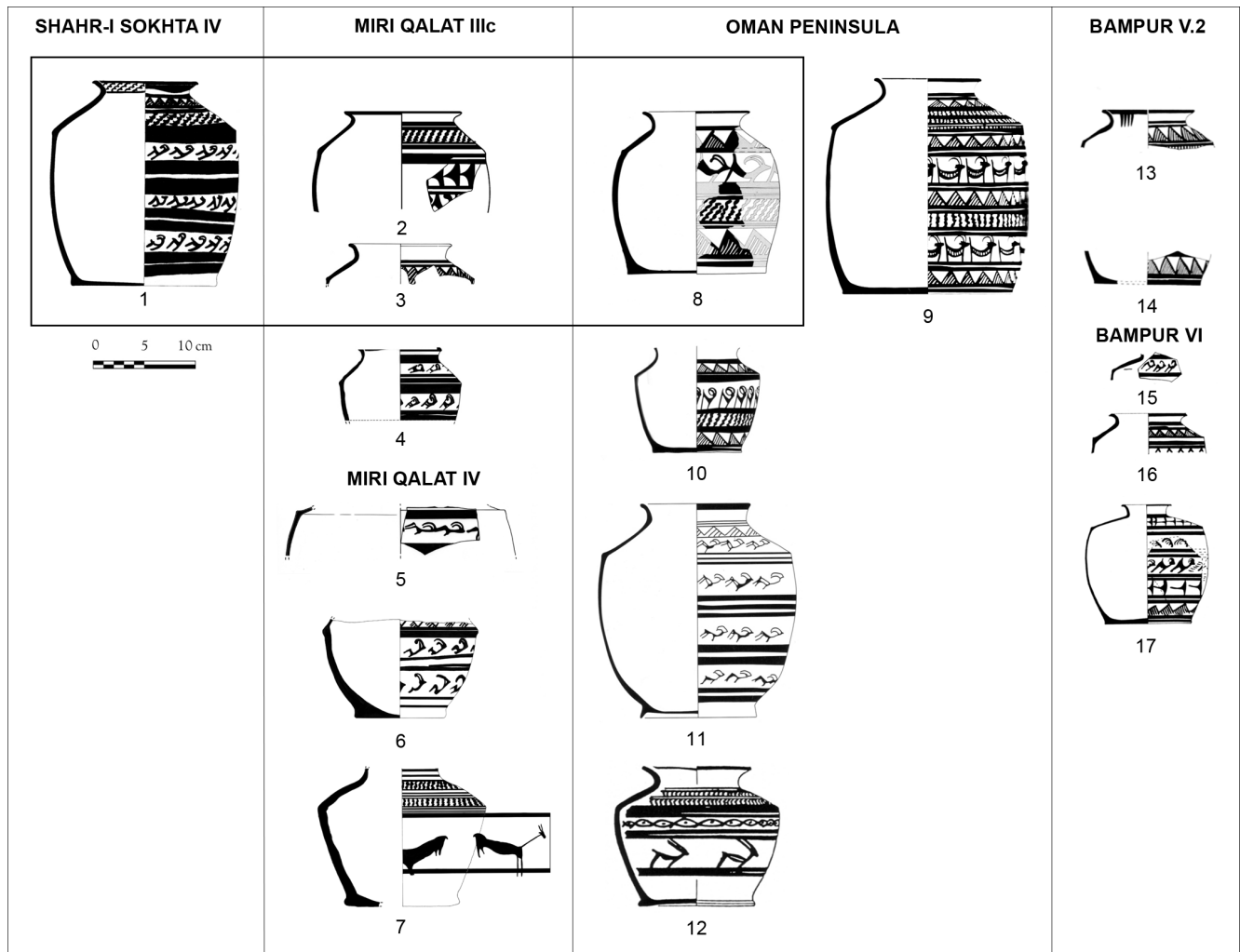

Fig. 18 – Parallels between canister pots decorated with ibex motifs. **1**, Ceramic from Shahr-i Sokhta IV (TOSI, 1983: fig. 55); **2-7**, Ceramics from Miri Qalat IIIc and IV (drawings MAFM); **8**, Ceramic from Hili, tomb M (VOGT et al., 2011: fig. 53, HM/v55); **9-10**, Ceramics from Hili, tomb 1059 (BIBBY, 1966: fig. 11); **11**, Ceramic from Hili, tomb B (AL-TIKRITI, 1981: Pl. 81H, 3); **12**, Ceramic from Hili Nord, tomb A (VOGT et al., 2011: fig. 204, DLA/v260); **13-14**, Ceramics from Bampur V.2 (DE CARDI, 1970: fig. 38.361-362); **15-17**, Ceramics from Bampur VI (DE CARDI, 1970: fig. 43.477, 479, 481).

high vase (16.5 cm) with a cylindrical body and a raised short neck with everted thin-rounded rim. The base is discontinuous with a flat to slightly convex bottom. The decoration painted in dark brown on the whole external surface consists of three superimposed friezes of stylized ibexes separated by sets of two horizontal bands. The division in different registers by the horizontal bands precedes the frieze execution. The ibex posture (with raised-hind legs meaning the running movement) is characteristic of the mid-3rd millennium figurative system in the iconography of South-Eastern Iran and South-Western

Pakistan.¹⁴¹ The execution of the animal motifs is very repetitive. Potters have first drawn the “U- or V-shaped” body from tail to head (sometimes including one horn), then added horns and the legs. Beneath the undulating and horizontal bands painted on the rim and the neck, the shoulder displays a frieze of hatched triangles and a frieze of slanted spirals composed of

141. Before, ibexes are often combined with geometric motifs and generally depicted in more fixed gesture.

small stylized triangles. The internal surface bears a frieze of slanted spirals or loops delimited by two bands.

The dating of the canister pot found at Shahr-i Sokhta poses some questions if we consider the ceramic parallels with Iran, the Oman Peninsula and Makran. M. Tosi first has pointed out with good reason “direct connections with Bampur and the Umm an-Nar graves”.¹⁴² The canister pot of Shahr-i Sokhta shows indeed links in the decoration with a vase from Bampur VI¹⁴³ (fig. 18: 17) even if the vessel shape is different. The neck is larger, the shoulder less high and the walls less convex. Another fragment of canister pot displays the same shape at Bampur VI,¹⁴⁴ but this type of vase is also known at Bampur V.2¹⁴⁵ (fig. 18: 13-14). In the Oman Peninsula, several canister pots decorated with friezes of caprids, triangles and spirals were found in Tombs B¹⁴⁶ and 1059¹⁴⁷ at Hili, and in tomb A of Hili Nord, dated to the second half of the 3rd millennium BC (fig. 18: 9-12). However, the best parallel, both in shape and decoration, is a vase discovered in Tomb M at Hili dated to between 2600 and 2500 BC on the basis of the pottery study¹⁴⁸ (fig. 18: 8). The material assemblage from tomb M is connected with phases IIB-IIC1 at Hili 8 and cairns II and V at Umm an-Nar. “Aucune poterie de la tombe M n'évoque (...) les assemblages de la fin du III^e millénaire av. J.-C.”¹⁴⁹ In Makran, fragments of canister pot decorated with friezes of caprids occur at Miri Qalat IV (fig. 18: 5-7), but the shapes are different with a truncated-conical body or with a marked *careen* such as Bampur VI. The best parallels identified for the vase of Shahr-i Sokhta are in Period IIIc (2600-2500 BC), for which several canister pots in grey ware with a similar decoration were found (fig. 18: 2-3). There is thus no reason to exclusively associate this vessel to a context dating to the end of the 3rd millennium or very beginning of the 2nd millennium BC, while its shape and its decoration show close comparisons with material assemblages from the previous period. The typo-chronological study of the canister pots in Makran (from the material of Periods IIIb, IIIc and IV) obviously reveals a morphological evolution that tends to wide-mouthed pots with short neck, convex walls and flat bottom in Period IIIb (2800-2600 BC) to pots with truncated-conical body and everted discontinuous bottom in Period IV (2500-2300 BC). Besides, it is important to notice that the incised grey ware, the ridged ware, the fragment

of painted pottery dish discovered in the same Burnt Building of Shahr-i Sokhta IV,¹⁵⁰ that are obviously all connected with a pottery tradition from south-eastern Iran (site of Bampur) and from Pakistani Balochistan, always find good ceramic parallels at Miri Qalat IIIc. It is also true for many vessel shapes in plain red ware and for the development of the streak-burnishing treatment at Shahr-i Sokhta IV, which presents the same technical characteristics as in Miri Qalat Period IIIc.

CONCLUSION

To sum up, the chronological framework based on a large amount of data in Balochistan or in the Indus valley enables to define reliable cultural periods from Mehrgarh Neolithic, during the last centuries of the 8th millennium BC, to the end of the Indus civilization in the beginning of the 2nd millennium BC. It is thus necessary to put aside the old models of Sir Mortimer Wheeler's time,¹⁵¹ stressing the so-called division and isolation of the different geographic entities of Balochistan and neighbouring areas. Beyond the diversity of the craft productions from many sites, which doubtlessly reflect local identities, broad factors of unity clearly appear on the scale of the Indo-Iranian regions. One of the most significant features is the progressive setting of complex technical knowledge over time, which appears to be synchronous at several sites of different regions. We have insisted on the fact that heating techniques for steatite beads were established at Mehrgarh as early as the Neolithic; then in the 5th millennium BC, during Period III with glazed beads, lost-wax copper objects and fine pottery using rotating technique. In the 4th millennium BC, the Makran pottery differ from that of the Mehrgarh region, but in these same periods, several common elements can be pointed out: the fineness of the ceramic paste, the use of a rotating support in shaping vessels, and the high level of expertise in the preparation and fixation of the coloured pigments. The concomitant appearance of the *Faiz Mohammad* and *Emir grey wares* with their outstanding technical and esthetical quality is also very significant. As another example is the kiln area of Lal Shah, near Mehrgarh, and of Rud-i Biyaban, near Shahr-i Sokhta. These two important pottery areas display the more common use of fast wheel, probably around 2800 BC, and similar technical knowledge and *chaînes opératoires*. These transformations, often related to craftsmanship of high quality,

142. Tosi, 1976: 85, fig. 4 ; Lamberg-Karlovsky and Tosi, 1973: fig. 6.

143. De Cardi, 1970: fig. 43, 481.

144. *Ibid.*: fig. 43, 477.

145. *Ibid.*: fig. 38, 361-362.

146. Al-Tikriti, 1981: Pl. 81H.

147. Bibby, 1966: fig. 11; Tosi, 1976: fig. 4.

148. Vogt, Cleuziou et Méry, 2011: 66-68.

149. *Ibid.*

150. Biscione, 1979: figs. 1-6.

151. Wheeler, 1950.

have indeed to be studied within a concordance of time which careful examination is probably among of the most efficient ways towards a better understanding of the prehistoric archaeology of the Indo-Iranian regions, but also of the socio-cultural background of the Indus civilization.

Although praising the remarkable contribution brought by the Italian mission at Shahr-i Sokhta and now by the Iranian mission, we have seen that none of the arguments reviewed in this article can sustain in a conclusive way that “the stressed importance of the chronology disagreement on Shahr-i Sokhta III is thus proved”. The assumption that Periods III and IV at Shahr-i Sokhta would be contemporary with Harappa 3C and therefore with Nausharo IV or Amri IIIC does not so far lie on any convincing argument. How could it be possible that Mehrgarh VII, Nausharo I, Makran IIIB and IIIC, Mundigak IV, which are obviously contemporary, if we take into account a large amount of data, with Shahr-i Sokhta III and IV, could be later than the two first major phases of the Indus civilization at the time of Nausharo II-III, Harappa 3A-B or Amri IIIA-B? It cannot be excluded that in the near future finds showing connections with the Indus and the Oxus civilizations or with south-eastern Iranian sites occupied at the end of the 3rd millennium BC such as Shahdad will be recorded in Iranian Sistān. But, this is not yet the case.

Jean-François JARRIGE
Aurore DIDIER
Gonzague QUIVRON

CNRS – UMR 9993

Centre de recherches archéologiques Indus-Balochistan,

Asie centrale et orientale

« Panthéon Bouddhique » – 19, avenue d'Iéna

75116 Paris – FRANCE

jean-francois.jarrige@udr1.cnrs.fr

aurore.didier@udr1.cnrs.fr

gonzague.quivron@udr1.cnrs.fr

GLOSSARY OF POTTERY STYLES MENTIONED IN THE TEXT

Aliabad: Distinctive pottery style defined by J.R. Caldwell from the ceramic material found at Aliabad, and identified at Tal-i Iblis IV in the Bard Sir valley (Kerman, Iran) (Caldwell, 1967: 75-79, 182-201). It includes two main painted pottery types: *Aliabad Painted* (decorated with straight, curved and wavy lines) and *Aliabad Bichrome* painted in brown, red and black. Although this pottery

style needs further investigations, several evidences tend to date this production to the mid-4th millennium BC (Mutin, in press).

Emir grey: Group of fine black-painted grey ware first noted by Sir A. Stein in Sistān and defined by Fairservis (Fairservis, 1956: 86). It mainly includes bowls, beakers, small-mouthed globular and canister pots painted with geometric (straight lines, bands, friezes of triangles, diamonds...) and naturalistic decorations (caprids, fish, hatched leaves, palms leaves or palm trees). The main production centre of *Emir grey* ware is the Makran region in South-Western Pakistani Balochistan, but its distribution extends to Iranian Sistān, Southern Afghanistan (Mundigak), South-Eastern Iran (Bampur valley, Kerman) and the Oman Peninsula. It is traditionally dated to the first half of the 3rd millennium BC. For a full description, see Wright, 1984; Didier, 2007; Besenval et Didier, 2004.

Faiz Mohammad grey: Fine grey ware painted in black or dark red and named for the site on which the vessels were found (Fairservis, 1956: 263, fig. 55). *Faiz Mohammad* grey ware includes bowls, beakers and pots and is decorated with a great variety of geometric, animal and plant motifs in a style inherited from the Quetta tradition. It is mainly manufactured in the Kachi-Bolan, Quetta, Zhob and Loralai regions (eastern Pakistani Balochistan), but was also found at Mundigak and in Sistān. At Mehrgarh, it occurs in Period VI-VII contexts (3100-2600 BC). For a full description, see Wright, 1984 and 1995; Jarrige *et al.*, 1995.

Geoksyur: Geoksyur, an oasis site located in the ancient Tedjen Delta (southern Turkmenistan), gives its name to a style of fine painted pottery of the Namazga III period (second half of the 4th millennium BC). The monochrome or polychrome decorations include mainly geometric designs (stepped motifs often compared to the Quetta pottery), but also stylized goat designs (Khlopin, 1964; Masson and Merpert, 1982). *Geoksyur* pottery is found from the Kopet Dagh Piedmonts (Southern Turkmenistan) to Sarazm (Tajikistan).

Kechi Beg polychrome: Pottery style defined by Fairservis (Fairservis, 1956: 259, fig. 53) which spreads over a vast area from southern Afghanistan (Kandahar region) to eastern (Quetta valley, Zhob and Loralai regions), and central-southern Pakistani Balochistan (Surab and Nal regions in the districts of Sarawan and Jhalawan). It is a fine buff pottery manufactured with coil-building and wheel-throwing techniques combined into a single sequence and decorated with a great variety of geometric designs (bands, wavy lines, hatched triangles and diamonds, circles, stars, pendant loops, zigzag and crenellated bands, checked squares), and rare floral motifs painted in black and red or brownish red. At Mehrgarh, it is dated to between 3600 and 3100 BC.

Kili Ghul Mohammad/Togau: The style of *Kili Ghul Mohammad* was defined from the excavations of Kili Ghul Mohammad I and II in the Quetta valley (Eastern Pakistani Balochistan) (Fairservis, 1956: 256-257, fig. 50b). It is a fine or medium-coarse red ware painted in black with simple geometric designs. Forms include bowls and ovoid pots. *Togau* is a fine black-painted pottery defined by B. De Cardi (De Cardi, 1965: 128-232), which spreads from southern Afghanistan (Mundigak region) and eastern Balochistan (Kachi-Bolan region) to central/southern Balochistan (Surab, Jhalawan, and Makran regions) and the Indus valley (Amri). De Cardi has distinguished four stages (A-D) in the evolution of the *Togau* pottery. *Kili Ghul Mohammad* and *Togau* are traditionally considered as the first painted pottery styles in Balochistan.

The excavations conducted at Mehrgarh have shown that both are in fact variants of the same ceramic tradition from early Chalcolithic (Mehrgarh Period III: 5th millennium to mid-4th millennium BC) (Jarrige, 2008: 18-19). In the first phase (Mehrgarh IIIA), forms are very limited (open bowls, globular jars) and decorations are simple (chevrons, hatched panels). Then (Mehrgarh IIIB, Togau A), the decorations include a great variety of geometric (Maltese crosses, rosettes, triangles, diamonds) and naturalistic (stylized caprids, birds, gazelle) designs. During Period IIIC (Togau B-C), the number of patterns is subsequently reduced, the motifs tend to be more geometrized (animals are reduced to stylized head and horns), and the first anthropomorphic decorations occur. At the end of Period IIIC, we also notice the appearance of friezes of hook characteristic of Togau C-D and the first bichrome ware. Togau E is a variant from South-Eastern Balochistan decorated with "mere stroke" (Franke, 2008: 654).

Kot Diji: Red pottery type found at Kot Diji I in the Indus valley (Khan, 1965: 42-43, pl. XVII-XXV) and dated to the first half of the 3rd millennium BC (2800-2600 BC). It is mainly characterized by neckless wide-mouthed globular jars decorated with fugitive bands painted in black, red or brownish red on the rim. The vessel is wheel-made and cream-slipped. It occurs in a great part of the Indus valley and in Eastern Balochistan. Other specimens (dishes-on stand, globular and biconical jars) are decorated with fish-scale motifs, intersecting circles, flowers and horned creatures.

Jemdet Nasr: The typical assemblage of Jemdet Nasr style was found on the eponymous site in south-central Iraq. It is generally dated to 3100-2900 BC and includes monochrome and polychrome pottery decorated with both geometric and figurative designs (Field and Martin, 1935; Matthews, 1992). Its distribution extends to Mesopotamia, Iran, the Oman Peninsula and southern Afghanistan (Mundigak).

Nal polychrome: Fine buff pottery painted in black, red, yellow and turquoise and characterized by complex geometric patterns arranged in friezes and metopes and by abstract figurative motifs (floral motifs, winged griffons, lions, birds, felines, bulls, human figures, and hybrid creatures) (Hargreaves, 1929; Franke, 2008: 661-662). It is mainly produced in the Nal region in Jhalawan (central/southern Pakistani Balochistan) between 3100 and 2700 BC, but its distribution extends over a vast area from South-Eastern Iran to Eastern and Southern Balochistan.

Quetta-Damb Sadaat: Black-on buff ware (wheel-manufactured), well-known for its typical steppe motifs found at Damb Sadaat II (3100-2700 BC) in the Quetta valley (Fairservis, 1956: 255-256, figs. 48-49, designs 108-469). It also includes a great variety of geometric and naturalistic motifs arranged between multiple rows of horizontal lines. Other production centres are attested in the Kachi-Bolan, Zhob and Loralai regions. It is distributed from Southern Afghanistan to Central Balochistan.

BIBLIOGRAPHY

AL-TIKRITI W.Y.

1981 *Reconsideration of the Late Fourth and Third Millennium BC in the Arabian Gulf, with Special Reference to the United Arab Emirates*. Unpublished PhD Thesis. Cambridge, Trinity College, University of Cambridge.

ALLCHIN B. and ALLCHIN R.

1982 *The Rise of Civilization in India and Pakistan*. Cambridge: Cambridge University Press (*Cambridge World Archaeology* 19).

AMIET P. and TOSI M.

1978 Phase 10 at Shahr-i Sokhta: Excavations in Square XDV and the Late 4th Millennium B.C. Assemblage of Sistān. *East and West* 28: 9-31.

BARTHÉLEMY DE SAIZIEU B.

2003 *Les Parures de Mehrgarh: Perles et Pendentifs du Néolithique précéramique à la Période pré-Indus. Fouilles 1974-1985*. Paris: Éditions ERC.

BARTHÉLEMY DE SAIZIEU B. and BOUQUILLON A.

1997 Evolution of glazed Materials from the Chalcolithic to the Indus Period based on the data of Mehrgarh and Nausharo. In: ALLCHIN R. and ALLCHIN B. (eds.), *South Asian Archaeology 1995*: 63-76. New Delhi: Oxford & IBH Publishing Co.

BESEVAL R.

1994 The 1992-1993 field-seasons at Miri Qalat: New contributions to the chronology of Protohistoric settlement in Pakistani

Makran. In: PARPOLA A. and KOSKIKALLIO P. (eds.), *South Asian Archaeology 1993* (vol. I): 81-91. Helsinki: Suomalainen Tiedeakatemia.

1997a Entre le sud-est iranien et la plaine de l'Indus: le Kech Makran. Recherches archéologiques sur le peuplement ancien d'une marche des confins indo-iraniens. *Arts Asiatiques* 52: 5-36.

1997b The Chronology of Ancient Occupation in Makran: Result of the 1994 Season at Miri Qalat, Pakistan, Makran. In: ALLCHIN R. and ALLCHIN B. (eds.), *South Asian Archaeology 1995*: 199-216. New Delhi: Oxford & IBH Publishing Co.

2000 New Data for the Chronology of the Protohistory of Kech-Makran (Pakistan) from Miri Qalat 1996 and Shahi-Tump 1997 Field-Seasons. In: TADDEI M. and DE MARCO G. (eds.), *South Asian Archaeology 1997*: 161-188. Rome: IsIAO (*Serie Orientale Roma* 90).

2005 Chronology of Protohistoric Kech-Makran. In: JARRIGE C. and LEFÈVRE V. (eds.), *South Asian Archaeology 2001*: 17-24. Paris: Éditions ERC.

BESEVAL R. et DIDIER A.

2004 Peuplement protohistorique du Kech-Makran au 3^{ème} millénaire av. J.-C.: l'assemblage céramique de la période IIIC sur le site de Miri Qalat. *Paléorient* 30,2: 159-178.

BIBBY T.G.

1966 The Eleventh Campaign of the Danish Archaeological Expedition, 1965. *Kuml* 1965: 75-95.

- BISCIONE R.
 1974 Relative Chronology and Pottery Connections between Shahr-i Sokhta and Mundigak, eastern Iran. *Memorie dell'Istituto Italiano di Paleontologia Umana II*: 131-145.
 1979 The Burnt Building of Period Shahr-I Sokhta IV. An Attempt of Functional Analysis from the Distribution of Pottery Types. In: GNOLI G. and ROSSI A.V. (eds.), *Iranica*: 291-306. Naples: Istituto Universitario Orientale.
 1990 The Elusive Phase 2 of the Shahr-i Sokhta Sequence. In: TADDEI M. and DE MARCO G. (eds.), *South Asian Archaeology 1987*: 391-410. Rome: IsIAO (*Serie Orientale Roma* 66).
- BONORA G.L., DOMANIN C., SALVATORI S. and SOLDINI A.
 2000 The Oldest Graves of Shahr-i Sokhta Graveyard. In: TADDEI M. and DE MARCO (eds.), *South Asian Archaeology 1997*: 495-513. Rome: IsIAO (*Serie orientale Roma* 90).
- CALDWELL J.R.
 1967 *Investigations at Tal-i Iblis*. Springfield: The Illinois State Museum Society (*Illinois State Museum Preliminary Report* 9).
- CASAL J.-M.
 1961 *Fouilles de Mundigak*. Paris : Librairie C. Klincksieck (*Mémoires de la Délégation archéologique française en Afghanistan XVII*).
 1964 *Fouilles d'Amri*. Paris: Publication de la Commission des Fouilles archéologiques.
- CORTESI E., TOSI M., LAZZARI A. and VIDALE M.
 2008 Cultural Relationships beyond the Iranian Plateau: The Helmand Civilization, Baluchistan and the Indus Valley in the 3rd Millennium BCE. *Paléorient* 34,2: 5-35.
- DALES G.F.
 1972 Prehistoric Research in Southern Afghanistan. *Afghanistan XXIV*: 14-40.
 1977 *New Excavations at Nad-i Ali (Sorkh Dagh), Afghanistan*. University of California Berkeley: Center for South and Southeast Asia (*Research Monograph Series* 16).
 1991 Some Specialized Ceramic Studies at Harappa 2. In: MEADOW R.H. (ed.), *Harappa Excavations 1986-1990. A Multidisciplinary Approach to Third Millennium Urbanism*: 61-69. Madison, Wisc.: Prehistory Press (*Monographs in World Archaeology* 3).
- DE CARDI B.
 1965 Excavation and Reconnaissance in Kalat, West Pakistan – The Prehistoric Sequence in the Surab Region. *Pakistan Archaeology* 2: 86-182. Karachi: The Department of Archaeology, Ministry of Education, Government of Pakistan.
 1970 *Excavations at Bampur, a Third Millennium Settlement in Persian Baluchistan, 1966*. New York: American Museum of Natural History (*Anthropological Papers of the American Museum of Natural History* 51, 3).
- DIDIER A.
 2007 *Archéologie des confins indo-iraniens : Étude de la production céramique du Kech-Makran (Pakistan) dans la première moitié du III^e millénaire av. J.-C.* Thèse de doctorat non publiée. Paris, Université de Paris 1 Panthéon-Sorbonne.
 In press L'utilisation de la couleur dans les céramiques protohistoriques du Balochistan pakistanais et à Mundigak (Afghanistan). Identités culturelles et traditions techniques. The Use of colour in the Protohistoric Pottery from Pakistani Balochistan and from Mundigak (Afghanistan). Cultural Identities and Technical Traditions. *Annales de la fondation Fyssen* 26.
- DIDIER A. et MUTIN B.
 In press La production céramique protohistorique du Makran pakistanaï dans la compréhension des relations indo-iraniennes. In: BENDEZU-SARMIENTO J. (éd.), *Archéologie française en Asie centrale post-soviétique. Un enjeu sociopolitique et culturel*. Paris: De Boccard, *Cahiers d'Asie centrale* 21.
- DUPREE L.
 1988 *Deh Morasi Ghundai: A Chalcolithic Site in South-Central Afghanistan*. New York (*Anthropological Papers of the American Museum of Natural History* 50,2).
- DURRANI F.A.
 1988 Excavations in the Gomal Valley: Rehman Dheri Excavation Report No. I. *Ancient Pakistan* 6: 1-204.
- FAIRSERVIS W.A. Jr.
 1956 *Excavations in the Quetta Valley, West Pakistan*. New York: American Museum of Natural History (*Anthropological Papers of the American Museum of Natural History* 45,2).
 1959 *Archaeological Surveys in the Zhob and Loralai Districts, West Pakistan*. New York (*Anthropological Papers of the American Museum of Natural History* 47,2).
 1961 *Archaeological Studies in the Seistan Basin of South-Western Afghanistan and Eastern Iran*. New York: American Museum of Natural History (*Anthropological Papers of the American Museum of Natural History* 48,1).
 1967 The Origin, Character, and Decline of an Early Civilization. *Novitates* 2302: 1-48.
- FIELD H. and MARTIN R.A.
 1935 Painted Pottery from Jemdet Nasr, Iraq. *American Journal of Archaeology* 39,3: 310-320.
- FRANKE U.
 2008 Baluchistan and the Borderlands. In: PEARSALL D. (ed.), *Encyclopedia of Archaeology 2008* (vol. 1): 651-670. New York: Elsevier.
- FRANKE-VOGT U.
 2005 Excavations at Sohr Damb/Nal: Results of the 2002 and 2004 Seasons. In: FRANKE-VOGT U. and WEISSHAAR H.-J. (eds.), *South Asian Archaeology 2003*: 63-76. Aachen: Linden Soft.
- FRANKE-VOGT U. and IBRAHIM A.
 2005 A New Perspective of an Old Site: Reopening Excavations at Sohr Damb/Nal (Balochistan). In: JARRIGE C. and LEFÈVRE V. (eds.), *South Asian Archaeology 2001*: 105-115. Paris: Éditions ERC.
- HARGREAVES H.
 1929 *Excavations in Baluchistan 1925. Sampur Mound, Mastung and Sohr Damb, Nal*. New Delhi: Government of India (*Memoirs of the Archaeological Survey of India* 35).
- ISAKOV A. et LYONNET B.
 1988 Céramiques de Sarazm (Tadjikistan, URSS) : Problèmes d'échanges et de peuplement à la fin du Chalcolithique et au début de l'âge du Bronze. *Paléorient* 14,1: 31-47.
- JARRIGE C.
 1988 Les figurines humaines au Baluchistan. In: AMIET P. (éd.), *Les Cités oubliées de l'Indus* : 65-70. Paris: Association Française d'Action Artistique.
 1997 The figurines from Nausharo, Period I and their further developments. In: ALLCHIN R. and ALLCHIN B. (eds.), *South Asian*

- Archaeology* 1995: 33-43. New Delhi: Oxford & IBH Publishing Co.
- 2008 The Figurines of the First Farmers at Mehrgarh and their Offshoots. *Pragdhara* 18: 155-166.
- JARRIGE C., JARRIGE J.-F., MEADOW R.H. and QUIVRON G. (eds.)
- 1995 *Mehrgarh Field Reports 1974-1985. From Neolithic Times to the Indus Civilization*. Karachi: The Department of Culture and Tourism, Government of Sindh.
- JARRIGE J.-F.
- 1987 Une jarre polychrome à tenon perforé de Mundigak. In: GNOLI G. and LANCIOTTI L. (eds.), *Orientalia Iosephi Tucci Memoriae Dicata*: 661-666. Rome: IsMEO (*Serie orientale* 56,2).
- 1988 Excavations at Nausharo, 1986-1987. *Pakistan Archaeology* 23: 149-203.
- 1989 Excavation at Nausharo, 1987-1988. *Pakistan Archaeology* 24: 21-67.
- 1990 Excavation at Nausharo, 1988-1989. *Pakistan Archaeology* 25: 193-240.
- 1993 The Question of the Beginnings of the Harappan Civilization as seen from the Nausharo Excavations. In: GAIL A. and MEVISSSEN G. (eds.), *South Asian Archaeology 1991*: 149-164. Stuttgart: Franz Steiner Verlag.
- 1994 The final phase of the Indus occupation at Nausharo and its connection with the following cultural complex of Mehrgarh VIII. In: PARPOLA A. and KOSKIKALLIO P. (eds.), *South Asian Archaeology 1993*: 294-314. Helsinki: Suomalainen Tiedekatemia.
- 1995 Du Néolithique à la Civilisation de l'Inde ancienne: Contribution des recherches archéologiques dans le Nord-Ouest du sous-continent pakistanais. *Arts Asiatiques* 50: 5-23.
- 1996 Les fouilles de Nausharo au Balochistan pakistanais et leur contribution à l'étude de la civilisation de l'Indus. *Académie des Inscriptions et Belles-Lettres, Comptes rendus des Séances de l'année 1996*, III: 821-877.
- 1998 The beginning of pottery in Balochistan. In: PHILLIPS C.S., POTTS D.T. and SEARIGHT S. (eds.), *Arabia and its Neighbours, Essays on Prehistorical and Historical Developments presented in honour of Beatrice de Cardi*: 327-338. Turnhout: Brepols.
- 2008 L'origine des cités de l'Indus à la lumière des fouilles de Mehrgarh et de Nausharo au Pakistan. In: GUILAINE J. (éd.), *Villes, villages, campagnes de l'Âge du Bronze*: 9-22. Paris: Errance.
- JARRIGE J.-F. and MEADOW R.H.
- 1992 Mélanges Fairservis: A Discourse on Relations between Kachi and Sindh in Prehistory. In: POSSEHL G.L. (ed.), *South Asian Archaeology Studies*: 163-178. New Delhi: Oxford & I.B.H. Publishing Co.
- JARRIGE J.-F. and QUIVRON G.
- 2008 The Indus Valley and the Indo-Iranian Borderlands at the end of the 3rd Millennium and the beginning of the 2nd Millennium B.C. In: RAVEN E.M. (ed.), *South Asian Archaeology 1999*: 60-70. Groningen: Egbert Forsten.
- JARRIGE J.-F. and USMAN-HASSAN M.
- 1989 Funerary Complexes in Baluchistan at the End of the Third Millennium in the Light of Recent Discoveries at Mehrgarh and Quetta. In: FRIFELT K. and SORENSEN P. (eds.), *South Asian Archaeology 1985*: 150-166. London: Curzon Press.
- JARRIGE J.-F., QUIVRON G., JARRIGE C., with the collaboration of HAQUET J.-F., DIDIER A. and MEADOW R.H.
- 2011 *Nindowari (Pakistan). La culture de Kulli. Ses origines et ses relations avec la civilisation de l'Indus. Nindowari (Pakistan). The Kulli Culture. Its origins and its relations with the Indus Civilization*. Paris: Gingko éditeur.
- KENOYER J.M. and MEADOW R.H.
- 1997 Excavations at Harappa 1994-1995: New Perspectives on the Indus Script, Craft Activities, and City Organization. In: ALLCHIN R. and ALLCHIN B. (eds.), *South Asian Archaeology 1995*: 139-172. New Delhi: Oxford & IBH Publishing Co.
- 2005 Excavations at Harappa 2000-2001: New Insights on Chronology and City Organization. In: JARRIGE C. and LEFÈVRE V. (eds.), *South Asian Archaeology 2001*: 207-225. Paris: Éditions ERC.
- 2008 Harappa Excavations 1998-1999. New Evidence for the Development and Manifestation of the Harappan Phenomenon. In: RAVEN E.M. (ed.), *South Asian Archaeology 1999*: 85-110. Groningen: Egbert Forsten.
- KHAN F.A.
- 1965 Excavations at Kot Diji. *Pakistan Archaeology* 2: 11-85.
- KHLOPIN I.N.
- 1964 *Geoksjurskaja grupa poselenii epoki eneolita* [Geoksiur group of sites from the Neolithic period]. Moscow and Leningrad: Nauka.
- KNOX R.
- 1994 A New Indus Valley Cylinder Seal. In: PARPOLA A. and KOSKIKALLIO P. (eds.), *South Asian Archaeology 1993* (vol.I): 375-378. Helsinki: Suomalainen Tiedekatemia.
- LAMBERG-KARLOVSKY C.C. and TOSI M.
- 1973 Shahr-i Sokhta and Tepe Yahya, Tracks on the Earliest History of the Iranian Plateau. *East and West* 23, 1-2: 21-58.
- LYONNET B.
- 1996 *Sarazm (Tadjikistan) céramiques (Chalcolithique et Bronze ancien)*. Paris: De Boccard (*Mémoires de la Délégation archéologique française en Asie centrale* VII).
- MACKAY E.J.H.
- 1937 *Further Excavations at Mohenjo-Daro*. New Delhi: Government Press.
- MADJIDZADEH Y.
- 2003 *Jiroft, the Earliest Oriental Civilization*. Tehran: Ministry of Culture and Islamic Guidance: Iran Cultural Heritage Organization Research Center.
- MASSON V.M. and MERPERT N. YA
- 1982 Eneolit Srednei Azii [Eneolithic of Central Asia]. In: MASSON V.M. and MERPERT N. (eds.), *Eneolit SSSR*: 9-92. Moscow: Nauka.
- MATTHEWS R.J.
- 1992 Defining the Style of the Period: Jemdet Nasr 1926-28. *Iraq* 54: 1-34.
- MILLE B., BOURGARIT D. and BESEVAL R.
- 2005 Metallurgical Study of the "Leopards Weight" from Shahi-Tump (Pakistan). In: JARRIGE C. and LEFÈVRE V. (eds.), *South Asian Archaeology 2001*: 237-244. Paris: Éditions ERC.

- MUGAVERO L. and VIDALE M.
2003 The Use of Polychrome Containers in the Hilmand Civilization: A Female Function? *East and West* 53: 67-94.
- MUTIN B.
2007 *Contribution à l'étude du peuplement des confins indo-iraniens au Chalcolithique: Caractérisation de la production céramique des périodes II et IIIa du Makran pakistanais (IVe millénaire av. J.-C.)*. Thèse de doctorat non publiée, Université de Paris 1 Panthéon-Sorbonne.
In press Ceramic Traditions and Interactions on the Southeastern Iranian Plateau during the 4th Millennium BC. In: PETRIE C. (ed.), *Ancient Iran and its Neighbours. Local developments and long-range interactions in the 4th millennium BC*. Oxford: Oxbow and British Institute of Persian Studies.
- PIPERNO M. and SALVATORI S.
1983 Recent Results and New Perspectives from the Research at the Graveyard of Shahr-i Sokhta, Sistan, Iran. *Annali dell'Istituto Universitario Orientale* 43,2: 173-191.
2007 *The Shahr-i Sokhta Graveyard (Sistan, Iran). Excavation Campaigns 1972-1978*. Rome: ISIAO (*Reports and Memoirs N.S. VI*).
- PRACCHIA S.
1985 Excavations of a Bronze-Age Ceramic Manufacturing Area at Lal Shah, Mehrgarh. *East and West* 35,4: 458-468.
- QUIVRON G.
2000 The Evolution on the Mature Indus Pottery Style in the Light of the Excavations at Nausharo, Pakistan. *East and West* 50, 1-4: 147-190.
2008 New light on the Kulli culture. In: RAVEN E.M. (ed.), *South Asian Archaeology 1999*: 47-59. Groningen: Egbert Forsten.
- RAO S.R.
1973 *Lothal and the Indus Civilization*. New York: Asia Publishing.
- SAJJADI S.M.S.
2003 Excavations at Shahr-i Sokhta. Preliminary report on the Excavations of the Graveyard, 1997-2000. *Iran* XLI: 21-97.
2005 *Bampur Tepe. The First Season of Excavation at Bampur Tepe*. Tehran: ICAR/ICHTO (*Archaeological Report Monograph Series*).
2007 *Excavations at Shahr-e Sukhteh. Graveyard 1997-2000. Preliminary report I* (in Persian). Tehran: Cultural and Communication Vice Directorate, Office of Cultural Affairs.
2009 *Excavations at Shahr-e Sukhteh. Second Preliminary report on the graveyard (2001-2003)*. Tehran: Iranian Center for Archaeological Research, Cultural Heritage, Handicrafts and Tourism Organization of Sistan and Baluchistan (in Persian).
- SALVATORI S. and TOSI M.
2005 Shahr-i Sokhta Revised Sequence. In: JARRIGE C. and LEFÈVRE V. (eds.), *South Asian Archaeology 2001*: 281-292. Paris: Éditions ERC.
- SALVATORI S. and VIDALE M.
1997 *Shahr-i Sokhta 1975-1978: Central Quarters Excavations, Preliminary Report*. Rome: ISIAO (*Reports and Memoirs* 1).
- SARRAF M.R.
1981 *Die Keramik von Tell-i Iblis und Ihre zeitliche und räumliche Beziehungen zu den anderen iranischen und mesopotamischen Kulturen*. Berlin: Dietrich Reimer Verlag (*AMI, Ergänzungsband VII*).
- STEIN A. (Sir.)
1931 *An Archaeological Tour in Gedrosia*. Calcutta: CPB (*Memoirs of the Archaeological Survey of India* 37).
- TOSI M.
1976 The Dating of the Umm an-Nar Culture and a Proposed Sequence for Oman in the Third Millennium BC. *The Journal of Oman Studies* 2: 81-92.
- TOSI M. (ed.)
1983 *Prehistoric Sistan I*. Rome: ISMEO (*ISMEO Reports and Memoirs* XIX, 1).
- VOGT B., CLEUZIOW S. et MÉRY S.
2011 Les premières tombes à chambres multiples : la tombe M de Hili. In: CLEUZIOW S., MÉRY S. et VOGT B. (éd.), *Protohistoire de l'oasis d'al-Aïn, Travaux de la mission archéologique française à Abou Dhabi (Émirats arabes unis). Les sépultures de l'âge du Bronze*: 41-71. Oxford (*BAR Int. Ser.* 2227).
- WHEELER M. (Sir.)
1950 *Five thousand years of Pakistan, an archaeological outline*. Karachi: Royal Book Co.
- WONG E., PETRIE C. and FAZELI H.
2010 Cheshme-Ali Ware. A Petrographic and Geochemical Study of a Transitional Chalcolithic Period Industry on the Northern Central Plateau of Iran. *Iran* XLVIII: 11-26.
- WRIGHT R.P.
1984 *Technology, Style and Craft Specialization: Spheres of Interaction and Exchange in The Indo-Iranian Borderlands, Third Millennium B.C.* Unpublished PhD Thesis. Cambridge, Mass., Harvard University.
1995 Fine ware traditions at Mehrgarh. In: JARRIGE C., JARRIGE J.-F., MEADOW R.H. and QUIVRON G. (eds.), *Mehrgarh Field Reports 1974-1985. From Neolithic Times to the Indus Civilization*: 662-671. Karachi: The Department of Culture and Tourism, Government of Sindh.
2010 *The Ancient Indus: Urbanism, Economy, and Society*. New York: Cambridge University Press.