



HAL
open science

The Qalhât Development Project and Qalhât Project : Final report on the 2013b/2014a season

Axelle Rougeulle, Magalie Dartus, Daniel Etienne, Juliette André, Guillaume Auger, Vincent Bernard, Thomas Creissen, Vladimir Dabrowski, Fabien Lesguer, Corinne Gosset, et al.

► To cite this version:

Axelle Rougeulle, Magalie Dartus, Daniel Etienne, Juliette André, Guillaume Auger, et al.. The Qalhât Development Project and Qalhât Project : Final report on the 2013b/2014a season. [Research Report] CNRS/MHC/Eveha International. 2014. halshs-03328483

HAL Id: halshs-03328483

<https://shs.hal.science/halshs-03328483>

Submitted on 3 Sep 2021

HAL is a multi-disciplinary open access archive for the deposit and dissemination of scientific research documents, whether they are published or not. The documents may come from teaching and research institutions in France or abroad, or from public or private research centers.

L'archive ouverte pluridisciplinaire **HAL**, est destinée au dépôt et à la diffusion de documents scientifiques de niveau recherche, publiés ou non, émanant des établissements d'enseignement et de recherche français ou étrangers, des laboratoires publics ou privés.

The Qalhât Development Project
Second season : October 8th – March 30th 2013

"The Qalhât Development Project and Qalhât Project"

Final report of the 2013b-2014a season

- Vol. 1 -

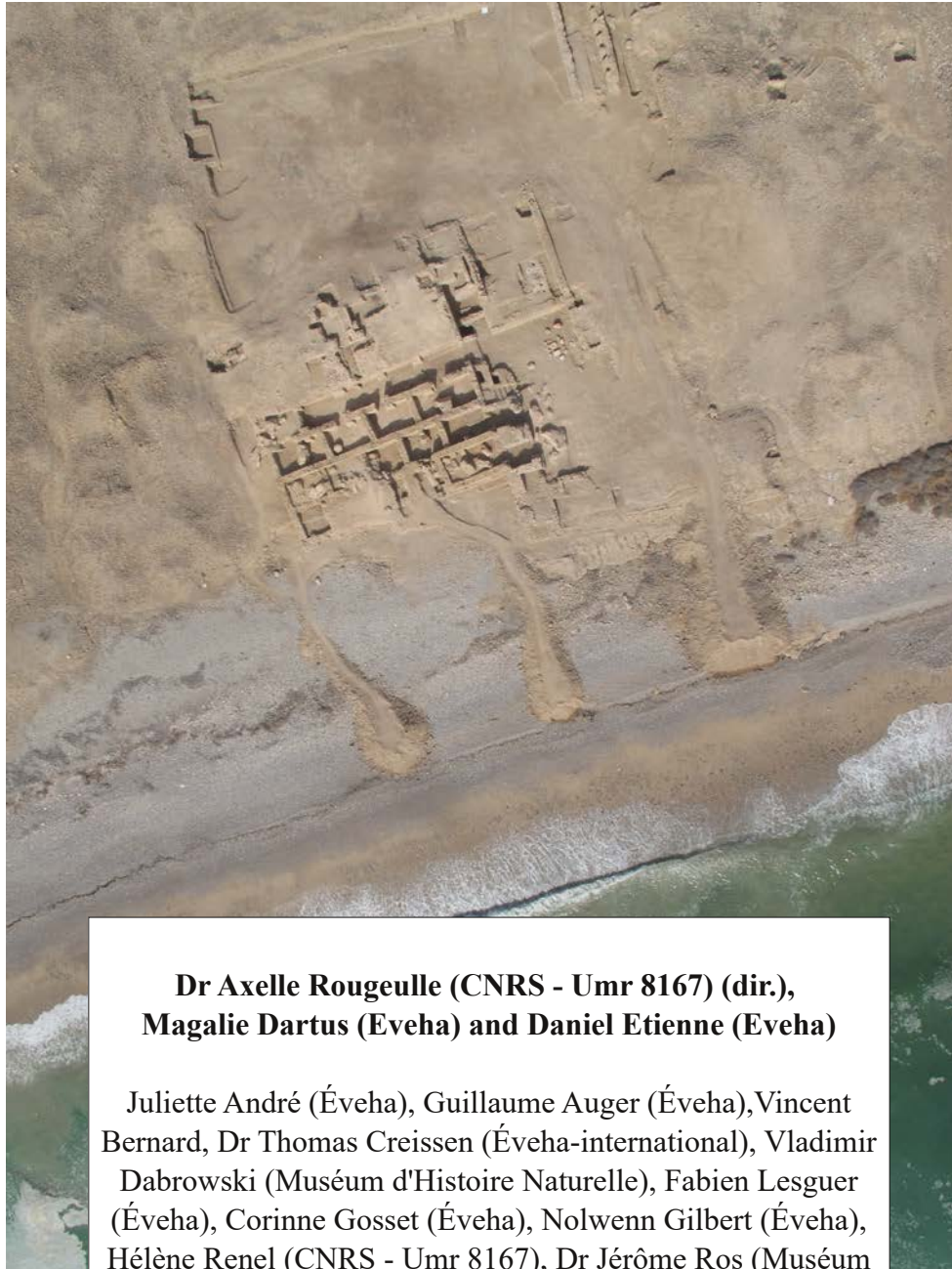

**Dr Axelle Rougeulle (CNRS - Umr 8167) (dir.),
Magalie Dartus (Éveha) and Daniel Etienne (Éveha)**

Juliette André (Éveha), Guillaume Auger (Éveha), Vincent Bernard, Dr Thomas Creissen (Éveha-international), Vladimir Dabrowski (Muséum d'Histoire Naturelle), Fabien Lesguer (Éveha), Corinne Gosset (Éveha), Nolwenn Gilbert (Éveha), Hélène Renel (CNRS - Umr 8167), Dr Jérôme Ros (Muséum d'Histoire Naturelle), Apolline Vernet (Éveha).

I
C
O
N
T
E
N
T

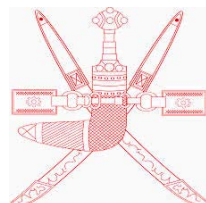

Sultanate of Oman
Ministry of Heritage and Culture



UMR 8167

MUSÉUM
NATIONAL
D'HISTOIRE
NATURELLE



Contents

| | |
|---|-----------|
| Acknowledgments | 7 |
| Location map | 9 |
| A. The great mosque | 11 |
| 1. Introduction | 11 |
| 1.1. Literary sources | 11 |
| 1.2. History of researches | 11 |
| 1.3. Course and methodology of the QDP excavations | 14 |
| 1.3.1. Course (date-contributors-objectives-delay / progress of excavations /) | 14 |
| 1.3.2. Methodology of excavations and registration (excavations / registration) | 20 |
| 1.3.3. Technical and numeral data | 28 |
| 2. General description of the B12 complex and architectural remains | 29 |
| 2.1. The mosque complex, location, general layout and chronology | 29 |
| 2.2. The main entrance and building B95 | 36 |
| 2.3. The courtyards and building B139 | 42 |
| 2.4. The mosque | 48 |
| 2.4.1. The basement, span one (rooms H, K and V) | 50 |
| 2.4.2. The basement, span two (rooms G, Q, S, L and R) | 55 |
| 2.4.3. The basement, span three (rooms I, A, C and F) | 60 |
| 2.4.4. The basement, span four (room B) | 67 |
| 2.4.5. The prayer hall | 70 |
| 2.4.6. The north wing (rooms E, X, J, P, W, T, U and areas M and N) | 72 |
| 3. Stratigraphical data | 85 |
| 3.1. The courtyards (B12-HC, B12-LC and external buildings (B95 and B139) | 85 |
| 3.1.1. Building B95 and passageway B95-B13 | 85 |
| 3.1.2. Building B139 and the courtyards (B12-HC and B12-LC) | 90 |

| | |
|---|-----|
| 3.2. The mosque building (B12) | 97 |
| 3.2.1. The basement, span one (rooms H, K and V) | 97 |
| 3.2.2. The basement, span two (rooms G, Q, S, L and R) | 99 |
| 3.2.3. The basement, span three (rooms I, A, C and F) | 103 |
| 3.2.4. The basement, span four (room B) | 109 |
| 3.2.5. The prayer hall | 113 |
| 3.2.6. The north wing (rooms E, J, P, T, W and areas M and N) | 113 |
| 3.3. Synthesis of the stratigraphy | 127 |
| | |
| 4. The decorative elements: description and location | 131 |
| 4.1. Typology | 131 |
| 4.1.1. Basic elements | 131 |
| 4.1.2. Elements/composite | 141 |
| 4.1.3. Styles | 147 |
| 4.2. Methodology | 154 |
| 4.2.1. Recording and counting | 155 |
| 4.2.2. Distribution | 161 |
| 4.3. Data | 162 |
| 4.4. Data interpretation by location | 162 |
| 4.5. Synthesis | 169 |
| 4.5.1. Decoration applied to the architecture | 169 |
| 4.5.2. Synthesis by location | 169 |
| 4.6. Conclusion | 171 |
| | |
| 5. The architectonic elements : description and location | 173 |
| 5.1. Pillars | 173 |
| 5.1.1. Central columns | 174 |
| 5.1.2. Lateral columns | 177 |
| 5.1.3. Engaged columns | 179 |
| 5.1.4. Octagonal pillars | 182 |
| 5.2. Arches | 183 |

| | |
|---|------------|
| 5.2.1. Central columns | 183 |
| 5.2.2. Lateral columns | 185 |
| 5.2.3. Engaged columns | 186 |
| 5.2.4. Octagonal pillars | 187 |
| 5.3. Doors and windows | 187 |
| 5.3.1. Doors and the inside partition wall | 187 |
| 5.3.2. Entrance | 190 |
| 5.3.3. Windows | 190 |
| 5.4. Cupolas | 191 |
| 5.5. Fan vault | 194 |
| 5.6. Merlons | 195 |
| 5.6. Synthesis | 195 |
| | |
| 6. By way of conclusion: a visit to the great mosque of Qalhât around 900 A.H./1500A.D. | 0 |
| 199 | |
| 6.1. The gates and courtyards | 199 |
| 6.1.1. The western city-gate | 199 |
| 6.1.2. The west courtyard | 199 |
| 6.1.3. The eastern sea-gate | 200 |
| 6.1.4. The north-east courtyard | 201 |
| 6.1.5. The southern gate | 201 |
| 6.2. The mosque | 202 |
| 6.2.1. The entrance hall | 202 |
| 6.2.2. The prayer hall | 203 |
| | |
| B. The ancient quarter of the city around the great mosque | 211 |
| 1. The surface survey in the ancient quarter of the city | 211 |
| 1.1. Introduction | 211 |
| 1.2. The streets | 213 |
| 1.3. The buildings | 214 |

2. The suq 217

C. Preliminary analysis of the archaeobotanical remains 231

The Qalhât Development Project is held by the Ministry of Heritage and Culture of Oman, under the high authority of H.H. Sayyid Haitham bin Tariq Al Said. Our deepest thanks are due to H.E. Salim bin Mohammad Al Mahruqi, Undersecretary for Heritage Affairs, without whom the Project would not exist. Our gratitude goes especially to Mr Hassan Mohammad Ali Al Lawati, Director General of Archaeology and Museums, and to Mr Sultan Saif Nasser Al Bakri, Director of the Department of Excavations and Archaeological Studies; their deep involvement in the project and their friendly backing in the various practical problems the project encountered this season were of a great importance. We also want to express our warmest appreciation to Mr Khamis Nasser Al 'Amri, representative of the Department in the Sur region, for his very efficient and friendly help and support all along the expedition, to Mr Mohamed Al Waili, in charge of the Qalhât Development Project in the Department in Muscat, and to Mr Adel Al Araimi, manager of the Heritage and Culture at Sûr.

We also wish to thank here warmly the French National Center for Scientific Research for its deep scientific and financial involvement in the Project. And the Eveha Agency, Julien Denis and Jérôme Monteil, its directors thanks to whom the Qalhât Development Project is going on with confidence and scientific rigor, and all the logistic staff of the agency in France who makes the life of the archaeological team much easier, Isabelle Besse, Frédéric Patient, Martine Perpillou, Florence Pfeiffer, Sandrine Piquet, Anne-Claire Volondat and Céline Caujolle-Bert.

Finally, this project would not go on so stimulatingly if not for the efficient and friendly collaboration of all others colleagues involved: the staff of the World Monuments Fund in charge of the conservation component of the QDP, Alessandra Peruzzeto, head of the project, Tristan Schebat, architect, and especially Chamsia Sadozaï, field conservator; Yves Ubelmann and Phillipe Barthélémy from the Iconem agency in charge of the 3D survey and documentation; and Cristina Guerra, conservator for the National Museum, for her analyze of the conservation of the decorative elements of the mosque.

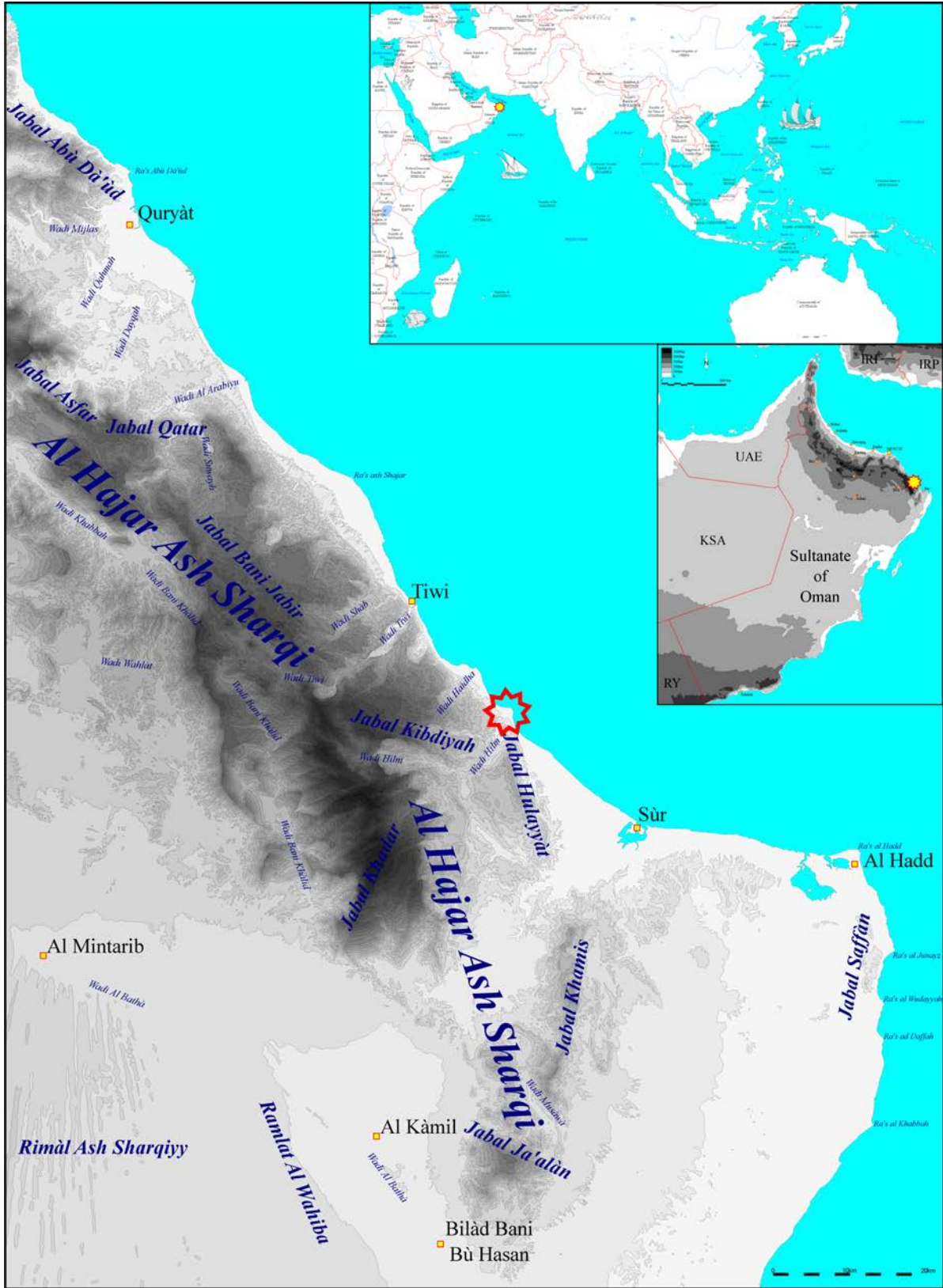

Fig. 1 - Localisation of the Ancient City of Qalhāt

A. The Great Mosque (B12)

1. Introduction

1.1. Literary sources

According to literary sources, the Friday Mosque was the main building of the city of Qalhât, and a most impressive example of Islamic architecture. It was first described by Ibn Battuta who wrote, around 1320 AD / 720 AH, that the city « has fine bazaars, and one of the most beautiful mosques that you could see anywhere, the walls of which are covered with enamelled tiles of Kashan. This mosque is very high, dominating the sea and harbour, and it was built by the pious Bîbî Maryam » (Battuta, II. 226). Nearly two centuries later, Bras de Albuquerque, chronicler of his father Afonso, gave a much more detailed description of the mosque which was destroyed by the Portuguese in 1508, “a very large building with seven naves, all lines with tiles, and containing much porcelain fastened upon the walls, and at the entrance to the gate a very large nave made with arcading, and above these was, as it were, a terrace looking towards the sea, all covered with tiles; the gates and roof of the mosque were all of elaborate masonry. And when it was set on fire it all fell to the ground, without anything remaining in it which was not burned.” (Albuquerque 1875 ed, p. 221). Some days earlier Afonso had “ordered a look out to be placed in the tower of the mosque, to keep watch from thence upon the movements of the Moors” which had been gathering at the foot of the mountain (ibid, p. 219), which most certainly means that the mosque had a tall minaret.

1.2. History of researches

The location of this building is since long one of the main questions arising about the city, and most scholars interested in Qalhât have wondered about it. According to T. Vosmer who directed a survey of the site in 1998 and then excavations in 2003 (Vosmer & al. 1998, p. 20 and fig. 25) the mosque could be located in the north-east quarter of the city, at the place of a huge building later identified during the Qalhât Project as a rich residence with a domestic quarter centred on a wide decorated majlis and three courtyards (B16, see QP Report 2009) (fig. 2). D. Agius, a member of the same team notes supports this idea “Our preliminary survey of the ruins of Qalhat suggests that the location of the mosque is north-west facing the sea “(Agius 1999, note 9 p.196, probably a slip for ‘north-east’ as the north-west part of the site does not face the sea but the mountain and the Wadi Hilm). Following the description of Ibn Battuta, the mosque was also identified with the Bîbî Maryam mausoleum, in the western corner of the city at the foot of the mountain. For Ibrahim & ElMahi (2000, p. 131) in particular « The description of the Qalhat mosque by Ibn Battuta matches clearly with Bîbî Miriam’s complex, which presents a unique piece of architecture » (fig. 2). P. Costa (2001, p.176; 2002, p. 58)



Fig.2 - Location of the Friday mosque of Qalhât, hypothesis (1-3) and reality (4)

disagree with this identification with the mausoleum itself but suggests that « a good candidate seems to me the large rectangular enclosure visible to the east of the mausoleum (fig. 2): the two buildings share the same commanding position over town and harbour, on almost the same east-west axis. As for B. and R. Bhacker (2003, 47), they note that “the description of the full frontal Portuguese attack on the city suggests that the Great Mosque was located nearer the headland rather than where the mausoleum is situated”, which means probably at the same place as the one suggested by T. Vosmer, in the north-eastern quarter near the promontory made by the mouth of the Wadi Hilm (fig. 2).

The description made by the Portuguese of their attack against Qalhât is in fact rather clear and does not support any of the abovementioned locations for the Great Mosque. As a matter of fact, it is noted that “as soon as they disembarked they were to proceed at once to attack the city on the side near the mosque, which was close to the sea, while he [Afonso d’Albuquerque] with the rest of the men would enter by the other end” (Albuquerque 1875 ed, p. 217). This means clearly that this mosque was located on the shore at a place where disembarkation was possible, i.e. along the beach in the south-east quarter of the city and not in the north-east one where the coast is lined by a cliff, not speaking of the Bibî Maryam area in the opposite part of the city at the foot of the mountain. As for the wide and low enclosure with towers near Bibî Maryam suggested by Costa (B3), it is most probably a much later structure, later than the abandonment of the city, as shown by the fact that it has a completely different orientation and furthermore destroyed part of the Bibî Maryam complex and north-west fortification wall of the city.

The discovery and excavations of the Friday Mosque of Qalhât were one of the main objectives of the MHC when starting the Qalhât Project. Fortunately, during the short preliminary visit made at the site in January 2007 at the invitation of the MHC, Dr Axelle Rougeulle discovered several fragments of moulded decoration and green glazed tiles in the shape of stars on the surface of a large building. This building (structure B12 of the Qalhât Project) was located on the seaside overlooking the beach, in the middle of the city, and was consequently interpreted as the possible location of the mosque (fig. 2). Several

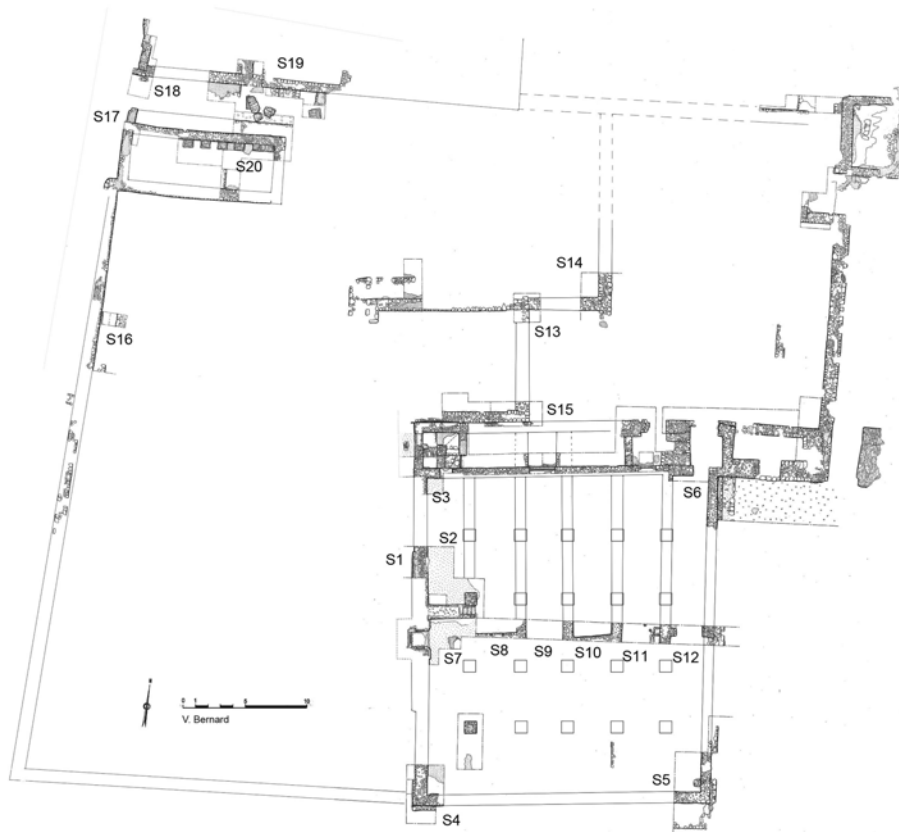

Fig. 3 - Plan of the mosque unit at the end of the QP excavations (2011)

soundings and trenches were therefore excavated in 2008-2011 in this area (fig. 3). Two soundings were first opened in 2008 on both sides of what was supposed to be the qibla wall, which brought to light the complete stratigraphy of the area (S1) and led to the discovery of the mihrab, the minbar and a pillar (S2), allowing the clear identification of B12 with the great mosque of Qalhât (Rougeulle 2008, p. 308-312). The other soundings opened in 2009, in the north-west (S3), south-west (S4), south-east (S5) and north-east (S6) corners of the building, together with a long axial trench, 1,50m wide, from the mihrab to the sea (S7-S12), brought information about the plan, elevation and additional details on the chronology of this mosque. Finally, further excavations were held in 2010 and 2011 in the surroundings, the wall between the two main courtyards (S13-S14), the northern wing of the mosque (S15), the west wall of

the unit (S16), the main gate (S17-18), the entrance corridor (S19) and an associated structure in the western courtyard (S20) (Rougeulle, Creissen & Bernard 2012).

The extensive excavation of the mosque and its conservation for display to the public are one of the main objectives of the Qalhât Development Project. It started during the 2013b-2014a season of the QDP and is now under progress.

1.3. Course and methodology of the QDP excavations

1.3.1. Course

- Dates of interventions, Contributors, Initial objectives and Reasons of delay

The second season of the Qalhât Development Project devoted to the excavations of the Great Mosque was divided in two sessions, the first one in Fall 2013 (2013-b) and the second in Winter 2014 (2014-a). Both sessions of two and half months have known some delays not attributable to the archaeological team (see below) which prevent the fully completion of the excavations.

The first session was intended to take place between the 06th of October 2013 and the 12th of December 2013 but the difficult providing of expected workforce allowed an effective start of excavations only on the 23rd of October. The second session took place between the 13th of January 2014 and the 27th of March 2014 and also known a delay of one week due to the provider of workforce, allowing an effective start on the 25th of January. On both sessions, the last week was devoted to the end of registration and making of the contractual reports. It was therefore free of excavations.

During the two sessions, the excavations were lead by a team of eight archaeologists from the French company EVEHA International under the direction of Dr A. Rougeulle (CNRS-UMR 8167), distributed between the two sessions and parts of them :

- Magalie Dartus (Field Director, from 2013/10/06 to 2013/11/02 and from 2014/01/13 to 2014/02/13)
- Daniel Etienne (Field Director, from 2013/10/06 to 2013/12/12 and from 2014/01/13 to 2014/03/27)
- Juliette André (Archaeologist, from 2013/10/06 to 2013/12/12 and from 2014/02/13 to 2014/03/27)
- Guillaume Auger (Archaeologist and Topographer, from 2013/10/06 to 2013/12/12 and from 2014/01/13 to 2014/03/27)
- Nolwenn Gilbert (Archaeologist, from 2014/01/13 to 2014/03/27)
- Corinne Gosset (Archaeologist, from 2013/10/06 to 2013/12/12 and from 2014/01/13 to 2014/03/27)
- Fabien Lesguer (Archaeologist, from 2013/10/06 to 2013/12/12 and from 2014/01/13 to 2014/03/27)
- Apolline Vernet (Archaeologist, from 2013/11/03 to 2013/12/12)

In parallel with the excavations focused on the Great Mosque, a campaign of the Qalhât Project, supported by the Ministry of Heritage and Culture and the archaeological committee of the French Ministry of Foreign Affairs and lead by Dr Axelle Rougeulle, took place during the first session (2013-b, see results below Chapter B). Three archaeologists were involved in this campaign, from the 14th of November to the 14th of December 2013 :

- Dr Axelle Rougeulle (Archaeologist, CNRS, scientific director of the QDP, director of the QP)
- Dr Thomas Creissen (Archaeologist, Head of Eveha International)
- Nolwenn Gilbert (Assistant archaeologist, Master Student at Sorbonne University)

In addition, during both sessions, various specialists brought their contribution, either on the Mosque excavations or the results of previous seasons.

- Vincent Bernard (Archaeologist and architect, from 2014/02/25 to 2014/03/12) made a study and precise drawings of the collapsed elements of the Great Mosque and worked on the tentative reconstruction of the building

- H  l  ne Renel (ceramologist, CNRS, from 2013/11/14 to 2013/12/14 and from 2014/02/25 to 2014/03/12) made a study of ceramic artifacts found in some parts of the Mosque, in the QP excavations and in the previous QDP season.

- Dr J  r  me Ros and Vladimir Dabrowski (archaeobotanists, Mus  um d'Histoire Naturelle, from 2014/02/20 to 2014/03/17) made the study of botanical remains found during the previous QDP and QP seasons.

The initial objective was to excavate the whole precinct of the Great Mosque complex during the season 2013b-2014a, but this objective was not reached, for some reasons.

It must first be admitted that some archaeological facts were not enough anticipated. The number of architectural and decorated elements was much bigger than it was expected and the poor state of conservation of the main architectural remains led to the necessity to change plans of removal during excavations.

But most of all, the main and sufficient reason of delay must be found in the repeated problems in the providing of the adequate and expected workforce. Besides the half-month lost during the two sessions because of the delay of the workers arrival, their number also quite never reached the expected number of forty and decreased to nearly twenty in February. Furthermore, several repeated troubles regarding the providing of food and salary to the workers led them, after several warnings, to stop working in March, quite all the month being then lost for work. In all, more than one month was lost for efficient work, because of the lack of workforce, and the remaining three and half months (counting one week at the end of each session for study and redaction) were done without the sufficient and contractual workforce (details and numeral data are given below). If the excavations might have not been fully completed without all these difficulties, their recurrence prevent any chance or possibility to try.

- *Progress of excavations*

In order to facilitate location and description, it has been decided to divide the Mosque Complex (B12) into several parts (fig. 4), either identified architectural units or arbitrary divisions, using both the shape of remains and

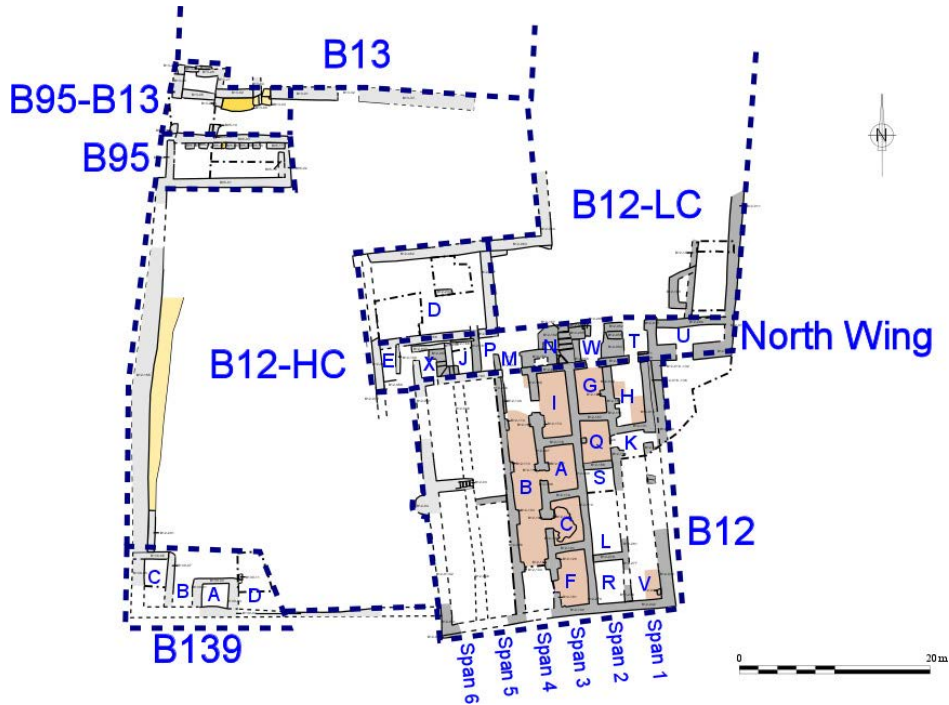

Fig. 4 - General organization and subdivisions of the complex B12

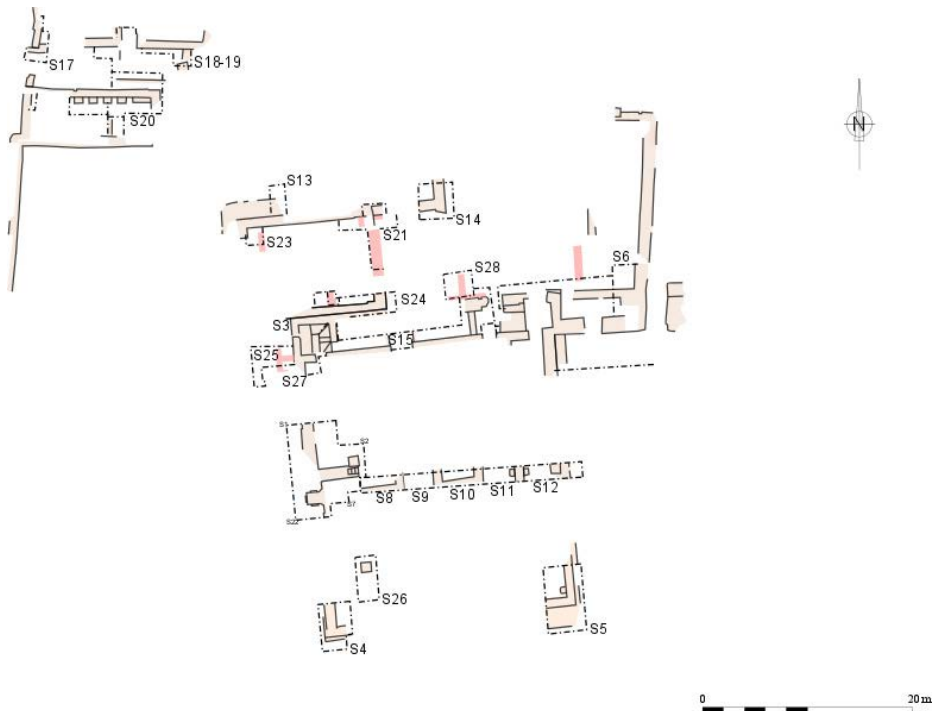

Fig. 5 - The complex B12 as known at the end of the QP campaigns

archaeological facts known by previous soundings (see below for monumental description) (fig. 5).

The Mosque building properly said (also B12) was divided in four parts (north-east, south-east, south-west and north-west). For north-south separation's line the long and central sounding opened by the QP was used the more or less known delimitation between the preserved floor of the prayer's hall and the basement filled by collapse provide the north-south separation's line. In that configuration, the north-east and south-east parts covered the basement while the north-west and south-w parts covered the prayer's hall, the axis of the mihrab making separation between north and south.

On the north side of the Mosque building (B12), several constructions less understood but identified as not belonging to the internal open space of the prayer's hall were gathered into the "north wing". Further more, the courtyards were divided between the large and higher one (B12-HC), on the west side of the Mosque building, and the smaller low one (B12-LC) on the north side. In the north-west of the high courtyard (B12-LC), a rectangular building (B95) was clearly visible. Several heaps and troughs in the south-west corner suggested the presence of another range of buildings.

In October 2013, excavations began in three places of the Mosque Complex (B12). The main part of the work was focused in the middle of the Mosque building, on north and south sides of the long sounding open through the Mosque by the QP during the previous campaign, each team progressing northward and southward on a width equivalent to the half of north-east and south-east parts. The second place of excavations was opened over the building B95 and its surroundings while the last one was opened at the west of the north wing intended to progress eastward.

During the month of November 2013, as excavations were ongoing on every parts already opened, a fourth place was opened over the second half of the north-east part of the interior of the Mosque, this time progressing from north to south. A small sounding was made in the north-west corner of the high courtyard (B12-LC), confirming the presence of buildings (B139), while an internal division (B12-D) of the high courtyard (B12-LC) was clearly brought out.

By the end of December 2013, quite all the north-east part was under excavations, having uncovered the limits of six rooms (B12-A, B12-B, B12-H, B12-I and B12-K). In the south-east part, where less people were at work, one half was excavated, discovering the limits of three rooms (B12-B, B12-C and B12-F). In the north wing three rooms more or less closed were found (B12-E, B12-J and B12-P) as well as an unclosed area with an open access to the basement (B12-M) and a staircase. A short part of the immediate surroundings were also unearthed at this time on eastern and southern sides (fig. 6, 7 § 8).

At the start of the second session in January 2014, excavations continued on building B95 and further investigations were led on the building B139 showing that it was more than an isolated building. The previous sounding around the mihrab and minbar in the prayer's hall was reopened and extended eastward, while unfinished areas of north-east and south-east parts were restarted. In the north wing, excavations intend to finish the already excavated



Fig. 6 - General view of the north-east part of the Mosque at the end of December 2013



Fig. 7 - General view of the south east part of the Mosque at the end of December 2013



Fig. 8 - General view of the Mosque at the end of December 2013

rooms and emptied the unclosed areas. Because of the continuous decline of the workforce, the planned excavations schedule was forced to change. We have adapted to the circumstances: some opened areas had to be stopped and left in state, as it was chosen to concentrate on the most advanced parts.

In February 2014, an important part of the working time was devoted to the complete and precise drawings and registrations of the most massive and interesting architectural elements, and for some of them to their methodical dismantling, as it was not possible to leave them in place for archaeological and safety reasons. A surface cleaning over the second half of the north-east part of the Mosque also revealed the plan of four new rooms (B12-L, B12-R, B12-S, B12-T). In the meantime, two rooms of the north wing (B12-T and B12-W), already partially known, were excavated, while a sounding opened in the internal division (B12-D) of the high courtyard (B12-HC) showed there some complex structures.

In March 2014, during which only the six members of the archaeological team have worked, the priority was focused on the rooms that were technically possible to finish. By the end of this session, it can be said that the north area and the north-east part are excavated and finished around 75% of their surface, while the north-east is only finished a little more than 50% and the prayer's hall



Fig. 9 - General view of the Mosque building at the end of March 2014



Fig. 10 - General view of B12-HC and B12-139

is quite almost unexcavated (fig. 9). The external building B95 is also rather finished but not its surroundings, while the southern building B139 is not completed but seems quite simple to excavate and finish (fig. 10).

Along with the strictly field archeology, some part of the workforce was used firstly for the cleaning of the track to make it passable and from time to time for the removal of the bushes covering the surface of Qalhât in order to make the aerial photographic project lead by Iconem gainful. In parallel, the study and reasoning about the architectural remains and their decoration, chronology, shape and restitution of the Mosque Complex, was exponentially ongoing during both sessions.

1.3.2. Methodology of excavations and registration

- Methodology of excavations

As it was known, by previous soundings, that the basement of the Mosque was filled by collapses full of decorative and architectural elements, it was decided to artificially divide this thick layer of collapse into several parts. This in order to keep knowledge of the location of those elements for facilitate and refine the restitution of the Mosque, without wasting a precious time by recording every one of them with the topographic station, especially for the many small and isolated carved stones or coated moldings which were not scientifically relevant to be individually located with a centimetric precision.

It was first intended to divide horizontally every room in at least two parts or more, in case of wide rooms, and excavate half by half or third by third. In some cases however, the presence of massive architectural elements did not allow to place these separation and stratigraphical benches in the middle of each rooms, and safety reasons did neither allow to maintain some of them from their tops. Nevertheless, stratigraphical benches were made in every room, if not always in its middle, and appropriate stratigraphical observations and registrations were also made.

Vertically, the thick level of collapse was divided into different artificial layers created every 0,5m, each of these layers being differently numbered and registered, in every half or third of the room. By this methodology it is now possible to show eventual concentration of decorative and architectural remains, either vertically or horizontally, and then refine the restitution by considering the presence of certain kind of decoration and architecture in certain places and certain heights of the Mosque.

After the removing of the large level of collapse, occupancy levels were also excavated by third or half, as it was barely possible to remove the other remaining part of collapse without damaging the uncovered levels and thus risking the loss of information. These levels were excavated by archaeological, and not artificial, layers, and occupancy structures, mainly hearths and postholes, were excavated according to international archaeological standards, namely by half. In presence of hearth or rejection structure, the sediment, charcoals and ashes were systematically sampled for

further detailed analysis, mainly botanical, and occasional samples were also made in occupancy layers when traces of charcoals and ashes suggested a scientific interest.

As it appeared that a more or less well preserved coated floor was existing in all rooms of the basement, excavations obviously stopped on that level. Where the coated floor was well preserved, there was no difficulties to completely exposed this level, but over the most damaged parts, namely around the doors and access, the excavations could have sometimes slightly reached the underneath backfill layers. Furthermore, it must be admit that the enthusiasm of the workers had sometimes led to a small damage of some structures, such as thresholds and top of walls.

The presence of massive architectural elements in the collapse (fig. 11 § 12), unable to be moved because of their size and weight, were treated differently regarding to their state of preservation, interest and location. The elements showing no traces of related decoration and/or characteristic architecture were systematically destroyed and thrown away after complete and adequate registration and documentation, including topographical survey, when they were either too small, irrelevant or preventing the pursuit of excavations. In this group are mainly gathered remains of walls.

Massive and complex elements, with architectural features easily identifiable and visible and/or with remains of decoration, were left in place when their location was not dangerous for the security of archaeologists and not preventing the completion of excavations. The registration was as complete as it was for any other elements, including topographical survey. As it was chosen to left some of those elements in situ after the end of excavations, to create animations among the ruins, the most fragile of them were basically strengthened during the course of excavations by the Conservation Component, waiting for a better and permanent solutions. In this group are



Fig. 11 - Remain of pillar left in place in room F



Fig.12 - Remains of columns left in place in rooms H and K

mainly gathered remains of pillars and columns.

The massive but transportable by hands elements that showed remarkable architectural features and/or remains of decoration, but not real interest to be left in place or to fragile to support outdoor conservation, were removed and stored in containers after adequate registration and documentation, including topographical survey (fig. 13). It will thus be possible to consider further conservation and restoration and wonder about the future display of these most



Fig. 13 - The small architectural elements stored in container

interesting archaeological remains.

Finally, the main difficulty was to deal with the architectural elements, which were often the most easily comprehensible and identifiable ones and showing the more interesting remains of decorations, and which were too fragile to be left in place and/or located in places where they were preventing the completion of excavations or creating actual hazard for the archaeologists and workers, and too massive to be transported by hands. As no suitable engines, such as hoist or dumpers, were able to drive down to the Mosque, it was decided to methodically dismantle and remove them in a way that will allow afterward reconstruction (fig. 14 § 15). After topographical survey, adequate registration and documentation, including manifold photographs and precise drawings, these elements were dismantled by hand, using a hammer and a burin to detach the carved stones from the facing face off the internal blocking mortar, and smaller tools, such as scalpel, to detach the elements of decoration as best as possible. While the stones were simply stored in containers with the others architectural elements, the remains of decoration were enfolded in bubble wrap and stored in aluminum boxes to keep them as safe as possible. With the precise registration that was made for them (see below), it will possible to rebuilt those interesting architectural remains and display them, rather in indoor situation where they could be shown to public in appropriate conditions of conservation, than in field where their fragility will make them very



Fig. 14 - Half-column IsoArc 331 after methodical dismantling



Fig. 15 - Pillar IsoArc 231 after methodical dismantling

vulnerable to alterable weather and human dilapidation.

In the others excavated parts of the B12 complex (courtyards and external neighboring buildings), the methodology was rather the same but simplified. The interior of the building B95, which limits were quite almost entirely known by previous soundings, was divided in opposite quarters with less artificial layers there, as it soon appeared that the collapse of this building contained less architectural and decorative remains than the Mosque buildings. This excavation by opposite quarters allowed the registration of two general stratigraphical benches, in width and length. Occupancy levels were also excavated by archaeological, and not artificial, layers and occupancy structures received the same usual archaeological treatment as the ones inside the Mosque. The passageway between the building B95 and the complex B13 was also excavated by opposite quarters, with exactly the same protocol.

As they were already known and well registered by the previous campaigns, the collapse layers which covered the eastern enclosing wall (B12-186) of the high courtyard (B12-HC) were excavated without intermediary stratigraphical benches, only three parts (northern, central and southern) being artificially created to help for the location of hypothetical architectural and decorative elements that did not come. Others small parts of the courtyards, for example the collapse layers covering the separating walls (B12-067, B12-063) between the high courtyard (B12-HC) and the low courtyard (B12-LC), already registered and documented, were excavated in the same way. However, occasional scarce structures found under these collapse layers were obviously excavated under the classical international protocol.

The methodology used for the building was more simple, regarding to the relative simplicity of it. After a ground cleaning to appraise the general shape of the internal rooms, each one of them was excavated by half, without artificial layers as the collapse clearly not contain any remarkable remains. Moreover, no occupancy structures are actually known inside or around this building.

- Methodology of registration

The methodology used in Qalhât follows the usual standard of modern archeology. Every excavations layers (hereafter named UF for Unit File), either artificial or actual, was described in a proper record file, first by hand and afterward included in a database, bearing all information of location, components, sizes, shape and hypothetical identification. A personal number was given to every single UF, from 3000 to 3499 and from 3600 to 3613 for the Mosque building, immediate surroundings and both courtyards, while the personal numbers ran from 3500 to 3566 for the buildings B95 and the passageway B95-B13. In the same way, every structures, either constructed (walls, thresholds...) or more temporary (hearths, postholes...) were recorded with a proper record file bearing the same information and received a personal number running from B12-001 to B12-291 and from B95-001 to

B95-028. All stratigraphical sections and structures were hand-drawn at a scale of 1/20. If the layers collapse and most part of the occupancy ones appeared only vertically on the drawing of the benches, all structures were also drawn horizontally in plan, unless security reasons prevent a complete horizontal excavations, at the same scale. All drawings were afterward redrawn in computer into Finalized Vector Drawing.

The usual archaeological artifacts (ceramics, bones, glass, metal...) and the lonely fragments of applied decoration (mainly glazed tiles) were collected and registered under the number of the corresponding UF without further information of location. After cleaning and photographs for the most interesting of them (especially glass and metal), these artifacts were stored in adequate conditions. When some of these elements were found in occupancy levels or on the floor, they could have been treated more precisely when their interest was estimated sufficient. In this case are gathered small metallic elements, remains of wood, coins, fish bones or scales... After adequate photographs and topographical survey, these artifacts, which are considered as the more interesting and scientifically useful, were isolated from the others and stored apart in order to ease a quicker study. They were also registered separately under a proper isolated series of Isolates (and thereby named as Iso) separated by material : IsoMet for metallic elements, IsoCer for ceramics, IsoNum for coins, IsoGla for glass, IsoFau for animals remains, IsoMal for shells, IsoIch for fishes remains, IsoAfc for remains made of fired clay, IsoMin for mineral elements (including tools made of stone barely worked), IsoOrg for organic elements (mainly wood) and IsoSla for slags. The particular protocol was in used during the previous campaign of the QDP (Buildings B94 and B21) and the series of numbers are running since January 2013. During this campaign, the Isolates of the QP campaigns (2008-2013) were also gathered and registered under this protocol.

The remains of architectural elements deserved a new specific registration protocol, as they were a new archaeological material (compared to previous QP and QDP campaigns) and the main sources of information for the features and decoration of the Mosque. All intelligible elements, meanings all lonely carved stones and coated or moulded mortar elements big enough and well preserved to suggest an identification and a provenance as well as massive remains, were isolated and registered (and thus named as IsoArc) but did not received the same level of preciseness. Every one of these IsoArc received a personal IsoArc number and was precisely registered and described (sizes, shape, components, identification and suggestion of provenance) in an appropriate record card. The smallest isolates, meaning complete or fragmentary isolated carved stones detached from biggest architectural elements or fragments of coating with architectural features and fragments of moulded mortar decoration, were gathered and stored with the number of their corresponding UF without more information about their location and were recorded by a simple photograph. The biggest ones, remains of pillars and columns or large fragments of coated walls with or without architectural features, received a more precise treatment by more

complete photographic and topographical surveys, and for the most interesting ones a precise drawing.

The IsoArc that showed elements of decoration such as applied glazed tiles, prints of tiles of carved figures, also received a personal number as IsoDec for Isolates of Decoration. Further details about the registration and treatment of the IsoArc and IsoDec will be given below in appropriated chapters. During both sessions, 687 IsoArc have been registered, some of them being later canceled as they were irrelevant, and 100 IsoDec.

A special and suitable protocol of registration was also created for the IsoArc which were concerned by the methodical dismantling (see above). The first one to be methodically dismantled (IsoArc 331) was a Style P half-column (see below) made of simple curved rectangular stones and by so quite easy to dismantled. A different number was given to every stone and reported either on photographs of the elements and on a simple handwriting outline. The same number with a handwriting arrow indicating the top of the element were then reported on the side of the stone, with a layer of paraloid underneath to ease the afterward removal of these handwritings.

The four others IsoArc to be treated that way (IsoArc 100, 131, 133 and 31) being of the same more complex kind with remains of applied decoration (Styles A and J, see below), a more sophisticated protocol was adopted. A special record form was created, bearing all information of general location, place and type of the element in the general structure, and a large sketch of Styles A and J decoration where personal number of removed elements, missing ones and states of preservation can be noted. In addition to this record form, the personal number was also reported on photographs. Same number and arrow were also applied in same conditions, on side or back of every elements. Though of less scientific relevance (but precious for saving time), this registration will be very helpful for the future rebuilding of these important architectural remains.

The photographic survey was as complete as possible regarding to outdoor conditions. As the weather, and mainly the shining sun of Oman, is not suitable for right and adequate photographs, it was only possible to take them early in the morning or late in the afternoon. For the smaller structures, it was possible to create some shadows by using a large sheet and thus not delay for too much the pursuit of excavations. It results from these conditions that the photographs are not always as good as hoped, especially lightness and contrasts. Furthermore, vertical photographs of the rooms from the outside were not always easy, because of their sizes and encasement. However, the quantity of photographs largely palliate their occasional defaults and the photographic survey can be considered as satisfying and accurate, especially as it is now completed by the aerial survey made by Iconem.

With a few exceptions due to particularly difficult situations, three different photographs were made for every subject. The first one was made with a board bearing the information of location and identification (meaning the

number of the room or area and the number of UF or structure), a plastic arrow toward north to indicate orientation and a metric scale, the second one with only the arrow and the metric scale, the third one without any elements. The first photograph is used to easily and quickly identify the two later photographs, the second one is used for the reports and articles to come, where information plates are often looked at unsightly, while the third one might once be used for publication or public display, where informative elements can be properly added by computer. Moreover, this threefold photographs enhance the chance to have at least one proper.

The stratigraphical sections and the structures were always registered with at least one series of photographs taken from the front, and often several series especially for the structures, before and after excavations, from above and from the front. The lonely IsoArc have been documented for the most of them by a single work photograph with metric scales and sometimes more when a lonely IsoArc had several interesting features on its different faces. The more complex and massive IsoArc were documented firstly by a threefold general photographs in state of discovery completed after by various series for the different faces and details. As often as possible, general views of excavations were also taken, with all limits due to the available equipment.

The more interesting artifacts, mainly coins, metallic objects and glass fragments, as well as some remains of decorations were also photographed in nearly lab conditions, either for publication purpose than research to come.

During both sessions, nearly 7300 photographs were taken.

1.3.3. Technical and numeral data

| | | | |
|--|---------------------------|--------------------------|--------------------------|
| <u>Days of work</u> (effective/expected/ratio) (78%) | 2013-b 42/50 (84%) | 2014-a 33/45 (73%) | Total 75/95 |
| <u>Workforce</u> (effective/expected/ratio) | 2013-b 1472/2000 (73%) | 2014-a 975/1800 (54%) | Total 2447/3800 (64%) |
| <u>Excavated area</u> | 2013-b | 2014-a | Total |
| Interior of the Mosque | 235 m.sq | 155 m.sq | 350 m.sq |
| Immediate surroundings | 175 m.sq | 140 m.sq | 330 m.sq |
| Adjacent buildings and courtyard | 315 m.sq | 200 m.sq | 440 m.sq |
| Total m.sq | 725 m.sq | 495 m.sq | 1 120 |
| <u>Estimated volume of Removed collapse</u> | 2013-b | 2014-a | Total |
| Basement of Mosque | 470 m3 | 130 m3 | 600 m3 |
| Prayer's Hall | 0 | 18,75 m3 | 18,75 m3 |
| Immediate surroundings | 175 m3 | 140 m3 | 315 m3 |
| Adjacent buildings and courtyard | 472,5 m3 | 300 m3 | 772,5 m3 |
| Total | 1117,5 m3 | 588,75 m3 | 1 706,25 m3 |
| <u>Remaining unexcavated area</u> | | | |
| Basement of Mosque | 105 m. sq | | |
| Prayer's Hall | 135 m. sq | | |
| Immediate surroundings | 360 m. sq | | |
| Adjacent buildings and courtyards | 300 m.sq | | |
| Total | 900 m.sq | | |
| <u>Estimated volume of remaining collapse</u> | | | |
| Basement of Mosque | 200 m3 | | |
| Prayer's Hall | 100 m3 | | |
| Immediate surroundings | 360 m3 | | |
| Adjacent buildings and courtyards | 600 m3 | | |
| Total | 1 260 m3 | | |
| <u>Registration Data (for both session)</u> | | | |
| Unit Files (UF) recorded | 579 | | |
| Structures recorded | 319 | | |
| IsoArc recorded | 687 | | |
| IsoDec recorded | 100 | | |
| Others Isolates | 45 | | |
| Photograph taken | 7279 | | |

2. General description of the B12 complex and standing architectural remains

In this chapter will be given information about the general organization of the complex and measures of the actual standing architectural remains. Without expressly mentioned exceptions, all measures always expressed in meter are given following the same forms : length (l:) by width (w:) by heights (h:) (I.E. l:1,65 x w:0,24 x h:1,34). In case of round structures, diameter (d:) is given instead of length and width, and in case of dug structures (posthole, pit...), the height is actually the depth. In presence of remains in place, the length is always the longest horizontal measure and the width the smallest horizontal one, while the height, which is the actual preserved elevation, is always the vertical measure. In case of element which original position is unknown, the length is always the longest measure, the width is the intermediary one and the height is the smallest. All altitudes are expressed in meter and integrated into the American Universal Transverse Mercator coordinate system (UTM-WGS84). In this grid system, the level 0 is calculated from an average worldwide sea level. In Qalhât, the real sea level varies from 3,50m (low tide) to 6,50m (high tide) higher than the UTM. It must so be kept in mind that altitudes given in this report are actually about 5m higher than the average main sea level.

2.1. The mosque complex, location, general layout and chronology

- Location and surroundings

The medieval city of Qalhât was founded on a rocky plateau at the foot of the Jebel al-Hajjar al-Sharqi, a place which is totally surrounded by the sea to the east, the mountain to the south-west and the high bank of the Wadi Hilm to the north-west. The plateau is slightly sloping down from the foot of the mountain (at level c.35m), ending on the sea-side with a steep and inaccessible cliff about 15m high, beaten by the waves at high tide. At one place only does the ground reach the level of the shore, as a natural depression surrounded by slopes and rocky ridges, bordering a sloppy pebble beach (fig. 16). It is the only place in the area where a boat may land, and underwater surveys led by the Australian team in 1998 showed that 15 of the 22 stone anchors registered on the seabed were indeed located in front of this beach (Vosmer T. & al. 1998. Oman Maritime Heritage Project, field report 1998, fig. 2. Perth, Western Australian Maritime Museum Report n°144).

The original settlement was located there in front of the harbour, in the depression and on the surrounding slopes and ridges. It is the only place



Fig. 16 - General view of the depression and the beach.

until now where excavations delivered archaeological layers earlier than the end of the 13th century AD. The associated material shows that the occupation goes back to around 1100 AD, a dating which fits with the descriptions of the foundation of Qalhât, in the 11th or 12th centuries, by Yaqût who visited the city around 1215/1220 AD (Yāqût al-Rūmī al-Hamawī/ed. F. Wüstenfeld, Kitāb mu'jam al-buldān. 1868, iv: p. 393), and then by Turan Shah in his book about the origin of the Hormuz Dynasty (Teixeira P. & Sinclair W.F. 1902. The travels of Pedro Teixeira; with his "Kings of Harmuz" and extracts from his "Kings of Persia", p. 153-155, 256-257. London: Hakluyt Society). Not a single trace was found yet which could corroborates a foundation going back to the early Christian era as suggested in the Kitāb Ansāb al 'Arab of al-Awtabî (Bhacker M.R. & Bhacker B. 2004. Qalhât in Arabian History: Context and Chronicles. Journal of Oman Studies 13, p. 25-26). This early city of Qalhât was mentioned around 1150, so shortly after its foundation, by al-Idrisi who describes a small town, with some pearl fishing activity. It was most probably not much more than a large village at that time, with rather small buildings and a small Friday mosque. Unfortunately al-Idrisi does not give any description of this mosque and no trace of it was found in excavations. It is more than probable that it was located in the centre of the city near the beach, and that it was later entirely destroyed when a wide architectural complex was built in this place in c.1300. This new centre was about 60m wide east-west and 80m long north-south along the shore, and included a new Friday mosque (B12) to the south and a large building (B13) to the north, both with associated courtyards.

As a matter of fact Qalhât underwent a major development starting in the end of the 13th century AD, under the reign of the governor Bahadin Ayâz Seyfin and his wife Bîbî Maryam. New quarters were then founded all around the ancient city, and the old part of the town itself seems to have been mostly rehabilitated. The southern part of the depression and the slopes all around were covered with a densely built settlement with massive buildings and a complex network of streets and lanes, with some city squares (see below, part B). They were surrounding the B12-B13 complex, which was standing in the northern part of the depression along the beach.

The complex was mainly accessible from the west, through the main street of the city which was crossing the town rather straightly from west to east (fig. 17). It started from the coastal track Sûr-Qurayyat in front of the mausoleum of Bîbî Maryam near the mountain, then passed through the west gate B31 in the city wall, then along the intra-muros cemetery B93, then through the ancient quarter, and finally down to the gate of the

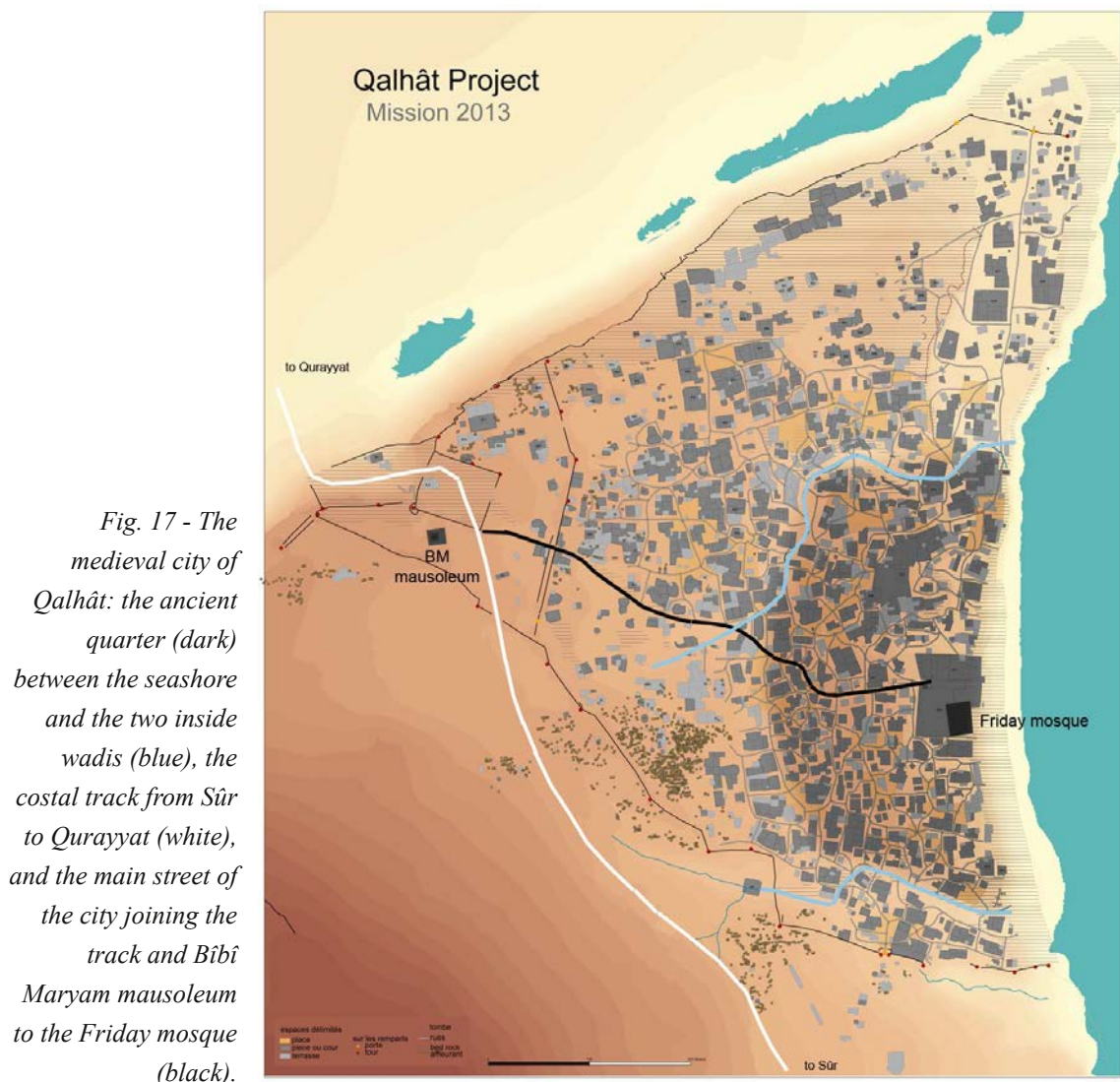

Fig. 17 - The medieval city of Qalhât: the ancient quarter (dark) between the seashore and the two inside wadis (blue), the coastal track from Sûr to Qurayyat (white), and the main street of the city joining the track and Bîbî Maryam mausoleum to the Friday mosque (black).

mosque unit of the complex which was located at the bottom of a rocky ridge; the ridge was partly landscaped with rough steps to make passage easier. The space between the ridge or the slope and the complex is about 20m wide. It is now a flat and even area made by the accumulation of a natural backfill brought by runoff from the slope against the wall. A sounding in front of the gate showed that it is here 1.5m thick and traces of some walls are visible on the present surface to the south. So it is not clear at the moment whether this space was opened, as a wide street or maidan lining the wall of the complex, with only some small attached structures, or if it was mostly built except probably for a narrow street.

The northern slope of the depression was particularly high and steep, with rocky ridges. Another architectural complex was standing on top (B14), dominating the sea to the east and the B12-B13 complex to the south. It included a large courtyard and several buildings, one of them with small cells which could be a khan or a convent, as shown by the excavations held there by an Iranian team in 2008. To-day the modern track passes through the courtyard of B14 before sloping down to the mosque complex, but it is not clear whether there was an ancient street here connecting both complexes, or if the B14 courtyard was closed on that side as seems to suggest the line of a wall under the track. In any case, excavations held this year in the depression down B14, between the B12-B13 complex and the foot of the northern slope, showed that a *sûq* was located there, along the north and probably north-west corner of B13, and that several narrow streets were connecting the beach and the city on that side of the complex (see below, Part B)

The B12-B13 complex was lined on the south side by a straight street connecting the beach to the city. South of it, the depression extends as a wide and rather flat area along the sea. The surface survey held there this year showed that it was covered by buildings, smaller than on the slopes, and rather large streets with wide squares with terraces (below, Part B). Only along the shore south of the mosque are large buildings (B150, 152, 155), associated with several long and rather high terraces covered with small pebbles (B155, 160), which overlook the beach and harbour. It is clear that all the area along the beach was devoted to public and official activities, as the *sûq*, the building B13, possibly the residence of the governor, the Friday mosque, and the large edifices to the south which are probably linked with some activities connected with trade and/or navigation, as a custom for example.

- General layout of the B12-B13 complex

The complex measures about 80m north-south and 60m east-west, and includes two units, north and south, with walls all around (fig. 18). The northern unit includes a large building (B13) to the west and a courtyard to the east, with secondary structures. Measuring about 30m north-south and 40m west-east, B13 is organised around a central courtyard but the



*Fig. 18 - kite photograph
of the B12-B13 complex
before the start of
excavations.*

general shape is rather irregular, with the north-west angle smaller than 90°. It was certainly a very impressive construction with at least two storeys given the height of the heaps of rough limestone blocks that now cover it, especially at its south-east corner where the ruins of some kind of a tower reach nearly 5m above the surrounding surface. Several soundings were opened in this area in 2010 which brought interesting information about its plan and chronology (see QP 2010 report). Its function is not clearly established yet, possibly the residence of the governor of the city.

To the south includes: the mosque itself in the south-east corner; a low courtyard to the north-east against the courtyard of B13, at shore level; a high courtyard in the western half of the unit, with secondary structures; and an intermediary area against the north-west corner of the mosque between both courtyards, at the level of the high one and with a retaining wall above the low one. The main access was located in the north-west corner of the upper courtyard against the B13 unit, at the extremity of the main street of the city (see above), but other gates were connecting the beach to the northern low courtyard.

The mosque proper appeared on the ground as a rather even area, without lines of walls or heaps of collapse, but with quite a lot of plaster

fragments; as a matter of fact, B12 is one of the few structures which appear as a white spot on the black and white aerial view of the site. The surface is strongly sloping from west to east. Its western limit appeared as a slightly elevated north-south line (about Δ 17.00), with a short slope westwards until the level of the western courtyard, c.1.00m down (Δ 16.00), and a rather steep and irregular slope eastwards until its eastern limit on the beach, at Δ c.12.00, 1m up the beach. The southern limit was also rather clear, lined by a straight street, but the northern one over the low courtyard appeared rather confused.

Excavations of the Qalhât Project in 2008-2011 showed that the prayer hall of the mosque was built on a massive basement, c.4-5m high. This basement was erected on the bedrock, after all the preceding layers of occupation in the depression, c.2.5m thick at that time, and all existing structures including the ancient Friday mosque, were dug out and thrown away to the sea, east of the line of the qibla wall of the new construction. This explains why the north courtyard, at bedrock level, was much lower than the west courtyard, established at the level of the preserved existing surface. The basement was divided into six spans by five north-south walls, the two western spans, on the qibla side, being backfilled, and the four eastern ones, on the sea-side, empty as under-floor rooms. The prayer hall was standing on top of the basement, 4-5m above the beach and north courtyard, 1.5m above the west courtyard, with seemingly five rows of four columns based on top of the underlying spans walls, forming five naves and six bays. When the mosque was sacked by the Portuguese and then collapsed, the superstructures of the prayer hall fell down, on the floor of the two western bays of the prayer hall on top of the backfilled spans, and inside the cellars under the six eastern bays. This part was later eroded and washed down to the sea, thus creating the steep slope of the present surface. The QP excavations also proved that the basement was lined to the north by a north wing. It included access rooms connecting the north courtyard to the cellars inside the basement, between a spiral staircase linking the upper courtyard to this down level to the west, and the base of a minaret to the east.

The main question arising when excavating the mosque was the way the prayer hall was accessible from the courtyards. No door was visible in the qibla wall which could have produced a rather easy access from the high courtyard. Access must therefore have been located in the north side, a staircase or a ramp connecting the northern low courtyard to the musalla more than 4m higher, but no trace of it had been found in the soundings opened in the area during the QP excavations.

- Chronology and dating

The first sounding (S1) opened in 2008 in the area of the mosque, against the outer face of the qibla wall, allowed a chronological study of the area and the dating of the mosque. It was dug down to the bedrock, which is

here 1m higher than on the sea-side (level Δ 11.50), and six chronological phases were identified on more than 5m of archaeological deposits (fig. 19).

The two earliest phases show thin successive layers of occupation, which

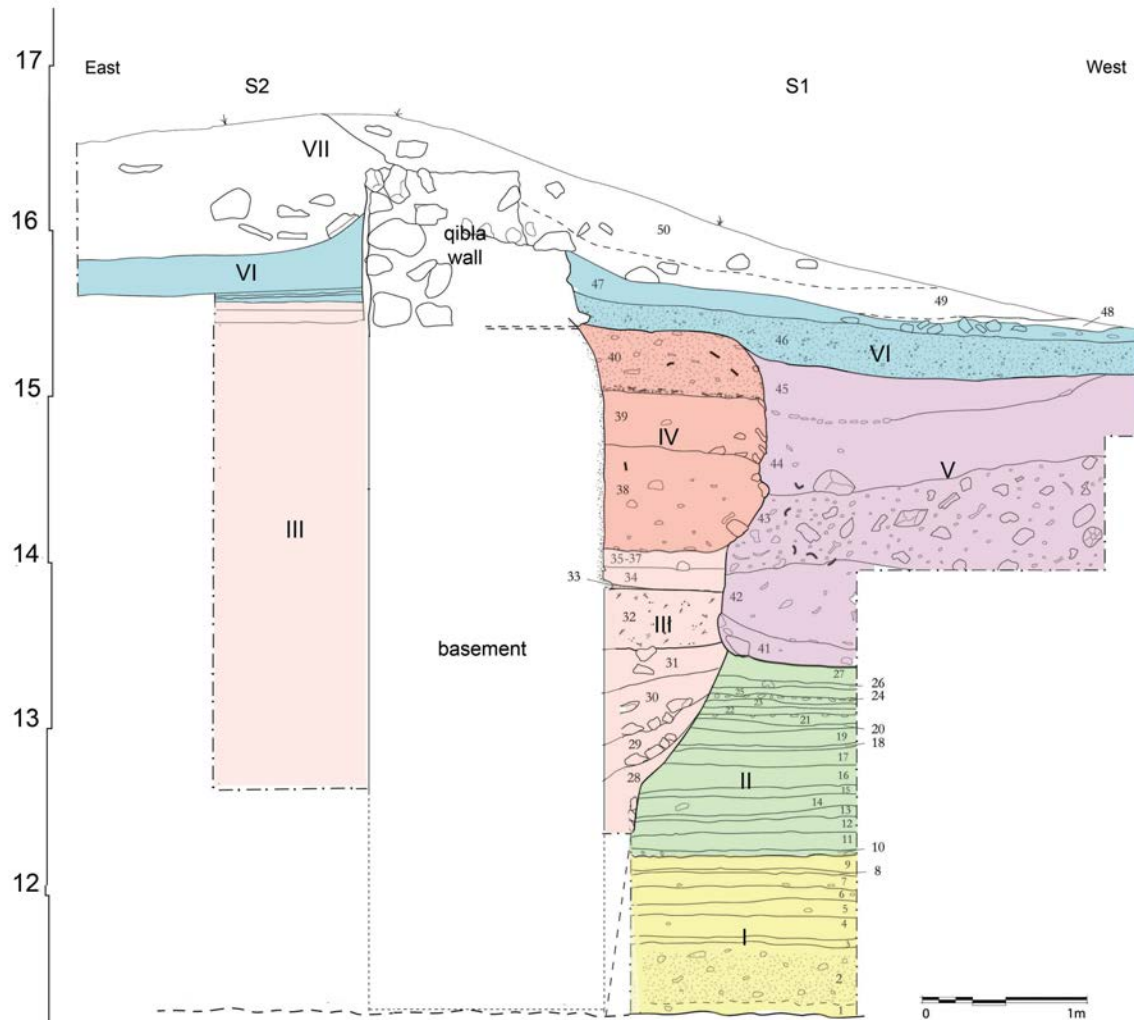

Fig. 19 - Section of the stratigraphical sounding S1 against the qibla wall of the great mosque

were divided according to the associated ceramic material. The lowest ones (layers 1-9), 1m thick, are characterized by the presence of Iranian sgraffiatos of hatched, champlévé and green monochrome styles, which may be dated to about the twelfth century. The upper layers (10-27), 1.50m thick, are characterized by the apparition of the Mustard Ware, a Yemeni production which was produced in the area of Aden or Zabid from c.1250 to c.1350.

The mosque was built in phase III. The levels of the earlier phases I-II were cleared out down to the bedrock and the basement was built in this excavated area. It is here 4m high, with 2.5m of foundation down the original surface, and 1.5m protruding from this surface of the west

courtyard, this part covered with a strong grey coating. The empty part of the foundation trench (levels 28-32), the occupation layers against the base of the wall (level 33-37), and the backfill inside the western span on the other side of the wall, delivered Mustard Ware sherds and some Chinese imports which may be dated to the end of the 13th and the 14th centuries. The qibla wall proper was built on top of the basement, starting at Δ 15.50.

It is therefore clear that the mosque was built some time after the apparition of the Mustard ware around 1250, and some time before its abandonment around 1350. This date range may be narrowed by the dating of the Iranian glazed tiles which were used in the decoration of the mosque, produced in the Kashân kilns at the end of the 13th and the beginning of the 14th century. The construction of the Friday mosque may therefore be dated to around 1300, under the reign of Ayâz and Bibî Maryam as mentioned by Ibn Battuta.

Later, in phase IV, three layers of backfill (38-40) were deposited in the west courtyard, altogether 1.5m thick, i.e. raising the level of the courtyard up to the summit of the basement which was no longer visible on that side. Then in phase V a large pit 2m deep was dug in these backfills, down to level 27 of the phase II occupation, which was refilled with several layers (41-45). According to the associated ceramics both phases IV and V may be dated to the 14th century. Eventually the qibla wall was renewed with a strong and thick coating and two layers of occupation (46-47, phase VI) piled up against the base of the wall before the mosque collapsed definitely (phase VII, levels 48-50). The associated material of phase VI is unfortunately undiagnostic and does not give any clue for the dating of the restoration of the qibla wall.

2.2. The main entrance and building B95

The assumed main entrance to the B12 complex is set in its north-west corner, in the close vicinity of the B13 complex and in front of one of the city's main streets that runs from the main city gate (B31) to the Friday Mosque. It consists of a narrow passageway between the north wall of B95 (B95-03) and the south walls of the B13 complex (B13-01 and B13-02), from 3,60m to 3,80m wide and about 13m long. Several structures for seating or resting are built on each side of this passageway, hence a shortening of the useful width from 2,5m at west to 1,5m at east in the last state of use. The original street level was partly found at the east about 2m lower than the actual ground level and archaeological observations strongly indicate that the street has a steep slope (fig. 20).

In the south-west of the passageway, leaning on the wall B95-03, a poorly preserved rectangular structure (B95-16 ; 3,30x1,10x0,40) is quite probably a seating bench (fig. 21). While the back of it is simply made by the external facing of the wall B95-03, east and west borders are made by

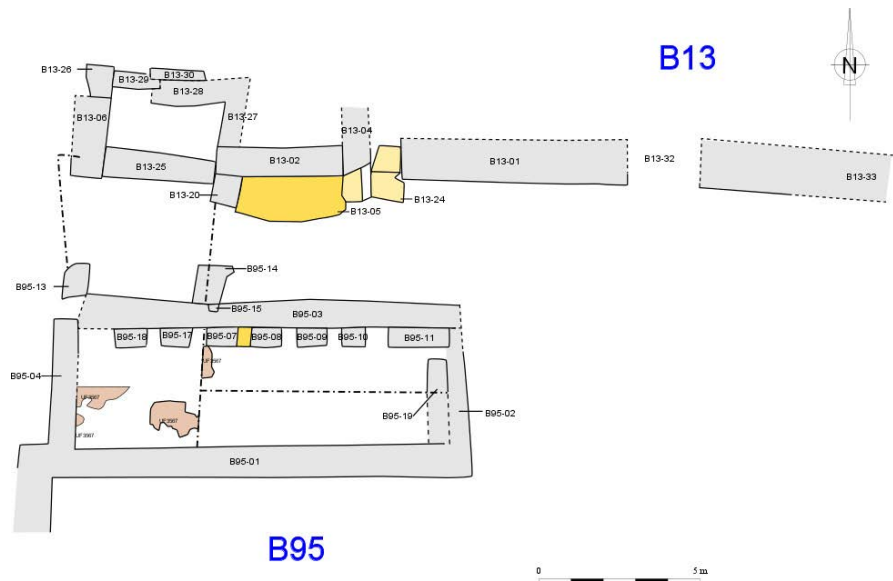

Fig. 20 - Ground plan of the Building B95 and the passageway B95-B13

two pillars made of corals bounded with mortar and without traces of coating. While the relations between B95 and the east pillar (B95-13 ; 1x0,75x1,20) are not fully known due to state of preservation and progression, the west pillar (B95-14 ; 1,20x0,85 to 1,10x1) is clearly built against the wall B95-03 and sealed a gutter (B95-15 ; 0,30x0,20x1,20), showing that the seating bench is a second stage of construction (fig. 22) . Between these two pillars, a small wall (probably about 0,30m wide and around 0,50m high) parallel to the wall B95-03 was existing but is only shortly preserved on the east side, the rest of its course being vanished. The interior of this quadrangular structure was afterward filled by pebbles (UF 3568) to created a bench. Though heavily damaged, it can be assumed that the original altitude of the seating place was around 16,50m and so about 0,50m above the street level.

West of this bench beyond the pillar B95-14, another long bench (B95-12) is build against the wall B95-03, possibly in the same time as the pillar B95-14. This yet incompletely excavated structure is around 1,10m wide for a minimal length of 7,40m and could continue along the west side of B95. At an average altitude of 16m, the top of structure is lower than the western seating bench B95-16, thus following the natural slope of the street.

Right in front of this bench, a third much well preserved one (B13-05 ; 3,30x1,40x0,80) stands in the north-west part of the passageway, leaning on the south side of the complex B13 (fig. 23). While the back of this bench is made by one (B13-02) of the south walls of building B13, the west side is leaning on a pillar (B13-20 ; 0,90x0,80x1,60) made of random mixed limestones and corals bounded with mortar and showing remains of



Fig. 21 - The bench B95-16



Fig. 22 - The gutter B95-15



Fig. 23 - The bench B13-05

coating. The south and east sides are made by a L-shape low wall leaning on walls B13-02 and B13-20 thus creating a rectangular structure filled probably with pebbles and finally covered with a strong beige coating. The east side of the structure is slightly higher for making an armrest while the west part may have been rebuilt or extend after the construction of pillar B13-20. At an average altitude of 16,10m with a gentle slope from back to front, the bench 13-05 is immediately west of a gate with threshold (respectively B13-31 and B13-21, B13-23 and B13-24) that gives way to the complex B13, an architectural pattern (access gate with outside bench) common in Qalhât.

In the north-west part of the passageway, a recess was either closed or transformed into a largest bench, the poor state of conservation of this area unhelping a full comprehension of this part, which shows several stages of construction (fig. 24). The west side of this recess is made by two walls (B13-06 ; 2,15x0,60x1,30 and B13-26 ; 1x0,80x1,10) both built with random limestones and corals, the northern one B13-26 leaning on the southern one B13-06 and being then a subsequent addition. The east side is



*Fig. 24 - The bench
B13-25*

made with a wall (B13-27 ; 2,30x0,60x0,70) which leans on the north-west corner of wall B13-02) and is clamped with the wall B13-28 (2,20x0,80x1,20) which makes quite the half of the northern back side, both walls being made of random limestones and corals bounded with mortar. It is yet impossible to state if the wall B13-28 was firstly extended until the west walls B13-06 and B13-26 or if a narrow passage first exist between them, but in a later stage of construction the space between B13-26 and B13-28 was closed by the small wall (B13-26 ; 1,60x0,60x1,90). In another stage a third wall (B13-30 ; 1,70x0,40xunknown) was built above both walls B13-28 and B13-29. Finally, a low wall (B13-25 ; 3,50x0,70x1,20) made of limestones and corals bounded with poor mortar

and badly preserved, was built, either to close the recess or turning it into a large bench about 3,50m long (east to west) and 2,30 wide (north to south). The leaning of the wall B13-25 on the wall B13-20 clearly states that the sealing or transformation of the recess B13-005 occurred in one of the last stages of construction. This area can be considered to be part of the complex B13 and the best way to fully understand the use and chronology is to extend widely the excavations. It has therefore been decided to stop the work here and wait for the future complete excavations of the complex B13.

As pillars B95-14 and B13-20 are built in front of each other, it is strongly possible that they were built in the same time, in order to create an internal division inside the passageway. A lintel or an arch might have surmounted those pillars and then making an internal gate. But no conclusive evidences are yet found. Also no clues about the possible roofing of the passageway have yet been discovered. Moreover, as no remains of decoration or architecture were found, there is a high possibility that the main entrance was of quite poor monumentality.

The building B95 sets in the north-west corner of the complex B12, right south of the main entrance, is a rectangular building. It is 13m long (east-west) by 5,50m wide (north-south), walls included. The north wall (B95-03, common with the passageway), the west wall (B95-04, which is part of the enclosing wall) and the south wall (B95-01) are well preserved and have no trace of gate, indicating that access to the building was located the east side, where the walls (B95-02 and B95-19) are very badly preserved (fig. 25).

The south wall (B95-01 ; 13,10x0,80x1,80) is mainly made of corals bounded with mortar and coating is preserved in the lower part. In the south face, horizontal wood beams are still in place, dividing the wall in two parts, the upper one slightly overhanging the lower one, an



Fig. 25 - General view of the building B95

architectural feature still visible in old Omani house, probably to reject the rain water flow away from the wall's foundation (fig.26). In the north face of the wall, a similar horizontal wood beam is only documented by its print.

The east wall (B95-04 ; 4x2,80x2) is linked with wall B95-01 and mainly made of coral bounded with mortar containing many ceramics, a yet unexplained cavity being visible between the bottom of the wall and the top of the underneath floor. The north wall (B95-03 ; 11,45x0,90x1,80) is probably clamped with the wall B95-04) but is too badly preserved at its



Fig. 26 - The south wall B95-01 with the beams

western extremity to be affirmative. Seven pillars are built against its southern face, creating seven recesses between them. The westernmost pillar (B95-18 ; 0,95x0,60x1,50) is built 1,10m east from the internal north-west corner of the building (1,10m being then also the width of the western recess). The second pillar (B95-17 ; 1x0,60x1,60) is 0,40m further east of B95-18, the third one (B95-07 ; 0,95x0,60x1,70) is 0,45m eastern, the fourth one (B95-08 ; 1x0,60x1,75) is 0,40m eastern, the fifth one (B95-09 ; 0,95x0,55x1,95) is 0,45cm eastern, the sixth one (B95-10 ; 0,70x0,60x1,95) is 0,45m eastern while the last and seventh one (B95-11 ; 1,90x0,60x1,40), a little longer than the others, is 0,70m eastern and built in the internal north-east corner. All these pillars are rather similar in components (corals bounded with mortar) and create recesses of merely the same size (0,40m wide). The bottom of these recesses, which altitude varies from 16,45m between pillars B95-18 and B95-17 to 15,65m between pillars B95-10 and B95-11, is made by a level of limestones bounded with mortar which end in the same alignment than the south faces of the pillars and there is a possibility that the constructed base of the recesses could be a single construction that runs under the above pillars (fig. 27).

The shape of the recesses and the presence of prints of wood beams hardly suggest that wooden shelves stood there, giving then information about the possible use of the building B95 and the difference of altitude between the bottom of the recesses also indicates that the ground level must have followed a similar slope.



Fig. 27 - General view of the northern pillars

The east wall (B95-02 ; 3,60x0,60x0,80) is the less well preserved and undoubtedly gave access to the interior of the building B95. A parallel wall (B95-19) leaning on the wall B95-02 was partially observed and could be related to the access of the building. The excavations being there incomplete, the modalities and shape of access are unknown and there is a risk that the decay of the building will not allowed a full understanding of the area, even after complete excavations.

A really damaged coated floor (B95-28) was partially observed in the west internal part of the building, at an average altitude of 16,15m. Where this ground is damaged, it can be observed that it is covering levels of backfill made of compacted soil (UF 3557 and UF 3565) or levels of wasted material of the construction phase (UF 3563 and UF 3566). In the east internal part of the building, slight traces of similar coated been have been observed over a backfill mainly made of unbounded stones, but further investigations are required to be more conclusive (fig. 28).

The row of shelves excluded, the internal useful surface of the building is around 33m sq.

2.3. The courtyards and building B139

The main part of the complex B12 is occupied by two courtyards, the largest and higher one (B12-HC) set in the west and north, the smallest

*Fig. 28 - General view
of the building B95
with the coated floor
at foreground)*



and lower one (B12-LC) set in the north-east (fig. 4). Their general shape is an upside-down L that surrounds the Mosque building settled in the south-east. Alongside the western part of the north wing of the Mosque, more or less preserved walls create a small internal division inside the high courtyard (B12-LC) which can be considered as an inner high courtyard (B12-D).

Boundaries of these courtyards are differently known. The courses of the western half of the south (B139-02) and of the west (B12-186) enclosing walls are known and the western half of the north limit is obviously the south enclosing wall of the complex B13 (B13-01, B13-33 and walls in the passageway of the main entrance). In the south-east corner, the limits are the western wall of the Mosque building (B12-01 and B12-02, i.e. the qibla wall) and the northern walls of the rooms and structures which are gathered into the north wing of the building B12 (see below). To the north-east, facing the seashore, a highly leveled wall (B12-11) is surely remains of the eastern enclosing wall and, as no traces of constructions are yet visible, there is a strong probability that the eastern wall of the Mosque was directly opened to the beach, without parallel enclosing wall.

The limits in the north-east corner of the complex are yet unknown, as no particular relief is visible. It is possible that the limit is in the same alignment than the wall B13-33 and thus marked by a highly collapsed wall, but the courtyard could also extend northerly in its eastern half.

Separation between the high courtyard (B12-HC) and the low courtyard (B12-LC) is also not yet entirely known. Its southern half, which is part of the inner high courtyard (B12-D), is made by a high retaining wall (B12-67) while its northern half is yet under a natural inclined plane that has to be left in place until the end of excavations and conservation works. It is very likely that the actual inclined plane covers either a simple lower inclined plane connecting the two levels of courtyard or a constructed structure such as a stair.

The high courtyard (B12-HC), which occupied more or less the western half of the B12 complex, is upside-down L-shaped if the inclined plane is considered to be part of it and the inner high courtyard is excluded. The west limit is well marked by the enclosing wall (B12-186 ; 38,20x2x1,20), mainly made of corals bounded with poor mortar and showing no traces of coating or decoration, that runs from the building B95 in the north-west corner to the building B139 in the south-west corner (fig. 29). The stones are put together in a rough facing except in the middle of the wall where this facing is missing. It is very likely that a protruding constructed structure stood there and disappeared with the collapse of the wall. The south extremity of wall B12-186 is flanked by a smaller wall (B12-201 ; 4,30x0,75x0,30) made of limestones and corals bounded with soil which could be part of an access system from the outside and building B139 to



Fig. 29 - General view of the high courtyard and the enclosing wall B12-186)

the high courtyard .

The south limit of the high courtyard (B12-HC) is less well marked by a badly preserved and not entirely excavated enclosing wall (B139-02 ; 21,10x1,10x1,20) which runs from the building B139 at the west to the south-west corner of the Mosque at the east. This wall is made of limestones and corals put in a rough facing bounded with sandy soil. No opening through this wall are known for the moment.

The maximal length of the high courtyard (B12-HC) is 53,30m from the south wall (B13-01) of the complex B13 at the north to the southern enclosing wall (B139-02) and the width varies from 30m at the south between the west enclosing wall (B12-186) to the qibla wall (B12-01 and B12-02) to 22m in the middle between the wall B12-186 and the wall B12-65 which delimits the inner high courtyard (B12-D) and to nearly 40m in the north from the wall B12-186 next to building B95 to the east

end of the inclined plane. The useful surface of the high courtyard (B12-HC) is around 1340m sq, building B95, building B139, and inner high courtyard (B12-D) excluded but incline plane included, and altitude varies from 16m around the west enclosing wall (B12-186) to 14,60m around the inner high courtyard (B12-D).

The inner high courtyard (B12-D) is a division of the high courtyard (B12-LC) set alongside the north-west corner of the Mosque, the northern walls (B12-58 and B12-168) of the north wing being so the south limit of the inner high courtyard (B12-D). The east limit is made by the retaining wall (B12-67 ; 8,10x1,20), made of limestones bounded with mortar, which is only preserved for only one course of construction on its west side along the inner high courtyard (B12-D) but which overhang the eastern low courtyard (B12-LC) for nearly 1,80m. The north limit is well visible and marked by a wall (B12-62 ; 11,50x1x0,50) made of limestones and corals bounded with mortar and showing fine coating on both side, especially the north one, built over second wall belonging to a prior phase of construction, as known by previous soundings (fig. 30).

In comparison, the west limit is the less visible as the partition wall there is only partially preserved under some scattered stones in the same alignment as the western end of the walls B12-58 and B12-62. There is in fact strong possibility that the wall was originally discontinuous with probably two openings, giving access to the inner high courtyard (B12-D) from the high courtyard (B12-HC).

The maximal internal length of this partition space is 11,30m (east-west)

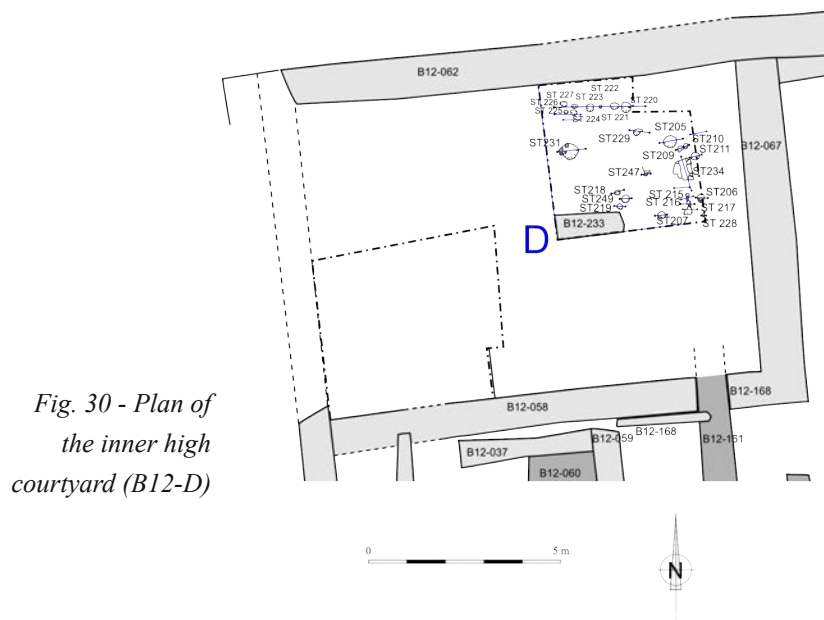

Fig. 30 - Plan of the inner high courtyard (B12-D)

and the maximal width is 8,10m (north-south) for a useful surface of 90m sq, with an actual ground floor at an average altitude of 14,50m.

The low courtyard (B12-LC) sets in the north-east corner of the complex B12 and is probably L-shaped, as it could extend northerly. The south

limits is made by the various structures that composed the north wing which will be described below. The west limit is made by the retaining wall (B12-67) of the inner high courtyard (B12-D) and the two northern perpendicular walls (B12-63 ; 6,50x1,20x1,60 and B12-64 ; 2,90x1,10x0,60) made of limestones and corals bounded with poor mortar which are probably part of the access that links the high courtyard (B12-HC) and the low courtyard (B12-LC).

To the east, a leveled wall (B12-11 ; 13,30x1,30x0,30) made of large limestones and of one reused element of prior masonry, is only preserved for one course of construction and is surely the east enclosing wall of the complex B12. About 3m west of this wall, a trapezoidal structure (B12-198 ; 4,50x2,70x0,30), also only preserved for one course of construction, is probably the first step and only remain of a staircase which was linking the low courtyard (B12-LC) and the upper floor of the Mosque. The underneath wall (B12-199 ; 8,20x0,70x0,60) is probably part of the stair, but further investigations are here required for a full understanding of the area.

The maximal length of the low courtyard (B12-LC) is merely 25m (east-west) from the retaining wall (B12-67) to the leveled eastern enclosing wall (B12-11), while its width is at least 12,40m (south to north) from the northern external wall of the Mosque to the retaining wall B12-63 , but could extend northerly to more than 20m. Its minimal useful surface is at least 330m sq but is very probably larger, and its actual altitude varies from 12,30m at the west to 10m at the east.

In the south-west corner of the complex B12, the building B139 is the gathering of three rather simple rooms or areas, yet not entirely excavated. The first room to be unearthed (B139-A) is the actual easterly known but another room might exists further east. The south back of this square room is made by the south enclosing wall B139-02, the north wall (B139-01 ; 2,90x1x1,20) and the south wall (B139-03 ; 3,10x1,10x0,80), both made of small limestones and corals bounded with sandy mortar, leaning on it. On the north side, a small continuous wall (B139-04 ; 2,80x0,50x0,30) closes the room, with no signs of threshold. Thus access to this room is problematic, either by the roof like it has been seen on buildings B94 and B21, or more likely by a threshold higher than the actual remaining elevation (fig. 31).

About 2,50m wide and 2,80m long internally, the room B139-A offers a useful surface of 6,80m sq (fig. 32).

Immediately west of the previous room, the area B139-B, yet not completed, could rather be a recess than a room properly said. The east limit is made by the wall B139-01 from the room B139-A and the west limit is made by the wall B13-07 from the room B139-C 2m away. As no signs of a dividing structure on the north side, it is very likely that the area B139-B is a simple recess, about 6m sq, between the two rooms B139-A and B139-C. However, as there is yet no strict evidence that the enclosing wall B139-02 is continuous in the south of this area, B139-B could also be

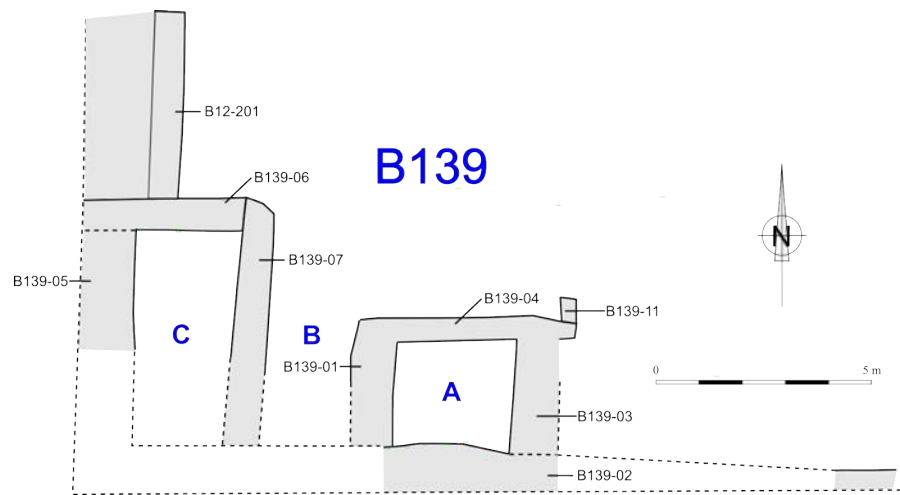

Fig. 31 - Plan of the building B139



Fig. 32 - View of room B139-A

a small passageway giving access to the B12 complex from south (fig. 33). Nestled in the south-west corner of the complex B12, B139-C is a rectangular room, very badly preserved in its northern part and not yet entirely excavated. The south wall is probably the continuity of the enclosing wall B139-02 and the eastern wall (B139-07 ; 5,70x0,80x0,90) is common with B139-B. The west wall (B139-05 ; 5x1,20x0,40) and north wall (B139-06 ; 3,75x0,70x0,20) are badly preserved, from one to four courses of construction. Nearly 5m long and 2,50 wide, the internal useful surface of the room B139-C is around 11m sq (fig. 34). The walls B139-05, B139-06, which is visibly leaning on the west enclosing wall (B12-186), and B139-07 are all clamped and made of small limestones and corals bounded with soil and poor mortar and showing no



Fig. 33 - General view of room B139-B

signs of threshold or access. Regarding to its position, B139-C might be a system of access from the south and west exterior of the complex B12, working with the structure B12-201 right to the north.

For now on, two possible levels of compacted soils have been observed, inside B139-A around the altitude of 15,80m and inside B139-C around 16m.



Fig. 34 - View of room B139-C

2.4. The mosque

After the soundings of the QP campaigns between 2007 and 2011, some

general features of the Mosque were known. The location of the building B12, nestled in the south-east corner of the complex, and its general shape, i-e a square building of nearly side 26m, walls included, built over two storeys, the first one being a basement and the second one being occupied by the prayer's hall. After the discovery of pillars in the prayer's hall and observations on the basement, it was supposed that the internal space of the Mosque was divided into several spans or aisles, five from north to south and six from west to east. As in the basement, the six west to east spans were made by walls and thus more visible than the five north to

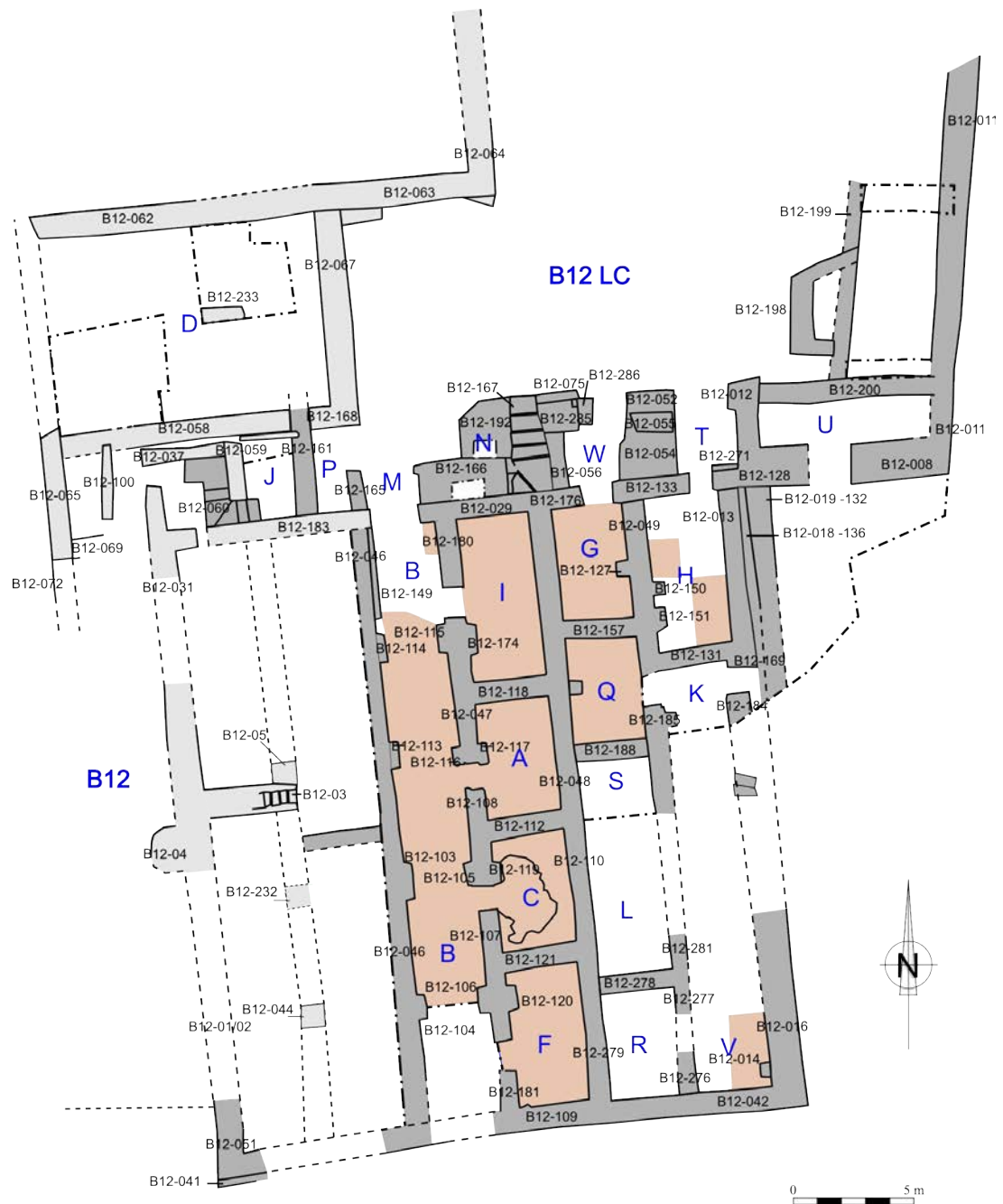

Fig. 35 - Ground plan of the Mosque building

south aisles, it has been decided to take them as the referent for the division of the internal space, and numbered them from Span 1 to Span 6 from east to west.

The QP campaigns also showed that in the basement, the four eastern spans (from span 1 to span 4) were originally empty and entirely filled with the collapse of the buildings, while the two westernmost spans (spans 5 and 6) were backfilled from the beginning. Only over this two spans is the original ground floor of the prayer's hall preserved in place, remains and fragments of it being found from place to place in the basement's collapse.

Along the north side of the building B12, various rooms and areas were gathered into a north wing, which is considered to be an additional wing not strictly belonging to the Mosque, as the prayer's hall was not extended over it (fig. 35).

2.4.1. The basement, span one (Rooms H; K and V)

The span 1 is the westernmost of the basement, facing the seashore and the Gulf of Oman. It is not yet entirely excavated, due to the necessity to maintain access to the westerly spans under excavations. For now on, three rooms are known (from north to south B12-H, B12-K and B12-V) and two others are supposed. The eastern limit of this span is made by the walls B12-13, B12-184 and B12-16, which are all part of the east external wall of the Mosque. Several east-west oriented dividing walls must exist and separate the rooms from each other, but only one (B12-131 between B12-H and B12-K) is yet uncovered. From all spans, this one is the less well-preserved and the will to let in place some interesting IsoArc prevented a complete excavation of the northern rooms.

- Room H

The room B12-H is the northernmost of the span 1 and is not entirely unearthed but can be considered as fully documented. After finding out the courses of surrounding walls and the shape of the rooms, six IsoArc (from north to south, IsoArc 199, IsoArc 200, IsoArc 251, IsoArc 285, IsoArc 277, IsoArc 282, see below), which are remains of octagonal columns and of their square bases, were discovered and left in place, thus reducing the safe space for further excavations. Two small soundings were opened between the IsoArc where there was enough space (fig. 36).

The eastern wall (B12-13 ; 6,40x0,80x1,50), which is also the external wall of the Mosque, is made of limestones and corals bounded with mortar with remains of coating on both sides. Around the north end of the west internal face of the wall B12-13, a rectangular beam print (B12-125 ; 0,20x0,15) is preserved (fig. 37) . Same beam prints were also found in many others rooms and will be further explained in room B.

Along its east outside face, the wall B12-13 is flanked by a dual wall (B12-136 ; 4,80x3,50x0,80), made of limestones and corals bounded with



*Fig. 36 - General view of
room H*

mortar and poorly preserved, which is probably a lining of protection. In case of hard weather conditions, such as salty seawind or high tides during storms, the wall B12-136 may suffer damages but is protecting the wall B12-13 behind. The wall B13-136 may then have known several phases of rebuilding. Further east, a row of massive pebbles (B12-132 ; 3,70x1x0,30) could either be a low seating bench or, more likely, some kind of sidewalk (fig. 38).

The south wall (B12-131 ; 3x0,80x0,80) is common with room K and H and linked with the west wall (B12-49 ; 6,40x0,80x1,80) separates span 1 and span 2. The wall B12-49 is strengthened by two buttresses, the smaller one (B12-150 ; 0,50x0,50x1,80) quite in the middle of the the wall, and the bigger one (B12-151 ; 0,50x0,70x0,80) closed to the south-west corner of the room, more or less in the axis of the dividing aisles of the upper floor.

Inside the basement the northern walls (B12-133 ; 3,20x0,80x1,80 and B12-128 ; 1,10x0,80x1,80), which are part of the north limit of the



Fig. 37 - Beam hole B12-125

Mosque building, are separated by a gate (0,90m wide) which is the only known access to the room H.

All walls are made the same way, IE limestones and corals bounded with mortar, and remain of coating are visible in the lower part.



Fig. 38 - General view of the exterior south

Two soundings, in the south-east corner of the room H and at the bottom of the wall B12-49 and buttress B12-150, were opened and reached the coated floor which altitude varies from 11,25m at east to 11,10 at west (fig. 39).

If the maximal internal dimensions of room H are 6,40m long (north-south) and 3,20m wide (east-west), the presence of the two buttresses

(B12-150 and B12-151) reduce the internal useful surface to 18,80m sq.

- Room K

Located immediately south of the previous one, the room B12-K is only partially excavated and thus not fully documented. Besides the need to



Fig. 39 - The coated floor in sounding 2

maintain, in the south part, a way of access for westerly ongoing excavations, the presence of four massive IsoArc (IsoArc 278, IsoArc 279, IsoArc 280 and IsoArc 281), remains of octagonal columns and square bases, reduce the space. (fig. 40)

The north limit is made by the wall B12-131, common with room H, that shows in its south face a beam print (B12-152 ; 0,30x0,20x0,20). The west limit of the room, which is also the separation between span 1 and span 2, is made by the continuity of the wall B12-49 until a gate which give access to the westerly room Q (see below). The south part of the gate is made by piedroit and buttress (B12-185 ; 0,80x0,60x1,40), while the southern limit is yet unknown.

The east external side of the room is made by the continuity of wall B12-13 and wall B12-184 (1,30x1x1,20), both separated by a gate (1,15m wide) which give access to the room K from the outside. A well preserved threshold (B12-153) (DE36 ; Threshold B12-153) made of big polished pebbles was found, at an average altitude of 10,90m. All walls are made of limestones and corals bounded with mortar and show remains of coating.

Necessaries safety conditions did not allow sufficient space for a sounding wide enough to reach a ground floor. Further excavations will maybe done in the gate between room K and Q and give information about the level of floor in this room.

If the width of the room K is known (2,90m), the state of excavations does not permit to consider the length and useful surface.



Fig. 40 - General view of room K

- Room V

Located in the south end of span 1, the room B12-V was first discovered



Fig. 41 - Threshold B12-153

during the QP campaign and is still under excavations.

The east limit of this room is made by the wall B12-16 (8,10x1,40x0,80) which is also part of the east external wall, while the south limit is made by the wall B12-42 (2,50x0,90x0,80) which is part of the south external wall. A small buttress (B12-14 ; 0,60x0,40x0,40) is present near the south-east internal corner. All constructions are made of limestones and corals bounded with mortar and show very few remains of coating. (fig. 42).

The others limits are not well known yet but a separating wall with a gate

giving access to the westerly room R is more or less visible. No others accesses are visible, especially from the outside, but access to the northerly room of span 1 is highly assumable.

Although the bedrock was reached in this room, no traces of coated floor were found there, which is a particular feature. The current state of excavations is not yet sufficient to give proper dimensions or surface.

2.4.2. The basement, span two (Rooms G, Q, S, L and R)

This span, among the last to be opened, is still under excavations in its southern half. Three rooms are known (B12-G and B12-Q, fully



Fig. 42 - General view of room B12-V

excavated, at north, and B12-R at the south end) and two more (B12-S and B12-L) are strongly assumed in the center of the span.

The east limit of the span is made by the north-south oriented walls that separate span 2 from easterly span 1 (B12-49) while the west limit is made by a long continuous north-south oriented wall (B12-48 also registered as B12-110 ; 24,40x1x2,40) without opening that separate the whole basement in two non communicating parts. Three dividing east-west oriented walls are well known : from north to south : B12-157 (3x0,80x1,80) between rooms G and Q, B12-188 (3x0,80x2) between rooms Q and S and B12-278 (3x0,80x1) between rooms L and R.

- Room G

The room B12-G is the northernmost of span 2 and was excavated in its northern part during the QP campaigns. The west, south and east limits are respectively made by the walls B12-48, B12-157 and B12-49. Quite in the

middle of the wall B12-49 is a small buttress (B12-27 ; 0,70x0,50x2).

The north side is made by the continuity of wall B12-133 and by wall B12-29, both being part of the north external wall of the Mosque. The original space between walls B12-133 and B12-29 was afterward reduced by the construction of wall B12-176 (0,70x0,70x1) (fig. 43). The actual gate through the north side, by the room W and only access to room G, is 1,30m wide. Remains of the threshold (B12-129) was found, at the average altitude of 11,60m (fig. 44).

All walls are made the same way, with a majority of limestones in the lower parts and majority of corals in the uppers ones bounded with mortar, and remains of coating are visible on the lower parts of each of them.

In the north-west corner of the room was found a rectangular structure (B12-173 ; 2,10x1,50x0,30), made by a L-shaped wall leaning on the north



Fig. 43 - View of room B12-G

and west walls and afterward filled mainly by pebbles. This structure is probably a bench and is built above the ground floor and could then belongs to a subsequent phase of construction.

A ground floor mainly made of hard soil (UF 3238) with few remains of a coated floor (B12-289) was discovered, at an average altitude of 11,50m to 11,60m. If the structure B12-173 is excluded, the useful surface of the room G is 10m sq, for a maximal length of 4,70m and a maximal width of



Fig. 44 - Threshold B12-129

2,70m.

- Room Q

Located immediately south of the room B12-G beyond the wall B12-157, the room Q is yet entirely excavated. The west limit is made by the continuous wall B12-48, separating from the westerly span 3, and the south limit is made by the wall B12-188, separating from the southerly room S. A small square buttress (B12-189 ; 0,60x0,55x2) is built against the wall B12-48, more or less halfway.

The east limit is made by the continuity of wall B12-49 and the buttress B12-185, separated by the gate (B12-190) that give access from the easterly room K. A threshold was observed but uncovered, as the section is overhang by a massive IsoArc (514) which will might be removed later.

All walls are made with limestones in the lower part and corals in the upper part, bounded with mortar and remains of coating are visible from place to place in the lower parts.

A very well-preserved coated ground floor (B12-193) was found over all the room, at an average altitude of 11,20m.. The only access is from room K, thus the room Q, whose useful surface is about 12,60m sq. for a maximal length of 4,40m and a maximal width of 3m, can be considered as the backroom of room K (fig. 45). Many postholes were uncovered



Fig. 45 - View of room B12-Q after excavations

inside these room. They will be mentioned below

- Room S

Located immediately south of the room Q beyond the wall B12-188, the room S is only partially excavated and mainly known by previous soundings. The north and west limits are known, respectively marked by the walls B12-188 and B12-48 and the east limit is obviously in the alignment of the walls B12-49 and B12-185. The south limit is however only assumed.

The observed walls, made of limestones and corals bounded with mortar, are in very poor state of conservation and show very few remains of coating.

A badly preserved ground made of hard soil was partially observed and access from the easterly span 1 is strongly supposed. However the state of excavations does not allow to give precises dimensions of the room (fig. 46).

- Room L

This room is the less excavated and documented of all the rooms of the basement. West and south limits are made respectively by the continuous wall B12-48 separating from the span 3 and the wall B12-278 separating from the room R. The east limit, separating from span 1, is obviously in the alignment of the walls B12-49 and B12-185 but the north limit, separating from room S, is unknown.

Excavations stopped on the upper level of collapse and, as the shape of the room is unknown, no precise dimensions can be given.

- Room R

The room is the southernmost of the span 2 and still under excavations,

however its limits are better known than rooms S and L. The west and south limits are the better known, respectively made by the continuous



*Fig. 46 - View of room
B12-S in March 2014*



*Fig. 47 - View of room
B12-R in March 2014*

wall B12-49 (here registered as B12-279 ; 4,45x0,90x1,50) and the south external wall B12-42 (here 2,80x0,90x0,90). The north limit is made by the wall B12-278 and two portions of walls were partially observed on the east side (B12-276 ; 0,80x0,70x0,30 and B12-277 ; 1,10x0,80?x0,45) probably separated by a gate which will be the only access to the room, from the room V.

All the walls are build in the same way, with limestones and corals with apparently less internal organization, bounded with mortar and showing a well-preserved coating.

A large piece of wall (IsoArc 385) that probably came from the upper part of the wall B12-49, will be left in place, but there will probably be enough space in the south part to excavate to the ground floor.(fig. 47)

The room R, which is probably the backroom of the room V, seems to be a little smaller, 4,40m long by 3m wide with a useful surface under 14m sq.

2.4.3. The basement, span three (Rooms I, A, C and F)

The span 3 is separated from the span 2 by the continuous north-south oriented wall B12-48 and contains four rooms (from north to south rooms I, A, C and F) of different size, each of them reachable, by the span 4. The west limit is made by a north-south alignment of several walls and gates that separate the rooms of the span 3 from the span 4. Four buttresses were unearthed on this side, symmetrical with four others of the span 4, all on the axis of the supposed aisles of the prayer's room made by alignment of pillars, an architectural feature which is less visible in the eastern part of the basement, beyond the wall B12-49.

The north limit is made by the wall B12-29, which is part of the north external wall of the Mosque, and the south limit is made by the wall B12-109, which is part of the south external wall. There are three east-west oriented dividing walls : B12-118 (3,15x0,80x1,20) between rooms I and A, B12-112 (3,15x0,80x1,90) between rooms A and C and B12-121 (3,20x0,80x0,90) between rooms C and F.

- Room I

This room is the northernmost room of the span 3 and the largest. Its limits are made to the north by the wall B12-29 (3,20x0,70x1,40), which is part of the north external wall, to the east by the continuous wall B12-48 (6,90x0,80x1,60) and to the south by the wall B12-118.

To the west, the limit is made by the wall B12-180 (2,80x0,80x1,60) in the northern part and the north half of wall B12-47 (2,70x0,80x1,40) in the southern part, both walls being separated by the gate, 1,20m wide, that gave access to the room from the span 4. Immediately south of that gate, the wall B12-047 is thickened by a buttress (B12-174 ; 1,10x0,40x1,40).

All walls are made by limestones, concentrated in the lower part, and corals in the upper part, bounded with mortar and showing important remains of coating. (fig. 48)

In the northern and southern parts of the room I, a strong ground floor made of coating was found, at an average altitude of 12,25m, but this ground floor is hardly damaged and vanished around the gate where it may have suffered destruction by fire. From place to place can be seen cracks between the ground floor and the bottom of the coated wall, suggesting a subsidence due to the slight drop of the underneath backfill.

Inside the gate between room I and span 4 was found a threshold (B12-170 ; 1,20x0,80x0,30) made of a dozen of large polished pebbles bounded



*Fig. 48 - View of room
B12-I*

with soils. Its average altitude is from 12,60m to 12,75m and as it lies upon layers of charcoals and of damaged coating which could be original ground floor, the threshold B12-170 is quite probably a late rebuilding. (fig. 49)

6,80m long (north to south) and 3m wide, the room I offers a useful surface of nearly 20m sq.

Along the wall B12-48 and leaning on it, a massive remains of wall (IsoArc 295) was left in place. This fragment of a coated wall with architectural feature of gate, obviously came from the upper part of the wall B12-48. Its actual size, combined with observations on other remains of walls in room L or R, clearly states that the continuous wall B12-48, was originally raising higher than the altitude of the observed upper floor and thus dividing the second storey of the Mosque in two parts, following



*Fig. 49 - The threshold
B12-170 half-excavated*

the course of wall B12-48, the eastern part over spans 1 and 2, the western part above spans 3 to 6.

- Room A

Immediately south of room I, beyond the wall B12-118, the room A was partially documented by the QP campaigns. North, east and south limits are respectively made by the walls B12-118, the continuous wall B12-48 and wall B12-112, separating from southerly room C.

The west side is made by the south half of the wall B12-47 (4,70x0,80x1,60) in the north part and by wall B12-108 (1,40x0,80x1,95), both wall being separated by the gate (B12-267), 1,10m wide, that gives access to the room A from span 4. Immediately north of the gate B12-267, the wall B12-47 is thickened by a buttress (B12-117 ; 0,80x0,40x1,50).

All walls are made of limestones and corals bounded with mortar and show very well-preserved coating on every faces. (fig. 50)

A fine coating perfectly preserved was discovered over the entire surface of room A, showing quite no traces of damage, at an average altitude of 11,90m, room A being so the lowest room of the westerly spans of the basement. The link between the coated floor and the coated walls is also well-preserved, showing that the room A suffered no subsidence.

The north and south piers of the access gate (B12-267) of the room A keeps remains of the wood prints positioned along them, while the threshold shows two beam prints (about 0,30m deep, 0,15m high and 0,05m wide) of the threshold's sill plate. It can then be assumed that a wooden frame was built against the walls and threshold, inside which was fixed the hinges of the wooden panels of the door, an architectural feature easily visible in old omani houses. Two rabbets are visible on both piers and must be the place where the two panels of the door were nestled. (fig. 51 § 52)



*Fig. 50 - View of room
B12-A*



*Fig. 51 - The
threshold B12-267*



*Fig. 52 - The threshold
B12-267*

As the ground floor is higher in span 4 than in room A and even the coated threshold is damaged, it is very likely that the sill plate was sustaining the difference of altitude by making a step about 0,20m high.

About 4,80m long, from north to south, and 3,20m wide, from east to west, the room A offers a useful surface of 14m sq.

- Room C

The room C is located immediately south of room A, beyond wall B12-112 which is its northern limit, east and south limits respectively made by the long continuous wall B12-48 (here named B12-110 ; 11,45x0,80x0,80) and wall B12-121, common with southerly room F.

To the west, the limit is made by the south part of the wall B12-108 (1,80x0,90x1,20) in the northern half and by the north part of wall B12-107 (1,80x0,80x1,30) in the southern half, both walls being separated by the gate (B12-230), 1m wide. Immediately north of the gate B12-230, the wall B12-107 is thickened by a buttress (B12-119 ; 0,80 to 0,90x0,40x1,60). All walls are made of limestones and corals bounded with mortar and show well-preserved coating in the lower part of every ones.

A massive remain of Styles A and J pillar (IsoArc 207, see below) that occupied the center of the room C was methodically dismantled while a Style J column drum (IsoArc 134) was slowly taken down and stored in the south-east corner of the room, giving enough safe space to excavate



Fig. 53 - View of room B12-C in December 2013

until to the ground floor (fig. 53).

Two different levels of coated ground floor were discovered. The first one (B12-250), made of coating, is visible around the gate B12-230 and in the center of the room, where the second floor (B12-256), also made of the same coating, is damaged. The second floor covered the rest of the surface of the room and all linking between it and the bottom of the coating of the walls are cracked, showing that the room suffered an important

subsidence, due to the slight drop of the underneath backfill. The two ground floor are separated by scattered remains of vegetable material which should be organic weaving, suggesting that a carpet covered the



Fig. 54 - View of room B12-C after excavations

first floor (B12-250) before the construction of the second floor (B12-256). The altitude of these ground floors varies from 12,50m closed to the walls to 12,20m in the middle (fig. 54).

The same features as in the gate are visible in the door B12-230 of room A. North and south piers of the door B12-230 keep the prints of the piece of wood which was leaning along them and the beam prints (about 0,10m deep, 0,10m wide and 0,10m high) of the sill plate is visible at the bottom of each pier. As in gate B12-267, a wooden frame was leaning on piers and threshold and support the fringes of the wooden panels of the door, which probably nestled in the rabbets of the gate B12-230 (fig. 55 § 56).

The ground floor being higher in room C than in the westerly span 4, it is very likely that the sill plate of the threshold also created a step about 0,10cm high, as in room A.

In the actual state of knowledge, the rooms A and C are the only known rooms with such a sophisticated system of closure.

About 4,60m long (north to south) and 3,20m wide, the room C offers a useful surface of 14m sq, the same size as room A.

- Room F

Located immediately south of room C, beyond the common wall (B12-121), the room F is the southernmost of span 3. The east limit is made by the continuous wall B12-48 (here named B12-279 ; 5,60x0,90x1,40) and the south limit is made by the wall B12-109 (3x1,10x0x70) which is part



Fig. 55 - The threshold B12-230



*Fig. 56 - The threshold
B12-230*

of the south external wall.

The west limit is made by the south part of the wall B12-107 (2,80x0,80x1,70) in the northern half and by the wall B12-181 (1,40x0,80x1,60) in the southern half, both walls being separated by the gate, 1,20m wide, which give access to the room from the westerly span 4. About 1m north of this gate, more or less in its middle, the wall B12-107 is thickened by a buttress (B12-120 ; 0,80x0,40x1,70). This gate is still under excavations, thus its features are still unknown.

A massive remain of a Styles P and O pillar was left in place, more in less in the center of the room.

All walls are made of limestones and corals bounded with mortar and show remains of a quite well-preserved coating in the northern half and more damaged in the southern half. (fig. 57)

A ground floor made of coating was discovered over the whole surface of the room but it is very damaged in the south half. The average altitude of this ground floor is around 12,20m, and scattered cracks between it and the bottom of the coated walls suggest that the room suffered a short

*Fig. 57 - View of room
B12-F*



subsidence.

Around 5,80m long (north-south) and 3m wide (east-west), the room F offers a useful surface about 16,80m sq.

2.4.4. The basement, span four (Room B)

This span, the westernmost of the empty spans of the basement, revealed to be a long single room (B12-B), reachable from the outside by a north opening and maybe by a south opening, and give access to all the easterly rooms of span 3. Still under excavations in its southern extremity where important architectural remains are still in place, the span 4 can be seen as an internal covered street that crossed the basement of the Mosque.

The east limit of this span is made by the alignment of the western walls of the rooms of the span 3 while the east limit is made by a long continuous wall (B12-46 ; 24,75x0,90?x2) which separates the easterly empty spans from the westerly backfilled spans 5 and 6. The north limit is made by a small continuity of the wall B12-29 and the side facing of the wall B12-183, both being part of the north external wall, separated by a large gate, 2m wide, that give access to the span 4 from the low courtyard (B12-LC);

The west wall (B12-46) is made of limestones, more present in lower part, and corals, more present in upper parts, bounded with mortar and showing coating differently preserved along its course, the part worst preserved being to the north. The coating and facing of the wall is there almost entirely vanished, and a low flanking wall (B12-149 ; 4,40x0,30x0,40) was built probably to reinforce the wall. Another possibility is that a very damaged gate might gave access to a westerly room.

Three massive remains of Styles A and J pillars were found and



*Fig. 58 - View of room
B12-B*

methodically dismantled (IsoArc 100 and IsoArc 321 in the middle of the span and IsoArc 131 little southerly) and other remains are still in place in the yet excavated southern one-sixth. (fig. 58)

Eight buttresses were found in this span, four on each east and west sides. The four eastern buttresses, which are from north to south B12-115 (1,10x0,40x0,90), B12-116 (0,80x0,40x1,75), B12-105 (1x0,40x1,50) and B12-106 (1,10x0,40x1,70), are symmetrical to the four buttresses of the span 3, and the four western buttresses, which are from north to south B12-114 (1,10x0,50x1,95), B12-113 (1,20x0,40x1,40), B12-103 (1,40x0,40x1,80) and B12-104 (1x0,50x1,90), are built in front of the aforementioned eastern buttresses.

All buttresses of the basement have more or less the same dimensions (around 1m long and 0,40m wide) and the distance between them is is approximately 4m. Their disposition in the axis of the aisles of the prayer's hall clearly suggests that they were made to support the weight of the

above pillars which divided the internal space of the prayer's hall and supported the roof of the Mosque. The south-western buttress B12-103 is the longest and was visibly expanded, presumably to strengthen the continuous west wall B12-46, which maintain huge levels of backfill and may have suffered a weakness.

Eight beam prints were also found in the elevation of the wall, and two more are strongly assumed. Four of them are found in the east side : B12-130 north of the gate leading to room I, B12-121 halfway between the gate to room I and the gate to room A, B12-171 south of the gate leading to room A and B12-160, north of the gate to room F. Three beam prints were found in the west continuous wall B12-46, in front of the easterly beam prints, and are from north to south B12-122 in front of B12-121, B12-172 in front of B12-171 and B12-159 in front of B12-160, and a fourth beam



*Fig. 59 - Beam hole
B12-122*



*Fig. 60 - Beam hole
B12-130*

print is still partially observable in the damaged facing in front of B12-272 (fig. 59 § 60).

All beam prints have more or less the same dimensions (0,10c long, 0,05cm high and 0,25cm deep) and they are built around 1,40m above the bottom of the walls, which is more or less shoulder's height, clearly stating that these prints can not belong to a roofing system. More likely, small projecting beams must have stood there, used for hanging bags or clothes, or torch, candlelight or more probably oil lamp, to give light in a probably dark place.

Such feature is known in room H (B12-125) but no traces of it was found in the other rooms, even when the walls are preserved over more than 1,40m high, thus the enlightenment of these rooms is problematic.

A ground coated floor (B12-100 and B12-108) unequally preserved was found on the whole surface of the span, with some important damaged part. The coated floor is strong and well preserved in the south and center of the room but is more damaged to the north, and vanished from the gate to room I to the external north gate. A small part is preserved in the north-east corner of the room. Where the coated floor is damaged, layers of backfill made of pebbles, soils and ashes were observed.

The altitude of the coated ground floor of room B varies from 12,50m at south to 12,30 at north, and the linking with the bottom of the coated walls shows evidence of a slight subsidence.

Even if not entirely excavated, general dimensions of the room B can be assumed. At least 24,50m long and little less than 3m wide, the room B, which occupies the whole span 4, offers a useful surface of nearly 68m sq.

2.4.5. The prayer hall

Partially documented during the QP campaign and little excavated during this season, the prayer's hall occupied the upper storey of the Mosque and its floor is only preserved over the two westerly spans 5 and 6, the rest of it having collapsed into the basement.

The mihrab (B12-04), the minbar (B12-03), part of the qibla wall (B12-01 and B12-01) and a damaged coated floor was uncovered by the QP campaigns, afterward recovered, and uncovered again during this session. (fig. 61).

Three square bases of pillars were also found in place, B12-05 (1x1x0,60) right north of the minbar (B12-03), B12-44 (1x1x0,30) and B12-232 (1x1x0,40), all in the same alignment about 3m east of the qibla wall (B12-01 and B12-02), with a spacing around 4m, giving thus the general pattern of the internal division of the prayer's hall and distribution of the pillars that supported the roof (fig. 62 et 35).

As seen above, the long continuous wall B12-48 originally divided the



Fig. 61 - View of the mihrab



Fig. 62 - Pillar B12-232

space of the second floor in two unequal parts, the largest extended over the westerly spans 3 to 6 and the the smallest over the two easterly spans 1 and 2. The western part is obviously used as a prayer's hall but the use of the eastern part is still under debate and can either be an entrance hall, or a prayer hall for women or a covered terrace overlooking the sea. Anyway, the architectural elements discovered and the fact that the pattern of the buttresses distributed in the basement in accordance with the axis of the aisles does not exist east of the continuous wall B12-48 clearly states that the eastern part of the building has a different architecture and probably use.

At an average altitude of 15,50m (i.e. around 3m above the ground floor of the basement), the prayer's hall, about 24,50m long from north to south and 14,60m wide from east to west, internally if only extended over the spans 3 to 6, is then around 340m sq (about 24,50m long from north to south and 14,60m wide from east to west, internally) , minbar, mirhab and bases of pillars excluded. The eastern part, which floor might be at a same altitude, must be a little more than 150m sq. The facies of the preserved coated floor in the eastern part and the many cracks on it strongly suggest that an important subsidence occurred, due to massive slight drop of the underneath backfill.

2.4.6. The north wing (Rooms E, X, J, P, W, T, U and areas M and N)

Under the name of north wing are gathered rooms which can be considered as annexes, because the prayer's hall was not extended over them. All rooms and area are different in shape and use.

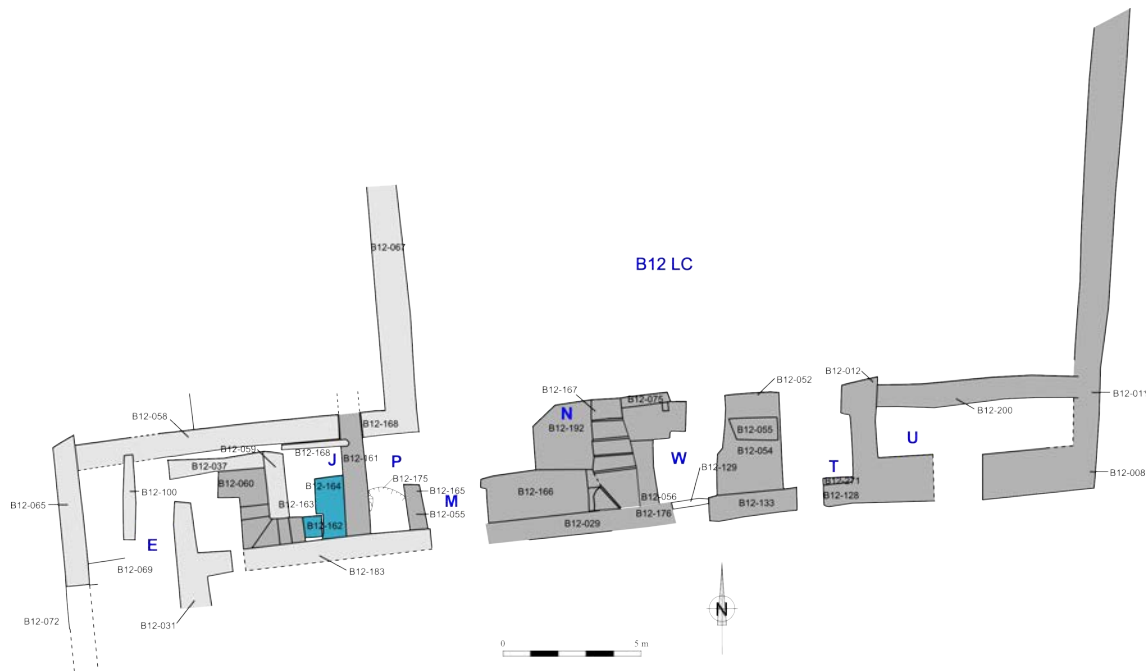

Fig. 63 - Plan of the north wing

- Room E

The room E is a small room sets in the north-west corner of the Mosque building, projecting westerly of the qibla wall, and south of the inner high courtyard (B12-D), badly preserved and partially excavated during the QP campaign (fig. 63).

The south part of the east limit is made by the projecting end of the qibla wall, while the north part is a gate (0,80m wide) that gave access to the westerly room X. The north limit is made by the south enclosing wall (B12-58) of the inner high courtyard (B12-D) and the west limit is made by the poorly preserved wall B12-65 (5,20x0,90x0,40). The south limit is

made by the wall B12-69 which is visible in the bench but unexcavated yet.

A floor made of compacted soil with inclusions of plaster (UF 3042, at the altitude of 15,50m) was discovered over the whole room and is covering



Fig. 64 - View of wall B12-100

and sealing a prior structure which might be a basin.

A small wall (B12-100 ; 3x0,50x0,40) was afterward built above that floor in a subsequent phase of occupancy (fig. 64).

The useful surface of the room E, which can be considered as an antechamber for room X, is around 10m sq, for a north-south length of 3,40m and a east-west width of 3,10m.

- Room X

East of room E and along the north external wall (B12-129) of the Mosque building, the room X is mainly occupied by a staircase (B12-160) entirely excavated during the QP campaigns. Access to the upper platform of the stair (at the altitude of 15,75m) is possible from room E and access to the prayer's hall is possible by a small badly preserved and not entirely excavated gate through the wall B12-29.

The first flight of steps, oriented east-west and not preserved, reach a level (altitude 14,50m) where the second flight is turning north-south for two steps before turning again east-west for three steps, before finally reaching the room J at the altitude of 12,80m, 2,70m below the upper plate-form.

The average width of the staircase is about 1m and the total length 3,50m divided into three flights of stairs.

The external walls of the staircase are made to the south by the north external wall (B12-183) of the Mosque building, the the west by the projection of the qibla wall and the gate from B12-E, to the east by the wall B12-59 (2,40x0,70x3), and to the north by the badly preserved wall B12-37 (3,40x0,60x0,80) which is leaning on the wall B12-58. The walls B12-37 and B12-59 are mainly made of corals bounded with soil and really poor mortar.

If the general dimensions of the room X are 4m long (east-west) and 2,80m wide (north-south), the useful walking surface is yet about 8,50m.

- Room J

The room J is located east of room X, along the north external wall (B12-29, here about 3m high), yet only reachable by the stair B12-60 and occupied by a basin complex, composed of three different structure. The west limit is made by the wall B12-59, common with staircase B12-60, the north limit by the wall B12-58 (here 2,20x0,80x2,20) and the east limit by the wall B12-161, common with room P. All walls are made mainly of corals with some limestones, and bounded with mortar. Remains of coating are scarce and mainly located on wall B12-29.

In the south-west corner of the room, a quadrangular step (B12-162 ; 0,80x0,60x0,40) is located at the outlet of the stair B12-60 and leads to a



Fig. 65 - View of the basin complex in room B12-J

quadrangular plate-form (B12-164 ; 2,20x1x0,30) which is probably the edge where people could take off their shoes. Both structures are covered by a strong waterproof coating (fig. 65).

The water basin properly said (B12-165, 2,70m long and from 0,90 to 2m

wide), upside-down L-shaped, is occupying the north-west half of the room. Its bottom is made by an indurated level of pebbles and gravels, probably not entirely waterproof. A cavity on the west side B12-156 ; 0,20m diameter and 0,20m deep) is quite probably a drainage pit.

The room J is 3,50m long (north-south) and 2m wide, the basin B12-163 occupying 4 m sq and the steps B12-162 and B12-164, at an average altitude of 12,50m, occupying 2,75m sq.

Few large pebbles in the north-east of the basin and the duct of a gutter (see room P) which both run under it, strongly suggest that the wall B12-161 (3,50x0,90x0,80) is a subsequent construction and that room J was originally reachable from room P and through it from the low courtyard (B12-LC).

- Room P

The room P is located east of room J and immediately north of the Mosque building. It is one of the smallest room of the complex.

The north limit is made by the wall B12-168, which is part of the sustaining wall of the inner high courtyard and the west limit is made by the wall B12-161, common with the westerly room J. To the south, the limit is made by the north external wall (B12-183) of the Mosque ; at the bottom of it, there is an opening covered by a pointed arch wick purpose remain unclear. It is connected with a huge pit (see below). The east limit is made by a small wall (B12-55 ; 1,60x0,60x0,80) and the gate (B12-251 ; 1,80 wide).

Except for B12-183 to the south, the walls are made mainly of corals with some limestones and no real internal organization, bounded with mortar and without remains of coating.

The ground is occupied to the north by a floor made of pebbles and to the south by a large pit. Closed and north to the wall B12-55, a level of a small compacted pebbles is quite probably the ground floor and can be considered as a threshold (B12-252). This threshold is surrounded, at the same level, by a ground floor made of bigger polished pebbles (B12-253). Though not homogenous, those two level of ground floor are undoubtedly working together, at an average altitude of 12,50m (fig. 66).

The ground floor B12-253 seems to have been cut by the large oval pit (B12-254 ; 1,60:1,30x1,20) which occupies the south half of the room. The inner faces of the pit, which is dug through layers of soils and ashes which are probably layers of backfill, are straight while the bottom is bowl-shaped (DE64 ; View of the pit B12-254). The opening (B12-291) at the bottom of wall B12-183 obviously works with this pit, but it is yet very difficult to know if the wall was damaged by the digging of the pit B12-254 or if the bottom of the wall was intentionally transformed into an arcade.

A waterproof coated gutter (B12-255) was found to the west of the pit



Fig. 66 - View of the ground floor in room P



Fig. 67 - View of the pit B12-254

(B12-254), running under the wall B12-161 and is obviously used to evacuate the water which might be over the plate-form B12-164. It is thus reasonably possible that the pit B12-254 was used as a drainage pit for the basin complex of the room J, to give space to the water to infiltrate into the ground without pouring out in the low courtyard (B12-LC) (fig. 67). At the end of excavations, a long and narrow waterproof coated



Fig. 68 - View of gutter B12-255

canalization was found under the northern half of wall B12-161. The relations between this structure and the basin complex of room J and the gutter B12-255 (fig. 68) and the drain pit B12-254, is a yet unsolved problem, as only the dismantlement of the wall B12-161 might give information.

- Area M

Immediately east of room P and north of the gate of the span 4, the area M was first assumed to be a close room but revealed to simply be the access space to the the basement from the low courtyard (B12-LC), between the room P and the easterly construction of area N.

East of this unfinished area, closed to the constructions of area N, a small remain of an inclined ground floor made of fine coating (B12-191) was found, apparently following the natural slope of the ground from an altitude of 12,25m to 12,15m. Where the coated ground floor (B12-191) is damaged, layers of backfill made of pebbles, soils and ashes were observed and seems to extend over the north half of the area, where the coated floor might have extend but is not preserved.

In the south half, a yet unexcavated bench might cover the threshold of the span 4 and eventually a best preserved ground floor.



Fig. 69 - View of area M in March 2014

If, as assumed, the main gate to the prayer's hall was above the gate leading to the span 4, area M was thus covered by a terrace, probably of wood as no remains of a stone vault or arch was found, this roof would have run from the edge of the stair to the east and over room P and J to the west, probably till the high platform of the staircase in room X.

A large posthole, partially observed in the section of the subsiding bench, might be a part of this system, as a large wooden post supporting the roof of the terrace (fig. 69).

- Area N

Also firstly thought as a closed room, the area N revealed to be a stair complex, which probably gave access to the prayer's hall by a gate which might have exist above the basement gate of span 4 (fig. 63).

Three construction occupied this place and probably composed the stair complex. Along the north external wall (B12-29) a rectangular structure (B12-166 ; 3,70x1,75x1,20) is quite probably the case above which the vanished steps of the stair were built. At least two L-shaped walls, made mainly of limestones bounded with mortar and showing some remains of coating, were built against the north external wall (B12-29) and the structure was afterward filled, the flight of stair being built over. The fact that the fine external coating of the north external wall (B12-29) continues under the backfill levels hardly suggest that the staircase is a subsequent construction, though it might have occurred shortly after the construction of wall B12-29.

Immediately east of the structure B12-166 and perpendicular to it, the structure B12-167 is the preserved flight of stairs of the staircase, probably built in the same way as B12-166. The first north-south oriented flight of stairs is made by five preserved steps, wide from 1,10m to 1,50m, and a triangular poorly preserved step initiates the second flight, east to west oriented, along the north external wall (B12-29 and B12-176).

The steps of the stair are made with limestones, sometimes polished, bounded with mortar and covered by a strong dark coating. Their length varies from 1,10m to 1,50 for an average width around 0,50m and an average height of 0,20m.

In the actual state of conservation, the stair rises from 11,75m at the first step to 13,50m at the last step.

The third structure is built against the junction of B12-166 and B12-167. This construction (B12-192) is an irregular pentagon (a rectangle with the north-west angle amputated), 2,40m long and 2,10m, and its height varies, as the structure is following the inclined natural slope, from 0,90cm at



Fig. 70 - View of the first steps of the stair B12-166-167

west to 1,20m at north-east. Three walls, mainly made of limestones bounded with poor mortar and soil, were built leaning on the previous structures (B12-166 and B12-167) and afterward filled, but the construction of this structure may have occurred shortly after the construction of the staircase. It was probably built to make the western edge of the first flight of steps or be a part of the supporting complex of the assumed terrace (fig. 70).

Two soundings were opened inside the staircase B12-166 and structure B12-192, to determine the facies of filling and date the building of its. Filling of both structures is very similar to each other. In staircase B12-166, the filling (UF3325) is made of alternate thin layers of brown silt and plaster blocks. Underneath lie several levels of backfill (gathered in UF 3335), mainly made of silt and gravels. The filling of structure B12-192 is similar (UF3336), although the beddings are more visible and organised, probably to prevent natural down turn. Underneath lie several layers of backfill, gathered in UF 3440, which probably backfilled the natural bedrock. Nevertheless, the narrowness of the sounding did not allowed the

reaching of the bedrock.

Ceramic study suggests that both structures are contemporary, even if the structure B12-192 is leaning on structure B12-166, built in the middle of the 14th century. There is however a short possibility that the structure B12-192 was built a little after, like few years later, in order to strengthened the staircase or support an architectural element.

- Room W

East of the staircase in area N, the quadrangular room W gave access to the sbasement from the northerly low courtyard (B12-LC), therefore room W can be seen as an antechamber of room G.

The south limit is made by the walls B12-176 and B12-133, both part of the north external walls of the Mosque building, separated by the gate that lead to room G. The east limit is made by a massive wall (B12-52 and B12-54 ; 3,50x2,40x2,50m) covered by a small remain of wall (B12-55) which certainly belongs to the upper floor. Leaning and differences of construction suggest that the north part (B12-52) and the south part (B12-54) could belong to a different stage of construction but the walls are too badly preserved to be affirmative.

The west limit is made by the wall B12-56 (2,40x0,65x2) which is leaning on the first flight of steps of the stair in area N, and is also leaning on the north wall (B12-285 ; 1,30x0,70x1,65) which itself also leans against the aforementioned stair. Between the wall B12-285 and B12-52 is the access gate (B12-287), originally 2m wide but reduced to 1,40m after the



*Fig. 71 -
General view
of room B12-
W with room
G in the
background*

subsequent construction of refurbishment (B12-286 ; 1,10x0,50x1,70). In the last stage of construction, a small wall (B12-75 ; 1,80x0,40x0,80) was built against the north faces of the walls B12-285 and B12-286.

All walls, except the ones belonging to the north external wall of the Mosque building, are made in the same way, with some big limestones and pieces of bedrock at the bottom and corals above, bounded with different mortar, from sandy grey one in the north walls and brown stronger one to the west, and only very scarce remains of coating can be find in the lower parts (fig.71).

A ground floor (B12-197), made of grey mortar or cement, stronger than the ground floors of the basement, was discovered on the whole surface of the room, with some gaps, at an average altitude of 11,50m. The room W offers a useful surface 9,3m sq, for a length of nearly 4m and a width of 2,30m, and was quite certainly covered by a vault or half-dome, remains of it being found in the layers of collapse (IsoArc 425 et al., see below).

- Room T

Immediately east of room W beyond the common walls B12-54 and B12-52, at the north-east corner of the Mosque building, the room T was partially unearthed by the QP campaign and then identified as part of the foundations of the minaret. As it is the only access of the southerly room H from the northerly low courtyard (B12-LC), the room T can also be seen, in its lower floor, as an antechamber of room H.

The south limit is made by the north external walls of the Mosque building (B12-133 and B12-128) and by the gate that separates them, while the west limit is made by the common wall with room W (B12-52 and B12-54). The east limit is made by the wall B12-12 (3,60x0,90x2), common with room U.

The north limit is only made by the gate, 2,20m wide, from the low courtyard (B12-LC) but to the east, a small projection of the wall B12-12 underlines this opening. For now on, no threshold has been found in the gate, and a massive architectural remain that will stay in place (IsoArc 39) will probably prevent further investigations.

All walls are made of large limestones and pieces of bedrock in the foundations and corals above, bounded with mortar, and large pieces of grey coating remain, mainly on the facing of walls B12-54 and B12-12. Engraved decorations are visible over the coating of the wall B12-54 : several lines might draw a stylized boat, and series of dug dots more or less organized as a cross (fig. 72). Right under these engraving, the lack of coating draw a half circular shape (B12-246) which is probably intentional but yet unexplained.

A ground floor (B12-242), similar to the ground floor of room W and different from the coating of the ground floors of the basement, made of grey mortar or cement, was unearthed over the whole surface of the room,



Fig. 72 - View of the engraving in room B12-T



Fig. 73 - View of room B12-T

with few gaps, at an average altitude of 11,50m. As the ground floor of the room T is about 0,30m higher than the ground floor of the room H, it is very likely that some steps must exist under the subsisting bench in the gate between the two rooms, but the architectural elements left in place in room

3. Stratigraphical data

The stratigraphy of the site was described and studied through sections made in the field. They are represented by blue lines on the following plans and visible in the second volume of this report.

3.1. The courtyards (B12-HC, B12-LC) and external buildings (B95 and B139)

3.1.1. Building B95 and passageway B95-B13

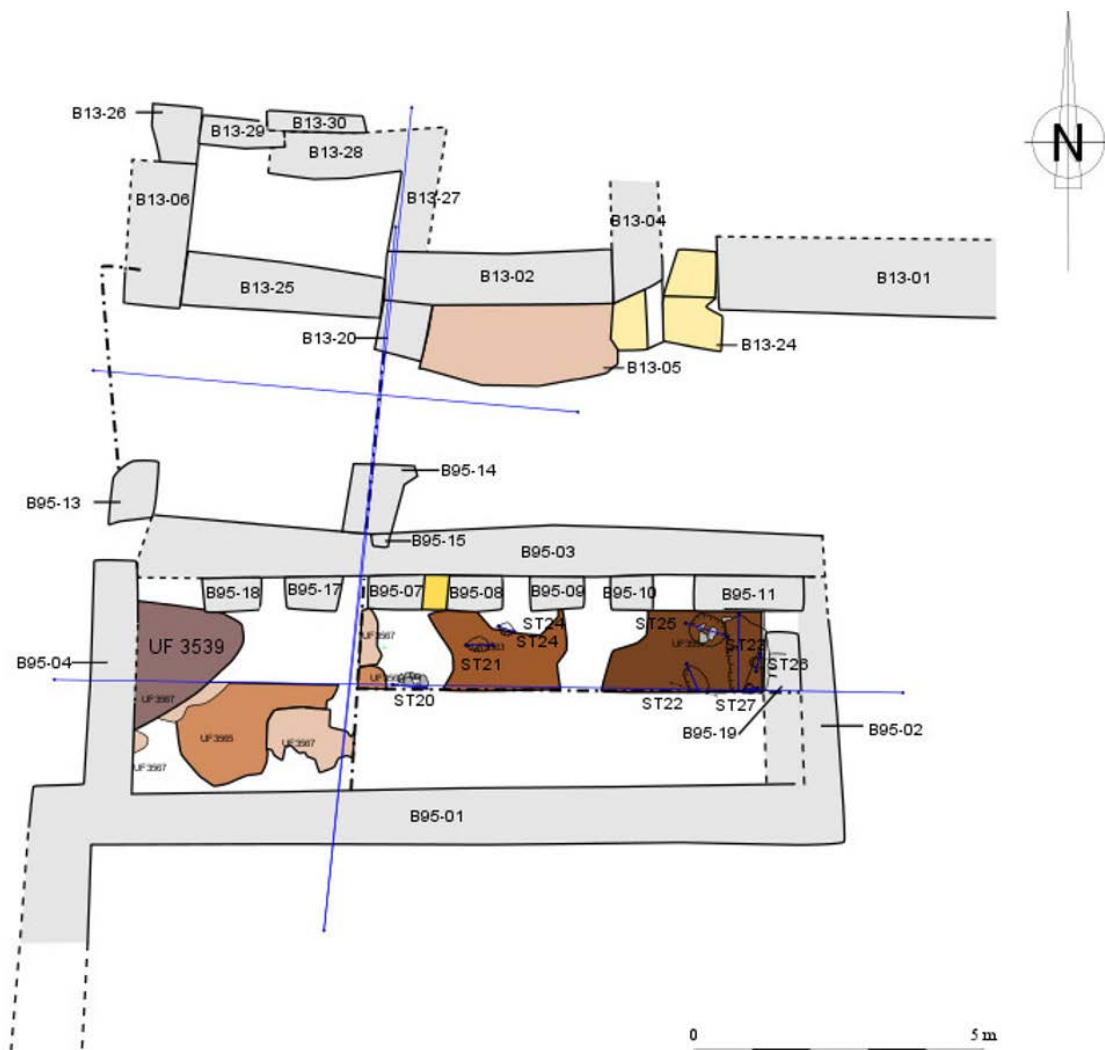

Fig. 75 - Occupancy layers and structures in B95

- B95 : Occupancy structures and layers (fig. 75).

Even if excavations stopped on the coated ground floor (B95-28), damages of this floor allow the observation of the underneath backfill levels. The main part of it seems to be made of crammed soils (UF 3557 at east and UF 3565 at west). From place to place can also be observed layers made of corals and soils (UF 3563 and UF 3566) which are probably the layers of construction of the walls of the building.

In the western part of the building, a level made of powdered and crammed plaster (UF 3567) is probably a repair or a new ground floor. This plaster floor is partially covered by a huge level of charcoals and

ashes (UF 3539) which is unlikely to be remains of a fire, as the walls and underneath plaster ground show no traces of reddening.

In the eastern part, two postholes (B95-26 ; 0,22x0,15x0,16 ; Digging :UF3556, Filling : UF3555 ; and B95-27 ; 0,20x0,20x0,18 ; Digging : UF3559, Filling : UF3558) and one pit (B95-25 ; 0,54x0,52x0,14 ; Digging : UF3561, Filling UF3560) were found. All these structures are dug in the UF3557 and quite probably through the ground floor (B95-28) though it is not preserved here. The filling of this structures being quite the same than UF3537, they must have been in use until the last occupancy of the building (cf. vol2, p. 5).

A subsequent level of occupancy is made by the UF3553 and UF3538, both being made of orange organic silt. Five combustion structures (B95-20 ; 0,50x?x? ; B95-21 ; 0,39x0,34x0,01 ; B95-22 ; ?x0,32x0,06 ; B95-23 ; 1,37x0,63x0,10 and B95-24 ; 0,20x0,20x0,03) were found randomly disposed over this layer (cf. vol2, p. 6). If the structures B95-20, B95-22, B95-23 and B95-24 are certainly temporaries hearths, the structure B95-21 is more likely a reject area. Even if this occupancy is not yet dated, it is very likely that this phase occurred when the primary use of the room has changed.

Covering these structures and their filling, a large layer made mainly of pebbles (UF3537) might be seen as the setting of a new floor or a new layer of occupancy, and the last one before the complete abandonment of the building.

- B95 : Collapse layers

The first level of collapse is made by the UF3536 and UF3530, where the remains of walls coating and roof have been found. Shortly afterward, the UF3528 and 3527, as they contains corals and mortar, are the collapse of the main part of the surroundings walls.

In the western part of the building, a level of charcoals and ashes (UF3532) is either a temporary reoccupancy or the traces of a fire, willing or accidental.

Finally, the last stage of collapse is made by UF3525, several IsoArc (391,392,426 and 427) being found in the east part of it. It is very likely that the IsoArc 391, 426 and 427 are part of the eastern collapsed gate of the building.

Above it and covering all space, the UF3500 is the ground surface cleaning (fig. 76).

- Passageway B95-B13 : Occupancy levels

In the main entrance of the complex B12, very few traces of occupancy were found.

At the feet of the bench B13-05, a level made of fragments of mortar, corals and limestones is probably the layer of construction of the bench and of the surrounding walls.

Above the top of the south-western bench (B95-16), a very short level (UF 3533) shows traces of reddening, suggesting that an hearth was made

Fig. 76 - View of the north-south section in passageway B95-B13



above the bench, presumably in the last stage of occupancy (fig. 77). Right north of this bench, in the western part of the passageway, a level made of hardpacked gravels, pebbles and soil (UF3546) is quite probably the street level, presumably made by a backfill leveling the underneath bedrock. Immediately east of it, a concentration of corals (UF3544) might be a step compensating the incline plane of bedrock and street.

- Passageway B95-B13 : Collapse levels

Two layers might be level of abandonment : the UF3514, made of soft brown silt, and the UF3521, made of pebbles and silt, are probably natural deposit, by wind or water flow, and have occurred between the abandonment of the complex and the beginning of the collapse of the building.

Other excavated layers are only made by a continuous level of collapse, artificially divided into different UFs for purpose of location or separated by the concentration of components.

From bottom to top, the UF3510 is a thin level of small gravels and pebbles above the bench B95-12, the UF3513 is a layer of powdered mortar which probably came from the erosion of the walls, the UF3512 is made of fragment of plaster and coral and UF3519 is made of silt mixed with ashes. All these layers are scattered in all the passageway and must have happened before the beginning of the collapse.

Covering all these layers, UF3502 is made by corals and limestones mixed with fragments of mortar and soil and is the first stage of collapse. Above it, and made the same way, the UF3501 is the upper level of collapse, spatially divided into Ufs 3503, 3504, 3523 and 3505, and equal to Ufs 3524 and 3515.

Finally, covering all layers, the UF3500 is the ground surface cleaning.

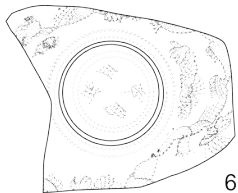
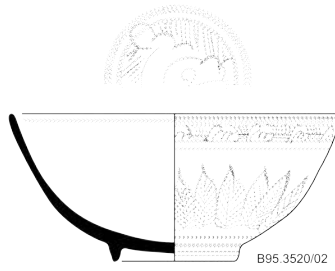
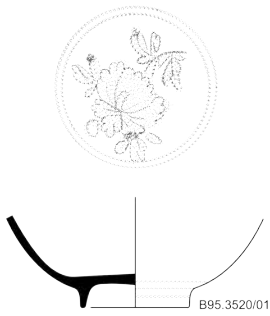
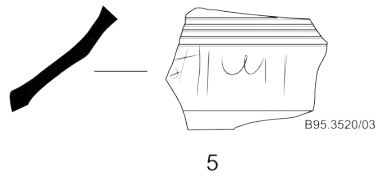
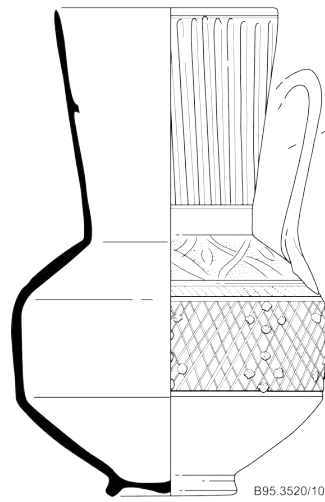
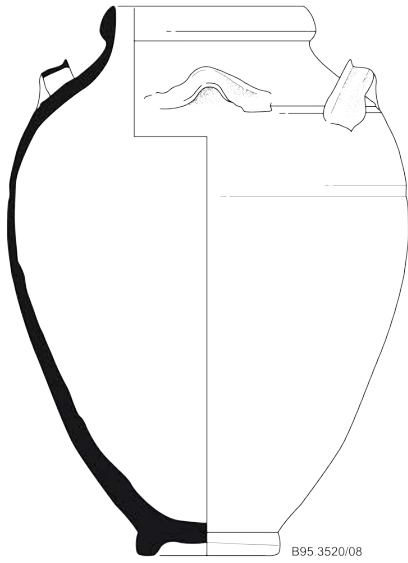

0 5 cm
(del. H. Renel)

Fig. 77 - Ceramics from B95 (UF3520), 2nd half of the 16th cent.

N°1: Ovoid jar with ring base. Orange brown well levigated and fired fabric. Ochre greenish glaze with black speckles on exterior and interior. Omani production. Bahla ware.

N°2: Jug. Carinated side with out-flaring neck, ring base and straight handle. Fine white well levigated fabric. Fine incised and combed decoration on the shoulder and the handle. Gouged and barbotine decoration on the neck and the wall. Iran production.

N°3: Oil lamp. Bowl with trefoil rim and ring base. Pale yellow fabric with mineral inclusions. Omani production. Qalhati ware.

N°4: Candlestick. White frit ware. Green glaze on interior. Iran production.

N°5: Fragment of cooking-pot. Light brown fabric mineral and organic inclusions. Dark polished surface. Graffiti on the shoulder. Indian production.

N°6: Hemispherical Bowl with ring base. Cobalt decoration. Chinese production. Blue and White porcelain.

N°7: Hemispherical Bowl with ring base. Cobalt decoration. Chinese production. Blue and White porcelain.

N°8: Large bowl. Light grey stoneware. Light green glaze on incised decoration. Chinese production.

3.1.2. Building B139 and the courtyards (B12-HC and B12-D)

- B139 : Occupancy structures and layers

Covering all the surface of room B139-A, the UF3342, made of pebbles and sand with charcoals and ashes, is probably a ground floor, and the only occupancy yet seen in the building B139. Ceramic study gives a dating from 15th century to 16th century and the aspect of ceramics also suggest a use of store, with large jars for water (fig 79 § 80).

- B139 : Collapse layers

The UF 3257 is the ground surface cleaning and thus is made of scattered corals and limestones, and extend over the whole surface of the building B139 and covered all the underneath layers.

In room B139-A, the collapse is made by a single layer (UF3222), compound of dark grey sand quite without any stones, suggesting that the top of the walls could have been made by hardpacked sand.

In room B139-B, the collapse layer (UF3304) has exactly the same type as the one from room A probably for the same reasons. Ceramic study gives a dating from the end of 15th century to 16th century.

In room B139-C, the collapse layer (UF3311) is also mostly made of dark grey sand but the concentration of corals and stones seems more important, probably because of the presence of the enclosing walls.

South of room A, the UF3306 and UF3309, made of corals and limestones, are the collapse of the south enclosing wall (B139-02), and they are covering a sandy level (3328) which can either be the collapse of the walls of room A or a ground floor. Ceramic study gives a dating from the end of 15th century to 16th century.

- B12-LC : Collapse layers

Apart from the ground surface cleaning (UF3011 along the west enclosing wall B12-186 and UF3068 along the qibla wall B12-01 and south of the mirhab B12-04), the layers of collapse in the high courtyard are to be found alongside the wall B12-186. Although the level of collapse is the same, it has been artificially divided in three parts, in case remains of decoration or architectural elements were found, which did not happen. UF3141 and UF3144 are both the collapse of the wall in its south third, UF3145 in its central third and UF3188 in its north half. All this collapse is made of mixed limestones and corals with few remains of mortar, suggesting that the enclosing wall (B12-186) was mainly bounded with soil.

South of the enclosing wall, the UF3258 is the particular collapse layer of the wall B12-201.

- B12-D : Occupancy structures and layers (fig. 78)

In the inner high courtyard (B12-D), traces of occupancy have only be

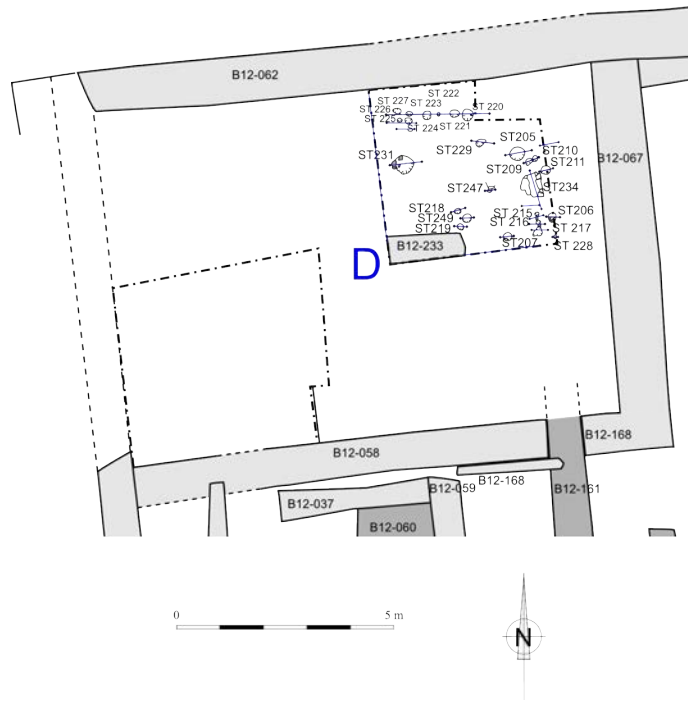

Fig. 78 - Occupancy structures in B12-D

found in the yet sole excavated north-east quarter.

The oldest sign of occupancy is the UF3408, which is a red compacted level, probably made of a mix of silt and crashed fired clay, and could be a ground floor. Yet clearly visible in the north part, alongside the wall B12-62, this possible ground floor is also observable from place to place in the surface of the sounding, and might extend over the whole inner high courtyard (B12-D), at an average altitude of 14,10m.

Probably built right above the floor UF3408 (but not certainly as the excavations are not complete) in the middle of the the soundings, a rectangular structure (B12-234) made of architectural fired clay (terracotta tiles or bricks) was partially seen and not excavated. Though it is yet too soon to be affirmative, the shape and components of the structure B12-234, coupled with observations and reasoning in other place of the area, might suggest a water use, such as covered duct or basin.

Partially covering the structure B12-234 and extended over the whole surface of the sounding except in the north part where it straight limit ends about 0,60 south of the wall B12-62 and the east part where its limit ends about 1m west of retaining wall B12-67, an irregular plaster layer (UF3352) was found, with no less than twenty-five postholes and one hearth (B12-229 ; 0,20x0,04 ; Digging : UF3402 ; Filling : UF3401 made of ashes) dug over it (cf. vol2, p. 7).

Seven of these postholes are in the same alignment set a the northern edge of the plaster layer (UF3352). From east to west, these postholes are B12-220 (0,24x0,28 ; Digging : 3383, Filling : 3384), B12-221 (0,22x0,20 ; Digging : 3385, Filling : 3386), B12-222 (0,10x0,16 ; Digging : 3387, Filling : 3388), B12-223 (0,20x0,25 ; Digging : 3389 , Filling : 3390), B12-224 (0,12x0,22 ; Digging : 3391, Filling : 3392), B12-225 (0,10x0,20

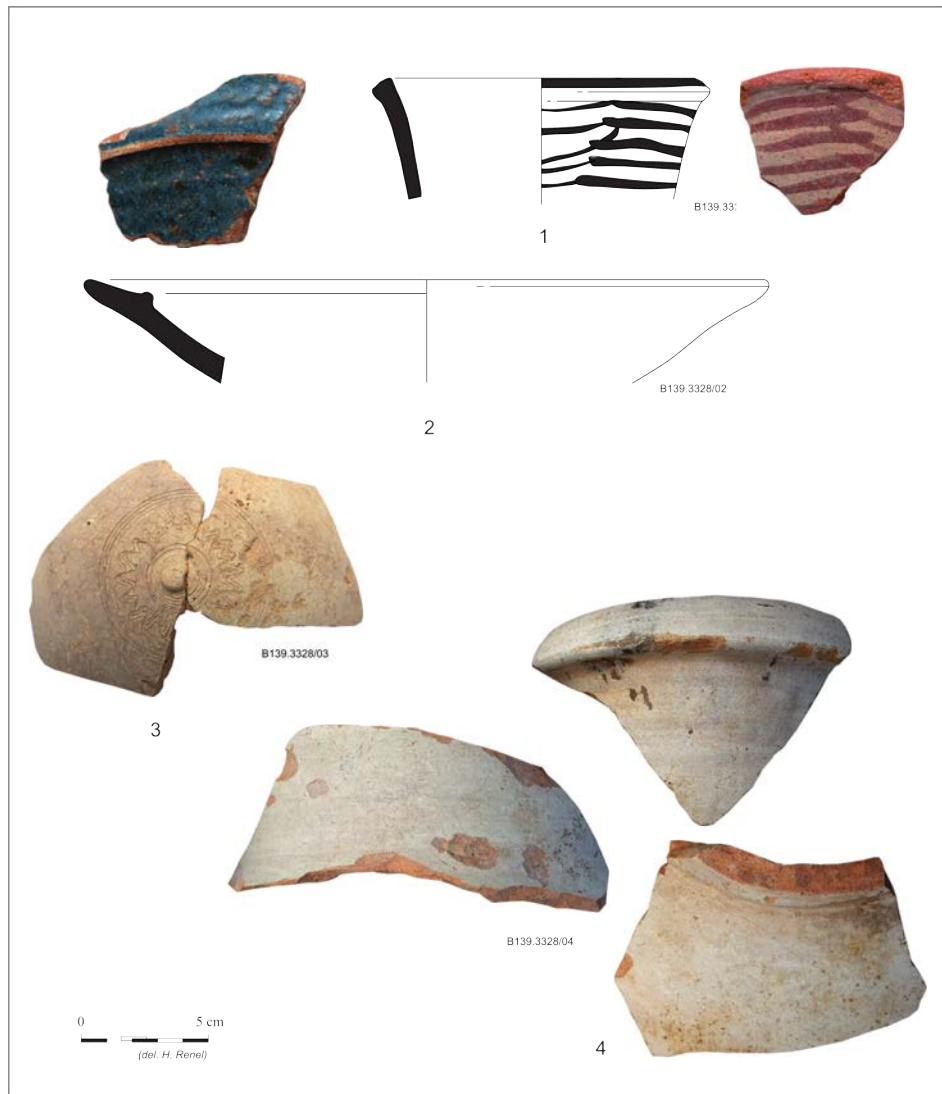
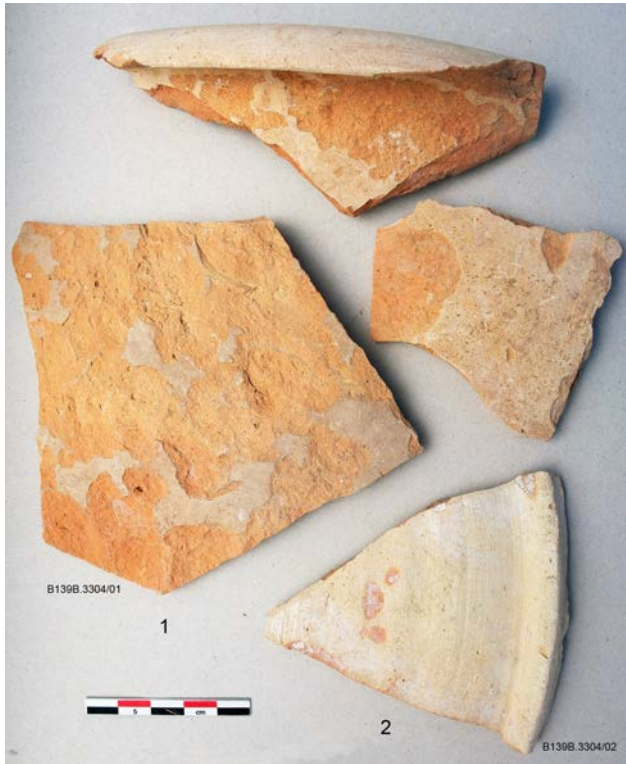

Fig. 79 - Ceramics from B139, room B (UF3304), end of the 15th cent. - 16th cent.

N°1: Storage jar with straight neck and large everted rim. Orange brown fabric with mineral inclusions. Pale brown on exterior. Omani production.

N°2: Lip. Brown fabric with mineral inclusions. White on interior and exterior. Omani production.

Fig. 80 - Ceramics from B139, room D (UF3328), end of the 15th cent. - 16th cent.

N°1: Jug with out-flaring neck and triangular rim. Orange brown fabric with chamotte, mineral and organic inclusions. Red painted lines on white slip. Shimal area production. Julfar ware.

N°2: Bowl with ledge rim. Brown fabric with mineral inclusions. Turquoise glaze with dark blue speckles on interior. Arabian production.

N°3: Lip or fragment of flask. Fine pale grey brownish well levigated fabric. Combed decoration. Iran production?

N°4: Storage jar. Straight neck and large everted rim. Orange brown fabric with mineral inclusions. Surfaces interior and exterior white. Omani production.

; Digging : 3393 ; Filling 3394), B12-226 (0,16x0,18 ; Digging : 3395, Filling 3396) and B12-227 (0,14x0,25 ; Digging : 3397, Filling : 3398) (cf. vol2, p. 8).

All these postholes were obviously part of a light vegetable fence which ran parallel to the wall B12-62 and creating a small corridor.

In the east part, where the plaster level (UF3352) irregularly stops, several postholes might also be gathered into a fence. From north to south, these postholes are B12-205 (0,40x0,40 ; Digging : 3353, Filling : 3354), B12-211 (0,30x0,30 ; Digging : 3366, Filling 3367), B12-209 (0,12x0,12 ; Digging : 3362, Filling : 3363), B12-208 (0,16x0,24 ; Digging : 3360, Filling : 3361), B12-206 (0,20x0,20 ; Digging : 3355, Filling : 3356, 3357) ; B12-215 (0,10x0,20 ; Digging : 3373, Filling : 3374), B12-216 (0,15x0,20 ; Digging : 3375, Filling : 3376), B12-217 (0,20x0,20 ; Digging : 3377, Filling : 3378) and B12-228 (0,12x0,06 ; Digging : 3399, Filling : 3400) (cf. vol2, p. 9).

Nevertheless, the alignment of these postholes is less visible than the northern fence and, if there was any vegetable fence in the east, all the aforementioned postholes might not be a part of it.

Others postholes -B12-207 (0,20x0,30 ; Digging : 3358, Filling : 3359), B12-212 (0,25x0,15 ; Digging : 3368, Filling : 3369), B12-218 (0,15x0,22 ; Digging : 3378, Filling : 3379), B12-219 (0,18x0,10 ; Digging : 3380, Filling : 3380), B12-231(0,55x0,40 ; Digging : 3406, Filling : 3407), B12-247 (0,12x0,14 ; Digging : 3432, Filling : 3433) and B12-249 (0,20x0,30 ; Digging : 3436, Filling : 3437)- are randomly scattered over the opening of the sounding and over the plaster level (UF3352) (cf. vol2, p. 10). If some of them are close and might work together, there is not enough to argue about their use and contemporaneity. However, as there is no sign of posthole afterward cut by a subsequent one and as all the filling are looking the same (i.e a silty brownish sediment similar to the upper covering layer UF3343, see below), it is very likely that all the postholes



Fig. 81 - View of the sounded area.

are contemporaneous and that all wooden posts were removed before the backfilling of the area (fig. 81).

If the use of the inner high courtyard (B12-D) is not yet fully explained, one hypothesis could be the use of a garden, where the low wall B12-233, quite in the center of the area, could be a bench, the structure B12-234 being a water duct and the scattered holes being either a remain of pergola or location of bushes and flowers, and the plaster layer (UF3352) supporting vanished basins.

- B12-D : Second occupancy and collapse layers

Above the plaster layer (UF3352) and only seen on the western section, two small layers of ashes (UF3611 and UF3612) could be the remains of temporaries hearthes, probably by the end of the garden occupancy.

A massive backfill (UF3343) made of brown silt mixed with little small stones was afterward put over the whole surface, at least of the sounding and probably of the inner high courtyard. Ceramic study gives a dating of the 16th century. A small layer of ashes (UF3613) was observed in the south section, over the backfill UF3343.

Also in the south section, around the wall B12-233, a layer of silt with more massive stones (UF3327) could be the collapse of the wall, but the destruction can be willingly made, as no heaps of collapse were seen. Moreover, this destruction could have participate to the leveling of the area, the underneath UF3343 showing there an important slope. Ceramic study gives a dating from the 16th century.

As the top of the UF3343 is at the same height than the upper overhang of the north wall B12-62, it is very likely that the layer was put in the same time than the enhancement of the wall, when the use of the inner high courtyards (B12-D) radically changed. Unfortunately, the connection between UF3343 and B12-62 is yet obliterated by a layer (UF3610) made of stones and corals without soil. This layer, only seen on the west section, might be a located fact, or the foundation trench of the wall. In this case, the enhancement of the wall B12-62 occurred a while after the backfilling (cf. vol2, p. 11).

Over the layers UF3343 and 3327, the UF3019, made of compacted soft soil with small pebbles and gravel, is probably the floor, or outdoor walking level, of the last stage of occupancy, shortly after the enhancement of the wall B12-62.

Afterward occurred the collapse, made of big polished stones and corals with a sandy, loose and brown sediment, with an obvious concentration of stones at the feet of the walls, whereas they are scattered in the center of the area. The general collapse has been divided into several UFs, regarding to their location : UF3035 at west, UF3031 closed to the wall B12-62, UF3014 along the wall B12-58. Immediately above, the UF3010 and the UF3026 are ground surface cleaning, one to west and one to east.



Fig. 82 - Ceramics from the area D from the mosque (UF3327), 16th cent.

N°1: Large jar with straight neck and everted rim. Light greenish fabric with chamotte and mineral inclusions. White rough surface. Omani production.

3.2. The Mosque building (B12)

3.2.1. The basement, span one (Rooms H, K and V)

- B12-H : Occupancy structures and layers (fig. 83)

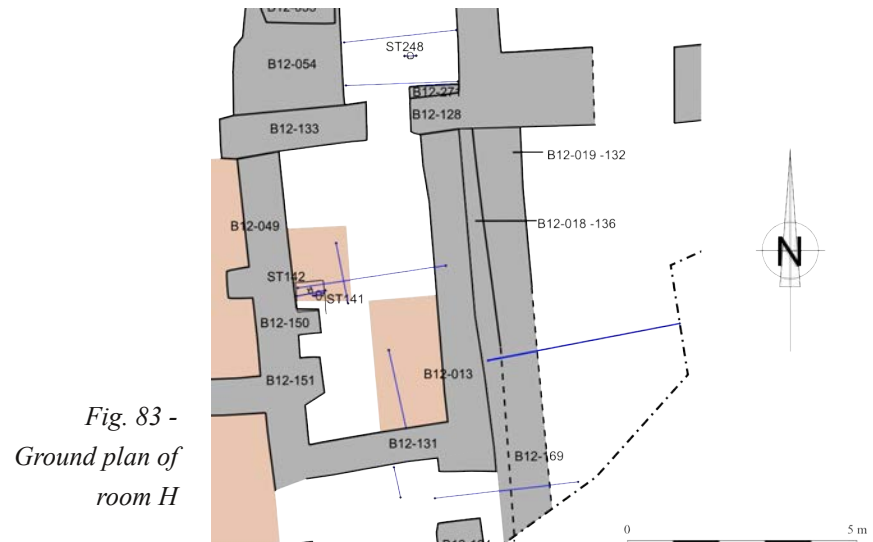

Fig. 83 -
Ground plan of
room H

As it was chosen to left in place some of the architectural elements (octagonal columns and square bases), the ground floor and occupancy layers have only be seen in two small soundings in this room, thus occupancy information is scarce and incomplete.

In the western sounding, a posthole (B12-142 ; 0,14x012 ; Digging : 3166, Filling : 3167), closely north of buttress B12-150, is the only incontestable occupancy structure, while a small oval cavity (B12-141 ; 0,20x0,15x0,04 ; Digging : 3142, Filling : 3143) next to it might be the print of a posthole, but this assertion is more debatable (cf. vol2, p. 12).

A thin layer of pebbles mixed with grey compacted soil (UF3175), only visible in sounding 1, is probably an intermediate occupancy level. It is covered by another layer (UF3132) made of pebbles mixed with loose grey soil, and a similar layer (UF3137) was found in sounding 2. Though the connection was not made, it is very likely that these two layers are the same, and the layer of the last occupancy. Right above start the collapse layers.

- B12-H : Collapse layers

The first phases of collapse have been seen in both soundings and their facies and stack are similar.

An irregular layer made of compacted soil with few stones and corals (UF3094 in sounding 1 and UF3128 in sounding 2) is the first layer of collapse, and probably came either from the slow disintegration of the coating of roof and walls or from exterior by wind input.

Above it, the general phase of collapse occurred as the UF3072 in the north and UF3078 in the south. These layers are mainly made of limestones and corals, fragments of mortar and pieces of wood, which

came from the architectural elements that lie right upon them.

The main part of the architectural elements is included into the UF3056, which is similar to the UFs 3072 and 3078 but with more sand, and common to all the room.

Above it, the UF3053 is the ground surface cleaning, common with room K, mainly made of sandy soils, probably carried by wind, and small stones. The architectural elements appeared in this UF, which probably be deposited when the general collapse stabilized (cf. vol2, p. 13).

- B12-K : Occupancy structures and layers

As for room H, the room K was not fully excavated because of the will to let in place the architectural element. No coated ground floor was found and traces of occupancy are few, but this lack probably results of the smallness of the sounding.

At the bottom of the sole sounding, a layer made of black organic soil mixed with ashes and a lot of artifact (UF3125) could either be a layer of occupancy or a backfill. On the top of this layer, scattered little pebbles might also be the trace of the last occupancy, as the layers of collapse start right above, but observations were not sufficient to be affirmative (cf. vol2, p. 14).

- B12-K : Collapse layers

The first layer of collapse is made by the UF3095, made of compacted grey soil with some stones ; as it is similar to the UFs 3094 and 3128 in room H, its provenance is probably the same.

Right above, the UF 3078 is the phase of general collapse. Made of sandy soil mixed with limestones, corals, fragments of mortar and coating and pieces of wood, this UF also contains the architectural elements left in place. In the south part were found fragments of wall-coating with carved drawings on them which are likely to be a sketch of the Mosque. Other fragments of this graffiti might exist under the remaining wheelbarrows berm and could later complete the drawing.

Finally, the UF 3053 is the ground surface cleaning, common with room H.

- B12-V : Occupancy structures and layers (fig. 84)

As the room V was already partially excavated during the QP campaigns and shortly extended during this season, traces of occupancy are fragmentary and subject to later addition.

The first layer of occupancy, probably right above the bedrock, is the UF3441, made of yellow greenish sediment mixed with slags, plaster and artifact. It could either be an organic deposit or a burning area.

Right above, the UF3439 is made of brown soil mixed with pebbles, small stones, charcoals, ashes and artifacts. It could either be a level of occupancy properly said, or a backfill to support the next level of occupancy. The heterogeneity of the components of the layer promotes the last hypothesis.

The UF3421, mainly made of small pebbles with ashes, charcoals and artifacts, is the last level of occupancy, similar of those found in others



Fig. 84 -
Ground plan of
room V

rooms (cf. vol2, p. 15).

- B12-V : Collapse layers

The single layer of collapse of the room V, made of limestones, corals, fragments of mortar and plaster, pieces of wood and roof, mixed with yellowish soil, was artificially divided in its heights into UF 3420, the lowest one, and UF 3316, the upper one.

These layers were only seen and registered on sections and have not been excavated yet, except a small cleaning and rectification of sections.

3.2.2. Span Two (Rooms G, Q, S, L and R)

- Room G : Occupancy structures and layers (fig. 85)

Right above the badly preserved floor (B12-289), the UF3427 is a surface cleaning executed in January 2014. This layer is made of brown soil with some pebbles. It includes both the scarce remains of the above layers and deposit that intervene between the two sessions of the season.

Right above, a thin layer of small pebbles (UF3262) covered with a thin layer of compacted soil (UF3238) is probably a second state of occupation. A posthole (B12-178 ; 0,14x0,12) at the south-west of buttress B12-127 is the only structure related to that phase of occupancy (cf. vol2, p. 16).

A subsequent layer of occupancy (UF 3237) made of pebbles mixed with

grey soil and artifacts occurred afterward. As this layer seems to continue under the structure B12-173, it certainly belongs to the subsequent phase. A small hearth (B12-179 ; Filling : 3261) with ashes and charcoals was found above the layer UF3237, closed to the rectangular structure B12-173.

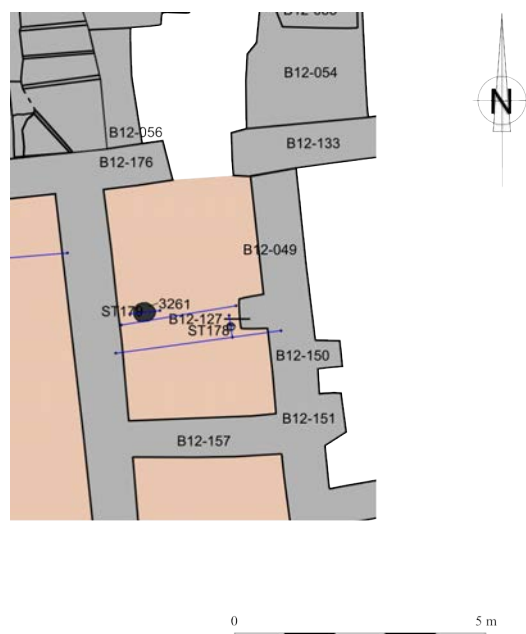

Fig. 85 - Ground plan of room G

Finally, a layer of pebbles (UF3232 at south and UF3243 at north), was observed and identified as the last layer of occupancy, and no structures can be linked with that phase. Right above start the collapse level.

- Room G : Collapse layers

As in adjacent rooms H and K, the first layer of collapse in room G is made by a thick level of compacted soil with few stones and corals (UF3073 at south and UF3205 at north), though some fragments of the upper floor have been found here.

Right above, the general collapse (UF3057 at south and 3071 at north) is made by many corals, limestones and charcoal mixed with a sandy loose soil. The main part of the architectural elements were obviously found in that layer.

Finally, a natural sediment (UF3052 at south and UF3054 at north) made of sandy loose soil with small stones covered the whole surface of the room and should have occurred after the stabilization of collapse (cf. vol2, p. 16).

- Room Q : Occupancy structures and layers (fig. 86)

In this room, nine postholes were discovered, more or less parallel to the enclosing wall.

The first row is along the western wall B12-48 and made by three postholes which are B12-195 (0,16x0,20 ; Digging : 3416, Filling : 3417), B12-261 (0,16x0,08 ; Digging : 3462, Filling : 3463) and B12-262 (0,18x0,26 ; Digging : 3464, Filling : 3465) at the south of buttress B12-

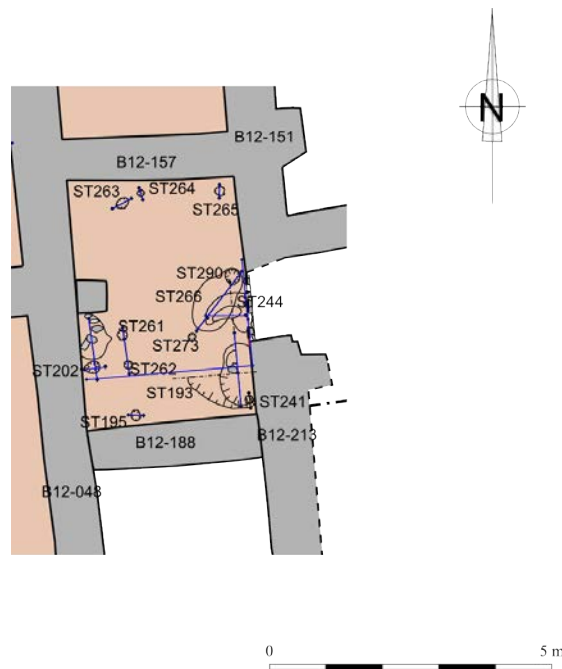

Fig. 86 - Ground plan of room Q

189 and a second row is along the north wall B12-157, made by the postholes B12-263 (0,24x0,24 ; Digging : 3466, Filling : 3467) and B12-265 (0,18x0,22 ; Digging : 3470 ; Filling : 3471) with the smaller posthole B12-264 (0,08x0,08; Digging : 3469, Filling : 3468) between them.. As its dimensions are smaller, it could have been a light repair or strengthening. DE96 (cf. vol2, p. 17).

The second row is parallel to the eastern wall B12-49 and made by the posthole B12-265 at north end and B12-290 (0,30x0,26 ; Digging : 3481, First Filling : 3484, Second filling 3489) next to the gate B12-190. In the south-east corner of the room, the posthole B12-241 (0,16x0,16 ; Digging : 3414, Filling : 3413) could have worked with B12-195 and B12-274 (0,38x0,22x0,20 ; Digging : 3479, Filling 3480) next to the gate B12-190. DE97 (cf. vol2, p. 18).

The ninth posthole (B12-264 ; 0,08x0,08; Digging : 3469, Filling : 3468) is between the postholes B12-263 and B12-265 along the north wall B12-157. As its dimensions are smaller, it could have been a light repair or strengthening, and no symmetrical posthole was found along the south wall B12-188).

The pattern and location of these postholes clearly state that they were supporting light wooden shelves for storage. No signs of beamprints was seen on the walls or the buttress B12-189.

Next to the gate B12-190, the posthole B12-290 and part of the coated ground floor B12-193 were covered by an hearth (B12-266). A conglomerate of charcoals, ashes and gypsum was observed in the center, surrounded by two reddened layers of soil (UF3485 and UF 3487). These layers were covered by a level of ashes (UF3461) in which were found many slags, suggesting rather a craft use than a domestic one. Very closed to this structure, a small cavity (B12-273 ; 0,08x0,08 ; Digging : 3477, Filling : 3378) might be the print of a little pole. Though there is no

stratigraphical certainty, it might be in use with the hearth B12-266. As one of the previous postholes is sealed by this structure, it is very likely that the wooden shelves have been removed when the craft area was in use, at least the eastern shelves even if the western ones could have been longer in use.

The last layer of occupancy is also here a level made of pebbles (UF3323) covering the whole surface of room Q. A concentration of ashes (UF3326) was observed in the south-west corner of the room, and must be a deposit in relation with the hearth B12-195 in the south-east corner. The fireplace is compound of a layer of reddened soil (UF3438) partially covered by a layer of ashes and charcoals (UF3324).

North of this hearth and in front of the gate B12-190, an area of trampled pebbles (UF3608) with concentration of ashes (UF3609) could be linked to the hearth B12-195 or, regarding to its location, to a yet unexcavated structure in adjacent room K (cf. vol2, p. 19).

- B12-Q : Collapse layers

The first layer of collapse in room Q (UF3370) is made of limestones, corals, fragments of mortar mixed with brown soil. Several pieces of the upper floor were also found in this level.

Above it in the south-east corner of the room, a small layer exclusively constituted of brown silt (UF3345) is probably a human deposit during a temporary squat, which use can not be state. Closed to the wall B12-48 and buttress B12-189, a hearth (B12-202) probably also belongs to a similar temporary squat. This fireplace sets in a small depression (UF3404), its bottom showing signs of reddening (UF3403), and filled by a layer of ashes (UF3349). Adjacent to this hearth, a concentration of fish scales (UF3350) is surely a reject of the hearth B12-202. It is very tempting to see here a fisherman landing on the closed seashore and cooking in the shelter of the collapsing walls.

Covering all these layers, the UF3322 is characterized by a more important concentration of fragments of roof than in the upper layer UF3318, both being made of limestones, corals, fragments of mortar mixed with brown soil. During the excavation of the south part of the room, these two UFs were gathered and registered as UF3348 (cf. vol2, p. 20).

The upper layers of collapse in room Q, which have the same components as others layers in others rooms, were artificially divided during the excavations into several UFs, either vertically or horizontally. From bottom to top, they are UF3295 at south and UF3221 at north, UF3265 at south and UF3281 at north, and UF3265 at south and UF3264 at north, which was also registered as UF3197.

- Room S

Already partially excavated by the QP in 2009 and not completed during this season, the room S has shown no signs of floor or occupancy yet.

Only the layer of general collapse, made of limestones, corals and

fragments of mortar mixed with brown soil, have been registered, as UF3290 at north and UF3296 at south.

- Room L

As the room L is not excavated yet, no occupancy was found. Only two layers of surface cleaning have been registered, as UF3123 at north and UF3351 at south.

- Room R

As the others rooms of the south part of span 2, the excavations of room R are still uncompleted.

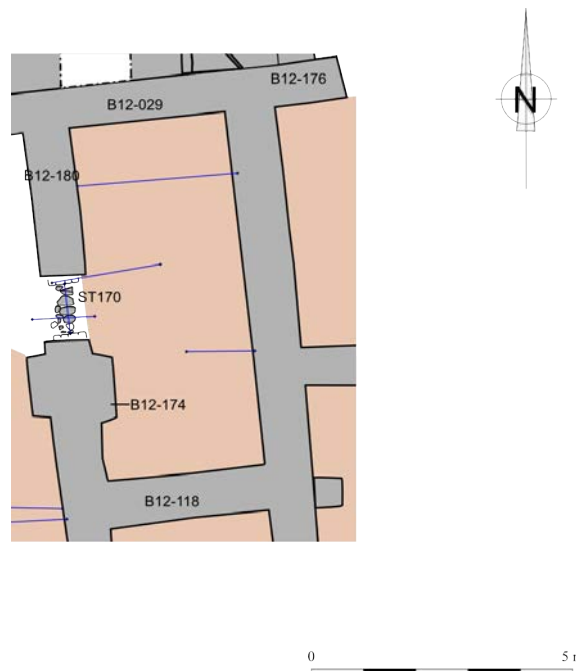

Fig. 87 - Ground plan of room I

Only four artificial layers of collapse, all made of limestones, corals, fragments of mortar and pieces of wood mixed with brown soil. The lowest ones are UF3284 at south and UF3340 at north. They are covered by the unique artificial UF3278 which is the level of excavations where the course of walls was visible. Above, the UF3274 is a ground surface cleaning.

3.2.3. Span Three (Rooms I, A, C and F)

- Room I: Occupancy structures and layers (fig. 87)

In room I, if a nearly completely preserved coated floor was found, no occupancy structures associated with it was found.

Under the threshold B12-170, a thin layer of clay (UF3415) was probably the first threshold of the room, probably similar as those found in room A and C, but this layer is too damaged to be affirmative and no traces of wood prints were seen, so they're could have been no special laying out there.

Right over this layer of clay, a carbonaceous layer (UF3220) went under

the threshold and extended around the gate frame. Under this layer, the coated floor is completely vanished. It is tempting to suppose that the carbonaceous layer (UF3220) is the result of the burning of the door, the fire having then destroyed the coated floor. But no traces of burning were seen on the walls of the gate, which would have been the case if the door has burnt in place. Ceramic study gives a dating from the 15th century to the beginning of the 16th century.

North of the carbonaceous layer, a small level made of clay mixed with charcoals and small limestones (UF3346) is probably a backfill or a localized repair of the floor, over which it was directly laying, and presumably contemporaneous with the UF3220.

Extended over all the south part of the room and partially observed in the north part, a layer (UF3244) made of compacted soil containing many pebbles and small nodules of plaster. This level is quite probably a



Fig. 88 - Ceramics from the area I from the mosque (UF3241), 15th cent., 1st half of the 16th cent.

N°1: Hemispherical bowl. Light brown with chamotte, white and mica inclusions. Light blue glaze with dark blue speckles. Arabian production.

N°2 : Small flask or inkwell. Ring base. Brown fabric with mineral inclusions. Purple glaze with black speckles on interior, turquoise glaze with dark blue speckles on exterior. Arabian production.

N°3: Cooking-pot with everted rim. Dark brown fabric with mineral inclusions.

refection and raising of the floor, even if the coated floor was not so damaged (cf. vol2, p. 21).

A small layer of mortar (UF3218) associated with a layer of plaster (UF3217) was seen from place to place over the UF3244. They are probably localized repairing of the second level of floor.

All layers were after covered by a layer of small pebbles mixed with brown soil (UF3241) which is quite probably the last level of occupancy, similar to those found in many others rooms. Ceramic study gives a dating from the 15th century to the beginning of the 16th century (fig. 88).

Above it start the collapse layers.

- Room I : Collapse layers

Following the chosen methodology, the layers of collapse were artificially divided, either vertically or horizontally.

The lowest level of collapse (UF3209 at south and UF3225 at north) is made by a mix of sandy brown soil containing limestones and corals with fragments of mortar and pieces of the roof.

The upper layers of collapse are similar, made of brown soils mixed with limestones, corals and fragments of mortar. Close to the walls, the sediment is more yellow and beige, because of the disintegration of the coating. From bottom to top, these artificially divided layers are UF3134 and south and UF3215 at north, UF3105 at south and UF3204 at north, UF3075 and 3070 at south and UF3198 at north.

Right above, the UF3000 is the common ground surface cleaning (cf. vol2, p. 22).

- Room A : Occupancy structures and layers

If room A is one of the best preserved rooms of the basement, especially the coated floor which shows no hard damage, no occupancy structures contemporaneous to it was found. Generally, traces of occupancy are very scarce here.

Present right over the coated floor and almost the whole surface of the room, a thin layer made of pebbles mixed with ashes, charcoals, fragments of gypsum and brown soil (UF3066) is the last occupancy before the general collapse. A concentration of ashes and carbonized fauna remains at the gate of the room may be considered as a temporary hearth, but the hypothetical structure was too damaged to be affirmative.

- Room A : Collapse layers

As the room A was partially excavated during the QP campaigns, the levels of the general collapse, already removed in the south part, was artificially divided only vertically.

The collapse layers are made of limestones, corals, fragments of mortars mixed with a brown soil that become more yellow against the walls. From bottom to top, they were registered as UF3064, UF3058, UF3048, UF3043, UF3015 and UF3003, upon which the massive architectural element (IsoArc321) was lying.

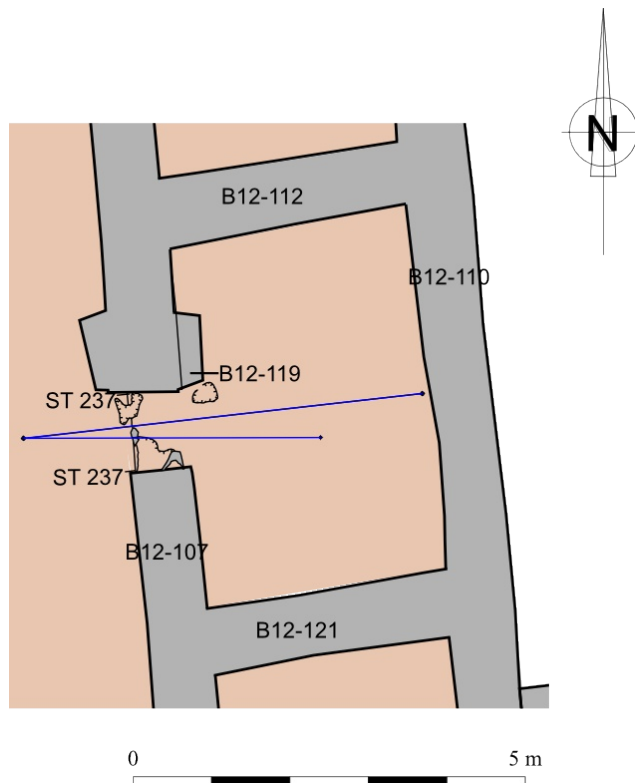

Fig. 89 -
Ground plan
of room C

Above, the UF300 is the common ground surface cleaning.

- Room C : Occupancy structures and layers (fig. 89)

As room A, the room C is one of the best preserved, by traces of occupancy are very scarce.

Around the gate frame, a localized layer made of brown soil mixed with some pebbles, small limestones and charcoal was present where the coated floor is the more damaged. This layer was obviously a repair.

Right above, five very thin occupancy layers were observed. The layer UF3422 is made of compacted ashes mixed with soil, sometimes inlaid in the coated floor. The compaction of this ashes layer results of an important human trampling, this layer could so reasonably be a reject used as backfill. Covering this level, the UF3472 is made of pebbles mixed with brown soils and ashes. The upper layer (UF3430) has the same facies but contains more small stones and charcoals. Upon it, the UF3124 is also made only of pebbles mixed with soil and ashes. Finally, covering all layers, the UF3423 is an heterogeneous layer made of soil mixed with pebbles, mortar, small stones, charcoals and fish remains.

All these layers are probably from the last phase of occupancy but, as they are mound-shaped and not flat, their aspect is problematical. They can not come from the filling of a nearby collapsed structure as absolutely no traces of an hypothetical structure was found. It is like the backfill were thrown into room C from the gate but never leveled (cf. vol2, p. 23).

- Room C : Collapse layers

The lowest layer of collapse is the UF3405, made of powdery mortar and soil mixed with limestones, corals, fragments of mortar and coating. Over

it is the second artificial layer of collapse, UF3055 (equal to UF3059), made with the same components.

Above it, the layer of collapse was artificially horizontally divided in three parts, instead of two, because of the presence of two massive architectural elements which divided the room in three parts.

The UF3025 at north, the UF3029 in the center and the UF3032 in the south are all similar, made of brown soil and powdery mortar mixed with limestones, corals and fragments of mortar. Right above, the UF3008 is the excavations layer until the discovery of the course of the walls, while the UF3000 is the common ground surface cleaning.

- Room F : Occupancy structures and layers

In room F, the choice to let in place a massive remain of column in the middle of the room prevented a full excavation but observations are sufficient. Also a bench is still present in the gate between room F and room B.

Over the coated ground floor, preserved over all the room, a layer made of powdery mortar, gravels and pebbles (UF3193) could either be a ground refection or a level of occupancy. In the bench that supports the column, a small hearth (B12-182) was seen but not excavated. No other hearths were found. Sealing this hearth and the UF3193, a thin layer of dark grey silt (UF3192) was also observed in the central bench.

Others occupancy layers were also observed over the bench in the gate. Right above the coated floor, the UF3317, made of brown soil mixed with ashes, pebbles and small stones, is probably the same as the UF3193, or at least contemporaneous. Above, the UF3489 made of grey soil mixed with ashes and few pebbles, is probably localized but looks similar as occupancy layer. Finally, the UF3488, made of brown silt mixed with pebbles, some small stones and corals, might be contemporaneous with the UF3192 but could also be considered, regarding the presence of stones and corals, the first stage of collapse (cf. vol2, p. 24).

- Room F : Collapse layers

The first layer of collapse (UF3076 at north, UF3235 at south and UF3490 in the gate) is made of brown soil mixed with limestones, corals, fragments of mortar and coating, and pieces of the roof.

Right above, the general collapse was artificially divided into several Ufs which are, from bottom to top, UF3069 at north, UF3224 at south and UF3491 in the gate, then UF3045 at north, UF3211 at south and UF3492 in the gate, and finally UF3027 at north, UF3210 at south and UF3493 in the gate. They are all similar, made of brown soil and powdery mortar mixed with limestones, corals, fragments of mortar and coating.

Above and common to the whole room, the UF3008 is the excavation level until the appearance of the walls.

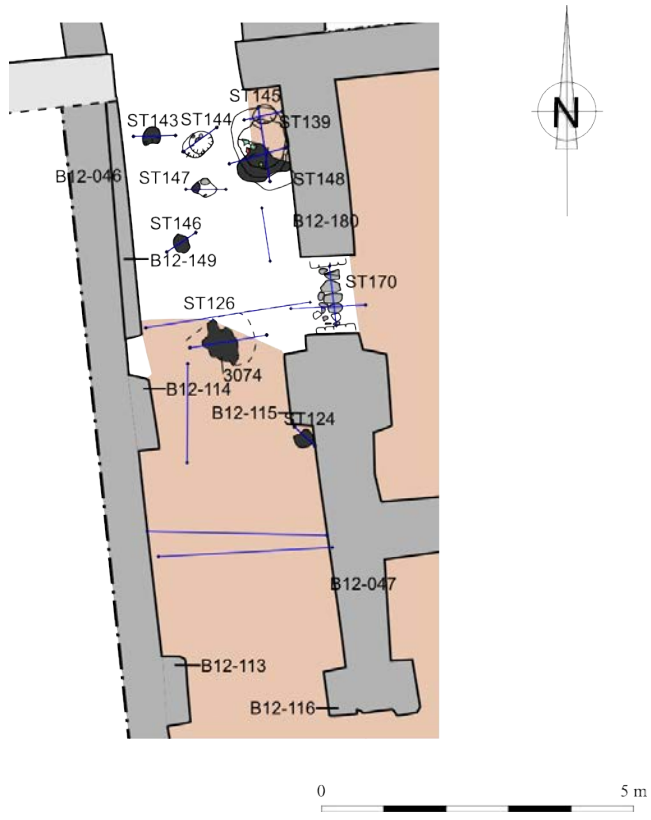

Fig. 90 - Ground plan of room B (north part)

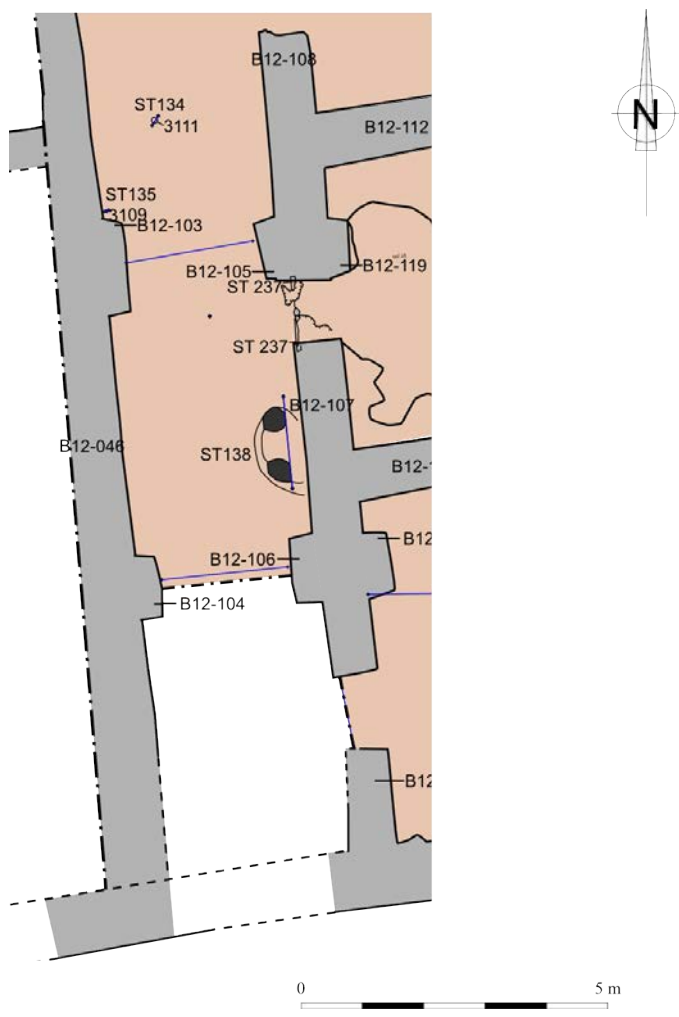

Fig. 91 - Ground plan of room B (south part)

3.2.4. *Span Four (Room B)*

- *Room B : Occupancy structures and layers (fig. 90 § 91)*

In this long single room, the coated ground floor was reached everywhere except the north extremity where it was completely damaged and the southern one where excavations is still incomplete. Several occupancy structures were found directly over this floor.

In the north part, the brown sandy soil with many pebbles (UF3147) which covered the area uncovered by the preserved coated floor could in fact either be the underneath layer of backfill, a poor attempt of repair or the disintegration of the coating. Ceramic study gives a dating from the second half of the 15th century to the first half the 16th century (fig. 92).

Six different hearths were found above this level, and their activities may be the cause of the damage of the floor.

These hearths -B12-143 (UF3156), B12-144 (UF3157 and UF3169), B12-145 (UF3158), B12-146 (Digging : UF3174, Filling : UF 3163 and UF3159), B12-147 (Digging : UF3172, Filling : UF3171, UF3170, UF3160) and B12-48 (UF3162 and UF3161) are not all dug, and their filling are mainly made of ashes and charcoals (cf. vol2, p.25). Slags and mill scales also suggest a craft use. A single piece of mustard ceramic dating from the second half from the 13th century to the beginning of the 14th century might be a later reused.

A little southerly, three others small hearths -B12-101 (UF3049), B12-102 (UF3050) and B12-126 (UF3074)- are probably contemporaneous with the six aforementioned hearths. They are set immediately on the coated ground floor which they have not damaged, maybe because they did not heat that as much.

Covering the entire room from north to south and the underneath layer of hearths, a level (UF3107 at south, UFs 3037 and 3131 at north) made of sand, powdery mortar and coating and few pebbles and gravels, looks like a disintegrated coating. It could be the result of the slow decay of the coating of the walls, but as it is present in the center of the room and that the general collapse did not occurred immediately after, it could also be an unusual way of refection. Ceramic study gives a dating from the second half of the 15th century to the first half the 16th century (fig. 93 § 94).

Six structures of occupancy have been found over that possible new ground floor.

In the southern half, a small hearth (B12-138 ; Filling, UF3130, UF3129, UF3120) and two postholes -B12-134 (Digging : UF3112, Filling : UF3111) and B12-135 (Digging : UF3110, Filling : UF3109)- were discovered. They might not be all linked but they occurred just before the general collapse. In the northern half, three hearths -B12-124 (Digging : 3065, Filling : Ufs 3061 and 3062), B12-139 (UF3133) and B12-140 (UF3138) were also set above the possible new floor. One single piece of ceramic in the filling of the hearth B12-140 gives a dating from the second half of the 15th century to the first half the 16th century (cf. vol2, p. 26).



Fig. 92 - Ceramics from the area B from the mosque (UF3147), 2nd half of the 15th cent., 1st half of the 16th cent.

N°1: Large jar with straight neck. Grey greenish with chamotte and mineral inclusions. Degraded green glaze. Omani production. Qalhati ware.

N°2 : Fragment of jug. Neck with cup rim. Light brown grayish fabric with chamotte and white inclusions. Incised decoration under degraded green glaze. Omani production. Qalhati ware.

N°3: Fragment of bowl. Red fabric with chamotte and mineral inclusions. Red painted decoration under degraded glaze. Arabian production?

N°4: Fragment of jar. Thick brown fabric with white and mica inclusions. Thick blue-green glaze with black speckles. Arabian production.

Fig. 93 - Ceramics from the area B from the mosque (UF3107), 2nd half of the 13th cent., 1st half of the 14th cent.

N°1: Cooking-pot with everted rim. Coarse dark brown fabric with medium chamotte and mineral inclusions.

N°2 : Fragment of bowl. Moulded decoration under white glaze. Chinese production Dehua ware

N°3: Hemispherical bowl with out-flaring rim. Light yellow fabric with fine chamotte inclusions. Green glaze on interior. Omani production. Qalhati ware.

Fig. 94 - Ceramics from the area B from the mosque (UF3131), 2nd half of the 15th cent., 1st half of the 16th cent.

N°1: Bowl with ring base. Orange brown fabric well levigated and fired. Ochre brown glaze on interior. Omani production. Bahla ware.

N°2 : Neck of jug with rounded rim. Brown fabric with chamotte and white inclusions. Incised decoration under degraded green glaze. Omani production. Qalhati ware.

N°3: Fragment of moulded pilgrim flask. Light yellow greenish well levigated fabric. Moulded floral patterns. Iran production.

N°4: Fragment of unglazed jug. Light yellow well levigated fabric. Incised and stamped geometric patterns. Iran production.

Right above that last level of occupancy, maybe subsequent to the effective abandonment of the Mosque, start the collapse layers.

- B12-B : Collapse layers

According to the chosen methodology, the large layer of collapse should have been artificially divided horizontally into six parts and vertically into four levels. But the course of excavations and above all the quantity of architectural remains and decoration discovered did not permit to follow that wish as strictly as expected, especially in the center of the south part where the IsoArc were numerous. However, if the number of UFs increased, the general pattern of division is visible (cf. vol2, p. 27, 28, 29 § 30).

The first stage of collapse, which contains in particular the remains of the roof, gathered from north to south and every sixth: the UFs3119 and 3106; UF3046; Ufs3030 and 3036 ; UF3091 ; UF3102 (fig. 95).

The above artificial layer gathered, following the same order : UF3101 ;



Fig. 95 - Ceramics from the area B from the mosque (UF3102), 14th cent.

N°1: Bowl. Light brown well levigated fabric. White slip under incised decoration, glaze missing. Iran production. Sgraffiato ware

N°2 : Cooking-pot with everted rim. Dark brown fabric with medium chamotte and mineral inclusions. Polished on exterior. Indian production.

N°3: Fragment of jug. Orange brown fabric with chamotte and mineral inclusions. White on exterior (slip?). Omani production. Qalhati ware?

N°4: Fragment of jar. Brown pinkish fabric with organic and white inclusions. White pinkish slip on interior and exterior. Indian production.

UF3028 ; 3012 ; UF3085 ; UFs3098 and 3151.

The third artificial layer, the biggest and most complex, gathered still in the same order : UFs 3090, 3084, 3083 ; UFs 3022, 3020, 3024 ; UF3009 ; UF3080 ; UFs 3051, 3152, 3153, 3154, 3155, 3148, 3149, 3150.

The upper artificial layer gathered more simply : UF3077 ; UF3017 ; UFs 3006, 3004, 3002 ; UFs 3018, 3038, 3021, 3040, 3016, 3034, 3033 ; and on the upper excavated part of the incomplete the southernmost sixth UFs 3199, 3206, 3267, 3268.

All layers are the same, made of brown soil mixed with limestones, corals, charcoals, fragments of mortar and coating and some remains of wood.

Finally, the UF3001 is the excavation level until the appearance of the walls while the UF3000 is the common ground surface cleaning.

3.2.5. The Prayer's Hall

During this season, the sounding made by the QP around the mirhab and minbar was emptied and shortly extended to the east. No sign of occupancy, other than the coated floor, was observed, the layers of collapse starting immediately above that floor.

For now on, only two layers of collapse have been registered. The UF3275 is the level of general collapse and the UF3280 is a thin layer of ashes and burnt soil which was observed from place to place in the collapse. In the UF3275, massive architectural elements (especially the IsoArc501) are apparently remains of pillars and arch intrados with its quite well-preserved spandrels. It is very likely that a cautious excavations of the collapse layers over the preserved floor of the prayer's hall, less disturbed than remains felt in the basement, will give the most precious information.

3.2.6. The north wing (Rooms E, J, P, T, W and areas M and N

- Room E

This poorly preserved room was mainly excavated during the QP campaigns and, as excavations stopped on the first level of occupancy founded (UF3042, made of compacted soil with plaster nodules and charcoal), only one small layer of collapse (UF1181, made of small stones and pebbles mixed with sand) was removed.

- Room J : Occupancy structures and layers

In this room occupied by the basin complex, the only layer of occupancy found is the UF3173, only made of compacted pebbles, filling the basin B12-163, which was probably used as filtrate. As this room is assumed to be a passing place which activity is related with water, it is in fact logical that traces of the first occupancy are so scarce. Ceramic study gives a dating from the second half of the 13th century to the first half of the 14th



1



2

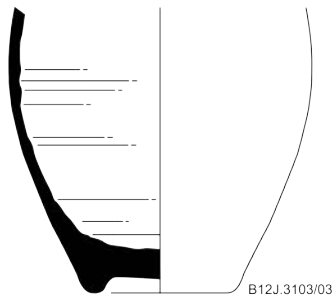

3



B12J.3103/05

4

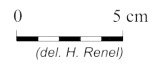

Fig. 96 - Ceramics from the area J from the mosque (UF3103), 2nd half of the 15th cent. – 1st half of the 16th cent.

N°1: Globular jug with straight neck. Light brown fabric, light yellow on exterior; medium chamotte and grey inclusions. Incised decoration. Oman production. Qalhati ware.

N°2 : Globular jar. Orange brown fabric with medium white and mica inclusions. Coarse speckled black glaze. Arabian production.

N°3: Ovoid jar. Fine brown fabric. Ochre brown glaze with dark speckles. Oman production. Bahla ware.

N°4: Globular cooking-pot with everted rim. Coarse dark brown fabric with mineral and organic inclusions. Indian production.

century (cf. vol2, p. 31).

Right above and covering all the room, the UF3118 is made of brown soil mixed with ashes, nodules of plasters, charcoals and various artifacts such as burnt pottery, fishbones and fragments of stucco and molding. Its slope clearly state that this level was thrown from the top of the staircase B12-60 and its composition suggests it is a layer of backfill or a reject deposit.

Over it and filling all the room, the UF3113 is made of loose brown soil mixed with stones. Above, the UF3103 is made of sandy soil mixed with stones and corals, charcoals, fragments of mortar and plaster. This level was also used for the foundation of the wall B12-168, made of stones and charcoals with coating, which was leaning against the wall B12-58 and above the wall B12-161.

Even if the UFs3113 and 3103 looks like layers of collapse, they more likely are layers of backfill, used to fill the room and raise a new circulation level around the height of the bottom of the wall B12-168. Unfortunately, no floor was observed. Ceramic study gives for the UFs3103, 3113 and 3118 a dating from the second half of the 15th century to the first half of the 16th century (fig. 96).

Over the UF3103 however obviously start the general collapse.

- Room J : Collapse and squat layers

In the beginning of excavation, the dividing wall B12-161 between rooms J and P was not known, so the layers of collapse are common to both rooms and registered under room J.

The first layer of the general collapse is the UF3093, made of brown compacted soil mixed with limestones, fragments of mortar and plaster, charcoals and pieces of roofs and coating. Above, at east, the UF3086 made of loose sand is a localized layer and could result of the wind action. At west, along the wall B12-59, the UF3079 made of brown soil mixed with gravels and small pebbles could be a late floor level. Charcoals and ashes suggest a temporary occupancy like a squat.

The last layer of collapse is the UF3081, made of brown sandy soil mixed with limestones, corals, fragments of mortar and coating, and pieces of coated wall which probably came from B12-168. Above, the UF3047 made of sand mixed with stones and fragments of coating has occurred after the stabilization of the collapse.

- Room P : Occupancy structures and layers

In room P, the occupancy structures are the pebbles floor (B12-252), the drainage pit (B12-175) and the gutter (B12-255) already described, and the occupancy layers are mainly linked with the use of the pit.

The whole pit was incompletely filled by a thick layer of pebbles without soil (UF3250) which did not raised to the height of the gutter. This layer was obviously used as a drainage layer, to allow slow infiltration of the water without undermining.

Above that level of pebbles, the pit was sealed with layers of charcoals (UFs 3247 and 3248), a layer of fine soil (UF3249) and a thick layer of

crashed plaster (UF3245), in which many fragments of Kashan tiles were found.

A layer of compacted soil (UF3246) might be a subsequent floor, which covered the whole room, and covered the drainage pit (B12-175) and the gutter (B12-175). A small hearth (B12-158) was found above that level in the center of the room.

Above that possible second floor, several layers of loose soil and thin layers of charcoals and ashes (UFs3201, 3202 and 3196) were found, with a concentration of fragments of Kashan tiles in the south-east corner. These layers could either be layers of reject, and then the room P would have been used as a dumping ground, or layers of craft activity.

A layer made of small pebbles (UF3195) was afterward spread over the room, probably as a backfill for the layer UF3122 which was a brown compacted soil and could have been the last floor in the room. It could however also be an abandonment layer compacted by the collapse.

Ceramic study gives for the UFs3122, 3195, 3196, 3201 and 3202 a dating from the second half of the 15th century to the first half of the 16th century (fig. 97, 98, 99 § 100 and cf. vol2, p. 32).

The above layers of collapse are common with room J and already described.

- Area M : Occupancy structures and layers

This area is a subdivision of the lower courtyard (B12-LC) between the room P and the stair complex in area N and give access to the basement of the Mosque by the span 4.

At east, along the structure B12-192, a floor made of cement (B12-191) was observed in a small surface, and there is yet no evidence that this floor once covered the all area. Above this ground floor was an irregular layer (UF3320) made of plaster, either in blocks or pulverized, mortar and compacted brown soil, which can be regarded, according to location and stratigraphy, as a construction level, made with waste of material used to build the structure B12-192.

This level was covered by a rather flat level (UF 3302) made of compacted brownish soil mixed with pebbles, very similar to the binder of the walls, which can be seen as a new ground floor raised after the construction of structure B12-192, in order to covered the waste's level underneath and created a flat level.

Above it lied a level (UF 3301) made of charcoals, ashes, slags and pulverized plaster. This level can be looked as a backfill, but no corresponding ground level can be found, or a garbage layer. The ceramical study made about the artefacts found in this layer suggests a datation around the middle of the 14th century (fig. 101 and cf. vol2, p. 33).

The previous level was covered by a layer (UF 3300) made of loose brown soil, without artefacts, that can be interpreted as a eolian deposit or a slow runoff moving soils from the top of structure B12-166. This assumed

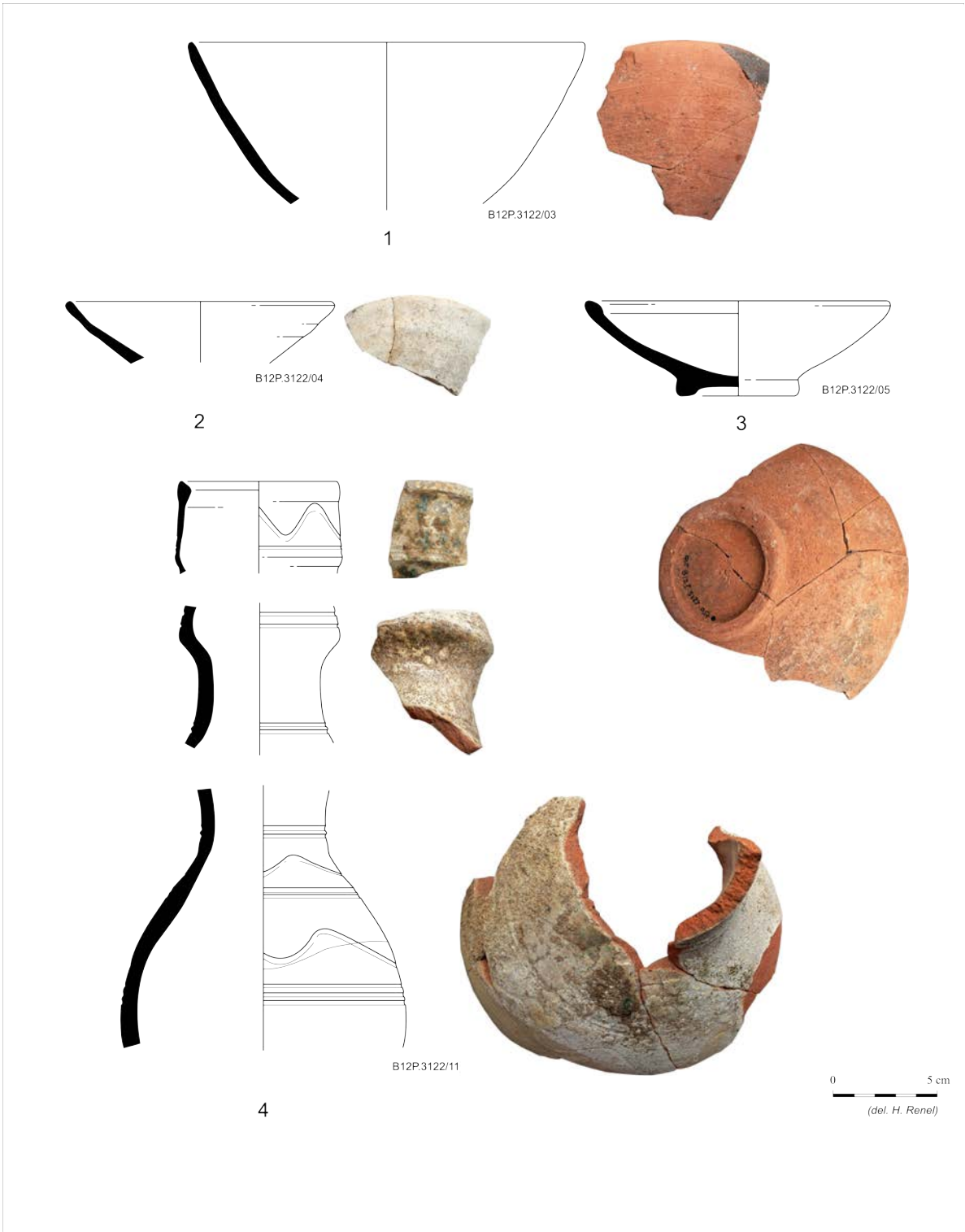

Fig. 97 - Ceramics from the area P from the mosque (UF3122), 2nd half of the 15th cent., 1st half of the 16th cent.

N°1: Hemispherical bowl. Orange brown fabric with chamotte and mineral inclusions. Omani production. Qalhati ware.

N°2: Bowl with out-flaring side. Light brown fabric with mineral inclusions. White on interior and exterior. Omani production. Qalhati ware.

N°3: Hemispherical bowl with rounded rim and ring base. Orange brown fabric with chamotte and mineral inclusions. Omani production. Qalhati ware.

N°4: Globular jug, neck with cup rim. Orange brown fabric with chamotte and mineral inclusions. Incised decoration under degraded green glaze. Omani production. Qalhati ware.

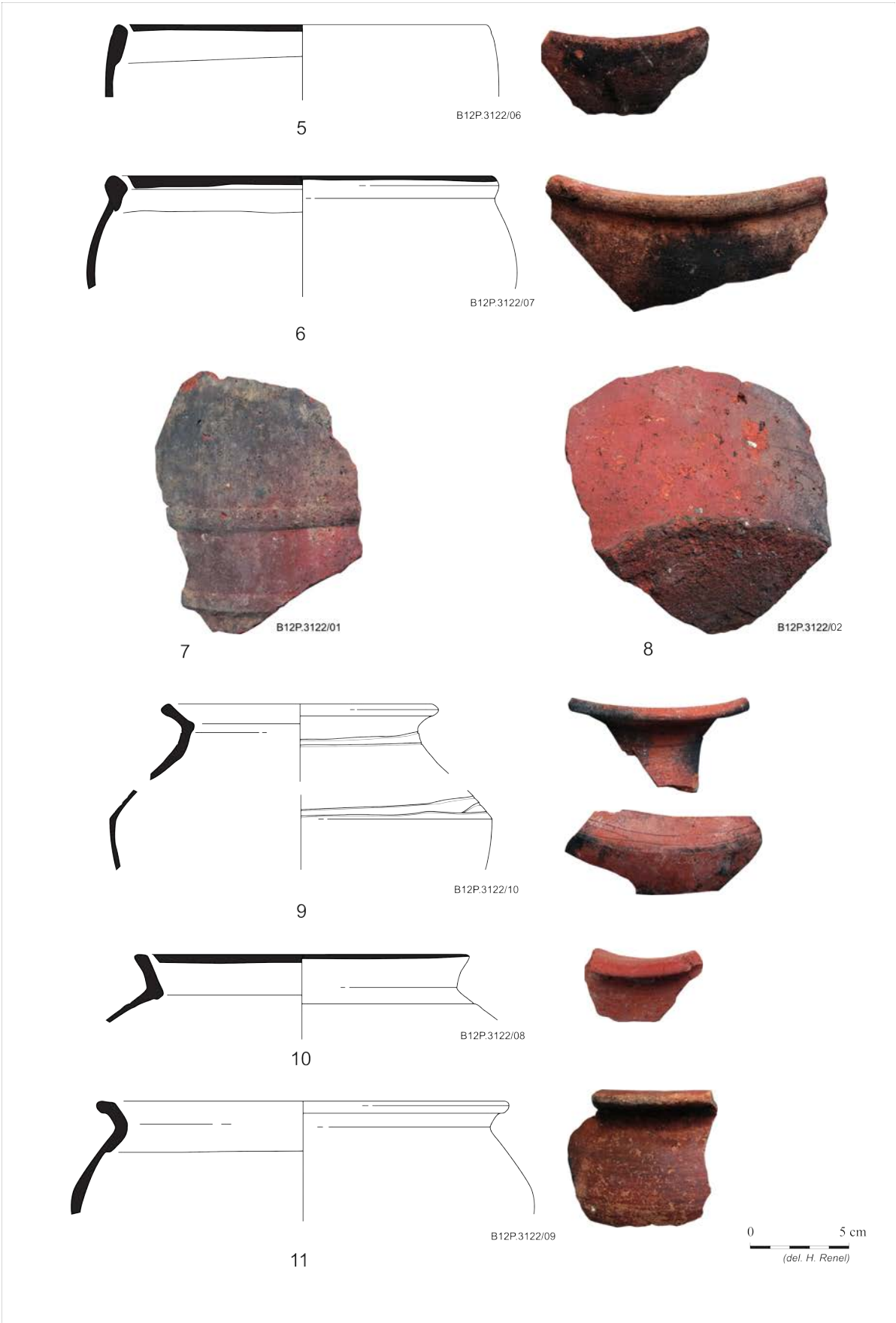

Fig. 98 - Ceramics from the area P from the mosque (UF3122), 2nd half of the 15th cent., 1st half of the 16th cent.

N°5: Handmade cooking-pot. Globular side with rounded rim. Red coarse fabric with medium chamotte, mineral and organic inclusions. Red paint on the rim. Wadi Haqil production (U.A.E.).

N°6: : Handmade cooking-pot. Globular side with rounded rim. Red coarse fabric with medium chamotte, mineral and organic inclusions. Red paint on the rim. Wadi Haqil production (U.A.E.).

N°7: Fragment of storage jar. Red coarse fabric with chamotte and mineral inclusions. Greyish on exterior. Wadi Haqil or Julfar production (U.A.E.)

N°8: Storage jar with flat base. Red coarse fabric with chamotte and mineral inclusions. Wadi Haqil or Julfar production (U.A.E.)

N°9: Carinated cooking-pot with everted rim. Coarse red fabric with chamotte white and mica inclusions. Pink micaceous slip and incised decoration on exterior. Indian production.

N°10: Carinated cooking-pot with out-flaring neck and flat rim. Brown fabric with mineral and chamotte inclusions. Pinkish polished wash on exterior. Red paint on the rim. Indian production.

N°11: Globular cooking-pot with everted rim. Brown fabric with chamotte, mineral and organic inclusions. Brown polished slip on exterior. Indian production.

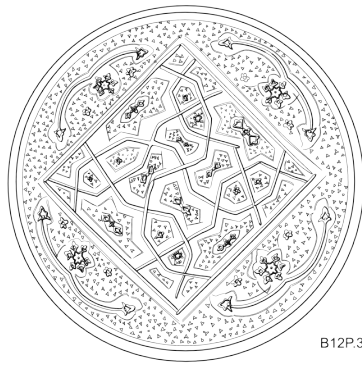

B12P.3122/18

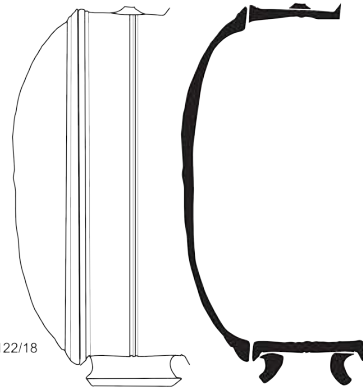

12



13

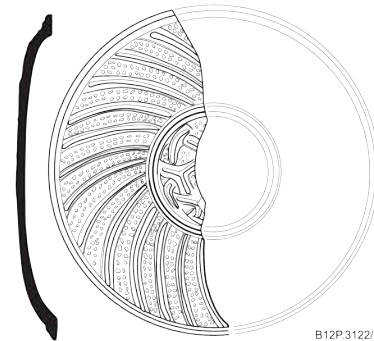

B12P.3122/14



B12P.3122/17

14



B12P.3122/15

15



B12P.3122/12

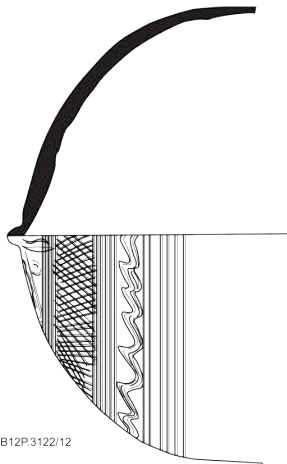

16

0 5 cm
(del. H. Renel)

Fig. 99 - Ceramics from the area P from the mosque (UF3122), 2nd half of the 15th cent., 1st half of the 16th cent.

N°12: Moulded pilgrim flask with ring base. Pale yellow well levigated fabric. Geometric and floral patterns. Iran production.

N°13: Moulded pilgrim flask. White well levigated fabric. Geometric patterns. Iran production.

N°14: Moulded pilgrim flask. Light brown, white on exterior. Floral patterns. Iran production.

N°15: Moulded pilgrim flask. White greenish well levigated fabric. Floral patterns. Iran production.

N°16: Globular flask. Red brown fabric with white inclusions. White on exterior. Combed decoration. Iran production?

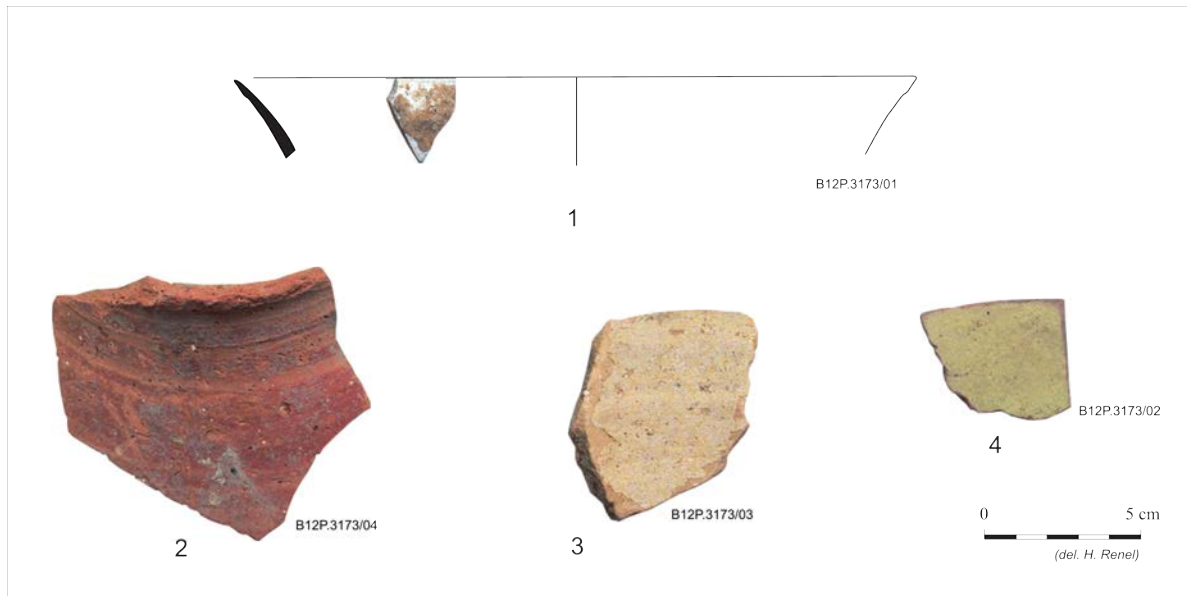

Fig. 100 - Ceramics from the area P of the mosque (UF3173), 2nd half of the 13th cent. – 1st half of the 14th cent.

N°1: Bowl with out-flaring side. White frit ware. Painted in cobalt under glaze. Iran production.

N°2: Jar. Pinkish brown fabric with mineral and organic inclusions. Indian production.

N°3: Bowl with straight side. Light brown fabric, degraded whitish glaze. Omani production. Qalhati ware.

N°4: Bowl. Light brown fabric with mica inclusions. Yellow glaze. Yemen production. "Mustard" ware.

abandonment level is covered by a layer (UF 3279) made of pebbles without soil, itself covered by another layer (UF 3286) made of pebbles mixed with brown soil, both being probably from the same phase, the upper one being mixed with soil infiltrating from the outside and the superior level. Dated by ceramical study from the 16th century, those two layers can be backfill level (their facies corresponding with various structures filling levels found elsewhere in Qalhat), but there is no structure in the vicinity with which connect this level.

- Area M : Collpase layers

Both previous levels are covered by a level (UF 3276) made of blocks of coral and stone, mixed with compact yellowish soil which is the

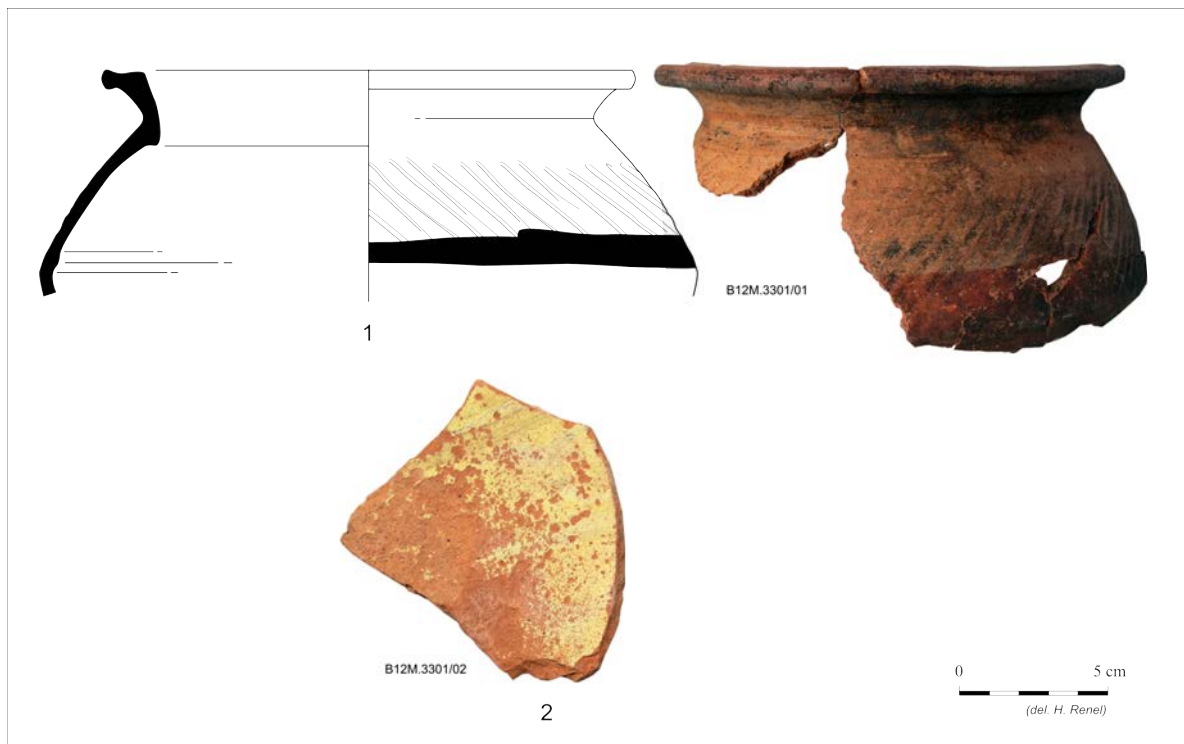

Fig. 101 - Ceramics from the area M from the mosque (UF3301), mid 14th cent.

N°1: Carinated cooking-pot with straight neck avec everted rim. Coarse dark brown fabric with medium mineral and chamotte inclusions. Paddlestamp and painted decoration. Indian production.

N°2 : Bowl. Light brown fabric with fine mica inclusion. Yellow glaze. Yemeni production. "Mustard" ware.

disaggregation followed by resolidification of the mortar of collapsed columns which lies above this level.

The other parts of collapse, made of limestones and coral mixed with a disintegrated mortar, were divided in UFs 3121, 3135 and 3200. In area M, the coating and mortar of the collapsed walls and architectural elements (such as columns) have somehow melted before solidified again, complicating the understanding of the collapse.

- Area N : Occupancy layers

In this area, the occupancy structure is the stair complex (B12-166 and B12-192) already described.

A thin layers of ashes (UF3219) was found above the stair. This level

could result from a localized fire. Ceramic study suggest a dating from the second half of the 15th century to the beginning of the 16th century but the quantity is not sufficient to be affirmative.

A covering layer of pebbles (UF3234) could be a new floor or a layer of final occupancy.

- Area N : Collapse layers

Above the layer of pebbles (UF3234) and sometimes directly over the stair B12-166, the first layer of collapse (Ufs3182 and 3233) is made of compacted brown soil, which could be an abandonment layer compacted by the collapse above. Ceramic study suggest a dating from the second half of the 15th century to the the beginning of the 16th century but the quantity is not sufficient to be affirmative.

The main phase of collapse was registered as UF3181. It is made of limestones and coral, fragments of mortar and coating, powdery mortar and plaster mixed with sandy brown soil. Above, the UF3135, made of the same components, is a ground surface cleaning.

- Room W : Occupancy structures and layers

In this antechamber of room G, a floor level (B12-197) was reached everywhere and no structures of occupancy linked with it was found. A layer of pebbles and gravels mixed with loose brown soil (UF3332) was covering that floor, in a feature already seen in others rooms.

Two hearths, maybe contemporaneous, were found above that level, B12-196 (UF3333) in the north-west corner and B12-240 (Ufs 3411 and 3412) against B12-286. The hearths and northern part of the layer 3332 are covered by a level of loose grey sediment (UF3331) which could be a level of abandonment brought through the gate by the wind (cf. vol2, p. 34).

- Room W : Collapse layer

The filling of the remain of the room W is made by a single layer of collapse (UF3326) composed by limestones and corals, fragments of mortar and plaster, piece of coating and roof and architectural elements, especially fragments of a decorated cupola or a dome that was probably covering the top of the room.

Other parts of the collapse have been excavated during the QP campaigns.

- Room T : Occupancy structures and layers

In this antechamber to room K, the ground floor was found almost everywhere and several traces of occupancy were observed.

Two postholes were found quite in the middle of the room : B12-248 (0,16x0,15 ; Digging : 3434, Filling : 3435) at north and B12-270 (0,17x0,16 ; Digging : 3474, Filling : 3475) at south. They probably supported a wooden structure, such as a shelve, set in the recess created by the piedroit of the two gates (cf. vol2, p. 35).

The floor and postholes were afterward covered by a layer of pebbles

mixed with brown soil (UF3418), which is undoubtedly a level of occupancy similar to those found in the basement. Two layers were found above it. Next to the gate that leads to room K, a layer made of dark brown soil, very organic (UF3429) might be the decomposition of a wooden element (probably a door) as several pieces of wood were found in that layer. In the west part of the room was also observed a level of small pebbles (UF3419).

Covering all layers, a thick level of loose brown soil (Ufs3310 and 3312) with charcoals but no others elements is quite probably a backfill. A temporary hearth, containing a fish tail, was found in the north-east corner of the room. Ceramical study gives a datation between the end of the 15th century and the beginning of the 16th century (fig. 102).

In the south part of the room, the UF3428 is made of adobe and a single row of stones was set over it and against the wall B12-128 in order to create a very low bench (B12-271). Ceramic study gives a 16th century datation.

Over this bench and covering the whole room, the UF3307 made of brown soil mixed with charcoals and ashes is probably a backfill to create a new floor, which is the last stage of occupancy, dated by ceramic analysis from the end of the 15th or beginning of the 16th centuries.. A carbonaceous layer (UF3424) was observed above that level in the south-east corner of the room, containing many ashes and charcoals and also powdery lime that might come from burnt corals, suggesting a craft use (cf. vol2, p. 36 § 37).

- Room T : Collapse layer

A single layer of collapse was registered here. The UF3297 is made of sandy soils mixed with limestones and corals, fragments of mortar and plaster, and pieces of wood, including a decorated one, engraved with lines that seems to draw a fleuron. It probably came from the top (probably the lintel) of a wooden door between rooms T and K.

Other parts of the upper collapse have been excavated during the QP campaign.

3.3. Synthesis of the stratigraphy

The excavation of the entrance (B95) of the complex revealed two phases of occupation . The first ground floor is probably contemporaneous of the street level discovered in the passageway. The study of this area is still in progress so more details about the dating and the relationship between the building, the structures and the occupancy layers could be lightened during the next session.

The series of little buildings (B139) discovered against the south part of the enclosing wall of the complex is also still in progress. For now only the last occupation is known and it correspond to a sand layer. A lot of fragments of jar for water discovered in this layer suggest that this building was the place of several stores. The dating estimate the last



B12T.3310/01

1

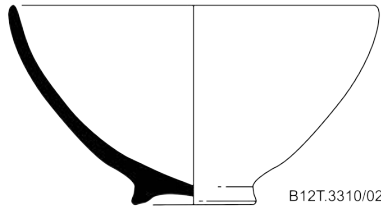

B12T.3310/02

2



B12T.3310/04

3

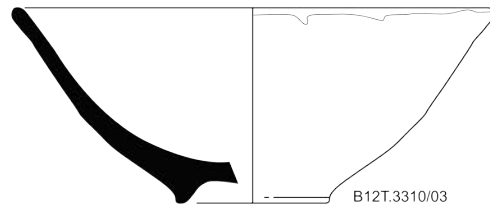

B12T.3310/03

4

0 5 cm
(del. H. Renel)

Fig. 102 - Ceramics from the area T from the mosque (UF3310), end of the 15th cent., 16th cent.

N°1: Hemispherical bowl. Light brown fabric with fine mineral inclusions. Omani production. Qalhati ware.

N°2 : Hemispherical bowl with ring base. Fine light grey brownish fabric with mineral inclusions. Omani production. Qalhati ware.

N°3: Large jar. Orange brown fabric with mineral inclusions. Light grey on exterior. Reuse as "tanûr". Omani production. Qalhati ware.

N°4: Hemispherical bowl with ring base. Brown fabric with chamotte and mineral inclusions. Degraded green glaze. Omani production . Qalhati ware.

occupation of the end of 15th century to the beginning of 16th century.

The majority of datable occupancy layers, discovered during the excavations of the mosque (B12), are from of the end of 15th to the beginning of the 16th century according to the ceramic study. Only some exceptional remains are identified as end of 13th to beginning of 14th century or second half of 14th century.

These most ancient occupancy layers are localized in the north wing: the system of filtration in the basins of the room J and a rubbish dump area in room M.

In the internal of the basement most of the time the floors are coated, except in room H and V but the excavation is still in progress so we don't have the entire vision of these rooms. Some wood structures have been identified particularly in room Q with the discovery of nine postholes, probably last evidence of a mezzanine or, of wooden shelves, for storage. The oldest occupancy layers of the basement are different depending the room. It could be a compacted soil, a brown soil or a level of pebbles mixed with soil.

All the dating of the ceramics coming from the internal of the basement give a chronology between the end of 15th and beginning of 16th century. They clearly correspond of the last occupation. Nevertheless a lot of interesting information appeared for the occupation around 1500, indeed some craft area have been determined, especially in room B with the presence of thirteen hearths associated with ashes, charcoals, slags and mill scales corresponding on a metallurgic activity, possibly a forge, and could reveal a phase of repairs of the mosque. Also all rooms, except rooms C and F, were recovered by a level of pebbles mixed with soil and most of the time associated with hearths. These level seems to correspond of the occupation around the Portuguese arrival.

4. The decorative elements: description and location

The work on decorative elements found in the Great Mosque of Qalhat (called B12) was a part of the specialized studies executed during the excavations.

Over the past two campaigns, a study protocol has been developed, which was possible mainly thanks to the methodical excavations accomplished on the field.

Among the excavations protocol elaborated on the field, two points were essential for the Mosque decoration study. Firstly, each span was divided in various portions allowing the positioning of the material found inside those parts. The second one was the methodical dismantling developed in order to first preserve the decorative elements, and then to submit a restitution of those elements.

One of the main objective in B12 is the restitution of the decorative elements in the architectural plan of the mosque which could complete the whole restitution of the Mosque.

The first step leading to a better understanding of the Mosque decoration was to review and complete the initial classification of all the elements found during the excavations. The result is not exhaustive though, considering the fact that the entire Mosque has not been excavated yet.

4.1. Typology

After a quick glance on the various elements and since the very start of the research, it has been decided to classify them in three different categories. This classification was mostly established according to their manufacturing technique.

4.1.1. Basic elements

The first category includes the basic element (a single identifiable element) which concerns stone elements, tile elements, mortar elements, and wood elements.

- Stones

Regarding the stone elements, the choice to introduce them in the classification has been made because these stones are cut in different shapes, in addition with their association with other decorative elements. The average measures submitted in this report have been calculated from a series of measures executed on each finding.

Three main shapes were identified

- The EICH or Bobbin (fig. 103)

Some stones are cut in an elongated hexagon shape, the so-called EICH (Elongated Irregular Convex Hexagon) stones. This stone shape is also



Fig. 103 - EICH

called bobbin (Dewar 2009 : DEWAR (R.E.) - Islamic Girih Tiles in their own right as a history lesson and design in the classroom- Symmetry : culture and science. 20, 2009, p. 201-216), but for this study it has been chosen to call it by the acronym EICH.

They can be declined in at least four categories :

- a full and regular EICH which is about 0,32 m length and 0,16 m height.
- a half horizontal EICH, with the same length as an EICH, but cut in a half measures between 0,07 m and 0,08 m height.
- a half vertical EICH is 0,16 m height for 0,16 m length size.
- a quarter of EICH measures so 0,16 m length by about 0,08 m height.

In a same way, some of them have been noticed as curved EICH :

- a set of the same shaped stones except that they are curved (curved EICH, curved $\frac{1}{2}$ horizontal EICH, curved $\frac{1}{2}$ vertical EICH), with the same average size. Only the quarter of EICH element has not been observed as curved.

- The Quatrefoils (fig. 104)



Fig. 104 -
Quatrefoil

Other stones are cut in a quatrefoil shape, they can be also divided in three kinds :

- a full quatrefoil which size is about 0,18 m length by 0,18 m height.
- a half quatrefoil measures 0,17 m length and 0,08 m height.
- a quarter of quatrefoil is around 0,08 m length by 0,08 m height.

- Quadrangular cut stones (fig. 105)



Fig. 105 -
IsoArc 402

The last stone category identified as decorative elements is the quadrangular cut stones. They have been divided in two main types :

- a rectangular cut stone, which can be curved
- a square cut stone, which can also be curved

For those elements, an average measurement is not particularly meaningful since it has been quickly noticed that the stones are very different in size, according to their location in architectural elements.

The back of the stones appears to be carved in different ways without visible meaning, if not to embed them easily in any masonry. Moreover, the thickness of all these stones seems to vary depending on their initial position in the architectural element

- Glazed tiles

The second main category concerning the basic elements is the glazed tiles one. This special classification took a main part of the work since it is from the precise identification of each element that an hypothetical restitution of the Mosque decoration is possible.

Thus, the typology given here has been re-organized considering the work of counting on the findings.

- The Stars (fig. 106)

First, different types of star tiles have been identified and classified in three main categories comprising complete stars, half stars and stars quarters. Two main types emerge with three subcategories each.

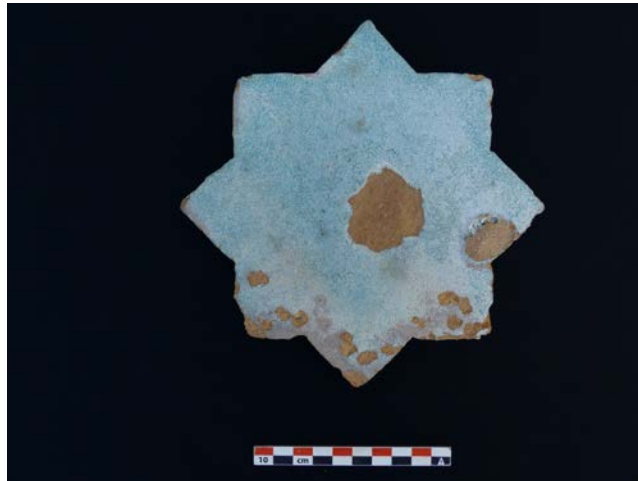

Fig. 106 - Turquoise complete star

- The glazed stars :

- Undetermined complete stars, half stars and stars quarters
- Green complete stars, half stars and stars quarters
- Turquoise complete stars, half stars and stars quarters

- The metallic luster stars :

- Undetermined metallic luster complete stars, half stars and stars quarters
- Gold type metallic luster complete stars, half stars and stars quarters
- Gold type with a blue border metallic luster complete stars, half stars and stars quarters

In the same way as the stone elements, a series of measures has been made so an average size of each element can be reported. The complete stars are about 0,18 m by 0,18 m while half stars measure 0,18 m by 0,085 m. At last, the stars quarters size is around 0,08 m by 0,08 m.

• The Crosses (fig. 107)

The second category concerns the glazed crosses tiles. Again, these tiles



Fig. 107 - Blue cobalt complete cross

can be divided into two main types which comprise complete crosses and half crosses. A third type, crosses quarters, has been added even though it has not been observed, since it seems that in the decorative compositions, the crosses quarters are substituted by fragment of crosses.

Four categories have been defined

- Undetermined complete crosses and half crosses
- Green complete crosses and half crosses
- Blue cobalt complete crosses and half crosses
- Turquoise complete crosses and half crosses

The measurements on the crosses reveal that those elements are of the same size as the stars.

- The Rectangular Tiles (fig. 108)



Fig. 108 - Metallic luster rectangular tiles in slight relief

The rectangular tiles represent four different categories :

- Moulded turquoise rectangular tiles
- Lajvardina rectangular tiles
- Metallic luster rectangular tiles in slight relief, which are approximately 0,25 m by 0,25 m
- Gold type metallic luster rectangular tiles

As it has been mentioned above, the unfinished excavations and moreover the too fragmented tiles, have not permitted to submit the hypothetical measures of these elements, since a full restitution can't be produced at this point.

- The Fragments of Tiles (fig. 109)

The last sort of tiles defined (fragments) does not actually concern a basic element but rather a category added to the material recording file. So, the fragments of tiles belong to each category enunciated above.



Fig. 109 - Green star
fragment

- Elements/Mortar

The third basic elements identified are the mortar elements. The issue of using the term "stucco" or "plaster" has been raised but at this point of study, and since more analysis are needed, it was decided to keep the word "mortar" in this preliminary report.

In order to organize the typology in a better way and mostly to help and accelerate the material recording, it has been decided to name the elements in mortar (Elements/Mortar) by their acronym (EM) and attribute a number to each identified decoration. These basic elements could be re-organized in different subcategories according to the decoration type, but at this point of study and since more time is needed to fully apprehend the decors, it was chosen to present in this report only a list of each identified element, as it is submitted in the catalog.

• Negative elements : the molds

Two types of mortar elements belong to this category because of their manufacturing techniques, however, they are not actually decorative elements but they rather take part in the making of the elements.

- EM 10 is a mortar mold executed to prepare EM 2, EC 3 or even EC 4 elements (see Elements/Composite). Like these categories, the full restitution pattern is under study. Nevertheless, it seems that the mold is smaller than the decorative element itself.

(fig. 110)

- EM 14 is a mortar mold for EC 5 or EC 6 decorations (see Elements/Composite). It happens to be quite the same size as EC 5, EC 6 panels and of course, presents the same pattern.

(fig. 111)

• Positive elements : various patterns

The other mortar elements are truly decorations units, and have been categorized depending on the pictured pattern or somehow their function.

Some EM have been added to this typology considering that several fragments were found during the previous soundings since 2008. The work on those elements is still in progress, as the entire Mosque complex has not been presently fully excavated (it is the case for EM 5, 6, 7, 8).



Fig. 110 - EM 10 is a mortar mold



Fig. 111 - EM 14; a mortar mold for EC 5 or EC 6

- EM 1 is a square mortar panel which is about 0,36 m side and between 0,03 m and 0,04 m thick. This molded panel is decorated with elongated hexagons forming a cross shape, repeated four times. The combination of the four crosses composes a central eight-pointed star decorated with eight trefoil shaped florets. The panels are often re-cut, this seems to be part of the desired organization of the decoration in the architectural elements. This type of panel is often very deteriorated, so that the stylized moldings have more or less disappeared. (fig. 112)

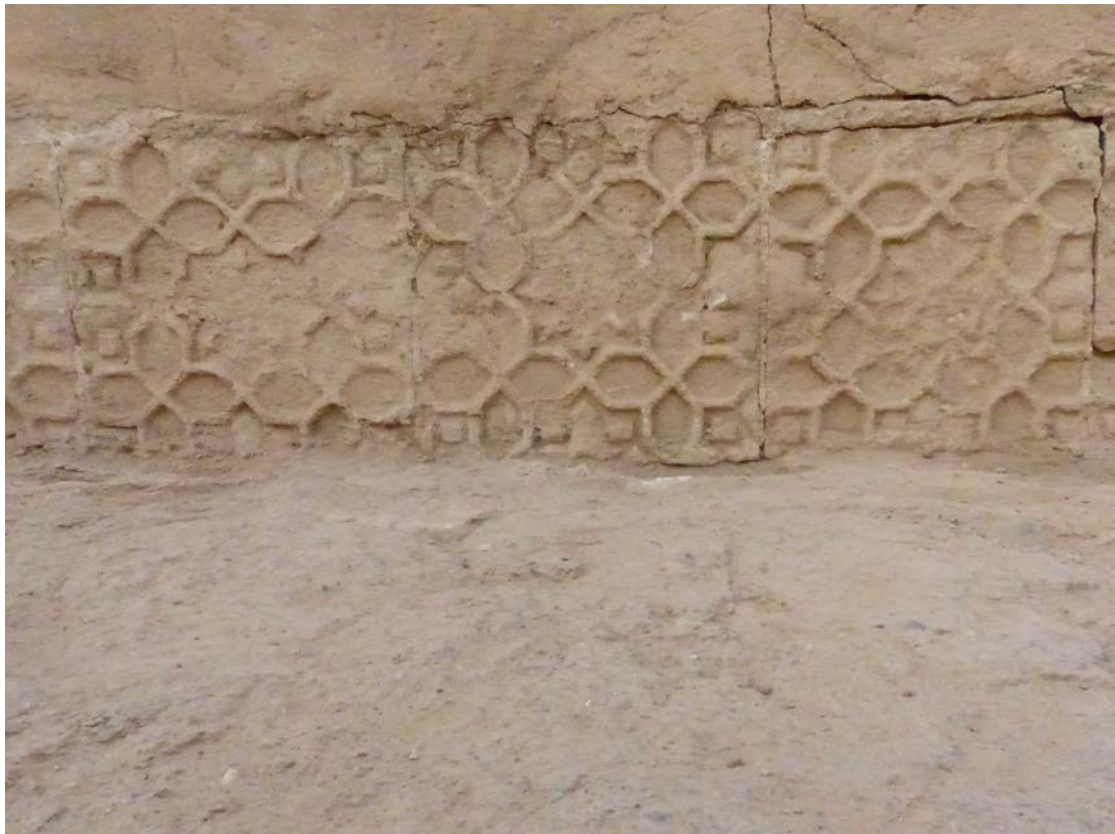

Fig. 112 - Layout of EM 1 panels on the Minbar, see also Style L

- EM 2 is a mortar panel with a geometric molded pattern, comprising stars, irregular hexagons and elongated diamonds. It is still under study even if the overall organization of this pattern is well-known in the Islamic

world. No complete panel has been found out yet, which does not allow to produce measurements and so, the full restitution of this panel. (fig. 113)



Fig. 113 -
EM 2

- EM 3 has been added in this typology still based on the material used to produce those elements, as claustra, probably fragments of Moucharabieh panels. Unfortunately, those found are in a bad state of conservation, and the pattern restitution is not possible at this time of study. Nevertheless, it can be presumed that the pattern is also well-known in the Islamic world as for EM 2. Only the location of the elements could thus give a general idea of the panels position in the architecture of the Mosque.(fig. 114)



Fig. 114 - EM3 fragment,
B95_3525

- EM 4 is a mortar frieze with directly carved intersecting circles. Again, the general pattern is not fully understood at this point. The hypothetical restitution of this element report a kind of frieze which could be on two lines of interlaced circles.

- EM 5 is a mortar panel with a geometric molded design, organized around a central five-pointed molded star. The restitution pattern is under study.

- EM 6 is a mortar element in a triangular shape. It contains a quadrangular Kufi inscription with Muhammad name, combined with vegetal decorations.

(fig. 115)

- EM 7 is, in the same way as EM 6, a mortar element with an inscription. The difference here is that EM 7 is likely a panel, and the inscription is a classical linear one.

(fig. 116)

- EM 8 is a mortar panel decorated with a carved trefoil floret. It is likely assumed that this vegetal decoration is a part of a larger wall decoration.



Fig. 115 - EM6



Fig. 116 - EM7

The restitution pattern is under study at this time (fig. 117)



Fig. 117 - EM8

- EM 9 has been added as a single rectangular mortar panel, while it seems to be a wide coverage of wall. Each panel fragment measures around 0,43 m height by 0,22 m width. It is not possible to propose any decoration restitution as the panels are poorly preserved. Nevertheless, it can be supposed that it was somehow molded with a decorative pattern.

- EM 11 represents some moldings applied to a wall, cutting the wall itself into different panels. This category is actually more a grouping of several molded lines which induce a general organization of the decorations wall, than a decorative element itself. Usually, the moldings form frame doors and horizontal bandeaux with molded triangles frieze. (fig. 118)

- EM 12 is a mortar panel picturing stylized molded half crosses on the edges, forming molded eight-pointed stars. The stars contain palm leaves decorations at each star tip, organized around a central small eight-pointed star. The crosses include an inside complex pattern of trefoil florets



Fig. 118 - EM11

decoration. The panel is mostly rectangular with 0,44 m length and between 0,21 / 0,22 m height. (fig. 119)



Fig. 119 - EM12

- EM 13 is a mortar element comprised in a significant architectural element which is the Muqarnas. No real decoration have been found on the mortar panels as it seems to be poorly preserved, and the full restitution is not known at this time since the Muqarnas is first an architectural element, and then a decorative one. However, it can be assumed that the panels were likely molded or carved with some designs. (fig. 120)



Fig. 120 - EM13

Fan Vault elements could also be integrated here, since their manufacturing technique makes them belong to the mortar elements category. However, more time is needed for this research and so the understanding and restitution of this architectural unit is still under study.

4.1.2. Elements/Composite :

The next category to be defined is the composite elements (Elements/Composite) consisting in a combination of mortar elements and tiles elements. Again, in order to arrange the typology effectively and for the material counting and recording, it was decided to name each identified element by their acronym (EC) and an associated number.

- Element/Composite 1

EC 1 is a square mortar panel which is about 0,36 m side and between 0,03 m and 0,04 m thick, as EM 1.

Fragments of elongated hexagon shape glazed tiles are inlaid in the mortar forming a decoration of crosses. Each cross is thus formed by four fragments of tiles, this is repeated four times. The combination of the four crosses composes a central eight-pointed star decorated with eight trefoil shaped florets.

The glazed tiles can be green, blue cobalt or turquoise and it seems to exist a kind of color play. Indeed, it has been observed that the panel is either totally inlaid with turquoise or green tiles, while sometimes, it can be half blue cobalt half green, one cross receiving two tiles from each color. It could be vertical lines blue cobalt and horizontal lines green. Unfortunately, this color play has not been noticed in situ, and an hypothetical restitution could be possible through the location of these

elements in the collapse levels.

The glazed tiles are not originally moulded in the elongated hexagon shape, and so have been re-cut as evidenced by the saw marks.

The panels are often re-carved, surely to precisely integrate the desired organization of the decoration in the architectural elements. (fig. 121)



Fig. 121 - EC1

- Element/Composite 2

EC 2 is a four-pointed star in mortar inlaid with green, turquoise or blue cobalt glazed tiles, molded in finish. The stars are approximately 0,26 m by 0,26 m.

Again, the different colors seems to create a color play, which leads to split EC 2 into two subcategory.

The first category is the four-pointed star with green glazed tiles in each point. The center is made of one or sometimes several blue cobalt fragments also in a four-pointed star shape. The finished molding represent a small star inside a bigger one.

(fig. 122)

The second subcategory is a four-pointed star with either green or turquoise glazed tiles at each point and one small square tile in the center, from each color too. No real organization has been observed though, and it could be assumed that the choice of green or turquoise can be random. However, around the square star center, four small triangular blue cobalt tiles are located on each square side. The whole center pictures thus a small four-pointed star inside a bigger one (as in the first subcategory).

(fig. 123)



Fig. 121 - EC2, first sub-category



Fig. 123 - EC2, second sub-category

- Element/Composite 3

EC 3 is made of several fragments of glazed tiles inlaid in a mortar panel. The inlay seems to be quite rough since it is the final covering molding which draws the pattern. Unfortunately, the retrieved elements didn't furnish enough information to reconstitute the full pattern or even give an average size of a panel. However, the molding seems to create an already well-known geometric design in the Islamic world which is one n-pointed central star with irregular hexagons around it and then small n-pointed stars, this grouping repeated over and over. After several measurements on each tile element composing EC 3, it can be assumed that the pattern is more likely made of big groupings and smaller ones combination. But, all the small subtleties can not be re-created at this time.

The molding is presumably applied with EM 10 elements, which as it has been seen, is smaller than a full EC 3 panel. The applied moldings appears then to be random so that the decoration pictured is not always alike even if the overall pattern remains the same.

(fig. 124)

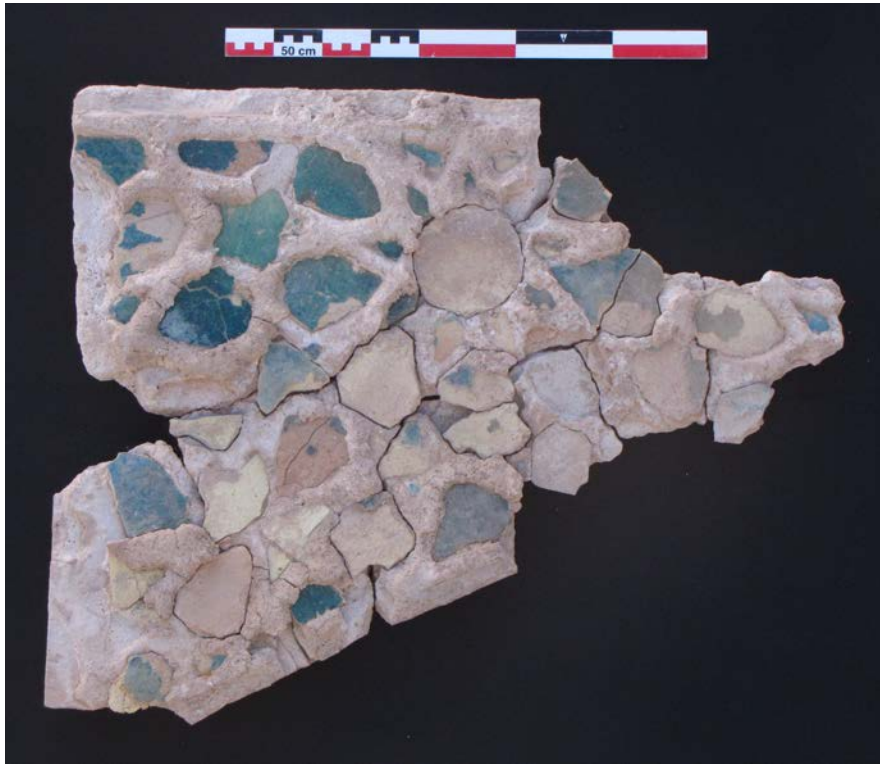

Fig. 124 - EC3

- Element/Composite 4

EC 4 is a mortar panel inlaid with fragments of glazed tiles molded in finish. Even if the general pattern formed by the applied molding seems to be the same as EC 3, it is quite different about the stars shape and the hexagons. Here some of the hexagons are regular and some of the stars have a pentagon center. Moreover, it has been observed that some of the tiles are turquoise what has not been noticed in EC 3.

Once again, the discovered elements are too fragmented to reconstitute a full pattern, even if with some comparison, an hypothetical restitution could be possible (fig. 125).



Fig. 125 - EC4

- Element/Composite 5

EC 5 is a rectangular mortar panel inlaid with metallic luster tiles, interposed with small fragments of blue tiles (fritware or dark luster). The panel is about 0,43 m length and 0,30 m height.

The applied final molding sketches a trefoil floret repeated four times creating thus a cross pattern. The metallic luster tiles are moulded in a stylized star shape.

- Element/Composite 6

EC 6 is a rectangular mortar panel, actually quite equivalent as EC 5. The general pattern seems to be identical and it can be assumed that the same mold has been used to apply the final molding (see EM 14). The difference lies in the crosses pattern which are inlaid with green fragments of tiles whilst blue fragments of tiles seems to be nonexistent.

(fig. 126)



Fig. 126 - EC6

In both of these cases, metallic luster used has been re-carved in a suitable shape for this precise panel type. However, the choice of metallic luster seems to be random since various tiles have been used as the gold type or the metallic luster in slight relief type.

- Element/Composite 7

EC 7 is a rectangular mortar panel with the same size and identical molded decoration as EM 12. The difference lies in the central stars which are inlaid with a green fragment of glazed tile.

(fig. 127)

- Element/Composite 8

EC 8 is a mortar panel inlaid with fragments of glazed tiles and molded in finish. The applied molding is thicker than any other molded element. The design could even have been directly carved on the mortar panel. The



Fig. 127 - EC7

geometric pattern is made of small squares in an irregular tracery. The hypothetical restitution of this pattern would form a square mortar panel. (fig. 128)



Fig. 128 - EC8

4.1.3. Styles :

Finally, the last category which was defined is a blend of basic elements and composites elements. The Styles (as it was called) are actually more a decoration set constituting a specific architectural element.

At least seventeen different styles have been identified.

- Style A

Style A is a composition between EICH stones and EC 2. The full element comprises nine EICH, six half horizontal EICH and six half vertical EICH (placed on the borders), and four quarters of EICH (arranged in the corners). It also contains twelve EC 2, which are located between EICH angles. The full element reconstituted is likely square, about 1 m side.

(fig. 129)

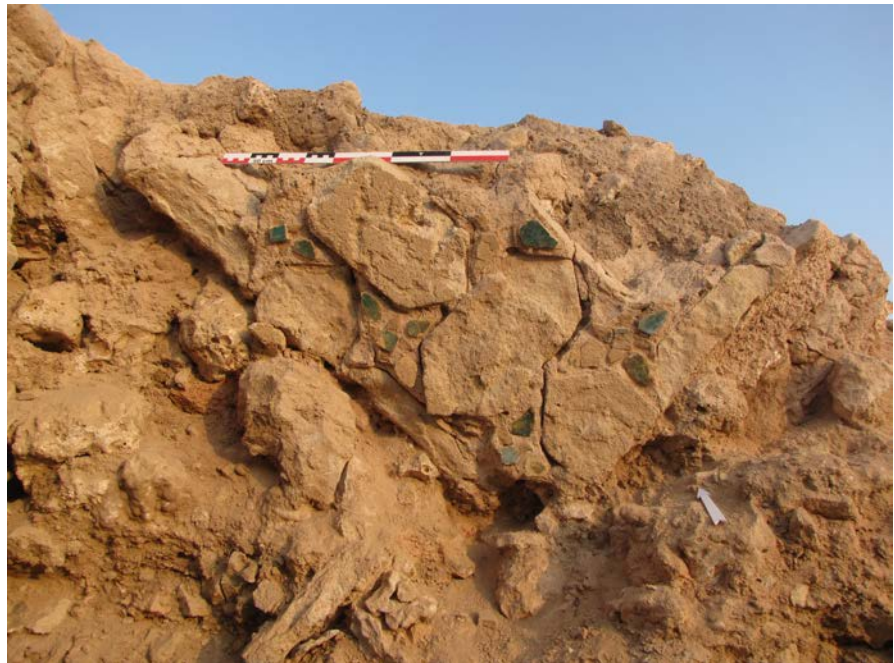

Fig. 129 - Style A

- Style B

Style B is an arrangement of different carved stones and glazed tiles. Quatrefoils are arranged in a line with half quatrefoils interposed on the edges. This combination forms mortar slots in eight-pointed stars shape and half stars shape where complete stars and half stars glazed tiles were placed. Slabs are used as borders in finish, slice measuring around 0,04 m width. The whole “frieze” is about 0,44 m width. The total length is not known at this time, although about 1,30 m length were preserved and so, observed in situ.

- Style C

Style C is a composition of glazed tiles and mortar, and half quatrefoils. The reconstitute module is made of four inlaid crosses disposed in a square, forming a central eight-pointed star and half stars on the sides.

Half quatrefoils are located on either side so that only slices can be seen. It could be possible to find half crosses starting this decorative element, even if it has not been seen in reality. This element is about 0,44 m width. (Style C)

- *Style D*

Style D is a combination of several complete tiles and half tiles, which can be jointed or side by side. Two kind of distribution set has been observed. The first noticed is a frieze made of complete crosses and green half stars. A color scheme exists between green and blue cobalt interposed crosses. On the frieze corners, it can be either half crosses or stars quarters. The frieze is 0,18 m width and the greatest length retrieved at this point, is between 0,70 m and 0,80 m.

(fig. 130)

The second is a panel combination with two central green eight-pointed stars surrounded by blue cobalt half crosses. The panel corners are made of crosses (almost) quarters, which have been re-cut from a complete cross. As its purpose seems to be a wide coverage, this panel would repeat itself along a large area. (fig. 131)

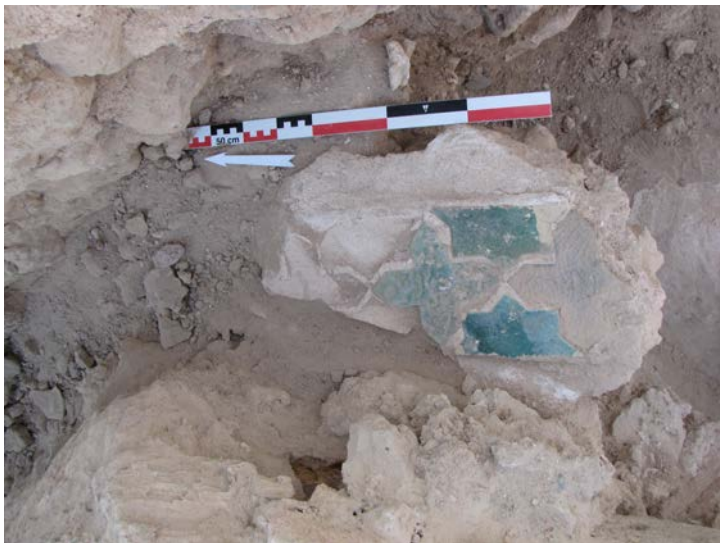

Fig. 130 - Frieze style D



Fig. 129 - Panel style D

- *Style E*

Style E is made of inlaid eight-pointed stars and half-stars (arranged against a border), in green color. Unfortunately, at this point, it is not possible to submit a restitution of this element, since its coverage is not known.

(Style E)

- *Style F*

Style F is a combination of crosses and half quatrefoils. The decoration set is identical as Style C, apart from half quatrefoils which are located on the edge. They are disposed so that this side forms a curvature.

(Style F)

- *Style G*

Style G is a blend of EC 3 panels and half quatrefoils forming the edge. These ones are also located on a curved line.

These two last styles have not been observed in their full dimensions. Only an hypothetical restitution is possible through surface calculations.

(fig. 132)



Fig. 132 - *Style G*

- *Style H*

Style H is made of blue and white ceramic fragments inlaid in mortar. The most likely restitution is one of four fragments disposed to form a cross. This being equivalent to EC 1 pattern, could also be repeated four times. As EC 1 for example, the same surface is covered by this pattern.

At this point of study, this element belongs to the Style category, although a more detailed study would tend to sort it out in the Elements/Composite category.

(fig. 133)



Fig. 133 -
Style H

- *Style I*

Style I is a frieze of inlaid glazed tiles arranged on a border. It is constituted by green eight-pointed stars and green complete crosses forming a diamond shape. On each frieze side are disposed half green stars, interposed with the diamond set.

The frieze is 0,36 m width and the fullest length of one element is not known at this time.

(fig. 134)



Fig. 134 - *Style I*

- *Style J*

Style J is made of an equivalent decoration pattern as Style A, except that the basic stones elements are curved. In this way, the whole restitution presents a curvature and is somehow circular. In addition, are numbered twelve of each kind of curved EICH identified, disposed as follows. One line of full curved EICH in the middle, and on each border, half curved EICH lines. The setting is about 0,50 m height with a 1 m diameter.

- *Style K*

Style K is a layout of EC 1 panels, most likely a vertical one. As it has been seen, some of EC 1 panels can be re-cut and so, they can be integrated to this Style.

- *Style L*

Style L is identical to Style K, except that panels used are EM 1 ones. In the same way too, the EM 1 re-cut panels are integrated to the Style.

(Image of EM 1)

- *Style M*

Style M is a combination of several various tiles in order to form a frieze. The whole element contains a gold type metallic luster tile frieze, green half stars, blue cobalt crosses fragments and some rectangular glazed tiles. At this point of excavations, it is not possible to submit a restitution.

(fig. 135)



Fig. 135 -
Style M

- *Style N*

Style N is made of eight-pointed stars and complete crosses inlaid in mortar, and even half stars on borders. The reconstituted pattern has been possible through mortar elements remains. Unfortunately, no large architectural elements has been preserved enough to make a full restitution possible.

- *Style O*

Style O is a composition of rectangular and square carved stones. No dimensions are proposed here, since this layout is presumably for different purposes.

- *Style P*

Style P is totally equivalent to Style O, apart that the stones used are curved. Once again, no dimensions are given, however it can be reasonably supposed that curved stones are initially used for circular elements purposes (fig. 136).



Fig. 136 - Style O and P

- *Style Q*

Style Q is a kind of bandeau inlaid with complete eight-pointed green stars, each distant of about 0,05 m. The frieze is 0,08 m width and the architectural element total length is not still known.(fig. 137)



Fig. 137 -
Style Q

- *Wood and painted coating :*

Some of the retrieved elements have not been integrated to this classification, while it is obvious they participate to the Mosque overall decoration. The reason is that it has not been possible to sort them by different types. This is especially the case for the wood elements and painted coating fragments.

- The wood elements

The first category seems to belong to different architectural units, and can serve to two mains purposes which are strengthening masonry or building architecture, and the decoration. This last one purpose could also fit into the first as the border between both is thin.

(fig. 138)



*Fig. 138 -
Wood
element*

- Painted coating elements

Painted coating fragments are not significant at this point and further studies would be needed to give a serious result.

(fig. 139)



*Fig. 139 -
Painted
coating
element*

- The Graffiti :

This is also the instance for discovered graffiti on the Mosque walls, or on coated fragments. While it is not part of the initial decoration, it could even be categorized here as decorative elements belonging to the occupation phase.

(fig. 140)



Fig. 140 - Graffiti

Even if these elements are remarkable, only a quick description and drawings have been realizable in time for this report. Many decorative elements are still uncovered at this point of excavations, and so the typology given here is not exhaustive.

4.2. Methodology

Once the general typology has been established, it was necessary to develop a specific study protocol. This later was conceived and designed in order to help considering some of the main issues regarding the Great Mosque B12, like the location and chronology of its architectural decorative elements, but also the restoration of the original elevation of the mosque. The methodology that was adopted requires a great accuracy of registration, which in turn slow down the work considerably. Nevertheless, this precision is essential to provide an accurate restitution of the Great Mosque of Qalhât, a richly adorned monument of the end of the middle ages which seems to have been unique and therefore deserve plainly such a precise excavation and registration process.

The study protocol is composed of four stages. The first phase is the collect and description of items directly in excavation field. Then the second step is decorations inventory. After those recording part of the protocol, the study on the interpretation of data. The interpretation divides into two parts, on the one hand the spatial distribution, on the other hand the restitution. Various tools and methodologies have been created to facilitate and optimize the work.

In the first place, on the field an excavation methodology has been applied so that the maximum amount of data is collected. Therefore the excavation

map is divided in equal sectors. The location B was too long so it was cut in six sections. B1 is the the section the most southern. After the collapse UF were arbitrarily excavated over a height of 0.50 m. During the excavation, all elements of decoration were collected without sorting (fig. 141).

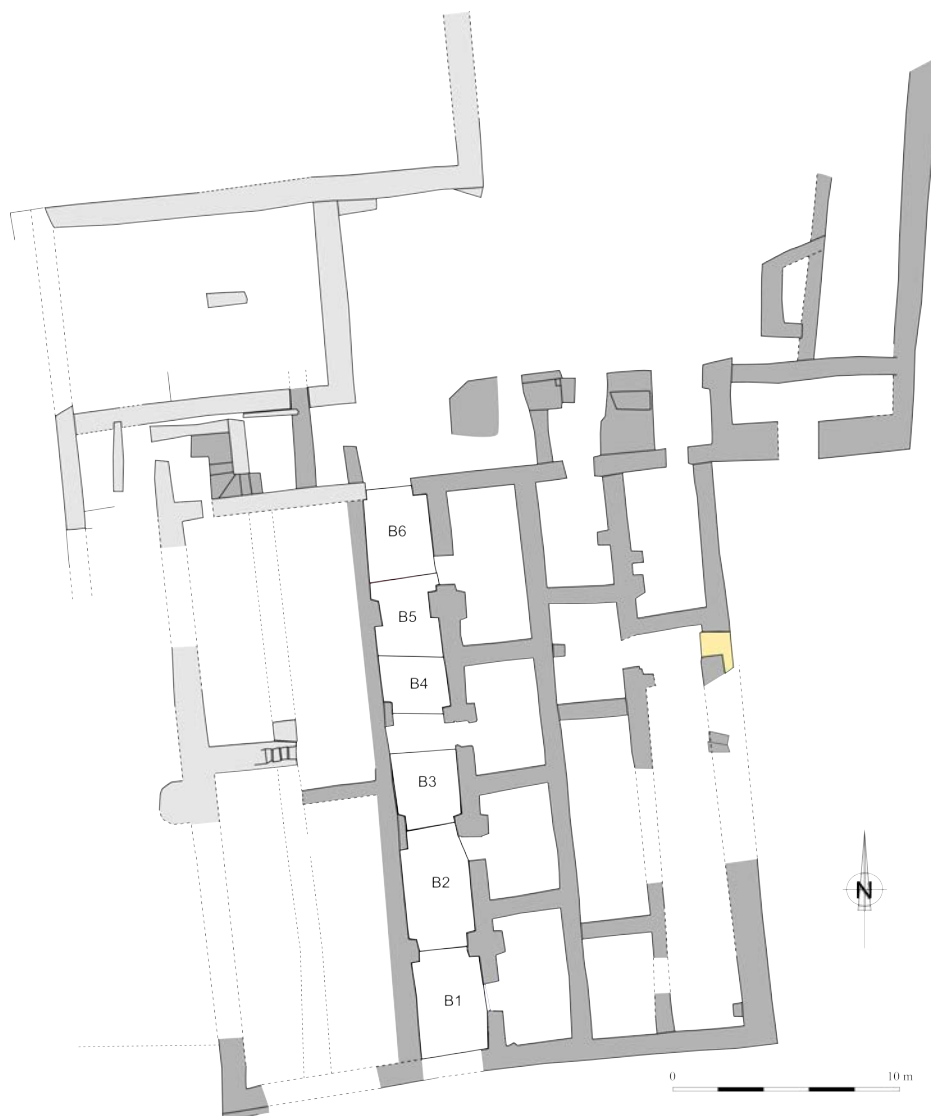

Fig. 141 - zoning of room B

4.2.1. Recording and Counting :

- The recording

Different registration methodologies were designed according to the element found. If the decorations elements are still integrated into an identifiable masonry, they are isolated. Then the masonry receives an "ISO ARC" registration number while the decorations receives a number of "ISO DEC". For those "ISO DEC " a specific recording form associated with a database has been established. The database was made on the software FileMaker Pro 12 and it has 435 entries.

The recording form and the database have the same page layout. The identification and location information are at the top of the form. A specific area is left for sketches and description .

A color code is applied for sketches: green is for green glazed tiles; deep blue is for blue cobalt glazed tiles; turquoise is for turquoise glazed tiles; yellow is for metallic lustre tiles; brown is for undetermined glazed tiles; pink is for prints and orange is for stones.

The remainder of the form is used for a detailed counting of the elements.

- The count:

The methodology used for the typology allows for counting on several plans by breaking down the different levels of it. As a style consists of basic elements and composite elements that in turn composed of basic elements, each of these categories could be counted. For example, “ISO DEC 031” associated with “ISO ARC 134” is Style J. The Style J comprises EICH and EC2 which is made with fragments of glazed tiles. Therefore counting is done from Style to fragment of glazed tile for each “ISO DEC”.

Counting Styles is based on a decomposition of the architectural element in several faces. Each face can have a different style. For example, “ISO DEC 034” associated with “ISO ARC 130” has three faces. But each face is different. The face one is Style G whereas the face two is Style F, and the face three is Style C. Therefore there are in the counting one Style G, one Style F and one Style C. On the opposite, an « ISO ARC » can have several faces, but only one style. It is the case for the association of « ISO DEC 042 » and « ISO ARC 325 ». This combination includes seven faces, each of them adorned with the same pattern. Consequently, only one style L is counted.

For the composite elements "EC" the counting is based on the number of pieces of panels that can be individualized for each ISO, whether the panel is complete or not. For instance, in the combination of « ISO DEC 025 » with 'ISO ARC 196 », three EC are accounted even though no complete panels are known yet.

Mortar Elements follow the same logic counting as for the “EC”. For example in the “ISO DEC 042” associated with “ISO ARC 325”, ten “EM 1” are accounted however only two panels are full.

The basics elements are stones elements and glazed tiles elements. In the state of progress of the protocol, the count of the stones elements is not directly associated with a style. Conversely, the counting of a glazed tile element is decomposed by its print in the masonry, its state of conservation and its different colors but also by its inclusion within a style or a “EC” or not. For each element, the check box "Total" must be completed and its possible use.

Here is the list of optional assignments of the elements :

-A complete star can belong to a Style B, D or E, I, N, Q.

-A half star can belong to a Style B, D or E, I, N.

-A star quarter can belong to a Style D, a EC 3, a EC 4

-A fragment of star can belong to a EC 1, a EC 2, a EC 3, a EC 4 , EC 6, EC 7, EC 8 and Style D. Only the Style D is reported because the fragments are re-cut in a specific way.

- A cross can belong to a Style C or D, F, I, N.
 - A half cross can belong to a Style D or N.
 - A cross quarter can belong to a Style D.
 - A fragment of cross has the same repartition that a fragment of star.
 - An undetermined fragment can be into all EC and into Style D.
- (fig. 142)



Fig. 142 - Counting of tiles elements

The complete star, half star and star quarter made with the technique of metallic lustre are not integrated into a style or an “EC”. Nevertheless, complete metallic lustre tiles can belong to the Style M. Moreover, fragments of metallic lustre stars, fragment of metallic lustre tiles and undetermined fragments can be used into a EC 5 or A EC 6.

The fragments of blue and white can belong to Style H or EC 5. The fragments of lajvardina, fragments of turquoise rectangular moulded tile with an inscription, and fragments of dark lustre fritware are just counted without attribution.

The approximate surface of some type of decorative elements can be given by a precise counting of the fragments of tiles used in it. For the EC 2, it is useful to count the triangular fragments, both the little and the big ones. For the EC 3, the restitution of the approximate surface meag will be provided by the counting of the hexagons, whereas for the EC 5 and 6, circular and semicircular fragments of metallic used should be used. Finally, EC 7 is characterized by circular and semicircular fragments of green tiles.

The non-figurative graffiti and figurative graffiti are also accounted in

the recording form.

All the elements of decoration that are not "ISO DEC" are inventoried in another recording form within the database "recording material form". This work is not carried out directly on the ground but on the post-excavation time. The recording form is the same model as the "ISO DEC" one but includes four more entries (metal decoration, glass, wood decoration and painted decor). This part of the recording requires greater interpretation of the glazed tiles elements in comparison of "ISO DEC". Two counting are made. The first one gives the total number of basic elements while the second one gives the probable characterization which can be multiple. For example, in UF 3124 there are six green undetermined fragments. However, there is 33% probable elements from an EC1, 33% probable elements from an EC2, 16% elements from a EC4 and 50% probably undetermined. Consequently the context of UF can help determining which is the EC those fragments most probably belong to.

The final database is the addition of data from sheets "ISO DEC" and data from sheets "recording material form". Furthermore, to complete the registration all "EC" and "EM" were photographed by UF and in detail.

- Surface and Length of the Decoration :

As it has already been stated, one of the main objective of this accurate study of these remains of decoration is to picture the original layout of the mosque. For this, it is necessary to have an idea of the original surface of the different types of decoration, or the length of such or such pattern. To do so, several tools were created with the software Libreoffice Calc.

There are two approaches to calculate the length or the surface. The simplest is to measure directly the remains. For the EC 3, EC 4, EC 8, EM 1, EM 2, EM 4, EM 12 the surface is measured from the photography of elements through the "measurement path" of inkscape software. For automating the calculation in the whole UF, an application was created "Model_calcul_Surface". Its aim is to have the factual surface directly. Here are the associated calculation :

$$\text{Factual_Surface} = \text{Inkscape_Surface} / ((\text{Inkscape_scale} / \text{Factual_scale}) * (\text{Inkscape_scale} / \text{Factual_scale}))$$

The second approach is to find the basic module constituting the element and choose the most significant accounting elements. Each element requires a different calculation. For automating the calculation of data from the final database in the whole UF, an application was created "Model_EC_and_Style_Surface". Here are the associated calculation for each specific element:

- EM 1

The surface of a complete panel EM 1 is 1296 cm².

$$\text{Minimum_Number_elements_EM1} = \text{Factual_area_EM1} / 1296$$

- EC1

There are sixteen tiles in a panel and the surface of a complete panel is 1296 cm².

$$\text{Minimum_Number_elements_EC1} = \text{Number_Tiles_EC1}/16$$

$$\text{Surface_EC 1} = (\text{Ratio_EC1}) * 1296$$

- EC 2

In a EC2, there are four triangular fragment.

$$\text{Minimum_Number_elements_EC2} = \text{Number_Triangular_Tiles_EC2}/4$$

- EC 3

Work in progress

- EC 4

Work in progress

- EC 5 and EC 6

In a complete panel of EC 5 and EC 6, there is two circular and six semicircular fragments of metallic lustre. Furthermore, the surface of a complete panel EC 5 and EC 6 is 1290 cm². The largest ratio allows to choose the best restorable surface.

$$\text{Ratio_EC5_EC6} = \text{Number_circular_Tiles_EC5_EC6}/2$$

$$\text{Ratio_EC5_EC6} = \text{Number_semicircular_Tiles_EC5_EC6}/6$$

$$\text{Surface_EC5_EC6} = (\text{Ratio_EC5_EC6}) * 1290$$

- EC 7

In a complete panel of EC 7, there are two circular and six semicircular fragments of metallic lustre. Furthermore, the surface of a complete panel EC 5 and EC 6 is 954 cm². The largest ratio allows to choose the best restorable surface.

$$\text{Ratio_EC7} = \text{Number_circular_Tiles_EC7}/2$$

$$\text{Ratio_EC7} = \text{Number_semicircular_Tiles_EC7}/6$$

$$\text{Surface_EC7} = (\text{Ratio_EC7}) * 954$$

- Style A

In a full style A pillar, There are thirty six EICH. It is possible to give the factual percentage of covered surface for the Style A on a pillar. However by adding the loose EICH by UF, it is possible to obtain a potential surface.

$$\text{Factual_Surface_Style A} = (\text{Number_EICH_ISODEC_Style A}/36) * 100$$

$$\text{Potential_Surface_Style A} = (\text{Number_EICH_Style A}/36) * 100$$

- Style B

In the basic module of Style B, there are one quatrefoil and two 1/2 quatrefoil. The module length is 0,35 m. The largest ratio allows to choose the best restorable length.

$$\begin{aligned} \text{Ratio_Quatrefoil_StyleB} &= \text{Number_Quatrefoil_Style B}/1 \\ \text{Ratio_1/2_Quatrefoil_StyleB} &= \text{Number_1/2_Quatrefoil_Style B}/2 \\ \text{Length_StyleB} &= (\text{Ratio_Style B}) * 0,35 \end{aligned}$$

- Style C

In the basic module of Style C, there are four cross. The module length is 0,36 m.

$$\begin{aligned} \text{Ratio_Cross_StyleC} &= \text{Number_Cross_StyleC}/4 \\ \text{Length_StyleC} &= (\text{Ratio_Style B}) * 0,36 \end{aligned}$$

- Style D

The D style is more complex. It can be a frieze or a panel. For the frieze, the restorable length varies by item. For a green cross, the minimum restorable length is 0,36 m. For a blue cobalt cross, the minimum restorable length is 0,36 m. For a star, the minimum restorable length is 0,18 m. For a 1/2 star, the minimum restorable length is 0,085 m. For a 1/2 cross, the minimum restorable length is 0,085 m.

$$\begin{aligned} \text{Length_StyleD} &= \text{Number_Green_Cross_Style D} * 0,36 \\ \text{Length_StyleD} &= \text{Number_Blue_Cobalt_Cross_Style D} * 0,36 \\ \text{Length_StyleD} &= \text{Number_Star_Style D} * 0,18 \\ \text{Length_StyleD} &= (\text{Number_1/2_Star_Style D} * 0,17) / 2 \\ \text{Length_StyleD} &= (\text{Number_1/2_Cross_Style D} * 0,17) / 2 \end{aligned}$$

For the panel, the area is calculated on Star number. A star surface is 324 cm².

$$\text{Surface_StyleD} = \text{Number_Star_Style D} * 324$$

- Style E

In the basic module of Style E, there are one star and one 1/2 star. The module length is 0,36 m.

$$\begin{aligned} \text{Length_StyleE} &= \text{Number_Star_StyleE} * 0,36 \\ \text{Length_StyleE} &= \text{Number_1/2_Star_Style E} * 0,36 \end{aligned}$$

- Style F

In the basic module of Style F, there are four crosses. The module surface is 1296 cm².

$$\text{Surface_StyleF} = (\text{Number_Cross_Style F} * 1296) / 4$$

- Style H

In the basic module of Style H, there are sixteen fragments of blue and white. The module surface is 1296 cm².

$$\text{Surface_StyleH} = (\text{Number_Cross_Style H} * 1296) / 16$$

- Style I

In the basic module of Style I, there are two crosses, two stars and two 1/2 stars. The module surface is 1944 cm². The largest ratio allows to choose the best restorable surface.

$$\text{Ratio_Cross_StyleI} = \text{Number_Cross_StyleI} / 2$$

$$\begin{aligned}\text{Ratio_Star_StyleI} &= \text{Number_Star_StyleI}/2 \\ \text{Ratio_1/2_Star_StyleI} &= \text{Number_1/2_Star_StyleI}/2 \\ \text{Surface_StyleI} &= (\text{Ratio_StyleI}) * 1944\end{aligned}$$

- Style J

In a full style J drum, There are twelve EICH. It is possible to give the factual percentage of covered surface for the Style J on a drum. However by adding the loose EICHs in UF, it is possible to obtain a potential surface.

$$\begin{aligned}\text{Factual_Surface_Style J} &= (\text{Number_EICH_ISODEC_Style J}/12) * 100 \\ \text{Potential_Surface_Style J} &= (\text{Number_EICH_Style J}/12) * 100\end{aligned}$$

- Style N

In the basic module of Style N, there are one cross and one star. The module surface is 625 cm². The largest ratio allows to choose the best restorable surface.

$$\begin{aligned}\text{Ratio_Cross_StyleN} &= \text{Number_Cross_StyleN}/1 \\ \text{Ratio_Star_StyleN} &= \text{Number_Star_StyleN}/1 \\ \text{Surface_StyleN} &= (\text{Ratio_StyleN}) * 625\end{aligned}$$

- Style Q

Work in progress

Data analysis on restitution of surfaces makes sense in a same sector and when grouping similar UF. The "Model_Location_Surface" file has been created to handle these data. The file compiles data from the "Model_calcul_Surface" file and the "Model_EC_and_Style_Surface" one, with a selection of the most pertinent data. The data taken in account are listed below:

- Minimum number of EC1 and EC2 elements.
- Surface of EC1, EC5, EC5, EC7.
- Factual, potential surface and total surface of EC 3 , EC 4 and EC 8.
- Surface of Style D, F, H and N.
- Surface of EM 1, EM 2, EM 4 and EM 12
- Length of Style B, C, D, E, I ,Q

4.2.2. Distribution

The study of the spatial distribution focused on the distribution of some parts of the original decoration of the Great Mosque : colors, metallic lustres, stone elements, basic elements, EM and EC.

The "Model_Distribution" file has been created to handle these data. As in "Model_Location_Surface" file, data analysis makes sense in same a sector and when grouping similar UF.

This file integrates all stones elements (quatrefoil, ½ quatrefoil, ¼ quatrefoil, fragment of quatrefoil, EICH, vertical 1/2 EICH, horizontal 1/2

EICH, ¼ EICH, fragment of EICH, curved EICH, curved vertical ½ EICH, curved horizontal ½ EICH, curved ¼ EICH, curved fragment of EICH, cut square, cut rectangular, curved cut square, curved cut rectangular) and the fragments of Fan Vault.

For glazed tiles elements, only the unfragmented elements are taken into account (complete stars, complete green stars, complete turquoise stars, half stars, green half stars, turquoise half stars, stars quarters, green stars quarters, turquoise stars quarters, complete crosses, complete green crosses, complete blue cobalt crosses, complete turquoise crosses, half crosses, green half crosses, blue cobalt half crosses, turquoise half crosses, crosses quarters, green crosses quarters, blue cobalt crosses quarters, turquoise crosses quarters).

There are also EM1, EM 2, EM 3, EM4, EM 5, EM 6, EM 7, EM 8, EM 9, EM 11, EM 12. There are the minimum number of EC1 elements, the minimum number of EC2 elements. However the file only integrates the number of fragments from EC 3, EC 4, EC 5, EC 6, EC 7, EC 8.

The study of the distribution of metallic lustres takes into account the total and unfragmented elements (metallic luster undetermined stars, metallic luster (gold type) stars, metallic luster (gold type) stars, metallic luster undetermined half stars, metallic luster (gold type) half stars, metallic lustre (gold type) with blue border half stars, metallic lustre (gold type) with blue border half stars, metallic luster (gold type) stars quarters, metallic lustre (gold type) with blue border stars quarters, complete metallic lustre undetermined tiles, complete metallic lustre (gold type) tiles, complete kashan lustre tiles fine type).

The study of the colors distribution takes into account the number of turquoise fragments from EC 1, the number of blue cobalt fragments from EC 1, the number of turquoise fragments from EC2, fragments of turquoise stars, fragments of turquoise crosses, turquoise undetermined fragments and fragments of blue cobalt.

4.3. Data

For all datas see vol.2, p. 75 to 81.

4.4. Data interpretation by location

By comparing the data regarding the location of the decorative elements and those concerning the restitution of their surface, it is possible to restore part of the original Mosque decoration, or at least to propose some hypothesis. Here are only the preliminary results of this work that will be completed with the complete excavation of the Great Mosque of Qalhât.

These results are first exposed for each area.

- *B12_A*

In this location, the choice was made to group every collapse UF (3003,

3015, 3043, 3048, 3058, 3064) since they seem to be equivalent or at least part of a same important phase of collapse.

Quatrefoils and half quatrefoils would belong to Styles B, C or F. However, the ratio between those elements leans toward Styles C and F, as there are more half than complete quatrefoils. In addition, the reconstituted surface of EC 3 combined to the half quatrefoils can lead to think of at least one Style G element. Conversely, the lack of complete glazed crosses tiles invalidates the hypothesis of Styles C and F.

The large amount of complete green stars and half stars could belong to Styles B, D, E, I, N and Q. But, because of the evident lack of crosses in that area, they most probably be part of Styles B, E and Q.

At least five reconstituted EC 1 panels are also located in this area. These panels probably indicate the presence of Style K, even if it is not possible to determinate how many elements of that type were represented.

With the methodical dismantling elaborated for Styles A and J pillars, it is possible to say that in this area, only 27,77 % of Style A were preserved, while no Style J have been found. The carved EICH founded separately gives a reconstituted pillar up to 33,33 %, which would represent the hypothetical conservation of the pillar when it collapsed.

This pillar contained at least 28,25 EC 2 with a number of 20 turquoise fragments, which could lead to think that different styles have been created with a color scheme on the pillars.

The association between EM 13 and quadrangular stones is also significant. Adding the retrieved fan vaults fragments, those elements seem to form an organized ensemble.

- B12_C

In order to apprehend in a better way the collapsed elements in B12_C location, the choice was made to group some UF together, as for other areas, according to their description.

The UF surface (3001) doesn't give significant results concerning retrieved elements apart from the existence of one single and full Style J. Five and a half EC 2 were discovered, which can be reasonably associated to the Style J in situ.

The first UF grouping (3025, 3027, 3029, 3032) gives several important results. First of all, as no blue cobalt crosses were found in that area, we can exclude the presence of style D in this part of the mosque. The amount of quatrefoils indicates the hypothetical presence of a Style B, which seems to be confirmed by the fact that few half quatrefoils were found. This even allows to eliminate other Styles like C, F and G. As for Style G, this conclusion is corroborated by the evident lack of EC 3 in this area. Besides crosses which could fit in Styles C or F, no relevant elements have been found to state on the presence of these styles in this location.

Considering the number of complete crosses, complete stars and half stars,

styles B, E, I and N are probably represented. While they have not been observed on the site as full and complete elements at this point of study, Style B, E or N, would be the most significant elements in a hypothetical restitution about the decoration in this location. This UF group also reports the presence of one Style A and Style J, which is in accordance with the nine and a quarter retrieved EC 2, under the methodical dismantling results.

The presence of almost three reconstituted EC 1 panels is also noted.

The second UF grouping (3055, 3059) main features are nearly identical to the first one. Indeed, the almost lack of half quatrefoils indicates the nonexistence of Styles C, F and G. However, the four quatrefoils could be representative of a Style B element presence. In the same way, the large amount of complete green glazed tiles such as stars, crosses and half stars, point out Styles B, E or N to be favored.

Seven and a half EC 2 have been found out in the collapse levels and added to the hypothetical 8,33 % of Style J element which is possible through the presence of EICH stone in these levels.

Once again, nearly three EC 1 panels have been uncovered in those UF.

The important thing to be noticed here, is the appearance of metallic lustre tiles fragments. Whereas they are not part of a composite element, they somehow would participate to the Mosque decoration in this location.

The last UF to be dealt with (3124, 3405), are quasi equivalent in the characteristics to the second UF group. Even if it is in a smaller amount, there still are some stars and crosses, which can be attributed to Style N. This idea is reinforced by the presence of carved rectangular stones.

Among the remarkable facts that have to be noticed for this location is the Style H element (only 81 cm sq. can be covered though) emergence.

- B12_B2

As for B12_A and B12_C, several UF have been gathered for more coherence.

The first UF group concerns 3016, 3033 and 3034 which could be interpreted as the final collapse levels.

The methodical dismantling executed in this area enabled to report 27,77% of a Style A and 83,33% of a Style J. Concerning this one, it is not only one but actually two architectural units that have been unearthed.

The sixteen and a half EC 2 found belong either to Style A or Style J. These EC 2 composed of some turquoise fragments, could be related to those discovered in B12_A, and thus could be part of a color scheme in the Mosque decoration. This would be one of the main researches concerning the decoration study in the following reports.

There is far less material in this area than in the previous described ones, but both shared what we could call the same schema. The proportion between complete stars, complete crosses and half stars is the same.

Combined with the total absence of blue cobalt crosses, this fact gives preferences to Style N.

In the same way, the proportion between quatrefoils and half quatrefoils could suggest the presence of a Style B element. This hypothesis is strengthened by the lack of EC 3 which eliminates Style G, or the small amount of crosses and half quatrefoils which excludes Style C and F.

As in B12_C location, at least two EC 1 panels have been reconstituted which could be associated to Style B. Some of these panels seem to contain turquoise tiles.

The second UF group comprises 3051 and 3098. Once again, the whole material amount is lower than in the previous area studied.

The important thing to notice is the appearance of some EC 3 (or EC 4, since the first studies do not permit to truly state on the belonging to one or the other) fragments in these levels.

In both UF grouping a large amount of quadrangular stones has been noticed.

- B12_B3

This place corresponds more or less to the middle of span B.

The first UF sorted are 3018, 3021, 3038, 3040 where a large quantity of decorative elements was found.

The quatrefoils and half quatrefoils report 11,08 m reconstituted length of a Style B element while only 0,72 cm have been discovered forming one architectural element. This result should be linked to the presence of basic elements as complete stars, crosses and half-stars. Indeed, those elements combined with half quatrefoils point out different styles. In this way, Styles C and F are not excluded, as for Style G which is also represented with almost one EC 3 reconstituted panel. At least seven EC 1 reconstituted panels were found which confirms also the existence of Style K. Because of the blue cobalt crosses absence, the Style D was probably not represented in this area.

New elements appear in these UF as the Style N elements. The given factual surface of these fragments is 0,35 m² although a reconstituted surface which is to attenuate (considering that every cross or star found in those levels does not belong to this only style), is about 1,81 m².

A large quantity of fan vaults fragments and some carved stones, associated to one EM 13 fragment have also been found.

Regarding the six and a quart EC 2 presents in this zone, they could reasonably be associated to one of the surrounding pillars.

The second UF group concerns 3080 and 3085. It actually coincides with the earliest collapse levels.

The main important remains reports a large amount of half stars (12) in comparison with complete stars (1). On the other hand, 14 green crosses

and 2 half crosses have been found. All the elements put together would argue in favor for a Style B or D element, if it were not the problem of the blue cobalt crosses absence. Thus, it would be more judicious to divide these elements between several styles.

Some specific datas are linked to this location. It is first, the appearance of identified EC 4 fragments which are reconstituted up to 377 cm², in addition with a possible EC 3 or EC 4 restored panel of 853 cm² size. Above all, this is the only place where elements of Style H have been found yet in such quantity. Almost one and half panel can be restituted.

- B12_B4

As for the other studied zones, the choice has been made to gather some UF.

The UF 3002, 3004, 3006, 3007 are actually corresponding to the final collapse levels.

The methodical dismantling report a presence of 50 % of a Style A element and 33,33 % of two architectural units of Style J (see ISO DEC 336 and 337). Scattered elements such as EICH stones found in these collapse levels allow to give a potential surface of 55,55 % and 50 % respectively. 34,5 restored EC 2 can be associated to those elements.

The presence of half and complete quatrefoils indicates a possibility of a Style B element with a minimal length of 1,04 m. But as some green crosses and EC 3 fragments combined to half quatrefoils have also been found, the existence of Styles C, F and G elements should also be considered. At least eight EC 1 reconstituted panels were uncovered, which enable to affirm the presence of Style K. Once again, the half stars are over-represented : they are 38 for only 11 complete ones.

To finish, the quadrangular stones, fan vaults fragments and EM 13 (at least 7 of it) associated set seems to be important in this area.

For the earliest collapse levels which consist of UF 3009, 3012 and 3030, the same main characteristics can be observed.

No EICH stone were found, but 7,5 EC 2 may belong to the collapsed architectural units located in the superior levels. As for the previous UF, several quadrangular stones were found. They are associated to one fan vault fragment and one EM 13.

The lack of quatrefoils leads to privilege Styles C, F and G. The presence of green crosses, EC 3 fragments and half quatrefoils strengthen this hypothesis. In addition, almost 8 EC 1 panels have been found and so Style K elements were most probably present in that part of the Great Mosque.

Once again, the proportion between half stars, stars and crosses is not coherent. Complete stars have almost disappeared while green half stars and green crosses are present in equal quantity.

- Distribution of some specific elements inside the Great Mosque : a preliminary study

If the distribution mapping of the different kind of decoration inside the Great Mosque is one of the main objective for the study of this unique monument, this work is not yet finished as the excavations is not terminated. Moreover, such a study requires a lot of time, much more than what was available this year. In the present state of study, only the fan-vault fragments distribution and the minimum number turquoise EC1 elements distribution has been analyzed.

In the mosque, there is eighty three fan vault fragments. 54 % are in the location B (three fragments in B5, seventeen fragments in B4 and twenty five fragments in B3). 23 % are in the location A. 20% are in the location C and 2% are in the location F. The largest concentration of fan vault fragments is in the location B center, in the location A and the location C. There is a small spreading in the location F and the location B5. (fig. 143)



*Fig. 143 -
Distribution of fan
vault*

In the present state of excavation, there are fifteen and a half panels with turquoise galzed tiles fragments. 81 % of pannels are in the north part of the mosque (29% in location I, 20,5% in the location B6, 19% in the location B5 and 12% in the location M). There is a small spreading in the location B2, location B3, location B4, location C, location F, location A.

(fig. 144)



*Fig. 144 -
Distribution of EC2
turquoise*

4.5. Synthesis

4.5.1. Decoration applied to the architecture

The detailed study of the decorative element from the Mosque has first permit to established a typology. Once this first step achieved, it is possible to propose some hypothesis as for the function of those elements. Naturally, this identification is essential for the restoration of the Mosque elevation.

Here is a brief summary of the results by decorative style. About the pillars, they have different sections according to their elevation : the base could be square whereas the top is octagonal. For this, different profiles do not necessary imply that the style belongs to different architectural element.

- Style A is applied on pillars; it would belong to each face of a square base of a pillar
- Style B would probably be the decorative face of an octagon pillar; probably on the top of the pillars
- Style C is the intrados of an arc
- Style D is a frieze or a panel; according to field observation, it would be applied on walls, cupola elements and pillars square bases
- Style E : restitution under study
- Style F is present as a spandrel of an arc
- Style G is a spandrel of an arc
- Style H : restitution under study
- Style I : restitution under study
- Style J is a column drum
- Style K would either be a spandrel of an arc, or the face of an octagon pillar (see Style B)
- Style L would either be applied on a wall as a frieze, or on an octagon pillar face
- Style M : restitution under study
- Style N is probably a sort of frieze or would be applied on a cupola, as it has been concluded from the material evidences
- Style O would either be a square base pillar, or the exterior coverage of a dome
- Style P is a column drum
- Style Q : restitution under study

Some mortar elements such as EM 1, EM 2 or even EM 12 for example, are missing in this list but as the excavations are still ongoing in B12, it is not possible at this time of study to give proper results on these elements.

4.5.2. Synthesis by location

These combined data and their interpretation allows to restore the collapsed architectural elements in their original location for B12_A, B12_C and B12_B2/3/4, and gives also a general idea about the state of conservation of those elements before their collapse.

In B12_A location, the dismantled pillar is from Style A (square shape base), which is logical since the pillar drums collapsed in the door between B12_A and B12_B, and were recorded in B12_B location.

Moreover, the reconstituted G and K styles allows the hypothesis of a collapsed arc in this area.

The fact that fan vaults elements, cut regular stones and EM 13 are equally spread all around this area could be a clue for the identification of these remains as part of a cupola that has collapse in this part of the Mosque. This could also explain the uncommon amount of half stars that would have been part of a decorative pattern specific of that cupola, maybe a Style D or E, but most probably a Style N decoration.

As no Styles C, F and G elements are documented in B12_C, it can be assumed that no arc ever collapse in this area. The Style B predominance indicates a potential octagonal pillar face presence, i. e. probably the upper part of a pillar.

In the same way, the existence of nearly six EC 1 panels (cumulative) added to the lack of arc presumption, could suggest that the EC 1 panels would also fit in an octagonal pillar face (see the above list). Thus, Style K could be used either for a spandrel, or a pillar face. Moreover, the presence of quadrangular stones added to fan vaults fragments and reconstituted Style N could also attest of a possible part of cupola collapsed in this area.

In the southern B12_B location, the propositions about decorative elements are not really significant considering the poor quantity of uncovered material. However, this lack is also significant. It gives some indications about the whole collapse process, and suggests that most of the cupola didn't collapse in this location.

In B12_B3 location, no architectural unit have been found. The hypothesis of a cupola in B12_B3 location is accredited by the lack of architectural units collapse. The only EC 2 elements found belong to Style A or J pillars which are located on the corners of this area. The presence of several different styles which could be interpreted as collapsed arcs, in addition with the large amount of fan vaults fragments reinforce this assumption.

In B12_B4 area, the large amount of half stars adding to the discovered crosses (which are not blue cobalt and so eliminate Style D), would suggest a Style N with half stars borders, since the overall surface of this Style is not currently known. This could explain the abundant half-stars which are more than two times numerous than crosses and stars.

What have not been determinate during the first study steps is the restitution and location of metallic lustre tiles. Although it has been observed that these particular tiles are located in the lowest UF through all these locations, which means in the earliest collapse levels, their function or decorative style can not be submitted at this point.

The material repartition maps permitted to provide important issues such as the glazed tiles color distribution or fan vaults fragments distribution. This one reinforced the hypothesis of a cupola located in B12_A, B12_C and B12_B 2/3/4 areas while the first map enabled to state that turquoise tiles were predominant in the northern Mosque locations.

Once again, the completion of this mapping of the collapse elements as well as their restitution inside the original elevation would be one of the priority for the next excavation campaign of the Mosque.

4.6. Conclusion

The given results proposed in this report are partial and submit only a few of the possible developments concerning the decorations study.

The choice has been made to focus on specific locations just to show how profitable such a detailed study could be. Even if the methodology of excavation as well as the study protocol both require a lot of time and then slow down the excavation process, they provide essential clues for the global restitution of the mosque. According to the preliminary results, this monument was absolutely unique, with no comparison known until now. It is then necessary to continue the excavation of this monument following the same methodology during the next campaign. In this way, and in accordance with the architectural researches, not only the overall restitution of B12 would be possible but also the restitution of the global collapse which occurred in the Mosque.

5. The architectonic elements : description and location

The chosen nomenclature for the architectural elements is IsoArc (Iso for isolate and Arc for architectural). All the elements discovered during the



Fig. 145 - Location of all IsoArc

excavation received a number of registration IsoArc 1 to n and are localized on the general plan of the mosque (fig. 145).

The analysis of pillars and arches elements provide decisive informations about the morphology of the upper part, roof and cupola.

5.1. Pillars

Four different kinds of pillar could be determined during the analysis of

architectural elements (central, lateral, engaged and octagonal). In relation with the localization of the element and the determination of the kind of construction, it's possible to reconstitute a part of the architecture according to six specific areas (north, lateral north, central, lateral south, south and east) (fig. 146). The central columns are in the central area, the lateral columns are in the lateral north and south areas, the engaged columns are in the north and south areas and the octagonal pillars are in the east area.

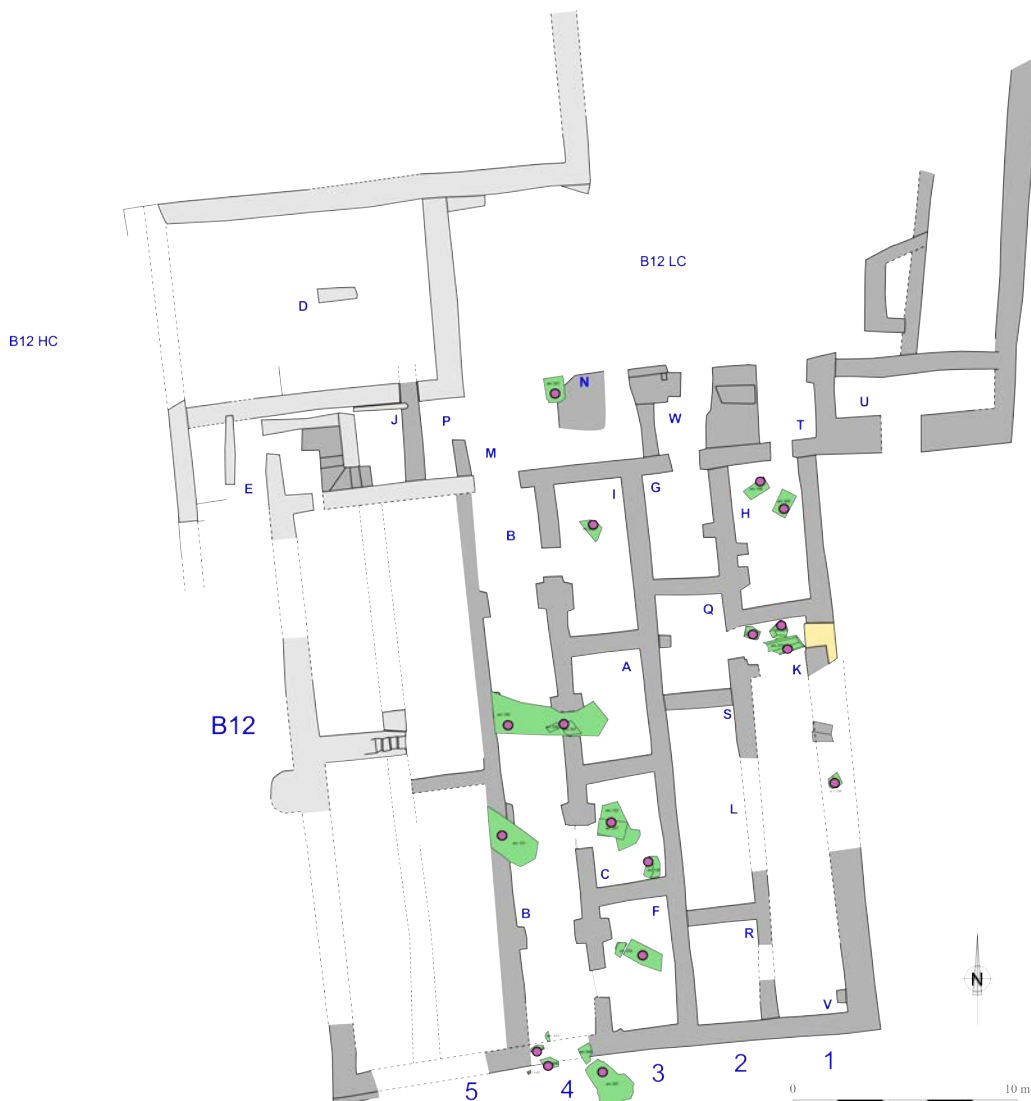

Fig. 146 - Location of pillars elements

The central, lateral and engaged columns are all constituted by two circular or semi-circular drums built upon on a square or half-square base. Between those part a wood ring was observed. The analysis of the octagonal pillars is still in progress so their constitution is not yet as precise as for the others.

5.1.1. Central columns

Seven IsoArc, discovered in the central area of the mosque (fig. 146), enable to propose a restitution of four columns.

- IsoArc 100

The excavation of this element is not complete. For now, only a square base located in room B has been unearthed. It is in the same east/west line than the Minbar and leaned on the wall B12-046. Others parts of this element have collapsed further west at the level of the prayer hall, which will excavate during the next season (fig. 147).

The remaining part is l: 1,05, w: 0,68, h: 1,10, but the global restitution of the base give all measurement to 1,10 m. Originally it was most probably a

Fig. 147 - IsoArc 100



*Fig. 148 -
Technical drawing
of IsoArc 100 (V.
Bernard)*

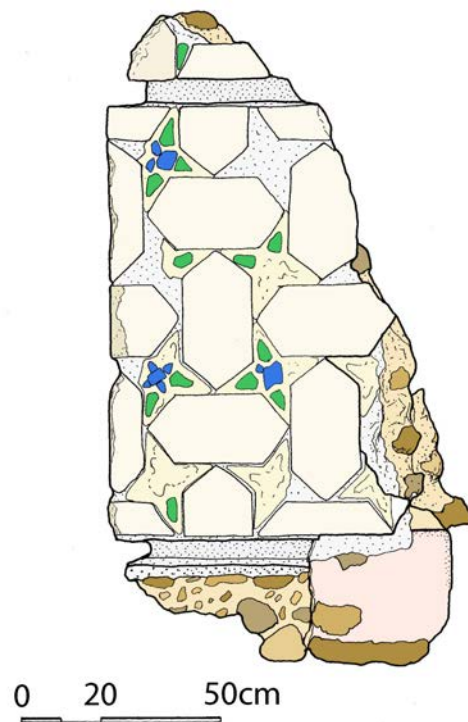

cube measuring 1,1 m on either side. The masonry is made of corals bounded with a gray/beige mortar. The four sides of the base are constituted of the same style A decoration (see above). Also, the precise observation of the base reveal a system of assembly between the floor and the column. It consist in an extension of the column masonry core, under the base and reachinf the top of the buttress (at the level of the basement) (fig. 148). The floor come after to surround this extension and in this way strengthen the position of the column.

- *IsoArc 131*

The excavation of this element is not complete. It is a square base located in room B, 3,70 m south from IsoArc 100, and leaned on the wall B12-046. The rest of this element is collapsed at the level of the prayer hall not yet excavated. The analysis, still in progress, shows the shaft of the column was composed of two drums. Located in the same line as these drums, the IsoArc 501 (see below) seems to be part of the arch once supported by the column.

Like for IsoArc 100, the base was probably a cube of 1,10m on either side. The masonry is made with corals bounded with a grey/beige mortar. The four sides of the base are adorned with a style A decoration (see above). The drums, discovered at the level of the prayer hall, are in a very poor state of conservation. It was very difficult to clearly distinguished their limits. Only the side collapsed against the floor is conserved (d: 1,10m, h: 0,52m). The decoration is style J (see above). The same system of assembly than the one describe for IsoArc 100 have been observed.

- *IsoArc 336 and 337*

Both are located in room B and just next to the door between room B and room A. The way these two elements collapsed as well as their proximity



Fig. 149 - IsoArc 336 and 337

leads to think that they were probably part of a same shaft. IsoArc 336 (d: 1,10m, h: 0.53m) and IsoArc 337 (d: 1,10m, h: 0,30m conserved) are built with coral bounded with gray/beige mortar and they are covered with a style J decoration (fig. 149).

- IsoArc 133, 207 and 134

Discovered in room A, IsoArc 133 was in a very poor state of conservation. Nevertheless, the general shape seems to be square, even if the dimensions are too uncertain to be mentioned here. IsoArc 133 is just under IsoArc 207: it is probably part of the same architectural element



Fig. 150 - IsoArc 133

(fig. 150).

IsoArc 207, also in room A and just under IsoArc 133, presents a general square shape but only one side is preserved (l: 1,35m, w: 1m conserved). It has a style A decoration. IsoArc 207 corresponds probably to a base. It should be noticed that to the bottom of this element, a fragment of floor is still attached (w: 0,25m).

IsoArc 134, discovered in the south-west of the room A, has a round shape (d: 1,10m, h: 0,50m) with style J decoration. It can be a column drum whereas IsoArc 133/207 would belong to the base of the same support. The others elements like the second drum or the capital are unfortunately completely destroyed.

5.1.2. Lateral columns

Two IsoArc, discovered in the lateral north and lateral south areas of the mosque (fig. 146), enable to propose a restitution of two columns.

- IsoArc 333

Located in the lateral south area, room F, IsoArc 333 belong to an almost

complete column. Three parts were identified: the base and two drums, all in connection. The base has a square shape (l: 0,94 m, h: 085 m, w: 0,84

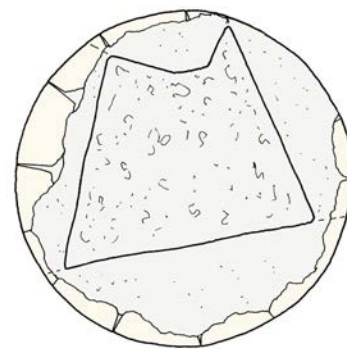
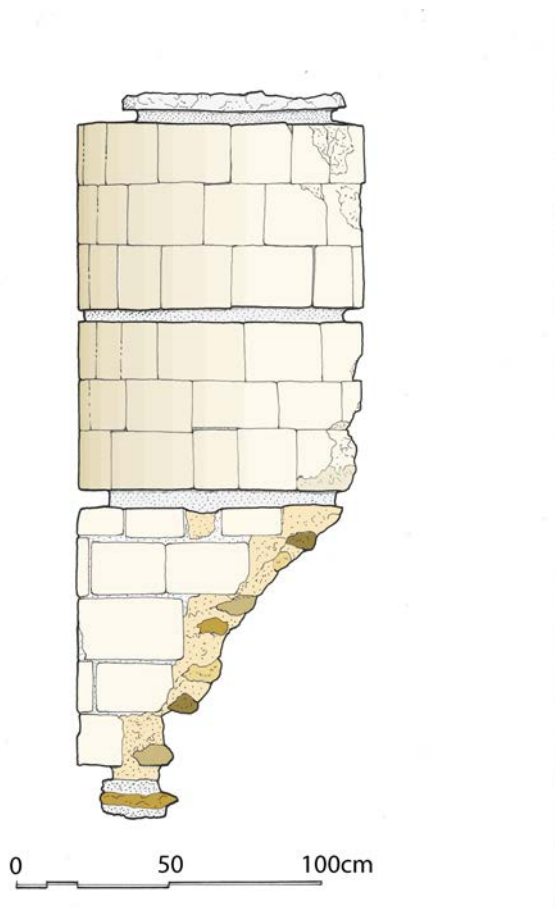

0 20cm ARC 333

Fig. 151 - IsoArc 333 (zenithal view)

Fig. 152 - Technical drawing of IsoArc 333 (front view) (V. Bernard)

Fig. 153 - Technical drawing of IsoArc 333 (upper view) (V. Bernard)

m), which is different from the one of the column from the central area. The base is not a cube, as the length is more important than the width and the height. The decoration of the base is style O. The drums (both d: 0,85, h: 0,53 m) have a style P decoration. Between each drum, a small recess was originally filled by a piece of wood now completely destroyed. The analysis of the higher drum provide more information about the way the pieces of wood were inserted in the masonry. Here, the core of the drum is



Fig. 154 - IsoArc 314

made of coral blocks bounded in mortar and four pieces of wood were fixed around this central insertion of the wood in the masonry. It shows a heart of the drum constituted of corals and gray mortar encircled with four pieces of wood. They were cut to form a circular feature, whereas the wooden structure was square between the base and the first drum (fig. 151, 152 § 153).

- IsoArc 314

Located in the middle of room I, IsoArc 314 has a round shape. It is composed of two drums belonging to the same shaft. The first drum (d: 0,70m; h: 0,53m) seems to be complete but the second is in very poor state of conservation (d: 0,70m; h: 40m). A space (h: 0,045m) is located between the two drums. As for IsoArc 333, it originally accomodate a wood ring (fig. 154).

5.1.3. Engaged columns

Some engaged columns are located on the north and south areas.

- IsoArc 331

Located in room M (i.e outside the mosque) IsoArc 331 have a half-round shape (d: 0,80 m; h: 1,20 m). This element is constituted by two drums

separated by a wood ring. The drums have a style P decoration (fig. 155).



Fig. 155 - IsoArc 331

- IsoArc 382

Located in room M, IsoArc 331 have a half-octagonal shape. It belong to the upper part of the shaft of an engaged column and present a style K decoration (fig. 156).

These two architectural elements (IsoArc 331 and 382) are part of the same column. They probably come from the north wall of the mosque and



Fig. 156 - IsoArc 382



Fig. 157 - *IsoArc 327*

according to their position were certainly outside the prayer hall. They are probably remains of a porch located in front of the entrance to the prayer hall.

- IsoArc 327

Found to the external South of the mosque following up room B, this element is made of three different parts, a half-square base (l: 0,90m; w: 0,50m; h: 1m) with style O decoration and two semi-circular drums (d: 0,90; h: 0,50m) with a style P decoration. Wood elements were also used in the general layout (fig. 157).

- IsoArc 346

Also located outside the mosque and following up IsoArc 327 to the north, this element have a half-octogonal shape (l: 3x0,40m and 2x0,18m; w: 0,60m; h: 1,10m). It is adorned with a a style L decoration. IsoArc 346 is the third part of the shaft and the presence of wood piece found between IsoArc 346 and IsoArc 327 bring to mind that the bond between them was a wood ring.

According to the location of these elements, the support, they are belonging to was probably inside the prayer hall.

- IsoArc 440, 446 and 343

IsoArc 440 is located outside the south area. It is composed by only three carved stones but seem to form an angle. It has not been removed yet and the decorated face is not clearly visible. Nevertheless, it is possible to observe a half-square shape and thus conclude that it part of a base. At the bottom of IsoArc 446, a fragment of floor is still attached which prove that it came from the inside of the mosque. IsoArc 440 and IsoArc 446 are two parts of the same element with style O decoration.

IsoArc 343 is in a very poor state of conservation but it's possible to identify a drum with round shape and style P decoration.

Finally three engaged columns have been found during the excavation, one in the north and two in the south, that are all lined up with span 3. These columns are all constituted by an half-square shape base with style O decoration, two half-round shape drums, with sytle P decoration, sit on the top of the base and separate by a wood ring to create the first part of the shaft. The second part of the shaft is a half-octagonal shape construction with Style K, O and EM1 observed for the engaged column of the north area, and style L for the engaged column of the south area.

5.1.4. Octagonal pillar

- IsoArc 126, 127, 199, 200, 278, 279, 280, 286, 305 and 306

Ten fragments of octagonal columns were all discovered in room H and K (fig. 158).



Fig. 158 - General view of room H with fragmennts of octagonal pillars

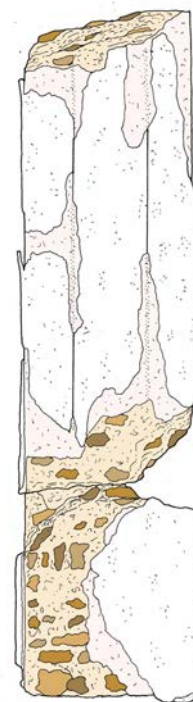

Fig. 159 - Technical drawing of IsoArc 279 and 281 (V. Bernard)

0 20 50cm
ARC 279 & 281

The base is square, of 0,75x0,75m, for 0,82m of height, the upper part is octagonal, 0,72m of maximum width, and apparently the summit is flat. (IsoArc 127). The maximum preserved length is 2,85m. (fig. 159)

Only one piece of column shows a light decoration. It consists of vertical bands situated in the edges, in the octagonal part of the column. This could be a simple decoration, or it could be a guide to set ornamented stucco plaque. In this case, one might conclude that these elements were still under process when the mosque was destroyed.

5.2. Arches



Fig. 160 - Location of arches elements

For this study only the structures which are support of the roof or the cupola are include in this chapter (fig.160). The other arches are determined like door or window (see below).

During the excavation three kinds of element were identified : the spandrels, the intrados and the extrados.

Most of the time these elements are in association with a specific type of pillar. So the description will be made following the position of the pillars.

5.2.1. Central columns

- IsoArc 196

IsoArc 196 was localized in the middle of room B. This element has an



*Fig. 161 -
IsoArc 196*

octagonal shape and correspond to the element just above the capital of the column, that is the departure of arches. There could be observed a spandrel with a style K decoration and the part located between two arches which has a style B decoration (fig. 161). This element is probably to be linked with IsoArc 129, 130, 208 and 210.

- IsoArc 130



Fig. 162 - IsoArc 130

This element is located in the middle of the room B, just under IsoArc 196. Three faces were observed. The first is a spandrel with EC3 decoration, the second is an intrados with style C decoration and the third is the second face of the spandrel with style F decoration (fig. 162). This element is a fragment of arch probably to be linked with IsoArc 196.

- IsoArc 129

This element is in a very poor state of conservation. But as it has been found just under IsoArc 196, it correspond probably to a spandrel. The style of decoration is not identifiable.

- IsoArc 208

Like IsoArc 196, it correspond to the part located just above the capital of the column. The only face visible is the part between two departures of arch wich has a style B decoration.

- IsoArc 210

This element is a fragment of a spandrel with EC3 decoration and it is probably a part of IsoArc 130 (fig. 163).



Fig. 163 - IsoArc 210

- IsoArc 501

The element have been found at the level of the prayer hall near the column IsoArc 131. It correspond to the same kind of element than IsoArc 196 or IsoArc 208, i.e. the part between two departures of arch. In spite of the poor state of conservation, the decoration is identified as style B.

5.2.2. Lateral columns

At this stage of excavation no arch were found in association with the transitional columns.

5.2.3. Engaged columns

- IsoArc 326

This element is located in the southern part of room B. Its poor state of conservation make the interpretation quite difficult. However the curve let think that this element is an arch and the decoration observed is identified like style L, but without certainty.

- IsoArc 344

Found in the south of room B and not entirely cleared, this element shows a departure of arch with style L decoration. It could be associated to the engaged column leaning on the south wall of the prayer room.

- IsoArc 335

Also found in the south of room B this element is a departure of arch with style L decoration. It could be associated with IsoArc 325, 346 and 327 (fig. 164).



Fig. 164 - IsoArc 335

- IsoArc 345

Also found in the south of room B this element is a departure of arch with style L decoration. It could be associated with IsoArc 343, 344 and

probably 326.

- IsoArc 325

It is the same kind of element as IsoArc 344, 335 or 345. It correspond to a departure of arch with style L decoration and could be associated to one of the two engaged columns of the south wall of the mosque.

5.2.4. Octagonal pillars

At this stage of excavation no arch have been found in association with the octagonal pillars located in the first span of the mosque.

Some doubt regarding the identification of some elements remain, as for IsoArc 204, 432 and 513. Further excavation will certainly provide more information

5.3. Doors and windows

5.3.1. Doors in the inside partition wall

Among the many walls excavated, specific layout as door jambs, pilasters, threshold or decoration have been noticed (fig. 165).



Fig. 165 - Location of doors elements

- IsoArc 295

This element found in room I correspond to a section of a wall that was just above the basement wall B12-048 (fig. 166). This wall itself is 75cm width at the bottom and 60cm width for the upper part. It is made of stones



Fig. 166 - IsoArc 295

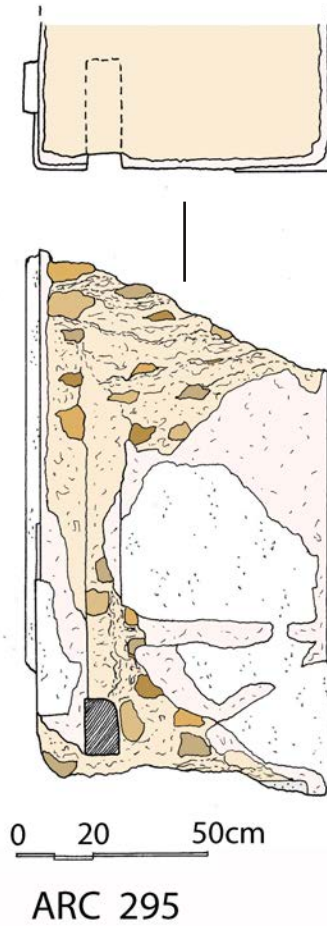

Fig. 167 - Technical drawing of IsoArc 295 (V. Bernard)

bounded with earthy mortar, and then coated with red solid mortar, with a final white plaster layer on surface. On the bottom of IsoArc 295, part of a door frame was observed. At the bottom could be noticed the cavity in

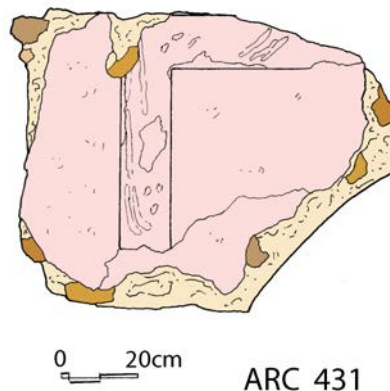

Fig. 168 - IsoArc 431 (V. Bernard)

which the wooden doorstep was fixed. In the upper part there is a print made by the door jamb (fig. 167). We can see also, horizontally, some wear mark, where the door bottom bars reinforcement was touching the wall.

- IsoArc 341, 431 and 378

These elements are fragments of wall originally located between two doors. The beginning of an arch could be observed in the IsoArc 341 (fig. 168).

- IsoArc 381, 384, 385 and 388

These elements are also fragments of a wall that originally take place between two doors as it is possible to identify two different jamb. Each door was topped by an arch. On the IsoArc 384, part of the upper door frame's print is preserved. Just above it, a cavity might have accommodated the part of the door frame (fig. 169 § 170).

Between the doors, there is a frieze of small moulded triangles in the upper part. Just below, a small recess is topped by some specific kind of horseshoe arch. Yet this motive is not complete, it looks like a Mihrab design. We could therefore suppose that a mihrab originally took place in this part of

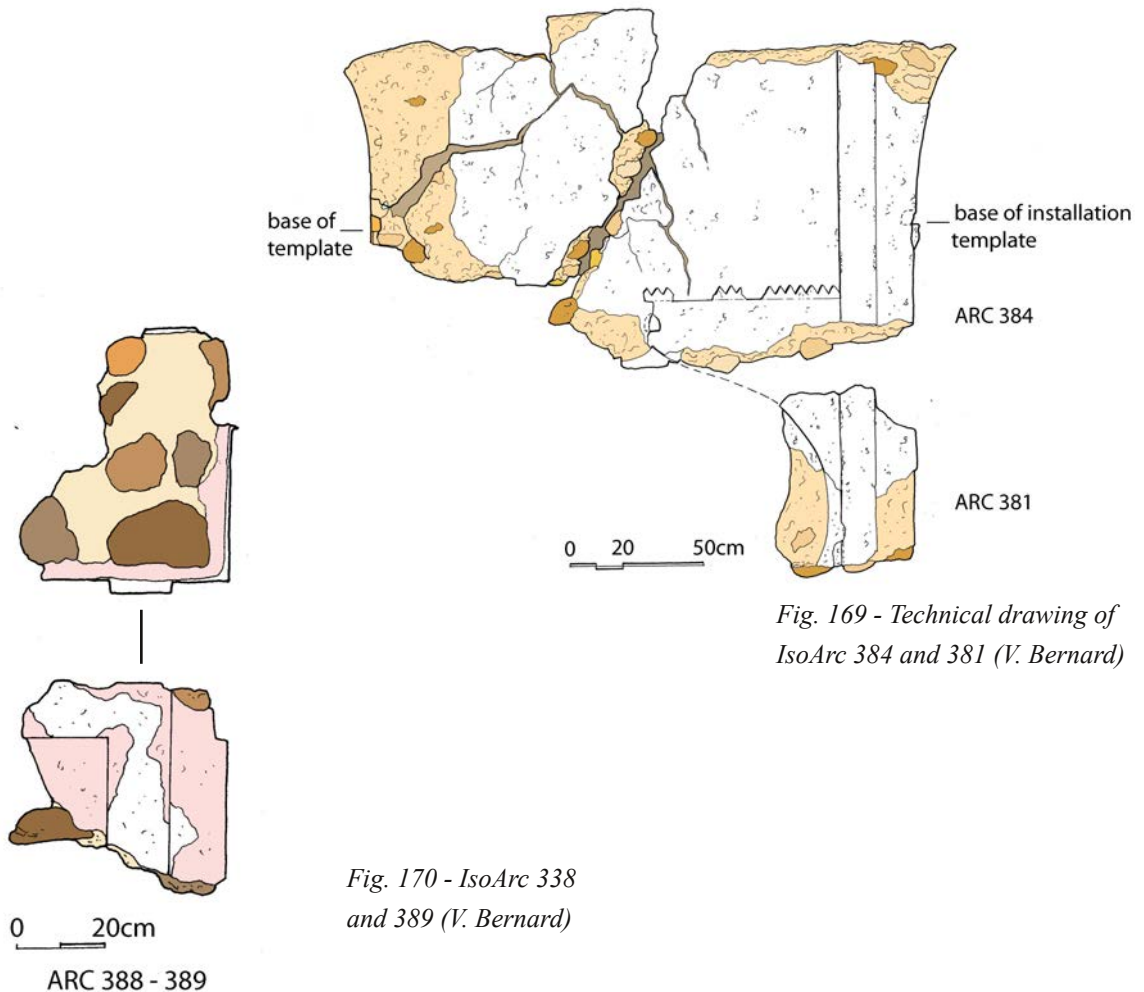

the mosque. It has to be noticed that it is quite usual to found mihrab on the outer wall, facing the courtyard, as a remind of qibla direction. By symetry, it is possible to restitute this central motive and so the width of this piece of wall : 1.98m. This decoration or mihrab was not found on IsoArc 295, meaning that there was certainly only one of them. The excavation of this area is still in progress, may be more decoration of mihrab will be found.

As we saw, not everything was excavated, so we miss some information: we still don't know the complete high of the wall of this part of the building. The kind of roofing is not clearly documented, even if structurally it is more convenient and usual to have a flat roof on the whole building to avoid problems with water draining, and to strengthened the lateral thrust produced by the arches on the west side, from the mosque itself.

According to the many clues of doors existence found among the pieces of the eastern dividing the prayer hall wall coming from the collapse, we can assume that at least four doors where opened in that wall, each of them connected with a specific nave.

As the work is still in progress in front of the central nave, it is not yet possible to guarantee the existence of a central door, even if this is highly probable.

5.3.2. Entrance

- IsoArc 290

This element, found in the northern part of room B, correspond probably to a door jamb (0,60m thickness). It is certainly part to the north entrance of the mosque.

- IsoArc 310

This arch is certainly the porch's gate. It is a round arch made of stone and solid red mortar exclusively,. Round arch avoid lateral thrust, the north-western angle of the porch not being counterweight.

- IsoArc 308

This is a fragment of an arch discovered in room K. It might belong to an access leading from the low courtyard to the basement. No decoration was observed.

5.3.3. Windows

- IsoArc 548

This is part of a window located in the southern wall of room R. It belong

to the south wall and has no specific decoration

- IsoArc 347

This element is located outside the mosque, south of room B. This piece of masonry is only 0,30 m large and preserved the print of frame. When it was removed, many prints of wood where observed. They draw some kind of cross shape pattern, and one might assume that a wooden claustra originally close that window.

- IsoArc 447

Also located outside the mosque, south of room B, this element correspond to an opening of the south wall of the mosque. In the upper face, covered with a coating, there is wood. Furthermore, on the thickness it can be seen the vertical projection of a slightly oblique groove, perhaps to accommodate a woodpiece.

- IsoArc 324

IsoArc 324 is part of the departure of the window arch found in the southern part of room B.

5.4. Cupolas

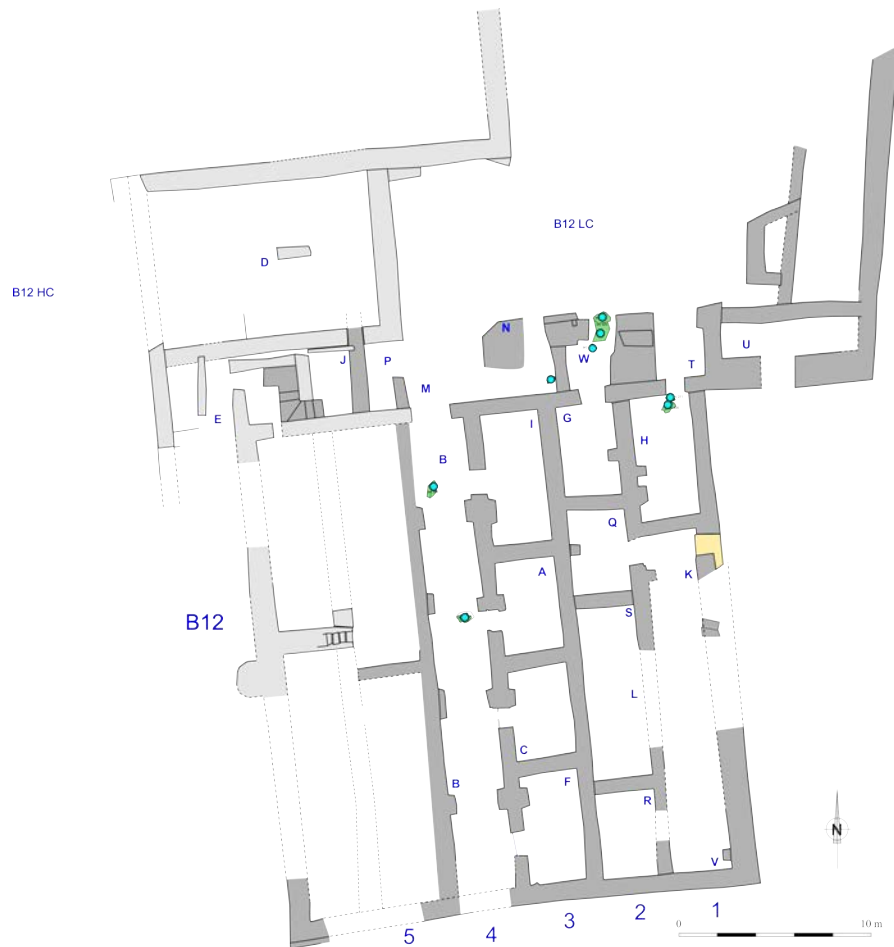

Fig. 171 - Location of the fragments of cupolas

Among the many architectural elements found in the collapse, part of them most probably belong to cupolas. Those remains are mostly located in two specific areas. Some of them among the so-called north wing, inside room W. The other ones around the center of the mosque, where those remains belong to a much more complex feature, probably a huge cupola built upon a drum.

- IsoArc 288 and 011

IsoArc 288 may be the central pillar of geminal bay located in the square part of the drum of the central cupola. Its width is 0,50m, like the wall. The stones are cuted in the internal and the external face (fig. 172).

IsoArc 011 is a concave element which correspond to a fragment of the base of the central cupola.

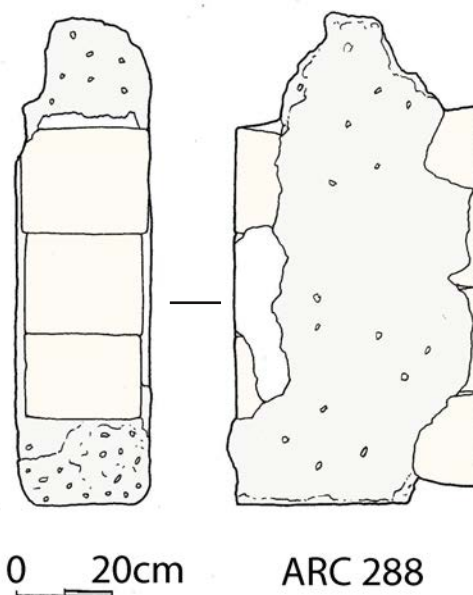

Fig. 172 - IsoArc 288
(V. Bernard)

- IsoArc 206, 211, 214, 425, 442, 443, 444 and 488

North of the mosque, the room W was most probably a porch covered by a cupola. This cupola has fall down on the porch's basement.

Many fragments have been found (fig. 173 to 179). They allow us to assure that this cupola was decorated by a frieze on the lower part, two other frieze showing the same pattern are runing from the bottom to the upper part of the cupola, and so dividing it in four equal parts (fig. 183).

The masonry is only 0,25 m in thick. It is made of stones bounded with a red mortar only used for the most solid elements. This masonry is covered with a thin layer of white plaster, on both its external and internal faces. The outer part is full of tool print made to maintain another surface layer (IsoArc 488). No evidence of it has been found. But maybe it is just to renew the white plaster cover. This cupola was attached on south with the northern wall of the mosque, on east to the minaret. (IsoArc 211) It diameter is 3.80m-4m. Just above, there was an octagonal porch, (IsoArc 214) with the gate on north leading to the upper northern terrace.



Fig. 173 - IsoArc 206

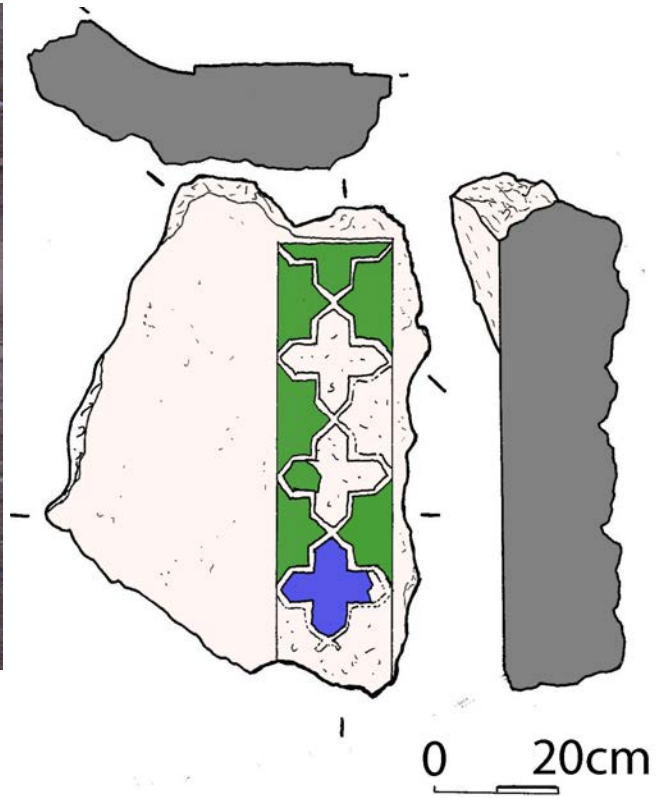

Fig. 174 - Technical drawing of IsoArc 206 (V. Bernard)



Fig. 175 - IsoArc 425

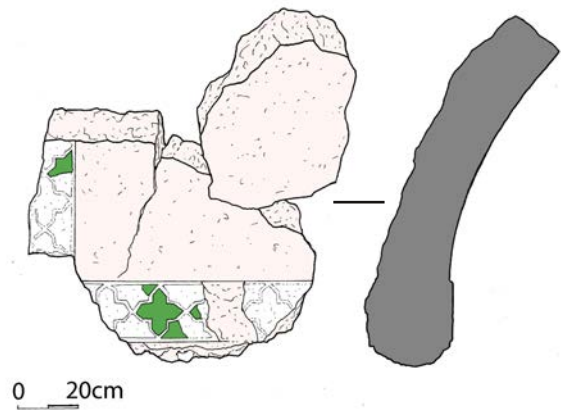

Fig. 176 - Technical drawing of a part of IsoArc 425 (V. Bernard)

Fig. 177 - Technical drawing of a part of IsoArc 425 (V. Bernard)



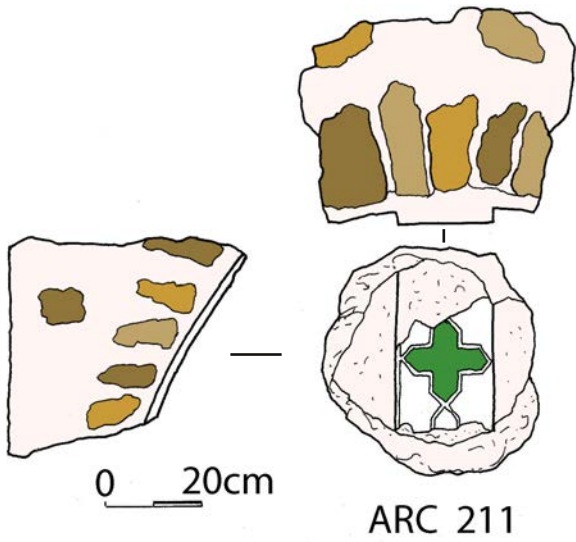

Fig. 178 - IsoArc 211 (V. Bernard)

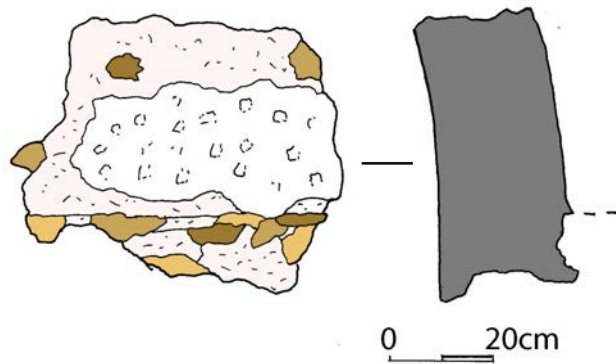

Fig. 179 - Technical drawing of a part of IsoArc 425 (V. Bernard)

5.5. Fan Vault

During excavation 73 fragments, and 10 probable fragments, of so-called fan-vault were found. They correspond to trapezoidal elements made of different plaster pieces fixed together and originally reinforced by reeds.

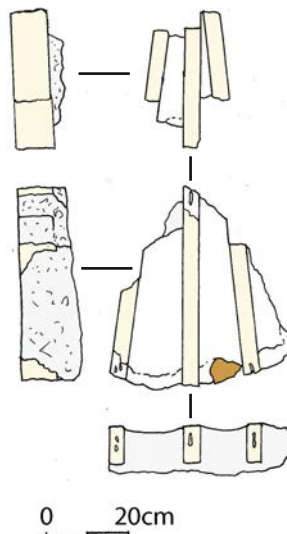
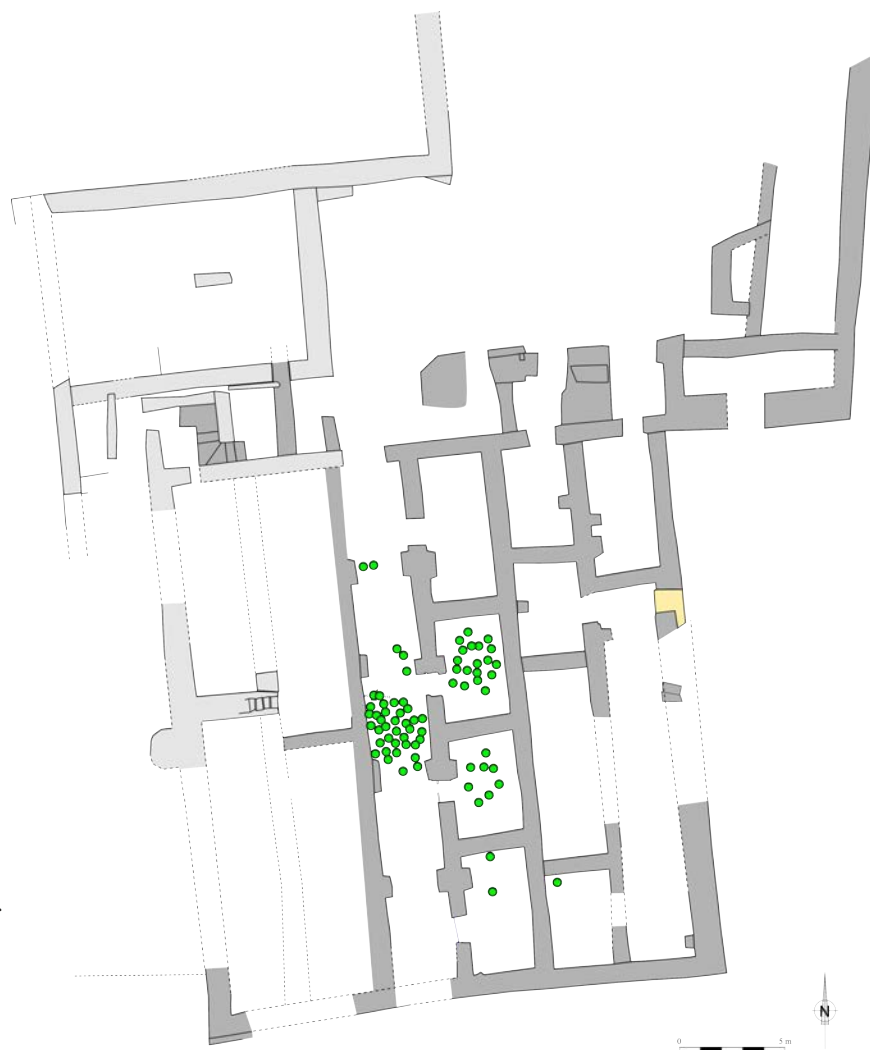

Fig. 181 - Technical drawing of a fan vault (V. Bernard)

Fig. 180 - Location of fan vault elements



Most of them are located in the middle of room B and in room A and C. Some exceptional elements are in room F and in the first third of room B (fig. 180 § 181). The technical analysis is still in progress.

5.6. Merlons

- IsoArc 37, 40, 41, 396, 475, 476, 477, 449

For now eight merlons were found. All have been discovered around or in the room T interpreted as the minaret. They most probably belong to the upper part of this minaret.

5.7. Synthesis

During the 2013b - 2014a excavations campaign, many architectural elements were found among the collapse layers. Some of them are more or less still in their original location; others have moved. But all of them provide general layout of both the basement and the prayer hall.

The observation, the methodology of description and interpretation of the

architectural elements (IsoArc) and the decoration (IsoDec) thus give very interesting results for the architecture of the mosque.

The determination, location and distribution of the architectural elements and the different kind of decoration allow us to distinguished several areas with different architectural features.

All architectural elements identified as round columns on square base with style A and J decorations are located in room A, in room C and in the central part of room B. Four square bases, 3 round drums were also found in this area, as well as one spandrel, 83 fan-vault fragments and one cupola fragment. We should then conclude that the central part of the mosque was covered by a cupola.

The lateral areas are characterized by the discovery of round columns on square base with O and P decoration. The analysis of the distribution of decoration shows also an important presence of turquoise fragments in lateral area north. They probably come from the arches but the study is still in progress.

From the south area two engaged columns with a half-square base, a half-round shaft then half-octagonal with O, P and L decoration, surround a window opening to the south. On the other side, north area, only one engaged column, with O, P, K and EM2 decoration, have been found but the second one was probably completely destroyed. It's possible to reconstitute an entrance to the prayer hall flanked by two external engaged columns.

The third east part of the mosque is separated of the rest by a wall drilled by at least four doors with wood frames. From the prayer hall these doors seem to open on a large terrace. Several columns on square base and with octagonal shaft supported the roof. No capital were found at this time but they were probably in wood. A decoration on the side east of the wall, it corresponds to a relief bandeau surrounding the doors. In that area, a second mihrab was maybe set up between two doors, as a shallow recess in the dividing wall.

The large Friday mosque complex of Qalhât was first discovered in 2008 in the course of the Qalhât Project. Punctual soundings were then opened, followed by complementary excavations from 2009 to 2011. Consequently, some hypothesis regarding the plan and the general layout of the mosque were proposed, according to which a first attempt of restitution was drawn by the specialist of Islamic architecture who has followed these excavations from their very beginning (fig. 182).

Even if the excavation of the complex is not completed yet, the last excavation campaign supported by the MHC has considerably enriched our knowledge. The archaeological team has uncovered a large part of the

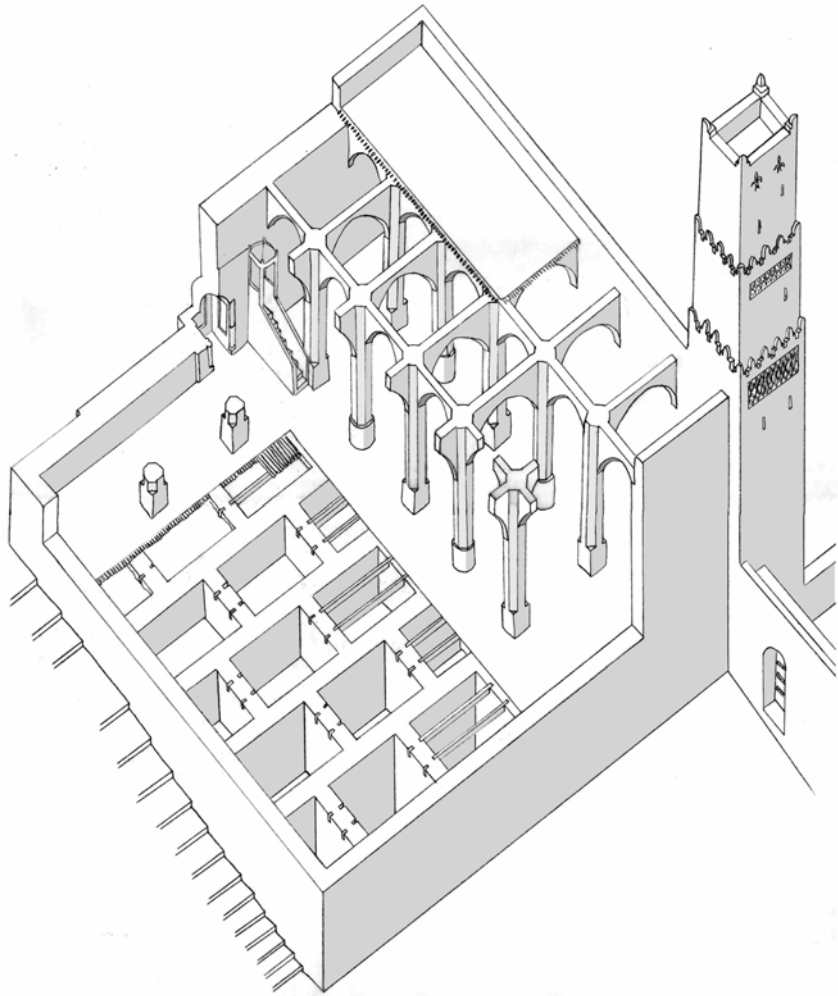

*Fig. 182 - Axionometry
of the great mosque.
Restitution did in 2009
(V. Bernard)*

area and studied many new elements regarding the mosque itself, its basement, prayer hall and various accesses, as the whole complex, the courtyards and associated structures. The strict scientific protocol adopted during the fieldwork has provided precious information concerning the distribution of the bays or the location of the different kinds of decoration identified. It is now almost possible to reconstitute every support of the prayer hall which all have different shapes and/or decoration according to their location. New elements concerning the roofing have arisen and it is now clear that the configuration of the mosque is much more complex than first imagined.

After controlling their clearing during excavation, the same architect was able to draw and study much of these newly uncovered elements. This precise and tenacious work, as well as fruitful discussion with the archaeologists, enabled him to complete and improve his restitution of the mosque. His results were then communicated to specialists of 3D modeling so it is now possible to provide a first attempt of 3D restitution of the mosque (fig. 183).

In the future, the same collaboration between the archaeological team (CNRS/Eveha International), the architect (Vincent Bernard) and the 3D



Fig. 183 - Proposal for restitution of the great mosque. View from the north. (Iconem)

modeling team (Iconem) will certainly allow us to provide a very clear and plausible restitution of the great Friday mosque of medieval Qahât, featuring its exceptional architectural features and extremely rich decoration. Even if this work is still in progress, it is now already possible to ensure that the mosque has a unique place in the history of medieval mosque's architecture (fig. 184).

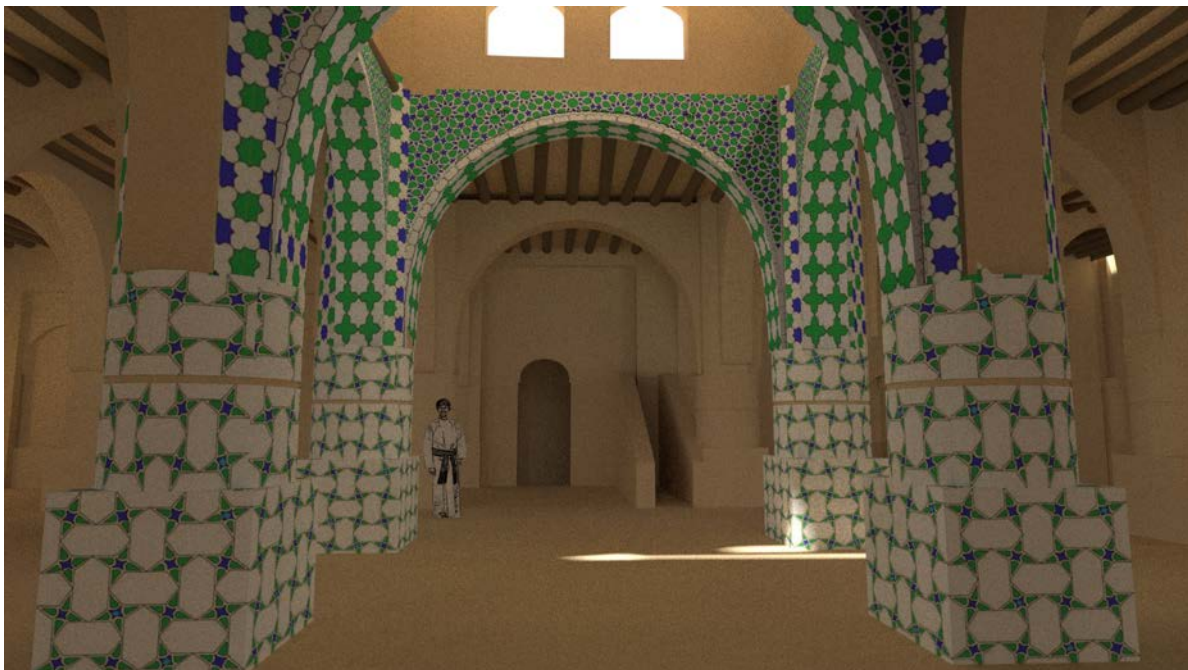

Fig. 184 - Proposal of restitution of the prayer hall with decoration. View from the east (Iconem).

6. By way of conclusion : A visit to the great mosque of Qalhât around 900 A.H. / 1500 C.E.

Excavations at the great mosque are still in progress and the detailed restitution of the building and the complex as a whole is planned to be produced next year, with digital 3D drawings and videos. It is nevertheless possible to give now, from the data already collected, a preliminary but plausible tentative proposal of the mosque complex as it was during its last stage of occupation, around 1500.

6.1. The gates and courtyards

6.1.1. The western gate

Coming from the Bîbî Maryam mausoleum through the main street of the city, the mosque complex appeared to the visitor standing on top of the western ridge, c.10m above it, as a wide and rather open space behind a long boundary wall, limited to the left by the massive figure of building B13, two or three stories high, and with the mosque on the right hand side protruding against the sea background. The main access to the complex was located straight in front of the end of the street down the ridge, against the corner of B13.

It seems that the door was preceded by a porch, 4.5m deep and 3.7m large, which was probably covered with a flat roof, or possibly even by a vault as an iwân. Against the right side of the porch was a plastered bench, and to the left was a wide platform with a raised floor, maybe for guards. The gate to the complex at the back of this porch was 1.9m wide and most probably closed by a wooden door. Once the door passed, the visitor entered into a passage 7m long and 3.8m large between the wall of B13 and a smaller construction located in the corner of the main courtyard of the complex (B95). This passageway could have been opened to the sky or covered with a flat roof. It was bordered by two benches, a long one to the right against the wall of B95, and a smaller one to the left between the gate and a door leading to B13. The central walkway was therefore not more than 2m wide. It was more or less horizontal in the last stage of the mosque, when the courtyard was at the same level than the street outside, but was probably strongly sloping in its first stage, when the level of the court was 1.5m lower.

6.1.2. The western courtyard

This passageway opened onto the corner of the main courtyard of the complex, a wide open rectangular space about 1300m². It was originally 1.5m lower than the present surface and its aspect at that time is not known. It was quickly raised with a backfill up to the level of the street

and the top of the basement of the mosque and was then possibly landscaped as a garden.

This courtyard was limited on the north side by the high wall of B13, on the west and south sides by the boundary wall which was probably around 2.5m high, and it was dominated in the background by the massive buildings of the ancient quarter, especially those located on top of the west and north ridges. To the southeast was the qibla wall of the mosque with the central salient of the mihrab, about 6m high in the last stage of the courtyard, 7.5m in its original state when the upper part of the basement was protruding from the surface. The only opened perspective was to the north-east. A terraced extension of the courtyard against the corner of the mosque was giving access to the door of the prayer hall in the north wall of the mosque, up the roof of the north wing, and a ramp or more probably a staircase between this terrace and B13 was leading to the north-east low courtyard, about 4m down at the level of the beach.

Several secondary buildings were located in the main courtyard. A long construction including a single room with many niches was standing south of the entrance corridor (B95), maybe a madrasa. Several small rooms were also lining the south wall, maybe shops. And an ablution area was located against the north part of the qibla wall and an adjacent small square construction with a door, 4.5 x 4.5m, which sheltered a narrow spiral staircase leading down to a room with other basins in the north wing, at the level of the north-east courtyard. This staircase was also probably leading up until the roof of the mosque and would have therefore been about 3m higher than the mosque, i.e. c.9m high, as a square tower.

6.1.3. The eastern sea-gate

For visitors coming from the east, from the beach or even from a boat on the sea, the mosque appeared as a massive building about 11m high on top of the steep beach, with a square minaret to the right, 4.5 x 4.5m at its base and possibly reaching 30m high at least to be visible from all parts of the city. Four small doors were located at the base of the mosque on the beach, leading to four rooms inside the first span of the basement, each one with a back-room in the second span; these rooms were most probably shops or stores, maybe connected with trade or fishing activities. Several windows were also opened in the upper part of the wall, at the level of the prayer hall.

To the right of the minaret the long boundary wall of the complex, around 2.5m high, was running north along the shore, probably lined by a wide bench or a protecting reinforcement against the sea. Another access to the complex, leading to the north-east courtyard, was located in this wall against a rectangular structure protruding onto the beach, possibly a tower. This area was strongly eroded and the details of the east wall, the tower and the door are now badly known. The gate was 3.20m large and also closed by a wood door, possibly also located in a porch. We know from the

Portuguese chronicles that the population of Qalhât used to gather on the beach and it is more than probable that this gate was also a main access to the mosque. As a matter of fact a second door on the beach seems to have been located near the minaret in the early period of the mosque.

6.1.4. The north-east courtyard

Passing the east gate the visitor entered the north-east courtyard of the mosque complex, a rather small area c.350m², between high walls. To the west, opposite the entrance, the courtyard was lined by the retaining wall of the main western courtyard, at least 4m high not including the parapet. Right in front of the gate, a staircase against the wall of the B13 complex was connecting the two courtyards, the east and west gates in a straight line. To the left the courtyard was closed by the mass of the mosque on its basement, altogether about 10m high at least, with the north wing in the foreground, 4m high. Its façade exhibited a row of doors or arcades leading to cellars inside the basement, and two staircases allow climbing up to a wide terrace on the roof, leading to the gates of the mosque proper. This impressive façade was furthermore flanked by the two square towers, the tall minaret to the left and the smaller tower of the staircase to the right.

6.1.5. The southern gate

A third gate to the mosque complex was situated in the south wall of the basement of the mosque, in the south street. It was giving access to a huge corridor, 25m long, nearly 3m large and about 4m high, which was crossing the entire basement until the north-east courtyard, with four cellars to the right. This area has not been completely excavated yet and the details of the entrance are unknown. But it must be noticed that the corridor was certainly rather dark, and that it was possibly mainly used to reach the cellars rather than as a main access to the mosque. A second gate to the mosque complex from the south street was possibly located just after the corner of the basement, leading to the main courtyard.

6.2. The mosque

The visitors entering the mosque complex through the west gate and the main courtyard could reach the door of the mosque walking straight to the terraced eastern extremity of the court against the staircase tower, and from there to the terrace on top of the north wing, at more or less the same level. Those coming from the beach and the lower north-east courtyard had to climb one of the two

staircases located there, one leading to the eastern extremity of the terrace near the minaret, the other one to the middle of the façade between the doors of the mosque. As a matter of fact, two different accesses to the mosque were located in the north wall, between the minaret and the staircase tower (fig. 185), and it appears that the mosque was not made of a single prayer room but was divided in two parts, 1/3 east and 2/3 west, by a wall based on the wall between the second and third spans of the basement.

6.2.1. The entrance hall

The eastern access was built as a small octagonal porch, 3.2 x 3.2m, which was encompassed in the corner of the mosque's wall and the minaret and was covered by a small cupola decorated inside with friezes of blue and green glazed tiles in the shape of stars and crosses (fig. 186). Access from

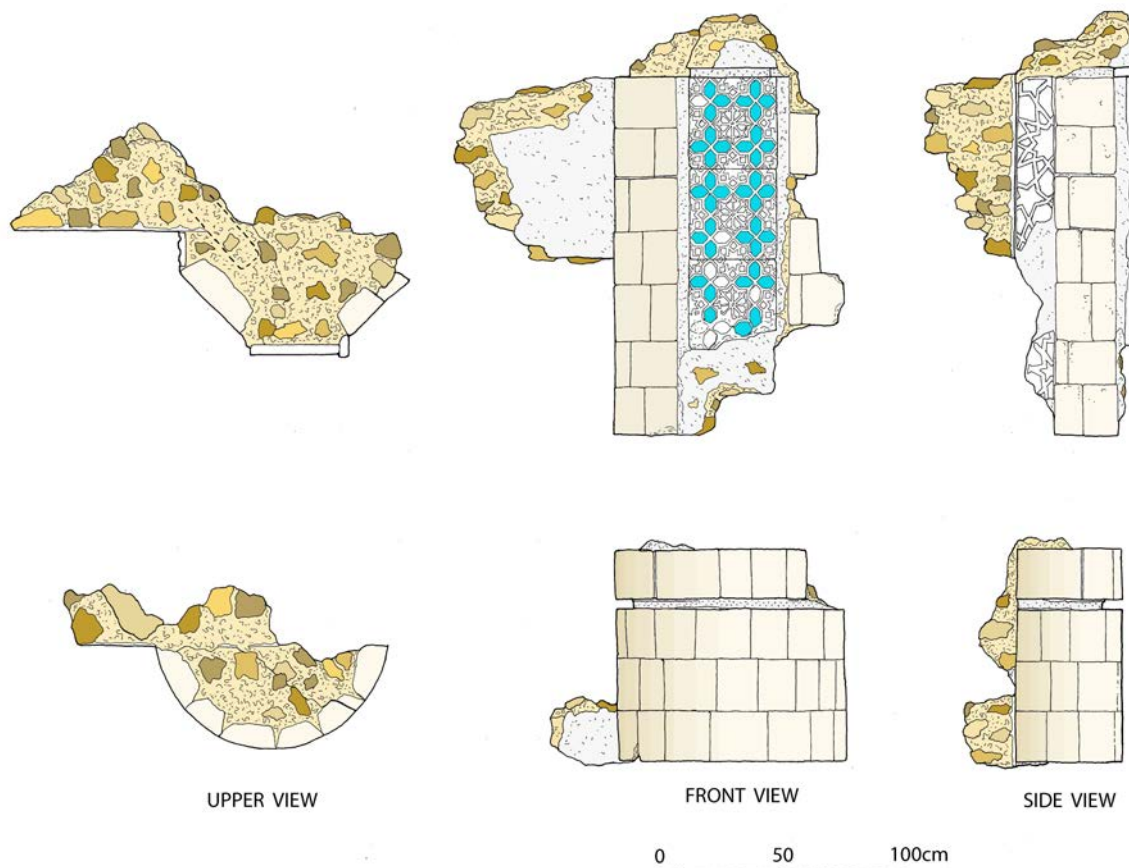

Fig. 185 - Northern gate of the mosque (V. Bernard)

the terrace was in its north wall, in front of the door of the mosque and this entrance was maybe richly decorated as several fragments of Iranian luster tiles from Kashân were found in this area.

Crossing the porch and passing the door of the mosque, the visitor reached a long north-south hall covering one third of the entire surface of the mosque, 6.5m large and 24.5m long (inside surface 159m²), with an axial

row of four octagonal columns on a square base (75 x 75cm + ht.82cm). They were probably topped by wooden capitals and beams supporting a flat roof which was perhaps 6m high as the prayer hall itself. As a matter of fact wood was a very important element of the construction of the mosque, especially as wood strappings were used in columns for reinforcement against earthquakes. It seems that the entrance hall was under renovation when the mosque collapsed and the final aspect of the columns is not known, whether decorated with molded or glazed slabs, or simply plastered. The east wall, on the sea-side, seems to have been opened with windows, and this hall could have been very clear. The west wall had five wide doors, each one opening onto a nave of the prayer hall. The openings were 3m large and probably topped by an arch although their height is unknown. They were closed by double wings wooden doors. The pillars between the doors, c.2m wide, were decorated with slight recesses in the shape of a mihrab niche (fig. 187).

6.2.2. The prayer hall

Although the first hall seems to have been acting as an entrance hall to the prayer hall proper, also as an extension when needed, a second door in the north wall allowed a direct connection with the terrace outside. It was positioned exactly midway between the porch of the entrance hall and the tower of the staircase, and it was flanked by two half columns in small rectangular limestone blocks, most probably topped by an arch. The whole was decorated with a frieze of molded mortar panels with inlaid turquoise glazed tiles, a color which is hardly found elsewhere in the mosque. Passing this door, the visitor reached the second bay of the prayer hall.

The prayer hall was four bays deep and five naves wide (14.5 x 24.5m, 354m²), and seems to have been widely opened to the south with windows (fig. 188). Based on the underfloor walls of the basement, the 12 columns were 2.30m high and rather stubby, with a cubic base 1.15m high and a short cylindrical shaft of the same height. They were crowned by an octagonal capital supporting high arches, about 3m high, running in both directions, north-south and east-west, thus forming rectangular spans. All these elements were highly decorated but the style varied according to their location.

The four central columns of the first and second row, at the intersection of the central nave and the second bay coming from the outside door, are larger (108cm of diameter) than all others (fig. 189). The bases and shafts are built with finely carved limestone blocks in the shape of elongated hexagons arranged horizontally and vertically, with small relief elements in glaze tiles and molded mortar as four petals flowers slightly protruding from the stone column. The arches they supported were also colorfully decorated, the intrados ornamented with green glazed stars or crosses inlaid in the white plaster and the spandrels with elaborated motives of stars made of mortar flanges on fragments of glazed tiles.

The four lateral columns of these two rows, as the four engaged columns at their extremities, are thinner (97cm) and built with simple rectangular limestone blocks tightly adjusted. The arches were decorated, on the intrados and spandrel, with molded mortar panels, seemingly without color decoration.

The last row of columns, in front of the qibla wall, seems to have been different. This part of the mosque was hardly studied yet but the bases excavated are different, with three sides in plain rectangular limestone blocks when the fourth one, on the east side facing the community, was decorated with green and blue glazed tiles inside a carved stone frame. The qibla wall itself is still badly known. It may have been decorated with small niches and several elements of decoration, including an inscription, were located around the mihrab.

The arches of the prayer hall were supporting a flat ceiling, about 5.5m high, except above the four central columns which were supporting a cupola (fig. 190). The rectangular span was here surmounted by a rectangular drum and then an octagonal one through squinches. Then was some kind of a cornice supporting a ribbed cupola, the keystone about 11m above the floor of the prayer hall. Both drums had openings and the prayer hall must have been very clear, with these openings to the sky, the windows in the south wall and the light coming from the entrance hall through the wide doors.

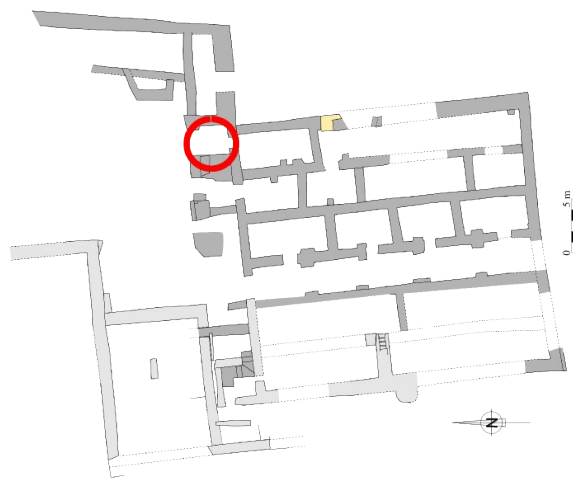
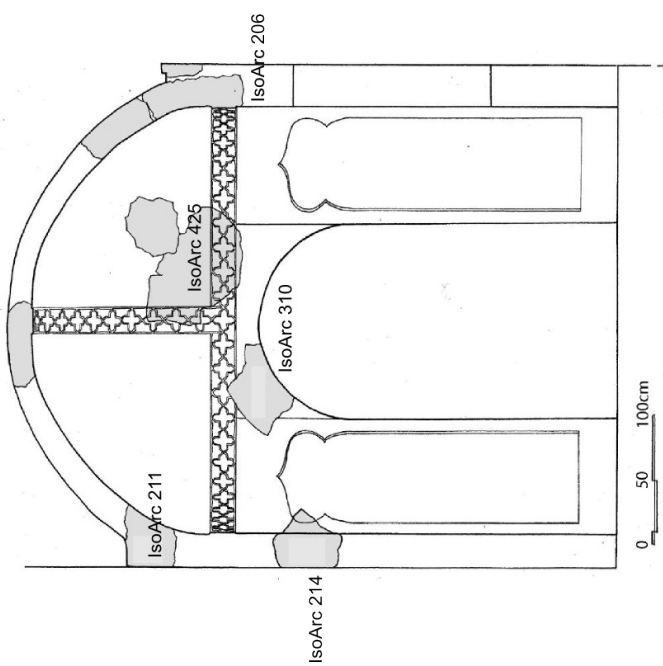
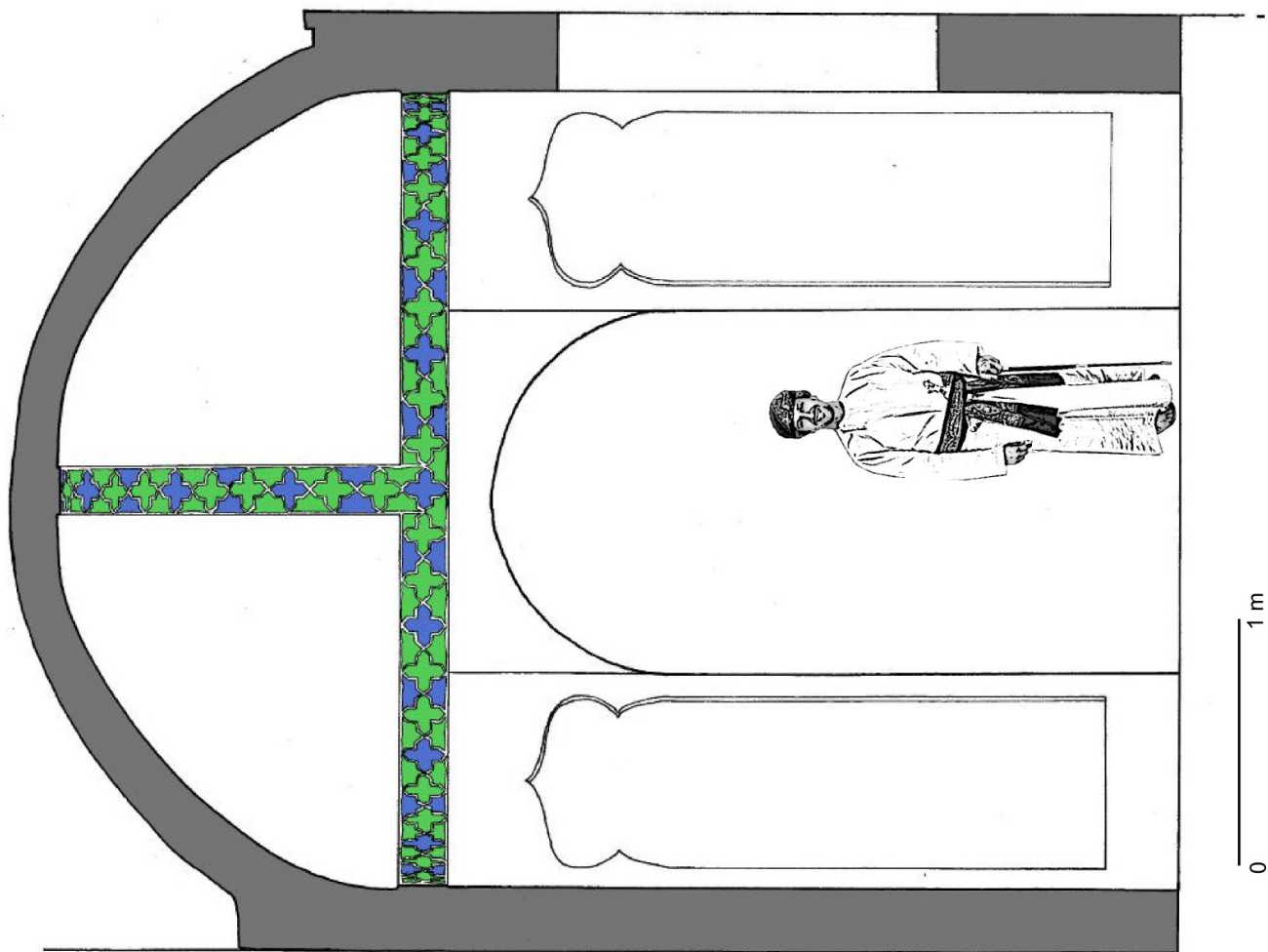
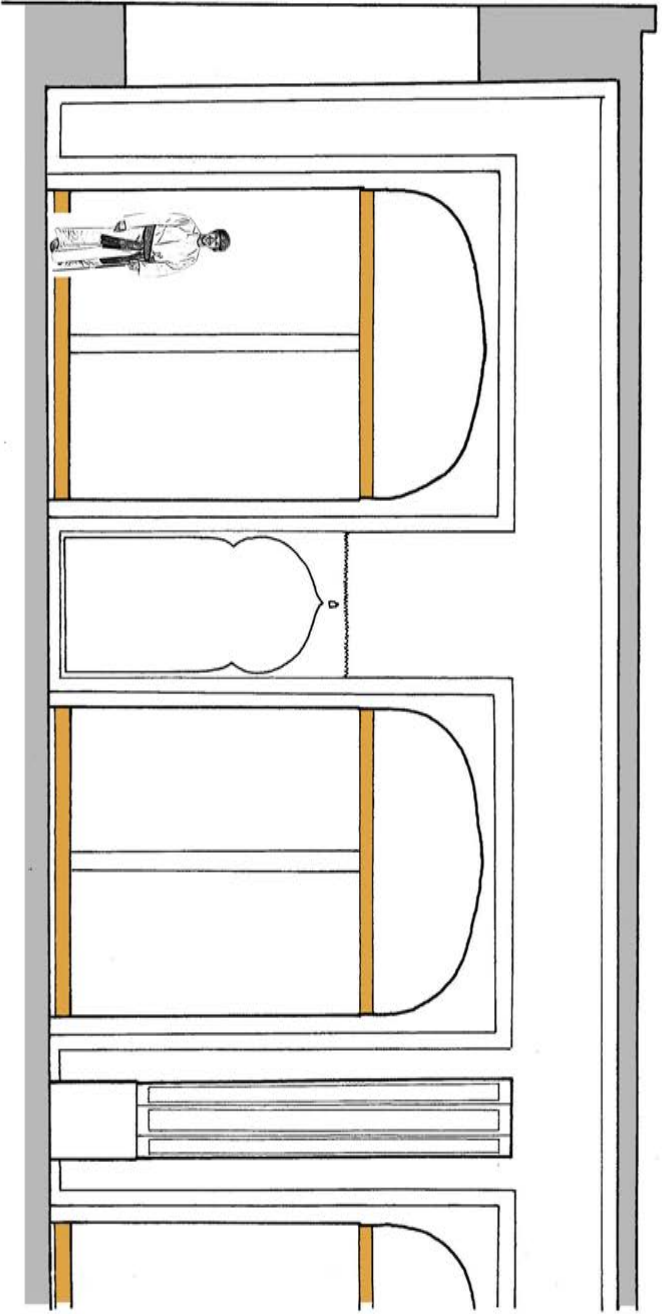

Fig. 186 - Proposal for restitution of the small cupola and the porch (V. Bernard)



0 1 2m

ENTRANCE HALL

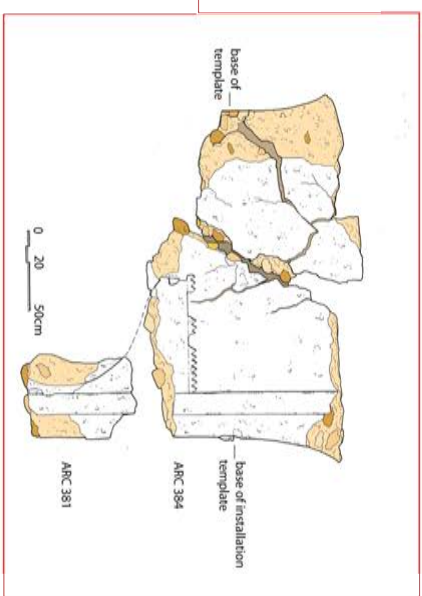
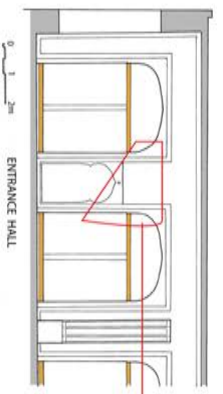
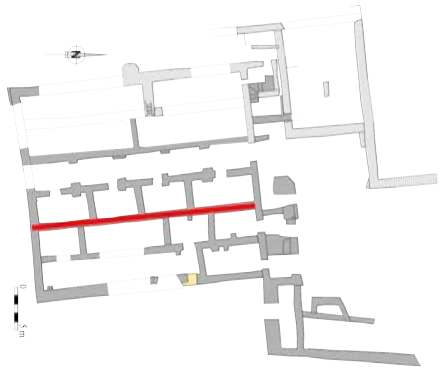

Fig. 187 - Proposal for restitution of the entrance hall (Y. Bernard)

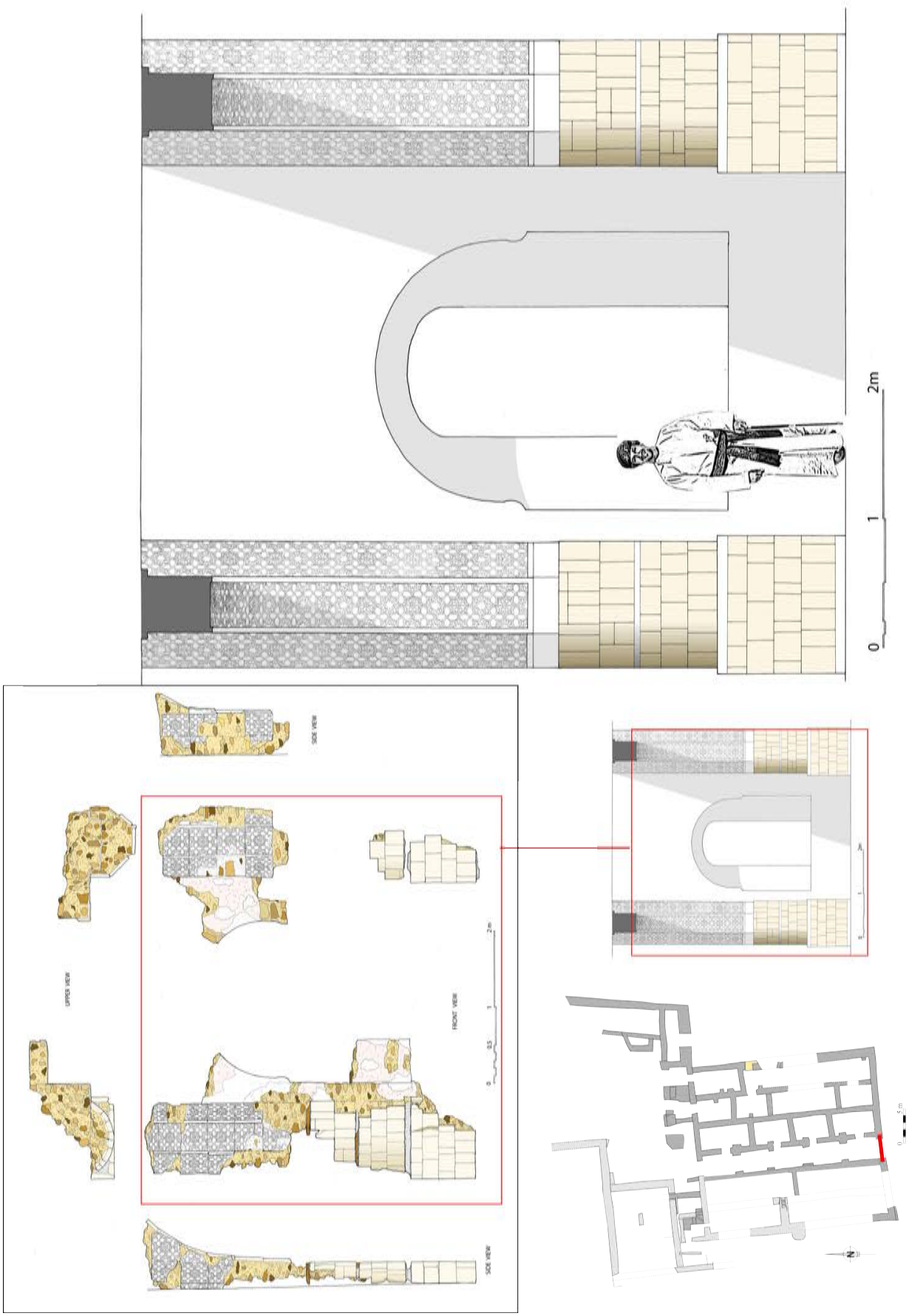

Fig. 188 - Proposal for restitution of the south wall with window (V. Bernard)

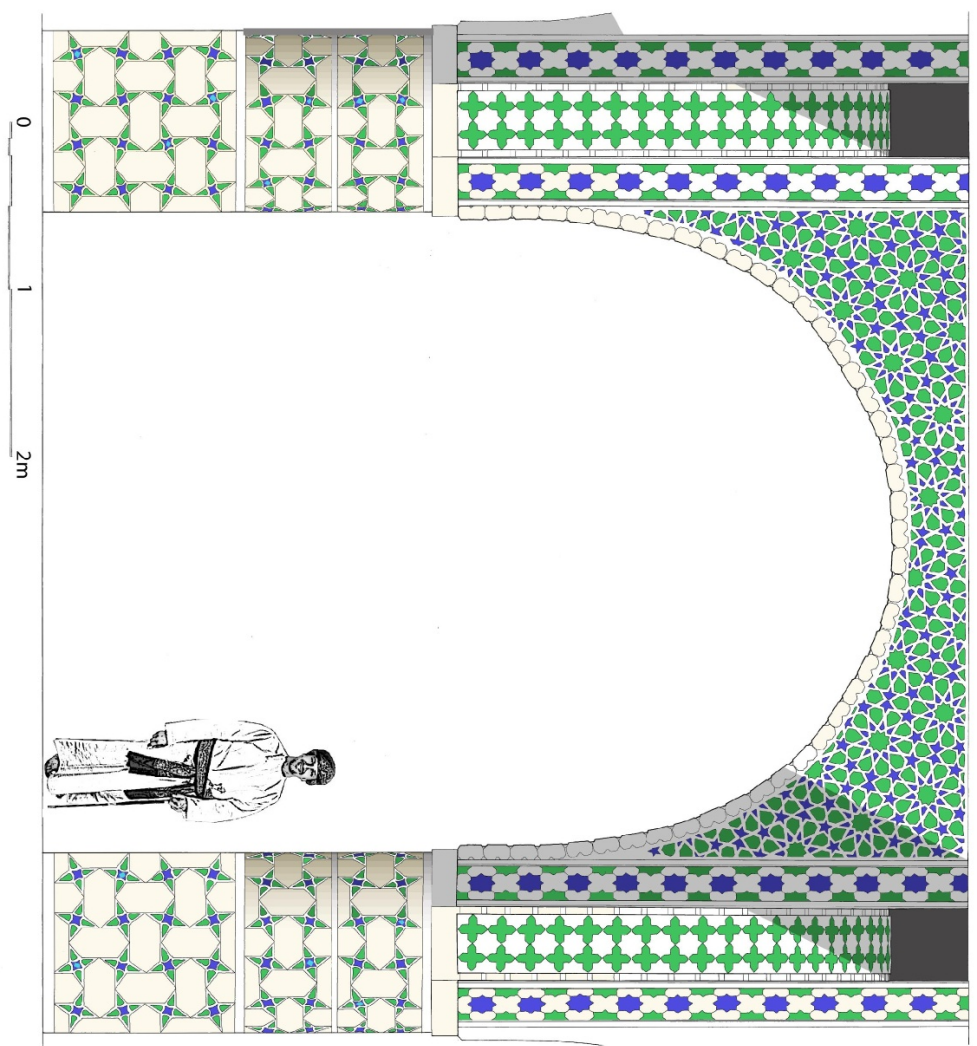
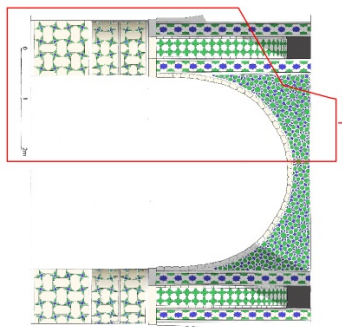
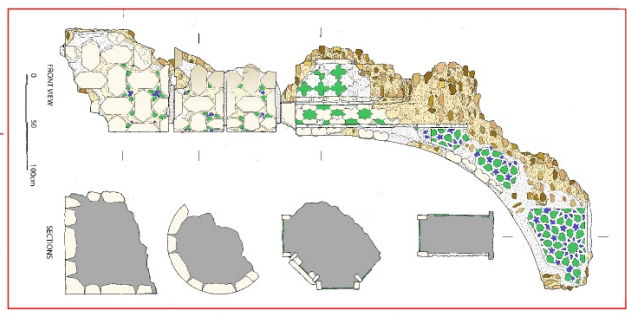
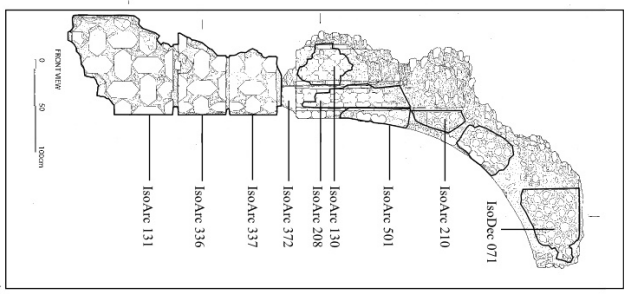
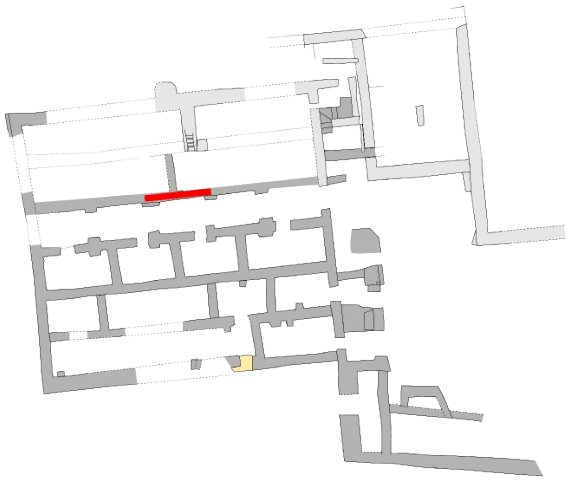

Fig. 189 - Proposal for restitution of the central arch of the prayer hall (V. Bernard)

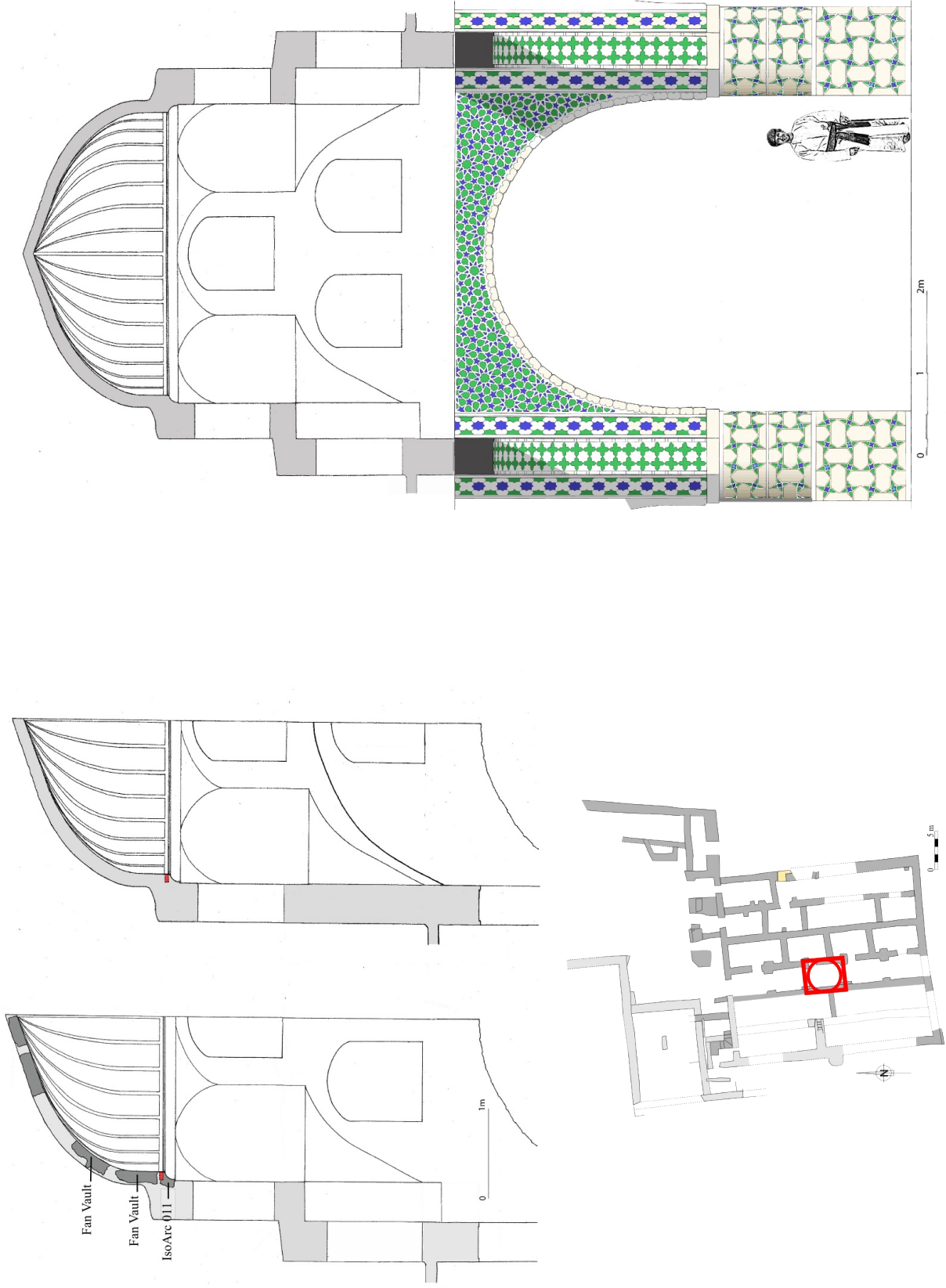

Fig. 190 - Proposal for restitution of the central cupola of the prayer hall (V. Bernard)

B. The ancient quarter of the city around the great mosque

Parallel to the Qalhât Development Project (QDP), a second five-year session of the original Qalhât Project (QP) initiated in 2008 was launched in 2013. Its objective is to continue studying the development and spatial organization of the medieval city of Qalhât as a whole, beside the extensive excavations and conservation of some specific buildings by the QDP. Thanks to the Ministry of Heritage and Culture and to a special fund of the CNRS-UMR8167 and the Archaeological Committee of the French Ministry of Foreign Affairs, a team of 4 people came for a one month mission (November 14th – December 14th):

Dr Axelle Rougeulle, archaeologist, CNRS-UMR8167, director of the QDP and the QP

Dr Thomas Creissen, archaeologist, Head of Eveha International

Mrs. H  l  ne Renel, ceramologist, research engineer at CNRS-UMR8167

Ms. Nolwenn Gilbert, assistant archaeologist, Master Student at Sorbonne University

The objective of the QP this season was to get information about the ancient quarter of the city, around the great mosque which is currently under clearing by the QDP. Two different investigations were made, a surface survey to get detailed information about the plan of this quarter, and excavations at what was supposed to be the suq of the area.

1. The surface survey in the ancient quarter of the city

1.1. Introduction

In 2008-2010, the Qalhât Cartographical Project, lead thanks to a fund of the Total Company by two archaeo-geographers from the CNRS Arch  orient lab in Lyon (Olivier Barge & Emmanuelle R  gagnon), succeeded to draw a preliminary map of the medieval city of Qalhât. The plan was based on a GIS built on a surface mapping of the ruins by differential GPS and the study of kite photographs. Although the Cartographical Project succeeded to map the entire surface of the site in the limited time allowed, three two-week missions, the ruins are extremely difficult to interpret, especially in densely built areas, and the plan was more or less accurate. Furthermore it had to be interpreted by an archaeologist.

One of the objectives of the second QP five-year session is therefore to achieve a comprehensive and precise survey of the entire surface of the site, to verify and detail the map of the QCP. It will provide detailed information on the spatial organization of the city, the different quarters, the various street networks, the boundaries and, hopefully, the inside plan

of each building. It will thus provide an accurate documentation for the publication and the development of the site and allow a better understanding of the life and evolution of the city.

During this first season the survey concentrated on the ancient quarter of Qalhât, around the Friday mosque which was under excavation by the QDP. The complete area between the main west-east street leading to the mosque and the southern inside wadi, a distance north-south of 200m, and between the sea and the main north-south street of the city, about 150m east-west, was surveyed. Altogether it represents a surface of c.3ha, the most densely built and therefore the most complex to interpret. Around fifty buildings or groups of buildings had been identified in this area by the QCP and were checked in detailed this year (fig. 191 § 192).

1.2. The streets

Although slightly meandering according to the position of the buildings, the general layout of the main street network in this quarter is roughly oriented north-south and east-west (fig. 193). Three main north-south axes

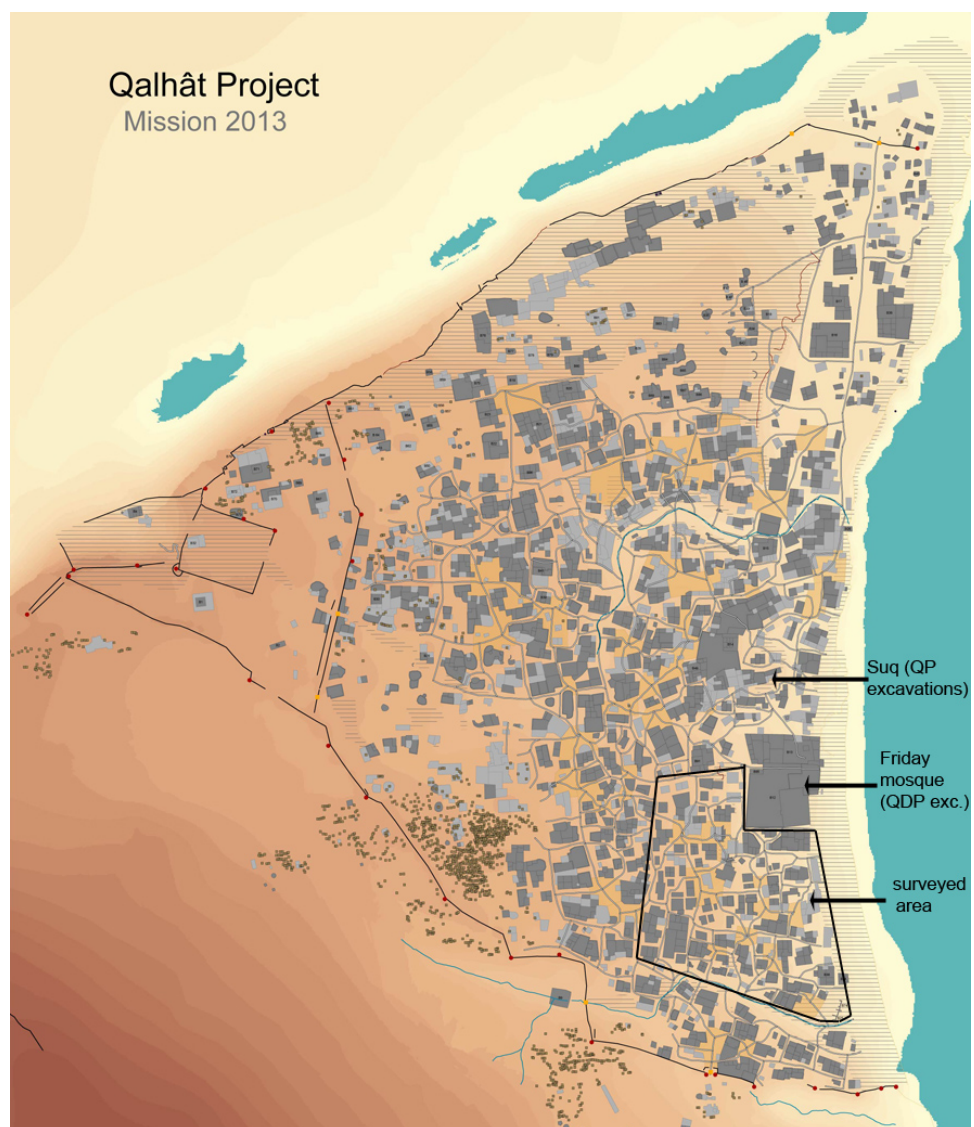

*Fig. 191 -
Location map of
the work of the
QP during the
first season*

Fig. 192 - View of the south-east quarter, seen from building B196.



were identified. The westernmost was leading to the south gate of the city (B8) after crossing the south wadi near its passage under the fortification wall B7 and then turning east across the south quarter. The two other main north-south streets reach the bed of the wadi but could hardly go further south given its very steep southern bank and had probably to follow the wadi bed eastwards or westwards. Beside the wadi itself, which was most of the time practicable, four main east-west streets were connecting the beach to the interior of the city, two located north of the area, near the mosque, and two others south, not far from the wadi. These main streets were interconnected by secondary pathways getting around the buildings.

Except for some narrow lanes, all those pathways, main and secondary, were as a rule rather wide, from 3m to 6m, about 4m on average. In this quarter the ground is rather sloppy, from the sea towards the west and from the wadi towards the north, in some places showing steep ridges in the bedrock. These ridges were thus landscaped, with stairs roughly cut in the bedrock and/or masoned. The surface of the streets is rarely visible now, hidden under collapse, and it is impossible to know without excavating whether they were landscaped. They were most probably at bedrock level, at least in the beginning before the level rises with daily life rubbish, and were probably masoned in places with isolated stairs or real staircases depending of the slope. Given the sloppy ground of the city, many of these streets would have been used as channel by running water in case of heavy rain and the bases of the walls were most probably protected by a strong mortar or an enlargement, as in the street excavated this year in the sūq (see below). Some outside terraces are also visible, open areas limited by low walls with a horizontal surface covered with small white pebbles. They are leaning against buildings or isolated but their function is not clear yet. Some of them, especially along the Great Mosque, were funerary terraces as traces of graves are still visible on top. Others are located in the

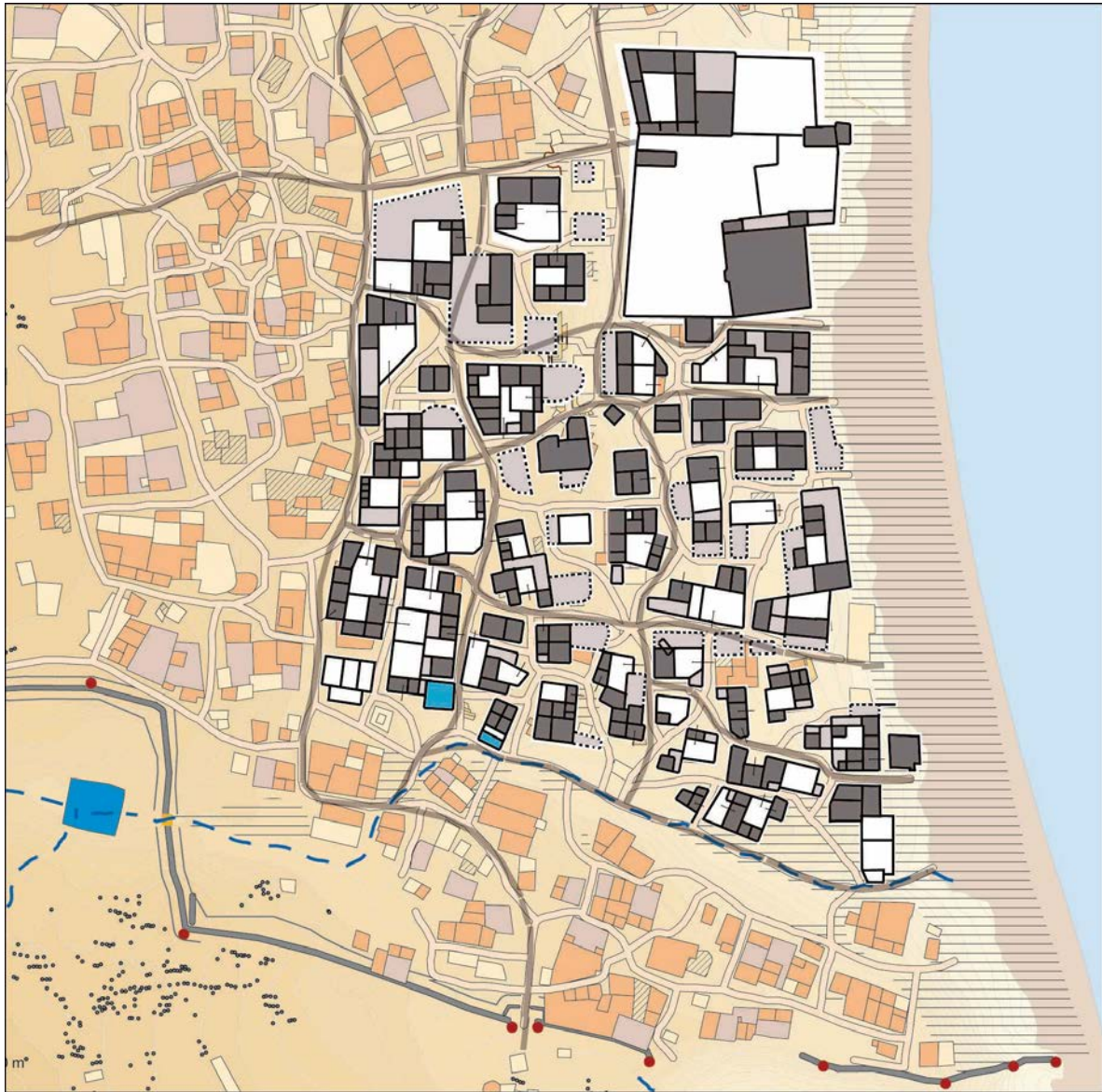

middle of city squares, which are open spaces about 20m x 20m at the meeting point of several streets, and could be connected to the circulation network.

1.3. The buildings

The buildings are rather wide constructions, around 300m² in average, up to 600m² in some cases, but three main groups may be identified (fig. 194). The largest are located close to the great mosque on the sea-shore; they are associated with some wide rectangular terraces overlooking the beach and harbour and these edifices could have had an official or public function connected to the trading and maritime activities of the city, as a custom for example. Other large buildings are located c.80m westwards, on top of the first natural ridge parallel to the coast from where there is a perfect view over the harbor, maybe the residences of wealthy merchants. Between these two groups and especially south along the wadi are smaller constructions, with smaller rooms and courtyards. It is possible that these

Fig. 193 - Map of the city in the area surveyed showing the main streets and structures (white: courtyards; black: rooms; grey: open outside terraces).

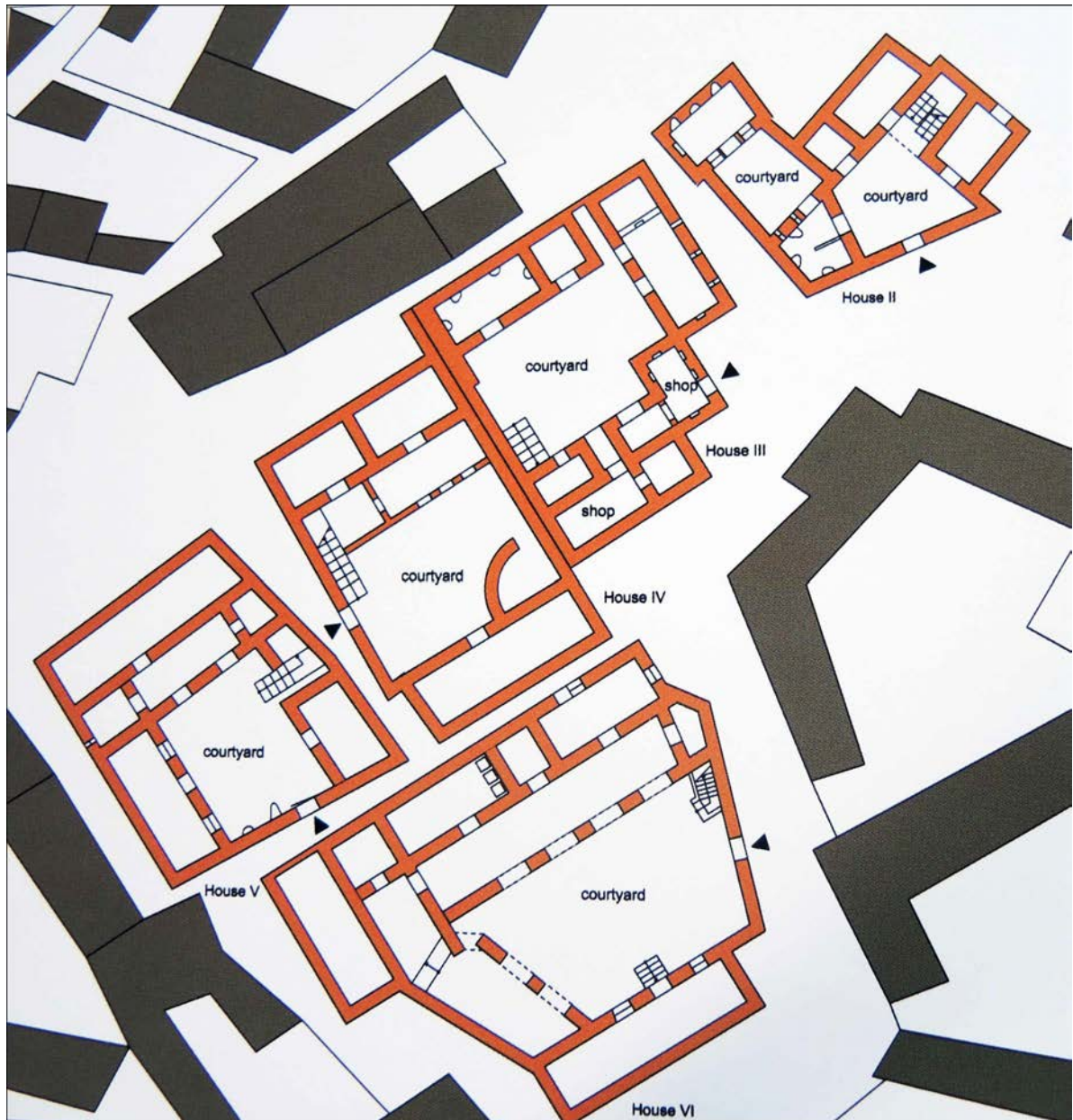

Fig. 194 - Plan of ancient houses in Tiwi (from Salimi, Gaube & Korn, Islamic Art of Oman, p. 160).

small houses go back to the ancient period of the quarter while the large ones would be part of the rehabilitation of the city at the end of the 13th and in the 14th centuries

Most buildings are roughly rectangular and oriented north-south but they often have a rather complex layout, with corners and recesses, and sometimes oblique surrounding walls. Many had probably two storeys, at least in some parts, and some of them show a gradient of nearly 5m between the bottom surface in the center of the wider rooms/courtyards and the highest preserved ruin. The identification of boundaries and inside spaces is therefore difficult to ascertain from surface survey only, but the plans could be similar to the ones of the ancient houses in Tiwi for example.

It is especially difficult to establish the number of accesses to the inside

part, and thus to get an idea about the number of familial units living in the building. As a matter of fact, these constructions seem very large to be the residence of a single family, unless the inhabitants of Qalhât were all rather wealthy. Many buildings also show more than one undisputable courtyard, i.e. large spaces too wide to afford a ceiling, and this could indicate the presence of several families, as in house B94 excavated in the northern quarter of the city (see final report QDP 2013a). Small rooms located against the main outside walls of some buildings could be shops.

As usual in Oman, the courtyard and ground floor of the houses could have been mostly used for storage and trading activities, with limited openings on the outside. The domestic life was probably located on the first floor and the terraces of the roof which were protected by a parapet and very important spaces. As the natural ground is rather sloppy at Qalhât, most house probably benefited of the sea-view, at least from these terraces. Altogether, the visual aspect of medieval Qalhât could be rather similar to the ancient quarters still preserved in some present Omani cities, as at Hamra for example (fig. 195).



Fig. 195 - Photo of ancient houses in Hamra (from Salimi, Gaube & Korn, Islamic Art of Oman, p. 185).

2. The suq

The suq is one of the main centers of an Islamic city, an important feature for the understanding of its spatial organization, as of its social and economic life. One of the objectives of this season was therefore to try discovering and then excavating the suq of Qalhât, or at least one suq. The survey did not delivered any trace of small structures as suq shops south of the great mosque, but an area north of the probably palatial residence B13 seemed a good candidate for the location of the suq.

As a matter of fact, north from the so-called palace B13 is a small basin topped by both this huge construction and B14, the building excavated by the iranian team in 2008. There, small hips of stones and coral blocks were lined up on both side of what looked like a sinuous street coming from the western part of the city (fig. 196).

The fact that these hips were not high seems to indicate that low and small



Fig. 196 - The supposed suq area before excavation

buildings were there constructed on both side of at least one path. This peculiarity as well as the fact that this area is located not far from the sea and near the monumental center of the old city have been considered as clues to the identification of this area as one of the suq of Qalhât.

To check the viability of this hypothesis, four soundings have been opened (fig. 197 § 198 and cf. vol2, p. 155 § 157).

The bedrock have been reached in different parts. Its level is very irregular : culminating at ca. 15m30 on the north side, is only at ca 14m20 in the center of the excavated area, where it is cut by what could be a natural ridge or a trench filled by a huge backfill (Uf 4016, cf. vol2, p. 155). This backfill have been removed until ca 13m50 without reaching the bedrock. Southward from this location, excavations have been stopped on top of a layer of pebbles and gravels included in a very strong sediment which

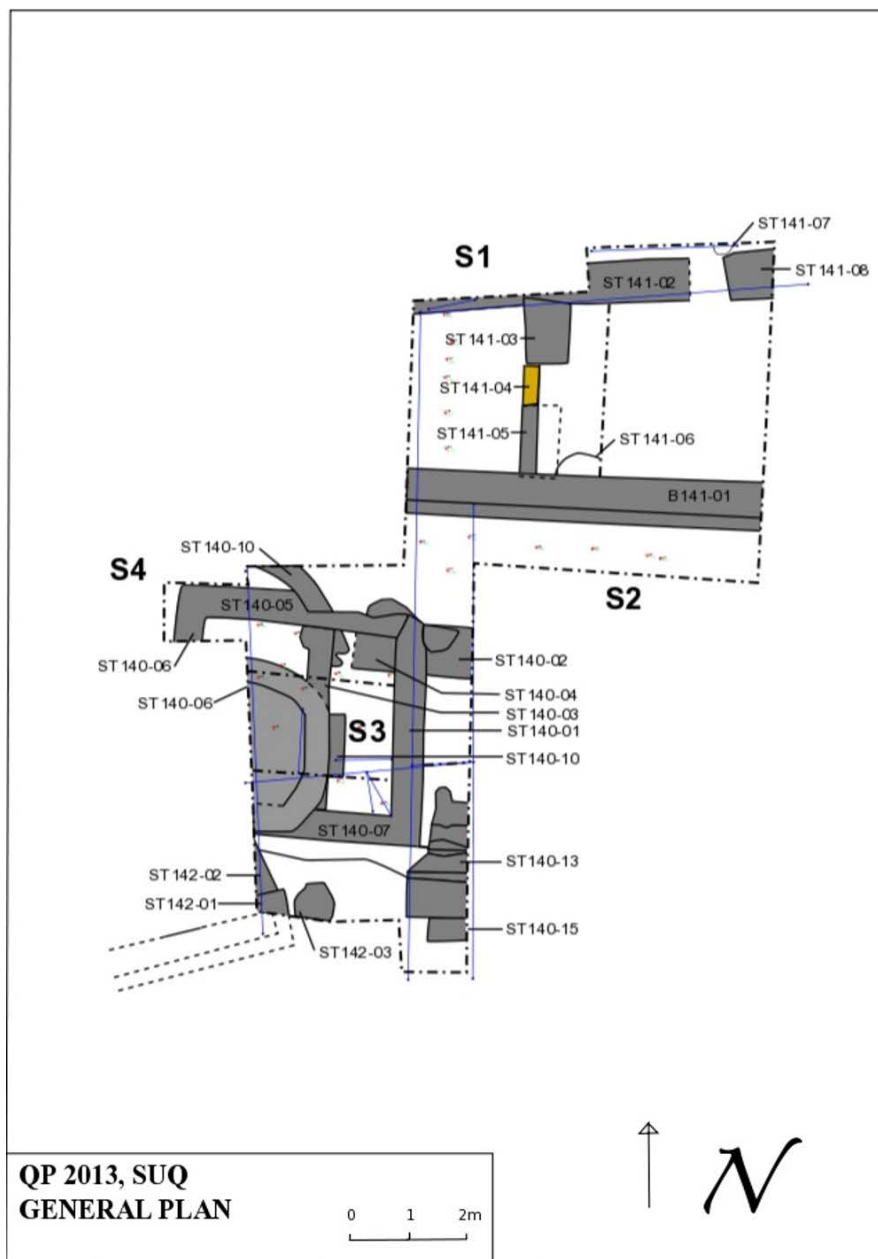

Fig. 197 -
Topographical plan
featuring location of the
soundings.

could be a level of colluvium (Δ ca 13m70). This level is topped by two sterile layers, one made of medium pebbles in a strong orange sediment, the other one mostly containing very small pebbles and gravels (Uf 4079). The upper one is at ca 14m20, and both of them are probably natural deposit.

The earliest occupation is documented by a pit (St 140-12) located in the south western part of the excavated area (fig. 199). It has been dug from a level of pebbles culminating at ca. Δ 14m00, down to ca 13m50. The sides of the pit are partly coated by a very compact clayish layer including some stones. The filling consist of heterogeneous layers, some of them lens of ashes and charcoal (Uf 4076, 4077). The ceramic, including some sgraffiatos, is dated from the first half of the 13th century (fig. 200).

This structure could not be linked to any building or other fittings yet.



Fig. 198 - General plan of the excavated area

On the southern part of the area is a stairway including at least four steps (St 140-13, fig. 201 and cf. vol2, p. 155). It is going down from south (Δ ca. 14m80) to north (Δ 13m85), where it is reaching a flat floor, just partly unearthed. Southward from this stairway, a small masonry (St 140-15) could be both a fifth step or part of the corner of a building (fig. 202). In



Fig. 199 - Section showing the pit St 140-12 (lower part).



Fig. 200 - 13th century ceramics from St 140-12

this area, the stairway leads to a floor located at ca. Δ 14m80 (Uf 4084). Connected to this layer, a very big boulder is probably related to a building located eastwards (B142, fig. 203). From this building, only the corner of what could be a bench running along its northern face have been excavated (St 142-02). But this masonry should probably be related to an alignment of stones emerging from the surface ca. 2m westwards (fig. 197). They certainly belong to a wall which is parallel with St 142-02 but not in the same axis. We then proposed that this wall is reinforced by the coated bench St 142-01.

In this part of the soundings, only the collapse layers have been removed, and is not possible to ensure any date for building B142. Even if it could be a late building, it is nonetheless clear that this area was reached by using the above-mentioned stairway : originally, it was a raised place. Only a complete excavation of this area could help to date more precisely the building B142.



Fig. 201 - Lower part of the stairway St 140-13.



Fig. 202 - Upper part of the stairway St 140-13.



Fig. 203 - North west corner of the supposed B142 building and associated boulder.



Fig. 204 - South section inside B140 showing the backfill Uf 4072 above the wall St 140-14 (section C).



Fig. 205 - The wall St 140-14.

Later, this staircase was partly covered by a backfill (fig. 201). Westwards from the staircase, the same backfill have been used to fill a pit partly excavated (St 140-11), that cuts different layers (Uf 4075/4081) containing ceramics from the second half of the 13th century or the first half of the 14th.

It has to be noticed that many shells of the same species have been collected in Uf 4075, probably related to a precise activity which is not yet recognized.

The backfill itself (fig. 204) contains pieces of walls and many fragments of coating mixed with ceramic belonging to the first half of the 14th century.

On top of that backfill, a south-north wall is built (St 140-14, fig. 254 and cf. vol2, p. 157). Only 1m30 long of it have been cleared. It is coated on its east face (the western face have not really been excavated). It is at least 40cm wide, and the masonry includes a lot of coral blocks bended in a strong beige mortar. Towards the east, this wall might be related to Uf

4063, a possible external floor. Westwards, two possible floors are located at ca 14m20 and 14m40 (they have been excavated as Uf 4068 and 4071, which are actually mixed Uf). They are flat and probably belong to the inner part of the building St 140-14 is belonging to. Few stones found in the western part of sounding S1 might belong to a wall connected with B 140-14 which would have had a west-east orientation.

North from this wall, different fittings might be linked to the same architectural phase. First of all, a street that was visible even before the excavations have been identified. It is running from the upper part of the old city down the seashore. This street, approximately 2m wide, reach the bedrock which was used as the circulation level at ca. 14m20.

On the north side, a long wall 1m10 wide is running all along that street (St 141-01, fig. 206 § 207 and cf. vol2, p. 155). It is at least 5m50 long, but stones emerging from the surface on the eastern part of this area seems to indicate that it was much more longer. This wall is directly built upon the bedrock, or on top of a natural depression filled with a sterile sediment (St 141-06). A coated bench ca 70cm high reinforced its southern side, and the



Fig. 206 - The building B141 from the south with wall St 141-01 in the foreground.



Fig. 207 - Building B141 from the east.

wall itself is only 80cm wide. It is mostly made of coral blocks banded in a grey mortar. The face of the wall and that of the bench don not follow the same orientation. This wall is related to another one located 3m northwards (St 140-02) that is not strictly parallel. It is also built directly on the bedrock, which have been cut on some place in order to accommodate this construction. Both these walls belong to a 3m large building. No door leading from the street to this building have been identified.

On the eastern part of the soundings, no floor have been discovered : the collapse layers (Uf 4036, 4053, 4058) lies directly above the bedrock, which was then probably used as a circulation level for this area. On the west, two south-north wall were connected to both wall St 141-01 (St 141-05) and St 141-02 (St 141-03). The southern one is severely damaged, and only its western face is more or less preserved. Between these two walls, a 1m wide threshold is built (St 141-04). There was a door leading to a room located westwards. This room is associated with a floor (Uf 4009, ca Δ 15m) but also with preparation layers for this floor (Uf 4031, 4020). These layers were settled here to flatten the surface, as the bedrock is very irregular (section A). The material coming from this strong backfills dated from the second half of the 13th century or the first half of the 14th (fig. 208).The material coming from the floor (Uf 4009) is much more later : end of the 15th century or first half of the 16th. This indicate that this building was kept in use for a long time, probably more or less until the final abandoned of the city.

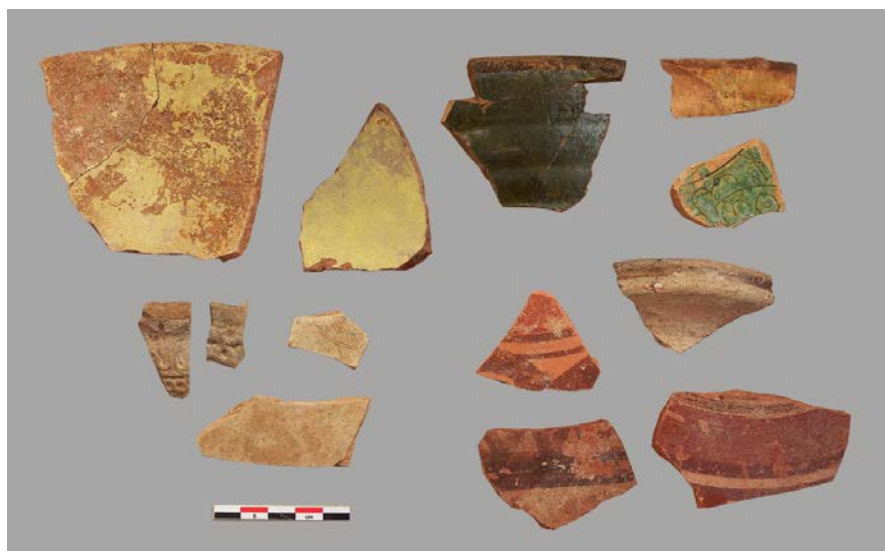

Fig. 208 - Ceramics coming from the Uf 4020 and 4031.

On the southern side of the street, the architectural history is much more complex (cf. vol2, p. 155). First, as it have already been mentioned, the bedrock is here cut by a natural ridge or a trench filled by a huge backfill, Uf 4016 (fig. 209). This backfill contains a lot of pottery sherds that are not very significant : they could date from the 14th century until the first half of the 15th. On top of this filling, the pit is covered by a layer of small

*Fig. 209 - The bedrock
in the street and the
backfill Uf 4016.*



pebbles included in a strong brown sediment (Uf 4013). The material coming from this layer is mixed, and some elements are dated from the end of the 15th century or the beginning of the 16th. But it is much probable that elements coming from the upper layer (4010/4003) have been mixed with the one properly coming from 4013.

Indeed, on top of that layer, at ca Δ 14m00, a curved wall is built, which is only partly unearthed (St 140-10, fig. 210). It is a least 60 cm wide, and its eastern face is coated. Stones and coral blocks are banded in a strong yellowish mortar. This wall is running across the supposed outline of the street and is preserved for approximately 90 cm high above the supposed circulation layer of this street : it is difficult to understand why this wall partly occupied the street. But the space between its outer face and that of the building B 141 would have been approximately 1m, so it was then still possible to use the path (even if this one would have been very narrow in that part of its outline).

Uf 4013 is also topped by huge boulders located eastwards (St 140-02, fig.

*Fig. 210 - The wall St
140-10 topped by St 140-
05.*





*Fig. 211 - The masonry
St 140-02.*

211). These boulders are connected with other stones (St 140-04), and all of them probably belong to a huge and rough masonry lining the southern side of the street and abutting the wall St 140-10. No floor or circulation layers could be surely associated with all these walls yet. The relation between St 140-10 and St 140-14 are not clear.

Later, all this area was raised and a backfill covered both the remaining part of the staircase and wall B140-14 (Uf 4012/4056/4066). This backfill contains ceramics from the second half of the 14th century. Above this layer, and some of the above-mentioned masonries (St 140-02, 140-04 and 140-10), a new building have been constructed (B140) from ca Δ 14m30. Part of its four walls are known (fig. 212). The east one is about 4m50 long on the outside (fig. 213), and we could reconstitute the same length for the west one. The north – and most probably the south – one is about 5m long (fig. 214). These wall are about 50 to 60 cm large, and it is then possible to reconstitute a construction of ca 14m². The south and east wall are mostly made of coral blocks bended in a very poor mortar whereas huge limestone ashlars ore pebbles are used for the lower part of both the north



*Fig. 212 - B 140,
general view from the
south.*

Fig. 213 - East wall of B140-01, inner face.



Fig. 214 - Northwest corner of B140 from the south.

and west walls. No entry leading to this building have been identified yet. On its eastern side, it was lean by a path now completely covering the staircase, and partly abutting the wall St 140-02 (Uf 4012). This path is located at Δ 14m60. On the southern side, an oblique edge or wall about 60cm high was erected between B140 and B142. Its function remains unclear (fig. 203).

Inside B140, a 40cm wide partition wall have been identified (St 140-03, fig. 215). It partly consists of huge pebbles or boulders, but a flat area about 1m large located in the center probably correspond to a threshold.



Fig. 215 - St 140-03, a partition wall inside B140.

We should then conclude that B140 was divided in two rooms. The elements used for the low part of the partition wall B140-03 indicates that the upper one was most likely made of vegetal elements.

Inside this building, the floor of the east room is made of a hard brown sediment (Uf 4052, ca. Δ 14m70/14m80, fig. 216). A post-hole related to this floor is located in the south-east corner (St 140-09, Uf 4048, 4049). Its diameter is about 20cm and it is 15cm deep. Not far from there, a small pit also cut the floor of this room. It is approximately 40 cm long for 35cm wide, and 20cm deep. The filing (Uf 4050) contains many fishbones but also ceramics sherds dating from the late 15th or 16th century.

Inside the western room, a hard beaten hearth floor has also been



Fig. 216 - Inner floor of B140 and associated excavated structure (St 140-08 and 140-09).

identified (Uf 4065/4068, Δ 14m60/14m70). No specific fittings have been identified inside this room.

All these buildings were later abandoned and, covering B140, there was a thick layer of loose sediment including many lens of ashes or charcoal, as

well as a lot of ceramics sherds, fishbones, shells... (Uf 4029, 4034, 4046). The pottery dates from the end of the 15th or the beginning of the 16th. Above this backfill (?) that partly topped the ruined walls of B140, are the proper collapse layer containing many coral blocs of some stones mixed with a very loose light grey sediment (Uf 4001, 4002, 4008, 4030, 4041, 4042, 4045).

These layers are covered by Uf 4003, which filled the former location of the street. It is a sandy layer, including many small pebbles.

A huge pit was then dug through the layers of collapse (St 140-06). It is filled with many stones and coral blocs (Uf 4032, 4040). Its function remain completely unknown.

In sum, in that area, preliminary excavations have revealed the existence of many streets or paths associated with buildings, three of them probably still in use when the city of Qalhât was abandoned. The only one largely excavated is quite small and divided in small rooms. All this could fit with the hypothesis of the souk, but no specific fittings or material confirm its validity. We also have to noticed that if many streets or path seems to have been identified, two of them are cut by wall or high edges. Three main phases could be distinguished, even if the precise chronology is still not perfectly clear for some buildings. A complete excavation of that area is therefore desirable.

C. Preliminary analysis of the archaeobotanical remains

Margareta Tengberg^a, Jérôme Ros^a and Vladimir Dabrowski^b

^aCNRS, Muséum National d'Histoire Naturelle, UMR 7209, Archéozoologie, Archéobotanique, Sociétés, Pratiques et Environnements, 55 rue Buffon, 75005, Paris, France

^bMaster 2 student, University Paris I Panthéon Sorbonne, Paris, France

I – Introduction

This report describes the first preliminary results of the analysis of archaeobotanical material retrieved during excavations at Qalhât. With the increased interest in the reconstruction of historical, environmental and economic patterns, the analysis of macroplant remains (such as seeds and charcoals) preserved in archaeological contexts has become a more active and important field of study. This discipline, known as Archaeobotany, allows collecting data on past cultures and offers insight on how agriculture changed over time. It may also provide evidence of trading systems, diet of populations and livestock, wood management and medicinal uses of plants.

The beginning of archaeobotanical researches at Qalhât offers a unique opportunity to study a period never documented so far in this part of Oman. This study will allow discussing numerous issues, such as the type of environments exploited by the local populations (existence of date palm garden, dry-cultures ?). The origins of plant products will also be discussed, considering the importance of trade at Qalhât, with Persian gulf or India, as already documented by ceramic studies.

II - Material and methods

Two methods have been used at Qalhât to recover plant remains : hand-sorting and flotation.

Hand-sorting

During previous sessions, a small part of the archaeobotanical remains has been hand-sorted directly on the field when seen. This method, although allowing the direct preservation of the remains, is inefficient because leading to different biases in macroplant assemblages. In fact, many plant remains which are very small (i. e. seeds such as fig, strawberry) or are present in low frequency are unlikely to be found by direct excavation.

A total of 18 carpological and 32 anthracological samples, all hand-sorted, has been selected for further analysis. The selected samples mainly come from B94, and in smaller proportion from B12, B13, B21 and B141.

Flotation

The other method used to recover macroremains was to sieve excavated deposit in a water bath, in order to allow the organic material to float to the surface. In order to do so, a flotation-machine was built (fig. 1).



Figure : Flotation-machine

The sediment, sampled in a wide variety of archaeological contexts, is slowly added to agitated water. By doing so, the soil, sand, and other heavy material (heavy fraction), sink on a bottom sieve (meshes : 1mm), while the less dense organic material (charred seeds, charcoals, bones) float to the surface. The material that floats to the top, called light fraction, is gathered with a sieve (meshes : 0,3mm) (fig. 2). Both fractions are then available for examination. The use of flotation often results in a real increase in the quantity and variety of botanical artifacts recovered. Moreover, flotation-derived macroplant assemblages provide more balanced collections than those collected directly in excavations.



Figure : The light fraction is gathered with a sieve

During this session, a total of 80 samples was sieved using the flotation-machine. The volume of the different sieved samples is variable, depending on the type of context sampled, and can go from 0,1 to 41 liters. Once the samples sieved, anthracological and carpological remains were sorted out, using a binocular (Nikon SMZ 1000) (fig. 3).



Figure : Binocular used for sorting out anthracological and carpological remains

III - Preliminary results

Anthracological remains

The hand-sorted samples are mostly composed of small quantities of charcoals (approximately less than 20). Such quantities are too few for a comprehensive paleoenvironmental study or propellant's husbandry reconstructions. However, some samples are composed of a sufficient number of charcoals (>100 charcoals), allowing complete studies.

The sieved samples have provided variable quantities of charcoals, depending on the volume of sediment and on the type of contexts sampled. Indeed, some of them are only composed of ashes or very small charcoals while others samples have provided more or less big charcoals in greater quantities (1mm to 5 cm).

Considering that charcoals have to be analyzed with a microscope in order to identify their species, using microanatomy, both hand-sorted and sieved samples will be sent at the UMR7209 laboratory, in Paris, for further analysis.

Carpological remains

Hand-sorted samples are mostly composed of charred cereals agglomerates, although the presence of carbonized fragment of dough will have to be confirmed. So far, the charred agglomerates seem to be composed of naked wheat (*Triticum aestivum/turgidum*) for some of them, and rice (*Oryza sativa*) for the others. The presence of such agglomerates will authorize to discuss about the existence of grain storages in B94 (species stored, type of storages, food consumption).

Among the 80 sieved samples, 43 have provided carpological remains, 33 samples coming from

B94, 8 from B21 and 2 from B12. The remains are mainly preserved by carbonization, although a few of them are preserved by mineralization, and possibly by desiccation. So far, 13 taxa have been identified, including 5 cereals (*Hordeum vulgare*, *Triticum aestivum/durum*, *Oryza sativa*, *Sorghum spec.*, *Panicum/Setaria*), 1 pulse (Fabaceae), 3 fruits (*Phoenix dactylifera*, *Vitis vinifera*, *Ziziphus nummularia/spina-christi*) and several wild taxa, not identified yet.

As for charcoals, binocular identification of carpological remains is usually carried out under a stereomicroscope, using morphological features such as shape and surface features. Identification literature as well as a comparative collection of modern plant materials are also crucial for reliable results. In order to lead a complete studies and interpretation of the carpological assemblages, they will be sent at the UMR7209 laboratory, in Paris. Further analysis will authorize to discuss about the economic status and role of the identified taxa at Qalhât.

IV - Conclusion and prospects

These first archaeobotanical investigations confirm the potential of the site concerning carpological and anthracological remains. Although a more important number of samples, greater volumes of sediment and a widest variety of contexts are needed, the first results allow establishing a preliminary list of exploited taxa and providing some element of interpretation concerning the comprehension of the site.

So far, B21 potential seems limited, at least from a carpological point of view. The function of B94 as a domestic space of life is enforced by the possible identification of grain storages and cooking spaces. The first approach led in B12 confirms the potential of the building regarding the study of food consumption, agricultural practices, trading systems and wood exploitation.

The site of Qalhât provides encouraging first elements about the history and patrimony of agriculture and food in Islamic Oman.