



**HAL**  
open science

## **Resilience after trauma: The role of memory suppression**

Alison Mary, Jacques Dayan, Giovanni Leone, Charlotte Postel, Florence Fraisse, Carine Malle, Thomas Vallée, Carine Klein-Peschanski, Fausto Viader, Vincent de la Sayette, et al.

### ► **To cite this version:**

Alison Mary, Jacques Dayan, Giovanni Leone, Charlotte Postel, Florence Fraisse, et al.. Resilience after trauma: The role of memory suppression. *Science*, 2020, 367 (6479), pp.eaay8477. 10.1126/science.aay8477. halshs-03919039

**HAL Id: halshs-03919039**

**<https://shs.hal.science/halshs-03919039v1>**

Submitted on 2 Jan 2023

**HAL** is a multi-disciplinary open access archive for the deposit and dissemination of scientific research documents, whether they are published or not. The documents may come from teaching and research institutions in France or abroad, or from public or private research centers.

L'archive ouverte pluridisciplinaire **HAL**, est destinée au dépôt et à la diffusion de documents scientifiques de niveau recherche, publiés ou non, émanant des établissements d'enseignement et de recherche français ou étrangers, des laboratoires publics ou privés.

## RESEARCH ARTICLE SUMMARY

## NEUROSCIENCE

# Resilience after trauma: The role of memory suppression

Alison Mary, Jacques Dayan, Giovanni Leone, Charlotte Postel, Florence Fraise, Carine Malle, Thomas Vallée, Carine Klein-Peschanski, Fausto Viader, Vincent de la Sayette, Denis Peschanski, Francis Eustache, Pierre Gagnepain\*

**INTRODUCTION:** One of the fundamental questions in clinical neuroscience is why some individuals can cope with traumatic events, while others remain traumatized by a haunting past they cannot get rid of. The expression and persistence of vivid and distressing intrusive memories is a central feature of post-traumatic stress disorder (PTSD). Current understanding of PTSD links this persistence to a failure to reduce the fear associated with the trauma, a deficit rooted in the dysfunction of memory. In this study, we investigated whether this deficit may additionally be rooted in the disruption of the brain system that normally allows control over memory.

**RATIONALE:** To test this hypothesis in a laboratory setting, we implemented neutral and in-offensive intrusive memories paired with a reminder cue in a group of 102 individuals exposed to the 2015 Paris terrorist attacks and in a group of 73 nonexposed individuals (i.e.,

individuals who did not experience the attacks). The exposed group was composed of 55 individuals suffering from PTSD symptoms (denoted PTSD+) and 47 individuals showing no noticeable impairment after the trauma (denoted PTSD-). We used functional magnetic resonance imaging to measure how the dorsolateral prefrontal cortex (DLPFC), a core hub of the brain control system, regulated and suppressed memory activity during the reexperiencing of these intrusive memories. We focused our analyses on both the functional and causal dependency between control and memory neural circuits during attempts to suppress the re-emergence of these intrusive memories.

**RESULTS:** In healthy individuals (PTSD- and nonexposed), attempts to prevent the unwanted emergence of intrusive memory into consciousness was associated with a significant reduction of the functional coupling between control and memory systems, compared with situations where

the reminder did not trigger such intrusion. In contrast, there was a near-absence of such a decrease in connectivity in PTSD+. Additional analyses focusing on the directionality of the underlying neural flow communications revealed that the suppression of intrusive memories in healthy individuals arose from the regulation of the right anterior DLPFC, which tuned the response of memory processes to reduce their responses. Notably, this regulation was directed at two key regions previously associated with the reexperiencing of traumatic memories: the hippocampus and the precuneus.

**CONCLUSION:** We observed a generalized disruption in PTSD of the regulation signal that controls the reactivation of unwanted memories. This disruption could constitute a central factor in the persistence of traumatic memories, undercutting the ability to deploy the necessary coping resources that maintain healthy memory. Such a deficit may explain maladaptive and unsuccessful suppression attempts often seen in PTSD. Our study suggests that the general mental operations typically engaged to banish and suppress the intrusive expression of unwanted memories might contribute to positive adaptation in the aftermath of a traumatic event, paving the way for new treatments. ■

The list of author affiliations is available in the full article online.  
\*Corresponding author. Email: pierre.gagnepain@inserm.fr  
Cite this article as A. Mary et al., *Science* 367, eaay8477 (2020). DOI: 10.1126/science.aay8477

## A Inclusion of exposed participants and task

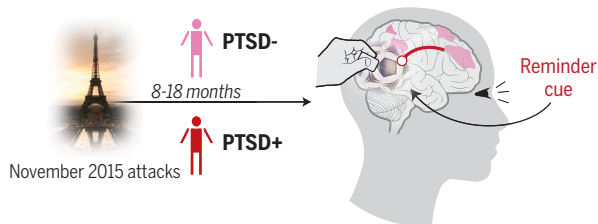

## B Brain connectivity during memory suppression

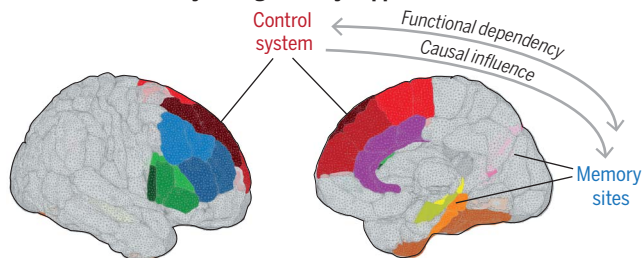

## C Functional dependency

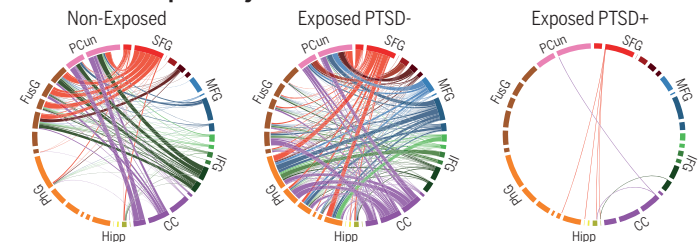

## D Causal influence

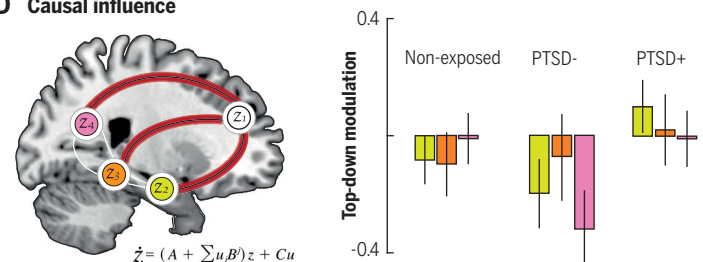

**Mechanisms of memory suppression after trauma.** (A) Exposed individuals with or without PTSD were asked to suppress the reexperiencing of neutral intrusive memories. (B) Analyses focused on the functional and causal dependencies between control and memory systems during suppression attempts. (C) Extensive decreased coupling to counteract intrusion was seen in nonexposed and PTSD- groups but not in the PTSD+ group. SFG, superior frontal gyrus; MFG, middle frontal gyrus; IFG, inferior frontal gyrus; CC, cingulate cortex; Hipp, hippocampus; PhG, parahippocampal gyrus; FusG, fusiform gyrus; PCun, precuneus. (D) This decreased coupling was mediated by top-down regulation of involuntary memory processing arising from the right DLPFC.

## RESEARCH ARTICLE

## NEUROSCIENCE

# Resilience after trauma: The role of memory suppression

Alison Mary<sup>1</sup>, Jacques Dayan<sup>1,2</sup>, Giovanni Leone<sup>1</sup>, Charlotte Postel<sup>1</sup>, Florence Fraisse<sup>1</sup>, Carine Malle<sup>1</sup>, Thomas Vallée<sup>1</sup>, Carine Klein-Peschanski<sup>3</sup>, Fausto Viader<sup>1</sup>, Vincent de la Sayette<sup>1</sup>, Denis Peschanski<sup>3</sup>, Francis Eustache<sup>1</sup>, Pierre Gagnepain<sup>1\*</sup>

In the aftermath of trauma, little is known about why the unwanted and unbidden recollection of traumatic memories persists in some individuals but not others. We implemented neutral and inoffensive intrusive memories in the laboratory in a group of 102 individuals exposed to the 2015 Paris terrorist attacks and 73 nonexposed individuals, who were not in Paris during the attacks. While reexperiencing these intrusive memories, nonexposed individuals and exposed individuals without posttraumatic stress disorder (PTSD) could adaptively suppress memory activity, but exposed individuals with PTSD could not. These findings suggest that the capacity to suppress memory is central to positive posttraumatic adaptation. A generalized disruption of the memory control system could explain the maladaptive and unsuccessful suppression attempts often seen in PTSD, and this disruption should be targeted by specific treatments.

The expression and persistence of vivid, uncontrollable, and distressing intrusive memories is a central feature of post-traumatic stress disorder (PTSD) (1–5). After a traumatic event, attempts to suppress or avoid traumatic memories sometimes paradoxically increase the expression of intrusive memories (6–8). Successful treatments of intrusive memories involve overcoming such avoidance and suppression, as well as bringing back elements of the traumatic memory to promote its extinction or updating by the integration of a safe context (2, 5, 9, 10). These treatments are in line with current neurobiological models that link PTSD to a learning impairment together with a deficit in processing contextual reminders in the fear circuit (11–15).

Theories of PTSD implicate experiential avoidance of traumatic memories via thought suppression as detrimental and central to the maintenance of intrusion symptoms (2, 16–19). Experiential avoidance is mediated by the tonic maintenance of the to-be-avoided mental image in mind and by the engagement of a reactive inhibitory control process suppressing the momentary awareness of that unwanted thought (20, 21). The former explains the paradoxical and maladaptive persistence of suppressed thoughts in memory and is exacerbated in PTSD (22, 23). The latter, however, ultimately leads to forgetting of the suppressed event in healthy individuals (24–31).

Asking people to suppress awareness of a memory triggered by a reminder cue, without appealing to that memory, can impair its later conscious recall (30, 31), unconscious expression (27, 32, 33), or emotional response (34, 35). Memory suppression engages control mechanisms implemented by the frontoparietal network (25–30). Suppressing memory retrieval reduces activity over an extended network (25–29, 34, 36–38). Neurobiological models of motivated forgetting (31, 39–41) assume that inhibitory control of memory awareness adaptively suppresses memory processing once retrieval cues have triggered interfering activity associated with unexpected intrusions. Suppression of hippocampal activity increases when unwanted memories intrude into awareness and need to be purged reactively (34, 36, 37). The central mechanisms associated with memory suppression are manifested as a negative influence of the right dorsolateral prefrontal cortex (DLPFC), especially the anterior middle frontal gyrus (MFG), over brain areas supporting the reactivation of memories (26, 27). Such top-down suppression increases to adaptively counteract and regulate intrusion involuntarily emerging into a person's awareness (34, 36).

Alteration of these inhibitory control mechanisms could represent a potentially critical mechanism underlying intrusive symptoms in PTSD that contributes to adverse outcomes. Thus, the perseveration of intrusive memories in PTSD after suppression attempts may arise from the existence of a compromised and ineffective memory control system. Disruption of the system controlling memories undercuts the ability to deploy the otherwise necessary coping skill of suppression. Any attempt to regulate and suppress intrusive memories is therefore doomed to failure and reflects futile

efforts to slam on a faulty brake. This hypothesis receives support from behavioral and neural evidence for inhibitory control deficits in PTSD (42–47).

In this study, we measured the connectivity between the control system and memory circuits using functional magnetic resonance imaging (fMRI) in 102 exposed and 73 nonexposed individuals of the 13 November 2015 Paris terrorist attacks (see materials and methods for type of traumatic exposure, “nonexposed” meaning not present in Paris), while they attempted to suppress neutral and inoffensive intrusive memories implemented in the laboratory (Fig. 1B). Trauma-exposed participants (see table S1 for demographic and clinical characteristics) were divided into two groups: one group with full or partial symptomology of PTSD (48) according to current *Diagnostic and Statistical Manual of Mental Disorders (DSM-5)* criteria ( $n = 55$  individuals), and one group without PTSD ( $n = 47$  individuals; see Fig. 1A and the materials and methods section). After learning word-object pairs, participants tried to stop the memory of the object from entering their awareness (“no-think”) during the think/no-think (TNT) phase (Fig. 1B), which also included trials for which they had to recall the associated object (“think”). If the object came to mind anyway during suppression attempts, they were asked to push it out of mind and to report after the end of the trial that the reminder elicited awareness of its paired object (37), allowing us to isolate when no-think trials triggered intrusions.

## Behavioral performances

In healthy individuals, intrusion decreases with repeated suppression of unwanted memory retrieval (34, 36, 37). Participants' control over intrusions improved across suppression repetitions in all three groups (Fig. 1C). A group times repetition analysis of variance (ANOVA) on participants' intrusion reports for no-think trials revealed a robust reduction in intrusion proportion with repetition [ $F_{7,1204} = 30.3, P < 0.001$ ]. Repeated suppressions reduced intrusions comparably for all three groups (group times repetition interaction was not significant) [ $F_{14,1204} = 0.46, P = 0.95$ ], and the overall proportion of intrusion did not differ between groups [ $F_{2,172} = 2.1, P = 0.125$ ].

After the TNT phase, we tested how easily participants could identify the objects amid visual noise. The amount of priming was reduced for no-think objects that were identified more slowly than objects from the baseline condition in nonexposed [ $t_{72} = 1.96, P = 0.027$ ] and exposed non-PTSD [ $t_{46} = 1.73, P = 0.045$ ] participants (see table S2 for mean reaction times and standard deviations). When objects reappeared in their visual world, participants found it harder to perceive suppressed objects than other recently encountered objects. This

<sup>1</sup>Normandie Université, UNICAEN, PSL Research University, EPHE, INSERM, U1077, CHU de Caen, GIP Cyceron, Neuropsychologie et Imagerie de la Mémoire Humaine, 14000 Caen, France. <sup>2</sup>Pôle Hospitalo-Universitaire de Psychiatrie de l'Enfant et de l'Adolescent, Centre Hospitalier Guillaume Régner, Université Rennes 1, 35700 Rennes, France. <sup>3</sup>Université Paris I Panthéon Sorbonne, HESAM Université, EHES, CNRS, UMR8209, 75231 Paris, France. \*Corresponding author. Email: pierre.gagnepain@inserm.fr

## A Inclusion of exposed participants

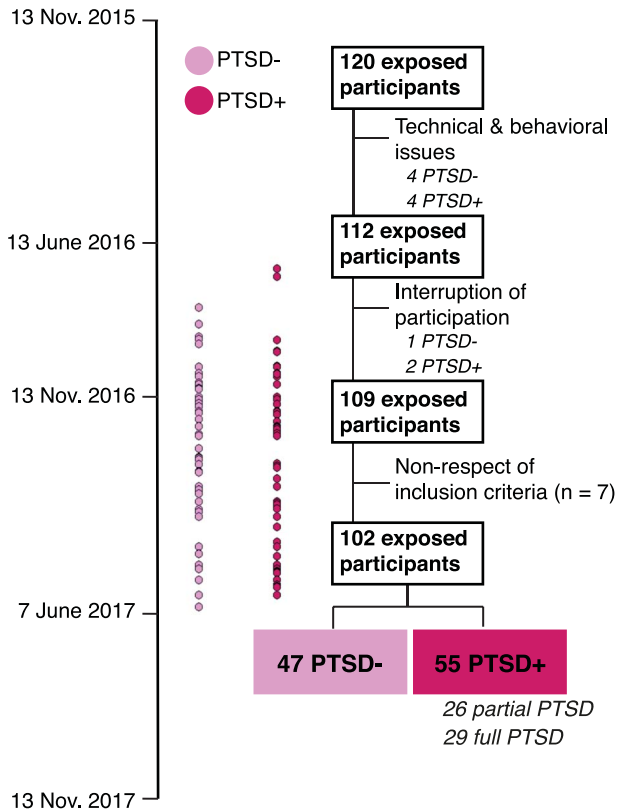

## B Experimental procedure

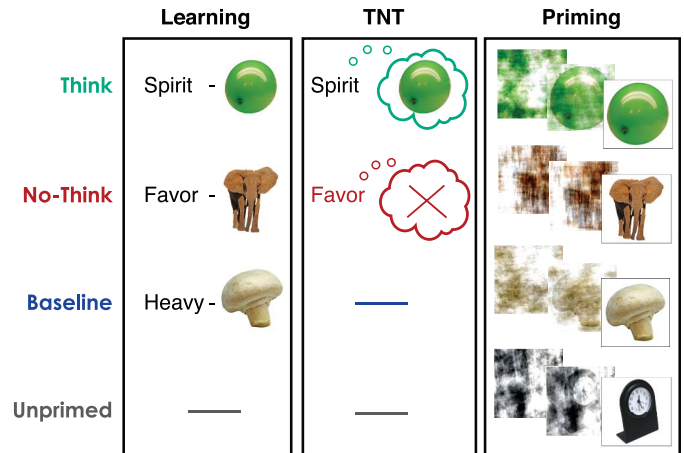

## C Intrusion proportion across suppression attempts

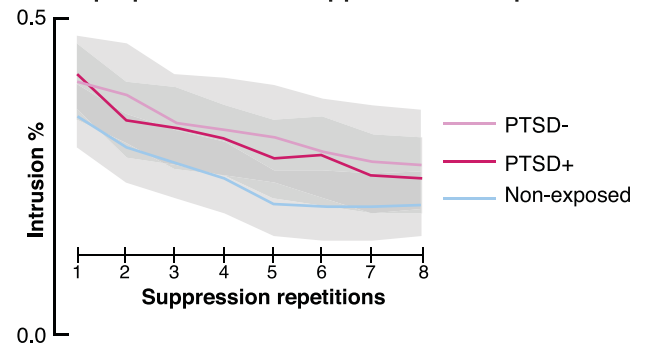

**Fig. 1. Experimental design.** (A) Timeline and procedure of inclusion of the participants exposed to the 13 November 2015 Paris terrorist attacks. The dates of the first and last inclusion are 13 June 2016 and 7 June 2017, respectively. Participants with a similar degree of exposure were diagnosed as non-PTSD or PTSD. (B) After learning word-object pairs, participants underwent fMRI scanning as they performed the think/no-think (TNT) task. For think items (in green), participants recalled a detailed visual memory of the associated picture. For no-think items (in red), they were asked to prevent the picture from entering

awareness. After no-think trial cues ended, participants reported the presence or absence of intrusive memories that further trigger reactive inhibitory process. At the behavioral level, the effect of suppression was measured using a perceptual identification task including novel unprimed objects. (C) Intrusion proportions (i.e., the proportion of trials in which the associated memory entered into awareness on no-think trials) as measured by our trial-by-trial intrusion report measure (see materials and methods) over the eight suppression attempts of the TNT phase. Shaded error bands represent 95% bootstrapped confidence intervals.

reduction of priming effect after memory suppression was not found in the PTSD group [ $t_{54} = -0.84, P = 0.4$ ], and the magnitude of this effect was significantly larger for the non-PTSD [ $t_{100} = 1.85, P = 0.033$ ] and nonexposed [ $t_{26} = 1.95, P = 0.027$ ] groups compared with the PTSD group, as shown by two-sample  $t$  tests. This difference could not be explained by a difference in training. Our procedure carefully matched learning of word-object associations, and no group differences emerged in the final criterion test before TNT procedure (correct recall: nonexposed, 93%; non-PTSD, 90%; and PTSD, 92%). Suppression-induced forgetting of explicit memories is impaired in PTSD (44). Our findings extend this deficit to perceptual implicit memory.

## Brain activity

We first contrasted whole-brain activity of no-think and think trials. For all three groups, we

observed the engagement of the right frontoparietal control network (FPCN) and the disengagement of visual and medial temporal lobe (MTL) areas during retrieval suppression (fig. S1 and table S3). No noticeable differences were seen between non-PTSD and PTSD groups. We observed, however, a significant interaction when the trauma-exposed group with PTSD was compared to the nonexposed group. This interaction was observed using family-wise error (FWE) rate correction when the search volume was restricted to the FPCN (no-think greater than think contrast) and was driven by a greater engagement of the right superior frontal gyrus in the nonexposed group [Montreal Neurological Institute (MNI) coordinates:  $x = 16, y = 36, z = 56; Z = 4.34, P_{FWE-FPCN} = 0.002$ ]. It is unclear whether the ability to modulate and engage this region is disrupted by the existence of PTSD, or by trauma exposure rather than PTSD (49). This interaction might also

reflect the daily engagement of trauma-exposed individuals in memory control processes and some form of habituation. Cortical thickness increases in a similar region after exposure to trauma, an effect that could potentially be related to experience-induced plasticity and habituation (50).

We next sought to examine whether people's ability to suppress intrusive memories depends on the engagement of the FPCN (34). The overall proportion of intrusions was entered into a regression model predicting the up-regulation of the control network during intrusion versus nonintrusion. The up-regulation of the frontoparietal network was associated with a reduced intrusion frequency in both the nonexposed and non-PTSD groups (fig. S2). This relationship, however, was not observed in the exposed group of participants with PTSD.

Previous studies have observed more pronounced down-regulation of hippocampal



activity during retrieval suppression when memories involuntarily intrude into consciousness compared with when they do not (34, 36, 37). Although we observed a suppression-induced reduction of bilateral hippocampal activity in all three groups (nonexposed: [ $t_{72} = 4.78, P < 0.001$ ]; non-PTSD: [ $t_{46} = 6.8, P < 0.001$ ]; PTSD: [ $t_{54} = 5.67, P < 0.001$ ]), no additional modulation was caused by the elevated control demand associated with intrusions (all  $P > 0.25$ ) (fig. S3A). We did find more pronounced suppression of hippocampal activity in response to intrusion in all three groups (fig. S3B), but only when an adaptive volume restricted to the most significant contiguous voxels associated with the main effect of suppression was used (34). Outside the hippocampus, the suppression of intrusion in the two exposed groups, but not in the nonexposed group, was associated with a decrease over the lateral and posterior regions of the visual system (tables S5 to S7). However, no interaction between groups was observed. No noticeable differences in suppression strategy were observed between groups (fig. S4) (see materials and methods).

### Functional connectivity

Next, we investigated the pattern of functional connectivity between the inhibitory control network and memory areas for the three groups (see materials and methods) (Fig. 2A and table S8). For the control network, we focused on the right-lateralized DLPFC (25–30), as well as the anterior cingulate cortex for its presumed role of relay in the DLPFC-hippocampal pathway (41). For the memory network, we included bilateral regions known to be modulated by inhibitory control mechanism and reflecting different memory domains (25–30, 34, 36, 37).

We used a general linear regression model (GLM) and generalized psychophysiological interaction (gPPI) (51) to estimate task-dependent functional connectivity (between each pair of control-memory regions) across this broad network, while controlling for task-based activation and task-independent (i.e., physiological) functional connectivity. PPI was conducted with the inhibitory control network as seeds (i.e., independent variable of the regression model) and memory-related sites as target regions (i.e., dependent variable). We first characterized TNT-dependent functional connectivity changes for each group separately, focusing on significant changes between intrusion and nonintrusion. Inhibitory control models predict that intrusions will generate more negative coupling between frontally mediated control processes and memory regions (31, 40, 41). In the context of the current PPI analysis, this process would manifest as decreased connectivity during intrusion relative to nonintrusion. For both nonexposed and

exposed non-PTSD groups, attempts to prevent the unwanted emergence of intrusive memory into consciousness were associated with a significant reduction in functional connectivity compared with nonintrusion in a broad network (Fig. 2B). These changes were characterized by a decrease in connectivity during intrusion (compared with nonintrusion) between an extensive frontal network and the parahippocampal gyrus, hippocampus, fusiform gyrus, and precuneus. When memories intruded awareness and needed to be purged, there was a near-absence of such a decrease in the connectivity in the exposed PTSD group (Fig. 2B).

However, these analyses did not formally establish that healthy and PTSD participants rely on different processes to suppress memory, which requires demonstrating the presence of a significant pattern of interaction between memory awareness (i.e., intrusive versus nonintrusive memories) and the groups. We thus focused on the connectivity changes between the right anterior MFG and memory regions (see materials and methods and Fig. 2A). The right anterior MFG region is critical for inhibitory control in a variety of cognitive task contexts (28) and inhibitory regulation of conscious awareness for unwanted memories (25–30, 34, 36). After computing the difference in connectivity between intrusion and nonintrusion, we looked at the connectivity separately for each target region and hemisphere to identify which memory processing was preferentially targeted by inhibitory control, controlling for the expected proportion of type I error across multiple regions of interest (ROIs) using the false discovery rate (FDR) correction. Two-sample  $t$  tests showed that the reduction in connectivity for intrusion compared with nonintrusion was significantly greater for exposed participants without PTSD than for the PTSD group in the right rostral hippocampus [ $t_{100} = -1.9, P_{\text{FDR}} = 0.043$ ]; the left [ $t_{100} = -4.09, P_{\text{FDR}} = 0.0004$ ] and right [ $t_{100} = -2.24, P_{\text{FDR}} = 0.023$ ] parahippocampal gyrus; the left [ $t_{100} = -2.3, P_{\text{FDR}} = 0.02$ ] and right [ $t_{100} = -3.27, P_{\text{FDR}} = 0.004$ ] fusiform gyrus; and the left [ $t_{100} = -2.71, P_{\text{FDR}} = 0.011$ ] and right [ $t_{100} = -2.69, P_{\text{FDR}} = 0.011$ ] precuneus. These differences were driven by significant decreases in connectivity for intrusive relative to nonintrusive memories in the non-PTSD group, as revealed by one-sample  $t$  tests (Fig. 3 and tables S9 and S10). These decreases were absent in the PTSD group (all  $P_{\text{FDR}} > 0.2$ ) or reversed with an up-regulation in the left parahippocampal gyrus [ $t_{54} = 2.91, P = 0.026$ ] and the right fusiform gyrus [ $t_{54} = 2.44, P = 0.045$ ]. These latter effects in the PTSD group became marginal after FDR corrections ( $P_{\text{FDR}} = 0.053$  and  $0.09$ , respectively). The differences in connectivity seen for the non-PTSD group compared with the PTSD group were inde-

pendent of type or duration of traumatic exposure, age, sex, education, or medication (table S11).

The pattern of results was less clear-cut for the nonexposed control group. We observed significant reduction in connectivity during intrusions compared with nonintrusion in the left [ $t_{72} = -2.37, P = 0.01$ ] and right [ $t_{72} = -2.64, P = 0.005$ ] precuneus that became a trend after FDR correction for multiple comparisons ( $P_{\text{FDR}} = 0.051$ ). We also observed in the nonexposed control group a trend in the right rostral hippocampus [ $t_{72} = -1.496, P = 0.07$ ] that did not survive FDR correction for multiple comparisons. When compared with the PTSD group, nonexposed control participants had a significantly greater reduction in connectivity for intrusion versus nonintrusion in the left parahippocampal gyrus [ $t_{126} = -1.76, P = 0.04$ ]; the left [ $t_{126} = -1.76, P = 0.04$ ] and right [ $t_{126} = -2.07, P = 0.02$ ] fusiform gyrus; the left [ $t_{126} = -2.71, P = 0.003$ ] and right [ $t_{126} = -2.31, P = 0.01$ ] precuneus; and showed a trend in the right rostral hippocampus [ $t_{126} = -1.5, P = 0.068$ ]. After FDR corrections, only the difference for the left precuneus was significant ( $P_{\text{FDR}} = 0.038$ ), the difference for the right rostral hippocampus did not survive to correction ( $P_{\text{FDR}} = 0.1$ ), and the differences in the other regions became marginal ( $P_{\text{FDR}} > 0.056$ ) (table S10). After an additional analysis controlling for age, sex, education, and medication, using FDR correction for multiple comparisons, the difference between the nonexposed and PTSD groups remained significant in the left precuneus (table S11). It is often observed that a healthy population is composed of a mixture of people with good and poor control abilities, as reflected in distinct connectivity profiles (27, 34, 36). Furthermore, it is possible that nonexposed individuals continuously engaged the anterior MFG to suppress memory activity regardless of whether an intrusion was present.

### Active versus resting-state connectivity

Inhibitory control models predict that memory suppression will generate more negative coupling between frontally mediated control processes and memory regions. Although this would manifest as decreased connectivity during intrusion relative to nonintrusion in PPI analysis, our design does not allow us to estimate absolute change in connectivity for isolated conditions (see materials and methods).

We therefore compared isolated indexes of task-dependent connectivity for each condition to a resting-state session collected after the TNT task. This approach relied on blind deconvolution to detect spontaneous event-related changes in the resting-state signal (52). From these pseudo-events, a gPPI regression model was recreated with parameter estimates

quantitatively comparable to TNT-dependent connectivity estimates (see materials and methods). Using these estimates of resting-state connectivity as a baseline, we found an active reduction in coupling between an extended

right DLPFC network and memory areas in reaction to intrusions for both nonexposed and non-PTSD groups (fig. S5). The PTSD group exhibited a similar decrease in the DLPFC-to-memory system connectivity but mostly during

nonintrusion trials. Notably, the nonexposed group also exhibited a reduction in connectivity during nonintrusion trials, in line with the idea that this group suppressed memory activity regardless of the presence or absence

**A Control and memory target regions of interest**

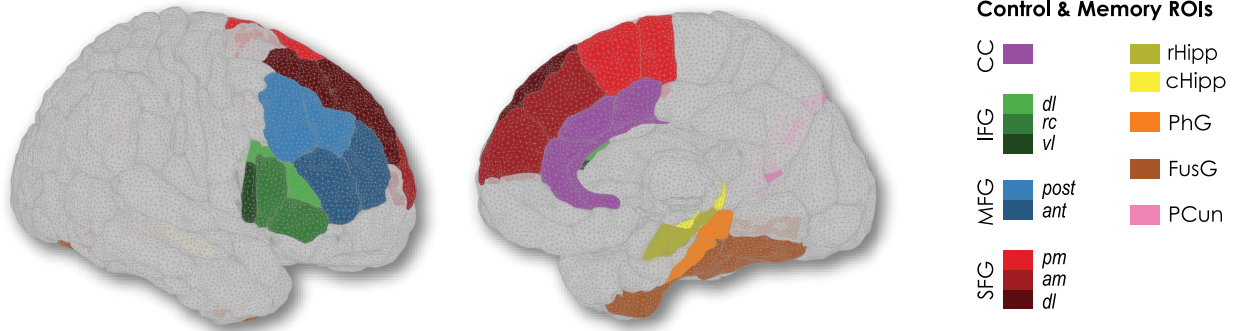

**B Functional down-regulation of intrusive against non-intrusive memories**

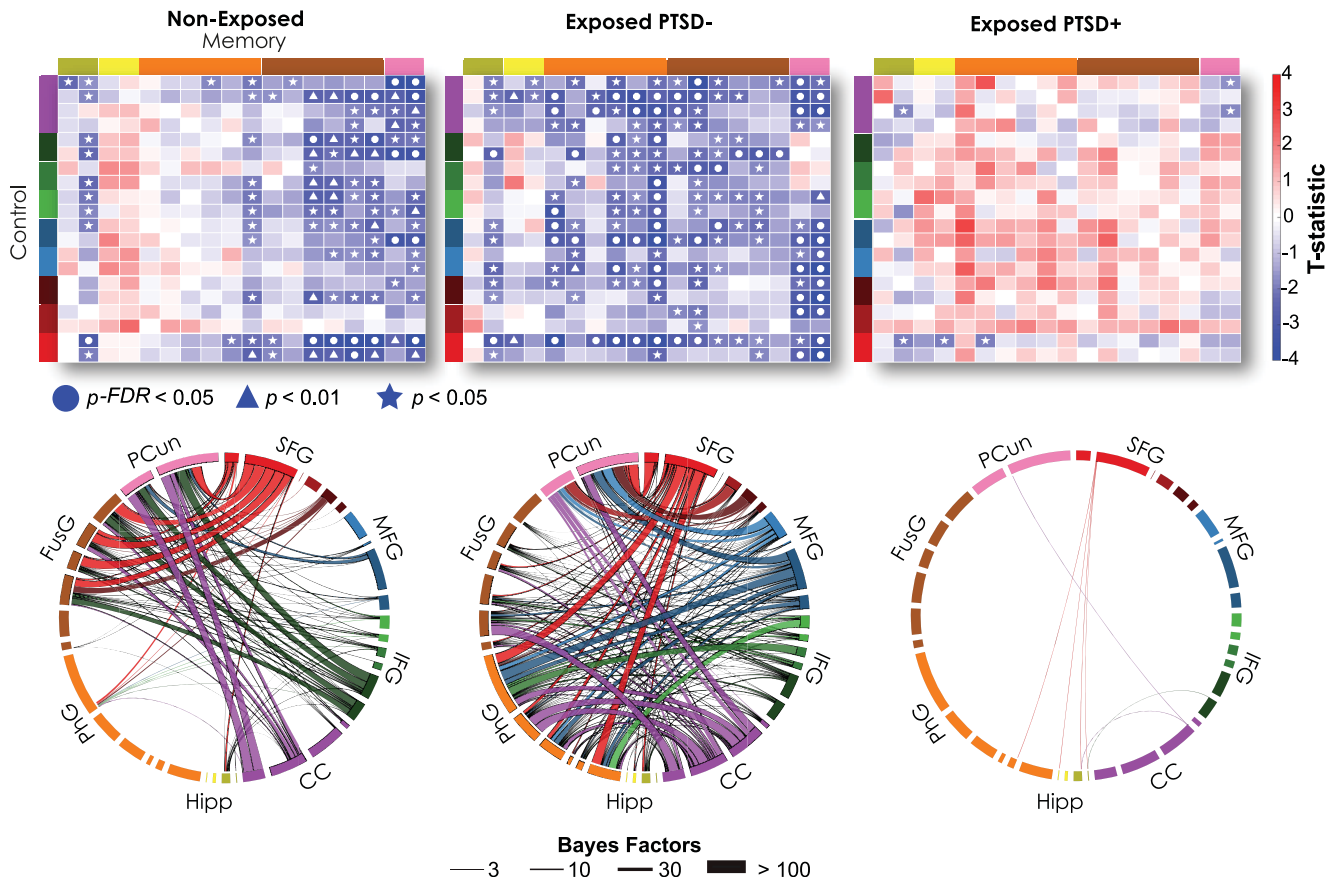

**Fig. 2. Decrease in functional connectivity during suppression of intrusive memories between control and memory brain regions.** (A) Suppression-induced functional connectivity was analyzed between prefrontal control (seed) and memory (target) regions of interest (ROIs). The control and memory target ROIs are represented as shown in the color key on the right. (B) The contrast between intrusion and nonintrusion shows an extensive decrease in connectivity for both the nonexposed and non-PTSD groups. The matrices represent connectivity changes (*t*-statistic) in each group, between the ROIs of the control and memory systems. Circles, triangles, and stars in the matrices represent significant changes in connection at  $P_{FDR} < 0.05$ ,  $P < 0.01$ , and

$P < 0.05$ , respectively. In the circular connectograms, the colors of the edges are defined by the prefrontal control ROIs that predicted activity of memory sites in the gPPI model [color key in (A) applies here]. The size of the edges reflects the Bayes factors for connections associated with a significant decrease in connectivity during the regulation of intrusive compared with nonintrusive memories. SFG, superior frontal gyrus; MFG, middle frontal gyrus; IFG, inferior frontal gyrus; CC, cingulate cortex; Hipp, hippocampus; rHipp, rostral hippocampus; cHipp, caudal hippocampus; PhG, parahippocampal gyrus; FusG, fusiform gyrus; PCun, precuneus; pm, posterior medial; am, anterior medial; post, posterior; ant, anterior; dl, dorsolateral; rc, rostrocaudal; vl, ventrolateral.

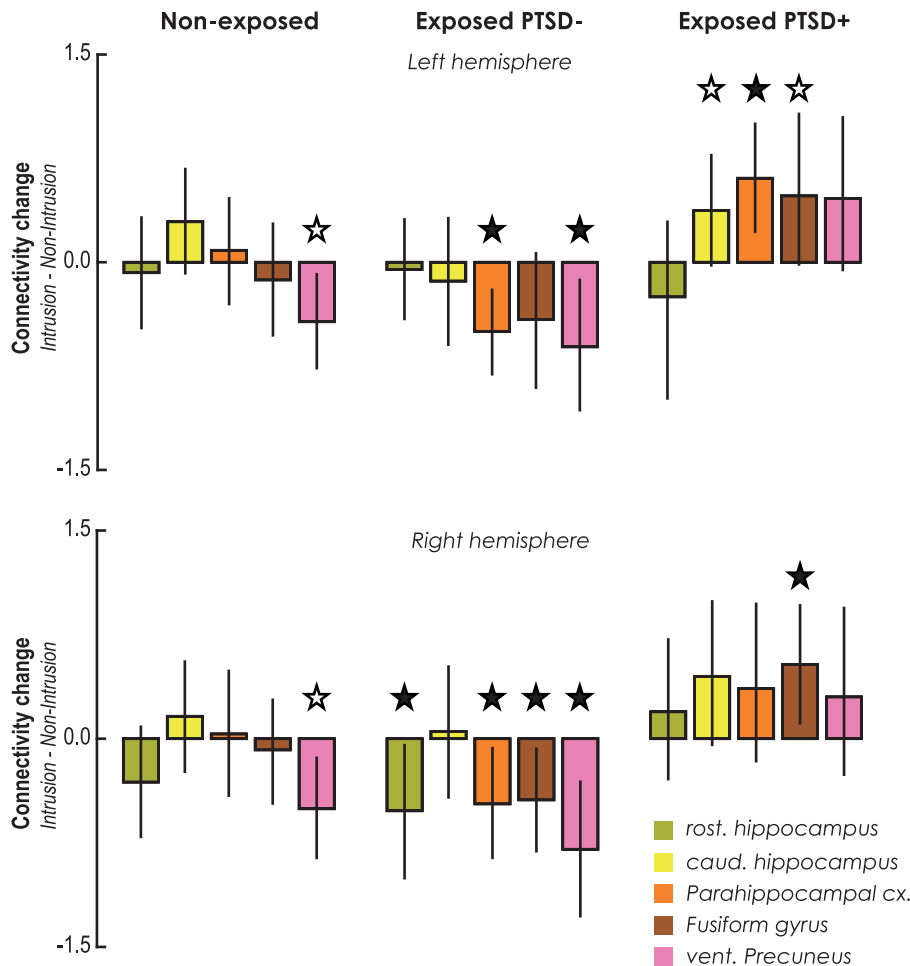

**Fig. 3. Connectivity modulation between right anterior MFG and memory systems during memory suppression.** Connectivity differences during the suppression of intrusive versus nonintrusive memories, between the right anterior MFG (seed) and target memory regions in the left (top panel) and right (bottom panel) hemispheres. Error bars reflect 95% bootstrapped confidence intervals and indicate significance when they do not encompass zero. Black and white stars indicate  $P_{FDR} < 0.05$  and  $P < 0.05$ , respectively. rost., rostral; caud., caudal; cx., cortex; vent., ventral.

of intrusion. Focusing this analysis on the right anterior MFG revealed that the connectivity with memory sites, including the hippocampus, was reduced actively during intrusion in both non-PTSD and nonexposed groups (Fig. 4; see tables S12 and S13 for details on statistics). Such active reduction in connectivity was also found during non-intrusion trials in the left and right fusiform gyrus and right caudal hippocampus for the nonexposed group, as well as in the left parahippocampal gyrus and right fusiform gyrus for the exposed PTSD group (although these effects did not survive correction for multiple comparisons across tested memory areas). In the non-PTSD group, the decreased connectivity induced by memory suppression between control and memory systems reflected an active process that increased when intrusive memories arose into consciousness and needed to be purged. Also, no active differences

in connectivity were found when reminder cues did not trigger intrusion in this group. These findings fit well with current neurobiological models of motivated forgetting (39–41), which propose that inhibitory control of memory adaptively increases to suppress memory processing once retrieval cues unexpectedly trigger interfering intrusive activity.

#### Top-down versus bottom-up connectivity

We used dynamic causal modeling (DCM) to analyze top-down and bottom-up influences separately during attempts to down-regulate intrusive memory. Because DCM is limited to a restricted number of nodes, we designed simple four-node DCM models to study the change in connectivity between the right anterior MFG on one hand, and the right rostral hippocampus, parahippocampal cortex, and precuneus on the other hand. We estimated seven models, reflecting possible differences in coupling between

intrusion and nonintrusion trials (Fig. 5A), as well as an additional model without modulation (see materials and methods).

All three groups showed strong evidence for the presence of suppression-induced modulation of the connectivity between the right MFG and memory systems (see materials and methods). We used Bayesian model averaging (BMA) to weight the change in coupling parameters according to posterior model evidence across all seven possible combinations of modulation between MFG and memory targets (Fig. 5B). Down-regulation of intrusive memory activity in the rostral hippocampus was mediated by a top-down modulation (M) of the right anterior MFG in non-PTSD participants [ $M = -0.198$ ; posterior probability (PP) = 0.997; 95% confidence interval (CI) =  $[-0.32, -0.08]$ ] and nonexposed participants ( $M = -0.083$ ; PP = 0.95; 95% CI =  $[-0.16, -0.0001]$ ). Critically, such top-down modulation of involuntary memory processing in the rostral hippocampus was absent in the PTSD group, which exhibited the reversed pattern characterized by a greater decrease in MFG-to-hippocampus coupling during nonintrusion ( $M = 0.10$ ; PP = 0.965; 95% CI =  $[0.009, 0.19]$ ). Significant group-differences ( $\Delta$ ) between the PTSD group and both the non-PTSD ( $\Delta = -0.30$ ; PP = 0.999; 95% CI =  $[-0.45, -0.15]$ ) and nonexposed ( $\Delta = -0.18$ ; PP = 0.95; 95% CI =  $[-0.31, -0.06]$ ) groups were seen on top-down coupling parameters between the right MFG and rostral hippocampus. The non-PTSD group also showed a strong down-regulation of the precuneus ( $M = -0.30$ ; PP = 0.999; 95% CI =  $[-0.45, -0.15]$ ), an effect that was much stronger than the one seen in both PTSD ( $\Delta = -0.31$ ; PP = 0.999; 95% CI =  $[-0.49, -0.15]$ ) and nonexposed ( $\Delta = -0.32$ ; PP = 1.0; 95% CI =  $[-0.48, -0.16]$ ) groups. The differences in top-down connectivity seen for the non-PTSD group compared with the other two groups was independent of type or duration of traumatic exposure, age, sex, education, or medication (table S14).

#### A general deficit in the inhibitory control of intrusive memories in PTSD

Current models of PTSD link the persistence of intrusive memories to a failure of the extinction or updating of the original traumatic memory traces while in a safe environment, together with an abnormal and exaggerated processing of contextual reminder of the trauma in the fear circuit (11–15). These disruptions involve the dysfunction of the hippocampus-amygdala complex and its interaction with the medial prefrontal cortex. Our findings suggest that PTSD is also characterized by a deficit in the top-down suppression of momentary awareness associated with intrusive memories. This deficit could constitute a central factor in the persistence of traumatic memories, undercutting the ability to deploy



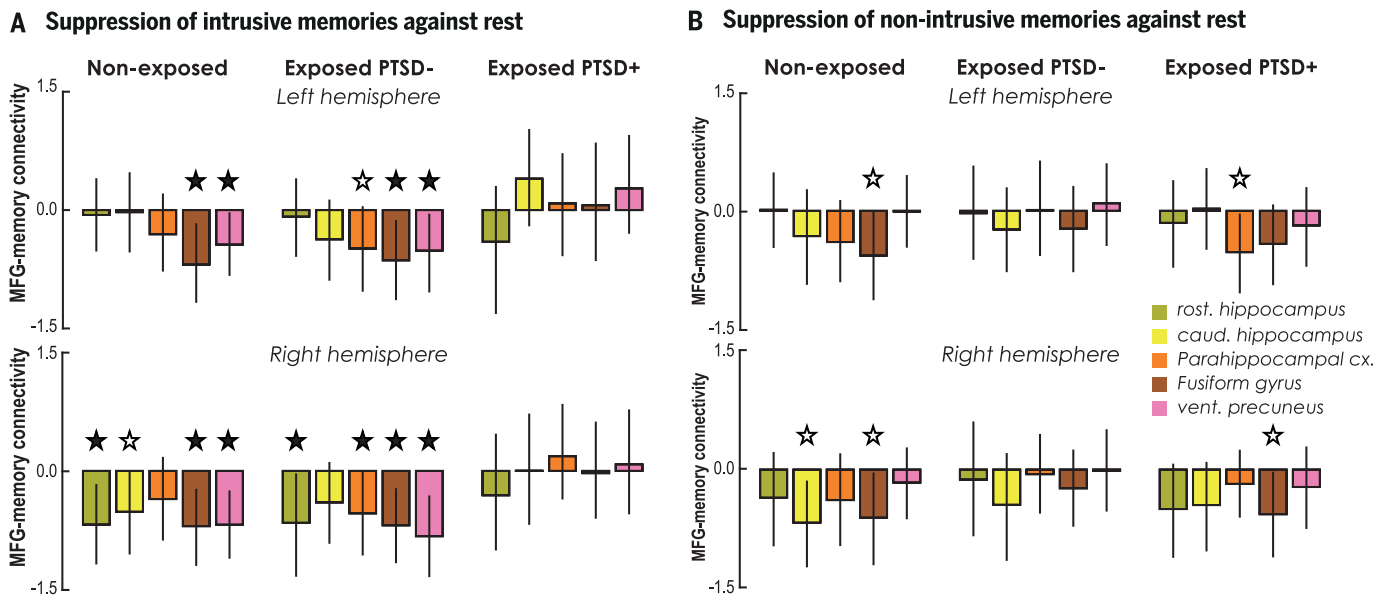

**Fig. 4. Suppression-induced connectivity against rest.** Connectivity differences induced by the suppression of intrusive (A) and nonintrusive (B) memories against a resting-state baseline, using the right anterior MFG as seed and memory regions as targets. Error bars reflect 95% bootstrapped confidence intervals and indicate significance when they do not encompass zero. Black and white stars indicate  $P_{FDR} < 0.05$  and  $P < 0.05$ , respectively.

the necessary coping resources that maintain a healthy memory.

In trauma-exposed individuals without PTSD, the functional connectivity between prefrontal areas involved in control and memory sites, including the hippocampus and precuneus, decreased during the regulation of intrusive memory compared with nonintrusion. This decrease in connectivity was also seen in comparison to a resting-state baseline, suggesting that changes in connectivity induced by the suppression of intrusion relied on an active modulation. Analysis of effective connectivity showed that a top-down process mediated these modulations in non-PTSD, and that this effect was accentuated compared with PTSD. The current findings are consistent with the existence of an inhibitory signal that interrupts the reactivation of unwanted memory traces in memory systems (29, 34). Such inhibitory control was preserved in resilient individuals but disrupted in people who developed PTSD.

The intrusive memories created in the current experiment are completely different from the distressing, fragmented, and decontextualized traumatic intrusions seen in PTSD (1–5). However, common features that are central to PTSD symptomatology also exist and can be modeled and isolated using the TNT paradigm. Both types of intrusions are involuntary, unintended, composed of sensory impressions, and triggered by unrelated contextual cues weakly related to the memory content (2). Neutral memories completely unrelated to the traumatic event also put exposed and nonexposed individuals on equal footing regarding the control demand associated with memory intrusion. Moreover, the regulation of neutral

and emotional memories is probably achieved by the same core control system (25, 28, 34). Our findings thus highlight the presence of a central and general disruption of the down-regulation function of the anterior DLPFC in PTSD, disrupting the control and suppression of involuntarily intruding memories, even when those memories are neutral, artificially created, equated in strength during learning, and completely unrelated to the traumatic event.

Suppressing memories is often assumed to be unwise because the undesired remnants will backfire (2, 6–8, 16–19). Rather than being the root of intrusive symptoms, our findings suggest that maladaptive and unsuccessful suppression attempts are a consequence of a compromised control system. Such disruption may prevent adaptive forgetting processes (31) that normally alter memory stabilization in the hippocampus (38) and might therefore prevent the impairment of the traumatic engram. Furthermore, alteration of control capacity can further cascade into an exaggerated avoidance of reminders of the trauma. Unlike memory suppression, avoidance of reminders prevents modulation of traumatic representations via inhibitory control (53), extinction, or updating (13–15). Disrupted inhibitory control processes could accentuate the imbalance between memory suppression and avoidance strategies, which reflect the same goal of keeping the trauma memory out of awareness but have opposite consequences on mental health.

#### Inhibitory control: Resilience or vulnerability to PTSD?

Do such inhibitory control mechanisms engaged during memory suppression reflect a

preexisting resilience factor, some form of positive and dynamic adaptation after exposure to a traumatic event, a preexisting vulnerability factor, or sequelae exacerbated by chronic stress (54)? Previous studies on memory suppression in healthy individuals provide some arguments in favor of the existence of a preexisting factor to combat or adequately resist the stress induced by traumatic revisitation. Individuals with better engagement of the control system experience fewer memory intrusions (34, 36), greater disruption of perceptual memory (27), and greater forgetting (25, 26, 28–30, 36, 37). Lower attentional control capacities (55) or deficient retrieval suppression (56) are potential risk factors for the development of intrusive memories after emotional films.

Memory control mechanisms may also adapt after exposure to stressful events to overcome traumatic experiences (53), illustrating a form of acquired resilience. The stronger top-down suppression of the ventral precuneus observed in trauma-exposed individuals without PTSD compared not only with individuals with PTSD but also nonexposed individuals is interesting in that respect. The precuneus seems central to the representation of sensory and mental images of the trauma (57–59), disconnected from contextual representations in the hippocampus (1). Suppression of the precuneus is compatible with recent findings suggesting that new memory engrams can be rapidly encoded (60) and updated (61) into this region. The coordinate suppression of intrusive memories across the precuneus and hippocampus, which we observed specifically in resilient individuals,



## A Modulation pathways

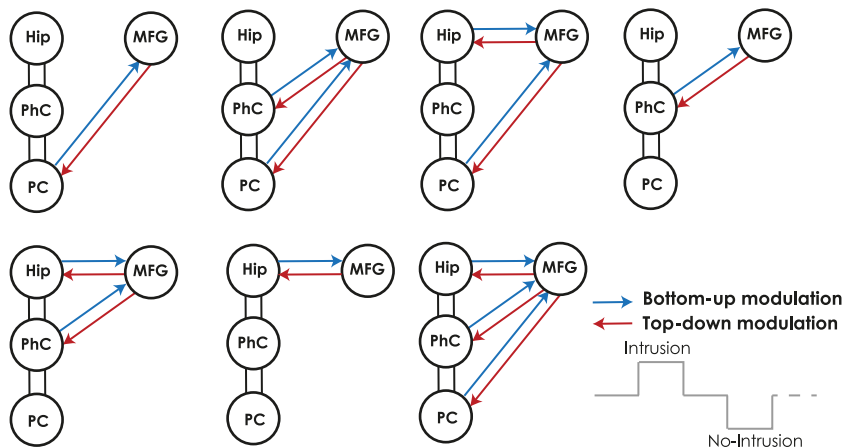

## B Bayesian model averaging

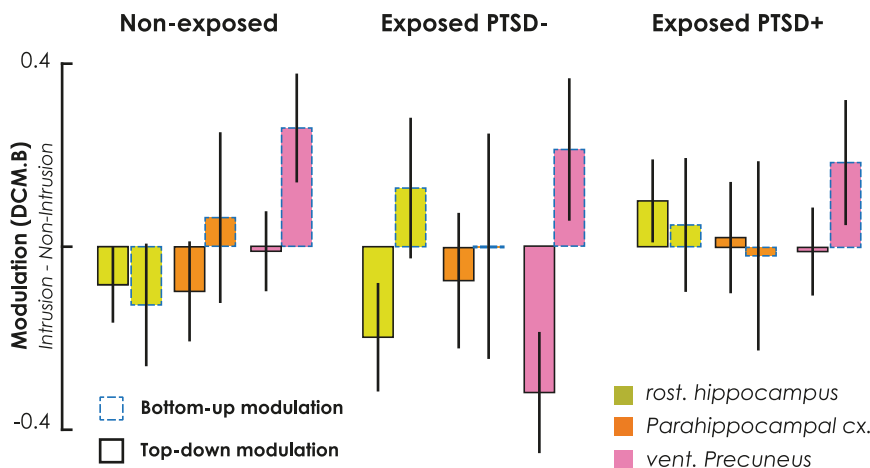

**Fig. 5. DCM model space and coupling parameters.** (A) Bottom-up and top-down influences between the right anterior MFG and memory regions during suppression attempts were measured across seven DCM models capturing different connection pathways. The modulatory input acting on these connections reflected the difference in coupling between intrusive and nonintrusive memories. Memory target regions included rostral hippocampus (Hip), parahippocampal cortex (PhC), and precuneus (PC). (B) Bayesian model averaging across model space of the top-down and bottom-up modulatory parameters. Error bars reflect 95% confidence intervals and indicate significance when they do not encompass zero.

might therefore be crucial to cope with traumatic events.

The disruption of memory control mechanisms seen in PTSD might also reflect a form of acquired vulnerability in PTSD or a preexisting vulnerability of inhibitory mechanisms. Stress can impair executive functioning (62), including cognitive control (63). Animal models propose that excessive and repeated stress damages GABAergic interneurons in the hippocampus (64), a neurotransmitter which potentially mediates the inhibitory effect associated with memory suppression (29, 41) and whose receptor population is disrupted after trauma (65). Similarly, an alteration of the white-matter tracts that propagate the inhibitory command (66)

could also prevent this effect from taking place in individuals with PTSD.

### Treating mechanisms of suppression?

The cross-sectional study described here does not provide insight into the origin of the observed memory suppression deficit seen in PTSD. However, it provides important information concerning the role of memory suppression mechanisms for understanding and treating the development of PTSD. Most of the current recommended psychotherapeutic treatments for PTSD focus on the traumatic experience and involve, to some degree, a reexposure to the traumatic content, which can sometimes be problematic in clinical settings (10). Treat-

ments focused on the memory control system, using neutral material unrelated to the trauma, might also be a viable option to complement standard psychological interventions and help patients to gain a better control over their memories during therapy. The capacity to benefit from exposure therapy in PTSD depends on prefrontal control resources (67, 68) and on the propagation of neural flows originating from the right anterior DLPFC (69).

However, the effectiveness of a treatment may be limited if applied in the context of compromised capacity and impaired functional brain connectivity. Nonetheless, individuals with PTSD have shown some residual capacities. Analysis of local activity revealed that these individuals could still engage the memory control network during attempts to suppress memories, although this did not translate into a reduction of intrusion frequency. Analysis of connectivity also revealed preserved suppression processes in PTSD when memory cues failed to trigger intrusion. In fact, PTSD might excessively rely on proactive control (70), an anticipatory process attempting to gate memory retrieval before intrusion arises to conscious awareness. Excessive proactive control could reduce the opportunities to modulate intrusive memory traces and lead to the same paradoxical and harmful avoidance effect on traumatic memory. Suppression can also induce forgetting of contextual information associated with the reminder cue (38). In the context of PTSD, exaggerated anticipatory suppression could therefore prevent the learning of safe contextual cues and promote overgeneralization of fear. Interventions focused on training the memory control system should aim for better allocation of the preserved resources of the control system and proactive engagement.

It remains unknown whether the mechanisms identified here can disrupt the traumatic memory itself, as trauma-focused exposure treatments can. Suppression can be ineffective after consolidation (71) or when memory reactivation is too strong (72). Suppression can also be detrimental to emotional response if individuals show poor inhibitory capacities or when forgetting is impossible (34, 35). Suppressing traumatic memory should thus not be attempted in individuals while they lack the necessary coping skills of inhibition and intrusive memories remain vivid and salient. Once these coping skills are strengthened, and traumatic traces have been reprocessed by the hippocampus together with contextual representations during standard exposure therapy sessions (15), remediation of control capacity might also promote the disruption and updating of the traumatic engram.

Our findings suggest that the general mental operations usually engaged to banish and suppress the intrusive expression of unwanted memories might contribute to positive adaptation in the aftermath of a traumatic event,

paving the way for new treatments unrelated to the trauma and promoting resilience (54).

## Materials and methods

### Participants

Eighty nonexposed and 120 exposed subjects participated in this study. Exposed participants were recruited through a transdisciplinary and longitudinal research “Programme 13-Novembre” ([www.memoire13novembre.fr/](http://www.memoire13novembre.fr/)), a nationwide funded program supported by victims’ associations. Data from seven non-exposed participants were excluded from further analyses for the following reasons: absence of intrusion rating owing to technical or behavioral issues ( $n = 4$ ), artifacts in the MRI images ( $n = 2$ ), and inability to pursue the experiment ( $n = 1$ ). Data from 18 exposed participants were excluded from further analyses for the following reasons: absence of intrusion rating owing to technical or behavioral issues ( $n = 8$ ), interruption of participation during the MRI acquisition ( $n = 3$ ), and non-respect of inclusion criteria ( $n = 7$ ). Among these seven participants who did not respect the inclusion criteria in the exposed group, six met the criteria for the reexperiencing symptoms but without the presence of other symptom categories (including functional significance, i.e., criterion G), and one was not actually exposed to the attacks (criterion A). The final sample consists of 102 participants exposed to the 13 November 2015 terrorist attacks in Paris and 73 nonexposed healthy control participants. Nonexposed participants were not present in Paris on 13 November 2015 and were recruited from a local panel of volunteers. All participants were between 18 and 60 years old, right-handed, French speaking, and had a body mass index  $<35 \text{ kg/m}^2$ . A clinical interview with a medical doctor was conducted to ensure that participants had no reported history of neurological, medical, visual, memory, or psychiatric disorders. Exclusion criteria also included history of alcohol or substance abuse (other than nicotine), mental or physical conditions that preclude MRI scanning (e.g., claustrophobia or metal implants), and medical treatment that may affect the central nervous system or cognitive functions. Fourteen exposed participants were taking antidepressant, anxiolytic, and/or hypnotic medication at the time of the study (see table S15 for a detailed description of psychoactive medication). We decided to include medicated and unmedicated exposed participants to reflect the general PTSD population. However, additional analyses of covariance were carried out to ensure that the main findings did not depend on these participants.

Exposed participants were diagnosed using the structured clinical interview for *DSM-5* (SCID) (73) conducted by a trained psychol-

ogist and supervised by a psychiatrist. All exposed participants met *DSM-5* criterion A, indicating that they experienced a traumatic event. Different types of exposure to the Paris attacks were observed in our sample (see table S1). *DSM-5* exposure types include: (i) individuals directly targeted by the terrorist attacks (criterion A1) or (ii) witnessing the attacks (criterion A2); (iii) close relatives of a deceased victim of the attacks (criterion A3); (iv) individuals who were exposed to aversive scenes and the attacks as first responders and police officers. Exposed participants were diagnosed with PTSD in its full form if all the additional diagnostic criteria defined by *DSM-5* were met ( $n = 29$ ). Participants were diagnosed with PTSD in its partial form ( $n = 26$ ) if they had reexperiencing symptoms (criterion B), with symptoms persisting for more than one month (criterion F) that caused significant distress and functional impairment (criterion G). For this partial form of PTSD,  $>80\%$  of the individuals also suffered from two other symptom criteria [i.e., avoidance (C), negative alterations in cognition and mood (D), or hyperarousal (E)]. Subthreshold (also referred to as partial or subsyndromal) PTSD has been associated with clinically significant psychological, social, and functional impairments (48). Although participants with a partial PTSD profile did not meet the full clinical symptoms of PTSD, the intrusive symptoms identified in each participant caused important distress that may be associated with significant levels of social and functional impairments comparable to full PTSD (74). The concept of subthreshold (partial or subsyndromal) PTSD suggests that an individual may still display noticeable clinical impairment (75), especially in relation to reexperiencing and intrusive symptoms, while not meeting full criteria for either avoidance or hyperarousal symptoms (76, 77). Therefore, trauma-exposed participants with full and partial PTSD profiles were grouped together for the purpose of statistical analyses in one clinical group referred to as the PTSD group. The study includes 55 trauma-exposed participants with PTSD (PTSD+), 47 trauma-exposed participants without PTSD (PTSD-), and 73 nonexposed control participants (Control).

PTSD symptom severity was assessed with the Post-traumatic Stress Disorder Checklist for *DSM-5* (PCL-5) (78). To assess for anxiety and depression, State-Trait Anxiety Inventory (STAI) (79) and Beck Depression Inventory (BDI) (80) were also administered. Participants’ sleep habits during the month preceding their inclusion in the study were assessed with the Pittsburgh Sleep Quality Index (81), and the presence of sleep insomnia was measured with the Insomnia Severity Index. To compare the participants’ usual sleep duration with their sleep duration the night before MRI

acquisition, we computed an ANOVA with as within-factor the sleep duration (usual and night-before acquisition) and as between-factor the four groups of subjects. We found an effect of sleep duration [ $F_{1,158} = 13.43, P < 0.001$ ] with no interaction with the group [ $F_{3,158} = 0.02, P = 0.996$ ] that indicated a decreased sleep duration the night before the acquisition in all participants. Tukey post-hoc comparisons for the group effect showed that the nonexposed group reported longer sleep duration than the participants with complete ( $P = 0.03$ ) and incomplete ( $P = 0.013$ ) PTSD. However, no differences were observed among the groups of exposed participants ( $P > 0.3$ ). The demographic and clinical characteristics of participants are summarized in table S1.

All participants completed the study between 13 June 2016 and 7 June 2017. The exposed groups did not significantly differ in the delay between the date of the Paris attacks and the date of inclusion in the study ( $F_{2,99} = 2.06, P = 0.13$ ; PTSD absent =  $1.14 \pm 0.18$  years, partial PTSD =  $1.23 \pm 0.21$  years, full PTSD =  $1.14 \pm 0.23$  years). Participants were financially compensated for their participation in the study. The study was approved by the regional research ethics committee (Comité de Protection des Personnes Nord-Ouest III, sponsor ID: C16-13, RCB ID: 2016-A00661-50, [clinicaltrials.gov](http://clinicaltrials.gov) registration number: NCT02810197). All participants gave written informed consent before participation, in agreement with French ethical guidelines. Participants were asked not to consume psychostimulants, drugs, or alcohol before or during the experimental period.

### Materials

The stimuli were three series of lists of 72 word-object pairs composed of neutral abstract French words (82) and objects selected from the Bank Of Standardized Stimuli (BOSS) (83). Three series of four lists of 18 pairs assigned to four conditions (think, no-think, baseline, and unprimed) were created, plus eight fillers used for practice. The lists of pairs were presented in counterbalanced order across the three series, the four conditions and the three groups of participants and matched on different properties that may influence performance to the task. The lists of words were matched on average naming latency, number of letters, and lexical frequency (82). The lists of objects were matched relative to the naming latency, familiarity and visual complexity levels, viewpoint, name and object agreement, and manipulability (83). Stimuli were presented using the Psychophysics Toolbox implemented in MATLAB (MathWorks). We used neutral material completely disconnected from the traumatic experience, which enabled the investigation of general memory control mechanisms and

incidentally avoided ethical issues for the trauma-exposed group.

### Procedure

Before MRI acquisition, participants learned 72 French neutral word-object pairs that were presented for 5 s each. After the presentation of all pairs, the word cue for a given pair was presented on the screen for up to 4 s, and participants were asked whether they could recall and fully visualize the paired object (see Fig. 1B for details of the procedure). If so, three objects then appeared on the screen (one correct and two foils), and participants had up to 4 s to select which object was associated with the word cue. After each recognition test, the object correctly associated with the word appeared for 2500 ms on the screen, and participants were asked to use this feedback to increase their knowledge of the pair. Pairs were learned through this test-feedback cycle procedure until either the learning criterion (at least 90% correct responses) was reached or a maximum of six presentations was achieved. Once participants had reached the learning criterion, their memory was assessed one last time using a final criterion test on all of the pairs but without giving any feedback on the response. Note that no differences were found between groups on this final criterion test (all  $P > 0.18$ ), suggesting that our procedure carefully matched the learning of word-object associations between groups. After this learning phase, pairs were divided into three lists of 18 pairs assigned to think, no-think, and baseline conditions for the think/no-think task (TNT). Participants were given the think/no-think phase instructions and a short TNT practice session before MRI acquisition to familiarize them to the task.

After this TNT practice session, participants entered the MRI scanner. During the T1 structural image acquisition, the complete list of learned pairs was presented once again to reinforce the learning of the pairs (5 s for each pair). This overtraining procedure was intended to ensure that the word cue would automatically bring back the associated object, allowing us to isolate brain regions engaged to control the intrusion of the paired object during the TNT phase. After this reminder of the pairs, participants performed the TNT task, which was divided into four sessions of ~8 min each. In each session, the 18 think and 18 no-think items were presented twice. Word cues appeared for 3 s on the screen and were written either in green for think trials or in red for no-think trials. During the TNT practice session, participants were trained to use a direct suppression strategy. During the think trials, participants were told to imagine the associated object in as much detail as possible. During the no-think trials, participants were instructed to imperatively prevent the object from coming to mind

and to fixate and concentrate on the word cue without looking away. Participants were asked to block thoughts of the object by blanking their mind and not by replacing the object with any other thoughts or mental images. If the object image came to mind anyway, they were asked to push it out of mind. After the end of each of the think or no-think trial cues, participants reported whether the associated object had entered awareness by pressing one of two buttons corresponding to “yes” (i.e., even if the associated object pops very briefly into their mind) or “no.” Although participants had up to 3600 ms to make this intrusion rating, they were instructed to make it quickly without thinking and dwelling too much on the associated object. The rating instruction was presented for up to 1 s on the screen and followed by a jittered fixation cross (1400, 1800, 2000, 2200, or 2600 ms). The Genetic Algorithm toolbox (84) was used to optimize the efficiency of the think versus no-think contrast. Twenty percent additional null events with no duration and followed by the jittered fixation cross only were added.

The perceptual identification task followed the TNT phase and tested whether previous attempts at suppression affected repetition priming. It comprised a single session of about 8 min. Each think, no-think, baseline, and unprimed item was presented on one trial in a 500 pixel by 500 pixel frame centered on a gray background, and trials were separated by a fixation cross. During each trial, a single item was gradually presented using a phase-unscrambling procedure that lasted for 3.15 s. Participants’ instruction was to watch carefully as the object was progressively unscrambled and to press the button as fast as possible when they were able to see and name the object in the picture. Unscrambling continued until a complete image appeared, irrespective of when and whether participants pressed a button. The scrambling was achieved by decomposing the picture into phase and amplitude spectra using a Fourier transform. Random noise was added to the phase spectrum starting from 100% and was decreased by 5% steps until 0% (i.e., intact picture) was reached. The picture was presented at each level of noise for 150 ms, yielding a total stimulus duration of 3.15 s. Between trials, there was a 2.4-s average interstimuli interval, and there were also 20% additional null events added. Brain activity was also recorded during this perceptual identification task but data are not reported here. After this task, a resting-state recording was also proposed to the participants. During this session, participants were instructed to keep their eyes closed, to let their thoughts flow freely without focusing on any particular idea, and to remain still and awake.

Finally, during a debriefing questionnaire, participants were asked about the strategies

used during the TNT phase. Participants rated on a five-point scale [never (0) to all the time (4)] the degree to which they used different kind of strategies to prevent the object from coming to mind during the no-think condition (i.e., direct suppression, thought substitution, or another strategy). This questionnaire was administered to determine whether participants complied with the direct suppression instructions. Debriefing confirmed that the participants remained attentive to the word displayed on the screen and predominantly controlled the unwanted memories by directly suppressing the associated object. Participants engaged significantly less in other strategies than in direct suppression to control awareness of the no-think items (Wilcoxon signed-rank test:  $z > 140$ ,  $P < 0.001$ ). Moreover, Kruskal-Wallis tests did not evidence any difference between the groups for any kind of strategies used [ $H(2) < 2.73$ ,  $P > 0.26$ ]. The mean rating score for each strategy is displayed in fig. S4 for each group.

### MRI acquisition parameters

MRI data were acquired on a 3T Achieva scanner (Philips). All participants first underwent a high-resolution T1-weighted anatomical volume imaging using a 3D fast field echo (FFE) sequence (3D-T1-FFE sagittal; TR = 20 ms, TE = 4.6 ms, flip angle = 10°, SENSE factor = 2, 180 slices, 1 mm by 1 mm by 1 mm voxels, no gap, FoV = 256 mm by 256 mm by 180 mm, matrix = 256 by 130 by 180). This acquisition was followed by the TNT functional sessions and an eyes-closed resting-state fMRI sequence, which were acquired using an ascending T2-star EPI sequence (MS-T2-star-FFE-EPI axial; TR = 2050 ms, TE = 30 ms, flip angle = 78°, 32 slices, slice thickness = 3 mm, 0.75-mm gap, matrix 64 by 64 by 32, FoV = 192 mm by 192 mm by 119 mm, 235 volumes per run). Each of the TNT and resting-state functional sequence lasted about 8 min.

### fMRI preprocessing

Image preprocessing was first conducted with the Statistical Parametric Mapping software (SPM 12, University College London, London, UK). Functional images were (i) spatially realigned to correct for motion (using a six-parameter rigid body transformation); (ii) corrected for slice acquisition temporal delay; and (iii) co-registered with the skull-stripped structural T1 image. The T1 image was bias-corrected and segmented using tissue probability maps for gray matter, white matter, and cerebrospinal fluid. The forward deformation field ( $y\_*.nii$ ) was derived from the nonlinear normalization of individual gray matter T1 images to the T1 template of the Montreal Neurological Institute (MNI). Each point in this deformation field is a mapping between MNI standard space to native-space



coordinates in millimeters. Thus, this mapping was used to project the coordinates of the MNI standard space ROIs to the native space functional images. All subsequent analyses were conducted using these projected native space ROIs without any spatial warping nor smoothing of the functional images.

#### Think/no-think univariate analyses

The preprocessed fMRI time series at each voxel were high-pass filtered using a cutoff period of 128 s. Task-related regressors within a GLM for each ROI were created by convolving a boxcar function at stimulus onset for each condition of interest (i.e., think, intrusion, and nonintrusion) with the canonical hemodynamic response function (HRF). Additional regressors of no interest were the six realignment parameters to account for linear residual motion artifacts and session dummy regressors. Filler items, along with the few items with no button press or not correctly recalled during think condition, were also entered into a single regressor of no interest. Autocorrelation between fMRI time series was corrected using a first-order autoregressive AR(1) model of noise temporal autocorrelation and the GLM parameters were estimated using restricted maximum likelihood (ReML). Voxel-based analyses were performed by entering first-level activation maps for each condition of interest into flexible ANOVAs implemented in SPM, which used pooled error and correction for nonsphericity to create  $t$ -statistics. The SPMs were thresholded for voxels whose statistic exceeded a peak threshold corresponding to  $P_{\text{FWE}} < 0.05$  family-wise error (FWE) correction using random field theory across the whole brain (for the no-think versus think contrasts), or within the appropriate search volumes of interest to perform within- and between-group comparisons for the intrusion versus nonintrusion contrasts (using an initial threshold of  $P_{\text{uncorr}} < 0.005$ ). Additional exploratory analyses were performed to examine the relation between brain activation (intrusion > nonintrusion) and intrusion frequency using a separate regression model for each group of participants ( $P_{\text{uncorr}} < 0.005$ ).

#### Regions of interest (ROIs)

We focused on prefrontal and memory systems previously identified in the TNT literature as up-regulated and down-regulated, respectively, during the attempts to suppress unwanted memories. We selected ROIs from the Brainnetome atlas (85; <http://atlas.brainnetome.org/>) that overlap with these control and memory networks. The Brainnetome atlas is a fine-grained connectivity-based and cross-validated parcellation atlas of the brain into 210 cortical and 36 subcortical regions and is therefore ideally suited to study the change in task-based connectivity across the control and

memory networks. Given the strong right lateralization of the prefrontal control network during memory inhibition, we selected brain regions of the right hemisphere consistently activated during memory retrieval suppression (25–30, 34, 36, 37), including: (i) the right superior frontal gyrus (SFG); (ii) the core of the right middle frontal gyrus (MFG), excluding the posterior sensory-motor inferior frontal junction (center coordinates:  $x = 42, y = 11, z = 39$ ), as well as the anterior lateral area corresponding to Brodmann area (BA) 10 (center coordinates:  $x = 25, y = 61, z = -4$ ); (iii) the right inferior frontal gyrus (IFG); and (iv) the right anterior cingulate gyrus (CG). For the memory network, we selected bilateral brain regions consistently reported as suppressed during memory suppression (25–30, 34, 36, 37), including: (i) the hippocampus (divided into rostral and caudal parts); (ii) the parahippocampal gyrus; (iii) the fusiform gyrus; and (iv) the ventral part of the precuneus alongside the parietal sulcus. The ventral part of the precuneus is associated with visual imagery (86), episodic (60), autobiographical (87), and trauma-related memories (57, 58). Note that the dorsal portion of the precuneus, as well as the transitional zone (BA 31) are activated rather than suppressed during no-think trials, and therefore cannot be included in the down-regulated target memory network. The individual connectivity matrices were estimated on the basis of the prefrontal control network ROIs that comprised 20 regions and the memory networks that included 18 potential sites of suppression (see table S8 for a list of the Brainnetome regions with their labels and center coordinates). For between-group comparisons during connectivity analyses (PPI and DCM), we used the anterior portion of the right MFG (area 46 and ventral area 9/46 of the Brainnetome atlas; see table S8).

#### Functional connectivity analysis

The regional BOLD signal that was filtered, whitened, and adjusted for confounds was used to perform psychophysiological interaction (PPI) analyses (51). We adapted the generalized form of context-dependent PPI (51) to investigate task-induced functional connectivity between ROIs of the prefrontal control (i.e., seed) and memory (i.e., target) networks (see table S8), focusing on the contrast involving the suppression of intrusive and nonintrusive memories. Our design optimize the detection of signal change between conditions by imposing short inter-stimuli intervals and slow changes between main conditions (88–90). In an attempt to reduce the duration of the task for the sake of the participants, periods of recording without stimulation were scarce and short. This approach, however, prevents the estimation of absolute change in task-induced changes re-

lative to implicit rest baseline (the intercept of the GLM which captures the mean of the signal left unexplained). Moreover, rest baseline in such design are likely contaminated by task-based cognitive processes, which presumably do not abruptly terminate at the onset of resting periods. As such, quantification of absolute change in task-based connectivity is problematic and a contrast approach is usually recommended. To circumvent this problem, we additionally used a blind-deconvolution approach to detect spontaneous event-related changes (52) in the resting-state signal of a sequence collected after the TNT task. Onsets of pseudo-events during resting state were obtained for each ROI from BOLD activation using a threshold between 1 and 4 standard deviations from the mean. Once identified, a GLM was estimated for each ROI over all possible micro-time onsets of the neural stick function that could have generated these pseudo-events. We allowed a 3- to 9-s shift to find the best explaining onset of BOLD activation peaks based on the residuals of the GLM.

BOLD time-courses in each seed ROI for both TNT and resting-state sequences were deconvolved to estimate the neural activity. A full-rank cosine basis set convolved with the HRF, as well as the filtered and whitened matrix of confounds, was used as the design matrix of a hierarchical linear model to estimate the underlying neuronal activity under a parametric empirical Bayes scheme (91). PPI regressors were created by multiplying estimated neural activity with a boxcar function (modeled as a 3-s short-epoch) encoding TNT or resting-state events. This interaction term was subsequently reconvolved with the canonical HRF and resample to scan resolution. PPI regressors were detrended and normalized to unit length using their norm to facilitate comparisons between TNT and resting-state estimates of connectivity. For each TNT and resting-state sequence, a first-level GLM was created to estimate the connectivity between seed and target preprocessed time-series (data filtered, whitened, and adjusted for confounds). This GLM included in the design matrix the PPI regressors of the seed, the psychological regressors obtained from the convolution of stimulus boxcar function with HRF to control for task-evoked univariate changes, the physiological BOLD signal of the seed region, and a constant term.

#### Effective connectivity analyses

DCM explains changes in regional activity in terms of experimentally defined modulations (“modulatory input”) of the connectivity between regions. Here, we used DCM and Bayesian Model Averaging (BMA; 92) to assess, in each of our group, whether the modulation in connectivity between the right anterior MFG and memory systems arising from the elevated



control demand during the suppression of intrusive memories (compared with non-intrusions) was mediated by a top-down process.

DCM entails defining a network of a few ROIs and the forward and backward connections between them. The neural dynamics within this network are based on a set of simple differential equations (the bilinear state equation was used here) relating the activity in each region to (i) the activity of other regions via intrinsic connections relative to implicit unmodelled baseline, (ii) experimentally defined extrinsic input (or “driving input”) to one or more of the regions, and, most importantly, (iii) experimentally defined modulations (or “modulatory input”) in the connectivity between regions. Changes in the network dynamics are caused by these driving (entering-regions) or modulatory (between-regions) inputs. These neural dynamics are then mapped to the fMRI time series using a biophysical model of the BOLD response. The neural (and hemodynamic) parameters of this DCM are estimated using approximate variational Bayesian techniques to maximize the free-energy bound on the Bayesian model evidence. Here, we defined different models defining potential pathways of both top-down and bottom-up modulation between the right MFG and memory systems, and we used BMA to marginalize over these models to derive posterior densities on model parameters that account for model uncertainty.

Retrieval inhibition was assumed to originate from the anterior portion of the right MFG (see ROIs section). Therefore, we focused on the influence of this region over memory regions within the same hemisphere as done in previous studies analyzing effective connectivity using the TNT paradigm (26, 27, 34, 36). Note that DCM requires a restricted number of nodes so we focused this analysis on the MTL (including rostral hippocampus and parahippocampal gyrus), as done previously (26, 34, 36), and on the precuneus for both its functional role in traumatic memories and its strong down-regulation during PPI analyses in healthy participants compared to PTSD group. The caudal hippocampus was not included in this analysis given the absence of significant modulation in this region during PPI analyses. This DCM analysis was conducted on the exact same filtered, whitened, and adjusted for confounds time-series than the ones used for PPI analyses.

Seven DCM models were created (for an illustration of the model space, see Fig. 5A), plus an additional null model. This null model did not include any modulatory input modelling the effect of suppression on connections. This null model was compared to other modulatory models to ensure that suppression induced some modulation of the connections. All models were fully connected and included a com-

mon driving input source entering the right MFG and reflecting cue-onset of all trials. The modulatory input acting on intrinsic connections was modeled as a 3-s short-epochs function reflecting the contrast between intrusion and non-intrusion. After estimating all 8 models for each participant (version DCM12.5 revision 7479), we first performed Bayesian model selection (BMS) to compare models including a modulatory input to null model. BMS overwhelmingly favored models including a modulatory input, with an exceedance probability (EP) and expected posterior probability (EPP), of EP = [100% 100% 100%] and EPP = [91% 88% 78%] for nonexposed, non-PTSD, and PTSD groups, respectively.

We then performed BMA including all modulatory models for each group separately. This produces a maximal a posteriori estimate of coupling parameters weighted by the subject specific posterior and by the posterior probability that subject  $n$  uses model  $m$ , treating the optimal model across participants in each group as a random effect.

#### Statistical analyses

All a priori hypotheses test of memory suppression-induced changes in functional connectivity were performed using one-sided paired sample  $t$  tests for within-group comparisons, and one-sided two-sample  $t$  tests for between group comparisons. The expected proportion of type I error across multiple testing was controlled for using the false discovery rate (FDR) correction, with a desired FDR  $q = 0.05$  and assuming a positive dependency between conditions (93). In addition, we used a Bayesian approach (94) using Markov chain Monte Carlo (MCMC) method. Bayes factors (BF) were estimated for visualization purpose to represent the likelihood of suppression effects for each within-group comparison. Based on this hypothesis, we defined a region of practical equivalence (ROPE) set as a Cohen's  $d$  effect size greater than  $-0.1$ . The MCMC method generated 50,000 credible parameter combinations that are representative of the posterior distribution. Then, the BF was estimated as the ratio of the proportion of the posterior within the ROPE relative to the proportion of the prior within the ROPE. The conventional interpretation of the magnitude of the BF is that there is substantial evidence for the alternative hypothesis when the BF ranges from 3 to 10, a strong evidence between 10 and 30, a very strong evidence between 30 and 100, and a decisive evidence above 100 (95). For ROI analyses, group-level inferences were also conducted using nonparametric random effects statistics to test for within-group differences by bootstrapping the subject set with 5000 iterations and compute 95% confidence intervals. Moreover, group comparisons were also conducted using an ANCOVA model con-

trolling for age, sex, education, medication, duration, and type of exposure to the attacks (table S11). For DCM, BMA gives for each group the mean and standard deviation of the coupling parameters posterior distribution. In line with the DCM Bayesian framework, we estimated the posterior probability and the 95% confidence interval of the within- and between-group differences. In this Bayesian framework, the posterior probability indicates the probability that a random sample from this estimated distribution will be different than zero, and is usually considered as significant when equal to or greater than 0.95 (see also table S14 for an ANCOVA model on individual coupling parameters extracted during BMA).

#### REFERENCES AND NOTES

- C. R. Brewin, J. D. Gregory, M. Lipton, N. Burgess, Intrusive images in psychological disorders: Characteristics, neural mechanisms, and treatment implications. *Psychol. Rev.* **117**, 210–232 (2010). doi: [10.1037/a0018113](https://doi.org/10.1037/a0018113); pmid: [20063969](https://pubmed.ncbi.nlm.nih.gov/20063969/)
- A. Ehlers, D. M. Clark, A cognitive model of posttraumatic stress disorder. *Behav. Res. Ther.* **38**, 319–345 (2000). doi: [10.1016/S0005-7967\(99\)00123-0](https://doi.org/10.1016/S0005-7967(99)00123-0); pmid: [10761279](https://pubmed.ncbi.nlm.nih.gov/10761279/)
- C. R. Brewin, The nature and significance of memory disturbance in posttraumatic stress disorder. *Annu. Rev. Clin. Psychol.* **7**, 203–227 (2011). doi: [10.1146/annurev-clinpsy-032210-104544](https://doi.org/10.1146/annurev-clinpsy-032210-104544); pmid: [21219190](https://pubmed.ncbi.nlm.nih.gov/21219190/)
- A. Hackmann, A. Ehlers, A. Speckens, D. M. Clark, Characteristics and content of intrusive memories in PTSD and their changes with treatment. *J. Trauma. Stress* **17**, 231–240 (2004). doi: [10.1023/B:JOTS.0000029266.88369.f6](https://doi.org/10.1023/B:JOTS.0000029266.88369.f6); pmid: [15253095](https://pubmed.ncbi.nlm.nih.gov/15253095/)
- A. Ehlers, A. Hackmann, T. Michael, Intrusive re-experiencing in post-traumatic stress disorder: Phenomenology, theory, and therapy. *Memory* **12**, 403–415 (2004). doi: [10.1080/09658210444000025](https://doi.org/10.1080/09658210444000025); pmid: [15487537](https://pubmed.ncbi.nlm.nih.gov/15487537/)
- J. C. Shipherd, J. G. Beck, The role of thought suppression in posttraumatic stress disorder. *Behav. Ther.* **36**, 277–287 (2005). doi: [10.1016/S0005-7894\(05\)80076-0](https://doi.org/10.1016/S0005-7894(05)80076-0)
- A. Nickerson et al., Emotional suppression in torture survivors: Relationship to posttraumatic stress symptoms and trauma-related negative affect. *Psychiatry Res.* **242**, 233–239 (2016). doi: [10.1016/j.psychres.2016.05.048](https://doi.org/10.1016/j.psychres.2016.05.048); pmid: [27294797](https://pubmed.ncbi.nlm.nih.gov/27294797/)
- C. Purdon, Thought suppression and psychopathology. *Behav. Res. Ther.* **37**, 1029–1054 (1999). doi: [10.1016/S0005-7967\(98\)00200-9](https://doi.org/10.1016/S0005-7967(98)00200-9); pmid: [10500319](https://pubmed.ncbi.nlm.nih.gov/10500319/)
- E. B. Foa, T. M. Keane, M. J. Friedman, J. A. Cohen, *Effective Treatments for PTSD: Practice Guidelines from the International Society for Traumatic Stress Studies* (Guilford Press, ed. 2, 2009).
- C. R. Brewin, Memory and forgetting. *Curr. Psychiatry Rep.* **20**, 87 (2018). doi: [10.1007/s11920-018-0950-7](https://doi.org/10.1007/s11920-018-0950-7); pmid: [30155780](https://pubmed.ncbi.nlm.nih.gov/30155780/)
- S. Lissek, B. van Meurs, Learning models of PTSD: Theoretical accounts and psychobiological evidence. *Int. J. Psychophysiol.* **98**, 594–605 (2015). doi: [10.1016/j.ijpsycho.2014.11.006](https://doi.org/10.1016/j.ijpsycho.2014.11.006); pmid: [25462219](https://pubmed.ncbi.nlm.nih.gov/25462219/)
- I. Liberzon, J. L. Abelson, Context processing and the neurobiology of post-traumatic stress disorder. *Neuron* **92**, 14–30 (2016). doi: [10.1016/j.neuron.2016.09.039](https://doi.org/10.1016/j.neuron.2016.09.039); pmid: [27710783](https://pubmed.ncbi.nlm.nih.gov/27710783/)
- R. J. Fenster, L. A. M. Lebois, K. J. Ressler, J. Suh, Brain circuit dysfunction in post-traumatic stress disorder: From mouse to man. *Nat. Rev. Neurosci.* **19**, 535–551 (2018). doi: [10.1038/s41583-018-0039-7](https://doi.org/10.1038/s41583-018-0039-7); pmid: [30054570](https://pubmed.ncbi.nlm.nih.gov/30054570/)
- S. Kida, Reconsolidation/destabilization, extinction and forgetting of fear memory as therapeutic targets for PTSD. *Psychopharmacology* **236**, 49–57 (2019). doi: [10.1007/s00213-018-5086-2](https://doi.org/10.1007/s00213-018-5086-2); pmid: [30374892](https://pubmed.ncbi.nlm.nih.gov/30374892/)
- A. Desmedt, A. Marighetto, P.-V. Piazza, Abnormal fear memory as a model for posttraumatic stress disorder. *Biol. Psychiatry* **78**, 290–297 (2015). doi: [10.1016/j.biopsych.2015.06.017](https://doi.org/10.1016/j.biopsych.2015.06.017); pmid: [26238378](https://pubmed.ncbi.nlm.nih.gov/26238378/)
- J. C. Magee, K. P. Harden, B. A. Teachman, Psychopathology and thought suppression: A quantitative review. *Clin. Psychol. Rev.* **32**, 189–201 (2012). doi: [10.1016/j.cpr.2012.01.001](https://doi.org/10.1016/j.cpr.2012.01.001); pmid: [22388007](https://pubmed.ncbi.nlm.nih.gov/22388007/)
- L. S. Bishop, V. E. Ameral, K. M. Palm Reed, The impact of experiential avoidance and event centrality in trauma-related

- rumination and posttraumatic stress. *Behav. Modif.* **42**, 815–837 (2018). doi: [10.1177/0145445517747287](https://doi.org/10.1177/0145445517747287); pmid: [29241356](https://pubmed.ncbi.nlm.nih.gov/29241356/)
18. T. Dalgleish, B. Hauer, W. Kuyken, The mental regulation of autobiographical recollection in the aftermath of trauma. *Curr. Dir. Psychol. Sci.* **17**, 259–263 (2008). doi: [10.1111/j.1467-8721.2008.00586.x](https://doi.org/10.1111/j.1467-8721.2008.00586.x)
  19. M. I. Davies, D. M. Clark, Thought suppression produces a rebound effect with analogue post-traumatic intrusions. *Behav. Res. Ther.* **36**, 571–582 (1998). doi: [10.1016/S0005-7967\(98\)00051-5](https://doi.org/10.1016/S0005-7967(98)00051-5); pmid: [9648331](https://pubmed.ncbi.nlm.nih.gov/9648331/)
  20. J. P. Mitchell *et al.*, Separating sustained from transient aspects of cognitive control during thought suppression. *Psychol. Sci.* **18**, 292–297 (2007). doi: [10.1111/j.1467-9280.2007.01891.x](https://doi.org/10.1111/j.1467-9280.2007.01891.x); pmid: [17470250](https://pubmed.ncbi.nlm.nih.gov/17470250/)
  21. D. M. Wegner, Ironic processes of mental control. *Psychol. Rev.* **101**, 34–52 (1994). doi: [10.1037/0033-295X.101.1.34](https://doi.org/10.1037/0033-295X.101.1.34); pmid: [8121959](https://pubmed.ncbi.nlm.nih.gov/8121959/)
  22. C. Gagne, P. Dayan, S. J. Bishop, When planning to survive goes wrong: Predicting the future and replaying the past in anxiety and PTSD. *Curr. Opin. Behav. Sci.* **24**, 89–95 (2018). doi: [10.1016/j.cobeha.2018.03.013](https://doi.org/10.1016/j.cobeha.2018.03.013)
  23. M. B. Stein, M. P. Paulus, Imbalance of approach and avoidance: The yin and yang of anxiety disorders. *Biol. Psychiatry* **66**, 1072–1074 (2009). doi: [10.1016/j.biopsych.2009.09.023](https://doi.org/10.1016/j.biopsych.2009.09.023); pmid: [19944792](https://pubmed.ncbi.nlm.nih.gov/19944792/)
  24. M. C. Anderson, C. Green, Suppressing unwanted memories by executive control. *Nature* **410**, 366–369 (2001). doi: [10.1038/35066572](https://doi.org/10.1038/35066572); pmid: [11268212](https://pubmed.ncbi.nlm.nih.gov/11268212/)
  25. B. E. Depue, T. Curran, M. T. Banich, Prefrontal regions orchestrate suppression of emotional memories via a two-phase process. *Science* **317**, 215–219 (2007). doi: [10.1126/science.1139560](https://doi.org/10.1126/science.1139560); pmid: [17626877](https://pubmed.ncbi.nlm.nih.gov/17626877/)
  26. R. G. Benoit, M. C. Anderson, Opposing mechanisms support the voluntary forgetting of unwanted memories. *Neuron* **76**, 450–460 (2012). doi: [10.1016/j.neuron.2012.07.025](https://doi.org/10.1016/j.neuron.2012.07.025); pmid: [23083745](https://pubmed.ncbi.nlm.nih.gov/23083745/)
  27. P. Gagnepain, R. N. Henson, M. C. Anderson, Suppressing unwanted memories reduces their unconscious influence via targeted cortical inhibition. *Proc. Natl. Acad. Sci. U.S.A.* **111**, E1310–E1319 (2014). doi: [10.1073/pnas.1311468111](https://doi.org/10.1073/pnas.1311468111); pmid: [24639546](https://pubmed.ncbi.nlm.nih.gov/24639546/)
  28. B. E. Depue, J. M. Orr, H. R. Smolker, F. Naaz, M. T. Banich, The organization of right prefrontal networks reveals common mechanisms of inhibitory regulation across cognitive, emotional, and motor processes. *Cereb. Cortex* **26**, 1634–1646 (2016). doi: [10.1093/cercor/bhu324](https://doi.org/10.1093/cercor/bhu324); pmid: [25601236](https://pubmed.ncbi.nlm.nih.gov/25601236/)
  29. T. W. Schmitz, M. M. Correia, C. S. Ferreira, A. P. Prescott, M. C. Anderson, Hippocampal GABA enables inhibitory control over unwanted thoughts. *Nat. Commun.* **8**, 1311 (2017). doi: [10.1038/s41467-017-00956-z](https://doi.org/10.1038/s41467-017-00956-z); pmid: [29101315](https://pubmed.ncbi.nlm.nih.gov/29101315/)
  30. M. C. Anderson *et al.*, Neural systems underlying the suppression of unwanted memories. *Science* **303**, 232–235 (2004). doi: [10.1126/science.1089504](https://doi.org/10.1126/science.1089504); pmid: [14716015](https://pubmed.ncbi.nlm.nih.gov/14716015/)
  31. M. C. Anderson, S. Hanslmayr, Neural mechanisms of motivated forgetting. *Trends Cogn. Sci.* **18**, 279–292 (2014). doi: [10.1016/j.tics.2014.03.002](https://doi.org/10.1016/j.tics.2014.03.002); pmid: [24747000](https://pubmed.ncbi.nlm.nih.gov/24747000/)
  32. Y. Wang, A. Luppi, J. Fawcett, M. C. Anderson, Reconsidering unconscious persistence: Suppressing unwanted memories reduces their indirect expression in later thoughts. *Cognition* **187**, 78–94 (2019). doi: [10.1016/j.cognition.2019.02.016](https://doi.org/10.1016/j.cognition.2019.02.016); pmid: [30852261](https://pubmed.ncbi.nlm.nih.gov/30852261/)
  33. K. Kim, D.-J. Yi, Out of mind, out of sight: Perceptual consequences of memory suppression. *Psychol. Sci.* **24**, 569–574 (2013). doi: [10.1177/0956797612457577](https://doi.org/10.1177/0956797612457577); pmid: [23459870](https://pubmed.ncbi.nlm.nih.gov/23459870/)
  34. P. Gagnepain, J. Hulbert, M. C. Anderson, Parallel regulation of memory and emotion supports the suppression of intrusive memories. *J. Neurosci.* **37**, 6423–6441 (2017). doi: [10.1523/JNEUROSCI.2732-16.2017](https://doi.org/10.1523/JNEUROSCI.2732-16.2017); pmid: [28559378](https://pubmed.ncbi.nlm.nih.gov/28559378/)
  35. N. LeGrand *et al.*, Does the heart forget? Modulation of cardiac activity induced by inhibitory control over emotional memories. *bioRxiv* 376954 [Preprint]. 13 February 2019. <https://www.biorxiv.org/content/10.1101/376954v3>
  36. R. G. Benoit, J. C. Hulbert, E. Huddleston, M. C. Anderson, Adaptive top-down suppression of hippocampal activity and the purging of intrusive memories from consciousness. *J. Cogn. Neurosci.* **27**, 96–111 (2015). doi: [10.1162/jocn\\_a.00696](https://doi.org/10.1162/jocn_a.00696); pmid: [25100219](https://pubmed.ncbi.nlm.nih.gov/25100219/)
  37. B. J. Levy, M. C. Anderson, Purging of memories from conscious awareness tracked in the human brain. *J. Neurosci.* **32**, 16785–16794 (2012). doi: [10.1523/JNEUROSCI.2640-12.2012](https://doi.org/10.1523/JNEUROSCI.2640-12.2012); pmid: [23175832](https://pubmed.ncbi.nlm.nih.gov/23175832/)
  38. J. C. Hulbert, R. N. Henson, M. C. Anderson, Inducing amnesia through systemic suppression. *Nat. Commun.* **7**, 11003 (2016). doi: [10.1038/ncomms11003](https://doi.org/10.1038/ncomms11003); pmid: [26977589](https://pubmed.ncbi.nlm.nih.gov/26977589/)
  39. X. Hu, Z. M. Bergström, P. Gagnepain, M. C. Anderson, Suppressing unwanted memories reduces their unintended influences. *Curr. Dir. Psychol. Sci.* **26**, 197–206 (2017). doi: [10.1177/0963721417689881](https://doi.org/10.1177/0963721417689881); pmid: [28458471](https://pubmed.ncbi.nlm.nih.gov/28458471/)
  40. B. E. Depue, A neuroanatomical model of prefrontal inhibitory modulation of memory retrieval. *Neurosci. Biobehav. Rev.* **36**, 1382–1399 (2012). doi: [10.1016/j.neubiorev.2012.02.012](https://doi.org/10.1016/j.neubiorev.2012.02.012); pmid: [22374224](https://pubmed.ncbi.nlm.nih.gov/22374224/)
  41. M. C. Anderson, J. G. Bunce, H. Barbas, Prefrontal-hippocampal pathways underlying inhibitory control over memory. *Neurobiol. Learn. Mem.* **134**, 145–161 (2016). doi: [10.1016/j.nlm.2015.11.008](https://doi.org/10.1016/j.nlm.2015.11.008); pmid: [26642918](https://pubmed.ncbi.nlm.nih.gov/26642918/)
  42. S. J.-H. van Rooij, E. Geuze, M. Kennis, A. R. Rademaker, M. Vink, Neural correlates of inhibition and contextual cue processing related to treatment response in PTSD. *Neuropsychopharmacology* **40**, 667–675 (2015). doi: [10.1038/npp.2014.220](https://doi.org/10.1038/npp.2014.220); pmid: [25154707](https://pubmed.ncbi.nlm.nih.gov/25154707/)
  43. N. Fani *et al.*, Attentional control abnormalities in posttraumatic stress disorder: Functional, behavioral, and structural correlates. *J. Affect. Disord.* **253**, 343–351 (2019). doi: [10.1016/j.jad.2019.04.098](https://doi.org/10.1016/j.jad.2019.04.098); pmid: [31078834](https://pubmed.ncbi.nlm.nih.gov/31078834/)
  44. A. Catarino, C. S. Küpper, A. Werner-Seidler, T. Dalgleish, M. C. Anderson, Failing to forget: Inhibitory-control deficits compromise memory suppression in posttraumatic stress disorder. *Psychol. Sci.* **26**, 604–616 (2015). doi: [10.1177/0956797615569889](https://doi.org/10.1177/0956797615569889); pmid: [25847536](https://pubmed.ncbi.nlm.nih.gov/25847536/)
  45. G. T. Waldhauser *et al.*, The neural dynamics of deficient memory control in heavily traumatized refugees. *Sci. Rep.* **8**, 13132 (2018). doi: [10.1038/s41598-018-31400-x](https://doi.org/10.1038/s41598-018-31400-x); pmid: [30177846](https://pubmed.ncbi.nlm.nih.gov/30177846/)
  46. R. L. Aupperle, A. J. Melrose, M. B. Stein, M. P. Paulus, Executive function and PTSD: Disengaging from trauma. *Neuropharmacology* **62**, 686–694 (2012). doi: [10.1016/j.neuropharm.2011.02.008](https://doi.org/10.1016/j.neuropharm.2011.02.008); pmid: [21349277](https://pubmed.ncbi.nlm.nih.gov/21349277/)
  47. J. DeGutis *et al.*, Posttraumatic psychological symptoms are associated with reduced inhibitory control, not general executive dysfunction. *J. Int. Neuropsychol. Soc.* **21**, 342–352 (2015). doi: [10.1017/S1355617115000235](https://doi.org/10.1017/S1355617115000235); pmid: [26126233](https://pubmed.ncbi.nlm.nih.gov/26126233/)
  48. M. Brancu *et al.*, Subthreshold posttraumatic stress disorder: A meta-analytic review of DSM-IV prevalence and a proposed DSM-5 approach to measurement. *Psychol. Trauma* **8**, 222–232 (2016). doi: [10.1037/tra0000078](https://doi.org/10.1037/tra0000078); pmid: [26390108](https://pubmed.ncbi.nlm.nih.gov/26390108/)
  49. D. R. Sullivan *et al.*, Behavioral and neural correlates of memory suppression in PTSD. *J. Psychiatr. Res.* **112**, 30–37 (2019). doi: [10.1016/j.jpsychires.2019.02.015](https://doi.org/10.1016/j.jpsychires.2019.02.015); pmid: [30844595](https://pubmed.ncbi.nlm.nih.gov/30844595/)
  50. I. K. Lyoo *et al.*, The neurobiological role of the dorsolateral prefrontal cortex in recovery from trauma. Longitudinal brain imaging study among survivors of the South Korean subway disaster. *Arch. Gen. Psychiatry* **68**, 701–713 (2011). doi: [10.1001/archgenpsychiatry.2011.70](https://doi.org/10.1001/archgenpsychiatry.2011.70); pmid: [21727254](https://pubmed.ncbi.nlm.nih.gov/21727254/)
  51. D. G. McLaren, M. L. Ries, G. Xu, S. C. Johnson, A generalized form of context-dependent psychophysical interactions (gPPI): A comparison to standard approaches. *Neuroimage* **61**, 1277–1286 (2012). doi: [10.1016/j.neuroimage.2012.03.068](https://doi.org/10.1016/j.neuroimage.2012.03.068); pmid: [22484411](https://pubmed.ncbi.nlm.nih.gov/22484411/)
  52. G. R. Wu *et al.*, A blind deconvolution approach to recover effective connectivity brain networks from resting state fMRI data. *Med. Image Anal.* **17**, 365–374 (2013). doi: [10.1016/j.media.2013.01.003](https://doi.org/10.1016/j.media.2013.01.003); pmid: [23422254](https://pubmed.ncbi.nlm.nih.gov/23422254/)
  53. J. C. Hulbert, M. C. Anderson, What doesn't kill you makes you stronger: Psychological trauma and its relationship to enhanced memory control. *J. Exp. Psychol. Gen.* **147**, 1931–1949 (2018). doi: [10.1037/xge0000461](https://doi.org/10.1037/xge0000461); pmid: [30024184](https://pubmed.ncbi.nlm.nih.gov/30024184/)
  54. R. Kalsch *et al.*, The resilience framework as a strategy to combat stress-related disorders. *Nat. Hum. Behav.* **1**, 784–790 (2017). doi: [10.1038/s41562-017-0200-8](https://doi.org/10.1038/s41562-017-0200-8); pmid: [31024125](https://pubmed.ncbi.nlm.nih.gov/31024125/)
  55. J. Verwoerd, P. J. de Jong, I. Wessel, Low attentional control and the development of intrusive memories following a laboratory stressor. *J. Psychopathol. Behav. Assess.* **30**, 291–297 (2008). doi: [10.1007/s10862-008-9080-6](https://doi.org/10.1007/s10862-008-9080-6)
  56. M. Streb, A. Mecklinger, M. C. Anderson, L. H. Johanna, T. Michael, Memory control ability modulates intrusive memories after analogue trauma. *J. Affect. Disord.* **192**, 134–142 (2016). doi: [10.1016/j.jad.2015.12.032](https://doi.org/10.1016/j.jad.2015.12.032); pmid: [26724692](https://pubmed.ncbi.nlm.nih.gov/26724692/)
  57. G. Sartory *et al.*, In search of the trauma memory: A meta-analysis of functional neuroimaging studies of symptom provocation in posttraumatic stress disorder (PTSD). *PLoS ONE* **8**, e58150 (2013). doi: [10.1371/journal.pone.0058150](https://doi.org/10.1371/journal.pone.0058150); pmid: [23536785](https://pubmed.ncbi.nlm.nih.gov/23536785/)
  58. G. A. Gvozdanovic, P. Stämpfli, E. Seifritz, B. Rasch, Neural correlates of experimental trauma memory retrieval. *Hum. Brain Mapp.* **38**, 3592–3602 (2017). pmid: [28419641](https://pubmed.ncbi.nlm.nih.gov/28419641/)
  59. I. A. Clark, C. E. Mackay, Mental imagery and post-traumatic stress disorder: A neuroimaging and experimental psychopathology approach to intrusive memories of trauma. *Front. Psychiatry* **6**, 104 (2015). doi: [10.3389/fpsyg.2015.00104](https://doi.org/10.3389/fpsyg.2015.00104); pmid: [26257660](https://pubmed.ncbi.nlm.nih.gov/26257660/)
  60. S. Brodt *et al.*, Fast track to the neocortex: A memory engraving in the posterior parietal cortex. *Science* **362**, 1045–1048 (2018). doi: [10.1126/science.aau2528](https://doi.org/10.1126/science.aau2528); pmid: [30498125](https://pubmed.ncbi.nlm.nih.gov/30498125/)
  61. P. L. St. Jacques, C. Olin, D. L. Schacter, Neural mechanisms of reactivation-induced updating that enhance and distort memory. *Proc. Natl. Acad. Sci. U.S.A.* **110**, 19671–19678 (2013). doi: [10.1073/pnas.1319630110](https://doi.org/10.1073/pnas.1319630110); pmid: [24191059](https://pubmed.ncbi.nlm.nih.gov/24191059/)
  62. G. S. Shields, M. A. Sazma, A. P. Yonelinas, The effects of acute stress on core executive functions: A meta-analysis and comparison with cortisol. *Neurosci. Biobehav. Rev.* **68**, 651–668 (2016). doi: [10.1016/j.neubiorev.2016.06.038](https://doi.org/10.1016/j.neubiorev.2016.06.038); pmid: [27371161](https://pubmed.ncbi.nlm.nih.gov/27371161/)
  63. S. A. Gagnon, A. D. Wagner, Acute stress and episodic memory retrieval: Neurobiological mechanisms and behavioral consequences. *Ann. N. Y. Acad. Sci.* **1369**, 55–75 (2016). doi: [10.1111/nyas.12996](https://doi.org/10.1111/nyas.12996); pmid: [26799371](https://pubmed.ncbi.nlm.nih.gov/26799371/)
  64. B. Czéh *et al.*, Chronic stress reduces the number of GABAergic interneurons in the adult rat hippocampus, dorsal-ventral and region-specific differences. *Hippocampus* **25**, 393–405 (2015). doi: [10.1002/hipo.22382](https://doi.org/10.1002/hipo.22382); pmid: [25331166](https://pubmed.ncbi.nlm.nih.gov/25331166/)
  65. I. Reuveni *et al.*, Altered cerebral benzodiazepine receptor binding in post-traumatic stress disorder. *Transl. Psychiatry* **8**, 206 (2018). doi: [10.1038/s41398-018-0257-9](https://doi.org/10.1038/s41398-018-0257-9); pmid: [30287828](https://pubmed.ncbi.nlm.nih.gov/30287828/)
  66. S. Siehl, J. A. King, N. Burgess, H. Flor, F. Nees, Structural white matter changes in adults and children with posttraumatic stress disorder: A systematic review and meta-analysis. *Neuroimage Clin.* **19**, 581–598 (2018). doi: [10.1016/j.nicl.2018.05.013](https://doi.org/10.1016/j.nicl.2018.05.013); pmid: [29984166](https://pubmed.ncbi.nlm.nih.gov/29984166/)
  67. G. A. Fonzo *et al.*, PTSD psychotherapy outcome predicted by brain activation during emotional reactivity and regulation. *Am. J. Psychiatry* **174**, 1163–1174 (2017). doi: [10.1176/appi.ajp.2017.16091072](https://doi.org/10.1176/appi.ajp.2017.16091072); pmid: [28715908](https://pubmed.ncbi.nlm.nih.gov/28715908/)
  68. E. Falconer, A. Allen, K. L. Felmingham, L. M. Williams, R. A. Bryant, Inhibitory neural activity predicts response to cognitive-behavioral therapy for posttraumatic stress disorder. *J. Clin. Psychiatry* **74**, 895–901 (2013). doi: [10.4088/JCP.12m08020](https://doi.org/10.4088/JCP.12m08020); pmid: [24107763](https://pubmed.ncbi.nlm.nih.gov/24107763/)
  69. A. Etkin *et al.*, Using fMRI connectivity to define a treatment-resistant form of post-traumatic stress disorder. *Sci. Transl. Med.* **11**, eaal3236 (2019). doi: [10.1126/scitranslmed.aal3236](https://doi.org/10.1126/scitranslmed.aal3236); pmid: [30944165](https://pubmed.ncbi.nlm.nih.gov/30944165/)
  70. T. S. Braver, The variable nature of cognitive control: A dual mechanisms framework. *Trends Cogn. Sci.* **16**, 106–113 (2012). doi: [10.1016/j.tics.2011.12.010](https://doi.org/10.1016/j.tics.2011.12.010); pmid: [22245618](https://pubmed.ncbi.nlm.nih.gov/22245618/)
  71. Y. Liu *et al.*, Memory consolidation reconfigures neural pathways involved in the suppression of emotional memories. *Nat. Commun.* **7**, 13375 (2016). doi: [10.1038/ncomms13375](https://doi.org/10.1038/ncomms13375); pmid: [27898050](https://pubmed.ncbi.nlm.nih.gov/27898050/)
  72. G. J. Detre, A. Natarajan, S. J. Gershman, K. A. Norman, Moderate levels of activation lead to forgetting in the think/no-think paradigm. *Neuropsychologia* **51**, 2371–2388 (2013). doi: [10.1016/j.neuropsychologia.2013.02.017](https://doi.org/10.1016/j.neuropsychologia.2013.02.017); pmid: [23499722](https://pubmed.ncbi.nlm.nih.gov/23499722/)
  73. American Psychiatric Association, *Diagnostic and Statistical Manual of Mental Disorders* (American Psychiatric Association, ed. 5, 2013).
  74. C. Zlotnick, C. L. Franklin, M. Zimmerman, Does “subthreshold” posttraumatic stress disorder have any clinical relevance? *Compr. Psychiatry* **43**, 413–419 (2002). doi: [10.1053/comp.2002.35900](https://doi.org/10.1053/comp.2002.35900); pmid: [12439826](https://pubmed.ncbi.nlm.nih.gov/12439826/)
  75. N. P. Mota *et al.*, High burden of subthreshold DSM-5 post-traumatic stress disorder in U.S. military veterans. *World Psychiatry* **15**, 185–186 (2016). doi: [10.1002/wps.20313](https://doi.org/10.1002/wps.20313); pmid: [27265715](https://pubmed.ncbi.nlm.nih.gov/27265715/)
  76. E. B. Blanchard *et al.*, One-year prospective follow-up of motor vehicle accident victims. *Behav. Res. Ther.* **34**, 775–786 (1996). doi: [10.1016/0005-7967\(96\)00038-1](https://doi.org/10.1016/0005-7967(96)00038-1); pmid: [8952120](https://pubmed.ncbi.nlm.nih.gov/8952120/)
  77. R. H. Pietrzak *et al.*, The burden of full and subsyndromal posttraumatic stress disorder among police involved in the World Trade Center rescue and recovery effort. *J. Psychiatr. Res.* **46**, 835–842 (2012). doi: [10.1016/j.jpsychires.2012.03.011](https://doi.org/10.1016/j.jpsychires.2012.03.011); pmid: [22464942](https://pubmed.ncbi.nlm.nih.gov/22464942/)
  78. C. A. Blevins, F. W. Weathers, M. T. Davis, T. K. Witte, J. L. Domino, The Posttraumatic Stress Disorder Checklist for DSM-5 (PCL-5): development and initial psychometric evaluation. *J. Trauma. Stress* **28**, 489–498 (2015). doi: [10.1002/pts.22059](https://doi.org/10.1002/pts.22059); pmid: [26606250](https://pubmed.ncbi.nlm.nih.gov/26606250/)
  79. C. D. Spielberger, M. Bruchon-Schwitzer, I. Paulhan, *Inventaire d'Anxiété état-trait: forme Y* (ECPA, les Éditions du centre de Psychologie Appliquée, 1993).
  80. A. T. Beck, R. A. Steer, G. K. Brown, *Manual for the Beck Depression Inventory-II* (Psychological Corporation, ed. 2, 1996).

81. D. J. Buysse, C. F. Reynolds 3rd, T. H. Monk, S. R. Berman, D. J. Kupfer, The Pittsburgh Sleep Quality Index: A new instrument for psychiatric practice and research. *Psychiatry Res.* **28**, 193–213 (1989). doi: [10.1016/0165-1781\(89\)90047-4](https://doi.org/10.1016/0165-1781(89)90047-4); pmid: [2748771](https://pubmed.ncbi.nlm.nih.gov/2748771/)
82. A. Syssau, N. Font, Évaluations des caractéristiques émotionnelles d'un corpus de 604 mots. *Bull. Psychol.* **477**, 361–367 (2005). doi: [10.3917/bupsy.477.0361](https://doi.org/10.3917/bupsy.477.0361)
83. M. B. Brodeur, K. Guérard, M. Bouras, Bank of Standardized Stimuli (BOSS) phase II: 930 new normative photos. *PLoS ONE* **9**, e106953 (2014). doi: [10.1371/journal.pone.0106953](https://doi.org/10.1371/journal.pone.0106953); pmid: [25211489](https://pubmed.ncbi.nlm.nih.gov/25211489/)
84. T. D. Wager, T. E. Nichols, Optimization of experimental design in fMRI: A general framework using a genetic algorithm. *Neuroimage* **18**, 293–309 (2003). doi: [10.1016/S1053-8119\(02\)00046-0](https://doi.org/10.1016/S1053-8119(02)00046-0); pmid: [12595184](https://pubmed.ncbi.nlm.nih.gov/12595184/)
85. L. Fan et al., The Human Brainnetome Atlas: A new brain atlas based on connective architecture. *Cereb. Cortex* **26**, 3508–3526 (2016). doi: [10.1093/cercor/bhw157](https://doi.org/10.1093/cercor/bhw157); pmid: [27230218](https://pubmed.ncbi.nlm.nih.gov/27230218/)
86. M. Grol, G. Vingerhoets, R. De Raedt, Mental imagery of positive and neutral memories: A fMRI study comparing field perspective imagery to observer perspective imagery. *Brain Cogn.* **111**, 13–24 (2017). doi: [10.1016/j.bandc.2016.09.014](https://doi.org/10.1016/j.bandc.2016.09.014); pmid: [27816776](https://pubmed.ncbi.nlm.nih.gov/27816776/)
87. P. L. St. Jacques, K. K. Szpunar, D. L. Schacter, Shifting visual perspective during retrieval shapes autobiographical memories. *Neuroimage* **148**, 103–114 (2017). doi: [10.1016/j.neuroimage.2016.12.028](https://doi.org/10.1016/j.neuroimage.2016.12.028); pmid: [27989780](https://pubmed.ncbi.nlm.nih.gov/27989780/)
88. K. J. Friston, E. Zarahn, O. Josephs, R. N. A. Henson, A. M. Dale, Stochastic designs in event-related fMRI. *Neuroimage* **10**, 607–619 (1999). doi: [10.1006/nimg.1999.0498](https://doi.org/10.1006/nimg.1999.0498); pmid: [10547338](https://pubmed.ncbi.nlm.nih.gov/10547338/)
89. R. M. Birn, R. W. Cox, P. A. Bandettini, Detection versus estimation in event-related fMRI: Choosing the optimal stimulus timing. *Neuroimage* **15**, 252–264 (2002). doi: [10.1006/nimg.2001.0964](https://doi.org/10.1006/nimg.2001.0964); pmid: [11771993](https://pubmed.ncbi.nlm.nih.gov/11771993/)
90. O. Josephs, R. N. Henson, Event-related functional magnetic resonance imaging: Modelling, inference and optimization. *Philos. Trans. R. Soc. London Ser. B* **354**, 1215–1228 (1999). doi: [10.1098/rstb.1999.0475](https://doi.org/10.1098/rstb.1999.0475); pmid: [10466147](https://pubmed.ncbi.nlm.nih.gov/10466147/)
91. D. R. Gitelman, W. D. Penny, J. Ashburner, K. J. Friston, Modeling regional and psychophysiological interactions in fMRI: The importance of hemodynamic deconvolution. *Neuroimage* **19**, 200–207 (2003). doi: [10.1016/S1053-8119\(03\)00058-2](https://doi.org/10.1016/S1053-8119(03)00058-2); pmid: [12781739](https://pubmed.ncbi.nlm.nih.gov/12781739/)
92. W. D. Penny et al., Comparing families of dynamic causal models. *PLoS Comput. Biol.* **6**, e1000709 (2010). doi: [10.1371/journal.pcbi.1000709](https://doi.org/10.1371/journal.pcbi.1000709); pmid: [20300649](https://pubmed.ncbi.nlm.nih.gov/20300649/)
93. Y. Benjamini, D. Yekutieli, The control of the false discovery rate in multiple testing under dependency. *Ann. Stat.* **29**, 1165–1188 (2001). doi: [10.1214/aos/1013699998](https://doi.org/10.1214/aos/1013699998)
94. J. K. Kruschke, Bayesian estimation supersedes the *t* test. *J. Exp. Psychol. Gen.* **142**, 573–603 (2013). doi: [10.1037/a0029146](https://doi.org/10.1037/a0029146); pmid: [22774788](https://pubmed.ncbi.nlm.nih.gov/22774788/)
95. R. Wetzels et al., Statistical evidence in experimental psychology: An empirical comparison using 855 *t* tests. *Perspect. Psychol. Sci.* **6**, 291–298 (2011). doi: [10.1177/1745691611406923](https://doi.org/10.1177/1745691611406923); pmid: [26168519](https://pubmed.ncbi.nlm.nih.gov/26168519/)

#### ACKNOWLEDGMENTS

We thank all participants for volunteering in this study and the associations of victims who have supported this project. We thank the medical doctors, especially M. Mialon and E. Duprey, and the staff at Cyceron (Biomedical Imaging Platform in Caen). We also thank the researchers; psychologists M. Deschamps, P. Billard, B. Marteau, R. Copalle, and C. Becquet; technicians; and administrative staff at U1077 (Caen), at "Programme 13-Novembre" in Paris, at INSERM "Délégation Régionale Nord-Ouest"

(Lille), and at INSERM "Pôle Recherche Clinique", especially K. Ammour. **Funding:** This study was funded by the French Commissariat-General for Investment (CGI) via the National Research Agency (ANR) and the "Programme d'investissement pour l'Avenir (PIA)." The study was realized within the framework of "Programme 13-Novembre" (EQUIPEX Matrice) headed by D.P. and F.E. This program is sponsored by the CNRS and INSERM and supported administratively by HESAM Université, bringing together 35 partners (see [www.memoire13novembre.fr](http://www.memoire13novembre.fr)). A.M. is funded by a 3-year postdoctoral fellowship from the Normandy region. **Author contributions:** J.D., D.P., F.E., and P.G. designed the study. J.D., D.P., F.E., C.K.-P., and P.G. obtained the financial support. A.M., C.P., and T.V. performed the data acquisition. C.M. and F.F. managed and coordinated the research activity planning and execution. F.V. and V.d.I.S. supervised MRI data collection on human participants and medical interviews. V.d.I.S. supervised the medical aspects of the study, and J.D. supervised SCID interviews and psychiatric examinations. A.M. and P.G. analyzed the behavioral and functional data with the help of G.L. and C.P. A.M. and P.G. wrote the original draft. All authors reviewed and edited the manuscript. **Competing interests:** The authors declare no competing interests. **Data and materials availability:** The data and code that support the conclusions of this study are available in the main text and the supplementary material.

#### SUPPLEMENTARY MATERIALS

[science.sciencemag.org/content/367/6479/eaay8477/suppl/DC1](https://science.sciencemag.org/content/367/6479/eaay8477/suppl/DC1)  
Figs. S1 to S5  
Tables S1 to S15

[View/request a protocol for this paper from Bio-protocol.](#)

25 July 2019; accepted 12 December 2019  
10.1126/science.aay8477

## Resilience after trauma: The role of memory suppression

Alison Mary, Jacques Dayan, Giovanni Leone, Charlotte Postel, Florence Fraise, Carine Malle, Thomas Vallée, Carine Klein-Peschanski, Fausto Viader, Vincent de la Sayette, Denis Peschanski, Francis Eustache and Pierre Gagnepain

*Science* **367** (6479), eaay8477.  
DOI: 10.1126/science.aay8477

### Memory suppression can help after trauma

Therapists have discussed for a long time whether attempts to voluntarily suppress the intrusion of trauma memories are helpful to combat the distressing impacts of trauma. Mary *et al.* studied survivors of the 2015 Paris terrorist attacks who developed posttraumatic stress disorder and those who did not (see the Perspective by Ersche). Using functional magnetic resonance imaging, they investigated the neural networks underlying the control and suppression of memory retrieval. The results suggest that the characteristic symptoms of the disorder are not related to the memory itself but to its maladaptive control. These results offer new insights into the development of post-traumatic stress disorder and potential avenues for treatment.

*Science*, this issue p. eaay8477; see also p. 734

#### ARTICLE TOOLS

<http://science.sciencemag.org/content/367/6479/eaay8477>

#### RELATED CONTENT

<http://stm.sciencemag.org/content/scitransmed/11/486/eaal3236.full>  
<http://stm.sciencemag.org/content/scitransmed/5/188/188ra73.full>

#### REFERENCES

This article cites 90 articles, 8 of which you can access for free  
<http://science.sciencemag.org/content/367/6479/eaay8477#BIBL>

#### PERMISSIONS

<http://www.sciencemag.org/help/reprints-and-permissions>

Use of this article is subject to the [Terms of Service](#)

---

*Science* (print ISSN 0036-8075; online ISSN 1095-9203) is published by the American Association for the Advancement of Science, 1200 New York Avenue NW, Washington, DC 20005. The title *Science* is a registered trademark of AAAS.

Copyright © 2020 The Authors, some rights reserved; exclusive licensee American Association for the Advancement of Science. No claim to original U.S. Government Works