



HAL
open science

Les royaumes hellénistiques d'Asie centrale : politiques et pratiques monétaires (3^e siècle av. J.-C. – 1^{er} s. ap. J.-C.)

Olivier Bordeaux

► To cite this version:

Olivier Bordeaux. Les royaumes hellénistiques d'Asie centrale : politiques et pratiques monétaires (3^e siècle av. J.-C. – 1^{er} s. ap. J.-C.). Master. Monnaie, politique et économie dans le monde grec antique, Maison de la recherche, Sorbonne-Université, France. 2023. halshs-04607454

HAL Id: halshs-04607454

<https://shs.hal.science/halshs-04607454v1>

Submitted on 10 Jun 2024

HAL is a multi-disciplinary open access archive for the deposit and dissemination of scientific research documents, whether they are published or not. The documents may come from teaching and research institutions in France or abroad, or from public or private research centers.

L'archive ouverte pluridisciplinaire **HAL**, est destinée au dépôt et à la diffusion de documents scientifiques de niveau recherche, publiés ou non, émanant des établissements d'enseignement et de recherche français ou étrangers, des laboratoires publics ou privés.



Distributed under a Creative Commons Attribution - NonCommercial - NoDerivatives 4.0 International License

Olivier BORDEAUX

Les royaumes hellénistiques d'Asie centrale : politiques et pratiques monétaires (3^e siècle av. J.-C. – 1^{er} s. ap. J.-C.)



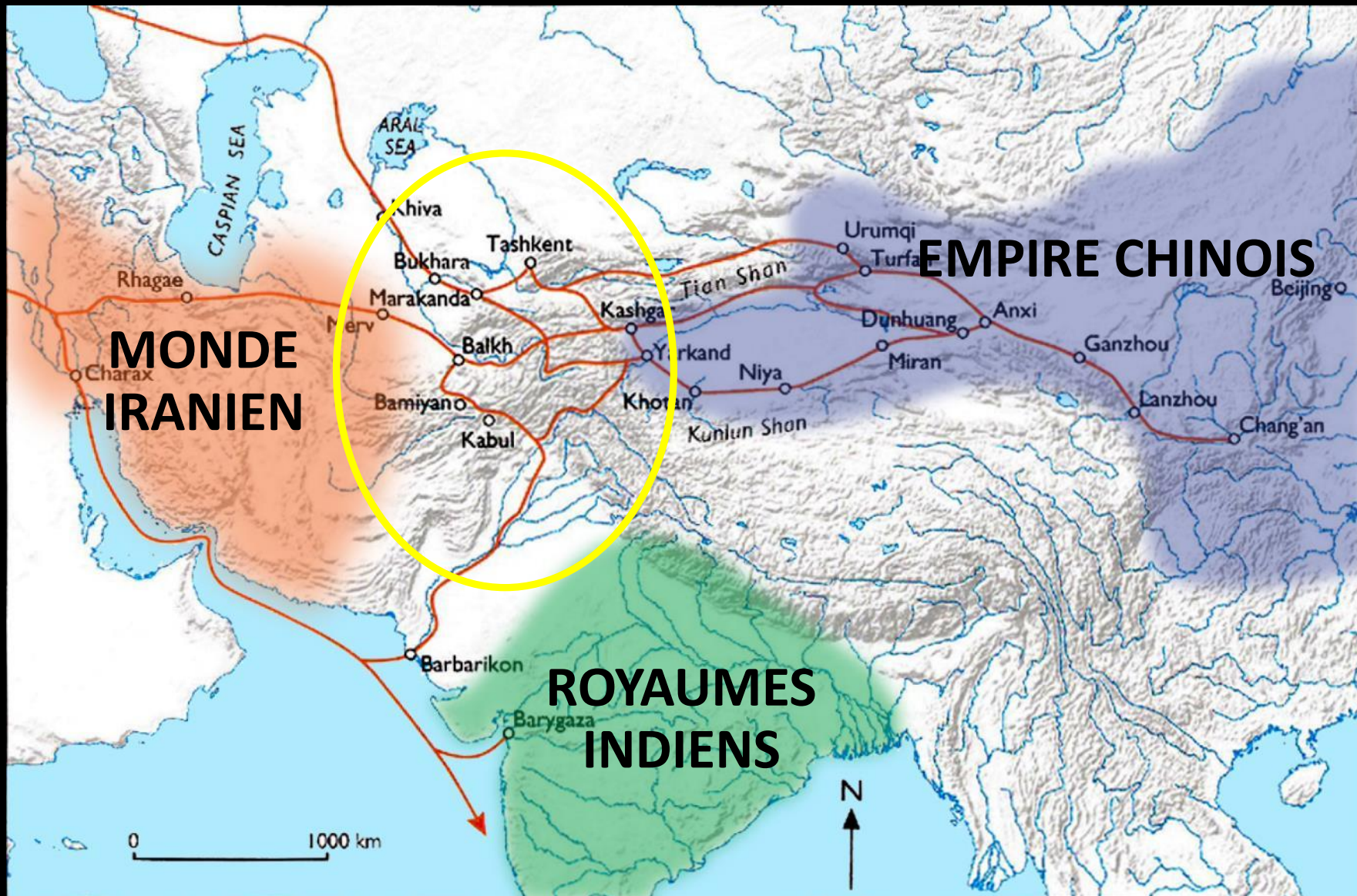

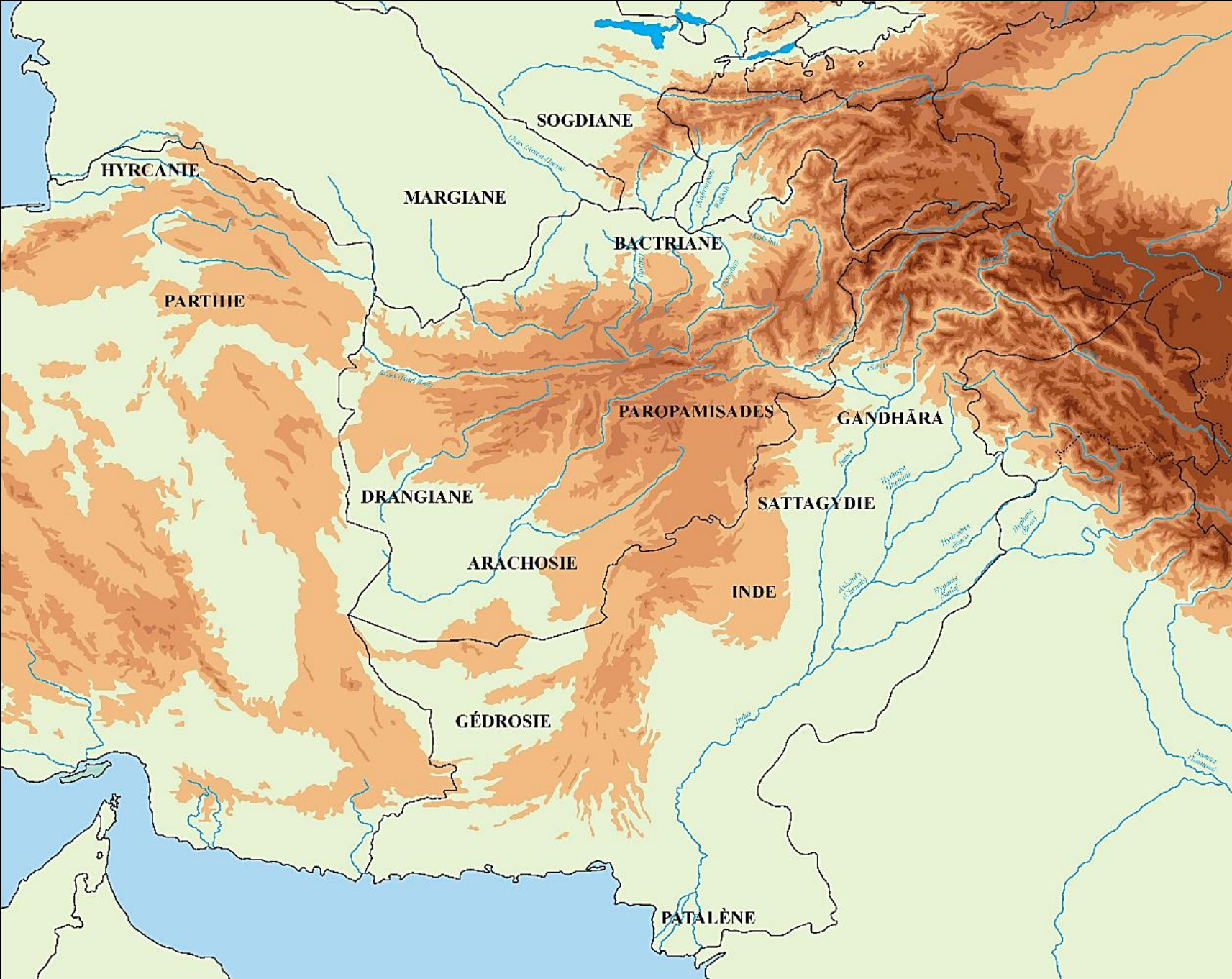





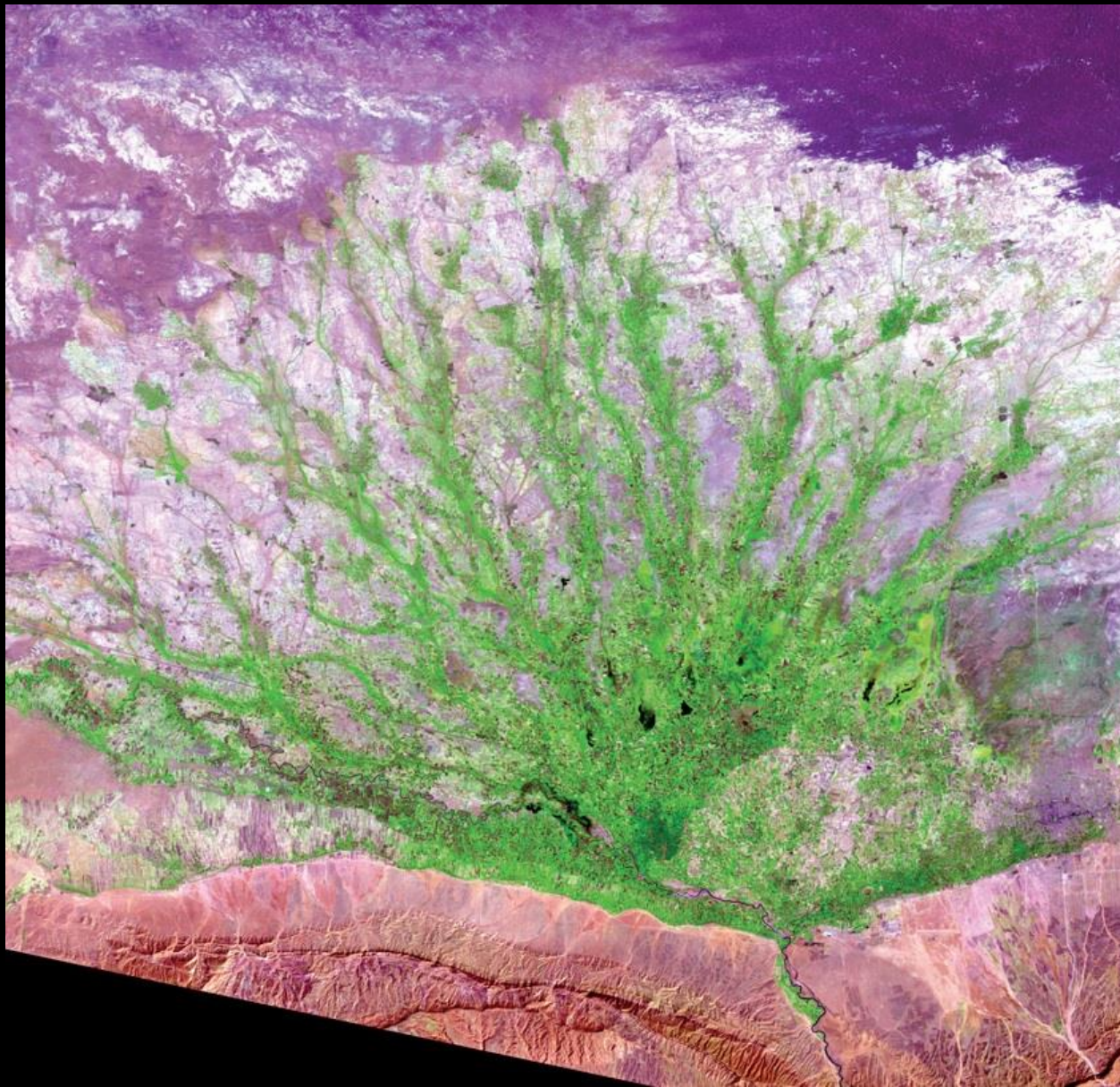

Plaines agricoles de Bactres et d'Aï Khanoum (Afghanistan) et leur système de canaux



Quelle trace avons-nous, architecturale, sculpturale, picturale ou simplement textuelle que les mêmes *self-made* Basileis aient pour leurs convenances personnelles appelé à leur cour des artistes autres que des graveurs (...)? – La réponse est, hélas, que nous n'en avons aucune.

(...) Il apparaît même, dès qu'on y regarde de près, qu'il n'est que le produit d'une hallucination provoquée par l'éblouissement de nos yeux européens devant la perfection de la numismatique gréco-bactrienne.

(A. Foucher 1947, p. 310-311)

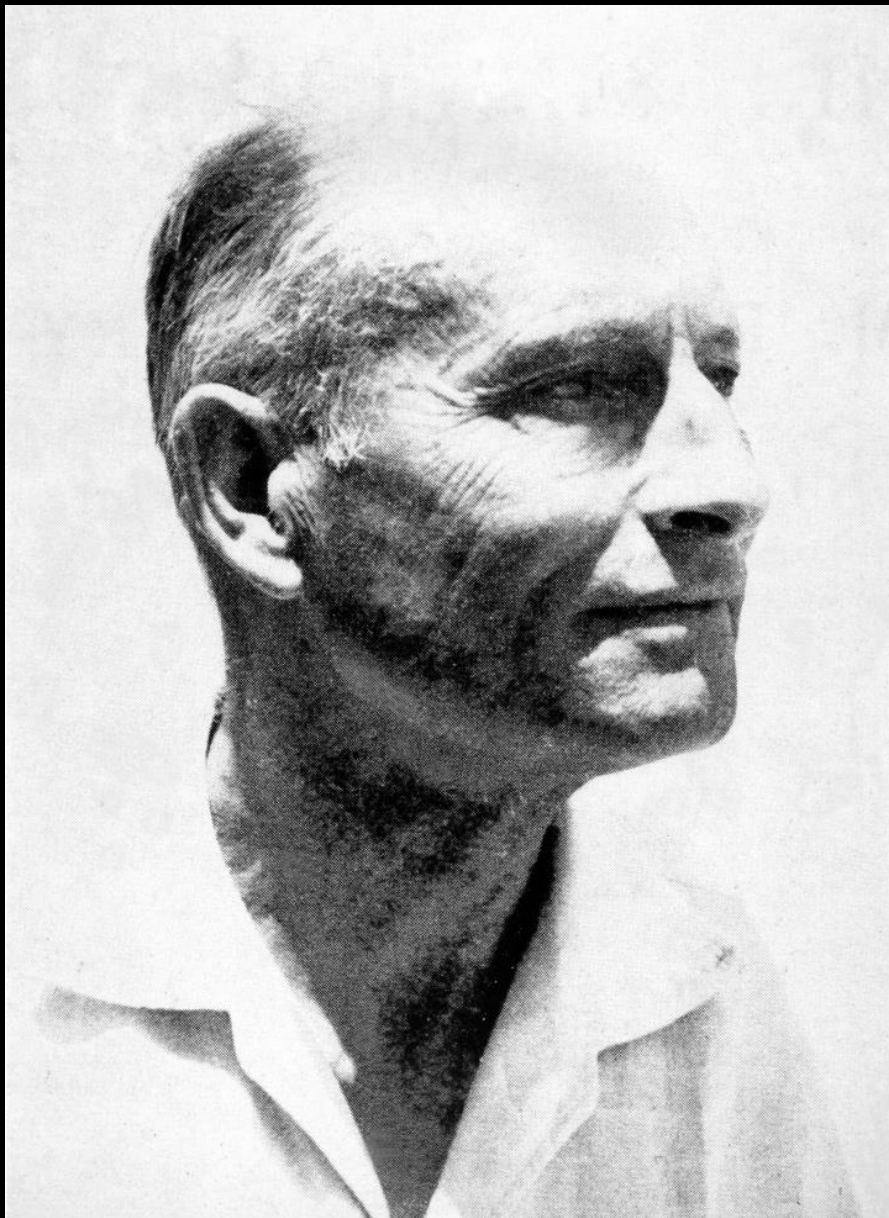

Daniel Schlumberger (1904 – 1972) © DAFA

L'ARGENT GREC DANS L'EMPIRE ACHÉMÉNIDE

A propos d'un trésor d'époque
perse découvert à Caboul
(*Trouaille du Tchaman-i Hazouri*)

PAR

DANIEL SCHLUMBERGER



“Monnaies d'une espèce nouvelle”



Raoul Curiel (1913 – 2000)

© Rika Gyselen

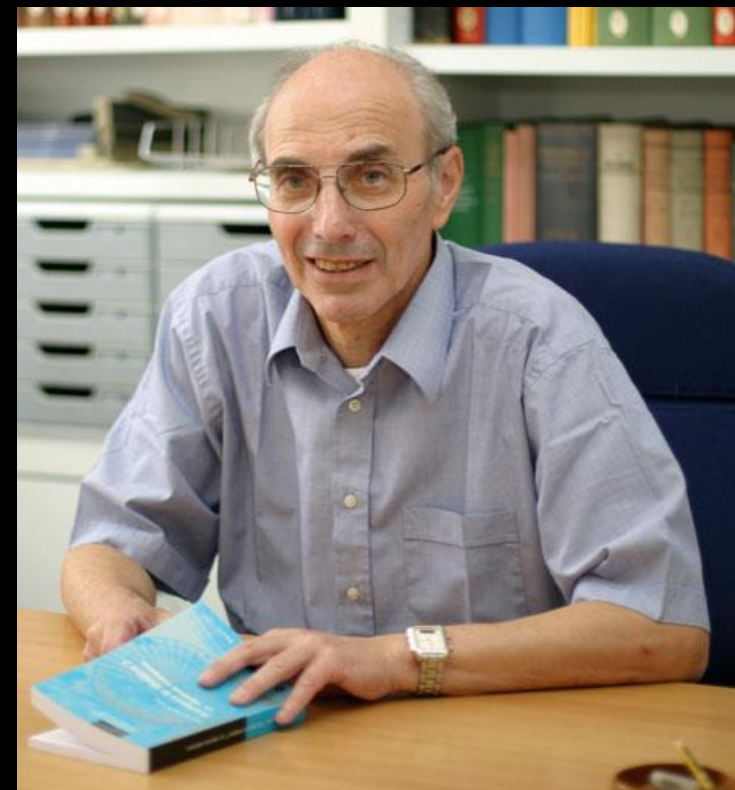
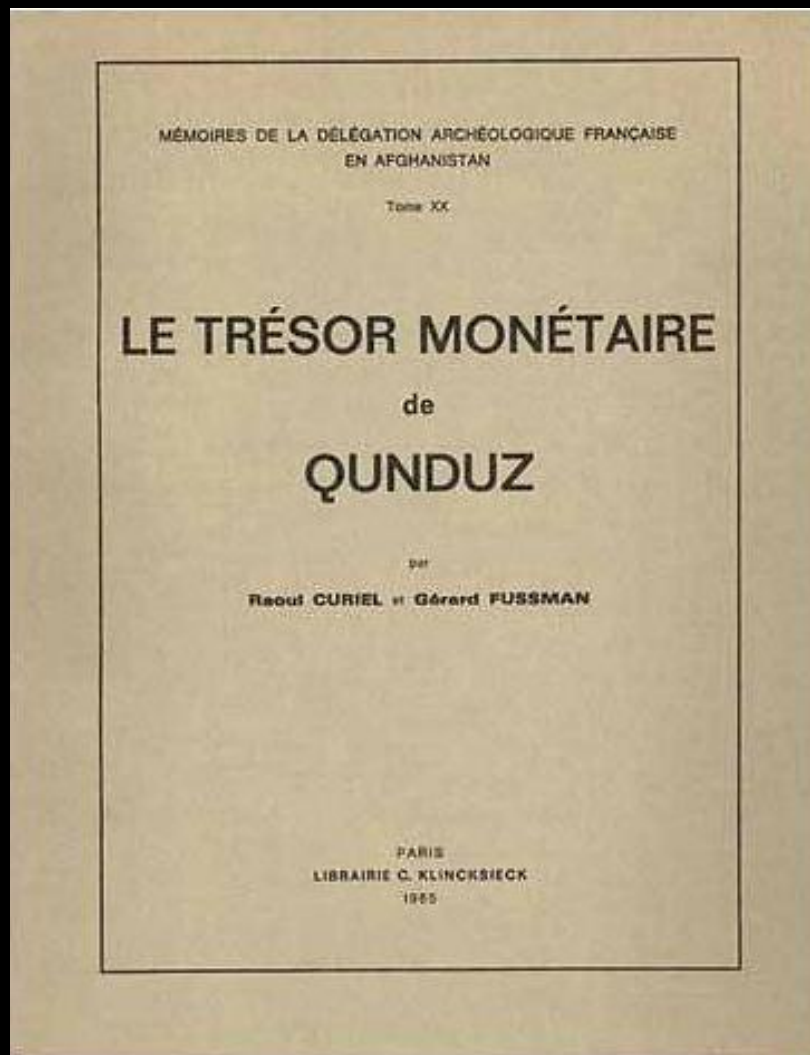

Gérard Fussman (1940 – 2022)

© Collège de France



Le temple à niches indentées d'Aï Khanoum (Afghanistan)



Objets du « trésor de l'Oxus »

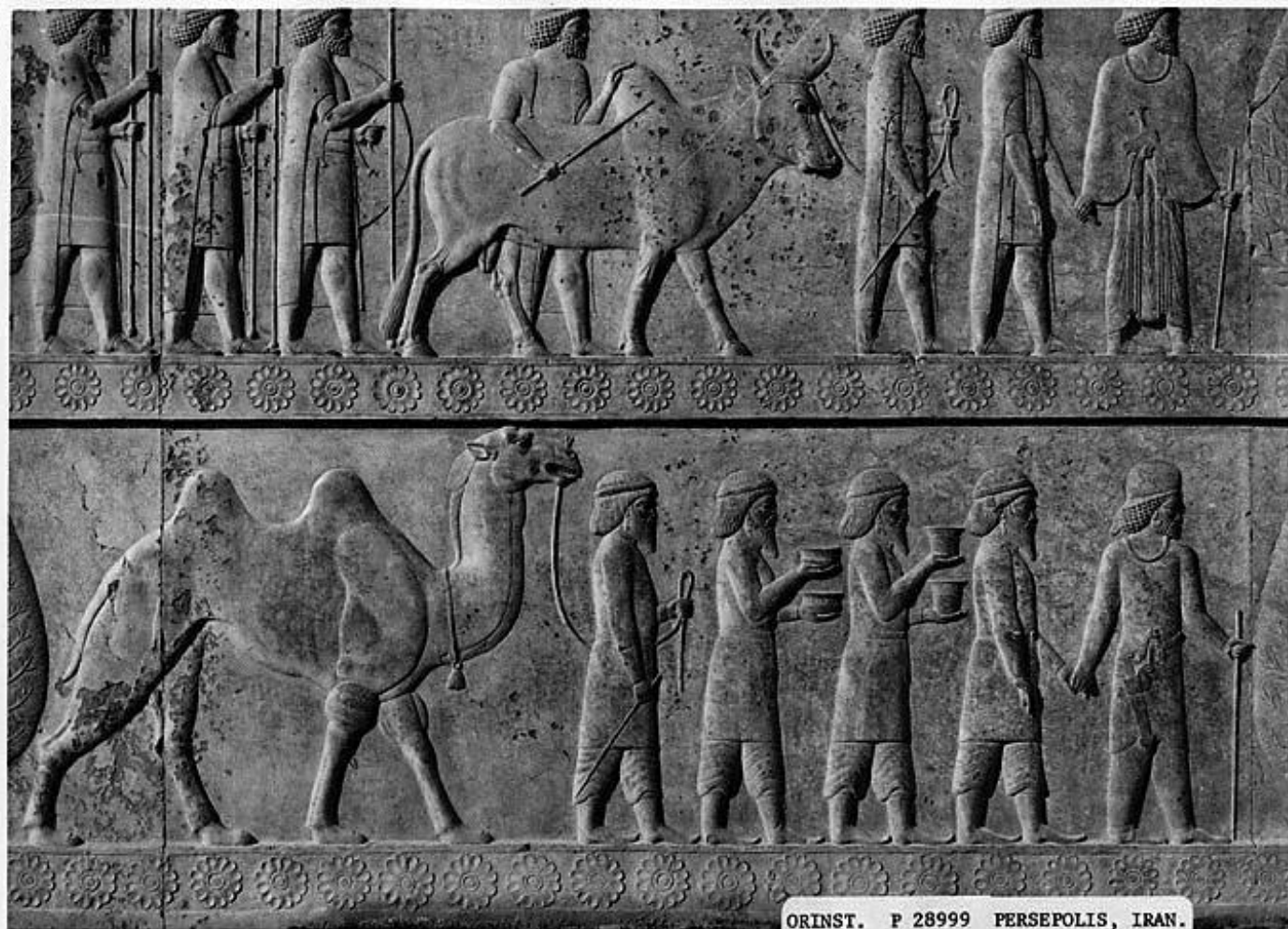

ORINST. P 28999 PERSEPOLIS, IRAN.
APADANA. TRIBUTE PROCESSION. THE
BACTRIAN DELEGATION. THE EASTERN
STAIRWAY.

E6

Les Gandhariens et les Bactriens sur
l'escalier de l'Apadana de Persépolis (Iran)



Dionysos sous la vigne, amphore attique du V^e siècle

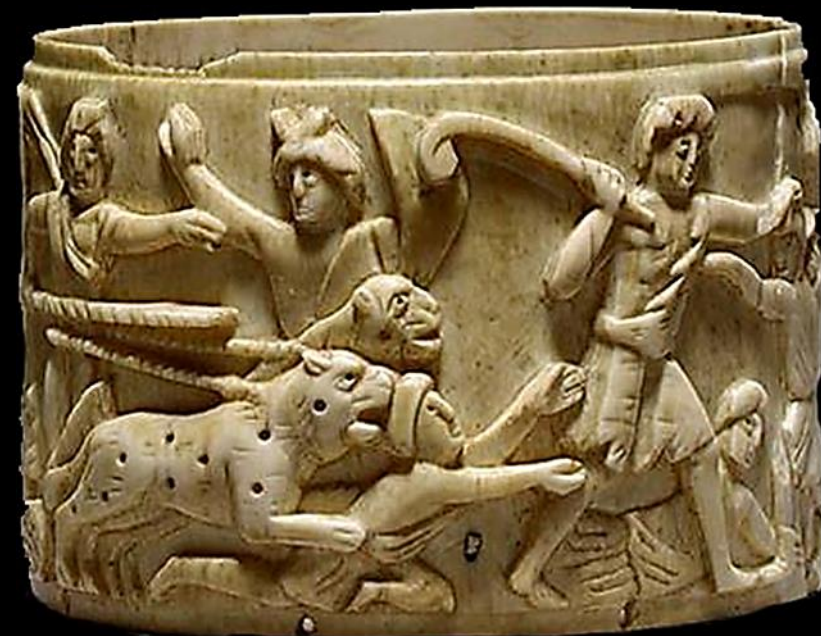

Pyxis décoré du triomphe de Dionysos
(peut-être fabriqué en Syrie, trouvé à Rome)



Séleucos I^{er} (305-281)



Agathocle (180-176)

L'EMPIRE D'ALEXANDRE : CONTRÔLE ET RECONNAISSANCE

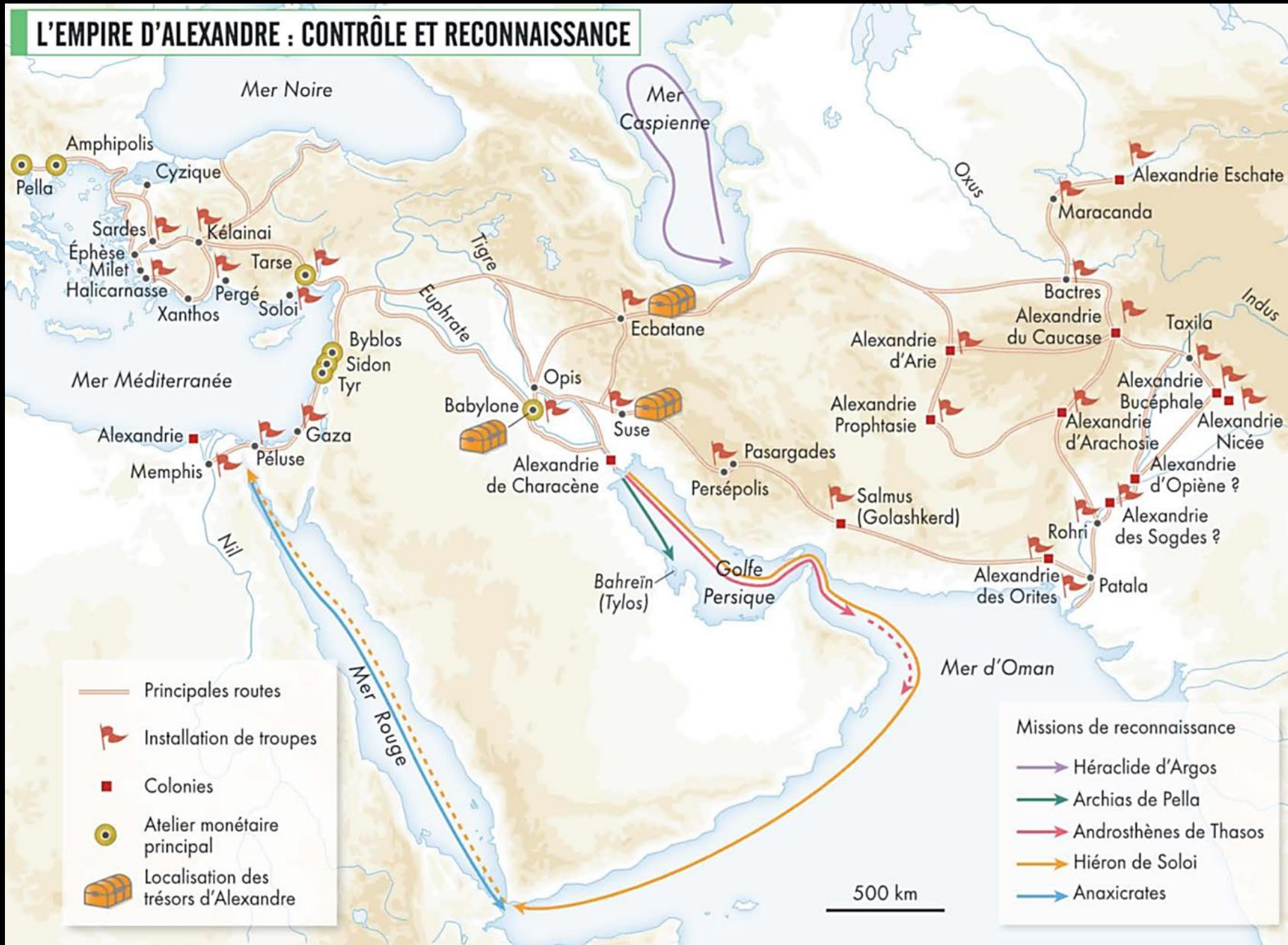

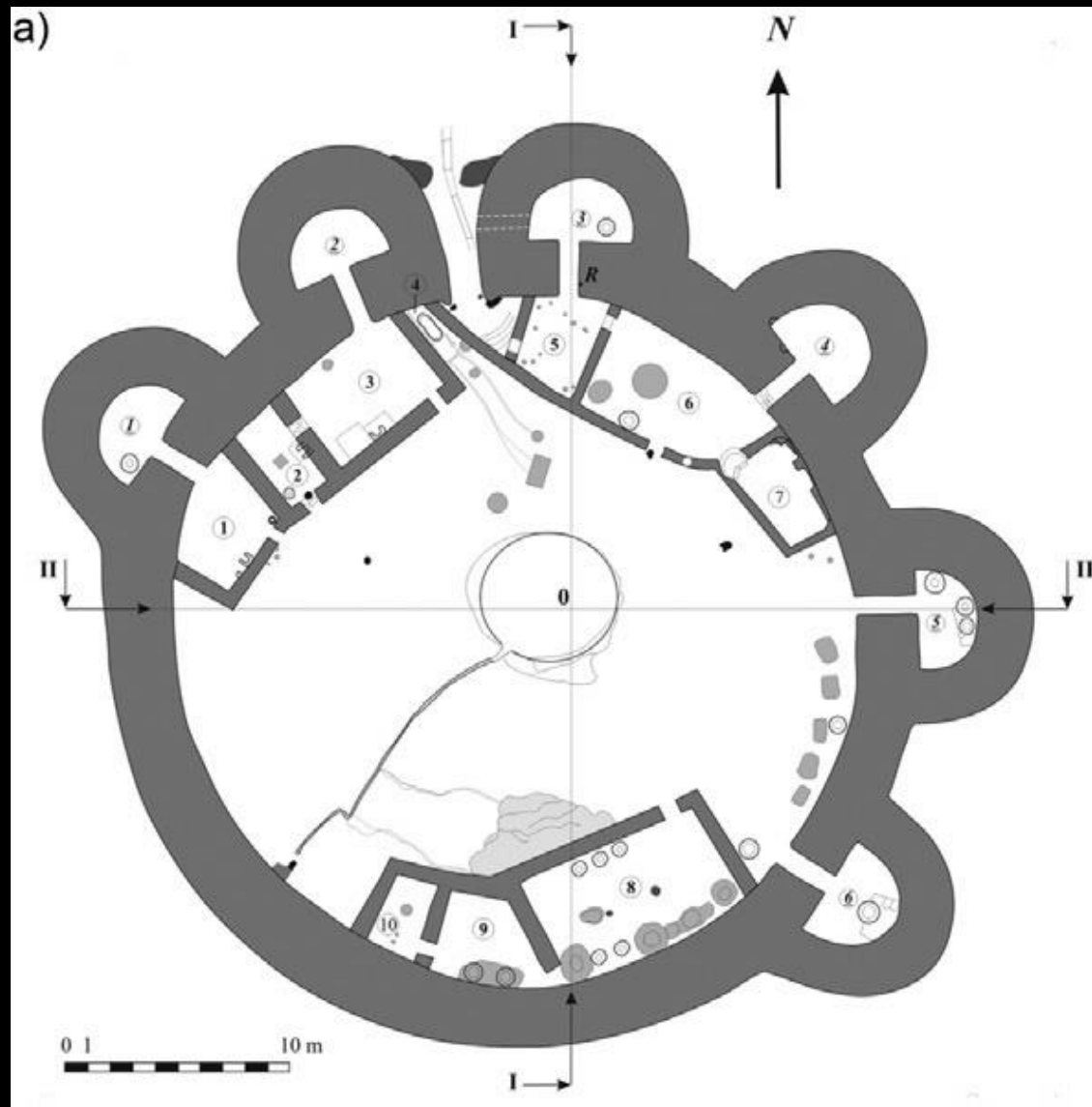

Plan de la citadelle de Kurganzol (Ouzbékistan)



Le médaillon d'Alexandre



Imitations de chouettes athéniennes



Série « à l'aigle »



Monnaies de Sôphytos



Monnaies d'Andragoras

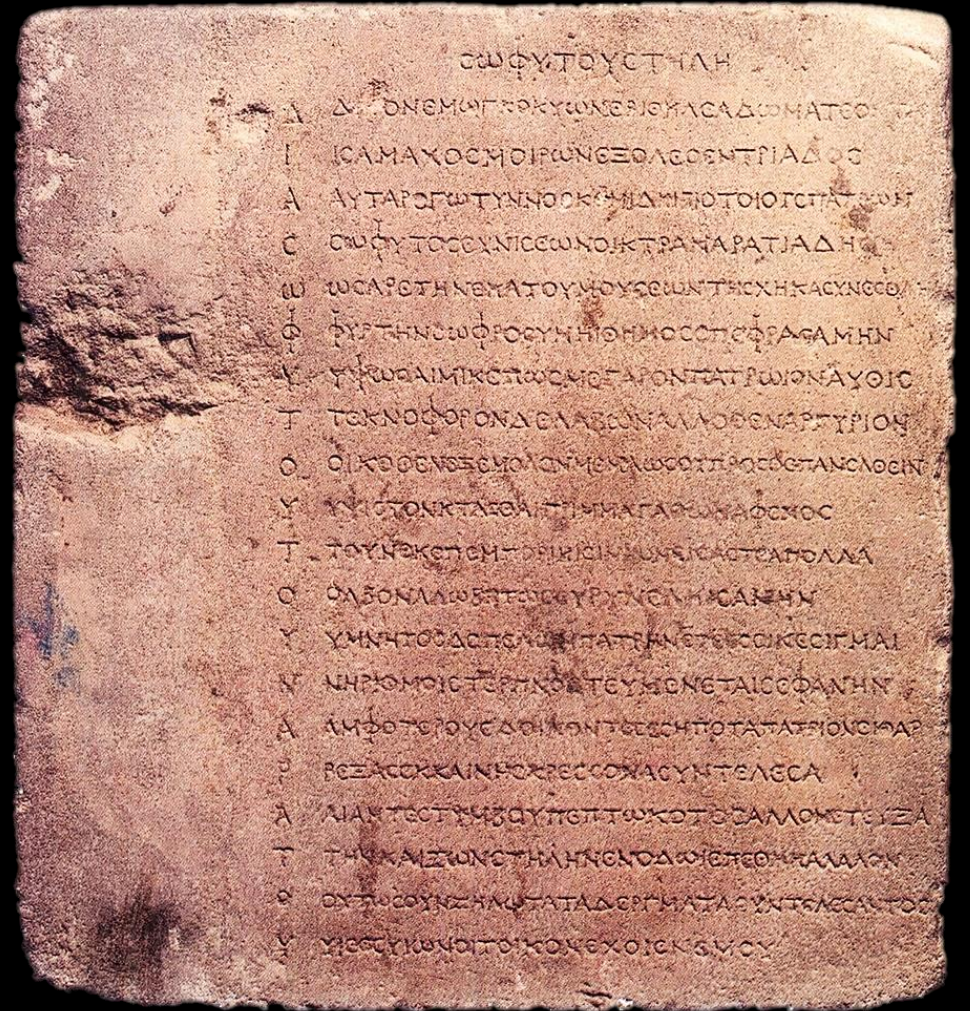

Épigramme de Sôphytos (entre 200 av. J.-C. et 100 ap. J.-C.), découverte à Kandahar (Afghanistan)



Tétradrachmes frappés en
Parthie par Andragoras
(247-239 BCE) (© BNF & CNG)



Intaille d'Égypte (?),
Début du 2^e s. av. J.-C.
(© BNF)

O. Bordeaux, « Sôphytos et Andragoras.
Deux cas de monnayages autonomistes
entre Bactriane et Parthie séleucides »,
*Monuments et mémoires de la Fondation
Eugène Piot*, 99, 2021, p. 77-154



Briques à glaçure silicieuse de Suse
(Louvre Sb 21240)



Artaxerxès II (404-358 av. J.-C.) à Persépolis
(© Wikimedia Commons)



Tête de Musa de Parthie (2 av. – 4 ap. J.-C.) trouvée à Suse
(© Wikimedia Commons)



“Monnaies d’une espèce nouvelle”, 5^e s. av. J.-C.

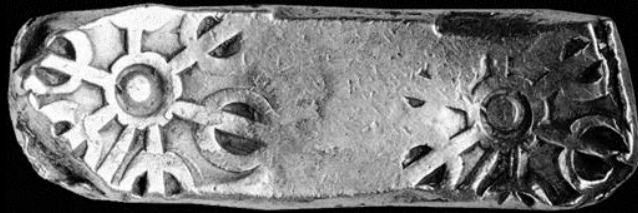

Barres incurvées, 5^e/4^e s. av. J.-C.



« Punch-marked coins », 3^e s. av. J.-C.



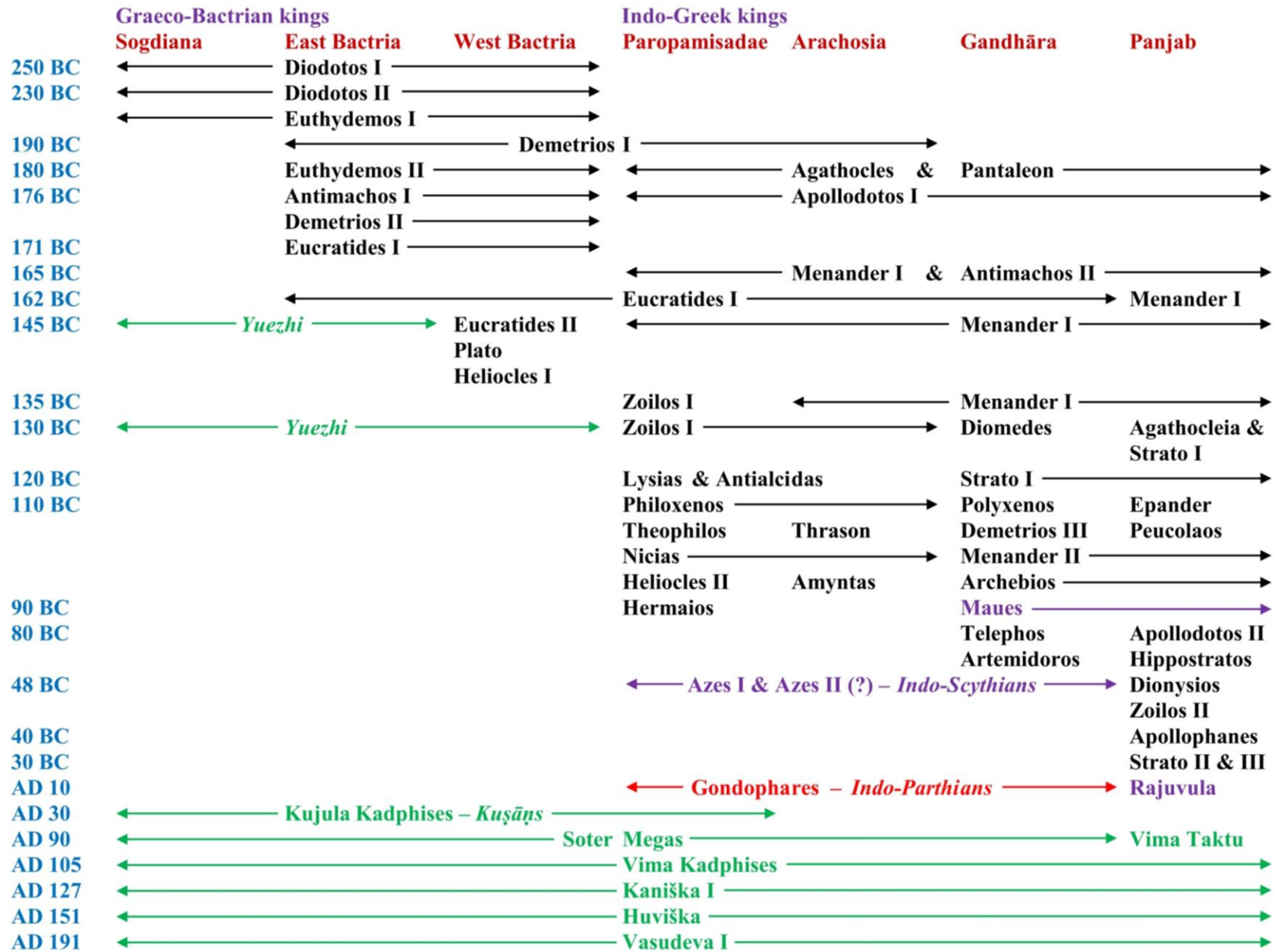

Bronzes bilingues frappés en territoire indiens par Agathocle et Pantaléon (180-176 av. J.-C.)

(© CNG)

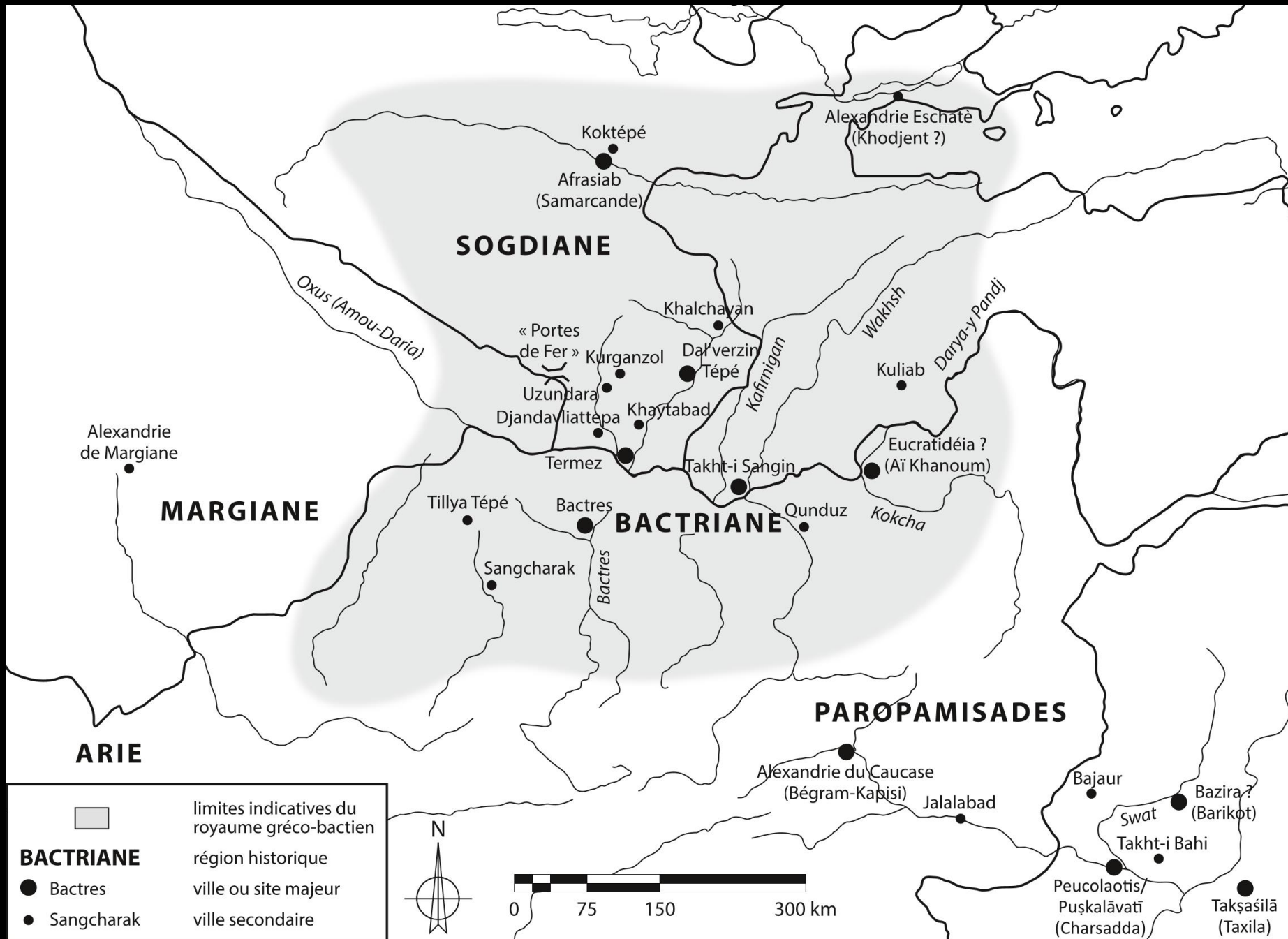



	limites indicatives du royaume gréco-bactien
BACTRIANE	région historique
	Bactres
	Sangcharak
	ville ou site majeur
	ville secondaire





0 75 150 300 km



Monnaie de vingt statères (169,20 g) frappée par Eucratide I^{er} (171-145 avant J.-C.) © BNF

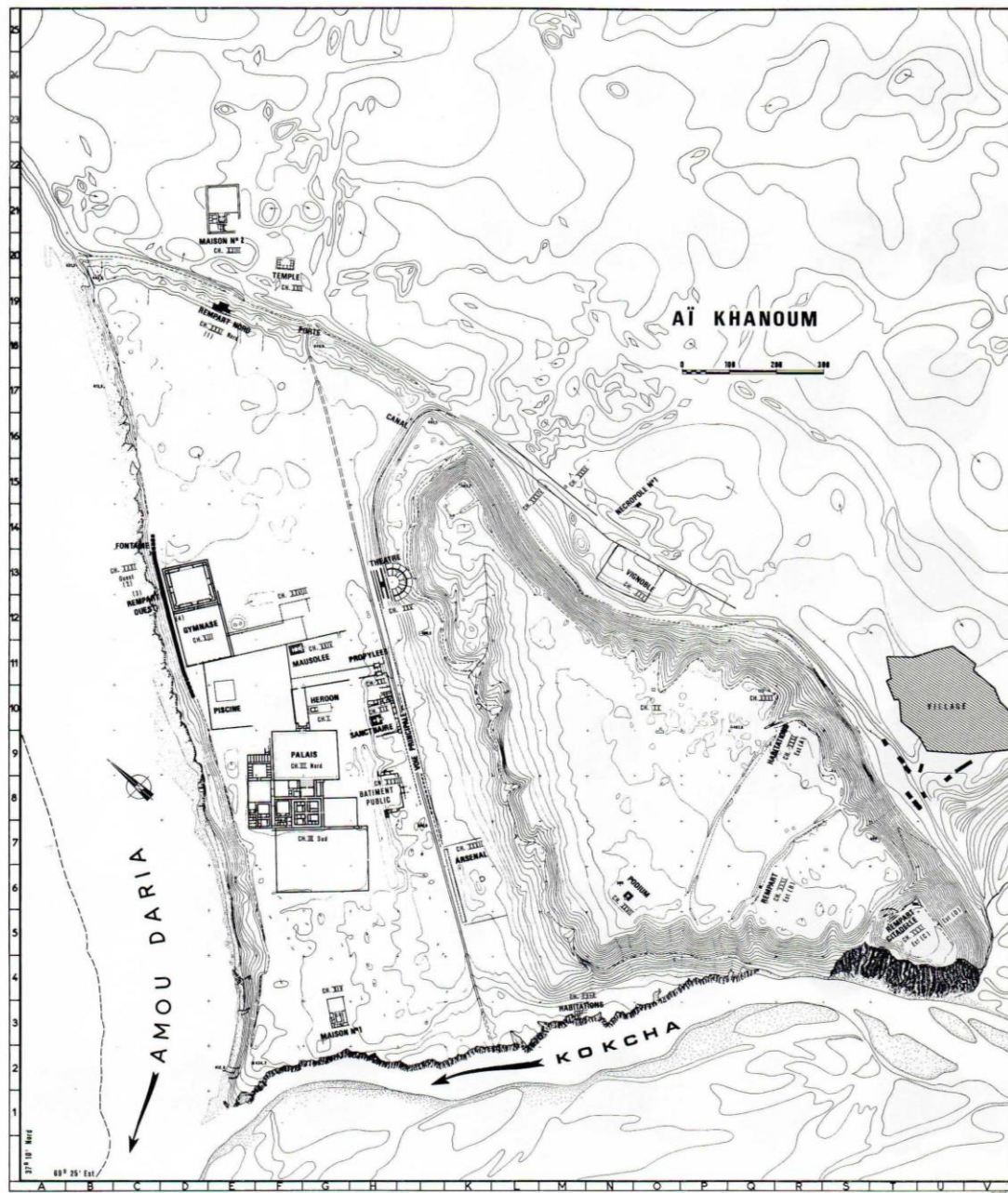

Plan du site avec les différents chantiers (dessin de J.-Cl. Liger).





Παῖς ὦν κόσμιος γίνου,
ἡβῶν ἐγκρατής,
μέσος δίκαιος,
πρεσβύτης εὐβουλος,
τελευτῶν ἄλυπος.

*Dans ton enfance, sois bien sage,
dans ta jeunesse, maitre de toi ;
au milieu de ta vie, sois juste,
dans ta vieillesse, de bon conseil,
au moment de ta mort, sans chagrin.*

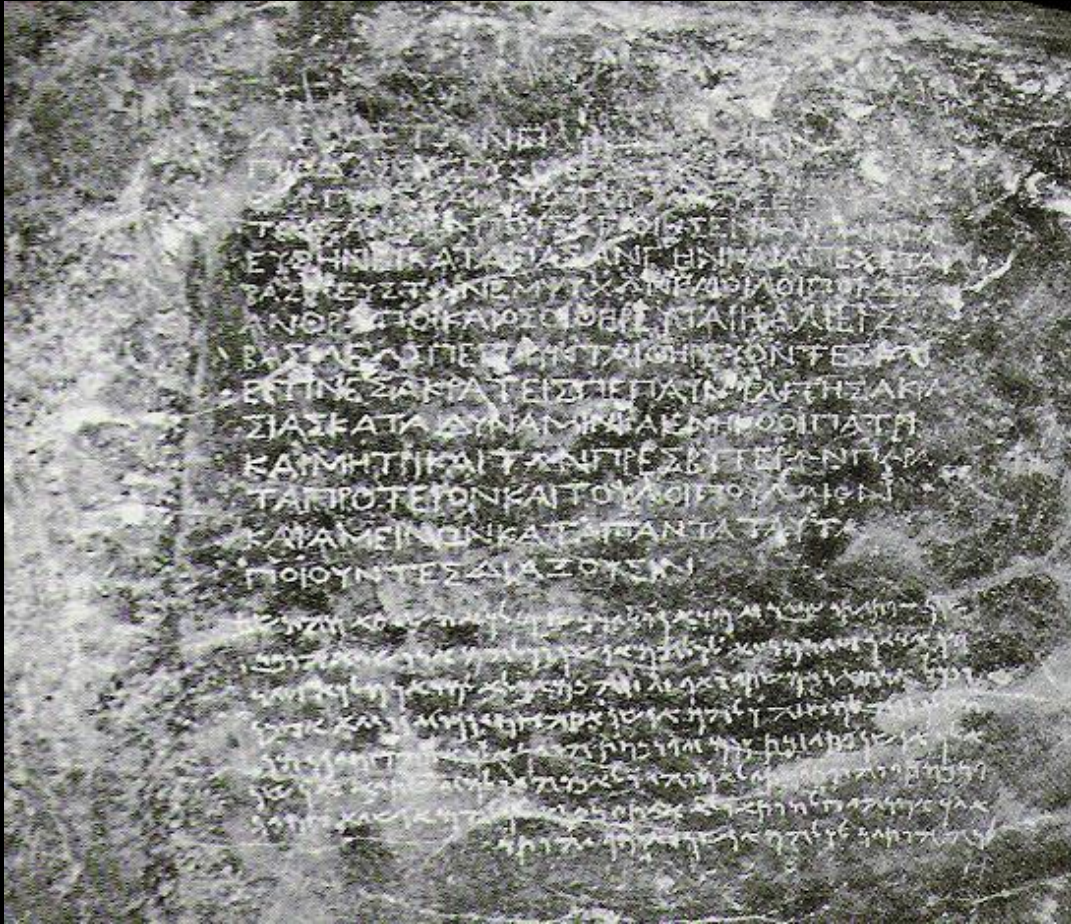

Edit bilingue d'Asoka (304-232 av. J.-C.)

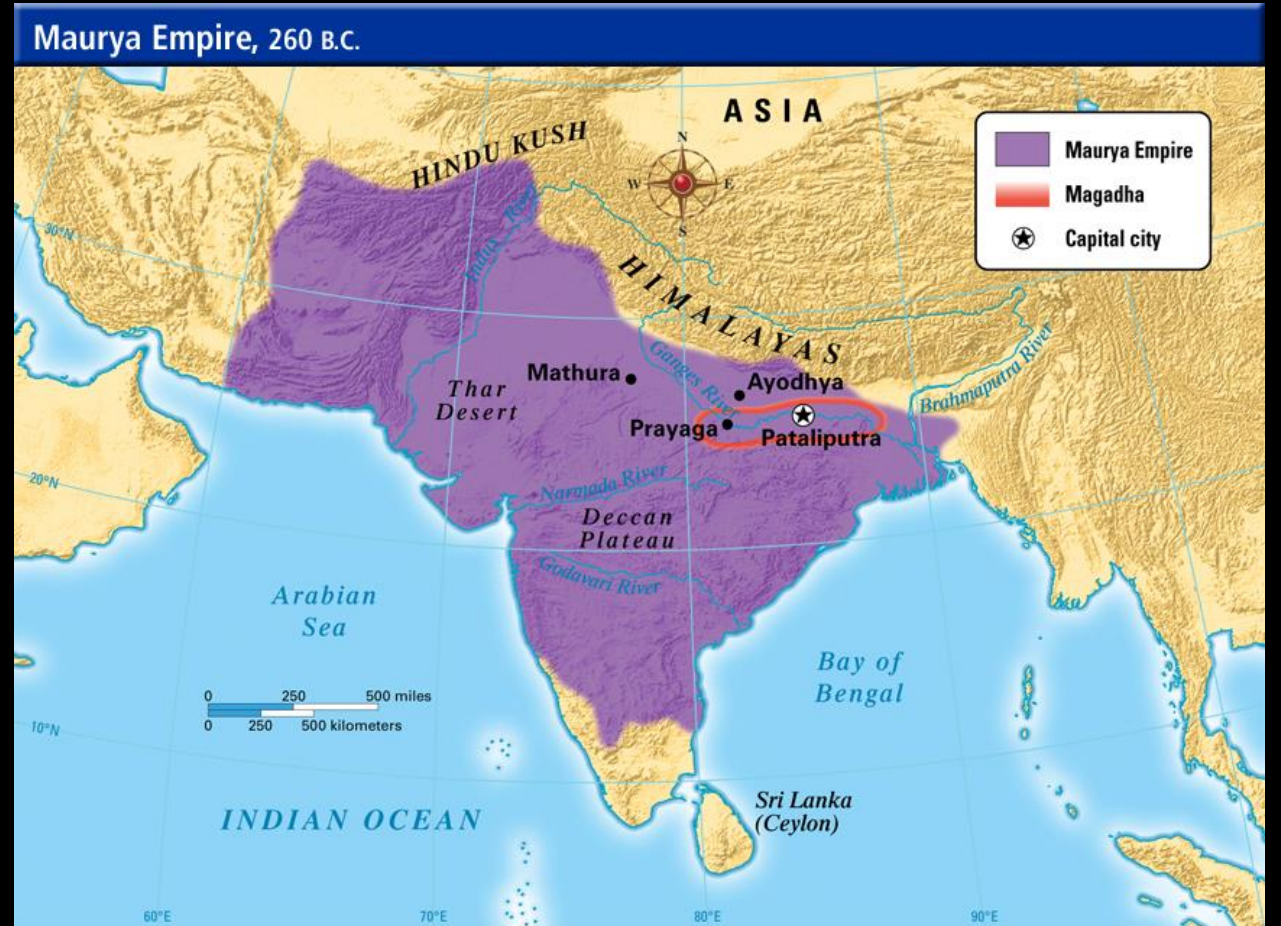

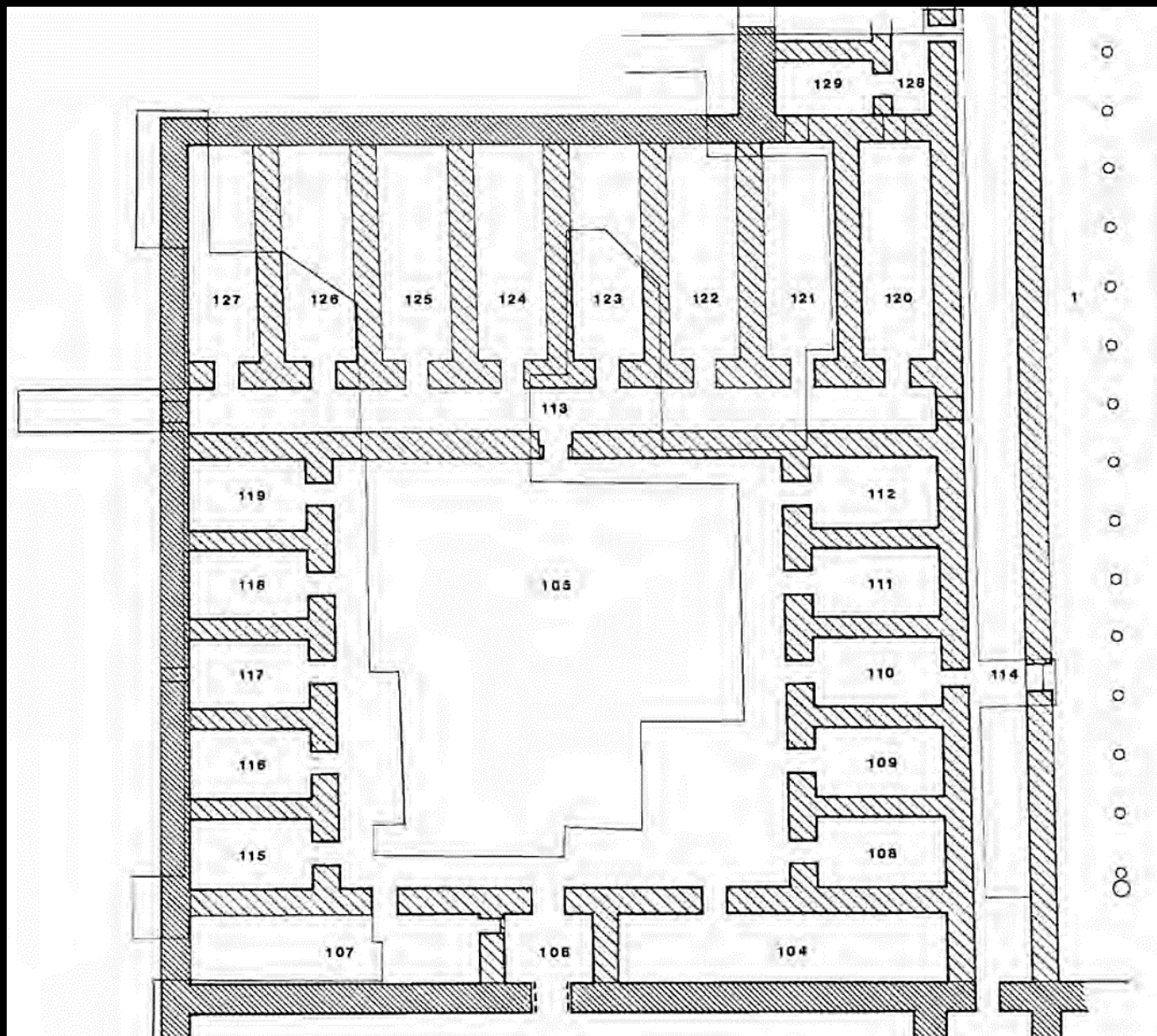

La trésorerie du palais hellénistique d'Aï Khanoum

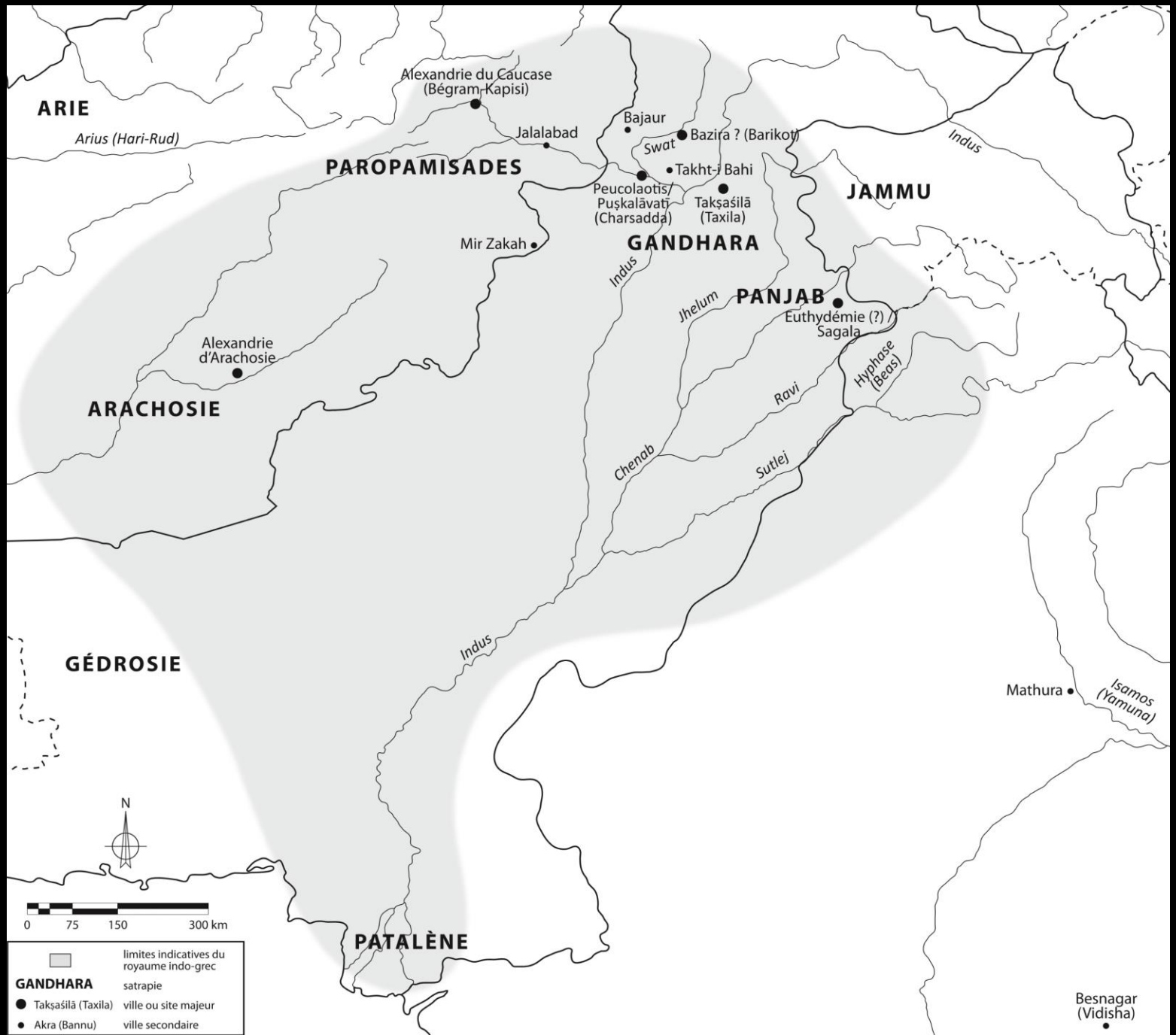



Double décadrachme d'Amyntas (95-90 av. J.-C.)

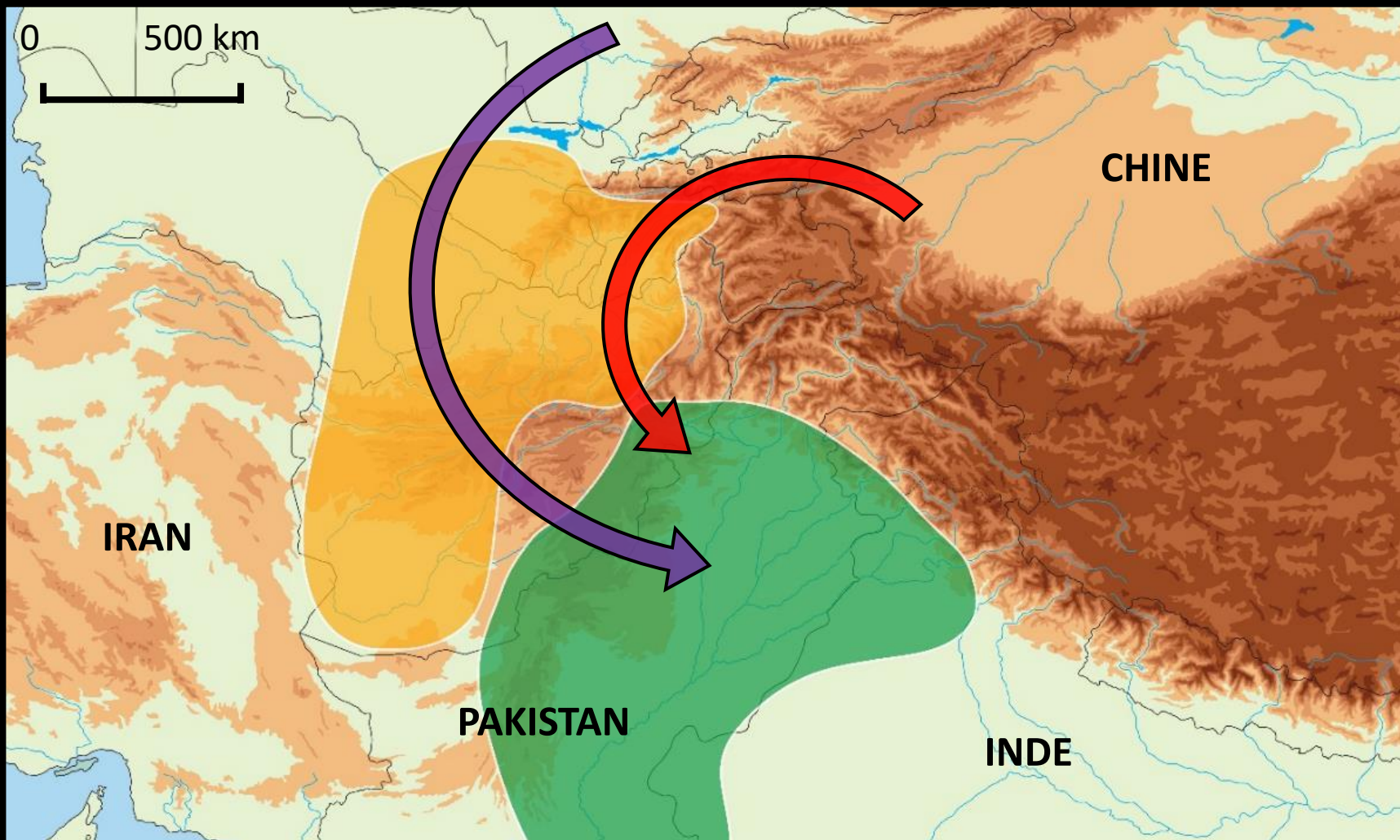

Arrivée des Scythes et des Yuezhi en Asie centrale, milieu du II^e siècle avant J.-C.



Khaltchayan
(mi-I^{er} s. apr.)



Tétradrachme d'Héraios
(I^{er} s. av. - I^{er} s. apr. J.-C.)

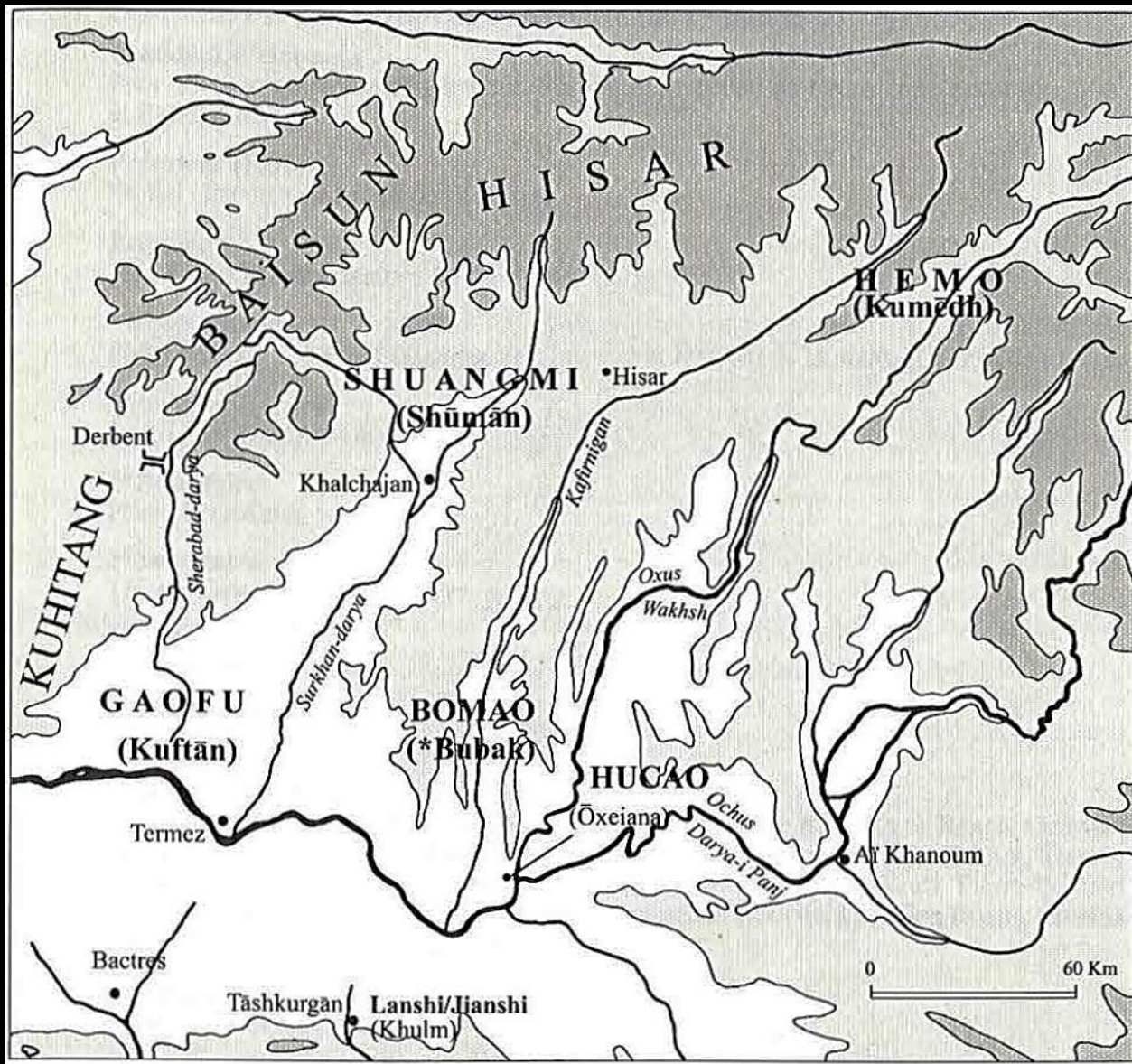

« ΚΟΡΡΑΝΟΥ »

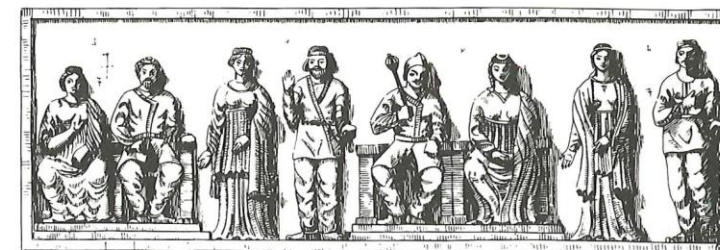

A



B

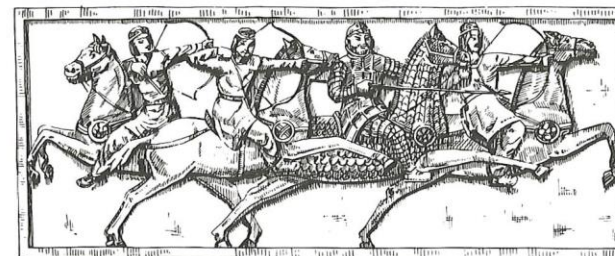

C

Tentative de restitution des cinq clans Yuezhi en Bactriane

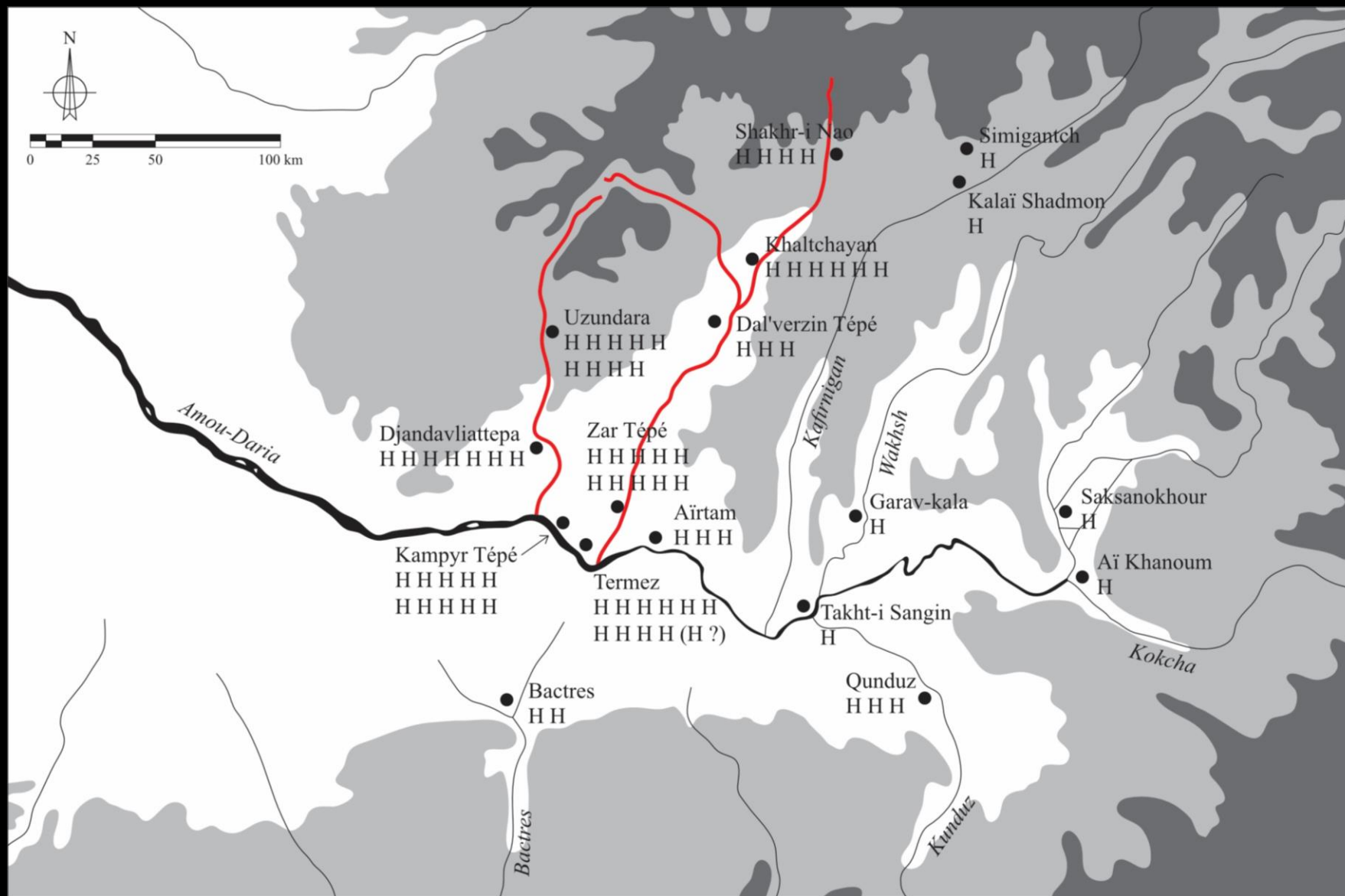

Répartition des imitations d'Hélioclès I^{er} dans la vallée de l'Oxus
(O. Bordeaux, R. Besenval, P. Marquis, N. Rassoli, « Les monnaies hellénistiques et kouchanes des fouilles franco-afghanes de Bactres (Balkh, Afghanistan) », *Revue Numismatique*, 2019)



Eucratide I^{er}
(171-145)

Hélioclès I^{er}
(145-130)





Coin de revers de la période gréco-bactrienne (Démétrios I^{er})

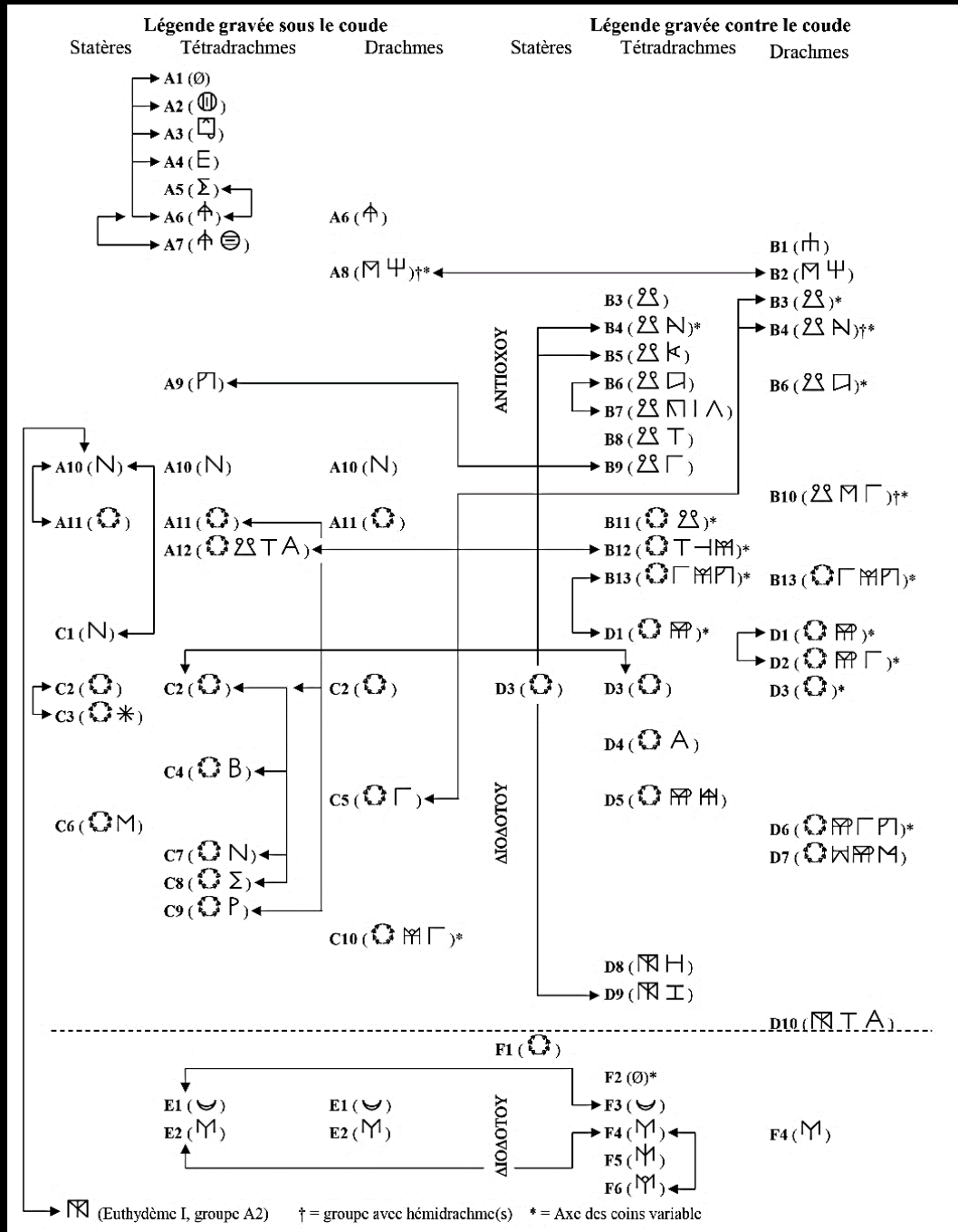

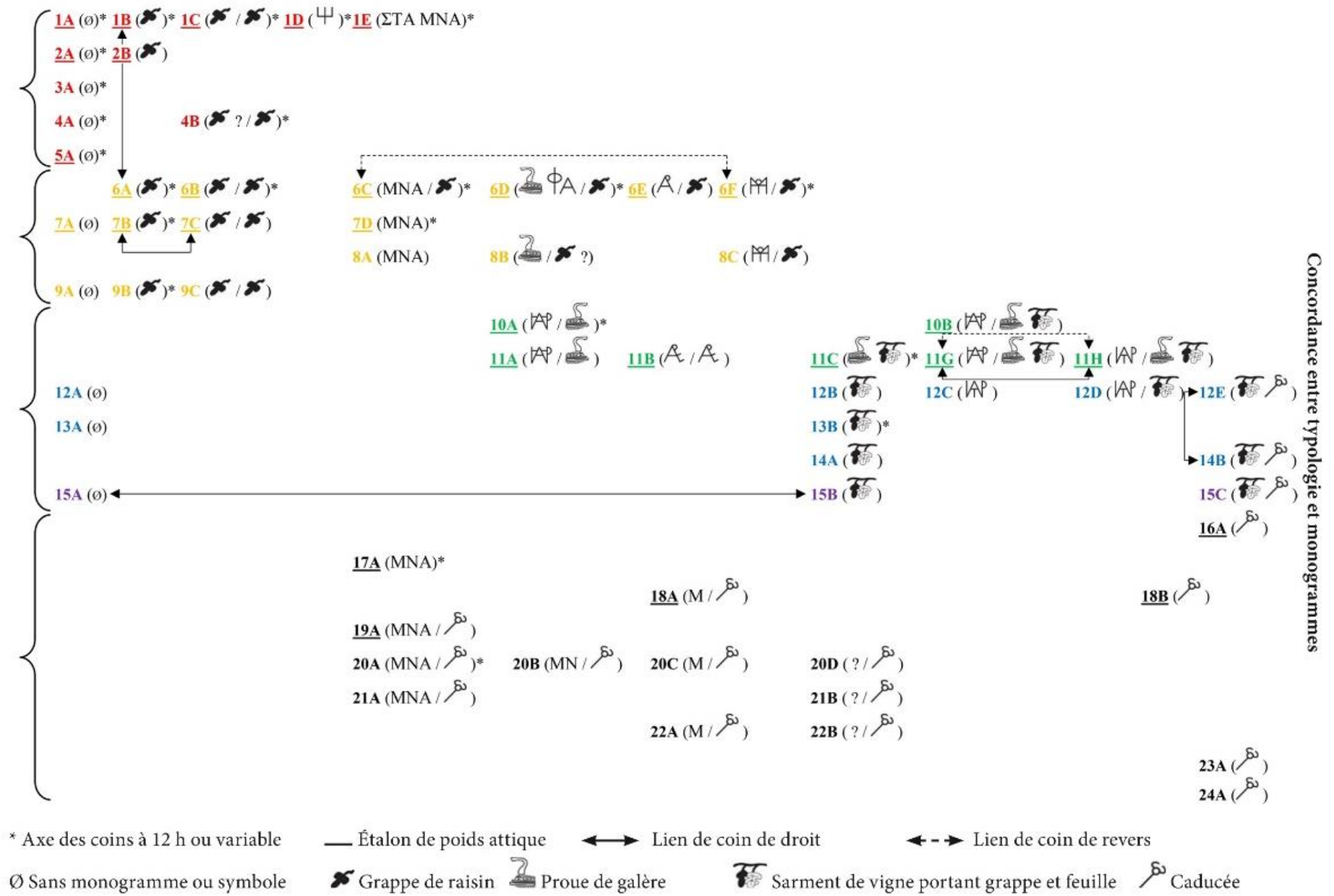
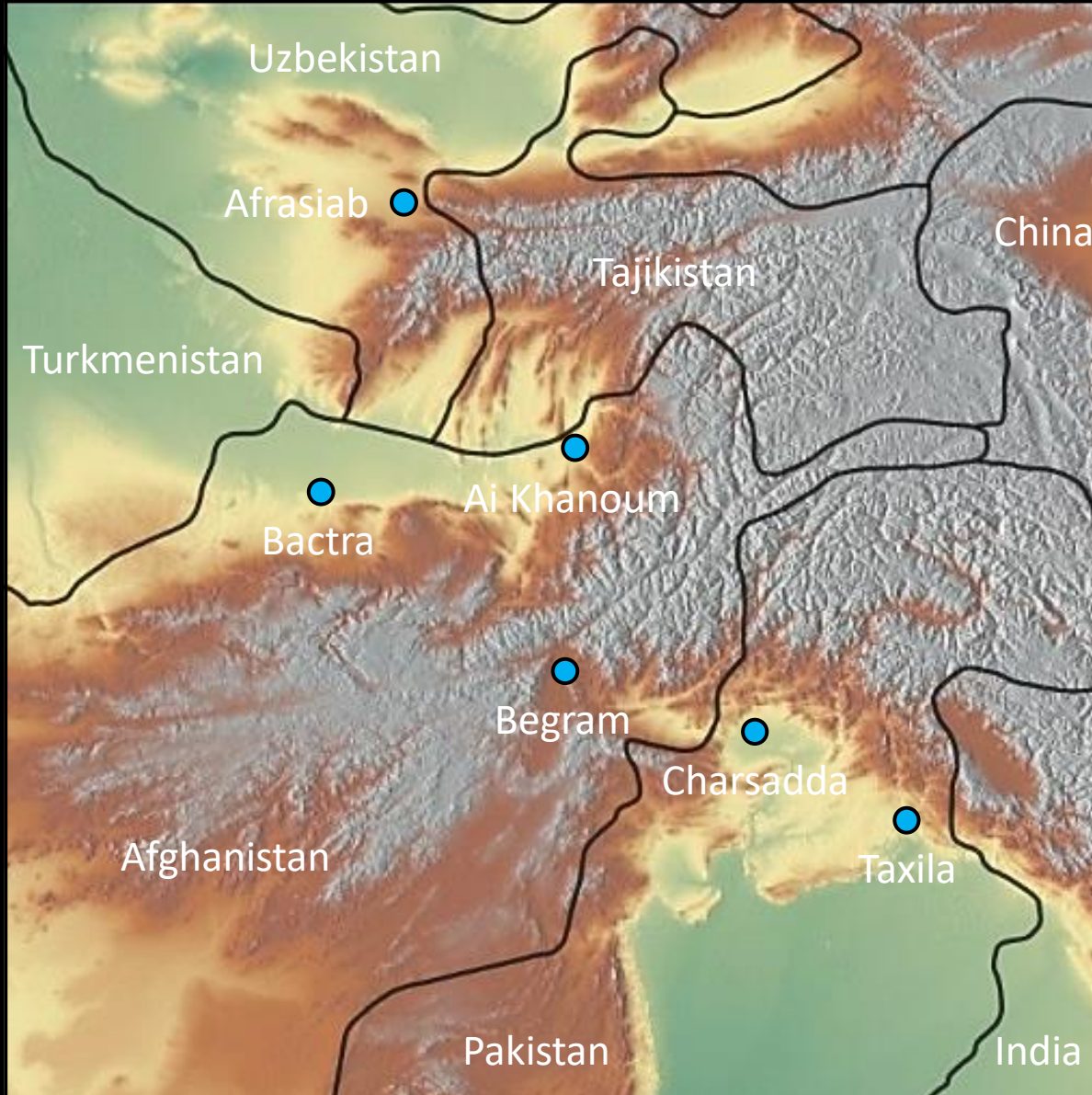

Fig. 3 Évolution chrono-typologique du monnayage pré-séleucide de Bactriane.

Les ateliers monétaires et les monogrammes



Noms de villes ?
Années de règne ?
Marques d'atelier ?
"Raison sociale" ?
Marque de monétaire ?

⌘ ⌘ **BAKTPA**

⌘ **ΑΛΕΞΑΝΔΡΙΑ**



SOUVERAINS	MONOGRAMMES											
Ménandre I	⌘	⌘	⌘									
Eucratide I	⌘	⌘	⌘	⌘	⌘							
Ménandre I	⌘	⌘	⌘	⌘		⌘	⌘	⌘				
Agathocléa								⌘	⌘			
Zoïle I	⌘	⌘	⌘			⌘	⌘					
Diomède			⌘	⌘	⌘				⌘	Σ	⌘	
Ag. et Straton I								⌘	⌘			
Straton I			⌘	⌘	⌘			⌘	⌘	⌘	Σ	



Agathocle
(180-176 av. J.-C.)



Antimachus I^{er}
(176-171 av. J.-C.)



Mένανδρε I^{er} (165-130) & Eucratide I^{er} (171-145)

ΒΑΣΙΛΕΩΣ /
ΕΥΚΡΑΤΙΔΟΥ



ΒΑΣΙΛΕΩΣ ΜΕΓΑΛΟΥ /
ΕΥΚΡΑΤΙΔΟΥ

171 – 162 BCE

162 BCE

162 – 145 BCE

165 – 162 BCE



ΒΑΣΙΛΕΩΣ ΣΩΤΗΡΟΣ / ΜΕΝΑΝΔΡΟΥ

145 BCE

145 – 130 BCE



Systeme de poids pour les bronzes de Ménandre I^{er}



$\Sigma = 16$ units



H = 8 units



$\Theta = 8$ units



$\Delta = 4$ units



$\Gamma = 3$ units



B = 2 units



A = 1 unit

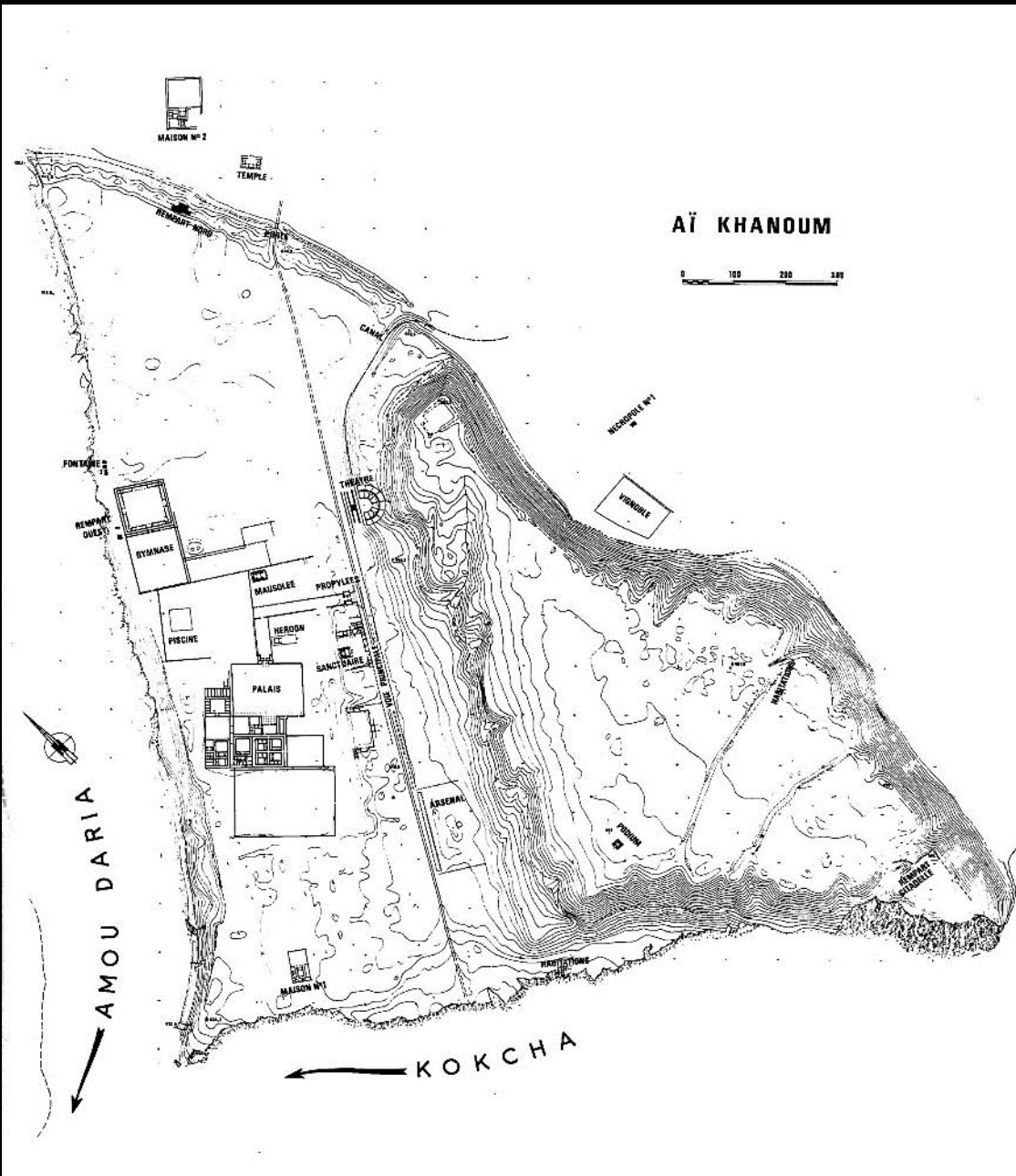

« Plaque indienne » d'Aï Khanoum



Monnaie d'argent aux types
Balarāma-Saṃkarṣaṇa et Vāsudeva-Kṛṣṇa



Γενεραφιλικου
 Κασαπανα ταξαηνά
 Διαρυτανει . . . α
 στρατα . . .

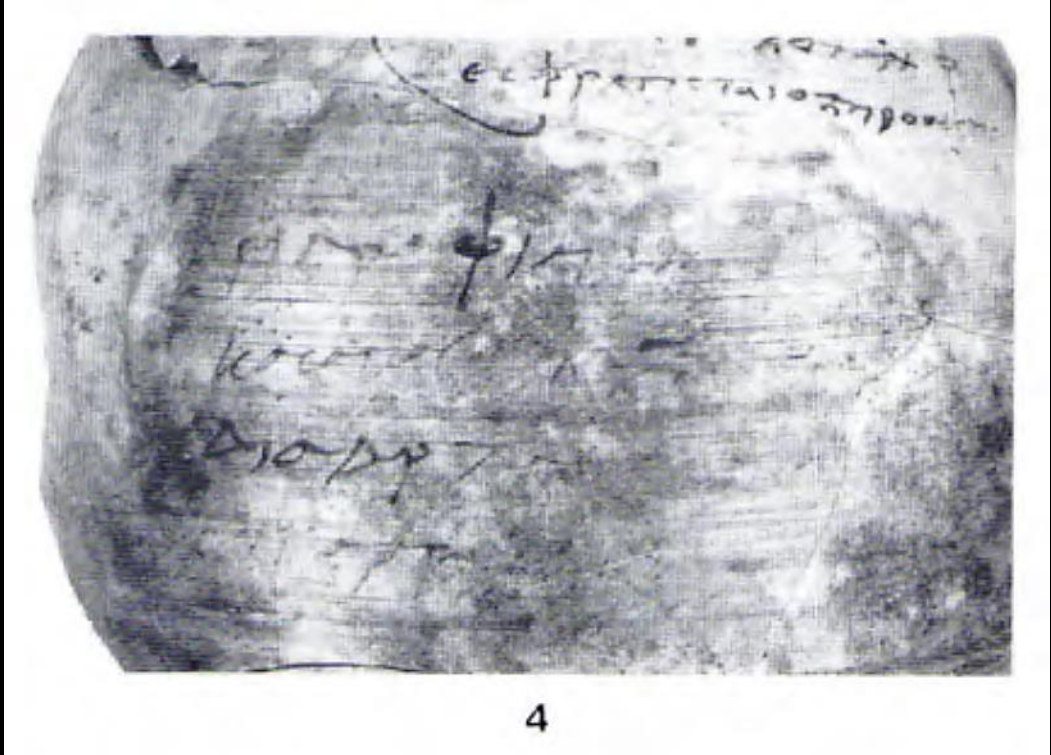

- 1) Παρά Φιλίσκου
- 2) κασαπανα ταξαηνά A
- 3) δια Άρυάνδου και M
- 4) Στρα . . . - - -

“De la part de Philiskos
 10 000 *kasarana taxaèna* ;
 par l’intermediaire d’Aryandès et
 Straton ; . . . ”



L'attribut du conquérant de l'Inde : le scalp d'éléphant





Paul Bernard (1929 – 2015)
(H.-P. Francfort 2016, p. 415, fig. 1)

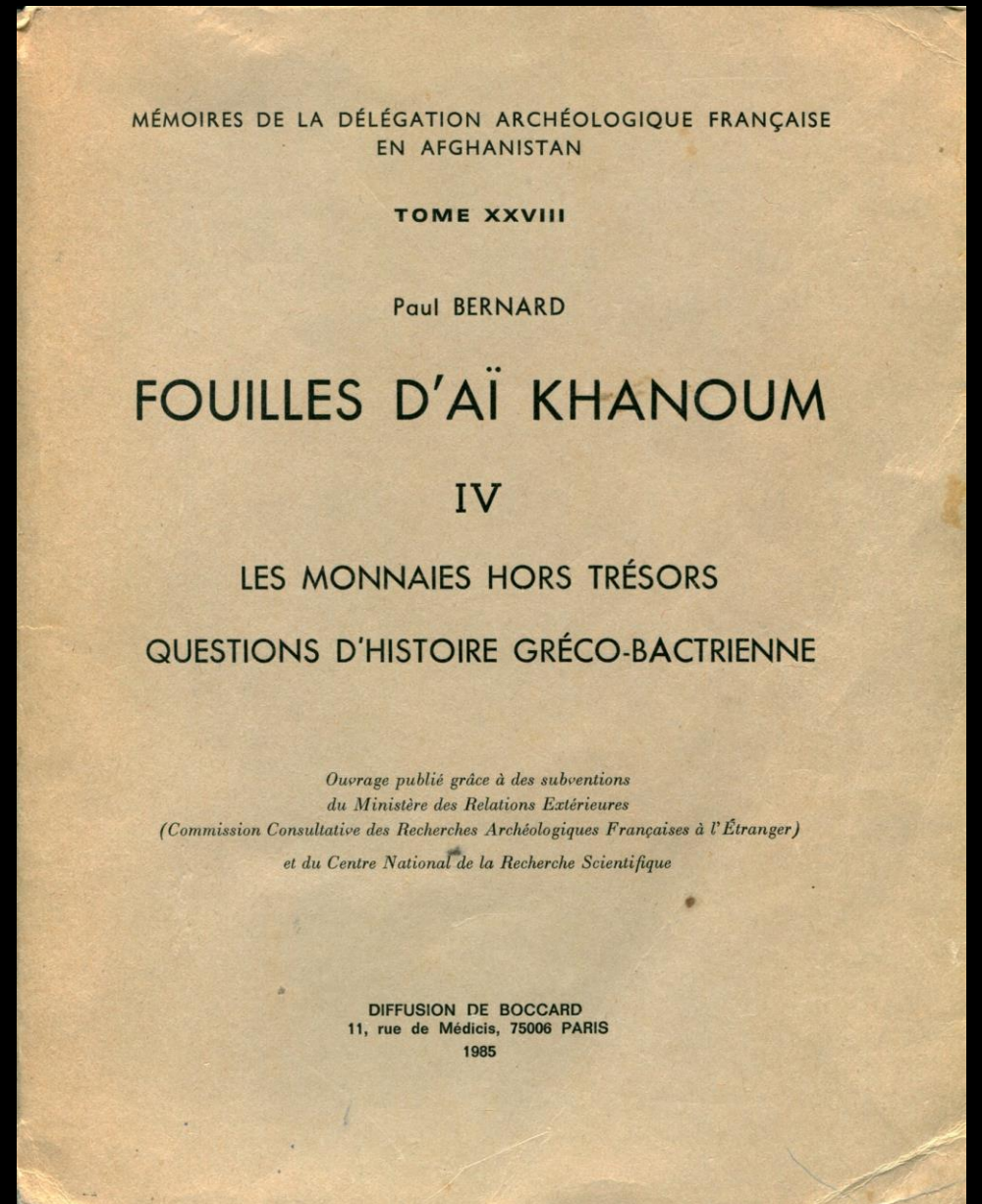



Lingots d'argent (Shaikhan Dheri, 5^e s. av. J.-C.) et d'or (Ai Khanoum, 2^e s. av. J.-C.)



Fig. 15: Usure du coin de droit en bronze en 2007.

Souverain	Or	Argent	Bronze
Diodote I ^{er}	237	162	
Diodote II	4	70	
Euthydème I ^{er}	12	531	123
Eucratide I ^{er}		751	
Ménandre I ^{er}	2	1714	261
Hippostrate		143	57



Le trésor de Mir Zakah II (province de Paktiya, Afghanistan) © Osmund Boppearachchi

Quelques lectures...

- O. Bopearachchi, *Monnaies gréco-bactriennes et indo-grecques. Catalogue raisonné*, BNF, Paris, 1991.
- O. Bordeaux, *Les Grecs en Inde. Politiques et pratiques monétaires (IIIe s. a. C. – Ier s. p. C.)*, Éditions Ausonius, Bordeaux, 2018.
- A. Bousdroukis, *D'Alexandre à Kanishka. Interactions culturelles dans les fondations des successeurs d'Alexandre du Proche-Orient à la vallée de l'Indus, aux époques hellénistique, romaine et arsacide*, de Boccard, Paris, 2023.
- F. L. Holt, *Into the Land of Bones. Alexander the Great in Afghanistan*, University of California Press, Berkeley-Los Angeles-Londres, 2005.
- F. L. Holt, *Lost World of the Golden King. In Search of Ancient Afghanistan*, University of California Press, Berkeley-Los Angeles-Londres, 2012.
- R. Mairs (dir.), *The Graeco-Bactrian and Indo-Greek World*, Routledge, Taylor & Francis Group, Londres/New York, 2020.
- S. van Reden (dir.), *Handbook of Ancient Afro-Eurasian Economies*, 3 volumes, de Gruyter, Berlin/Boston, 2019-2023 (chapitres de L. Morris).